



Test Report

Product Name : Tablet PC System

Model No.: TTAB910

FCC ID.: BJM-TTAB910

Applicant : Tatung Company

Address : 22, Chungshan N. Rd., 3rd Sec. Taipei, Taiwan, 104, R.O.C.

Date of Receipt : Nov. 01, 2002

Date of Test : Nov. 04, 2002

Report No. : 02BL010FI

The test results relate only to the samples tested.

The test report shall not be reproduced except in full without the written approval of Quietek Corporation.

This report must not be used to claim product endorsement by NVLAP any agency of the U.S. Government

Test Report Certification

Test Date : Nov. 04, 2002

Report No. : 02BL010FI



Accredited by NIST (NVLAP)
NVLAP Lab Code: 200533-0

Product Name : Tablet PC System

Applicant : Tatung Company

Address : 22, Chungshan N. Rd., 3rd Sec. Taipei, Taiwan, 104, R.O.C.

Manufacturer : Tatung Company

Model No. : TTAB910

FCC ID. : BJM-TTAB910

Rated Voltage : AC 120V/60Hz

Trade Name : TATUNG

Measurement Standard : FCC Part 15 Subpart C Paragraph 15.247

Measurement Procedure : ANSI C63.4: 1992

Test Result : Complied



Test Results relate only to the samples tested.

The test report shall not be reproduced except in full without the written approval of Quietek Corporation.

This report must not be used to claim product endorsement by NVLAP any agency of the U.S. Government

Documented By : Chiatmichen
(Chialin Chen)

Tested By : Tony Hsieh
(Tony Hsieh)

Approved By : Gene Chang
(Gene Chang)

TABLE OF CONTENTS

| Description | Page |
|---|-----------|
| 1. GENERAL INFORMATION..... | 5 |
| 1.1. EUT Description..... | 5 |
| 1.2. Operational Description | 6 |
| 1.3. Tested System Details..... | 7 |
| 1.4. Configuration of tested System | 8 |
| 1.5. EUT Exercise Software | 8 |
| 1.6. Test Facility | 9 |
| 2. Conducted Emission..... | 10 |
| 2.1. Test Equipment..... | 10 |
| 2.2. Test Setup | 10 |
| 2.3. Limits | 10 |
| 2.4. Test Procedure | 11 |
| 2.5. Test Result of Conducted Emission..... | 12 |
| 3. Peak Power Output | 13 |
| 3.1. Test Equipment..... | 13 |
| 3.2. Test Setup | 13 |
| 3.3. Limits | 13 |
| 3.4. Test Result of Peak Power Output..... | 14 |
| 4. RF Exposure Evaluation..... | 15 |
| 4.1. Limits | 15 |
| 4.2. Test Procedure | 15 |
| 4.3. Test Result of RF Exposure Evaluation..... | 16 |
| 5. Radiated Emission..... | 17 |
| 5.1. Test Equipment..... | 17 |
| 5.2. Test Setup | 17 |
| 5.3. Limits | 18 |
| 5.4. Test Procedure | 19 |
| 5.5. Test Result of Radiated Emission..... | 20 |
| 6. Band Edge | 44 |
| 6.1. Test Equipment..... | 44 |
| 6.2. Test Setup | 44 |
| 6.3. Limits | 45 |
| 6.4. Test Procedure | 45 |
| 6.5. Test Result of Band Edge | 46 |
| 7. Occupied Bandwidth..... | 50 |
| 7.1. Test Equipment..... | 50 |
| 7.2. Test Setup | 50 |
| 7.3. Limits | 50 |
| 7.4. Test Result of Occupied Bandwidth | 51 |
| 8. Power Density | 54 |

| | | |
|-----------|---|-----------|
| 8.1. | Test Equipment..... | 54 |
| 8.2. | Test Setup | 54 |
| 8.3. | Limits | 54 |
| 8.4. | Test Result of Power Density | 55 |
| 9. | EMI Reduction Method During Compliance Testing | 58 |

Attachment 1: EUT Test Photographs

Attachment 2: EUT Detailed Photographs

1. GENERAL INFORMATION

1.1. EUT Description

| | |
|-----------------------|-----------------------------------|
| Product Name | : Tablet PC System |
| Trade Name | : TATUNG |
| FCC ID. | : BJM-TTAB910 |
| Model No. | : TTAB910 |
| Frequency Range | : 2412MHz to 2462MHz |
| Channel Number | : 11 |
| Chip Rate | : 1Mbps, 2Mbps, 5.5Mbps, 11Mbps |
| Type of Modulation | : Direct Sequence Spread Spectrum |
| Antenna type | : Connector |
| Antenna Gain | : 3dBi |
| Operator Selection of | : By software |
| Operating Frequency | |

EUT Configuration:

| | |
|-------------------------|--|
| CPU | PIII 866MHz |
| PCB NO. | VT830MB, BN&HK-R00D, TT910BN |
| ADAPTER | HP-OD042D03 R1V:X01 |
| BATTERY PACK | 7.4V 3900/4300mAh |
| Mini PCI Modem | 1456VQL1T(INT) |
| *Mini-PCI Module | WISTRON, EM9-NB |
| SO-DIMM 256MB PC133 | MICRON,MT8LSDT3264HG-133 256MB SAMSUNG, M464S3323DN1-L7A 256MB (Final Test) INFINEON, HYS64V32220GDL-7.5 256MB |
| SO-DIMM 128MB PC133 | MICRON,MT4LSDT1664HG-133 128MB SAMSUNG, M464S1724DTS-L7A 128MB INFINEON, HYS64V16220GDL-7.5 128MB |
| 20GB HDD 2.5''*9.5mm | TOSHIBA, MK2018GAP(5V) (Final Test) IBM, IC25N020ATCS04(5V) FUJITSU, MHS2020AT(5V) |
| Power Adapter | MFR:H1PRO,M/N:HP-OD042D03 Cable IN: Non-Shielded, 1.8m Cable Out: Non-Shielded, 1.8m, one ferrite core bonded. |
| Mother Board | VT830MB, TATUNG |
| VGA Card | On Board |
| Sound Card | On Board |
| LAN Card | On Board |

Frequency of Each Channel:

| Channel | Frequency | Channel | Frequency | Channel | Frequency |
|------------|-----------|------------|-----------|-------------|-----------|
| Channel 1: | 2412 MHz | Channel 5: | 2432 MHz | Channel 9: | 2452 MHz |
| Channel 2: | 2417 MHz | Channel 6: | 2437 MHz | Channel 10: | 2457 MHz |
| Channel 3: | 2422 MHz | Channel 7: | 2442 MHz | Channel 11: | 2462 MHz |
| Channel 4: | 2427 MHz | Channel 8: | 2447 MHz | | |

Note:

1. This device is a 2.4GHz Tablet PC System included a 2.4GHz receiving function, a 2.4GHz transmitting function.
2. Regards to the frequency band operation; two rate that were included the lowest 、 middle and highest frequency of channel were selected to perform the test, then shown on this report.
3. These tests were conducted on a sample of the equipment for the purpose of demonstrating compliance with Part 15 Subpart C Paragraph 15.247 for spread spectrum devices.
4. This device is a composite device in accordance with Part 15 regulations. The function receiving was measured and made a test report that the report number is 02BL010F under Declaration of Conformity.

1.2. Operational Description

EUT is a Tablet PC System with wireless LAN adapter. This device provided 11 channels and four kind of transmitting speed 1,2,5.5 and 11Mbps. The device of RF carrier is DQPSK, DB PSK and CCK.

The device adapts direct sequence spread spectrum modulation. The Connector antenna was provides diversity function to improve the receiving function.

This Tablet PC System is an IEEE 802.11b Wireless LAN adapter. It allows your computer to connect to a wireless network and to share resources, such as files or printers without being bound to the network wires. Operation in 2.4GHz Direct Sequence Spread Spectrum (DSSS) radio transmission, the Tablet PC System transfers data at speeds up to 64/128-bit Wired Equivalent Protection (WEP) algorithm is used. In addition, its standard compliance ensures that it can communicate with any 802.11b network.

1.3. Tested System Details

The types for all equipment, plus descriptions of all cables used in the tested system (including inserted cards) are:

| | Product | Manufacturer | Model No. | Serial No. | FCC ID. | Power Cord |
|-----|-----------------------|--------------|-----------|------------------|------------|--------------------|
| (1) | Monitor | ADI | CM703 | 038054T10203875A | FCC DoC | Non-shielded, 1.8m |
| (2) | USB Keyboard | BTC | 5200U | N/A | E5XKB5122U | N/A |
| (3) | Microphone & Earphone | TOKTO | SX-MI | N/A | FCC DoC | N/A |
| (4) | USB Mouse | Logitech | M-BE58 | LZE11405150 | FCC DoC | N/A |
| (5) | Notebook | DELL | PP01L | N/A | FCC DoC | Non-shielded, 1.8m |
| (6) | AP | ASUS | AC300 | N/A | FCC DoC | Non-shielded, 1.8m |

| Signal Cable Type | Signal cable Description |
|--------------------------------|--|
| A. Monitor Cable | Shielded, 1.8m, two ferrite cores bonded |
| B. USB Keyboard Cable | Shielded, 1.5m |
| C. Microphone & Earphone Cable | Non-Shielded, 1.8m |
| D. USB Mouse Cable | Shielded, 1.5m |
| E. Telecom Cable | Non-Shielded, 5m |
| F. LAN Cable | Non-Shielded, 6m |
| G. LAN Cable | Non-Shielded, 1m |

1.4. Configuration of tested System

Tx & Rx

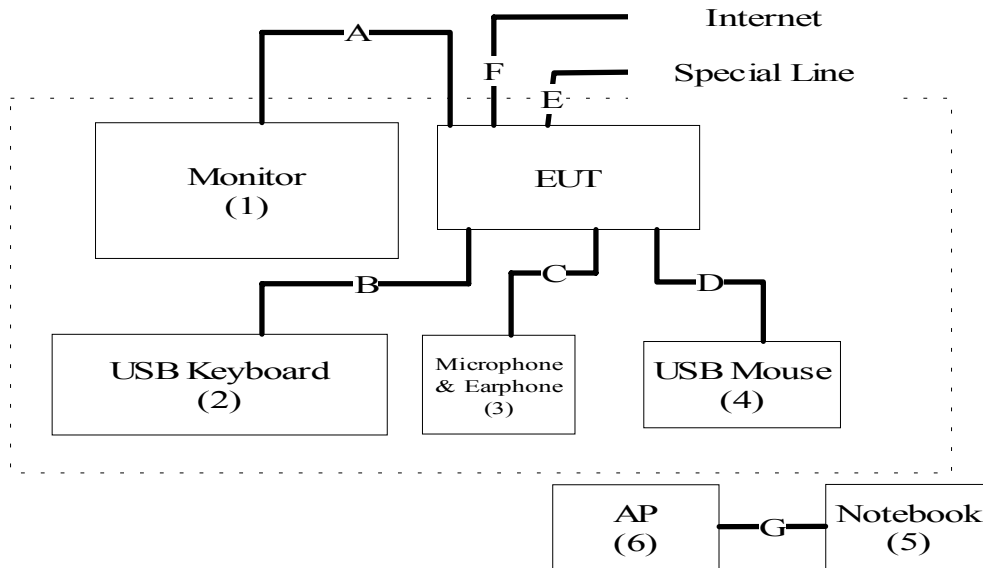

1.5. EUT Exercise Software

- (1) Setup the EUT and simulators as shown on 1.4
- (2) Turn on the power of all equipment.
- (3) Notebook PC reads data from disk.
- (4) Data will be transmitting and receiving through EUT.
- (5) The transmitted and receive status will be shown on the monitor.
- (6) Repeat the above procedure (3) to (5)

1.6. Test Facility

Ambient conditions in the laboratory:

| Items | Required (IEC 68-1) | Actual |
|----------------------------|---------------------|----------|
| Temperature (°C) | 15-35 | 20-35 |
| Humidity (%RH) | 25-75 | 50-65 |
| Barometric pressure (mbar) | 860-1060 | 950-1000 |

Site Description: June 22, 2001 File on
Federal Communications Commission
FCC Engineering Laboratory
7435 Oakland Mills Road
Columbia, MD 21046
Reference 31040/SIT1300F2



July 03, 2001 Accreditation on NVLAP
NVLAP Lab Code: 200533-0

Site Name: Quietek Corporation

Site Address: No. 5-22, Ruei-Shu Valley, Ruei-Ping Tsuen,
Lin-Kou Shiang, Taipei,
Taiwan, R.O.C.
TEL: 886-2-8601-3788 / FAX : 886-2-8601-3789
E-Mail : service@quietek.com

2. Conducted Emission

2.1. Test Equipment

The following test equipment are used during the conducted emission test:

| Item | Instrument | Manufacturer | Type No./Serial No | Last Cal. | Remark |
|------|--------------------|--------------|--------------------|-----------|-------------|
| 1 | Test Receiver | R & S | ESCS 30/825442/17 | May, 2002 | |
| 2 | L.I.S.N. | R & S | ESH3-Z5/825016/6 | May, 2002 | EUT |
| 3 | L.I.S.N. | Kyoritsu | KNW-407/8-1420-3 | May, 2002 | Peripherals |
| 4 | Pulse Limiter | R & S | ESH3-Z2 | N/A | |
| 5 | No.4 Shielded Room | | | N/A | |

Note: All equipment upon which need to calibrated are with calibration period of 1 year.

2.2. Test Setup

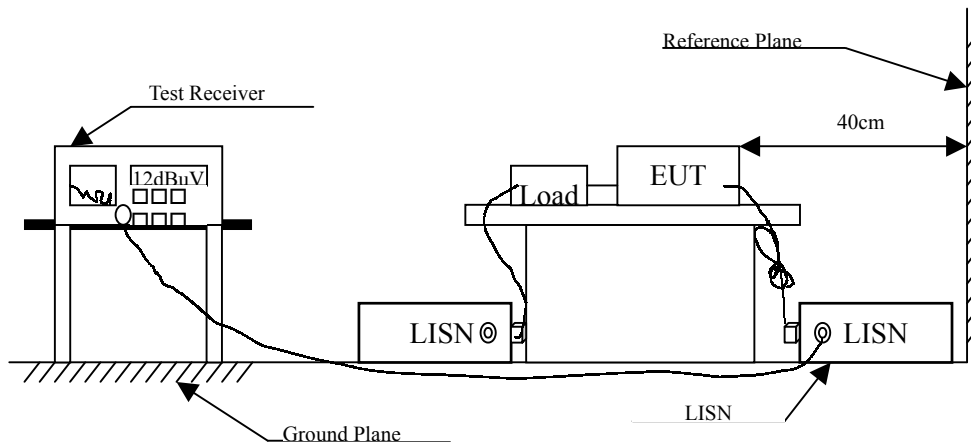

2.3. Limits

| FCC Part 15 Subpart C Paragraph 15.207 (dBuV) Limit | | |
|---|--------|------|
| Frequency MHz | Limits | |
| | uV | dBuV |
| 0.45 - 30 | 250 | 48.0 |

2.4. Test Procedure

The EUT and simulators are connected to the main power through a line impedance stabilization network (L.I.S.N.). This provides a 50 ohm /50uH coupling impedance for the measuring equipment. The peripheral devices are also connected to the main power through a LISN that provides a 50ohm/50uH coupling impedance with 50ohm termination. (Please refers to the block diagram of the test setup and photographs.)

Both sides of A.C. line are checked for maximum conducted interference. In order to find the maximum emission, the relative positions of equipment and all of the interface cables must be changed according to ANSI C63.4:1992 on conducted measurement.

Conducted emissions were investigated over the frequency range from 0.45MHz to 30MHz using a receiver bandwidth of 9kHz.

2.5. Test Result of Conducted Emission

Product : Tablet PC System
 Test Item : Conducted Emission Test
 Test Mode : Normal Operation

| Frequency MHz | Cable Loss dB | LISN Factor dB | Reading Level dBuV | Measurement Level dBuV | Limits dBuV |
|------------------|---------------------|----------------------|--------------------------|------------------------------|----------------|
|------------------|---------------------|----------------------|--------------------------|------------------------------|----------------|

Line1

Quasi-Peak

| | | | | | |
|---------|------|------|-------|-------|-------|
| 0.162 | 0.21 | 0.10 | 38.62 | 38.93 | 48.00 |
| 0.235 | 0.21 | 0.10 | 33.34 | 33.65 | 48.00 |
| * 0.548 | 0.21 | 0.10 | 31.12 | 31.43 | 48.00 |
| 1.805 | 0.09 | 0.13 | 27.55 | 27.76 | 48.00 |
| 3.063 | 0.23 | 0.15 | 24.43 | 24.81 | 48.00 |
| 7.543 | 0.33 | 0.19 | 27.36 | 27.88 | 48.00 |

Line2

Quasi-Peak

| | | | | | |
|---------|------|------|-------|-------|-------|
| 0.158 | 0.21 | 0.10 | 39.42 | 39.73 | 48.00 |
| 0.201 | 0.21 | 0.10 | 32.51 | 32.82 | 48.00 |
| 0.361 | 0.21 | 0.10 | 20.28 | 20.59 | 48.00 |
| * 0.552 | 0.21 | 0.10 | 30.36 | 30.67 | 48.00 |
| 2.288 | 0.09 | 0.14 | 27.04 | 27.26 | 48.00 |
| 7.659 | 0.33 | 0.19 | 27.62 | 28.14 | 48.00 |

Remarks :

1. All Readings below 1GHz are Quasi-Peak value.
2. “ * ” means that this data is the worst emission level.
3. Emission Level = Reading Level + LISN Factor + Cable Loss.

3. Peak Power Output

3.1. Test Equipment

The following test equipments are used during the radiated emission tests:

| | Equipment | Manufacturer | Model No./Serial No. | Last Cal. |
|---|-------------------|--------------|----------------------|-----------|
| X | Spectrum Analyzer | Advantest | R3272 / 72421194 | May, 2002 |

Note: 1. All equipment upon which need to calibrated are with calibration period of 1 year.
 2. Mark "X" test instruments are used to measure the final test results.

3.2. Test Setup

Conduction Power Measurement

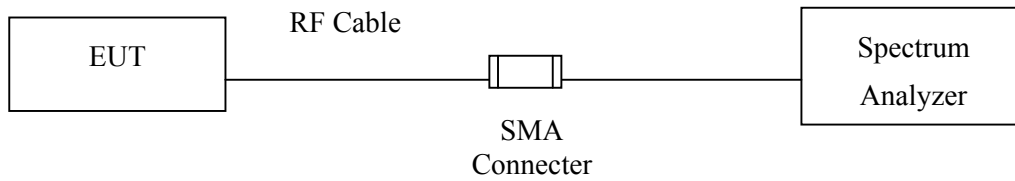

3.3. Limits

The maximum peak power shall be less 1 Watt.

3.4. Test Result of Peak Power Output

Product : Tablet PC System
 Test Item : Peak Power Output Data
 Test Site : No.2 OATS
 Test Mode : Normal Operation

Data Speed: 1Mbps

| Channel No. | Frequency(MHz) | Measurement | Required Limit | Result |
|-------------|----------------|-------------|----------------|--------|
| 1 | 2412.0 | 8.94 dBm | 1 Watt= 30 dBm | Pass |
| 6 | 2437.0 | 8.17 dBm | 1 Watt= 30 dBm | Pass |
| 11 | 2462.0 | 9.65 dBm | 1 Watt= 30 dBm | Pass |

Data Speed: 11Mbps

| Channel No. | Frequency (MHz) | Measurement | Required Limit | Result |
|-------------|-----------------|-------------|----------------|--------|
| 1 | 2412.0 | 8.67dBm | 1 Watt= 30 dBm | Pass |
| 6 | 2437.0 | 10.45dBm | 1 Watt= 30 dBm | Pass |
| 11 | 2462.0 | 9.75dBm | 1 Watt= 30 dBm | Pass |

4. RF Exposure Evaluation

4.1. Limits

According to FCC 1.1310: The criteria listed in the following table shall be used to evaluate the environment impact of human exposure to radio frequency (RF) radiation as specified in 1.1307(b)

LIMITS FOR MAXIMUM PERMISSIBLE EXPOSURE (MPE)

| Frequency Range (MHz) | Electric Field Strength (V/m) | Magnetic Field Strength (A/m) | Power Density (mW/cm ²) | Average Time (Minutes) |
|---|-------------------------------|-------------------------------|-------------------------------------|------------------------|
| (A) Limits for Occupational/ Control Exposures | | | | |
| 300-1500 | -- | -- | F/300 | 6 |
| 1500-100,000 | -- | -- | 5 | 6 |
| (B) Limits for General Population/ Uncontrolled Exposures | | | | |
| 300-1500 | -- | -- | F/1500 | 6 |
| 1500-100,000 | -- | -- | 1 | 30 |

F= Frequency in MHz

Friis Formula

Friis transmission formula: $P_d = (P_{out} * G) / (4 * \pi * r^2)$

Where

P_d = power density in mW/cm²

P_{out} = output power to antenna in mW

G = gain of antenna in linear scale

π = 3.1416

R = distance between observation point and center of the radiator in cm

P_d is the limit of MPE, 1 mW/cm². If we know the maximum gain of the antenna and the total power input to the antenna, through the calculation, we will know the distance r where the MPE limit is reached.

4.2. Test Procedure

Software provided by client enabled the EUT to transmit and receive data at lowest, middle and highest channel individually.

The temperature and related humidity: 18°C and 78% RH.

4.3. Test Result of RF Exposure Evaluation

Product : Tablet PC System
 Test Item : RF Exposure Evaluation Data
 Test Site : No.2 OATS
 Test Mode : Normal Operation

Antenna Gain

Antenna Gain: The maximum Gain measured in fully anechoic chamber is 3dBi or 2 in linear scale.

Output Power Into Antenna & RF Exposure Evaluation Distance:

| Channel | Channel Frequency (MHz) | Output Power to Antenna (mW) | Minimum Allowable Distance ® From Skin(cm) |
|-------------|-------------------------|------------------------------|--|
| 1 (1Mbps) | 2412.9 | 7.8343 | 1.1153 |
| 1 (11Mbps) | 2412.9 | 7.3621 | 1.0812 |
| 6 (1Mbps) | 2437.9 | 6.5615 | 1.0207 |
| 6 (11Mbps) | 2437.9 | 11.0917 | 1.3271 |
| 11 (1Mbps) | 2462.9 | 9.2257 | 1.2103 |
| 11 (11Mbps) | 2462.9 | 9.4406 | 1.2243 |

The distance r (4th column) calculated from the Fries transmission formula is far shorter than 20 cm separation requirement. So, RF exposure limit warning or SAR test are not required.

5. Radiated Emission

5.1. Test Equipment

The following test equipment are used during the radiated emission test:

| Test Site | Equipment | Manufacturer | Model No./Serial No. | Last Cal. |
|-----------|---------------------|--------------|----------------------|------------|
| Site # 1 | Test Receiver | R & S | ESCS 30 / 825442/14 | May, 2002 |
| | Spectrum Analyzer | Advantest | R3261C / 71720140 | May, 2002 |
| | Pre-Amplifier | HP | 8447D/3307A01812 | May, 2002 |
| | Bilog Antenna | Chase | CBL6112B / 12452 | Sep., 2002 |
| | Horn Antenna | EM | EM6917 / 103325 | May, 2002 |
| Site # 2 | X Test Receiver | R & S | ESCS 30 / 825442/17 | May, 2002 |
| | X Spectrum Analyzer | Advantest | R3261C / 71720609 | May, 2002 |
| | X Pre-Amplifier | HP | 8447D/3307A01814 | May, 2002 |
| | X Bilog Antenna | Chase | CBL6112B / 2455 | Sep., 2002 |
| | X Horn Antenna | EM | EM6917 / 103325 | May, 2002 |

- Note:
1. All equipments that need to calibrate are with calibration period of 1 year.
 2. Mark "X" test instruments are used to measure the final test results.

5.2. Test Setup

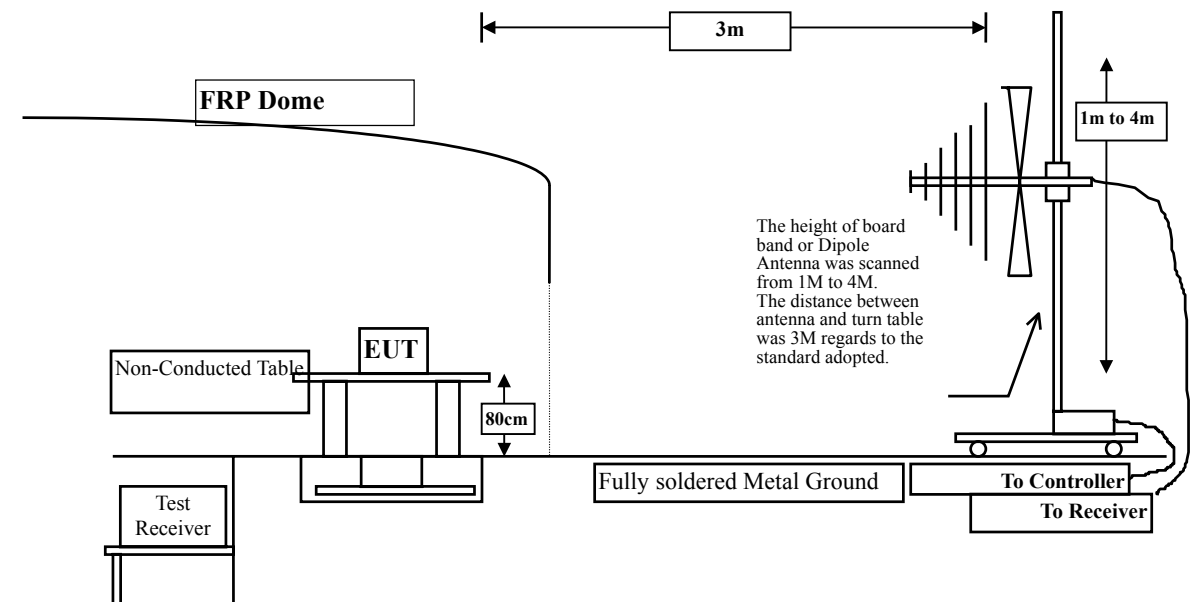

5.3. Limits

➤ **General Radiated Emission Limits**

Emissions radiated outside of the specified frequency bands, except for harmonics, shall be attenuated by at least 20dB below the level of the fundamental or to the general radiated emission limits in paragraph 15.209, whichever is the lesser attenuation.

| FCC Part 15 Subpart C Paragraph 15.209(a) Limits | | |
|---|----------|-----------|
| Frequency MHz | uV/m @3m | dBuV/m@3m |
| 30-88 | 100 | 40 |
| 88-216 | 150 | 43.5 |
| 216-960 | 200 | 46 |
| Above 960 | 500 | 54 |

- Remarks :
1. RF Voltage (dBuV) = 20 log RF Voltage (uV)
 2. In the Above Table, the tighter limit applies at the band edges.
 3. Distance refers to the distance in meters between the measuring instrument antenna and the closed point of any part of the device or system.

5.4. Test Procedure

The EUT and its simulators are placed on a turn table which is 0.8 meter above ground. The turn table can rotate 360 degrees to determine the position of the maximum emission level. The EUT was positioned such that the distance from antenna to the EUT was 3 meters.

The antenna can move up and down between 1 meter and 4 meters to find out the maximum emission level.

Both horizontal and vertical polarization of the antenna are set on measurement. In order to find the maximum emission, all of the interface cables must be manipulated according to ANSI C63.4:1992 on radiated measurement.

The additional latch filter below 1GHz was used to measure the level of harmonics radiated emission during field strength of harmonics measurement.

The bandwidth below 1GHz setting on the field strength meter (R&S Test Receiver ESCS 30)is 120 kHz, above 1GHz are 1 MHz.

The frequency range from 30MHz to 10th harmonics is checked.

5.5. Test Result of Radiated Emission

Product : Tablet PC System
 Test Item : Harmonic Radiated Emission Data
 Test Site : No.2 OATS
 Test Mode : Channel 1 (1Mbps)

| Frequency | Cable | Probe | PreAMP | Reading | Emission | Margin | Peak | Average |
|-----------|-------|--------|--------|---------|----------|--------|--------|---------|
| MHz | Loss | Factor | dB | Level | Level | dB | Limit | Limit |
| | dB | dB/m | | dBuV | dBuV/m | | dBuV/m | dBuV/m |

Horizontal

Peak Detector:

| | | | | | | | | |
|----------|-------|-------|-------|-------|---------|-------|-------|-------|
| 4825.619 | 6.17 | 33.64 | 19.50 | 29.30 | 49.61 | 24.39 | 74.00 | 54.00 |
| 7237.658 | 7.33 | 36.77 | 18.33 | 23.15 | < 48.92 | 25.08 | 74.00 | 54.00 |
| 9651.207 | 8.73 | 38.24 | 15.86 | 19.34 | < 50.44 | 23.56 | 74.00 | 54.00 |
| 12064.00 | 9.98 | 39.03 | 16.08 | 17.96 | < 50.90 | 23.10 | 74.00 | 54.00 |
| 14476.68 | 10.65 | 40.46 | 17.43 | 17.40 | < 51.09 | 22.91 | 74.00 | 54.00 |
| 16887.65 | 12.27 | 41.87 | 16.14 | 13.40 | < 51.40 | 22.60 | 74.00 | 54.00 |
| 19302.38 | 12.72 | 37.96 | 18.02 | 19.14 | < 51.80 | 22.20 | 74.00 | 54.00 |
| 21715.21 | 13.02 | 37.40 | 18.77 | 20.41 | < 52.06 | 21.94 | 74.00 | 54.00 |
| 24126.97 | 13.65 | 39.24 | 19.06 | 18.38 | < 52.20 | 21.80 | 74.00 | 54.00 |

Vertical

Peak Detector:

| | | | | | | | | |
|----------|-------|-------|-------|-------|---------|-------|-------|-------|
| 4825.614 | 6.17 | 33.64 | 19.50 | 27.50 | 47.81 | 26.19 | 74.00 | 54.00 |
| 7238.419 | 7.33 | 36.77 | 18.33 | 23.25 | < 49.02 | 24.98 | 74.00 | 54.00 |
| 9651.158 | 8.73 | 38.24 | 15.86 | 20.20 | < 51.30 | 22.70 | 74.00 | 54.00 |
| 12064.01 | 9.98 | 39.03 | 16.08 | 17.16 | < 50.10 | 23.90 | 74.00 | 54.00 |
| 14476.78 | 10.65 | 40.46 | 17.43 | 17.19 | < 50.88 | 23.12 | 74.00 | 54.00 |
| 16889.48 | 12.27 | 41.87 | 16.14 | 12.60 | < 50.60 | 23.40 | 74.00 | 54.00 |
| 19302.38 | 12.72 | 37.96 | 18.02 | 18.74 | < 51.40 | 22.60 | 74.00 | 54.00 |
| 21715.05 | 13.02 | 37.40 | 18.77 | 20.06 | < 51.71 | 22.29 | 74.00 | 54.00 |
| 24126.99 | 13.65 | 39.24 | 19.06 | 18.88 | < 52.70 | 21.30 | 74.00 | 54.00 |

Note:

1. All Readings below 1GHz are Quasi-Peak, above are average value.
2. Receiver setting (Peak Detector) : RBW:1MHz; VBW:1MHz; Span:100MHz ◦
3. Receiver setting (AVG Detector) : RBW:1MHz; VBW:30Hz; Span:20MHz ◦
4. Emission Level = Reading Level + Probe Factor + Cable Loss- PreAMP.
5. The average measurement was not performed when the peak measured data under the limit of average detection. If the readings given are average, peak measurement should also be supplied.

Product : Tablet PC System
 Test Item : Harmonic Radiated Emission Data
 Test Site : No.2 OATS
 Test Mode : Channel 6 (1Mbps)

| Frequency | Cable | Probe | PreAMP | Reading | Emission | Margin | Peak | Average |
|-----------|-------|--------|--------|---------|----------|--------|--------|---------|
| MHz | Loss | Factor | | Level | Level | | Limit | Limit |
| | dB | dB/m | dB | dBuV | dBuV/m | dB | dBuV/m | dBuV/m |

Horizontal

Peak Detector:

| | | | | | | | | |
|----------|-------|-------|-------|-------|---------|-------|-------|-------|
| 4875.431 | 6.20 | 33.77 | 19.50 | 27.92 | 48.40 | 25.60 | 74.00 | 54.00 |
| 7313.152 | 7.37 | 36.98 | 18.27 | 23.09 | < 49.17 | 24.83 | 74.00 | 54.00 |
| 9750.799 | 8.87 | 38.35 | 15.81 | 19.18 | < 50.60 | 23.40 | 74.00 | 54.00 |
| 12188.41 | 10.13 | 39.07 | 16.29 | 17.00 | < 49.91 | 24.09 | 74.00 | 54.00 |
| 14626.21 | 10.67 | 40.02 | 17.87 | 17.57 | < 50.38 | 23.62 | 74.00 | 54.00 |
| 17063.87 | 12.30 | 42.89 | 16.27 | 12.25 | < 51.17 | 22.83 | 74.00 | 54.00 |
| 19501.62 | 12.76 | 37.97 | 18.18 | 19.07 | < 51.61 | 22.39 | 74.00 | 54.00 |
| 21939.26 | 13.04 | 37.34 | 18.79 | 20.14 | < 51.72 | 22.28 | 74.00 | 54.00 |
| 24377.02 | 13.72 | 39.37 | 19.09 | 18.08 | < 52.07 | 21.93 | 74.00 | 54.00 |

Vertical

Peak Detector:

| | | | | | | | | |
|----------|-------|-------|-------|-------|---------|-------|-------|-------|
| 4875.341 | 6.20 | 33.77 | 19.50 | 28.06 | 48.54 | 25.46 | 74.00 | 54.00 |
| 7313.116 | 7.37 | 36.98 | 18.27 | 23.34 | < 49.42 | 24.58 | 74.00 | 54.00 |
| 9750.674 | 8.87 | 38.35 | 15.81 | 18.41 | < 49.83 | 24.17 | 74.00 | 54.00 |
| 12188.41 | 10.13 | 39.07 | 16.29 | 17.81 | < 50.72 | 23.28 | 74.00 | 54.00 |
| 14626.10 | 10.67 | 40.02 | 17.87 | 17.22 | < 50.03 | 23.97 | 74.00 | 54.00 |
| 17063.84 | 12.30 | 42.89 | 16.27 | 12.37 | < 51.29 | 22.71 | 74.00 | 54.00 |
| 19501.57 | 12.76 | 37.97 | 18.18 | 19.23 | < 51.77 | 22.23 | 74.00 | 54.00 |
| 21939.22 | 13.04 | 37.34 | 18.79 | 19.58 | < 51.16 | 22.84 | 74.00 | 54.00 |
| 24376.89 | 13.72 | 39.37 | 19.09 | 18.72 | < 52.71 | 21.29 | 74.00 | 54.00 |

Note:

1. All Readings below 1GHz are Quasi-Peak, above are average value.
2. Receiver setting (Peak Detector) : RBW:1MHz; VBW:1MHz; Span:100MHz ◦
3. Receiver setting (AVG Detector) : RBW:1MHz; VBW:30Hz; Span:20MHz ◦
4. Emission Level = Reading Level + Probe Factor + Cable Loss- PreAMP.
5. The average measurement was not performed when the peak measured data under the limit of average detection. If the readings given are average, peak measurement should also be supplied.

Product : Tablet PC System
 Test Item : Harmonic Radiated Emission Data
 Test Site : No.2 OATS
 Test Mode : Channel 11 (1Mbps)

| Frequency | Cable | Probe | PreAMP | Reading | Emission | Margin | Peak | Average |
|-----------|-------|--------|--------|---------|----------|--------|--------|---------|
| MHz | Loss | Factor | dB | Level | Level | dB | Limit | Limit |
| | dB | dB/m | | dBuV | dBuV/m | | dBuV/m | dBuV/m |

Horizontal

Peak Detector:

| | | | | | | | | |
|----------|-------|-------|-------|-------|---------|-------|-------|-------|
| 4924.241 | 6.26 | 33.90 | 19.49 | 28.45 | 49.12 | 24.88 | 74.00 | 54.00 |
| 7386.315 | 7.42 | 37.14 | 18.22 | 24.90 | < 51.24 | 22.76 | 74.00 | 54.00 |
| 9848.411 | 8.97 | 38.47 | 15.70 | 18.38 | < 50.12 | 23.88 | 74.00 | 54.00 |
| 12310.41 | 10.27 | 39.12 | 16.18 | 17.60 | < 50.81 | 23.19 | 74.00 | 54.00 |
| 14772.54 | 10.68 | 39.53 | 17.01 | 17.71 | < 50.91 | 23.09 | 74.00 | 54.00 |
| 17234.71 | 12.33 | 43.99 | 16.40 | 11.28 | < 51.20 | 22.80 | 74.00 | 54.00 |
| 19696.74 | 12.79 | 37.97 | 18.32 | 19.23 | < 51.67 | 22.33 | 74.00 | 54.00 |
| 22158.89 | 13.10 | 37.40 | 18.82 | 19.46 | < 51.13 | 22.87 | 74.00 | 54.00 |
| 24621.01 | 13.78 | 39.50 | 19.12 | 17.65 | < 51.81 | 22.19 | 74.00 | 54.00 |

Vertical

Peak Detector:

| | | | | | | | | |
|----------|-------|-------|-------|-------|---------|-------|-------|-------|
| 4924.246 | 6.26 | 33.90 | 19.49 | 28.20 | 48.87 | 25.13 | 74.00 | 54.00 |
| 7386.315 | 7.42 | 37.14 | 18.22 | 24.42 | < 50.76 | 23.24 | 74.00 | 54.00 |
| 9848.381 | 8.97 | 38.47 | 15.70 | 17.85 | < 49.59 | 24.41 | 74.00 | 54.00 |
| 12310.51 | 10.27 | 39.12 | 16.18 | 17.87 | < 51.08 | 22.92 | 74.00 | 54.00 |
| 14772.56 | 10.68 | 39.53 | 17.01 | 17.74 | < 50.94 | 23.06 | 74.00 | 54.00 |
| 17234.69 | 12.33 | 43.99 | 16.40 | 11.42 | < 51.34 | 22.66 | 74.00 | 54.00 |
| 19696.80 | 12.79 | 37.97 | 18.32 | 18.96 | < 51.40 | 22.60 | 74.00 | 54.00 |
| 22158.84 | 13.10 | 37.40 | 18.82 | 20.57 | < 52.24 | 21.76 | 74.00 | 54.00 |
| 24621.00 | 13.78 | 39.50 | 19.12 | 18.00 | < 52.16 | 21.84 | 74.00 | 54.00 |

Note:

1. All Readings below 1GHz are Quasi-Peak, above are average value.
2. Receiver setting (Peak Detector) : RBW:1MHz; VBW:1MHz; Span:100MHz ◦
3. Receiver setting (AVG Detector) : RBW:1MHz; VBW:30Hz; Span:20MHz ◦
4. Emission Level = Reading Level + Probe Factor + Cable Loss- PreAMP.
5. The average measurement was not performed when the peak measured data under the limit of average detection. If the readings given are average, peak measurement should also be supplied.

Product : Tablet PC System
 Test Item : Harmonic Radiated Emission Data
 Test Site : No.2 OATS
 Test Mode : Channel 1 (11Mbps)

| Frequency | Cable | Probe | PreAMP | Reading | Emission | Margin | Peak | Average |
|-----------|-------|--------|--------|---------|----------|--------|--------|---------|
| MHz | Loss | Factor | dB | Level | Level | dB | Limit | Limit |
| | dB | dB/m | | dBuV | dBuV/m | | dBuV/m | dBuV/m |

Horizontal

Peak Detector:

| | | | | | | | | |
|----------|-------|-------|-------|-------|---------|-------|-------|-------|
| 4825.598 | 6.17 | 33.64 | 19.50 | 28.71 | 49.02 | 24.98 | 74.00 | 54.00 |
| 7237.554 | 7.33 | 36.77 | 18.33 | 25.32 | < 51.09 | 22.91 | 74.00 | 54.00 |
| 9651.348 | 8.73 | 38.24 | 15.86 | 18.70 | < 49.80 | 24.20 | 74.00 | 54.00 |
| 12064.01 | 9.98 | 39.03 | 16.08 | 17.45 | < 50.39 | 23.61 | 74.00 | 54.00 |
| 14476.69 | 10.65 | 40.46 | 17.43 | 16.92 | < 50.61 | 23.39 | 74.00 | 54.00 |
| 16887.43 | 12.27 | 41.87 | 16.14 | 13.15 | < 51.15 | 22.85 | 74.00 | 54.00 |
| 19302.28 | 12.72 | 37.96 | 18.02 | 19.13 | < 51.79 | 22.21 | 74.00 | 54.00 |
| 21715.18 | 13.02 | 37.40 | 18.77 | 19.59 | < 51.24 | 22.76 | 74.00 | 54.00 |
| 24126.75 | 13.65 | 39.24 | 19.06 | 18.66 | < 52.48 | 21.52 | 74.00 | 54.00 |

Vertical

Peak Detector:

| | | | | | | | | |
|----------|-------|-------|-------|-------|---------|-------|-------|-------|
| 4825.602 | 6.17 | 33.64 | 19.50 | 28.71 | 49.02 | 24.98 | 74.00 | 54.00 |
| 7238.355 | 7.33 | 36.77 | 18.33 | 24.15 | < 49.92 | 24.08 | 74.00 | 54.00 |
| 9651.127 | 8.73 | 38.24 | 15.86 | 19.56 | < 50.66 | 23.34 | 74.00 | 54.00 |
| 12064.28 | 9.98 | 39.03 | 16.08 | 17.89 | < 50.83 | 23.17 | 74.00 | 54.00 |
| 14476.64 | 10.65 | 40.46 | 17.43 | 17.41 | < 51.10 | 22.90 | 74.00 | 54.00 |
| 16889.66 | 12.27 | 41.87 | 16.14 | 13.70 | < 51.70 | 22.30 | 74.00 | 54.00 |
| 19302.34 | 12.72 | 37.96 | 18.02 | 18.23 | < 50.89 | 23.11 | 74.00 | 54.00 |
| 21715.12 | 13.02 | 37.40 | 18.77 | 20.53 | < 52.18 | 21.82 | 74.00 | 54.00 |
| 24126.88 | 13.65 | 39.24 | 19.06 | 17.81 | < 51.63 | 22.37 | 74.00 | 54.00 |

Note:

1. All Readings below 1GHz are Quasi-Peak, above are average value.
2. Receiver setting (Peak Detector) : RBW:1MHz; VBW:1MHz; Span:100MHz °
3. Receiver setting (AVG Detector) : RBW:1MHz; VBW:30Hz; Span:20MHz °
4. Emission Level = Reading Level + Probe Factor + Cable Loss- PreAMP.
5. The average measurement was not performed when the peak measured data under the limit of average detection. If the readings given are average, peak measurement should also be supplied.

Product : Tablet PC System
 Test Item : Harmonic Radiated Emission Data
 Test Site : No.2 OATS
 Test Mode : Channel 6 (11Mbps)

| Frequency | Cable | Probe | PreAMP | Reading | Emission | Margin | Peak | Average |
|-----------|-------|--------|--------|---------|----------|--------|--------|---------|
| MHz | Loss | Factor | | Level | Level | | Limit | Limit |
| | dB | dB/m | dB | dBuV | dBuV/m | dB | dBuV/m | dBuV/m |

Horizontal

Peak Detector:

| | | | | | | | | |
|----------|-------|-------|-------|-------|---------|-------|-------|-------|
| 4875.446 | 6.20 | 33.77 | 19.50 | 27.71 | 48.19 | 25.81 | 74.00 | 54.00 |
| 7313.201 | 7.37 | 36.98 | 18.27 | 23.63 | < 49.71 | 24.29 | 74.00 | 54.00 |
| 9750.814 | 8.87 | 38.35 | 15.81 | 18.20 | < 49.62 | 24.38 | 74.00 | 54.00 |
| 12188.42 | 10.13 | 39.07 | 16.29 | 17.83 | < 50.74 | 23.26 | 74.00 | 54.00 |
| 14626.16 | 10.67 | 40.02 | 17.87 | 18.23 | < 51.04 | 22.96 | 74.00 | 54.00 |
| 17063.87 | 12.30 | 42.89 | 16.27 | 12.56 | < 51.48 | 22.52 | 74.00 | 54.00 |
| 19500.99 | 12.76 | 37.97 | 18.18 | 18.50 | < 51.04 | 22.96 | 74.00 | 54.00 |
| 21939.27 | 13.04 | 37.34 | 18.79 | 20.29 | < 51.87 | 22.13 | 74.00 | 54.00 |
| 24377.00 | 13.72 | 39.37 | 19.09 | 17.27 | < 51.26 | 22.74 | 74.00 | 54.00 |

Vertical

Peak Detector:

| | | | | | | | | |
|----------|-------|-------|-------|-------|---------|-------|-------|-------|
| 4875.299 | 6.20 | 33.77 | 19.50 | 28.79 | 49.27 | 24.73 | 74.00 | 54.00 |
| 7313.125 | 7.37 | 36.98 | 18.27 | 24.34 | < 50.42 | 23.58 | 74.00 | 54.00 |
| 9750.598 | 8.87 | 38.35 | 15.81 | 18.18 | < 49.60 | 24.40 | 74.00 | 54.00 |
| 12188.43 | 10.13 | 39.07 | 16.29 | 17.80 | < 50.71 | 23.29 | 74.00 | 54.00 |
| 14626.14 | 10.67 | 40.02 | 17.87 | 18.63 | < 51.44 | 22.56 | 74.00 | 54.00 |
| 17063.79 | 12.30 | 42.89 | 16.27 | 13.05 | < 51.97 | 22.03 | 74.00 | 54.00 |
| 19501.58 | 12.76 | 37.97 | 18.18 | 19.53 | < 52.07 | 21.93 | 74.00 | 54.00 |
| 21939.27 | 13.04 | 37.34 | 18.79 | 19.94 | < 51.52 | 22.48 | 74.00 | 54.00 |
| 24376.88 | 13.72 | 39.37 | 19.09 | 18.16 | < 52.15 | 21.85 | 74.00 | 54.00 |

Note:

1. All Readings below 1GHz are Quasi-Peak, above are average value.
2. Receiver setting (Peak Detector) : RBW:1MHz; VBW:1MHz; Span:100MHz ◦
3. Receiver setting (AVG Detector) : RBW:1MHz; VBW:30Hz; Span:20MHz ◦
4. Emission Level = Reading Level + Probe Factor + Cable Loss- PreAMP.
5. The average measurement was not performed when the peak measured data under the limit of average detection. If the readings given are average, peak measurement should also be supplied.

Product : Tablet PC System
 Test Item : Harmonic Radiated Emission Data
 Test Site : No.2 OATS
 Test Mode : Channel 11 (11Mbps)

| Frequency | Cable | Probe | PreAMP | Reading | Emission | Margin | Peak | Average |
|-----------|-------|--------|--------|---------|----------|--------|--------|---------|
| MHz | Loss | Factor | dB | Level | Level | dB | Limit | Limit |
| | dB | dB/m | | dBuV | dBuV/m | | dBuV/m | dBuV/m |

Horizontal

Peak Detector:

| | | | | | | | | |
|----------|-------|-------|-------|-------|---------|-------|-------|-------|
| 4924.257 | 6.26 | 33.90 | 19.49 | 28.67 | 49.34 | 24.66 | 74.00 | 54.00 |
| 7386.324 | 7.42 | 37.14 | 18.22 | 24.32 | < 50.66 | 23.34 | 74.00 | 54.00 |
| 9848.315 | 8.97 | 38.47 | 15.70 | 18.45 | < 50.19 | 23.81 | 74.00 | 54.00 |
| 12310.29 | 10.27 | 39.12 | 16.18 | 18.39 | < 51.60 | 22.40 | 74.00 | 54.00 |
| 14772.61 | 10.68 | 39.53 | 17.01 | 18.07 | < 51.27 | 22.73 | 74.00 | 54.00 |
| 17234.67 | 12.33 | 43.99 | 16.40 | 10.99 | < 50.91 | 23.09 | 74.00 | 54.00 |
| 19696.75 | 12.79 | 37.97 | 18.32 | 19.82 | < 52.26 | 21.74 | 74.00 | 54.00 |
| 22158.88 | 13.10 | 37.40 | 18.82 | 20.44 | < 52.11 | 21.89 | 74.00 | 54.00 |
| 24621.10 | 13.78 | 39.50 | 19.12 | 17.41 | < 51.57 | 22.43 | 74.00 | 54.00 |

Vertical

Peak Detector:

| | | | | | | | | |
|----------|-------|-------|-------|-------|---------|-------|-------|-------|
| 4924.217 | 6.26 | 33.90 | 19.49 | 29.34 | 50.01 | 23.99 | 74.00 | 54.00 |
| 7386.422 | 7.42 | 37.14 | 18.22 | 23.17 | < 49.51 | 24.49 | 74.00 | 54.00 |
| 9848.617 | 8.97 | 38.47 | 15.70 | 19.29 | < 51.03 | 22.97 | 74.00 | 54.00 |
| 12310.61 | 10.27 | 39.12 | 16.18 | 17.01 | < 50.22 | 23.78 | 74.00 | 54.00 |
| 14772.44 | 10.68 | 39.53 | 17.01 | 18.19 | < 51.39 | 22.61 | 74.00 | 54.00 |
| 17234.70 | 12.33 | 43.99 | 16.40 | 11.86 | < 51.78 | 22.22 | 74.00 | 54.00 |
| 19696.45 | 12.79 | 37.97 | 18.32 | 18.94 | < 51.38 | 22.62 | 74.00 | 54.00 |
| 22158.38 | 13.10 | 37.40 | 18.82 | 20.27 | < 51.94 | 22.06 | 74.00 | 54.00 |
| 24621.67 | 13.78 | 39.50 | 19.12 | 18.02 | < 52.18 | 21.82 | 74.00 | 54.00 |

Note:

1. All Readings below 1GHz are Quasi-Peak, above are average value.
2. Receiver setting (Peak Detector) : RBW:1MHz; VBW:1MHz; Span:100MHz ◦
3. Receiver setting (AVG Detector) : RBW:1MHz; VBW:30Hz; Span:20MHz ◦
4. Emission Level = Reading Level + Probe Factor + Cable Loss- PreAMP.
5. The average measurement was not performed when the peak measured data under the limit of average detection. If the readings given are average, peak measurement should also be supplied.

Product : Tablet PC System
 Test Item : General Radiated Emission Data
 Test Site : No.2 OATS
 Test Mode : Channel 1 (1Mbps)

| Frequency | Cable Loss | Probe Factor | PreAMP | Reading Level | Emission Level | Margin | Limit |
|-----------|------------|--------------|--------|---------------|----------------|--------|--------|
| MHz | dB | dB/m | dB | dBuV | dBuV/m | dB | dBuV/m |

Horizontal:

| | | | | | | | |
|-----------|------|-------|------|-------|-------|-------|-------|
| 166.155 | 1.57 | 9.12 | 0.00 | 20.54 | 31.23 | 12.27 | 43.50 |
| 232.476 | 1.92 | 9.61 | 0.00 | 25.90 | 37.43 | 8.57 | 46.00 |
| 398.580 | 2.78 | 14.62 | 0.00 | 20.24 | 37.64 | 8.36 | 46.00 |
| 598.250 | 3.80 | 17.71 | 0.00 | 13.64 | 35.15 | 10.85 | 46.00 |
| 631.350 | 3.97 | 18.64 | 0.00 | 14.97 | 37.58 | 8.42 | 46.00 |
| * 664.140 | 4.13 | 18.42 | 0.00 | 17.19 | 39.74 | 6.26 | 46.00 |

Vertical:

| | | | | | | | |
|-----------|------|-------|------|-------|-------|-------|-------|
| 64.241 | 1.04 | 6.13 | 0.00 | 19.34 | 26.52 | 13.48 | 40.00 |
| 132.475 | 1.40 | 10.55 | 0.00 | 17.54 | 29.49 | 14.01 | 43.50 |
| 232.660 | 1.92 | 10.01 | 0.00 | 20.08 | 32.01 | 13.99 | 46.00 |
| * 398.570 | 2.78 | 16.13 | 0.00 | 20.08 | 38.99 | 7.01 | 46.00 |
| 455.057 | 3.06 | 16.66 | 0.00 | 17.66 | 37.37 | 8.63 | 46.00 |
| 664.680 | 4.14 | 17.63 | 0.00 | 15.18 | 36.95 | 9.05 | 46.00 |

Note:

1. All Readings below 1GHz are Quasi-Peak, above are average value.
2. “ * ”, means this data is the worst emission level.
3. Emission Level = Reading Level + Probe Factor + Cable Loss.

Product : Tablet PC System
 Test Item : General Radiated Emission Data
 Test Site : No.2 OATS
 Test Mode : Channel 6 (1Mbps)

| Frequency | Cable | Probe | PreAMP | Reading | Emission | Margin | Limit |
|-----------|-------|--------|--------|---------|----------|--------|--------|
| | Loss | Factor | | Level | Level | | |
| MHz | dB | dB/m | dB | dBuV | dBuV/m | dB | dBuV/m |

Horizontal:

| | | | | | | | |
|-----------|------|-------|------|-------|-------|-------|-------|
| 67.924 | 1.07 | 5.99 | 0.00 | 20.37 | 27.43 | 12.57 | 40.00 |
| 112.647 | 1.29 | 12.01 | 0.00 | 17.46 | 30.76 | 12.74 | 43.50 |
| 167.995 | 1.59 | 8.99 | 0.00 | 18.30 | 28.87 | 14.63 | 43.50 |
| 220.995 | 1.85 | 8.63 | 0.00 | 19.34 | 29.82 | 16.18 | 46.00 |
| * 398.611 | 2.78 | 14.62 | 0.00 | 21.74 | 39.14 | 6.86 | 46.00 |
| 532.588 | 3.45 | 16.61 | 0.00 | 16.70 | 36.76 | 9.24 | 46.00 |

Vertical:

| | | | | | | | |
|-----------|------|-------|------|-------|-------|-------|-------|
| 48.925 | 0.96 | 7.00 | 0.00 | 21.33 | 29.30 | 10.70 | 40.00 |
| 130.352 | 1.39 | 10.59 | 0.00 | 17.49 | 29.47 | 14.03 | 43.50 |
| 167.245 | 1.57 | 8.47 | 0.00 | 22.67 | 32.71 | 10.79 | 43.50 |
| 216.348 | 1.82 | 9.33 | 0.00 | 18.27 | 29.43 | 16.57 | 46.00 |
| 300.924 | 2.27 | 12.06 | 0.00 | 19.36 | 33.69 | 12.31 | 46.00 |
| * 440.674 | 2.99 | 16.97 | 0.00 | 18.66 | 38.62 | 7.38 | 46.00 |

Note:

1. All Readings below 1GHz are Quasi-Peak, above are average value.
2. “ * ”, means this data is the worst emission level.
3. Emission Level = Reading Level + Probe Factor + Cable Loss.

Product : Tablet PC System
 Test Item : General Radiated Emission Data
 Test Site : No.2 OATS
 Test Mode : Channel 11 (1Mbps)

| Frequency | Cable Loss | Probe Factor | PreAMP | Reading Level | Emission Level | Margin | Limit |
|-----------|------------|--------------|--------|---------------|----------------|--------|--------|
| MHz | dB | dB/m | dB | dBuV | dBuV/m | dB | dBuV/m |

Horizontal:

| | | | | | | | |
|-----------|------|-------|------|-------|-------|-------|-------|
| 86.992 | 1.16 | 9.46 | 0.00 | 22.34 | 32.96 | 7.04 | 40.00 |
| 144.511 | 1.45 | 10.66 | 0.00 | 18.84 | 30.95 | 12.55 | 43.50 |
| 200.365 | 1.74 | 8.40 | 0.00 | 21.54 | 31.68 | 11.82 | 43.50 |
| 240.674 | 1.96 | 10.57 | 0.00 | 19.33 | 31.86 | 14.14 | 46.00 |
| 362.847 | 2.59 | 13.83 | 0.00 | 17.33 | 33.76 | 12.24 | 46.00 |
| * 631.350 | 3.97 | 18.64 | 0.00 | 16.74 | 39.35 | 6.65 | 46.00 |

Vertical:

| | | | | | | | |
|-----------|------|-------|------|-------|-------|-------|-------|
| 132.360 | 1.40 | 10.59 | 0.00 | 16.79 | 28.78 | 14.72 | 43.50 |
| 209.748 | 1.80 | 8.85 | 0.00 | 21.39 | 32.03 | 11.47 | 43.50 |
| 298.355 | 2.25 | 12.14 | 0.00 | 18.64 | 33.03 | 12.97 | 46.00 |
| * 398.557 | 2.78 | 16.13 | 0.00 | 20.34 | 39.25 | 6.75 | 46.00 |
| 482.662 | 3.20 | 16.53 | 0.00 | 18.37 | 38.10 | 7.90 | 46.00 |
| 664.160 | 4.13 | 17.70 | 0.00 | 16.75 | 38.58 | 7.42 | 46.00 |

Note:

1. All Readings below 1GHz are Quasi-Peak, above are average value.
2. “ * ”, means this data is the worst emission level.
3. Emission Level = Reading Level + Probe Factor + Cable Loss.

Product : Tablet PC System
 Test Item : General Radiated Emission Data
 Test Site : No.2 OATS
 Test Mode : Channel 1 (11Mbps)

| Frequency | Cable Loss | Probe Factor | PreAMP | Reading Level | Emission Level | Margin | Limit |
|-----------|------------|--------------|--------|---------------|----------------|--------|--------|
| MHz | dB | dB/m | dB | dBuV | dBuV/m | dB | dBuV/m |

Horizontal:

| | | | | | | | |
|-----------|------|-------|------|-------|-------|-------|-------|
| 68.113 | 1.07 | 5.99 | 0.00 | 22.64 | 29.70 | 10.30 | 40.00 |
| 110.664 | 1.28 | 12.01 | 0.00 | 16.98 | 30.27 | 13.23 | 43.50 |
| 170.005 | 1.60 | 8.93 | 0.00 | 19.68 | 30.21 | 13.29 | 43.50 |
| 232.847 | 1.92 | 9.61 | 0.00 | 19.65 | 31.18 | 14.82 | 46.00 |
| 367.552 | 2.62 | 14.21 | 0.00 | 19.04 | 35.87 | 10.13 | 46.00 |
| * 664.030 | 4.13 | 18.42 | 0.00 | 17.03 | 39.58 | 6.42 | 46.00 |

Vertical:

| | | | | | | | |
|-----------|------|-------|------|-------|-------|-------|-------|
| 76.315 | 1.11 | 6.73 | 0.00 | 18.33 | 26.17 | 13.83 | 40.00 |
| 126.348 | 1.36 | 10.27 | 0.00 | 19.95 | 31.58 | 11.92 | 43.50 |
| 184.225 | 1.67 | 8.31 | 0.00 | 20.48 | 30.45 | 13.05 | 43.50 |
| 262.884 | 2.08 | 13.22 | 0.00 | 17.85 | 33.15 | 12.85 | 46.00 |
| 445.652 | 3.02 | 17.05 | 0.00 | 18.37 | 38.44 | 7.56 | 46.00 |
| * 721.334 | 4.44 | 19.74 | 0.00 | 15.24 | 39.41 | 6.59 | 46.00 |

Note:

1. All Readings below 1GHz are Quasi-Peak, above are average value.
2. “ * ”, means this data is the worst emission level.
3. Emission Level = Reading Level + Probe Factor + Cable Loss.

Product : Tablet PC System
 Test Item : General Radiated Emission Data
 Test Site : No.2 OATS
 Test Mode : Channel 6 (11Mbps)

| Frequency | Cable | Probe | PreAMP | Reading | Emission | Margin | Limit |
|-----------|-------|--------|--------|---------|----------|--------|--------|
| MHz | Loss | Factor | | Level | Level | | |
| | dB | dB/m | dB | dBuV | dBuV/m | dB | dBuV/m |

Horizontal:

| | | | | | | | |
|-----------|------|-------|------|-------|-------|-------|-------|
| 71.994 | 1.08 | 6.64 | 0.00 | 18.34 | 26.07 | 13.93 | 40.00 |
| 144.821 | 1.47 | 10.66 | 0.00 | 20.66 | 32.78 | 10.72 | 43.50 |
| 167.252 | 1.57 | 9.09 | 0.00 | 21.95 | 32.61 | 10.89 | 43.50 |
| 232.448 | 1.92 | 9.61 | 0.00 | 19.37 | 30.90 | 15.10 | 46.00 |
| * 322.474 | 2.38 | 12.22 | 0.00 | 21.74 | 36.34 | 9.66 | 46.00 |
| 530.347 | 3.45 | 16.59 | 0.00 | 15.11 | 35.15 | 10.85 | 46.00 |

Vertical:

| | | | | | | | |
|-----------|------|-------|------|-------|-------|-------|-------|
| 50.364 | 0.98 | 6.60 | 0.00 | 17.68 | 25.26 | 14.74 | 40.00 |
| 120.445 | 1.33 | 10.36 | 0.00 | 21.57 | 33.26 | 10.24 | 43.50 |
| 162.240 | 1.55 | 8.53 | 0.00 | 16.30 | 26.37 | 17.13 | 43.50 |
| 200.015 | 1.74 | 8.40 | 0.00 | 19.24 | 29.38 | 14.12 | 43.50 |
| 398.580 | 2.78 | 16.13 | 0.00 | 19.68 | 38.59 | 7.41 | 46.00 |
| * 631.362 | 3.97 | 18.65 | 0.00 | 16.34 | 38.96 | 7.04 | 46.00 |

Note:

1. All Readings below 1GHz are Quasi-Peak, above are average value.
2. “ * ”, means this data is the worst emission level.
3. Emission Level = Reading Level + Probe Factor + Cable Loss.

Product : Tablet PC System
 Test Item : General Radiated Emission Data
 Test Site : No.2 OATS
 Test Mode : Channel 11 (11Mbps)

| Frequency | Cable | Probe | PreAMP | Reading | Emission | Margin | Limit |
|-----------|-------|--------|--------|---------|----------|--------|--------|
| MHz | Loss | Factor | | Level | Level | dB | dBuV/m |
| | dB | dB/m | dB | dBuV | dBuV/m | | |

Horizontal:

| | | | | | | | |
|-----------|------|-------|------|-------|-------|-------|-------|
| 132.226 | 1.40 | 11.69 | 0.00 | 19.34 | 32.43 | 11.07 | 43.50 |
| 150.740 | 1.49 | 10.32 | 0.00 | 13.84 | 25.66 | 17.84 | 43.50 |
| 266.844 | 2.09 | 12.24 | 0.00 | 18.20 | 32.53 | 13.47 | 46.00 |
| 398.647 | 2.78 | 14.62 | 0.00 | 18.69 | 36.09 | 9.91 | 46.00 |
| 455.101 | 3.06 | 16.34 | 0.00 | 16.74 | 36.14 | 9.86 | 46.00 |
| * 621.884 | 3.93 | 18.68 | 0.00 | 15.84 | 38.45 | 7.55 | 46.00 |

Vertical:

| | | | | | | | |
|-----------|------|-------|------|-------|-------|-------|-------|
| 82.664 | 1.14 | 7.53 | 0.00 | 16.72 | 25.39 | 14.61 | 40.00 |
| 118.245 | 1.32 | 10.49 | 0.00 | 19.24 | 31.05 | 12.45 | 43.50 |
| 167.334 | 1.57 | 8.47 | 0.00 | 20.37 | 30.41 | 13.09 | 43.50 |
| 230.245 | 1.90 | 9.73 | 0.00 | 19.30 | 30.94 | 15.06 | 46.00 |
| 371.881 | 2.63 | 14.87 | 0.00 | 16.64 | 34.14 | 11.86 | 46.00 |
| * 560.012 | 3.60 | 19.04 | 0.00 | 14.76 | 37.40 | 8.60 | 46.00 |

Note:

1. All Readings below 1GHz are Quasi-Peak, above are average value.
2. “ * ”, means this data is the worst emission level.
3. Emission Level = Reading Level + Probe Factor + Cable Loss.

Product : Tablet PC System
 Test Item : Harmonic Radiated Emission Data
 Test Site : No.2 OATS
 Test Mode : Channel 1 (1Mbps) (Flat on Turntable)

| Frequency | Cable | Probe | PreAMP | Reading | Emission | Margin | Peak | Average |
|-----------|-------|--------|--------|---------|----------|--------|--------|---------|
| MHz | Loss | Factor | | Level | Level | | Limit | Limit |
| | dB | dB/m | dB | dBuV | dBuV/m | dB | dBuV/m | dBuV/m |

Horizontal

Peak Detector:

| | | | | | | | | |
|----------|------|-------|-------|-------|-------|-------|-------|-------|
| 4825.713 | 6.17 | 33.64 | 19.50 | 30.19 | 50.50 | 23.50 | 74.00 | 54.00 |
| 7238.254 | 7.33 | 36.77 | 18.33 | 25.41 | 51.18 | 22.82 | 74.00 | 54.00 |
| 9651.096 | 8.73 | 38.25 | 15.86 | 20.72 | 51.84 | 22.16 | 74.00 | 54.00 |

Vertical

Peak Detector:

| | | | | | | | | |
|----------|------|-------|-------|-------|-------|-------|-------|-------|
| 4825.773 | 6.17 | 33.64 | 19.50 | 32.10 | 52.41 | 21.59 | 74.00 | 54.00 |
| 7238.494 | 7.33 | 36.77 | 18.33 | 25.14 | 50.91 | 23.09 | 74.00 | 54.00 |
| 9651.381 | 8.73 | 38.25 | 15.86 | 20.75 | 51.87 | 22.13 | 74.00 | 54.00 |

Note:

1. All Readings below 1GHz are Quasi-Peak, above are average value.
2. Receiver setting (Peak Detector) : RBW:1MHz; VBW:1MHz; Span:100MHz °
3. Receiver setting (AVG Detector) : RBW:1MHz; VBW:30Hz; Span:20MHz °
4. Emission Level = Reading Level + Probe Factor + Cable Loss- PreAMP.
5. The average measurement was not performed when the peak measured data under the limit of average detection. If the readings given are average, peak measurement should also be supplied.

Product : Tablet PC System
 Test Item : Harmonic Radiated Emission Data
 Test Site : No.2 OATS
 Test Mode : Channel 6 (1Mbps) (Flat on Turntable)

| Frequency | Cable | Probe | PreAMP | Reading | Emission | Margin | Peak | Average |
|-----------|-------|--------|--------|---------|----------|--------|--------|---------|
| MHz | Loss | Factor | | Level | Level | | Limit | Limit |
| | dB | dB/m | dB | dBuV | dBuV/m | dB | dBuV/m | dBuV/m |

Horizontal

Peak Detector:

| | | | | | | | | |
|----------|------|-------|-------|-------|-------|-------|-------|-------|
| 4874.647 | 6.21 | 33.77 | 19.50 | 29.86 | 50.35 | 23.65 | 74.00 | 54.00 |
| 7312.016 | 7.37 | 36.98 | 18.27 | 24.83 | 50.91 | 23.09 | 74.00 | 54.00 |
| 9749.324 | 8.87 | 38.35 | 15.82 | 20.19 | 51.59 | 22.41 | 74.00 | 54.00 |

Vertical

Peak Detector:

| | | | | | | | | |
|----------|------|-------|-------|-------|-------|-------|-------|-------|
| 4874.639 | 6.21 | 33.77 | 19.50 | 29.84 | 50.33 | 23.67 | 74.00 | 54.00 |
| 7311.955 | 7.37 | 36.98 | 18.27 | 24.71 | 50.79 | 23.21 | 74.00 | 54.00 |
| 9749.264 | 8.87 | 38.35 | 15.82 | 20.32 | 51.72 | 22.28 | 74.00 | 54.00 |

Note:

1. All Readings below 1GHz are Quasi-Peak, above are average value.
2. Receiver setting (Peak Detector) : RBW:1MHz; VBW:1MHz; Span:100MHz ◦
3. Receiver setting (AVG Detector) : RBW:1MHz; VBW:30Hz; Span:20MHz ◦
4. Emission Level = Reading Level + Probe Factor + Cable Loss- PreAMP.
5. The average measurement was not performed when the peak measured data under the limit of average detection. If the readings given are average, peak measurement should also be supplied.

Product : Tablet PC System
 Test Item : Harmonic Radiated Emission Data
 Test Site : No.2 OATS
 Test Mode : Channel 11 (1Mbps) (Flat on Turntable)

| Frequency | Cable | Probe | PreAMP | Reading | Emission | Margin | Peak | Average |
|-----------|-------|--------|--------|---------|----------|--------|--------|---------|
| MHz | Loss | Factor | dB | Level | Level | dB | Limit | Limit |
| | dB | dB/m | | dBuV | dBuV/m | | dBuV/m | dBuV/m |

Horizontal

Peak Detector:

| | | | | | | | | |
|----------|------|-------|-------|-------|-------|-------|-------|-------|
| 4924.751 | 6.23 | 33.90 | 19.49 | 29.72 | 50.37 | 23.63 | 74.00 | 54.00 |
| 7387.024 | 7.42 | 37.14 | 18.22 | 24.93 | 51.27 | 22.73 | 74.00 | 54.00 |
| 9849.352 | 8.97 | 38.44 | 15.70 | 20.45 | 52.16 | 21.84 | 74.00 | 54.00 |

Vertical

Peak Detector:

| | | | | | | | | |
|----------|------|-------|-------|-------|-------|-------|-------|-------|
| 4924.871 | 6.23 | 33.90 | 19.49 | 31.07 | 51.72 | 22.28 | 74.00 | 54.00 |
| 7387.358 | 7.42 | 37.14 | 18.22 | 24.30 | 50.64 | 23.36 | 74.00 | 54.00 |
| 9849.711 | 8.97 | 38.44 | 15.70 | 19.68 | 51.39 | 22.61 | 74.00 | 54.00 |

Note:

1. All Readings below 1GHz are Quasi-Peak, above are average value.
2. Receiver setting (Peak Detector) : RBW:1MHz; VBW:1MHz; Span:100MHz ◦
3. Receiver setting (AVG Detector) : RBW:1MHz; VBW:30Hz; Span:20MHz ◦
4. Emission Level = Reading Level + Probe Factor + Cable Loss- PreAMP.
5. The average measurement was not performed when the peak measured data under the limit of average detection. If the readings given are average, peak measurement should also be supplied.

Product : Tablet PC System
 Test Item : Harmonic Radiated Emission Data
 Test Site : No.2 OATS
 Test Mode : Channel 1 (11Mbps) (Flat on Turntable)

| Frequency | Cable | Probe | PreAMP | Reading | Emission | Margin | Peak | Average |
|-----------|-------|--------|--------|---------|----------|--------|--------|---------|
| MHz | Loss | Factor | dB | Level | Level | dB | Limit | Limit |
| | dB | dB/m | | dBuV | dBuV/m | | dBuV/m | dBuV/m |

Horizontal

Peak Detector:

| | | | | | | | | |
|----------|------|-------|-------|-------|-------|-------|-------|-------|
| 4824.749 | 6.17 | 33.64 | 19.50 | 29.18 | 49.49 | 24.51 | 74.00 | 54.00 |
| 7237.024 | 7.33 | 36.77 | 18.33 | 24.88 | 50.65 | 23.35 | 74.00 | 54.00 |
| 9649.350 | 8.73 | 38.25 | 15.86 | 20.81 | 51.93 | 22.07 | 74.00 | 54.00 |

Vertical

Peak Detector:

| | | | | | | | | |
|----------|------|-------|-------|-------|-------|-------|-------|-------|
| 4824.748 | 6.17 | 33.64 | 19.50 | 29.97 | 50.28 | 23.72 | 74.00 | 54.00 |
| 7237.082 | 7.33 | 36.77 | 18.33 | 25.08 | 50.85 | 23.15 | 74.00 | 54.00 |
| 9649.339 | 8.73 | 38.25 | 15.86 | 21.25 | 52.37 | 21.63 | 74.00 | 54.00 |

Note:

1. All Readings below 1GHz are Quasi-Peak, above are average value.
2. Receiver setting (Peak Detector) : RBW:1MHz; VBW:1MHz; Span:100MHz ◦
3. Receiver setting (AVG Detector) : RBW:1MHz; VBW:30Hz; Span:20MHz ◦
4. Emission Level = Reading Level + Probe Factor + Cable Loss- PreAMP.
5. The average measurement was not performed when the peak measured data under the limit of average detection. If the readings given are average, peak measurement should also be supplied.

Product : Tablet PC System
 Test Item : Harmonic Radiated Emission Data
 Test Site : No.2 OATS
 Test Mode : Channel 6 (11Mbps) (Flat on Turntable)

| Frequency | Cable | Probe | PreAMP | Reading | Emission | Margin | Peak | Average |
|-----------|-------|--------|--------|---------|----------|--------|--------|---------|
| MHz | Loss | Factor | | Level | Level | | Limit | Limit |
| | dB | dB/m | dB | dBuV | dBuV/m | dB | dBuV/m | dBuV/m |

Horizontal

Peak Detector:

| | | | | | | | | |
|----------|------|-------|-------|-------|-------|-------|-------|-------|
| 4877.773 | 6.21 | 33.77 | 19.50 | 29.88 | 50.37 | 23.63 | 74.00 | 54.00 |
| 7316.645 | 7.37 | 36.98 | 18.27 | 25.21 | 51.29 | 22.71 | 74.00 | 54.00 |
| 9755.498 | 8.87 | 38.35 | 15.82 | 20.21 | 51.61 | 22.39 | 74.00 | 54.00 |

Vertical

Peak Detector:

| | | | | | | | | |
|----------|------|-------|-------|-------|-------|-------|-------|-------|
| 4876.450 | 6.21 | 33.77 | 19.50 | 29.09 | 49.58 | 24.42 | 74.00 | 54.00 |
| 7314.572 | 7.37 | 36.98 | 18.27 | 24.60 | 50.68 | 23.32 | 74.00 | 54.00 |
| 9752.750 | 8.87 | 38.35 | 15.82 | 20.32 | 51.72 | 22.28 | 74.00 | 54.00 |

Note:

1. All Readings below 1GHz are Quasi-Peak, above are average value.
2. Receiver setting (Peak Detector) : RBW:1MHz; VBW:1MHz; Span:100MHz °
3. Receiver setting (AVG Detector) : RBW:1MHz; VBW:30Hz; Span:20MHz °
4. Emission Level = Reading Level + Probe Factor + Cable Loss- PreAMP.
5. The average measurement was not performed when the peak measured data under the limit of average detection. If the readings given are average, peak measurement should also be supplied.

Product : Tablet PC System
 Test Item : Harmonic Radiated Emission Data
 Test Site : No.2 OATS
 Test Mode : Channel 11 (11Mbps) (Flat on Turntable)

| Frequency | Cable | Probe | PreAMP | Reading | Emission | Margin | Peak | Average |
|-----------|-------|--------|--------|---------|----------|--------|--------|---------|
| MHz | Loss | Factor | | Level | Level | | Limit | Limit |
| | dB | dB/m | dB | dBuV | dBuV/m | dB | dBuV/m | dBuV/m |

Horizontal

Peak Detector:

| | | | | | | | | |
|----------|------|-------|-------|-------|-------|-------|-------|-------|
| 4924.090 | 6.23 | 33.90 | 19.49 | 29.52 | 50.17 | 23.83 | 74.00 | 54.00 |
| 7386.030 | 7.42 | 37.14 | 18.22 | 24.75 | 51.09 | 22.91 | 74.00 | 54.00 |
| 9848.024 | 8.97 | 38.44 | 15.70 | 20.45 | 52.16 | 21.84 | 74.00 | 54.00 |

Vertical

Peak Detector:

| | | | | | | | | |
|----------|------|-------|-------|-------|-------|-------|-------|-------|
| 4924.030 | 6.23 | 33.90 | 19.49 | 29.18 | 49.83 | 24.17 | 74.00 | 54.00 |
| 7386.024 | 7.42 | 37.14 | 18.22 | 24.15 | 50.49 | 23.51 | 74.00 | 54.00 |
| 9848.010 | 8.97 | 38.44 | 15.70 | 19.71 | 51.42 | 22.58 | 74.00 | 54.00 |

Note:

1. All Readings below 1GHz are Quasi-Peak, above are average value.
2. Receiver setting (Peak Detector) : RBW:1MHz; VBW:1MHz; Span:100MHz ◦
3. Receiver setting (AVG Detector) : RBW:1MHz; VBW:30Hz; Span:20MHz ◦
4. Emission Level = Reading Level + Probe Factor + Cable Loss- PreAMP.
5. The average measurement was not performed when the peak measured data under the limit of average detection. If the readings given are average, peak measurement should also be supplied.

Product : Tablet PC System
 Test Item : General Radiated Emission Data
 Test Site : No.2 OATS
 Test Mode : Channel 1 (1Mbps) (Flat on Turntable)

| Frequency | Cable Loss | Probe Factor | PreAMP | Reading Level | Emission Level | Margin | Limit |
|-----------|------------|--------------|--------|---------------|----------------|--------|--------|
| MHz | dB | dB/m | dB | dBuV | dBuV/m | dB | dBuV/m |

Horizontal:

| | | | | | | | |
|-----------|------|-------|------|-------|-------|------|-------|
| 50.690 | 0.97 | 7.73 | 0.00 | 25.09 | 33.80 | 6.20 | 40.00 |
| 133.590 | 1.40 | 11.39 | 0.00 | 22.81 | 35.60 | 7.90 | 43.50 |
| * 232.730 | 1.91 | 9.61 | 0.00 | 32.32 | 43.84 | 2.16 | 46.00 |
| 397.630 | 2.76 | 14.62 | 0.00 | 22.40 | 39.79 | 6.21 | 46.00 |
| 584.840 | 3.73 | 18.19 | 0.00 | 18.65 | 40.57 | 5.43 | 46.00 |
| 779.810 | 4.73 | 19.03 | 0.00 | 18.38 | 42.14 | 3.86 | 46.00 |
| 996.120 | 5.85 | 20.77 | 0.00 | 18.15 | 44.76 | 9.24 | 54.00 |

Vertical:

| | | | | | | | |
|-----------|------|-------|------|-------|-------|------|-------|
| 66.350 | 1.05 | 5.86 | 0.00 | 30.68 | 37.59 | 2.41 | 40.00 |
| 133.250 | 1.40 | 10.55 | 0.00 | 23.29 | 35.24 | 8.26 | 43.50 |
| 232.730 | 1.91 | 10.01 | 0.00 | 30.77 | 42.69 | 3.31 | 46.00 |
| 398.600 | 2.77 | 16.13 | 0.00 | 20.58 | 39.48 | 6.52 | 46.00 |
| 597.450 | 3.79 | 19.42 | 0.00 | 19.66 | 42.88 | 3.12 | 46.00 |
| * 779.810 | 4.73 | 19.88 | 0.00 | 19.37 | 43.98 | 2.02 | 46.00 |
| 997.090 | 5.85 | 19.97 | 0.00 | 21.78 | 47.59 | 6.41 | 54.00 |

Note:

1. All Readings below 1GHz are Quasi-Peak, above are average value.
2. “ * ”, means this data is the worst emission level.
3. Emission Level = Reading Level + Probe Factor + Cable Loss.

Product : Tablet PC System
 Test Item : General Radiated Emission Data
 Test Site : No.2 OATS
 Test Mode : Channel 6 (1Mbps) (Flat on Turntable)

| Frequency | Cable | Probe | PreAMP | Reading | Emission | Margin | Limit |
|-----------|-------|--------|--------|---------|----------|--------|--------|
| MHz | Loss | Factor | | Level | Level | | |
| | dB | dB/m | dB | dBuV | dBuV/m | dB | dBuV/m |

Horizontal:

| | | | | | | | |
|-----------|------|-------|------|-------|-------|------|-------|
| 66.320 | 1.05 | 5.66 | 0.00 | 28.49 | 35.21 | 4.79 | 40.00 |
| 133.650 | 1.40 | 11.39 | 0.00 | 22.47 | 35.26 | 8.24 | 43.50 |
| 231.760 | 1.91 | 9.57 | 0.00 | 32.28 | 43.76 | 2.24 | 46.00 |
| 299.660 | 2.26 | 12.53 | 0.00 | 22.93 | 37.72 | 8.28 | 46.00 |
| 398.600 | 2.77 | 14.62 | 0.00 | 21.45 | 38.84 | 7.16 | 46.00 |
| * 597.450 | 3.79 | 17.71 | 0.00 | 22.28 | 43.79 | 2.21 | 46.00 |
| 779.810 | 4.73 | 19.03 | 0.00 | 17.88 | 41.64 | 4.36 | 46.00 |
| 996.120 | 5.85 | 20.77 | 0.00 | 18.42 | 45.03 | 8.97 | 54.00 |

Vertical:

| | | | | | | | |
|-----------|------|-------|------|-------|-------|------|-------|
| 66.320 | 1.05 | 5.86 | 0.00 | 28.29 | 35.20 | 4.80 | 40.00 |
| 133.690 | 1.40 | 10.49 | 0.00 | 23.50 | 35.40 | 8.10 | 43.50 |
| 231.760 | 1.91 | 9.87 | 0.00 | 30.74 | 42.52 | 3.48 | 46.00 |
| 324.880 | 2.39 | 12.59 | 0.00 | 22.57 | 37.55 | 8.45 | 46.00 |
| 398.600 | 2.77 | 16.13 | 0.00 | 19.26 | 38.16 | 7.84 | 46.00 |
| 597.450 | 3.79 | 19.42 | 0.00 | 18.59 | 41.81 | 4.19 | 46.00 |
| * 779.810 | 4.73 | 19.88 | 0.00 | 19.71 | 44.32 | 1.68 | 46.00 |
| 997.090 | 5.85 | 19.97 | 0.00 | 21.21 | 47.02 | 6.98 | 54.00 |

Note:

1. All Readings below 1GHz are Quasi-Peak, above are average value.
2. “ * ”, means this data is the worst emission level.
3. Emission Level = Reading Level + Probe Factor + Cable Loss.

Product : Tablet PC System
 Test Item : General Radiated Emission Data
 Test Site : No.2 OATS
 Test Mode : Channel 11 (1Mbps) (Flat on Turntable)

| Frequency | Cable Loss | Probe Factor | PreAMP | Reading Level | Emission Level | Margin | Limit |
|-----------|------------|--------------|--------|---------------|----------------|--------|--------|
| MHz | dB | dB/m | dB | dBuV | dBuV/m | dB | dBuV/m |

Horizontal:

| | | | | | | | |
|-----------|------|-------|------|-------|-------|------|-------|
| 66.350 | 1.05 | 5.66 | 0.00 | 28.68 | 35.40 | 4.60 | 40.00 |
| 133.650 | 1.40 | 11.39 | 0.00 | 22.47 | 35.26 | 8.24 | 43.50 |
| * 232.730 | 1.91 | 9.61 | 0.00 | 33.39 | 44.91 | 1.09 | 46.00 |
| 398.600 | 2.77 | 14.62 | 0.00 | 22.58 | 39.97 | 6.03 | 46.00 |
| 598.420 | 3.80 | 17.65 | 0.00 | 22.79 | 44.24 | 1.76 | 46.00 |
| 779.810 | 4.73 | 19.03 | 0.00 | 17.82 | 41.58 | 4.42 | 46.00 |
| 997.090 | 5.85 | 20.77 | 0.00 | 17.71 | 44.32 | 9.68 | 54.00 |

Vertical:

| | | | | | | | |
|-----------|------|-------|------|-------|-------|------|-------|
| 66.390 | 1.06 | 5.96 | 0.00 | 28.18 | 35.20 | 4.80 | 40.00 |
| 133.650 | 1.40 | 10.49 | 0.00 | 24.30 | 36.20 | 7.30 | 43.50 |
| * 232.730 | 1.91 | 10.01 | 0.00 | 31.00 | 42.92 | 3.08 | 46.00 |
| 398.600 | 2.77 | 16.13 | 0.00 | 20.83 | 39.73 | 6.27 | 46.00 |
| 597.450 | 3.79 | 19.42 | 0.00 | 18.13 | 41.35 | 4.65 | 46.00 |
| 779.810 | 4.73 | 19.88 | 0.00 | 15.54 | 40.15 | 5.85 | 46.00 |
| 996.120 | 5.85 | 19.97 | 0.00 | 21.63 | 47.44 | 6.56 | 54.00 |

Note:

1. All Readings below 1GHz are Quasi-Peak, above are average value.
2. “ * ”, means this data is the worst emission level.
3. Emission Level = Reading Level + Probe Factor + Cable Loss.

Product : Tablet PC System
 Test Item : General Radiated Emission Data
 Test Site : No.2 OATS
 Test Mode : Channel 1 (11Mbps) (Flat on Turntable)

| Frequency | Cable Loss | Probe Factor | PreAMP | Reading Level | Emission Level | Margin | Limit |
|-----------|------------|--------------|--------|---------------|----------------|--------|--------|
| MHz | dB | dB/m | dB | dBuV | dBuV/m | dB | dBuV/m |

Horizontal:

| | | | | | | | |
|-----------|------|-------|------|-------|-------|-------|-------|
| 66.320 | 1.05 | 5.66 | 0.00 | 29.28 | 36.00 | 4.00 | 40.00 |
| 133.900 | 1.40 | 11.39 | 0.00 | 22.81 | 35.60 | 7.90 | 43.50 |
| * 232.730 | 1.91 | 9.61 | 0.00 | 33.16 | 44.68 | 1.32 | 46.00 |
| 398.600 | 2.77 | 14.62 | 0.00 | 21.92 | 39.31 | 6.69 | 46.00 |
| 584.840 | 3.73 | 18.19 | 0.00 | 20.62 | 42.54 | 3.46 | 46.00 |
| 779.810 | 4.73 | 19.03 | 0.00 | 18.17 | 41.93 | 4.07 | 46.00 |
| 998.060 | 5.85 | 20.77 | 0.00 | 16.47 | 43.08 | 10.92 | 54.00 |

Vertical:

| | | | | | | | |
|-----------|------|-------|------|-------|-------|------|-------|
| 66.390 | 1.06 | 5.96 | 0.00 | 27.27 | 34.29 | 5.71 | 40.00 |
| 133.650 | 1.40 | 10.49 | 0.00 | 23.36 | 35.26 | 8.24 | 43.50 |
| * 231.760 | 1.91 | 9.87 | 0.00 | 31.14 | 42.92 | 3.08 | 46.00 |
| 398.600 | 2.77 | 16.13 | 0.00 | 19.81 | 38.71 | 7.29 | 46.00 |
| 597.450 | 3.79 | 19.42 | 0.00 | 16.85 | 40.07 | 5.93 | 46.00 |
| 779.810 | 4.73 | 19.88 | 0.00 | 17.41 | 42.02 | 3.98 | 46.00 |
| 997.090 | 5.85 | 19.97 | 0.00 | 20.83 | 46.64 | 7.36 | 54.00 |

Note:

1. All Readings below 1GHz are Quasi-Peak, above are average value.
2. “ * ”, means this data is the worst emission level.
3. Emission Level = Reading Level + Probe Factor + Cable Loss.

Product : Tablet PC System
 Test Item : General Radiated Emission Data
 Test Site : No.2 OATS
 Test Mode : Channel 6 (11Mbps) (Flat on Turntable)

| Frequency | Cable | Probe | PreAMP | Reading | Emission | Margin | Limit |
|-----------|-------|--------|--------|---------|----------|--------|--------|
| MHz | Loss | Factor | | Level | Level | | |
| | dB | dB/m | dB | dBuV | dBuV/m | dB | dBuV/m |

Horizontal:

| | | | | | | | |
|-----------|------|-------|------|-------|-------|-------|-------|
| 66.390 | 1.06 | 5.96 | 0.00 | 28.88 | 35.90 | 4.10 | 40.00 |
| 133.580 | 1.40 | 11.39 | 0.00 | 21.47 | 34.26 | 9.24 | 43.50 |
| * 231.760 | 1.91 | 9.57 | 0.00 | 32.49 | 43.97 | 2.03 | 46.00 |
| 398.600 | 2.77 | 14.62 | 0.00 | 23.40 | 40.79 | 5.21 | 46.00 |
| 597.450 | 3.79 | 17.71 | 0.00 | 19.65 | 41.16 | 4.84 | 46.00 |
| 779.810 | 4.73 | 19.03 | 0.00 | 17.95 | 41.71 | 4.29 | 46.00 |
| 996.120 | 5.85 | 20.77 | 0.00 | 15.91 | 42.52 | 11.48 | 54.00 |

Vertical:

| | | | | | | | |
|-----------|------|-------|------|-------|-------|------|-------|
| 66.380 | 1.05 | 5.86 | 0.00 | 28.79 | 35.70 | 4.30 | 40.00 |
| 133.870 | 1.40 | 10.49 | 0.00 | 22.12 | 34.02 | 9.48 | 43.50 |
| * 232.730 | 1.91 | 10.01 | 0.00 | 32.94 | 44.86 | 1.14 | 46.00 |
| 398.600 | 2.77 | 16.13 | 0.00 | 20.62 | 39.52 | 6.48 | 46.00 |
| 779.810 | 4.73 | 19.88 | 0.00 | 17.50 | 42.11 | 3.89 | 46.00 |
| 997.090 | 5.85 | 19.97 | 0.00 | 20.59 | 46.40 | 7.60 | 54.00 |

Note:

1. All Readings below 1GHz are Quasi-Peak, above are average value.
2. “ * ”, means this data is the worst emission level.
3. Emission Level = Reading Level + Probe Factor + Cable Loss.

Product : Tablet PC System
 Test Item : General Radiated Emission Data
 Test Site : No.2 OATS
 Test Mode : Channel 11 (11Mbps) (Flat on Turntable)

| Frequency | Cable Loss | Probe Factor | PreAMP | Reading Level | Emission Level | Margin | Limit |
|-----------|------------|--------------|--------|---------------|----------------|--------|--------|
| MHz | dB | dB/m | dB | dBuV | dBuV/m | dB | dBuV/m |

Horizontal:

| | | | | | | | |
|-----------|------|-------|------|-------|-------|------|-------|
| 66.450 | 1.06 | 5.96 | 0.00 | 27.08 | 34.10 | 5.90 | 40.00 |
| 133.620 | 1.40 | 11.39 | 0.00 | 21.41 | 34.20 | 9.30 | 43.50 |
| * 232.730 | 1.91 | 9.61 | 0.00 | 31.79 | 43.31 | 2.69 | 46.00 |
| 398.600 | 2.77 | 14.62 | 0.00 | 22.38 | 39.77 | 6.23 | 46.00 |
| 597.450 | 3.79 | 17.71 | 0.00 | 19.57 | 41.08 | 4.92 | 46.00 |
| 779.810 | 4.73 | 19.03 | 0.00 | 17.16 | 40.92 | 5.08 | 46.00 |
| 996.120 | 5.85 | 20.77 | 0.00 | 17.89 | 44.50 | 9.50 | 54.00 |

Vertical:

| | | | | | | | |
|-----------|------|-------|------|-------|-------|------|-------|
| 66.150 | 1.05 | 5.86 | 0.00 | 26.34 | 33.25 | 6.75 | 40.00 |
| 133.950 | 1.40 | 10.49 | 0.00 | 24.10 | 36.00 | 7.50 | 43.50 |
| 231.760 | 1.91 | 9.87 | 0.00 | 31.12 | 42.90 | 3.10 | 46.00 |
| 398.600 | 2.77 | 16.13 | 0.00 | 20.94 | 39.84 | 6.16 | 46.00 |
| 597.450 | 3.79 | 19.42 | 0.00 | 16.89 | 40.11 | 5.89 | 46.00 |
| * 779.810 | 4.73 | 19.88 | 0.00 | 19.09 | 43.70 | 2.30 | 46.00 |
| 996.120 | 5.85 | 19.97 | 0.00 | 21.87 | 47.68 | 6.32 | 54.00 |

Note:

1. All Readings below 1GHz are Quasi-Peak, above are average value.
2. “ * ”, means this data is the worst emission level.
3. Emission Level = Reading Level + Probe Factor + Cable Loss.

6. Band Edge

6.1. Test Equipment

The following test equipments are used during the band edge tests:

| Equipment | Manufacturer | Model No./Serial No. | Last Cal. |
|---------------------|--------------|----------------------|------------|
| X Spectrum Analyzer | Advantest | R3272 / 72421194 | May, 2002 |
| X Test Receiver | R & S | ESCS 30 / 825442/14 | May, 2002 |
| X Spectrum Analyzer | Advantest | R3261C / 71720140 | May, 2002 |
| X Pre-Amplifier | HP | 8447D/3307A01812 | May, 2002 |
| X Bilog Antenna | Chase | CBL6112B / 12452 | Sep., 2002 |
| X Horn Antenna | EM | EM6917 / 103325 | May, 2002 |

- Note: 1. All equipments that need to calibrate are with calibration period of 1 year.
 2. Mark "X" test instruments are used to measure the final test results.

6.2. Test Setup

RF Conducted Measurement:

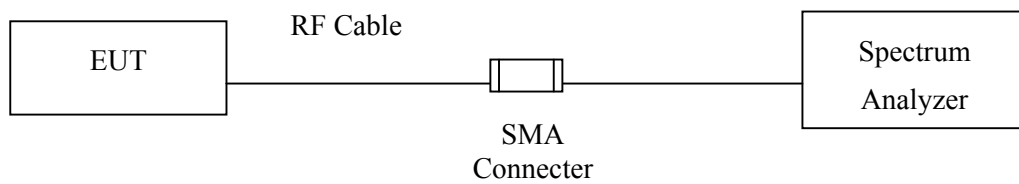

RF Radiated Measurement:

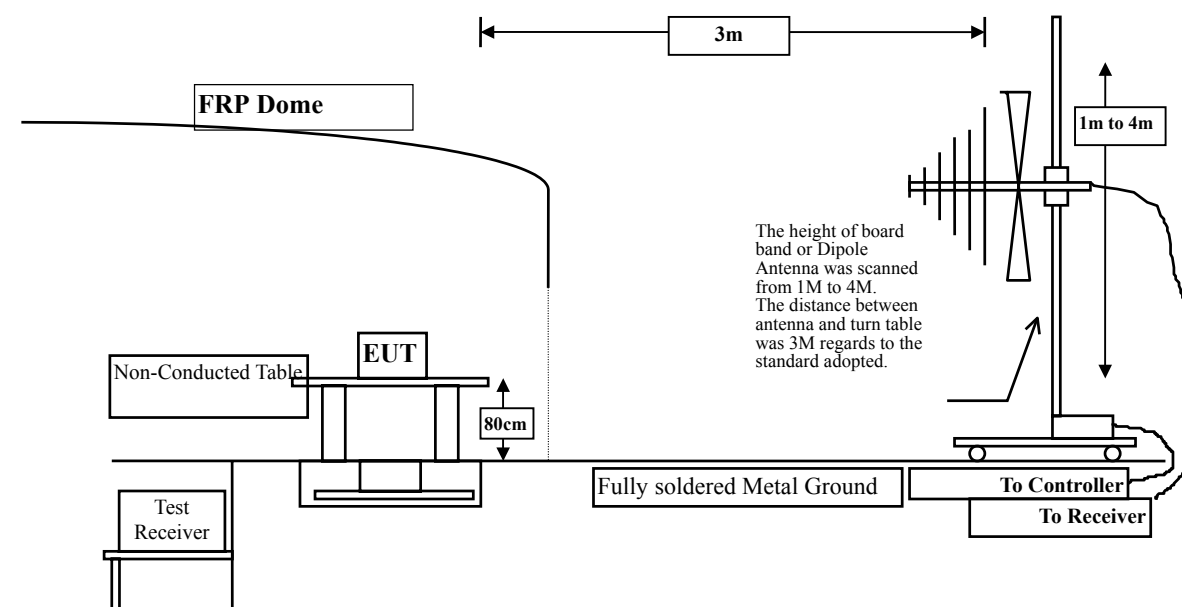

6.3. Limits

In any 100 kHz bandwidth outside the frequency band in which the spread spectrum intentional radiator is operating, the radio frequency power that is produced by the intentional radiator shall be at least 20 dB below that in the 100 kHz bandwidth within the band that contains the highest level of the desired power, based on either an RF conducted or a radiated measurement. Attenuation below the general limits specified in Section 15.209(a) is not required. In addition, radiated emissions which fall in the restricted bands, as defined in Section 15.205(a), must also comply with the radiated emission limits specified in Section 15.209(a) (see Section 15.205(c)).

6.4. Test Procedure

The EUT and its simulators are placed on a turn table which is 0.8 meter above ground. The turn table can rotate 360 degrees to determine the position of the maximum emission level. The EUT was positioned such that the distance from antenna to the EUT was 3 meters.

The antenna can move up and down between 1 meter and 4 meters to find out the maximum emission level.

Both horizontal and vertical polarization of the antenna are set on measurement. In order to find the maximum emission, all of the interface cables must be manipulated according to ANSI C63.4:1992 on radiated measurement.

The bandwidth below 1GHz setting on the field strength meter (R&S Test Receiver ESCS 30)is 120 kHz, above 1GHz are 1 MHz.

6.5. Test Result of Band Edge

Product : Tablet PC System
 Test Item : Band Edge Data
 Test Site : No.2 OATS
 Test Mode : Channel 1 (1Mbps)

RF Radiated Measurement:

| Channel No. | Frequency (MHz) | Required Limit (dBc) | Result |
|----------------|-----------------|----------------------|--------|
| 1 (Horizontal) | <2400 | >20 | Pass |
| 1 (Vertical) | <2400 | >20 | Pass |

Figure Channel 1: (Horizontal)

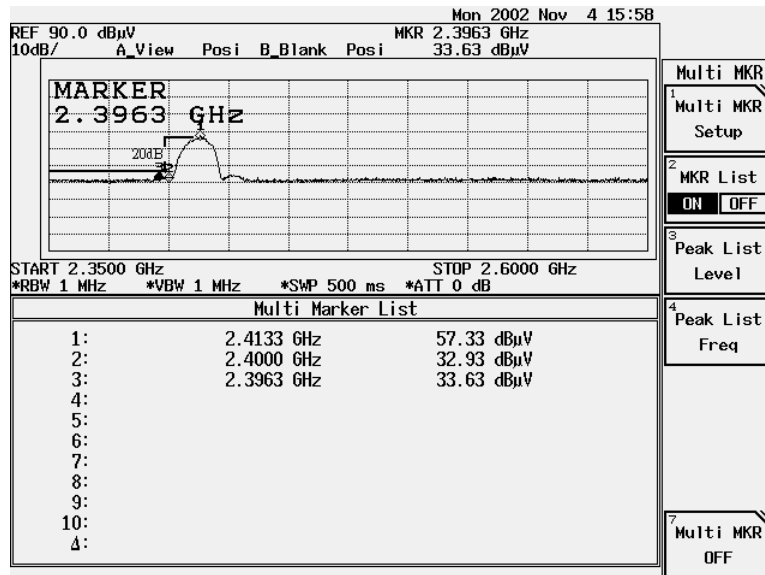
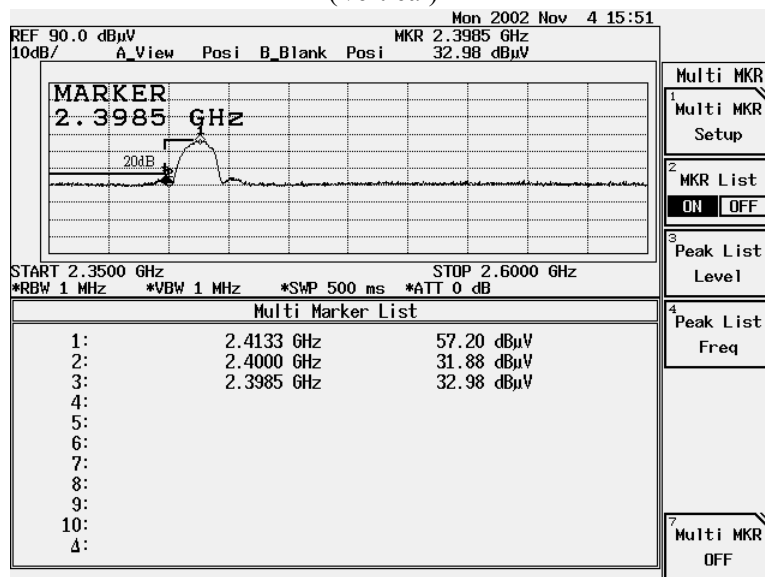

Figure Channel 1: (Vertical)



Product : Tablet PC System
 Test Item : Band Edge Data
 Test Site : No.2 OATS
 Test Mode : Channel 1 (11Mbps)

RF Radiated Measurement:

| Channel No. | Frequency (MHz) | Required Limit (dBc) | Result |
|----------------|-----------------|----------------------|--------|
| 1 (Horizontal) | <2400 | >20 | Pass |
| 1 (Vertical) | <2400 | >20 | Pass |

Figure Channel 1: (Horizontal)

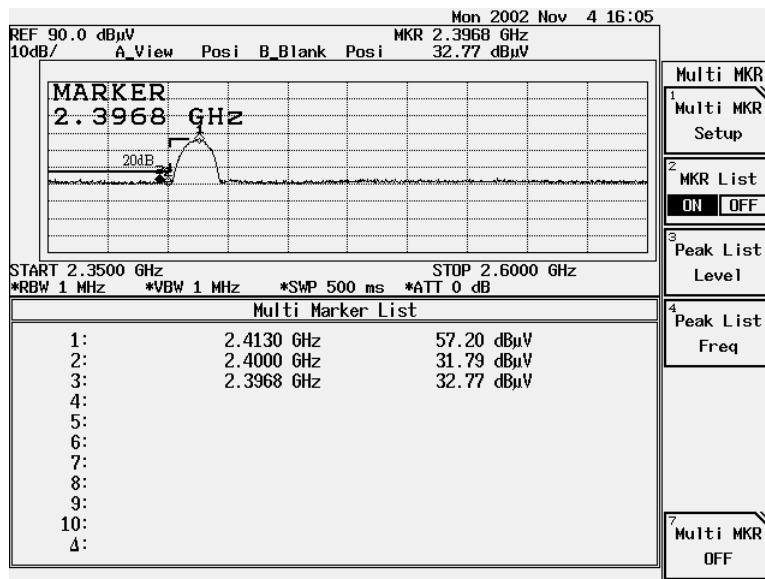
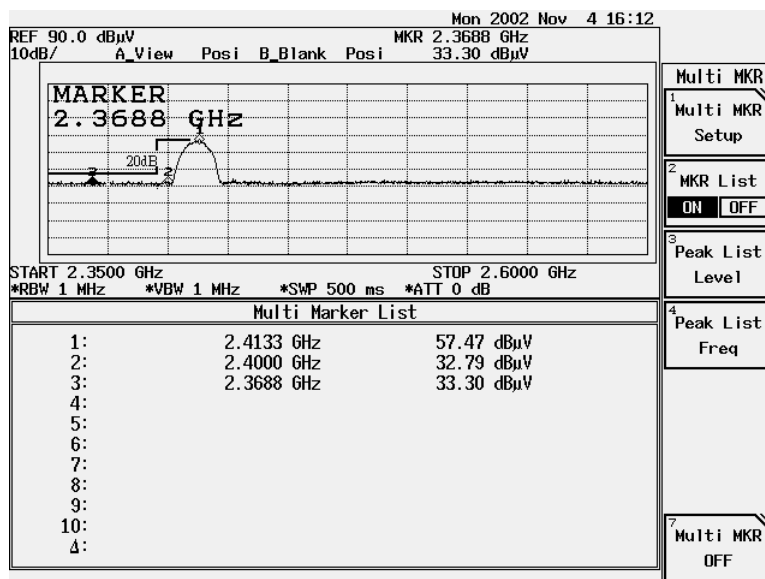

Figure Channel 1: (Vertical)



Product : Tablet PC System
 Test Item : Band Edge Data
 Test Site : No.2 OATS
 Test Mode : Channel 11 (1Mbps)

RF Radiated Measurement:

| Channel No. | Frequency (MHz) | Reading Level (dBuV) | Emission Level (dBuV/m) | Peak Limit (dBuV/m) | Average Limit (dBuV/m) | Result |
|----------------|-----------------|----------------------|-------------------------|---------------------|------------------------|--------|
| 11(Horizontal) | 2495.8 | 33.43 | 46.32 | 74 | 54 | Pass |
| 11(Vertical) | 2488.5 | 33.04 | 45.81 | 74 | 54 | Pass |

Figure Channel 11: (Horizontal)

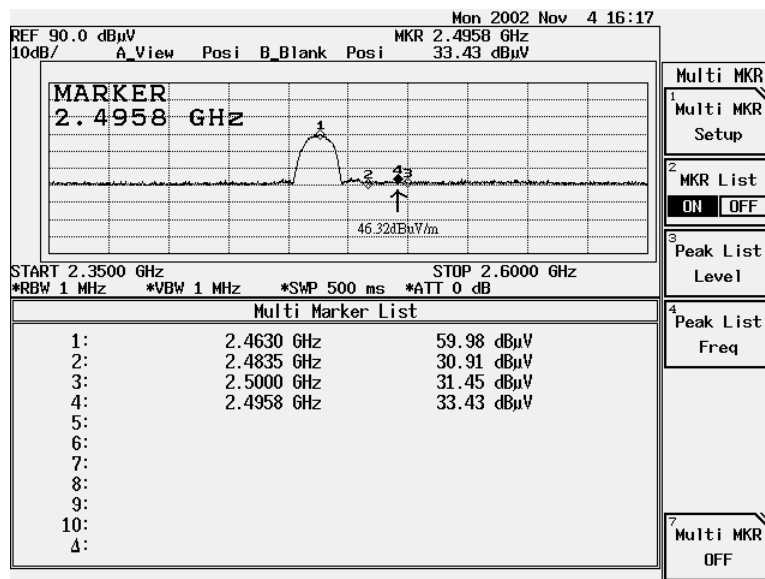
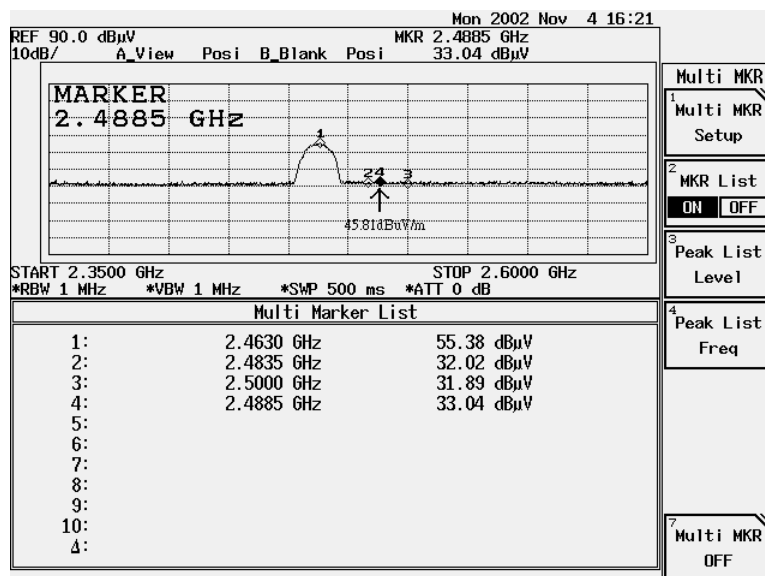

Figure Channel 11: (Vertical)



Note: The average measurement was not performed when the peak measured data under the limit of average detection. If the readings given are average, peak measurement should also be supplied.

Product : Tablet PC System
 Test Item : Band Edge Data
 Test Site : No.2 OATS
 Test Mode : Channel 11 (11Mbps)

RF Radiated Measurement:

| Channel No. | Frequency (MHz) | Reading Level (dBuV) | Emission Level (dBuV/m) | Peak Limit (dBuV/m) | Average Limit (dBuV/m) | Result |
|----------------|-----------------|----------------------|-------------------------|---------------------|------------------------|--------|
| 11(Horizontal) | 2487.50 | 33.74 | 46.51 | 74 | 54 | Pass |
| 11(Vertical) | 2494.50 | 33.38 | 44.16 | 74 | 54 | Pass |

Figure Channel 11:

(Horizontal)

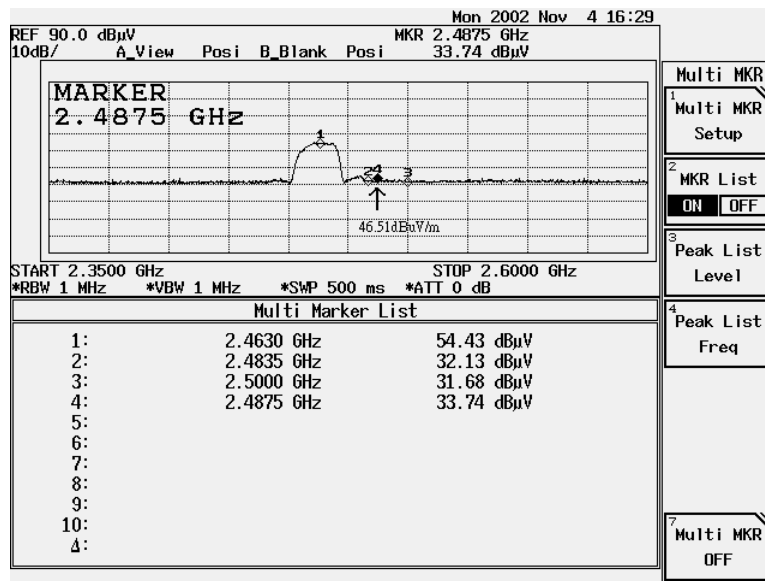
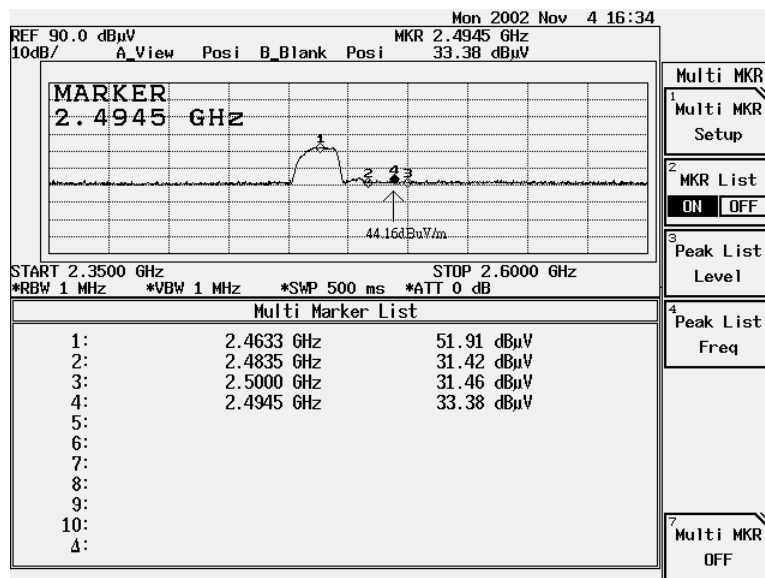

Figure Channel 11:

(Vertical)



Note: The average measurement was not performed when the peak measured data under the limit of average detection. If the readings given are average, peak measurement should also be supplied.

7. Occupied Bandwidth

7.1. Test Equipment

The following test equipments are used during the radiated emission tests:

| Equipment | Manufacturer | Model No./Serial No. | Last Cal. |
|---------------------|--------------|----------------------|-----------|
| X Spectrum Analyzer | Advantest | R3272 / 72421194 | May, 2002 |

Note: 1. All equipment upon which need to calibrated are with calibration period of 1 year.
 2. Mark "X" test instruments are used to measure the final test results.

7.2. Test Setup

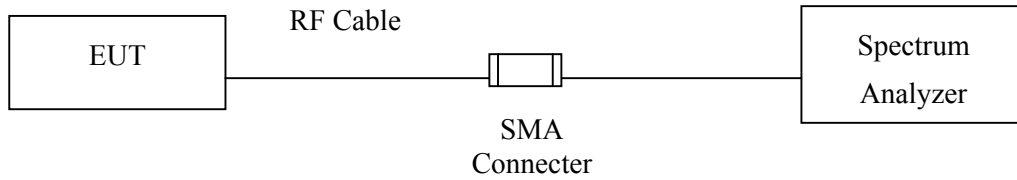

7.3. Limits

The minimum bandwidth shall be at least 500kHz.

7.4. Test Result of Occupied Bandwidth

Product : Tablet PC System
 Test Item : Occupied Bandwidth Data
 Test Site : No.2 OATS
 Test Mode : Channel 1

| Channel No. | Frequency (MHz) | Measurement Level (kHz) | Required Limit (kHz) | Result |
|-------------|-----------------|-------------------------|----------------------|--------|
| 1 (1Mbps) | 2412.60 | 10800 | >500 | Pass |
| 1 (11Mbps) | 2412.60 | 10400 | >500 | Pass |

Figure Channel 1: 1Mbps

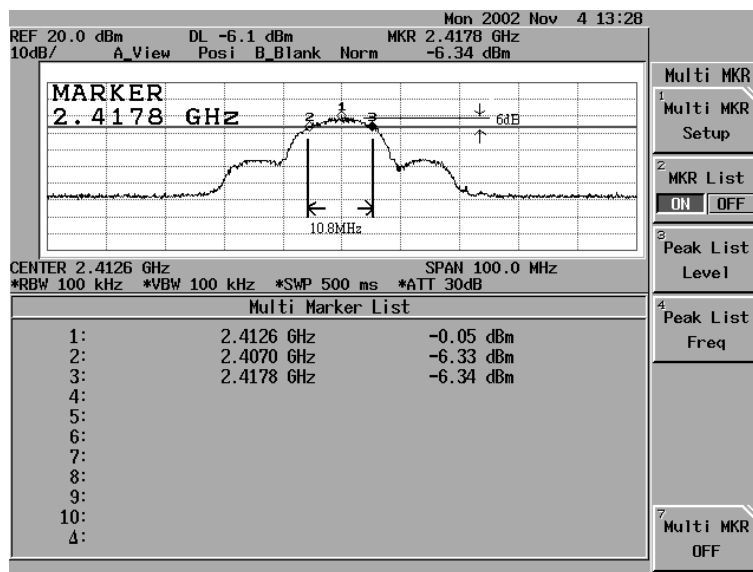
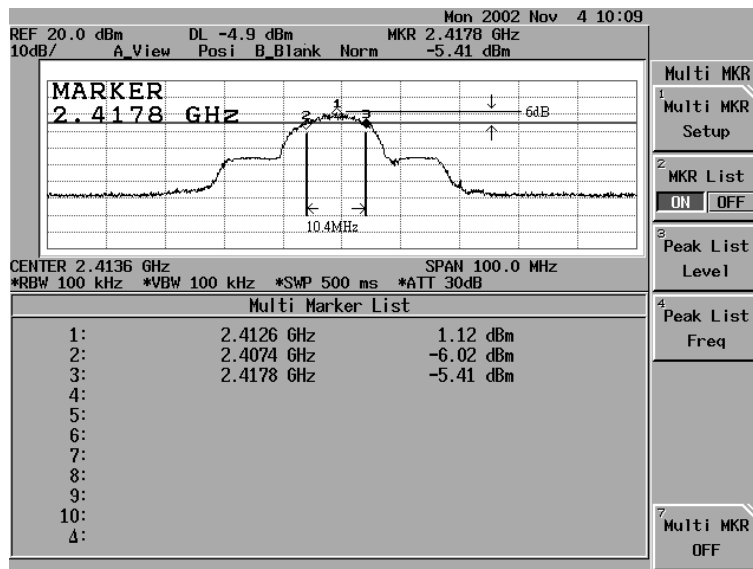

Figure Channel 1: 11Mbps



Product : Tablet PC System
 Test Item : Occupied Bandwidth Data
 Test Site : No.2 OATS
 Test Mode : Channel 6

| Channel No. | Frequency (MHz) | Measurement Level (kHz) | Required Limit (kHz) | Result |
|-------------|-----------------|-------------------------|----------------------|--------|
| 6 (1Mbps) | 2438.00 | 11700 | >500 | Pass |
| 6 (11Mbps) | 2437.20 | 11300 | >500 | Pass |

Figure Channel 6:

1Mbps

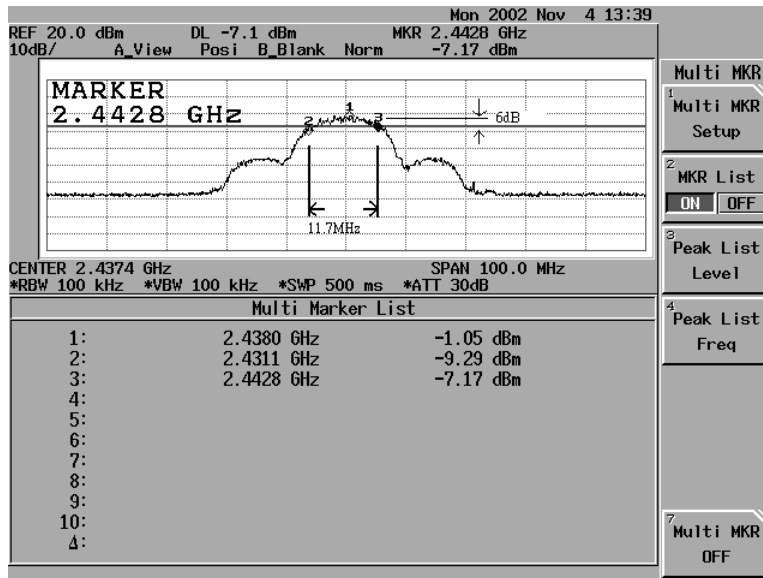
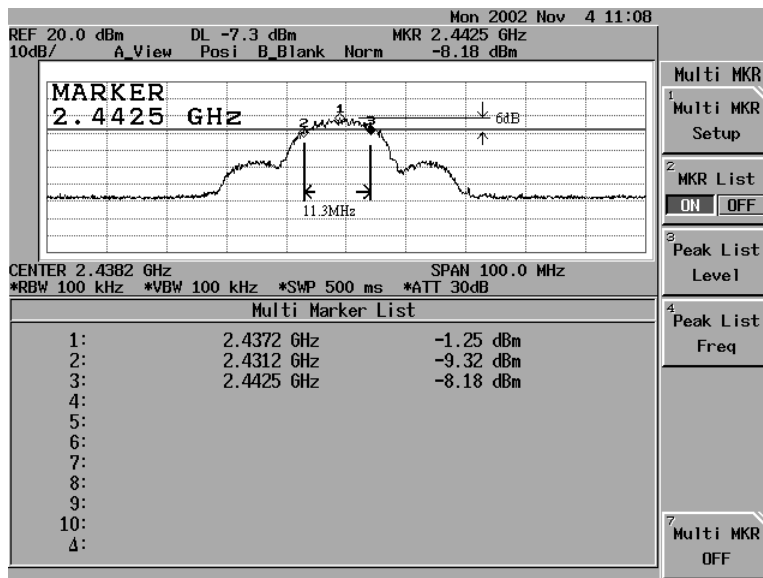

Figure Channel 6:

11Mbps



Product : Tablet PC System
 Test Item : Occupied Bandwidth Data
 Test Site : No.2 OATS
 Test Mode : Channel 11

| Channel No. | Frequency (MHz) | Measurement Level (kHz) | Required Limit (kHz) | Result |
|-------------|-----------------|-------------------------|----------------------|--------|
| 11 (1Mbps) | 2462.10 | 9500 | >500 | Pass |
| 11 (11Mbps) | 2462.10 | 9500 | >500 | Pass |

Figure Channel 11:

1Mbps

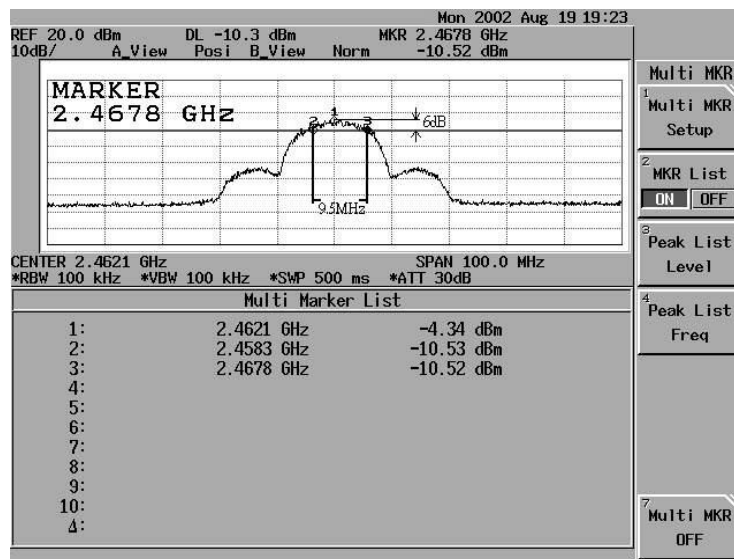
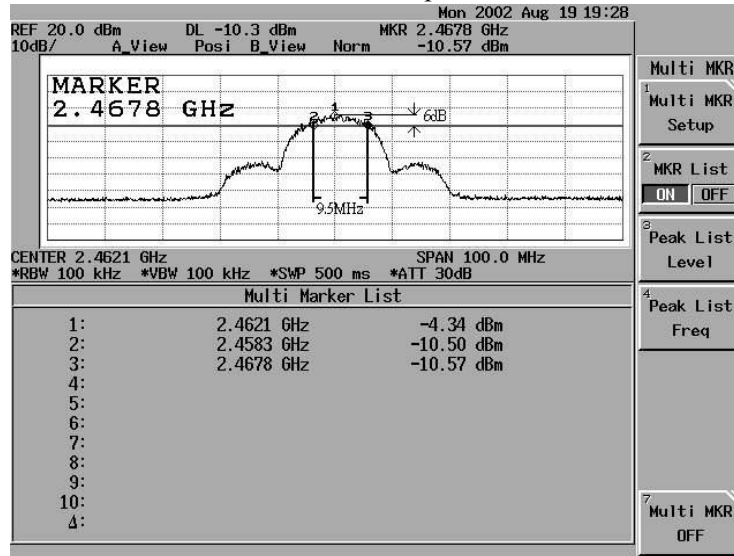

Figure Channel 11:

11Mbps



8. Power Density

8.1. Test Equipment

The following test equipments are used during the radiated emission tests:

| | Equipment | Manufacturer | Model No./Serial No. | Last Cal. |
|---|-------------------|--------------|----------------------|-----------|
| X | Spectrum Analyzer | Advantest | R3272 / 72421194 | May, 2002 |

Note: 1. All equipment upon which need to calibrated are with calibration period of 1 year.
 2. Mark "X" test instruments are used to measure the final test results.

8.2. Test Setup

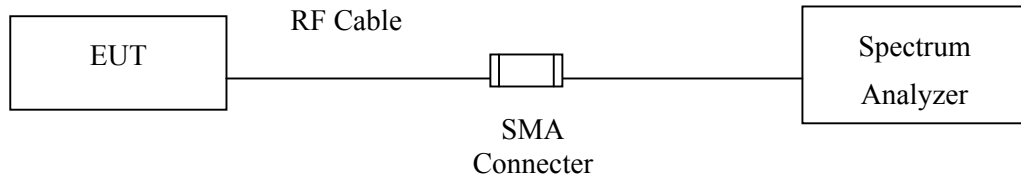

8.3. Limits

The transmitted power density averaged over any 1 second interval shall not be greater +8dBm in any 3kHz bandwidth.

8.4. Test Result of Power Density

Product : Tablet PC System
 Test Item : Power Density Data
 Test Site : No.2 OATS
 Test Mode : Channel 1

| Channel No. | Frequency (MHz) | Measure Level (dBm) | Limit (dBm) | Result |
|-------------|-----------------|---------------------|-------------|--------|
| 1 (1Mbps) | 2412.449 | -12.80 | < 8dBm | Pass |
| 1 (11Mbps) | 2412.449 | -12.51 | < 8dBm | Pass |

Figure Channel 1:

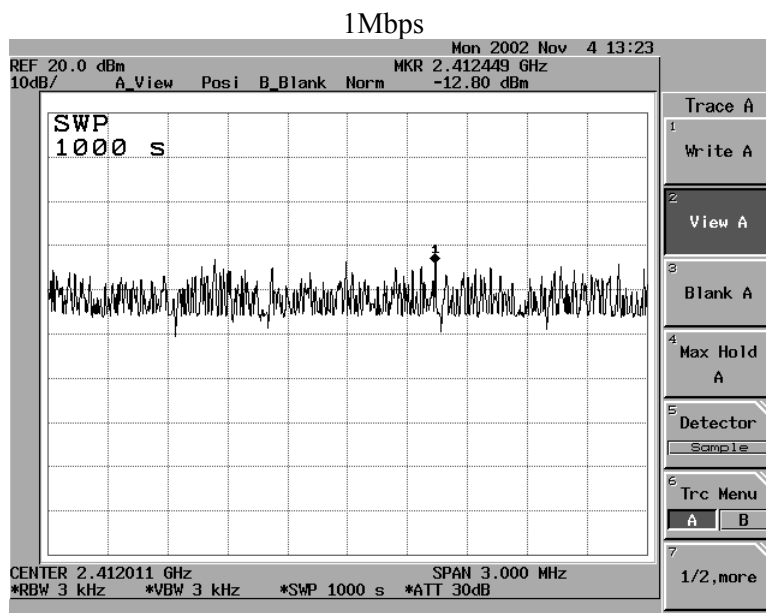
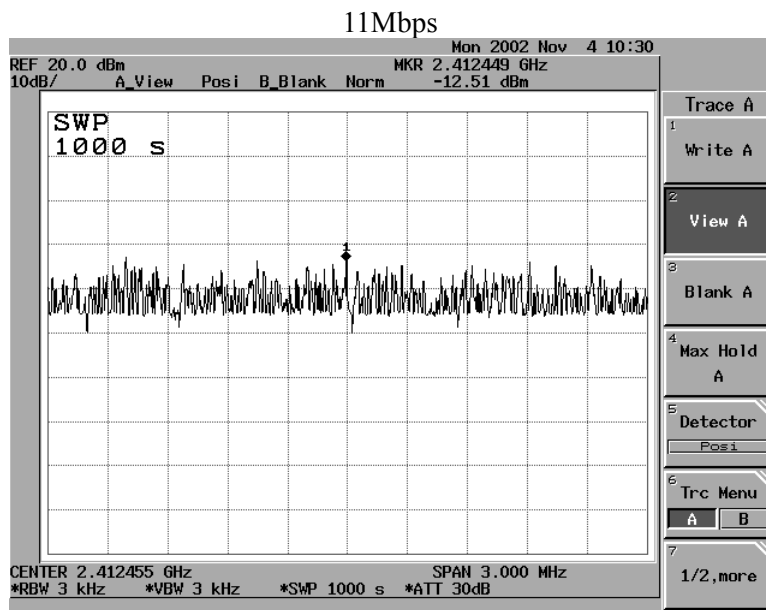

Figure Channel 1:



Product : Tablet PC System
 Test Item : Power Density Data
 Test Site : No.2 OATS
 Test Mode : Channel 6

| Channel No. | Frequency (MHz) | Measurement Level (dBm) | Required Limit (dBm) | Result |
|-------------|-----------------|-------------------------|----------------------|--------|
| 6 (1Mbps) | 2436.133 | -14.83 | < 8dBm | Pass |
| 6 (11Mbps) | 2436.132 | -14.74 | < 8dBm | Pass |

Figure Channel 6:

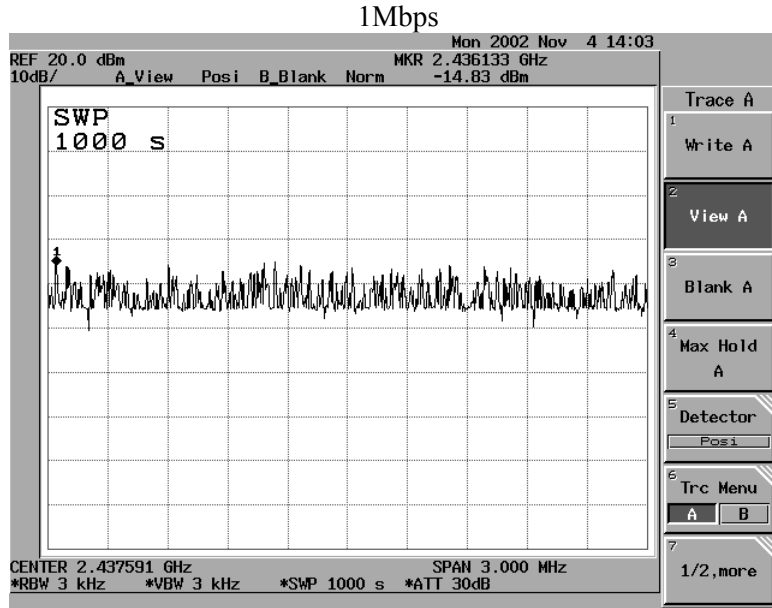
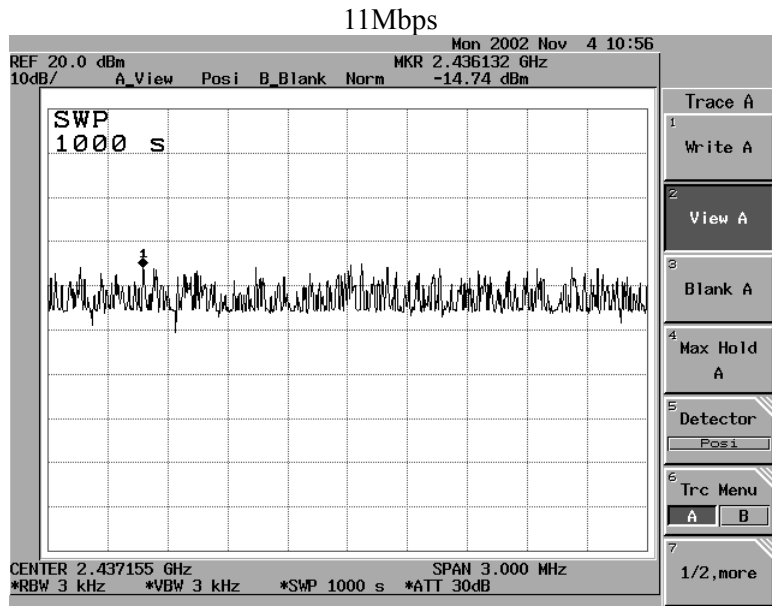

Figure Channel 6:



Product : Tablet PC System
 Test Item : Density Data
 Test Site : No.2 OATS
 Test Mode : Channel 11

| Channel No. | Frequency (MHz) | Measurement Level (dBm) | Required Limit (dBm) | Result |
|-------------|-----------------|-------------------------|----------------------|--------|
| 11 (1Mbps) | 2461.132 | -15.76 | < 8dBm | Pass |
| 11 (11Mbps) | 2461.132 | -15.70 | < 8dBm | Pass |

Figure Channel 11:

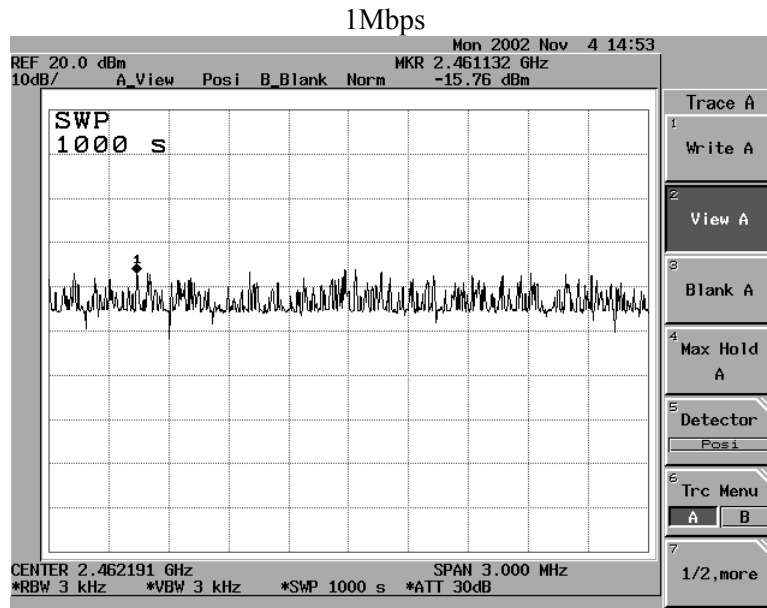
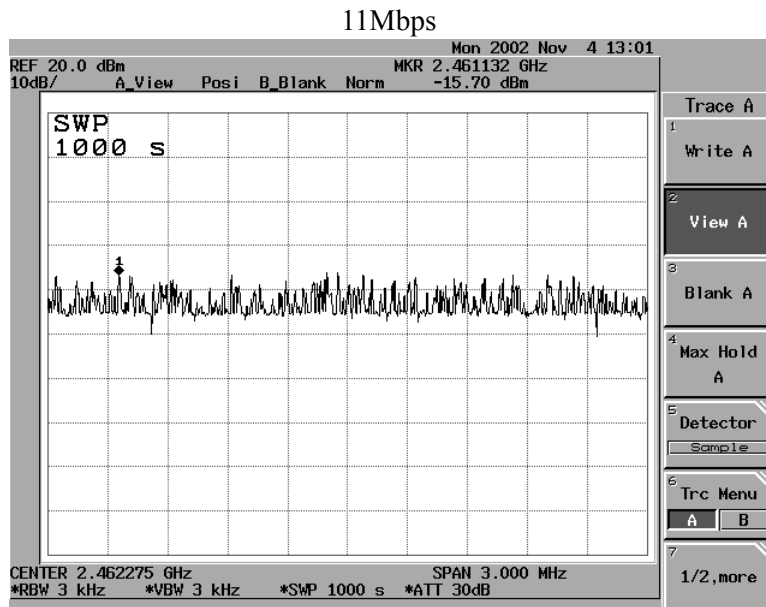

Figure Channel 11:



9. EMI Reduction Method During Compliance Testing

No modification was made during testing.

Attachment 1: EUT Test Photographs

Attachment 1: EUT Test Setup Photographs

Front View of Conducted Test (Mode 1)



Back View of Conducted Test (Mode 1)

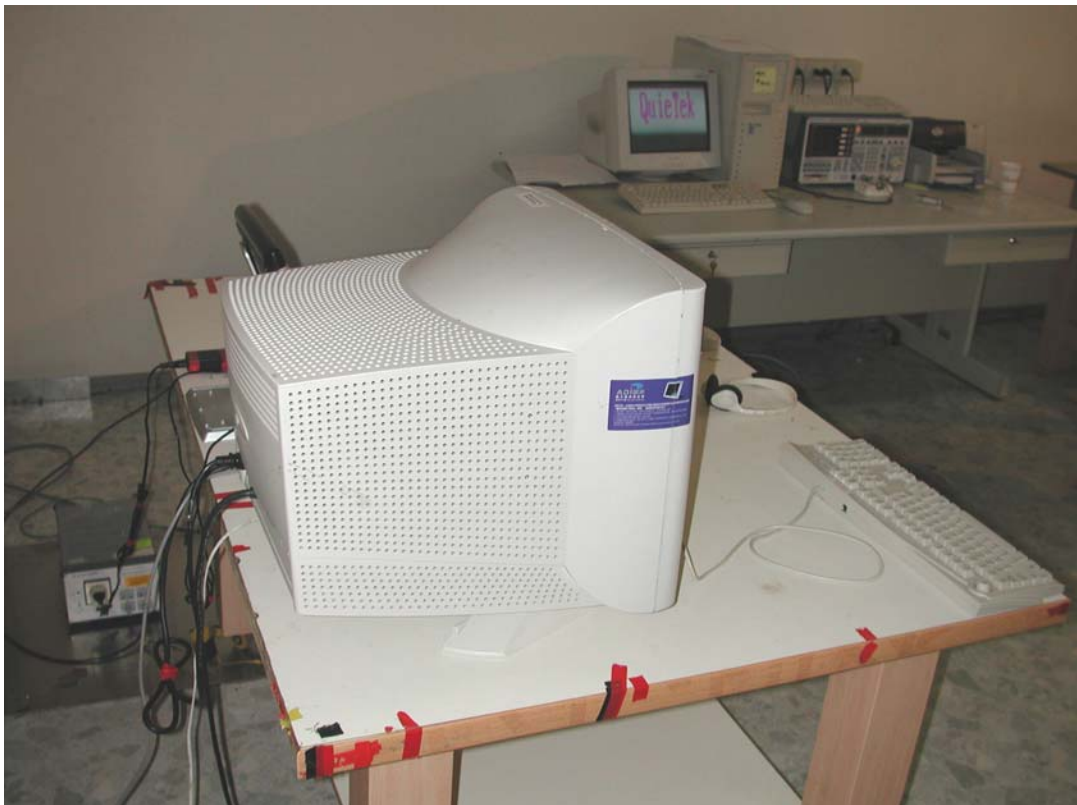

Front View of Radiated Test

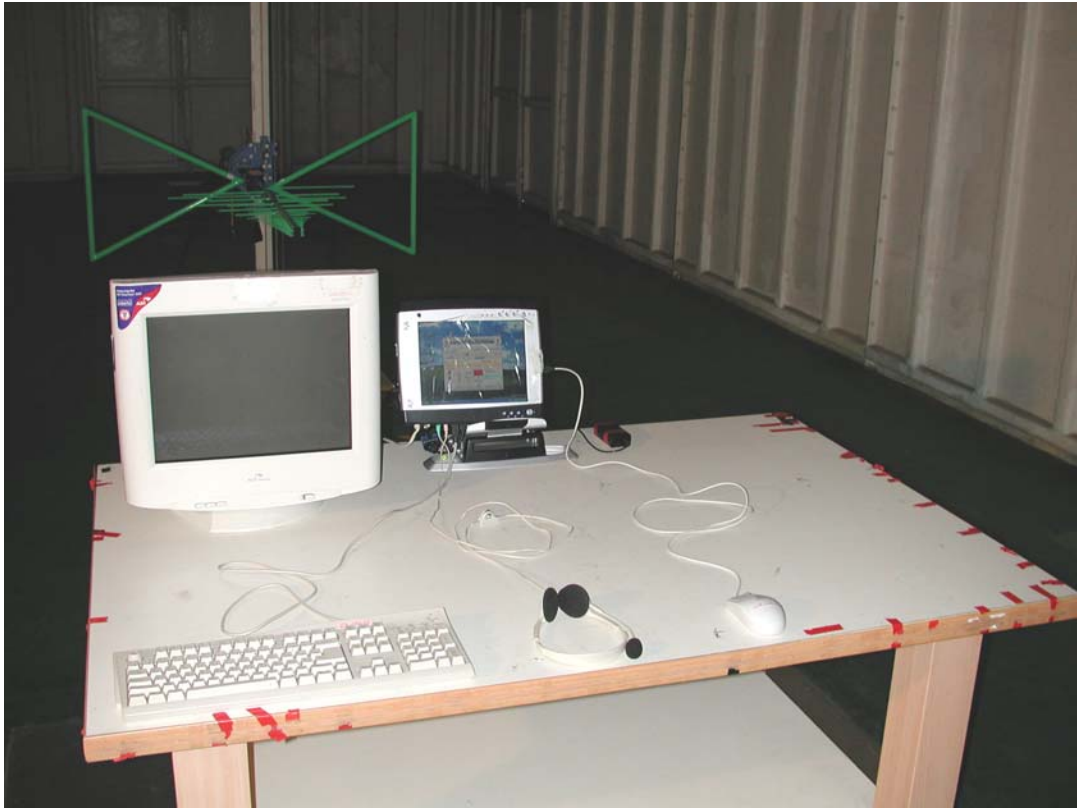

Back View of Radiated Test



Front View of High Frequency Radiated Test



Attachment 2: EUT Detailed Photographs

Attachment 2 : EUT Detailed Photographs

(1) EUT Photo



(2) EUT Photo



(3) EUT Photo



(4) EUT Photo



(5) EUT Photo



(6) EUT Photo



(7) EUT Photo



(8) EUT Photo

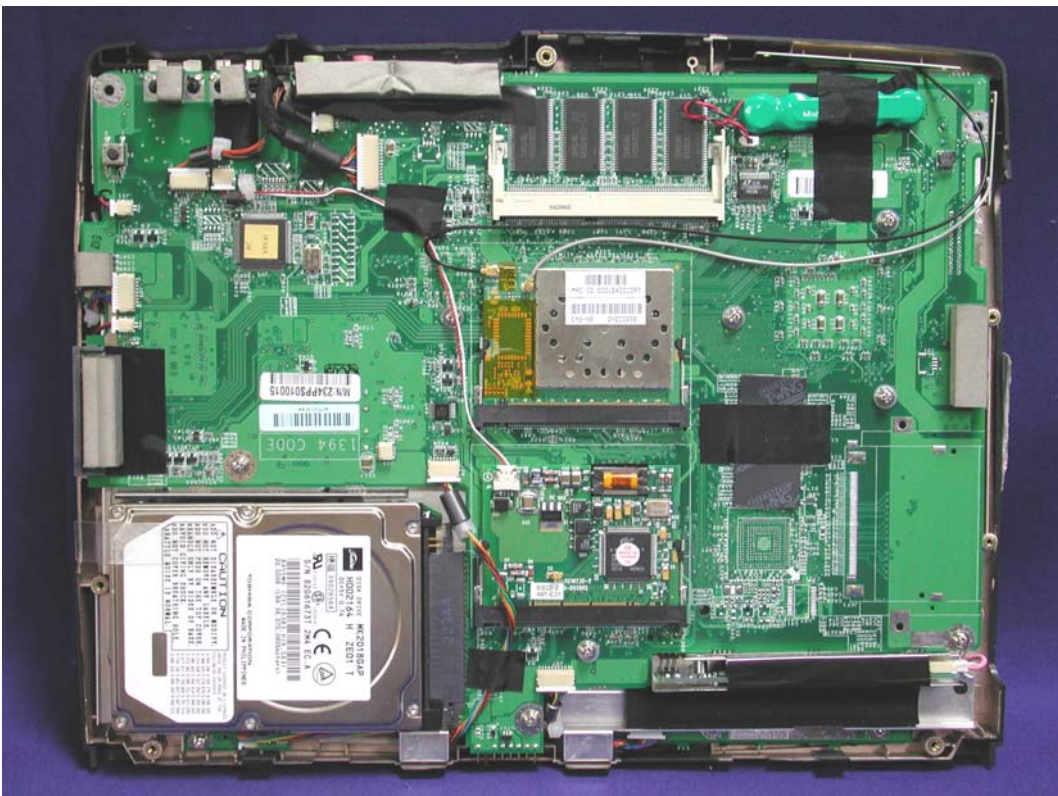

(9) EUT Photo



(10) EUT Photo

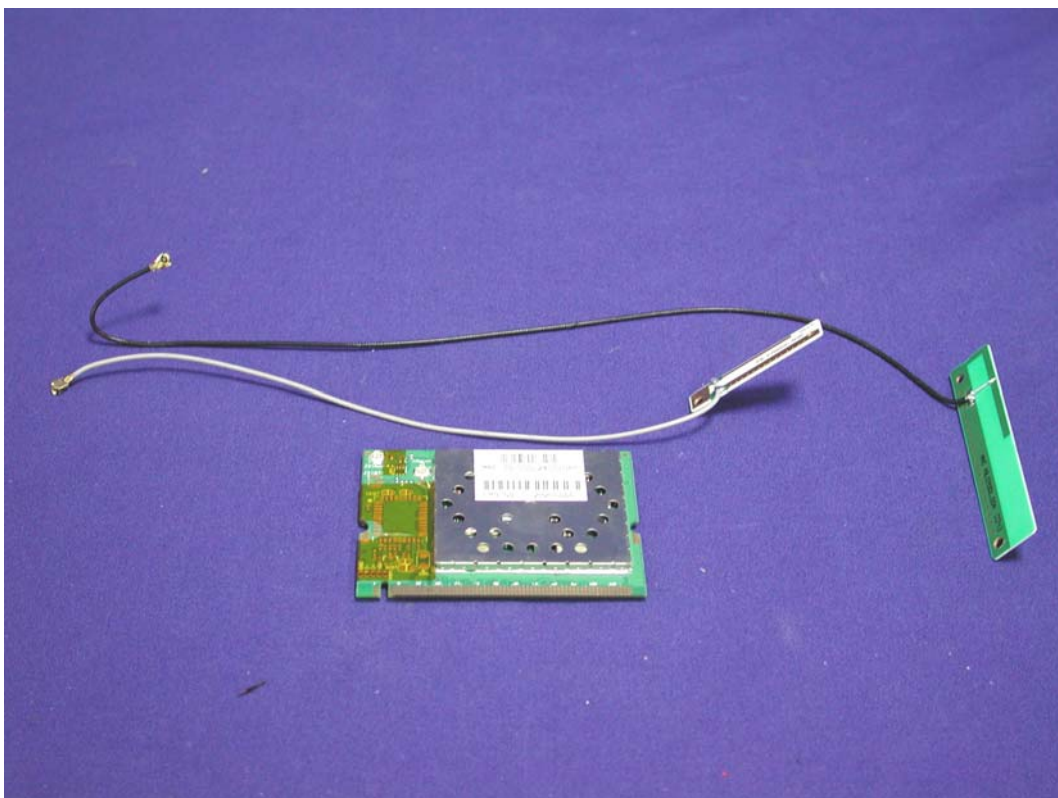

(11) EUT Photo

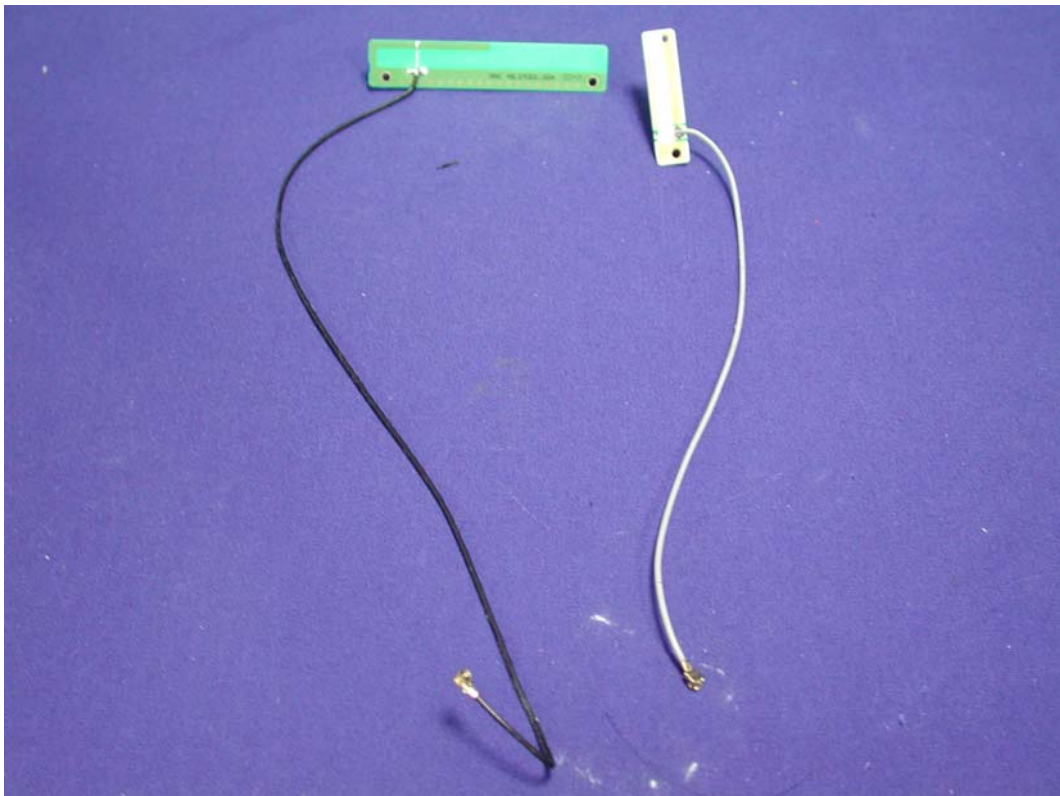

(12) EUT Photo

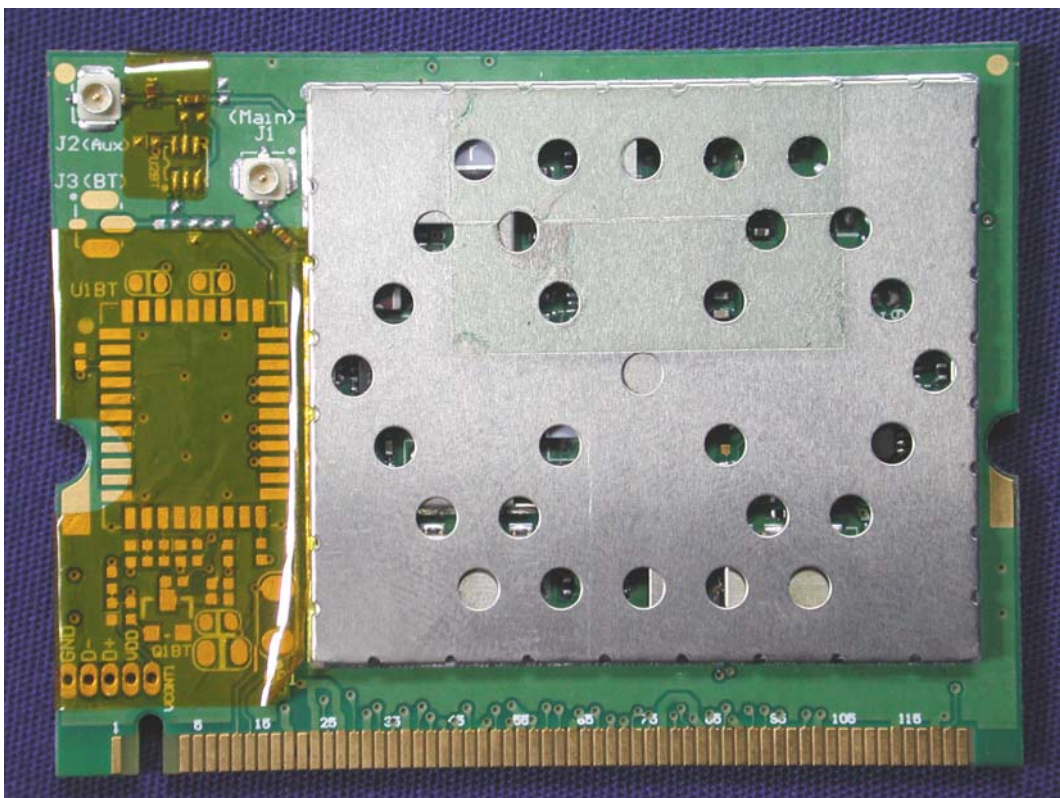

(13) EUT Photo

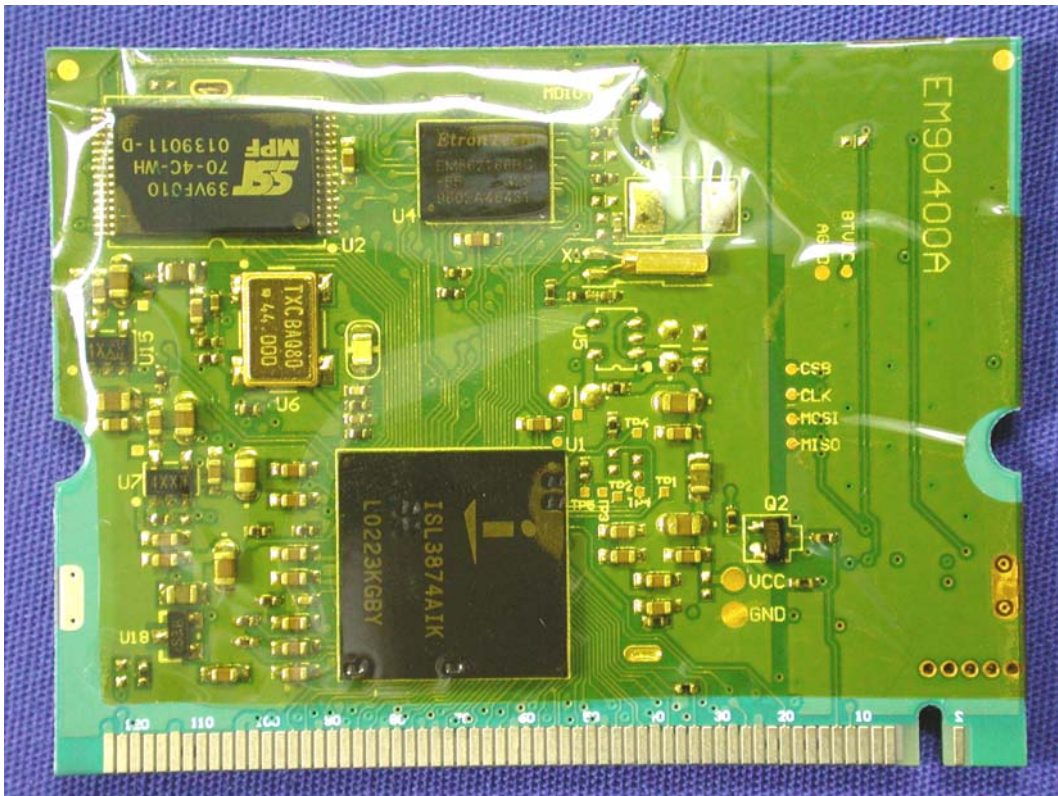

(14) EUT Photo

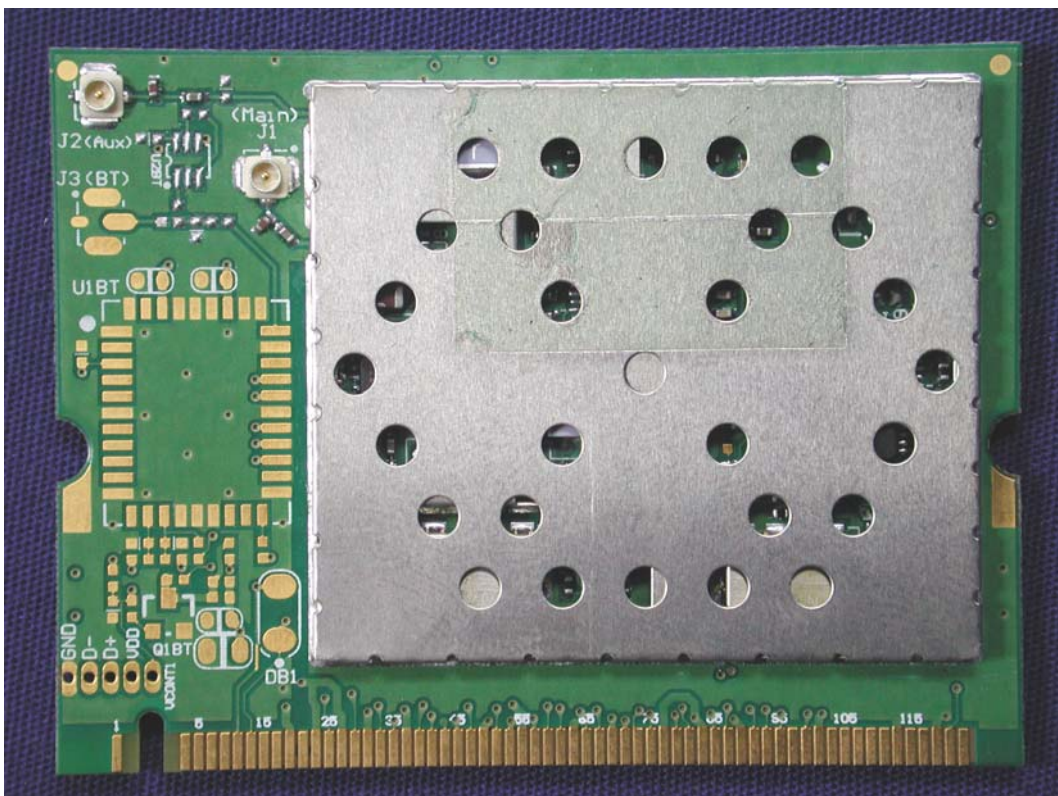

(17) EUT Photo

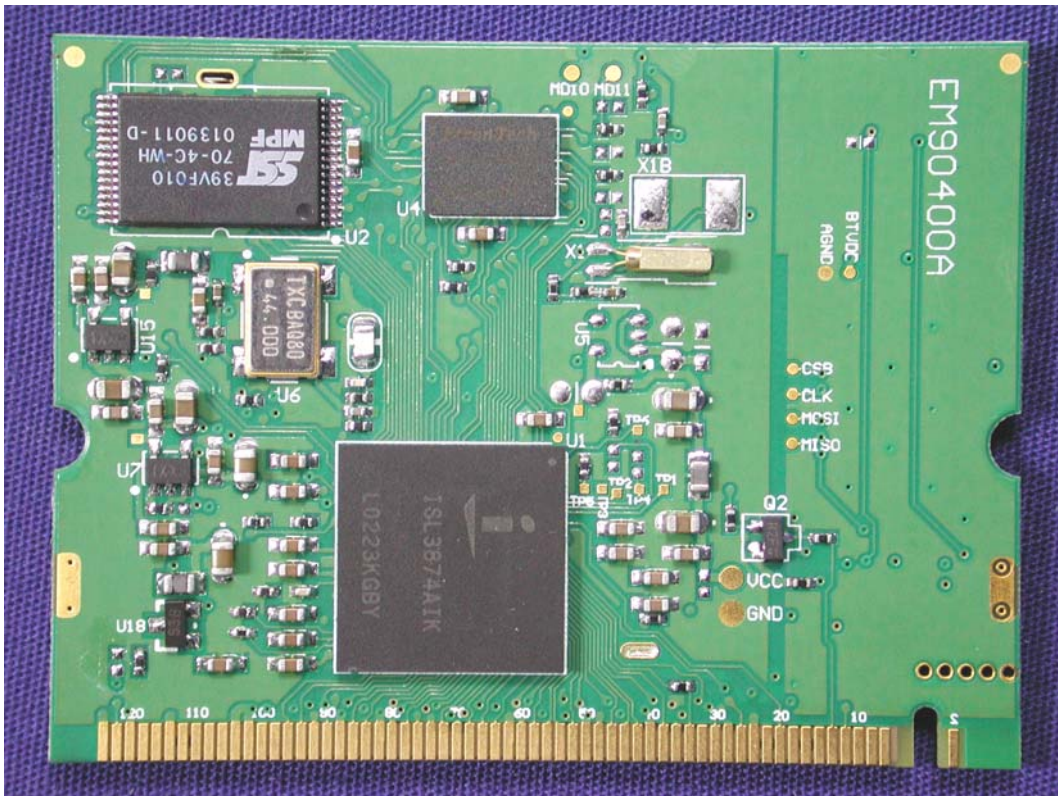

(18) EUT Photo



(19) EUT Photo

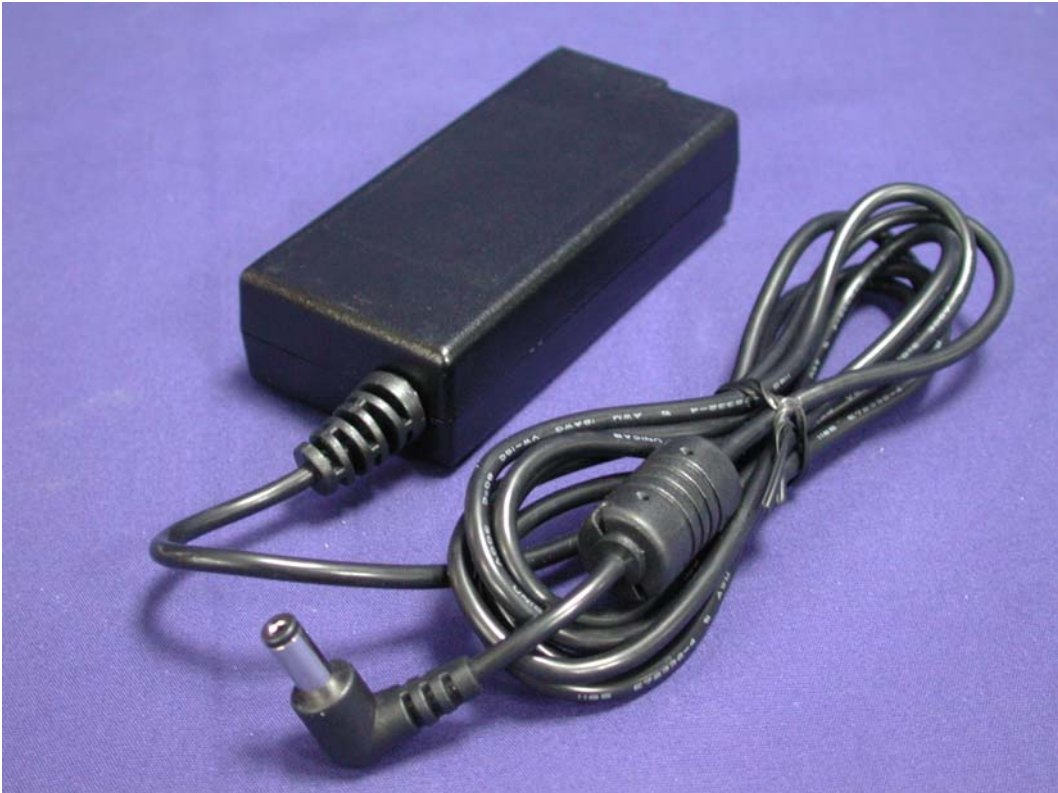

(20) EUT Photo



(21) EUT Photo

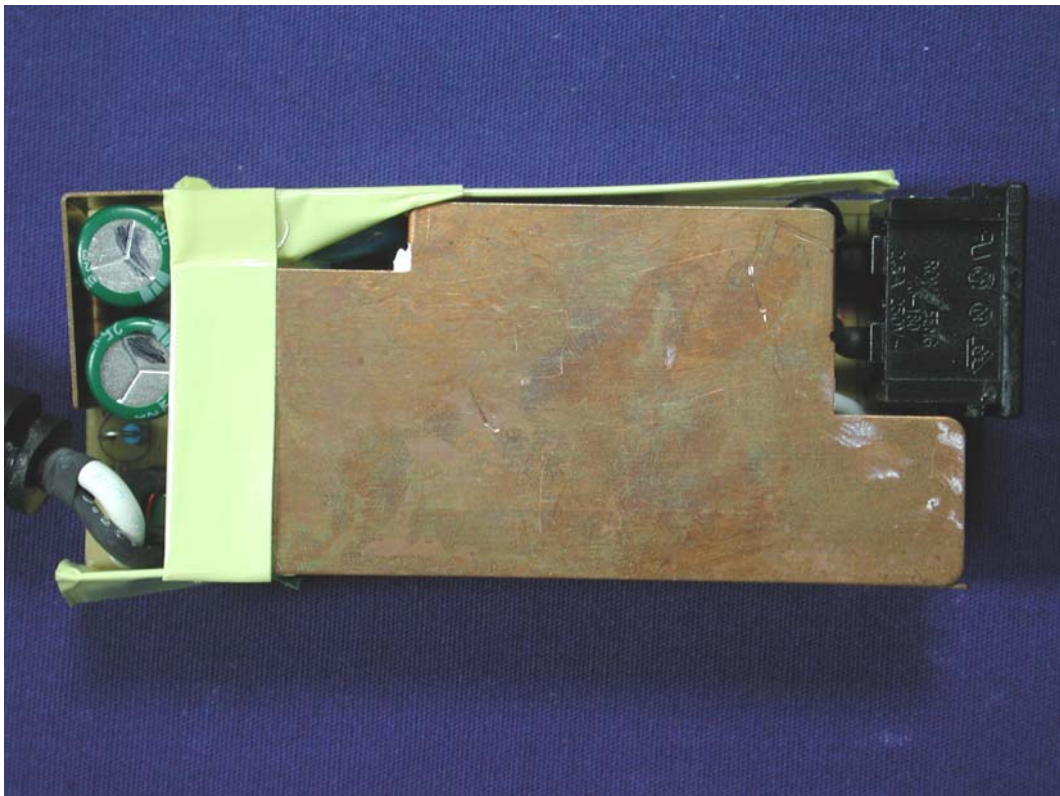

(22) EUT Photo



(23) EUT Photo

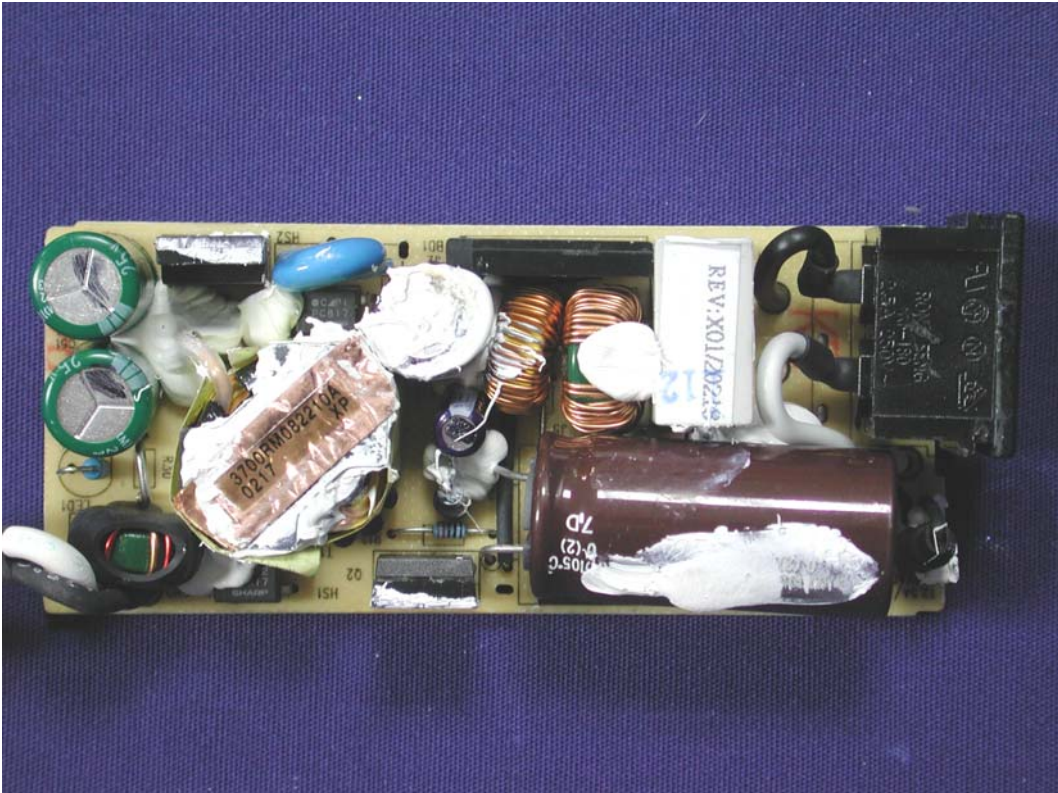

(24) EUT Photo

