



Digital Living. Simplified.SM

Quick Start Guide

Models: ROS2000 and ROS1000

Read the **Safety and Notices** section on page 14 for important safety and regulatory information.



Contents

Setup Hardware.....	4
Standard DVD / Satellite Composite vDMA Setup.....	8
High Definition Component vDMA Setup	9
High Definition HDMI vDMA Setup	10
RHC LED Description	11
vDMA LED Description	12
Universal Remote Description	13
Safety and Notices	14
Warranty.....	Back

Actual product may vary from depictions in this guide.

1. Before you begin, make sure you have following equipment.

- Working high-speed Internet connection
- Television
- Activation code you received from your ROS service provider.
- At least the following ROS hardware:



ROS Home Center



ROS Home Center AC Adapter



ROS Set Top Box



ROS Set Top Box AC Adapter



Remote (with batteries)



Ethernet Cable



Component Cables



Component Dongle

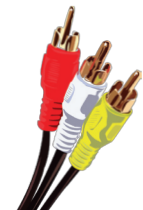

Composite Cables

IMPORTANT! If you have a modem - router combination, you need to turn on bridge mode.

What is a router?

A router manages and connects your home networked

computers and devices via Wi-Fi or Ethernet.

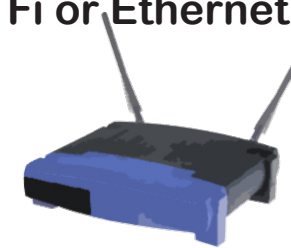

What is a modem?

A modem connects your home to the Internet services provided by your

Internet Service Provider (ISP).

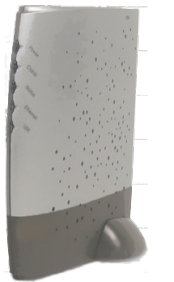

Specifications

RHC Supply voltage:	115/230 V.C.A. ±10%
RHC Frequency:	50/60 Hz
RHC Current consumption:	3.33 A
vDMA Supply voltage:	115/230 V.C.A. ±10%
vDMA Frequency:	50/60 Hz
vDMA Current consumption:	2.1 A

SETUP HARDWARE

2. Place for your ROS Home Center (ROS2000) next to your Internet modem (preferred location). Unplug power from your modem.

Install your equipment in a clean, indoor environment where the temperature is between 32 and 104 degrees Fahrenheit (no attics or garages).

3. Connect your ROS Home Center with your modem using the provided blue Ethernet cable and then supply power to your modem.



4. Plug your ROS Home Center into an electric outlet.

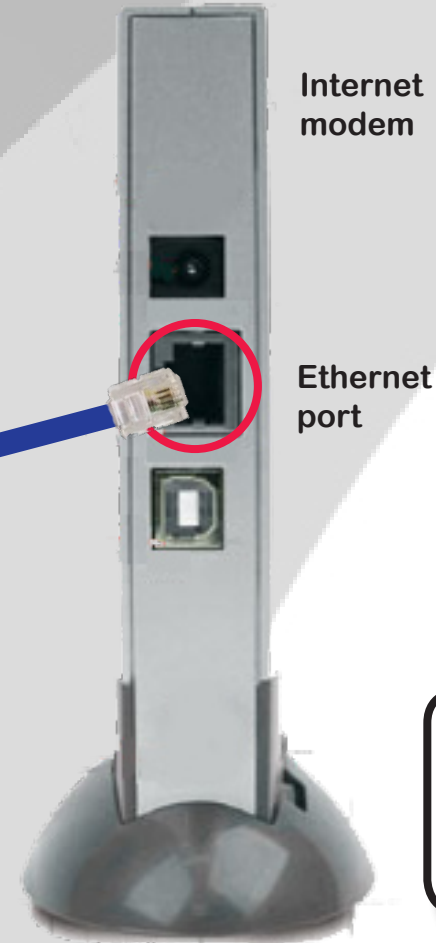

5. Using another Ethernet cable, connect your PC to the RHC.

6. Set up your vDMA (ROS1000).

IMPORTANT! Power the ROS Home Center (ROS2000) only with the included AC adapter: Hipro model HP-02040D43 LF, 12VDC operating at 3.33 amps.

For Standard DVD or Cable / Satellite Boxes Composite Cables

If your television or devices support only standard definition, complete the following steps to connect the ROS Set Top Box to your television using composite A/V cables. If your television supports high definition, see the following pages for installation instructions.

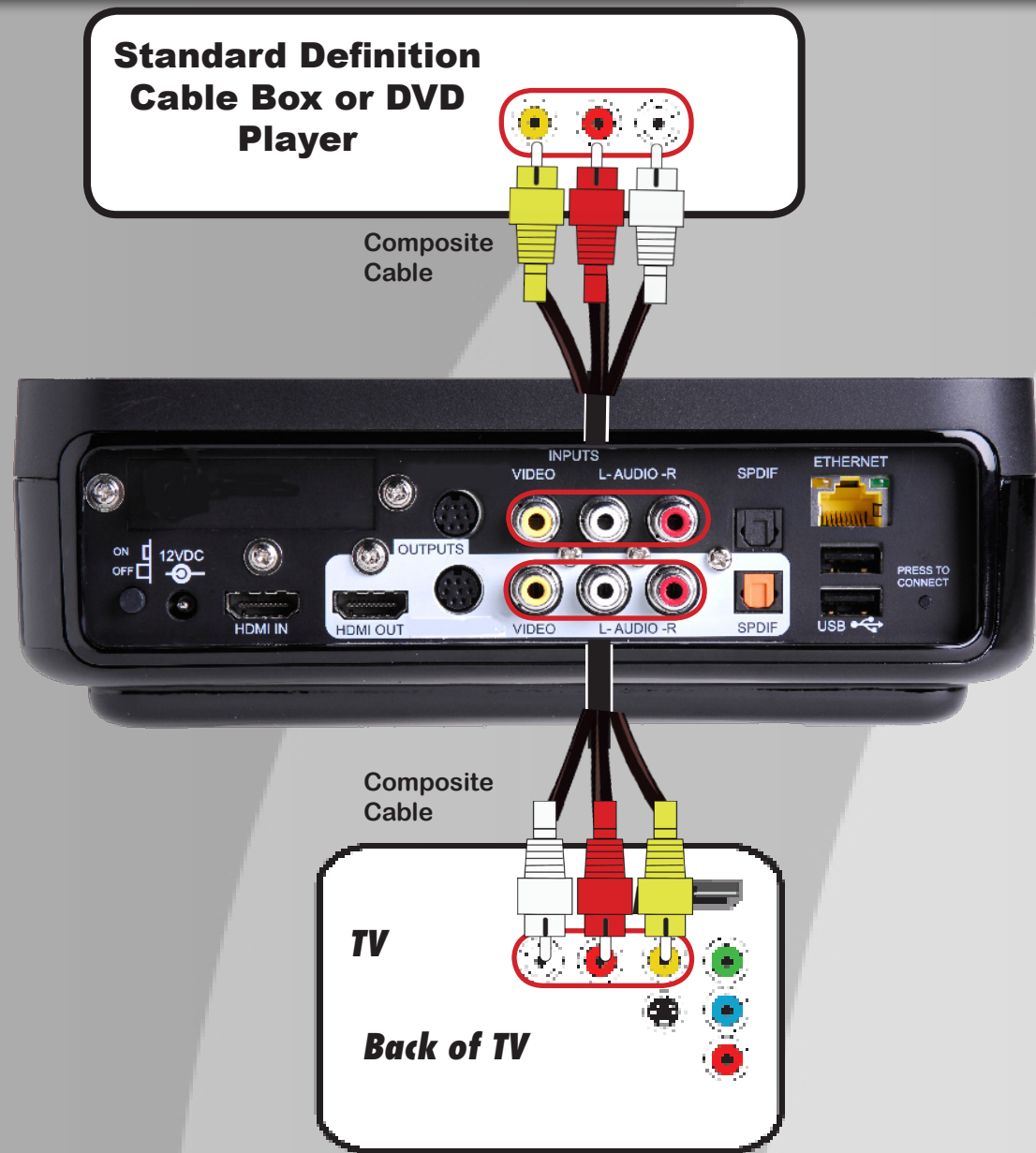

For High Definition DVD and Cable / Satellite Boxes Component Cables

Connect your high definition devices to the ROS Set Top Box and the ROS Video Set Top Box to your TV using the supplied component video dongles and cables for video. Use either composite or S/PDIF (optical) cables for audio (A or B).

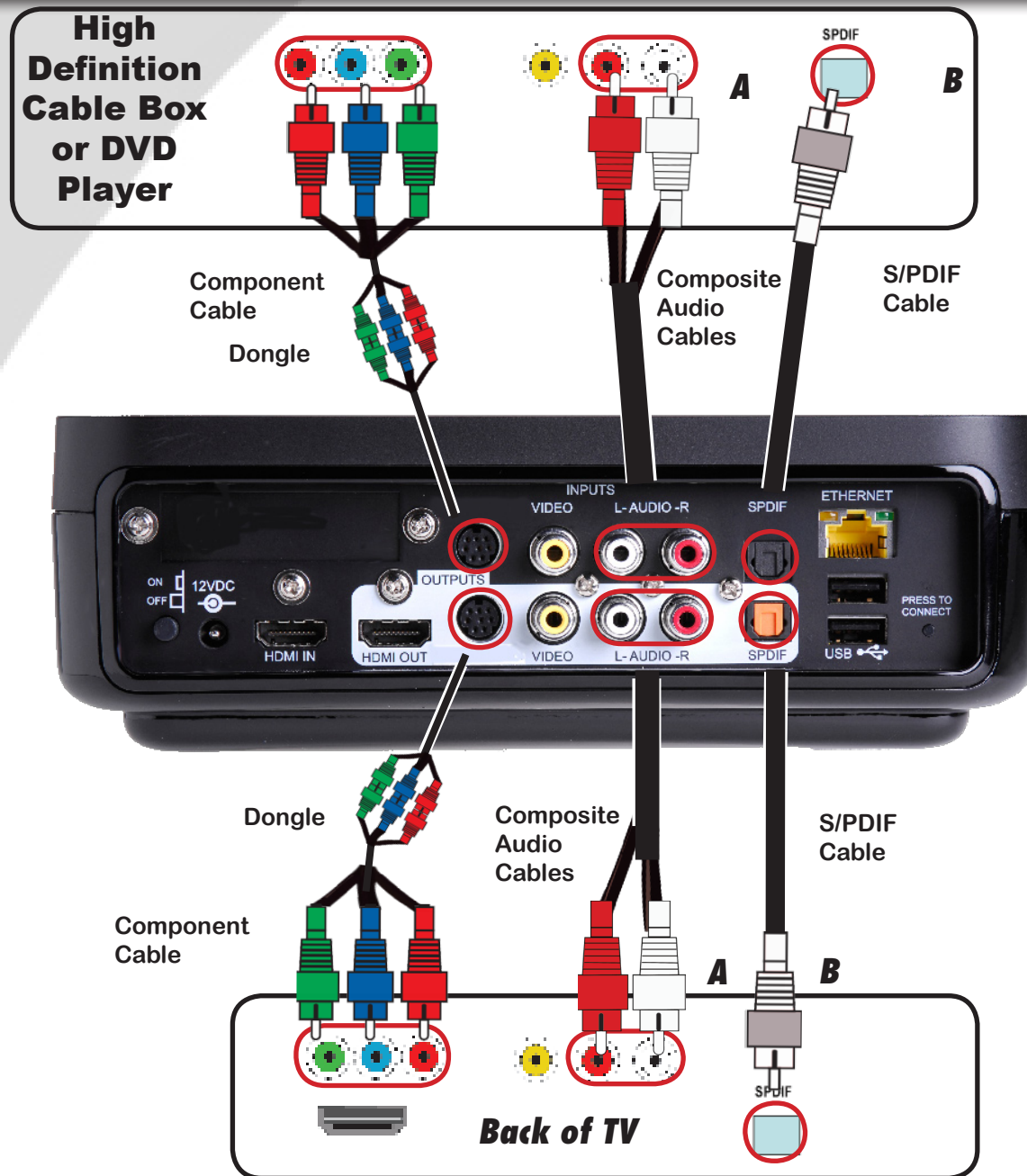

Connect your high definition devices to the ROS Set Top Box, and then the ROS Set Top Box to your TV using HDMI cables.

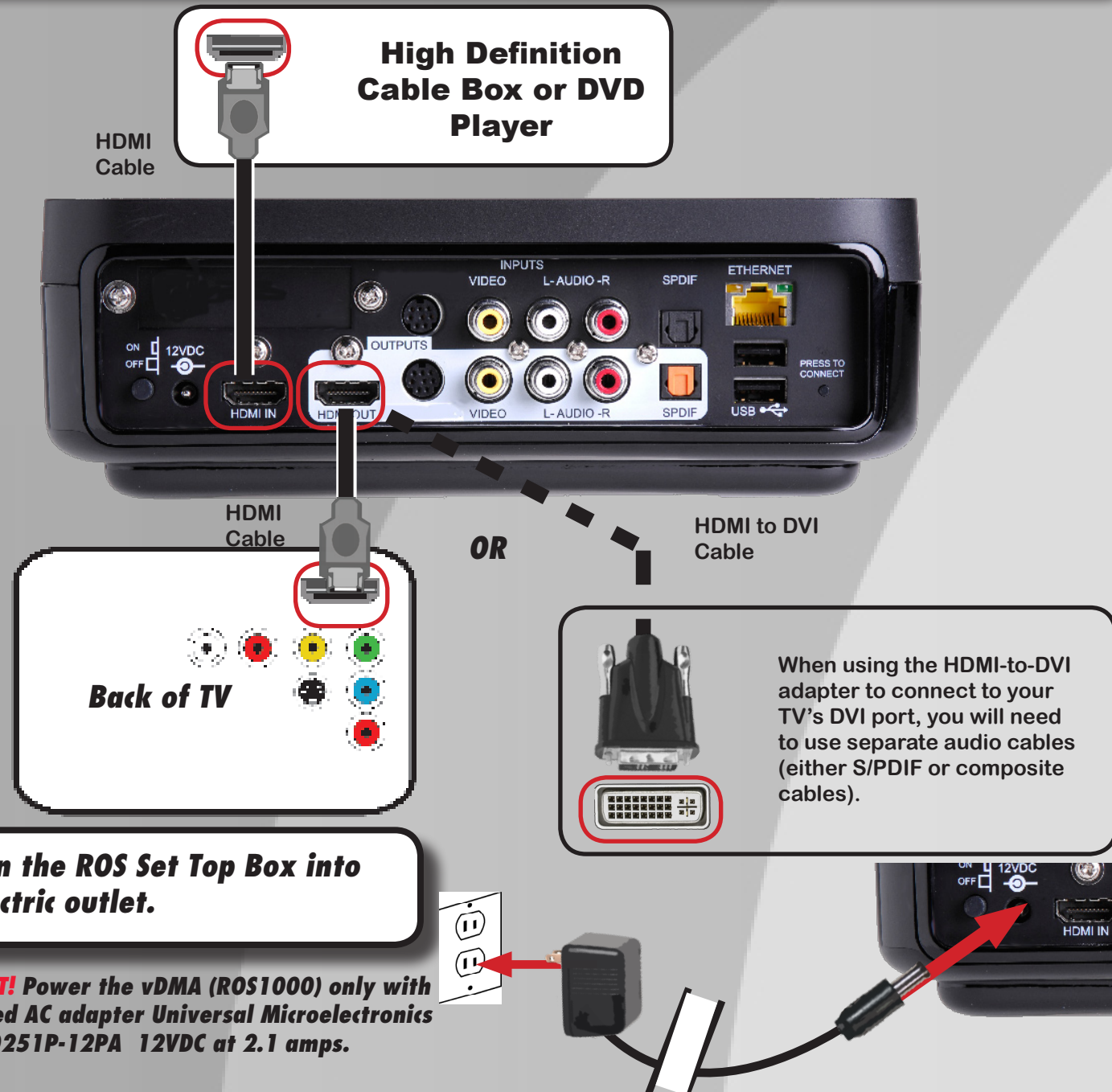

IMPORTANT! Power the vDMA (ROS1000) only with the included AC adapter Universal Microelectronics model UP0251P-12PA 12VDC at 2.1 amps.

RHC LED Description

Color	Description
Red	When first powered on, the LED is red during start up. If the LED is red after activation, check your Ethernet cabling.
Amber (blinking)	Indicates that the RHC is attempting activation.
Amber	Indicates activation failed.
Green (blinking)	Indicates the RHC is activating.
Green	Indicates the RHC is activated and you can reach the Internet.

vDMA LED Description

Color	Description
Red	The vDMA LED is red during start up; if it remains red, there is a service connectivity issue.
Amber (flashing)	vDMA is connected to the RHC but there is a service problem.
Amber	Attempting Wi-Fi Protected Setup (WPS).
Green (flashing)	vDMA is connecting to the RHC.
Green	vDMA is connected to the RHC and service is available.

ROS
Click to access your ROS Home Center.

Widgets
Access weather and more.

ROS
Click to access your ROS Video DMA menu.

To Replace the Battery: Open the battery compartment cover on the back, insert 2 AA batteries matching the + and - polarity symbols inside and replace cover.

NOTES:
When the battery voltage is low, the feedback LED will blink 5 times. Dispose of batteries properly.

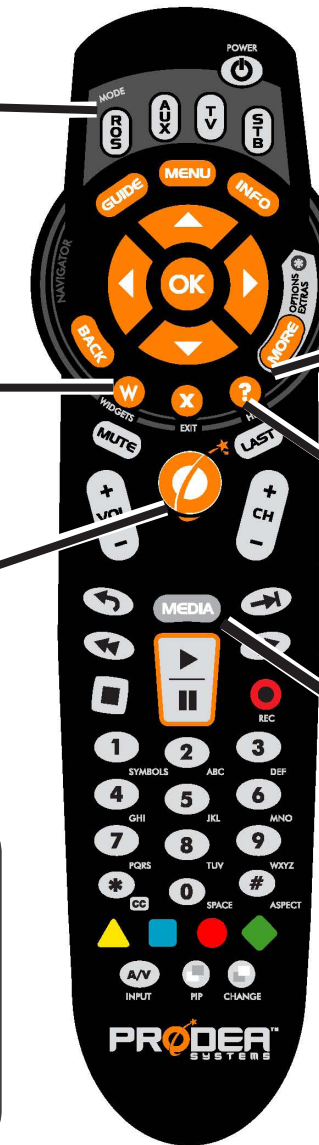

Favorites -
Quickly find your favorite music, movies, pictures and more.

Help - Get answers to your questions -- fast!

Media
Find new music and movies.

Important Safety Information

Read and follow these instructions to use your products and services safely.

- Read and keep these instructions.
- Heed all warnings.
- Follow all instructions.
- Do not use this apparatus near water.
- Clean only with dry cloth.
- Keep all devices, cabling, and accessories away from children.
- Do not install near heat sources such as radiators, heat registers, stoves, or other apparatus (including amplifiers) that produce heat.
- Protect the power cord from being touched, walked on or pinched, particularly at plugs and at the point where they exit from the apparatus.
- Only use supported devices and accessories with your service.
- Unplug this apparatus during lightning storms or when unused for long periods of time.
- Refer all servicing to qualified service personnel. Servicing is required when the apparatus has been damaged in any way, such as damage to the power-supply cord or plug, liquid has been spilled or objects have fallen into any of the devices, a device has been outdoors / exposed to rain or moisture, does not operate normally, or has been dropped.
- Do not place naked flame sources, such as lighted candles, on or near the devices.
- These devices do not have on/off switches. To disconnect the devices from power, you must disconnect the power cord. Make sure the power cord is always easily accessible but out of reach of children.
- The devices and all accessories included with this device are for indoor use only.
- Do not move the devices if another device such as a TV, computer, or other electronic device is connected to it.
- Do not expose the device to dripping or splashing and do not place any object filled with liquid on or near any of the devices.
- Other important Information such as model number, electrical rating, and other classifications is located on the bottom of the devices.

FCC Regulatory Information

This equipment has been tested and found to comply with the limits for a Class B digital device, pursuant to Part 15 of the FCC Rules. These limits are designed to provide reasonable protection against harmful interference in a residential installation. This equipment generates, uses, and can radiate radio frequency energy and, if not installed and used in accordance with the instructions, may cause harmful interference to radio communications. However, there is no guarantee that interference will not occur in a particular installation. If this equipment does cause harmful interference to radio or television reception, which can be determined by turning the equipment off and on, the user is encouraged to try to correct the interference by one or more of the following measures:

- Reorient or relocate the receiving antenna.
- Increase the separation between the equipment and receiver.
- Connect the equipment into an outlet on a circuit different from that to which the receiver is connected.

Consult your service provider, retailer, or an experienced technician for help.

If you cannot eliminate the interference, the FCC requires that you stop using your phone. Changes or modifications not expressly approved may cause interference and void the user's authority to operate the equipment.

Product	product name
Model	ROS 1000, ROS 2000
Responsible Party	Prodea Systems, Inc. 6101 West Plano Parkway Suite 210 Plano, Texas 75093
Phone	214.278.1850

This device complies with Part 15 of the FCC Rules. Operation is subject to the following two conditions: (1) This device may not cause harmful interference, and (2) This device must accept any interference received, including interference that may cause undesired operation.

This equipment complies with Part 68 of the FCC Rules and the requirements adopted by ACTA. On the back of this equipment is a label that contains a product identifier in the format US:AAEQ##TXXXX. If requested, this information must be provided to your telephone company.

A plug and jack used to connect this equipment to the premises wiring and telephone network must comply with the applicable FCC Part 68 rules and requirements adopted by ACTA. A compliant telephone cord and modular plug is provided with this product. It is designed to be connected to a compatible modular jack that is also compliant. See installation instructions for details.

The REN is used to determine the number of devices that may connect to a telephone line. Excessive RENs on a telephone line may result in the devices not ringing in response to an incoming call. In most but not all areas, the sum of the RENs should not exceed five (5.0). To be certain of the number of devices that may be connected to a line, as determined by the total RENs, contact your local telephone company. For product approved after July 23, 2001, the REN for this product is part of the product identifier that has the format US:AAEQ##TXXXX. The digits represented by ## are the REN without the decimal point (e.g., 03 is a REN of 0.3). For earlier products, the REN is separately shown on the label.

If your DIGITAL VIDEO RECORDER causes harm to the telephone network, the telephone company will notify you in advance that temporary discontinuance of service may be required. But if advance notice isn't practical, the telephone company will notify the customer as soon as possible. Also, you will be advised of your right to file a complaint with the FCC if you believe it is necessary.

The telephone company may make changes in its facilities, equipment, operations or procedures that could affect the proper functioning of your equipment. If they do, you will be notified in advance in order for you to make necessary modifications to maintain uninterrupted service.

If trouble is experienced with this unit, for repair or warranty information, please contact customer service at the address and phone listed below. If the equipment is causing harm to the network, the telephone company may request that you disconnect the equipment until the problem is resolved.

DO NOT DISASSEMBLE THIS EQUIPMENT. It does not contain any user serviceable components.

We recommend the installation of an AC surge arrester in the AC outlet to which this equipment is connected. Telephone companies report that electrical surges, typically lightning transients, are very destructive to customer terminal equipment connected to AC power sources.

Wireless Radio Use

These devices are restricted to indoor use due to its operation in the 2.4 to 5 GHz frequency range to reduce the potential for harmful interference to co-channel Mobile Satellite systems.

Outdoor operations in the 5.15-5.25GHz band is prohibited.

Exposure to Radio Frequency Energy

The radiated output power of these devices is below the FCC radio frequency exposure limits; however, these devices should be operated with a minimum distance of at least 20 cm between its antennas and a person's body, and the antennas used with these transmitters must not be co-located or operated with any other antenna or transmitter subject to the conditions of the FCC Grant.

PÓLIZA DE GARANTÍA

[address of representative company in Mexico]

[representative company in Mexico] garantiza este producto por el término de un año o noventa días en todas sus partes y mano de obra contra cualquier defecto de fabricación y funcionamiento a partir de la fecha de entrega al consumidor

CONDICIONES

I. Para hacer efectiva esta garantía no podrán exigirse mayores requisitos que la presentación de esta póliza junto con el producto en cualquier tienda de [address of representative company in Mexico], donde también se podrán encontrar partes, componentes, consumibles y accesorios.

II. La empresa se compromete a reparar el producto así como las piezas y componentes defectuosos del mismo, sin ningún cargo al consumidor, los gastos del flete del producto que se deriven de su cumplimiento serán cubiertos por [address of representative company in Mexico]

III. El tiempo de reparación en ningún caso deberá ser mayor de 30 días a partir de la recepción del producto en cualquier sitio en donde se pueda hacer efectiva la garantía.

IV. Esta garantía no es válida en los siguientes casos:

a) Cuando el producto ha sido utilizado en condiciones distintas a las normales.

b) Cuando el producto no ha sido operado siguiendo las indicaciones del instructivo proporcionado.

c) Cuando el producto ha sido alterado o reparado por personas no autorizadas por [representative company in Mexico]

V. En caso de que la presente garantía se extraviara, el consumidor puede recurrir a su proveedor para que se le expida otra póliza de garantía, previa presentación de la nota de compra o factura.

NOTA: Los aparatos eléctrico-domésticos tienen un año de garantía y los de baterías 30 días.

ESTE PRODUCTO FUE FABRICADO EN CHINA PARA [address and telephone of representative company in Mexico]

Producto:

Marca:

No. de catálogo:

No. de serie:

No. de factura:

SELLO DE LA SUCURSAL FECHA DE ENTREGA

[address of representative company in Mexico] garantiza este producto por el término de un año o noventa días en todas sus partes y mano de obra contra cualquier defecto de fabricación y funcionamiento a partir de la fecha de entrega al consumidor.

WARRANTY

This product is warranted by Prodea Systems against manufacturing defects in material and workmanship under normal use for ninety (90) days from the date of purchase from authorized Prodea Systems retailers.

For complete warranty details and exclusions, see www.prodeasystems.com.

© COPYRIGHT 2006-2008 PRODEA SYSTEMS, INC. ALL RIGHTS RESERVED.