



TEC Bluetooth™ Module for B-415 Series

TEC-BTM

Installation Manual

TOSHIBA TEC CORPORATION

Precautions for Handling of Wireless Communication Devices

Bluetooth™ Module: TEC-BTM

■ Trademark

The Bluetooth is a trademark owned by Bluetooth SIG, Inc. and is used by TOSHIBA TEC Corporation under license.

■ Cautions

General

This product is a wireless communication device, and the use of this product is restricted to the following countries or areas. If the product is used in the countries or areas other than the following, you may be punished according to the laws of those countries or areas.

Japan, USA, Canada, Austria, Belgium, Denmark, Finland, France, Germany, Greece, Italy Ireland, Luxembourg, Portugal, Spain, Sweden, Switzerland, The Netherlands, United Kingdom, Australia

For Europe: C E 0682 D

Hereby, Toshiba TEC Corporation, declares that this TEC-BTM is in compliance with the essential requirements and other relevant provisions of Directive 1999/5/EC.

This equipment uses the radio frequency band which has not been harmonized throughout all EU and EFTA countries, and can be used in the following countries.

Austria, Belgium, Denmark, Finland, France, Germany, Greece, Ireland, Italy, Luxembourg, Portugal, Spain, Sweden, Switzerland, The Netherlands, United Kingdom

For USA

This device complies with Part 15 of the FCC Rules. Operation is subject to the following two conditions :

- (1) this device may not cause harmful interference, and
- (2) this device must accept any interference received, including interference that may cause undesired operation.

Changes or modification not expressly approved by manufacturer for compliance could void the user's authority to operate the equipment.

For Canada

Operation is subject to the following two conditions:

- (1) this device may not cause interference, and
- (2) this device must accept any interference, including interference that may cause undesired operation of the device.

To prevent radio interference to the licensed service, this device is intended to be operated indoors and away from windows to provide maximum shielding. Equipment that is installed outdoors is subject to licensing.

For Japan

この機器の使用周波数帯域では、電子レンジ等の産業・科学・医療用機器のほか工場の製造ライン等で使用されている移動体識別用の構内無線局（免許を要する無線局）及び特定小電力無線局（免許を要しない無線局）が運用されています。

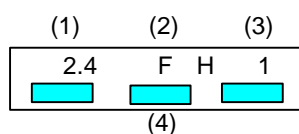

1. この機器を使用する前に、近くで移動体識別用の構内無線局及び特定小電力無線局が運用されていないことを確認して下さい。
2. 万一、この機器から移動体識別用の構内無線局に対して電波干渉の事例がした上、下記連絡先にご連絡頂き、混信回避のための処置等（例えば、パーティションの設置など）についてご相談して下さい。
3. その他、この機器から移動体識別用の特定小電力無線局に対して電波干渉の事例が発生した場合など何かお困りのことが起きたときには、購入元へお問い合わせ下さい。



(1) 「2.4」：2.4GHz 帯を使用する無線設備を表す。

(2) 「FH」：変調方式を表す。

(3) 「1」：予想される干渉距離を表す。

(4) 「  」：全帯域を使用し、かつ移動体識別装置の帯域を回避可能であることを意味する。

For safety

Do not disassemble, modify, or repair the product.

Doing so may cause injury. Also, modification is against the Laws and Regulations for Radio Equipment. Please ask your TOSHIBA TEC sales agent for repair.

Do not use the product in locations where the use is forbidden, for example, in an airplane or a hospital.

When you do not know the forbidden areas, please refer to and follow the airline company or medical institution, otherwise flight instrument or medical equipment may be affected, causing a serious accident.

Do not use the product near an automatic control device, such as an automatic door, a fire alarm, etc.

Doing so may affect the automatic control device, causing an accident.

Immediately stop using the product when it causes a failure of other devices by radio.

Failure to do this may cause malfunctions of these devices, resulting in an accident.

Precaution in use

This product communicates with other devices by radio. Depending on the installation location, orientation, environment, etc., its communication performance may deteriorate or devices installed near by may be affected.

Keep away from a microwave.

Communication performance may be deteriorated or a communication error may occur under the influence of the radio emitted from the microwave.

Keep away from the wireless LAN.

The product and the wireless LAN may interfere with each other, causing a deterioration of communication performance or a communication error.

Do not use the product on a metal table or near a metal object.

Communication performance may be deteriorated.

Specification

- Bluetooth class 2
- Built-in protocol stack activated by Bluetooth V1.1 serial port profile
- Operating temperature: -5 to 50°C 25% to 85%RH (No condensation)
- Dimensions: 38.1 mm (W) x 25.4 mm (H) x 7 mm (D)

TEC

TOSHIBA TEC CORPORATION

Procedure of attaching TEC-BTM into B-415 series

1) Open the media cover and raise it to its full open position.

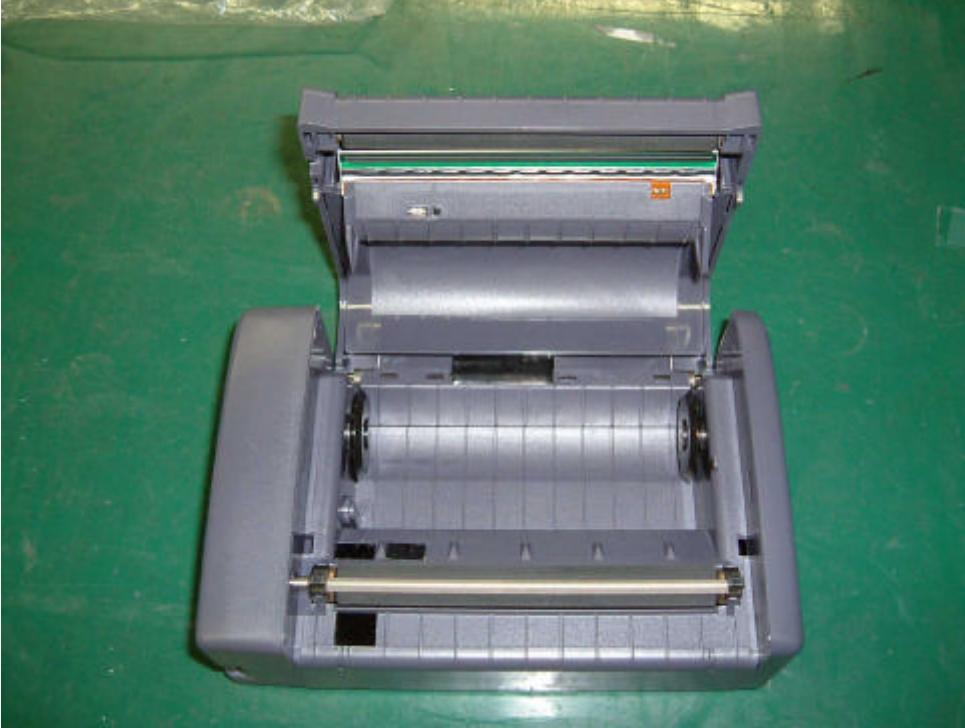

2) With a small tool, such as a pin punch or a jewellers screwdriver, push to release the left and right hooks that secure the head cover to the media cover.

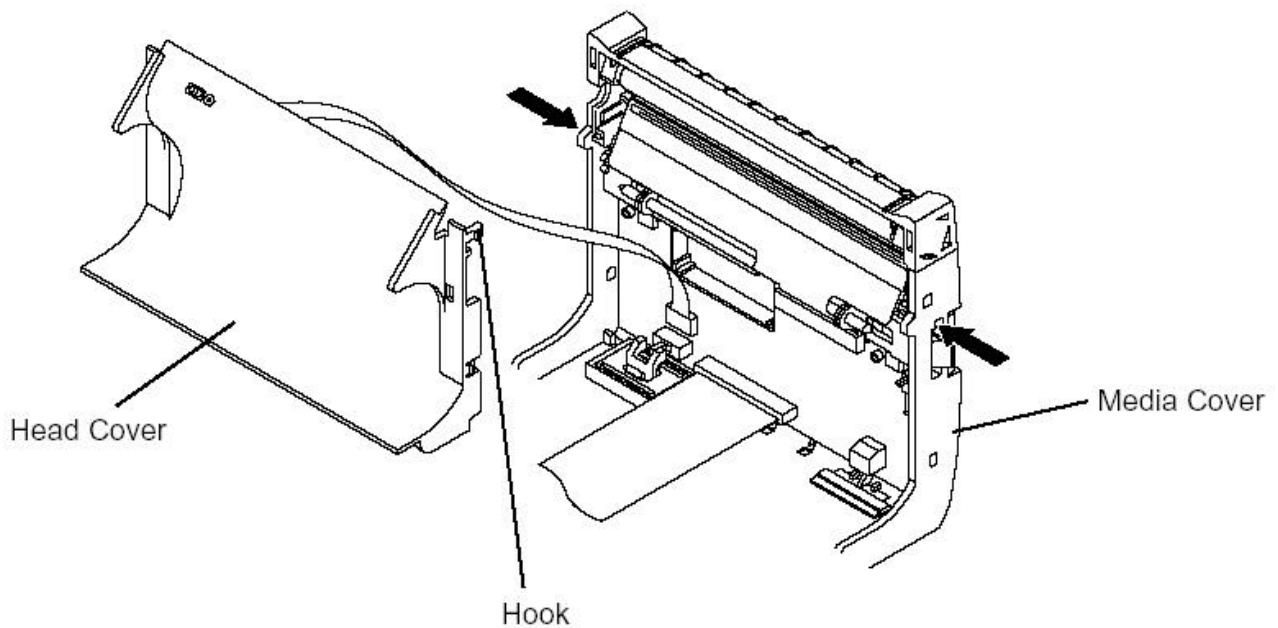

3) Take off sensor PCB with small ribbon cable (sensor FPC) from head cover.

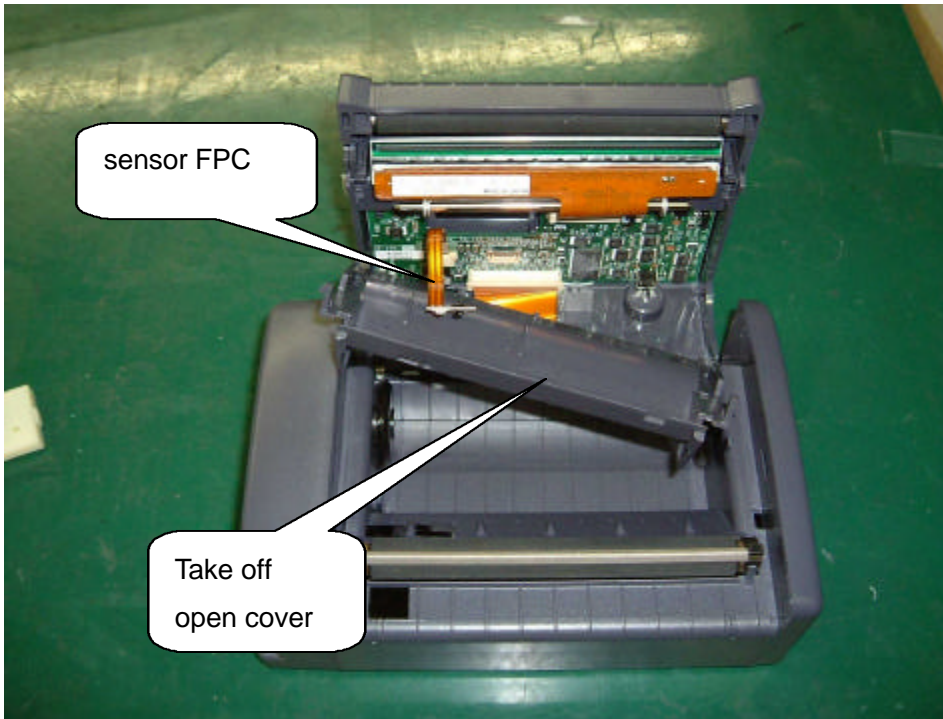

4) Attach the TEC-BTM into specified space near MAIN PCB.

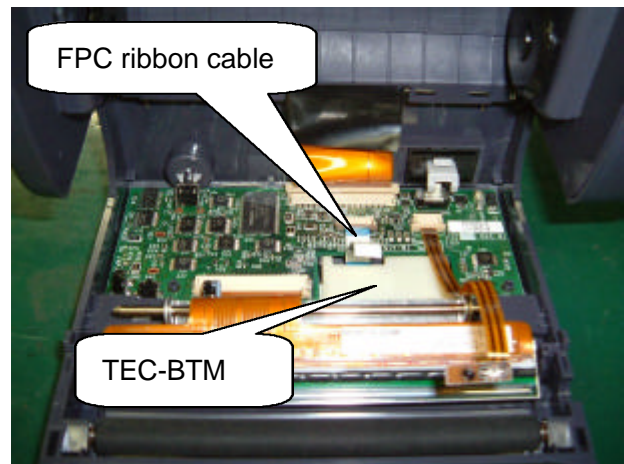
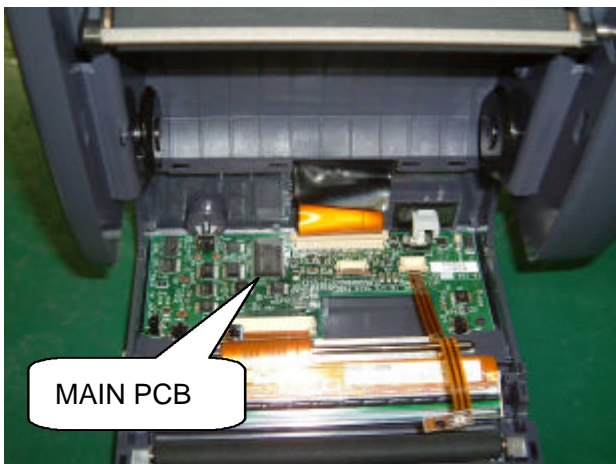

5) Connect the both side of FPC ribbon cable to the connector of TEC-BTM and the CN3 of MAIN PCB.

6) Assemble the parts according to reverse procedure.

TEC

TOSHIBA TEC CORPORATION

PRINTED IN JAPAN