

FCC Test Report

Product Name	Barcode Printer
Model No.	B-FV4T-GS14-QM-R, B-FV4T-GS12-QM-R, B-FV4T-TS14-QM-R, B-FV4T-TS12-QM-R
FCC ID.	BJI-FV4TBT1

Applicant	Toshiba TEC Corporation
Address	6-78, Minami-cho, Mishima-shi, Shizuoka-ken 411-8520, Japan

Date of Receipt	Dec. 05, 2014
Issued Date	Jan. 14, 2015
Report No.	14C0257R-RFUSP01V00
Report Version	V1.0



The test results relate only to the samples tested.
 The test results shown in the test report are traceable to the national/international standard through the calibration of the equipment and evaluated measurement uncertainty herein.
 This report must not be used to claim product endorsement by TAF or any agency of the government.
 The test report shall not be reproduced without the written approval of QuieTek Corporation.

Test Report

Issued Date: Jan. 14, 2015

Report No.: 14C0257R-RFUSP01V00



Product Name	Barcode Printer
Applicant	Toshiba TEC Corporation
Address	6-78, Minami-cho, Mishima-shi, Shizuoka-ken 411-8520, Japan
Manufacturer	Toshiba TEC Corporation
Factory	ARGOX Information Co., Ltd.
Model No.	B-FV4T-GS14-QM-R, B-FV4T-GS12-QM-R, B-FV4T-TS14-QM-R, B-FV4T-TS12-QM-R
FCC ID.	BJI-FV4TBT1
EUT Rated Voltage	AC 100-240V, 50-60Hz
EUT Test Voltage	AC 120V/60Hz
Trade Name	TOSHIBA
Applicable Standard	FCC CFR Title 47 Part 15 Subpart C: 2013 ANSI C63.4: 2014, ANSI C63.10: 2013
Test Result	Complied

Documented By :

(Senior Adm. Specialist / Joanne Lin)

Tested By :

(Engineer / Eason Chen)

Approved By :

(Director / Vincent Lin)

TABLE OF CONTENTS

Description	Page
1. GENERAL INFORMATION	5
1.1. EUT Description.....	5
1.2. Operational Description.....	7
1.3. Tested System Details.....	8
1.4. Configuration of Tested System	8
1.5. EUT Exercise Software	9
1.6. Test Facility	10
2. CONDUCTED EMISSION	11
2.1. Test Equipment.....	11
2.2. Test Setup	11
2.3. Limits.....	12
2.4. Test Procedure	12
2.5. Uncertainty	12
2.6. Test Result of Conducted Emission.....	13
3. PEAK POWER OUTPUT	15
3.1. Test Equipment.....	15
3.2. Test Setup	15
3.3. Limit	15
3.4. Test Procedure	15
3.5. Uncertainty	15
3.6. Test Result of Peak Power Output.....	16
4. RADIATED EMISSION	18
4.1. Test Equipment.....	18
4.2. Test Setup	18
4.3. Limits.....	19
4.4. Test Procedure	20
4.5. Uncertainty	20
4.6. Test Result of Radiated Emission.....	21
5. RF ANTENNA CONDUCTED TEST	29
5.1. Test Equipment.....	29
5.2. Test Setup	29
5.3. Limits.....	29
5.4. Test Procedure	29
5.5. Uncertainty	29
5.6. Test Result of RF Antenna Conducted Test.....	30
6. BAND EDGE	32
6.1. Test Equipment.....	32
6.2. Test Setup	33
6.3. Limit	34
6.4. Test Procedure	34
6.5. Uncertainty	34

6.6.	Test Result of Band Edge	35
7.	CHANNEL NUMBER.....	43
7.1.	Test Equipment	43
7.2.	Test Setup	43
7.3.	Limit	43
7.4.	Test Procedure	43
7.5.	Uncertainty	43
7.6.	Test Result of Channel Number.....	44
8.	CHANNEL SEPARATION.....	46
8.1.	Test Equipment	46
8.2.	Test Setup	46
8.3.	Limit	46
8.4.	Test Procedure	46
8.5.	Uncertainty	46
8.6.	Test Result of Channel Separation.....	47
9.	DWELL TIME.....	51
9.1.	Test Equipment	51
9.2.	Test Setup	51
9.3.	Limit	51
9.4.	Test Procedure	51
9.5.	Uncertainty	51
9.6.	Test Result of Dwell Time	52
10.	OCCUPIED BANDWIDTH	56
10.1.	Test Equipment	56
10.2.	Test Setup	56
10.3.	Limits.....	56
10.4.	Test Procedure	56
10.5.	Uncertainty	56
10.6.	Test Result of Occupied Bandwidth	57
11.	EMI REDUCTION METHOD DURING COMPLIANCE TESTING	63

Attachment 1: EUT Test Photographs
Attachment 2: EUT Detailed Photographs

1. GENERAL INFORMATION

1.1. EUT Description

Product Name	Barcode Printer
Trade Name	TOSHIBA
Model No.	B-FV4T-GS14-QM-R, B-FV4T-GS12-QM-R, B-FV4T-TS14-QM-R, B-FV4T-TS12-QM-R
FCC ID.	BJI-FV4TBT1
Frequency Range	2402 – 2480MHz
Channel Number	79
Type of Modulation	FHSS: GFSK(1Mbps) / π /4DQPSK(2Mbps) / 8DPSK(3Mbps)
Antenna Type	Chip Antenna
Channel Control	Auto
Antenna Gain	Refer to the table “Antenna List”
USB Cable	Shielded, 1.6m
RS-232 Cable	Shielded, 1.5m
Power Cable	Non-Shielded, 1.8m
Power Adapter	MFR: EDAC Electronics (Suzhou) Co., Ltd., M/N: EA10953 Input: AC 100-240V~2.5A, 50-60Hz Output: DC 24V, 3.75A Cable Out: Non-Shielded, 1.3m

Antenna List

No.	Manufacturer	Part No.	Antenna Type	Peak Gain
1	ARGOX	69-70001-002	Chip	4.1dBi for 2.4 GHz

Note: The antenna of EUT is conform to FCC 15.203.

Frequency of Each Channel:

Channel	Frequency	Channel	Frequency	Channel	Frequency	Channel	Frequency
Channel 00:	2402 MHz	Channel 20:	2422 MHz	Channel 40:	2442 MHz	Channel 60:	2462 MHz
Channel 01:	2403 MHz	Channel 21:	2423 MHz	Channel 41:	2443 MHz	Channel 61:	2463 MHz
Channel 02:	2404 MHz	Channel 22:	2424 MHz	Channel 42:	2444 MHz	Channel 62:	2464 MHz
Channel 03:	2405 MHz	Channel 23:	2425 MHz	Channel 43:	2445 MHz	Channel 63:	2465 MHz
Channel 04:	2406 MHz	Channel 24:	2426 MHz	Channel 44:	2446 MHz	Channel 64:	2466 MHz
Channel 05:	2407 MHz	Channel 25:	2427 MHz	Channel 45:	2447 MHz	Channel 65:	2467 MHz
Channel 06:	2408 MHz	Channel 26:	2428 MHz	Channel 46:	2448 MHz	Channel 66:	2468 MHz
Channel 07:	2409 MHz	Channel 27:	2429 MHz	Channel 47:	2449 MHz	Channel 67:	2469 MHz
Channel 08:	2410 MHz	Channel 28:	2430 MHz	Channel 48:	2450 MHz	Channel 68:	2470 MHz
Channel 09:	2411 MHz	Channel 29:	2431 MHz	Channel 49:	2451 MHz	Channel 69:	2471 MHz
Channel 10:	2412 MHz	Channel 30:	2432 MHz	Channel 50:	2452 MHz	Channel 70:	2472 MHz
Channel 11:	2413 MHz	Channel 31:	2433 MHz	Channel 51:	2453 MHz	Channel 71:	2473 MHz
Channel 12:	2414 MHz	Channel 32:	2434 MHz	Channel 52:	2454 MHz	Channel 72:	2474 MHz
Channel 13:	2415 MHz	Channel 33:	2435 MHz	Channel 53:	2455 MHz	Channel 73:	2475 MHz
Channel 14:	2416 MHz	Channel 34:	2436 MHz	Channel 54:	2456 MHz	Channel 74:	2476 MHz
Channel 15:	2417 MHz	Channel 35:	2437 MHz	Channel 55:	2457 MHz	Channel 75:	2477 MHz
Channel 16:	2418 MHz	Channel 36:	2438 MHz	Channel 56:	2458 MHz	Channel 76:	2478 MHz
Channel 17:	2419 MHz	Channel 37:	2439 MHz	Channel 57:	2459 MHz	Channel 77:	2479 MHz
Channel 18:	2420 MHz	Channel 38:	2440 MHz	Channel 58:	2460 MHz	Channel 78:	2480 MHz
Channel 19:	2421 MHz	Channel 39:	2441 MHz	Channel 59:	2461 MHz		

Note:

1. The EUT is a Barcode Printer with a built-in Bluetooth transceiver.
2. The different is listed as below:

Model Name	Prototype	Difference	Note
B-FV4T-GS14-QM-R	--	USB+LAN+RS232	Resolution: 203 dpi
B-FV4T-GS12-QM-R	B-FV4T-GS14-QM-R	USB+LAN	Resolution: 203 dpi
B-FV4T-TS14-QM-R	B-FV4T-GS14-QM-R	USB+LAN+RS232	Resolution: 300 dpi
B-FV4T-TS12-QM-R	B-FV4T-GS14-QM-R	USB+LAN	Resolution: 300 dpi

3. These tests were conducted on a sample for the purpose of demonstrating compliance of Bluetooth transmitter with Part 15 Subpart C Paragraph 15.247 for spread spectrum devices.
4. Regarding to the operation frequency, the lowest, middle and highest frequency are selected to perform the test.
5. Bluetooth operation was evaluated at both 1Mb/s and 3Mb/s data rates. 2Mb/s data rate was found, through pre-testing, to produce emissions similar to those for 3Mb/s.

Test Mode	Mode 1: Transmit - 1Mbps (GFSK) Mode 2: Transmit - 3Mbps (8DPSK)
-----------	---

1.3. Tested System Details

The types for all equipment, plus descriptions of all cables used in the tested system (including inserted cards) are:

Product	Manufacturer	Model No.	Serial No.	Power Cord
1 Notebook PC	DELL	PP18L	36119001664	Non-Shielded, 1.8m
2 Test Fixture	N/A	N/A	N/A	N/A
3 FLASH	Transcend	JetFlash110	155422-2931	N/A

Signal Cable Type	Signal cable Description
A USB Cable	Shielded, 1.8m
B Signal Cable	Non-Shielded, 0.2m
C Printer Cable	Shielded, 1.2m
D LAN Cable	Non-Shielded, 2m
E RS-232 Cable	Shielded, 1.5m
F USB Cable	Shielded, 1.6m

1.4. Configuration of Tested System

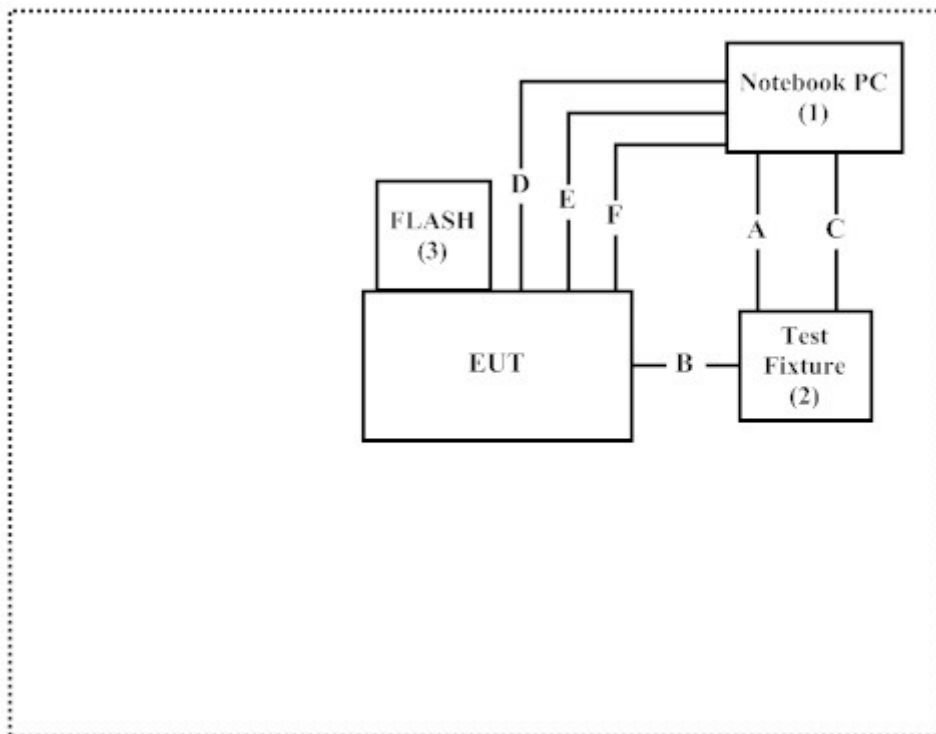

1.5. EUT Exercise Software

- (1) Setup the EUT as shown in Section 1.3.
- (2) Execute software “Tera Term Pro v2.3.0.0” on the Notebook.
- (3) Configure the test mode, the test channel, and the data rate.
- (4) Press “OK” to start the continuous Transmit.
- (5) Verify that the EUT works properly.

1.6. Test Facility

Ambient conditions in the laboratory:

Items	Required (IEC 68-1)	Actual
Temperature (°C)	15-35	20-35
Humidity (%RH)	25-75	30-65
Barometric pressure (mbar)	860-1060	950-1000

The related certificate for our laboratories about the test site and management system can be downloaded from QuieTek Corporation’s Web Site: <http://www.quietek.com/tw/ctg/cts/accreditations.htm>
 The address and introduction of QuieTek Corporation’s laboratories can be founded in our Web site: <http://www.quietek.com/>

Site Description: File on
 Federal Communications Commission
 FCC Engineering Laboratory
 7435 Oakland Mills Road
 Columbia, MD 21046
 Registration Number: 92195

Site Name: Quietek Corporation
 Site Address: No.5-22, Ruishukeng,
 Linkou Dist. New Taipei City 24451,
 Taiwan, R.O.C.
 TEL: 886-2-8601-3788 / FAX : 886-2-8601-3789
 E-Mail : service@quietek.com

FCC Accreditation Number: TW1014

2. Conducted Emission

2.1. Test Equipment

	Equipment	Manufacturer	Model No. / Serial No.	Last Cal.	Remark
X	Test Receiver	R & S	ESCS 30 / 825442/018	Sep., 2014	
X	Artificial Mains Network	R & S	ENV4200 / 848411/10	Feb., 2014	Peripherals
X	LISN	R & S	ESH3-Z5 / 825562/002	Feb., 2014	EUT
	DC LISN	Schwarzbeck	8226 / 176	Mar., 2014	EUT
X	Pulse Limiter	R & S	ESH3-Z2 / 357.8810.52	Feb., 2014	
	No.1 Shielded Room				

Note:

1. All equipments are calibrated every one year.
2. The test instruments marked by “X” are used to measure the final test results.

2.2. Test Setup

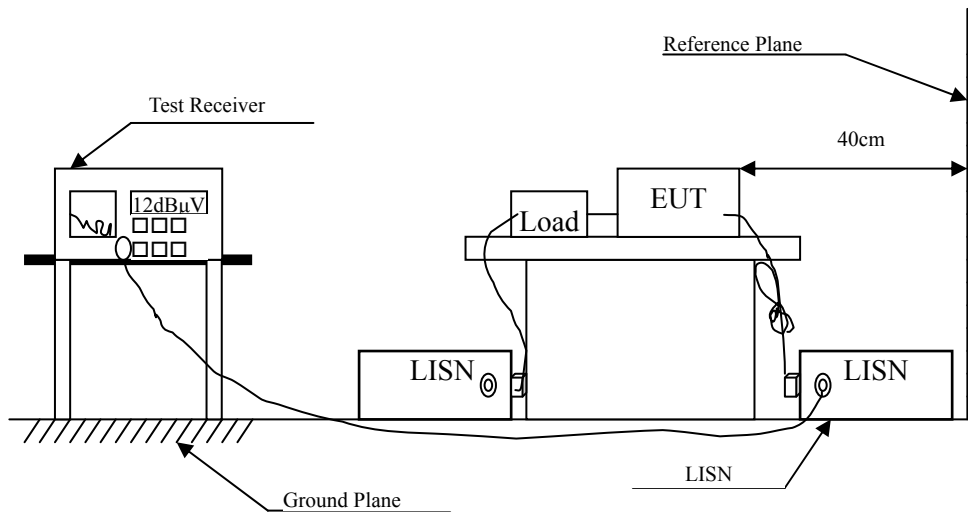

2.3. Limits

FCC Part 15 Subpart C Paragraph 15.207 (dBμV) Limit		
Frequency MHz	Limits	
	QP	AV
0.15 - 0.50	66-56	56-46
0.50-5.0	56	46
5.0 - 30	60	50

Remarks: In the above table, the tighter limit applies at the band edges.

2.4. Test Procedure

The EUT and Peripherals are connected to the main power through a line impedance stabilization network (L.I.S.N.). This provides a 50 ohm /50uH coupling impedance for the measuring equipment. The peripheral devices are also connected to the main power through a LISN that provides a 50ohm /50uH coupling impedance with 50ohm termination. (Please refer to the block diagram of the test setup and photographs.)

Both sides of A.C. line are checked for maximum conducted interference. In order to find the maximum emission, the relative positions of equipment and all the interface cables must be changed according to ANSI C63.10: 2013 on conducted measurement.

Conducted emissions were investigated over the frequency range from 0.15MHz to 30MHz using a receiver bandwidth of 9kHz.

The EUT was setup to ANSI C63.10: 2013; tested to FHSS test procedure of FCC Public Notice DA 00-705 for compliance to FCC 47CFR 15.247 requirements.

2.5. Uncertainty

± 2.26 dB

2.6. Test Result of Conducted Emission

Product : Barcode Printer
 Test Item : Conducted Emission Test
 Power Line : Line 1
 Test Mode : Mode 2: Transmit - 3Mbps (8DPSK) (2441MHz)

Frequency MHz	Correct Factor dB	Reading Level dBμV	Measurement Level dBμV	Margin dB	Limit dBμV
LINE 1					
Quasi-Peak					
0.201	9.650	37.990	47.640	-16.903	64.543
0.650	9.675	32.410	42.085	-13.915	56.000
1.025	9.695	26.620	36.315	-19.685	56.000
1.345	9.723	27.420	37.143	-18.857	56.000
1.873	9.762	22.760	32.522	-23.478	56.000
2.994	9.803	20.580	30.383	-25.617	56.000
Average					
0.201	9.650	28.260	37.910	-16.633	54.543
0.650	9.675	24.180	33.855	-12.145	46.000
1.025	9.695	16.440	26.135	-19.865	46.000
1.345	9.723	15.860	25.583	-20.417	46.000
1.873	9.762	12.440	22.202	-23.798	46.000
2.994	9.803	11.650	21.453	-24.547	46.000

Note:

1. All Reading Levels are Quasi-Peak and average value.
2. "█" means the worst emission level.
3. Measurement Level = Reading Level + Correct Factor

Product : Barcode Printer
 Test Item : Conducted Emission Test
 Power Line : Line 2
 Test Mode : Mode 2: Transmit - 3Mbps (8DPSK) (2441MHz)

Frequency MHz	Correct Factor dB	Reading Level dBμV	Measurement Level dBμV	Margin dB	Limit dBμV
LINE 2					
Quasi-Peak					
0.201	9.660	35.390	45.050	-19.493	64.543
0.279	9.665	24.350	34.015	-28.299	62.314
0.408	9.662	24.350	34.012	-24.617	58.629
0.611	9.673	33.820	43.493	-12.507	56.000
0.931	9.700	29.250	38.950	-17.050	56.000
1.962	9.767	25.580	35.347	-20.653	56.000
Average					
0.201	9.660	28.300	37.960	-16.583	54.543
0.279	9.665	13.910	23.575	-28.739	52.314
0.408	9.662	16.680	26.342	-22.287	48.629
0.611	9.673	24.680	34.353	-11.647	46.000
0.931	9.700	19.100	28.800	-17.200	46.000
1.962	9.767	16.470	26.237	-19.763	46.000

Note:

1. All Reading Levels are Quasi-Peak and average value.
2. "█" means the worst emission level.
3. Measurement Level = Reading Level + Correct Factor

3. Peak Power Output

3.1. Test Equipment

	Equipment	Manufacturer	Model No./Serial No.	Last Cal.
X	Power Meter	Anritsu	ML2495A/6K00003357	May, 2014
X	Power Sensor	Anritsu	MA2411B/0738448	Jun., 2014

Note: 1. All equipments are calibrated every one year.
 2. The test instruments marked by “X” are used to measure the final test results.

3.2. Test Setup

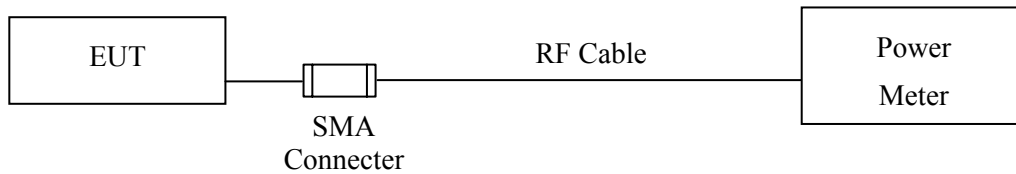

3.3. Limit

The maximum peak power shall be less 1Watt.

3.4. Test Procedure

The EUT was setup to ANSI C63.10: 2013; tested to FHSS test procedure of FCC Public Notice DA 00-705 for compliance to FCC 47CFR 15.247 requirements.

3.5. Uncertainty

± 1.27 dB

3.6. Test Result of Peak Power Output

Product : Barcode Printer
 Test Item : Peak Power Output
 Test Site : No.3 OATS
 Test Mode : Mode 1: Transmit - 1Mbps (GFSK)

Channel No.	Frequency (MHz)	Measurement (dBm)	Required Limit	Result
Channel 00	2402.00	3.09	1 Watt= 30 dBm	Pass
Channel 39	2441.00	3.48	1 Watt= 30 dBm	Pass
Channel 78	2480.00	3.61	1 Watt= 30 dBm	Pass

Product : Barcode Printer
Test Item : Peak Power Output
Test Site : No.3 OATS
Test Mode : Mode 2: Transmit - 3Mbps (8DPSK)

Channel No.	Frequency (MHz)	Measurement (dBm)	Required Limit	Result
Channel 00	2402.00	-0.29	1 Watt= 30 dBm	Pass
Channel 39	2441.00	-0.27	1 Watt= 30 dBm	Pass
Channel 78	2480.00	-0.33	1 Watt= 30 dBm	Pass

4. Radiated Emission

4.1. Test Equipment

The following test equipments are used during the radiated emission test:

Test Site	Equipment	Manufacturer	Model No./Serial No.	Last Cal.	
☒ Site # 3	X	Magnetic Loop Antenna	Teseq	HLA6121/ 37133	Sep., 2014
	X	Bilog Antenna	Schaffner Chase	CBL6112B/ 2707	Jun., 2014
	X	EMI Test Receiver	R&S	ESCS 30/838251/ 001	Jun., 2014
	X	Coaxial Cable	QTK(Armist)	RG 214/ LC003-RG	Jun., 2014
	X	Coaxial signal switch	Armist	MP59B/ 6200798682	Jun., 2014

Test Site	Equipment	Manufacturer	Model No./Serial No.	Last Cal.	
☒ CB # 8	X	Spectrum Analyzer	R&S	FSP40/ 100339	Oct., 2014
	X	Horn Antenna	ETS-Lindgren	3117/ 35205	Mar., 2014
	X	Horn Antenna	Schwarzbeck	BBHA9170/209	Jan., 2015
	X	Horn Antenna	TRC	AH-0801/95051	Aug., 2014
	X	Pre-Amplifier	EMCI	EMC012630SE/980210	Jan., 2015
	X	Pre-Amplifier	MITEQ	JS41-001040000-58-5P/153945	Jul., 2014
	X	Pre-Amplifier	NARDA	DBL-1840N506/013	Jul., 2014

- Note: 1. All equipments are calibrated with traceable calibrations. Each calibration is traceable to the national or international standards.
 2. The test instruments marked with “X” are used to measure the final test results.

4.2. Test Setup

Below 1GHz

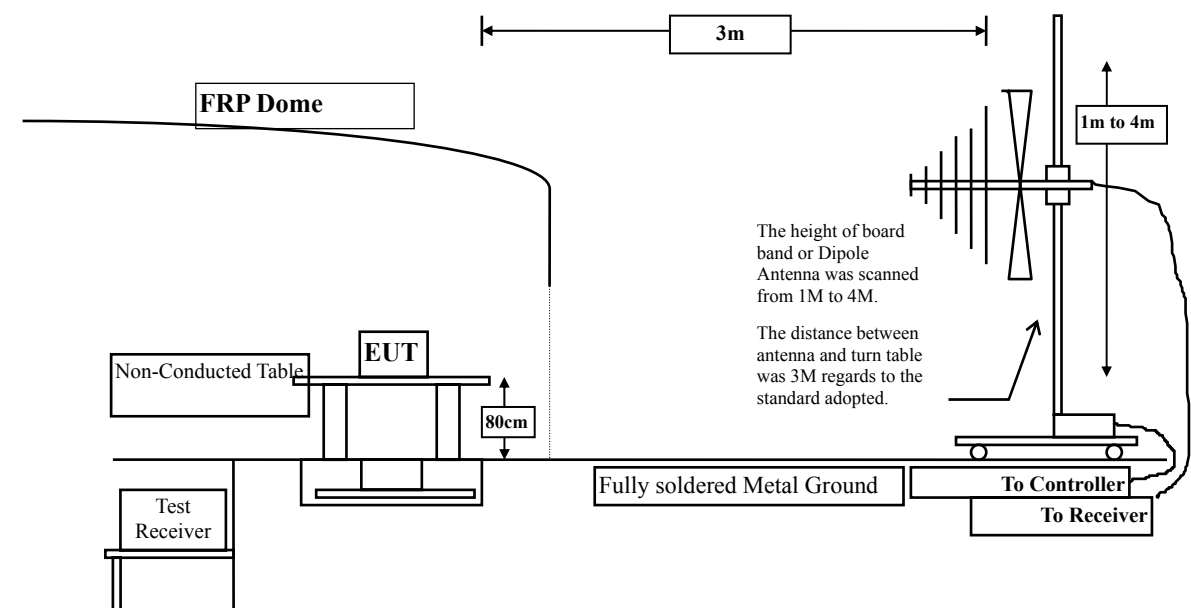

Above 1GHz

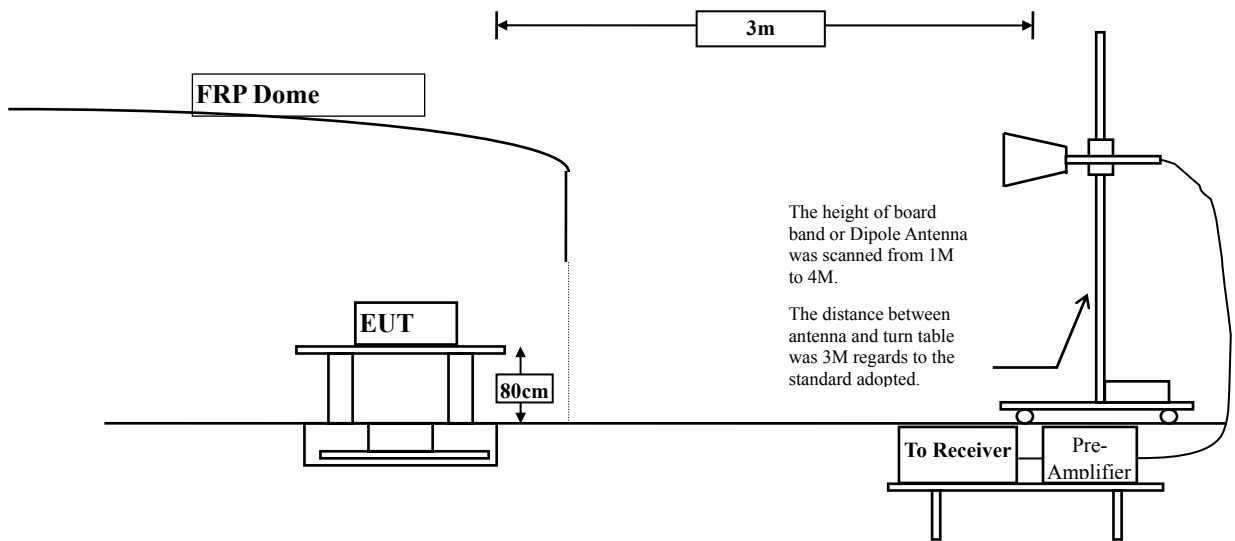

4.3. Limits

➤ **General Radiated Emission Limits**

Emissions radiated outside of the specified frequency bands, except for harmonics, shall be attenuated by at least 20dB below the level of the fundamental or to the general radiated emission limits in paragraph 15.209, whichever is the lesser attenuation.

FCC Part 15 Subpart C Paragraph 15.209 Limits		
Frequency MHz	uV/m @3m	dBµV/m@3m
30-88	100	40
88-216	150	43.5
216-960	200	46
Above 960	500	54

- Remarks:
1. RF Voltage (dBµV) = 20 log RF Voltage (uV)
 2. In the Above Table, the tighter limit applies at the band edges.
 3. Distance refers to the distance in meters between the measuring instrument antenna and the closed point of any part of the device or system.

4.4. Test Procedure

The EUT was setup according to ANSI C63.10, 2013 and tested according to FHSS test procedure of FCC Public Notice DA 00-705 for compliance to FCC 47CFR 15.247 requirements.

The EUT is placed on a turn table which is 0.8 meter above ground. The turn table is rotated 360 degrees to determine the position of the maximum emission level. The EUT was positioned such that the distance from antenna to the EUT was 3 meters.

The antenna is scanned from 1 meter to 4 meters to find out the maximum emission level. This is repeated for both horizontal and vertical polarization of the antenna. In order to find the maximum emission, all of the interface cables were manipulated according to ANSI C63.10, 2013 on radiated measurement.

The resolution bandwidth below 1GHz setting on the field strength meter is 120 kHz and above 1GHz is 1MHz.

Radiated emission measurements below 1GHz are made using broadband Bilog antenna and above 1GHz are made using Horn Antennas.

The measurement is divided into the Preliminary Measurement and the Final Measurement.

The suspected frequencies are searched for in Preliminary Measurement with the measurement antenna kept pointed at the source of the emission both in azimuth and elevation, with the polarization of the antenna oriented for maximum response. The antenna is pointed at an angle towards the source of the emission, and the EUT is rotated in both height and polarization to maximize the measured emission. The emission is kept within the illumination area of the 3 dB bandwidth of the antenna.

The worst radiated emission is measured on the Final Measurement.

The measurement frequency range from 9kHz - 10th Harmonic of fundamental was investigated.

4.5. Uncertainty

± 3.9 dB above 1GHz

± 3.8 dB below 1GHz

4.6. Test Result of Radiated Emission

Product : Barcode Printer
 Test Item : Harmonic Radiated Emission
 Test Site : No.3 OATS
 Test Mode : Mode 1: Transmit - 1Mbps (GFSK)(2402MHz)

Frequency MHz	Correct Factor dB	Reading Level dBμV	Measurement Level dBμV/m	Margin dB	Limit dBμV/m
Horizontal					
Peak Detector:					
4804.000	3.327	47.260	50.587	-23.413	74.000
7206.000	10.136	38.260	48.396	-25.604	74.000
9608.000	13.706	38.260	51.966	-22.034	74.000
Average Detector:					
--					
Vertical					
Peak Detector:					
4804.000	6.638	46.660	53.297	-20.703	74.000
7206.000	11.005	38.260	49.265	-24.735	74.000
9608.000	14.103	37.120	51.223	-22.777	74.000
Average Detector:					
--					

Note:

1. All Readings below 1GHz are Quasi-Peak, above 1GHz are performed with peak and/or average measurements as necessary.
2. Peak measurements: RBW = 1MHz, VBW = 3 MHz, Sweep: Auto.
3. Average measurements: RBW = 1MHz, VBW = 10 Hz, Sweep: Auto.
4. Measurement Level = Reading Level + Correct Factor.
5. Correct Factor = Antenna factor + Cable loss – Amplifier gain.
6. The average measurement was not performed when the peak measured data under the limit of average detection.
7. The emission levels of other frequencies are very lower than the limit and not show in test report.

Product : Barcode Printer
 Test Item : Harmonic Radiated Emission
 Test Site : No.3 OATS
 Test Mode : Mode 1: Transmit - 1Mbps (GFSK)(2441MHz)

Frequency MHz	Correct Factor dB	Reading Level dB μ V	Measurement Level dB μ V/m	Margin dB	Limit dB μ V/m
Horizontal					
Peak Detector:					
4882.000	3.001	46.260	49.261	-24.739	74.000
7323.000	11.846	37.260	49.107	-24.893	74.000
9764.000	12.563	37.120	49.683	-24.317	74.000
Average Detector:					
--					
Vertical					
Peak Detector:					
4882.000	5.713	45.260	50.974	-23.026	74.000
7323.000	12.727	37.150	49.878	-24.122	74.000
9764.000	13.028	37.260	50.288	-23.712	74.000
Average Detector:					
--					

Note:

1. All Readings below 1GHz are Quasi-Peak, above 1GHz are performed with peak and/or average measurements as necessary.
2. Peak measurements: RBW = 1MHz, VBW = 3 MHz, Sweep: Auto.
3. Average measurements: RBW = 1MHz, VBW = 10 Hz, Sweep: Auto.
4. Measurement Level = Reading Level + Correct Factor.
5. Correct Factor = Antenna factor + Cable loss – Amplifier gain.
6. The average measurement was not performed when the peak measured data under the limit of average detection.
7. The emission levels of other frequencies are very lower than the limit and not show in test report.

Product : Barcode Printer
 Test Item : Harmonic Radiated Emission
 Test Site : No.3 OATS
 Test Mode : Mode 1: Transmit - 1Mbps (GFSK)(2480MHz)

Frequency MHz	Correct Factor dB	Reading Level dB μ V	Measurement Level dB μ V/m	Margin dB	Limit dB μ V/m
Horizontal					
Peak Detector:					
4960.000	2.760	45.690	48.450	-25.550	74.000
7440.000	12.567	37.120	49.686	-24.314	74.000
9920.000	13.456	37.260	50.716	-23.284	74.000
Average Detector:					
--					
Vertical					
Peak Detector:					
4960.000	5.557	46.230	51.787	-22.213	74.000
7440.000	13.426	37.560	50.985	-23.015	74.000
9920.000	13.958	37.510	51.468	-22.532	74.000
Average Detector:					
--					

Note:

1. All Readings below 1GHz are Quasi-Peak, above 1GHz are performed with peak and/or average measurements as necessary.
2. Peak measurements: RBW = 1MHz, VBW = 3 MHz, Sweep: Auto.
3. Average measurements: RBW = 1MHz, VBW = 10 Hz, Sweep: Auto.
4. Measurement Level = Reading Level + Correct Factor.
5. Correct Factor = Antenna factor + Cable loss – Amplifier gain.
6. The average measurement was not performed when the peak measured data under the limit of average detection.
7. The emission levels of other frequencies are very lower than the limit and not show in test report.

Product : Barcode Printer
 Test Item : Harmonic Radiated Emission
 Test Site : No.3 OATS
 Test Mode : Mode 2: Transmit - 3Mbps (8DPSK)(2402MHz)

Frequency MHz	Correct Factor dB	Reading Level dBμV	Measurement Level dBμV/m	Margin dB	Limit dBμV/m
Horizontal					
Peak Detector:					
4804.000	3.327	45.230	48.557	-25.443	74.000
7206.000	10.136	39.230	49.366	-24.634	74.000
9608.000	13.706	37.020	50.726	-23.274	74.000
Average Detector:					
--					
Vertical					
Peak Detector:					
4804.000	6.638	46.260	52.897	-21.103	74.000
7206.000	11.005	37.120	48.125	-25.875	74.000
9608.000	14.103	36.020	50.123	-23.877	74.000
Average Detector:					
--					

Note:

1. All Readings below 1GHz are Quasi-Peak, above 1GHz are performed with peak and/or average measurements as necessary.
2. Peak measurements: RBW = 1MHz, VBW = 3 MHz, Sweep: Auto.
3. Average measurements: RBW = 1MHz, VBW = 10 Hz, Sweep: Auto.
4. Measurement Level = Reading Level + Correct Factor.
5. Correct Factor = Antenna factor + Cable loss –Amplifier gain.
6. The average measurement was not performed when the peak measured data under the limit of average detection.
7. The emission levels of other frequencies are very lower than the limit and not show in test report.

Product : Barcode Printer
 Test Item : Harmonic Radiated Emission
 Test Site : No.3 OATS
 Test Mode : Mode 2: Transmit - 3Mbps (8DPSK) (2441MHz)

Frequency MHz	Correct Factor dB	Reading Level dBμV	Measurement Level dBμV/m	Margin dB	Limit dBμV/m
Horizontal					
Peak Detector:					
4882.000	3.001	47.120	50.121	-23.879	74.000
7323.000	11.846	37.120	48.967	-25.033	74.000
9764.000	12.563	37.220	49.783	-24.217	74.000
Average Detector:					
--					
Vertical					
Peak Detector:					
4882.000	5.713	47.120	52.834	-21.166	74.000
7323.000	12.727	40.550	53.278	-20.722	74.000
9764.000	13.028	37.120	50.148	-23.852	74.000
Average Detector:					
--					

Note:

1. All Readings below 1GHz are Quasi-Peak, above 1GHz are performed with peak and/or average measurements as necessary.
2. Peak measurements: RBW = 1MHz, VBW = 3 MHz, Sweep: Auto.
3. Average measurements: RBW = 1MHz, VBW = 10 Hz, Sweep: Auto.
4. Measurement Level = Reading Level + Correct Factor.
5. Correct Factor = Antenna factor + Cable loss – Amplifier gain.
6. The average measurement was not performed when the peak measured data under the limit of average detection.
7. The emission levels of other frequencies are very lower than the limit and not show in test report.

Product : Barcode Printer
 Test Item : Harmonic Radiated Emission
 Test Site : No.3 OATS
 Test Mode : Mode 2: Transmit - 3Mbps (8DPSK) (2480MHz)

Frequency MHz	Correct Factor dB	Reading Level dB μ V	Measurement Level dB μ V/m	Margin dB	Limit dB μ V/m
Horizontal					
Peak Detector:					
4960.000	2.760	45.120	47.880	-26.120	74.000
7440.000	12.567	37.120	49.686	-24.314	74.000
9920.000	13.456	38.030	51.486	-22.514	74.000
Average Detector:					
--					
Vertical					
Peak Detector:					
4960.000	5.557	47.030	52.587	-21.413	74.000
7440.000	13.426	37.520	50.945	-23.055	74.000
9920.000	13.958	37.230	51.188	-22.812	74.000
Average Detector:					
--					

Note:

1. All Readings below 1GHz are Quasi-Peak, above 1GHz are performed with peak and/or average measurements as necessary.
2. Peak measurements: RBW = 1MHz, VBW = 3 MHz, Sweep: Auto.
3. Average measurements: RBW = 1MHz, VBW = 10 Hz, Sweep: Auto.
4. Measurement Level = Reading Level + Correct Factor.
5. Correct Factor = Antenna factor + Cable loss – Amplifier gain.
6. The average measurement was not performed when the peak measured data under the limit of average detection.
7. The emission levels of other frequencies are very lower than the limit and not show in test report.

Product : Barcode Printer
 Test Item : General Radiated Emission
 Test Site : No.3 OATS
 Test Mode : Mode 1: Transmit - 1Mbps (GFSK) (2441MHz)

Frequency MHz	Correct Factor dB	Reading Level dB μ V	Measurement Level dB μ V/m	Margin dB	Limit dB μ V/m
Horizontal					
198.780	-10.661	48.710	38.049	-5.451	43.500
472.320	0.637	37.824	38.461	-7.539	46.000
623.640	1.959	37.038	38.997	-7.003	46.000
695.420	3.438	35.594	39.032	-6.968	46.000
846.740	5.741	34.228	39.969	-6.031	46.000
978.660	6.754	32.113	38.867	-15.133	54.000
Vertical					
297.720	-7.143	42.212	35.070	-10.930	46.000
472.320	-4.613	42.555	37.942	-8.058	46.000
577.080	-5.661	41.099	35.438	-10.562	46.000
695.420	1.878	35.357	37.235	-8.765	46.000
912.700	1.762	36.944	38.706	-7.294	46.000
968.960	8.191	29.772	37.963	-16.037	54.000

Note:

1. All Readings below 1GHz are Quasi-Peak, above 1GHz are performed with peak and/or average measurements as necessary.
2. Peak measurements: RBW = 1MHz, VBW = 3 MHz, Sweep: Auto.
3. Average measurements: RBW = 1MHz, VBW = 10 Hz, Sweep: Auto.
4. Measurement Level = Reading Level + Correct Factor.
5. Correct Factor = Antenna factor + Cable loss – Amplifier gain.
6. The average measurement was not performed when the peak measured data under the limit of average detection.
7. The emission levels of other frequencies are very lower than the limit and not show in test report.

Product : Barcode Printer
 Test Item : General Radiated Emission
 Test Site : No.3 OATS
 Test Mode : Mode 2: Transmit - 3Mbps (8DPSK) (2441MHz)

Frequency MHz	Correct Factor dB	Reading Level dB μ V	Measurement Level dB μ V/m	Margin dB	Limit dB μ V/m
Horizontal					
173.560	-9.954	47.418	37.465	-6.035	43.500
268.620	-4.942	43.004	38.062	-7.938	46.000
396.660	-2.296	42.445	40.149	-5.851	46.000
623.640	1.959	38.840	40.799	-5.201	46.000
716.760	3.537	36.755	40.292	-5.708	46.000
978.660	6.754	36.643	43.397	-10.603	54.000
Vertical					
297.720	-7.143	43.204	36.062	-9.938	46.000
363.680	-2.393	37.194	34.801	-11.199	46.000
520.820	-0.298	39.655	39.357	-6.643	46.000
695.420	1.878	38.392	40.270	-5.730	46.000
895.240	1.688	39.635	41.322	-4.678	46.000
968.960	8.191	29.968	38.159	-15.841	54.000

Note:

1. All Readings below 1GHz are Quasi-Peak, above 1GHz are performed with peak and/or average measurements as necessary.
2. Peak measurements: RBW = 1MHz, VBW = 3 MHz, Sweep: Auto.
3. Average measurements: RBW = 1MHz, VBW = 10 Hz, Sweep: Auto.
4. Measurement Level = Reading Level + Correct Factor.
5. Correct Factor = Antenna factor + Cable loss – Amplifier gain.
6. The average measurement was not performed when the peak measured data under the limit of average detection.
7. The emission levels of other frequencies are very lower than the limit and not show in test report.

5. RF Antenna Conducted Test

5.1. Test Equipment

Equipment	Manufacturer	Model No./Serial No.	Last Cal.
Spectrum Analyzer	R&S	FSP40 / 100170	Jun., 2014
Spectrum Analyzer	Agilent	E4407B / US39440758	Jun., 2014
X Spectrum Analyzer	Agilent	N9010A / MY48030495	Apr., 2014

Note: 1. All equipments are calibrated every one year.
 2. The test instruments Marked “X” are used to measure the final test results.

5.2. Test Setup

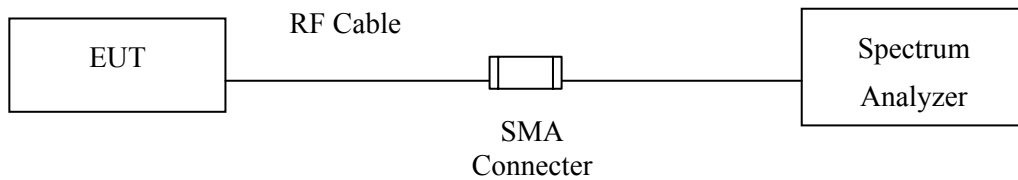

5.3. Limits

According to FCC Section 15.247(d). In any 100 kHz bandwidth outside the frequency band in which the spread spectrum or digitally modulated intentional radiator is operating, the radio frequency power that is produced by the intentional radiator shall be at least 20 dB below that in the 100 kHz bandwidth within the band that contains the highest level of the desired power, based on either an RF conducted or measurement, provided the transmitter demonstrates compliance with the peak conducted power limits. If the transmitter complies with the conducted power limits based on the use of RMS averaging over a time interval, the attenuation required under this paragraph shall be 30 dB instead of 20 dB.

5.4. Test Procedure

The EUT was setup to ANSI C63.10: 2013; tested to FHSS test procedure of FCC Public Notice DA 00-705 for compliance to FCC 47CFR 15.247 requirements.

5.5. Uncertainty

± 150Hz

5.6. Test Result of RF Antenna Conducted Test

Product : Barcode Printer
 Test Item : RF Antenna Conducted Test
 Test Site : No.3 OATS
 Test Mode : Mode 1: Transmit - 1Mbps (GFSK)

Figure Channel 00:

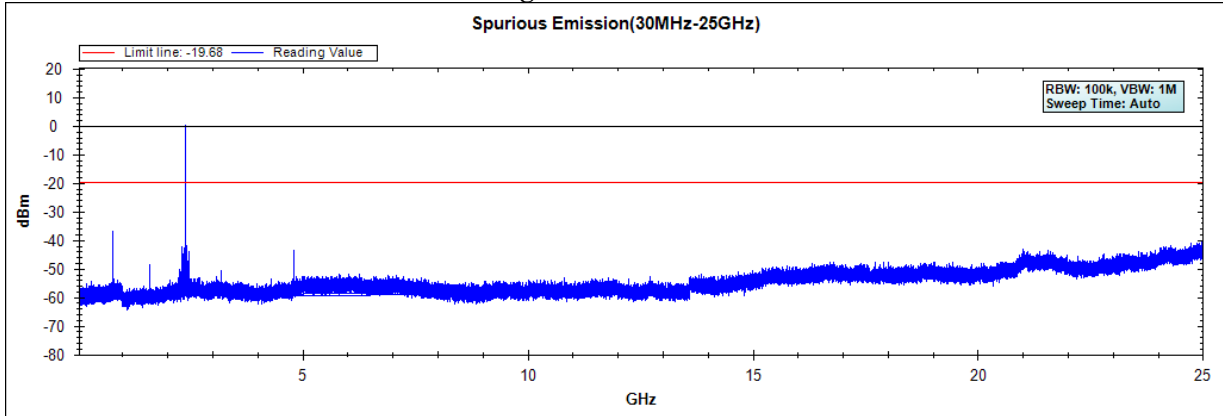

Figure Channel 39:

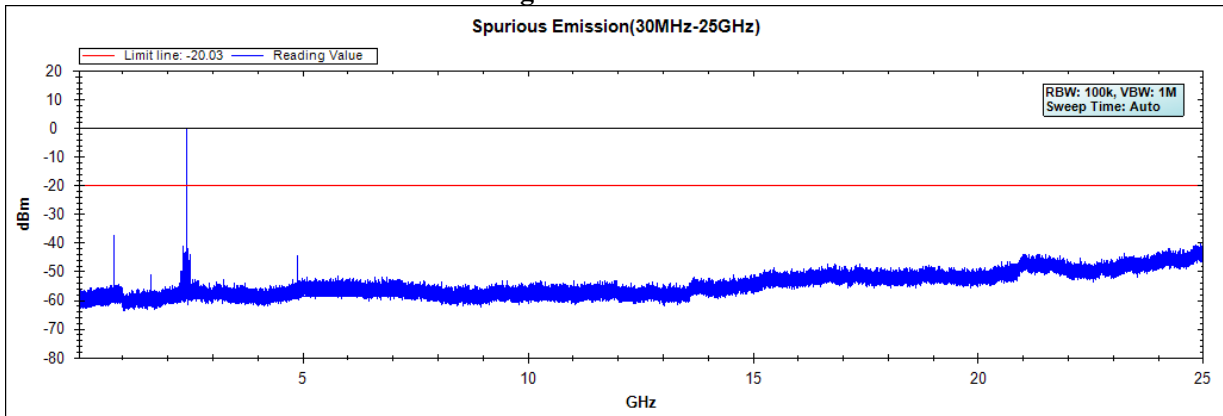
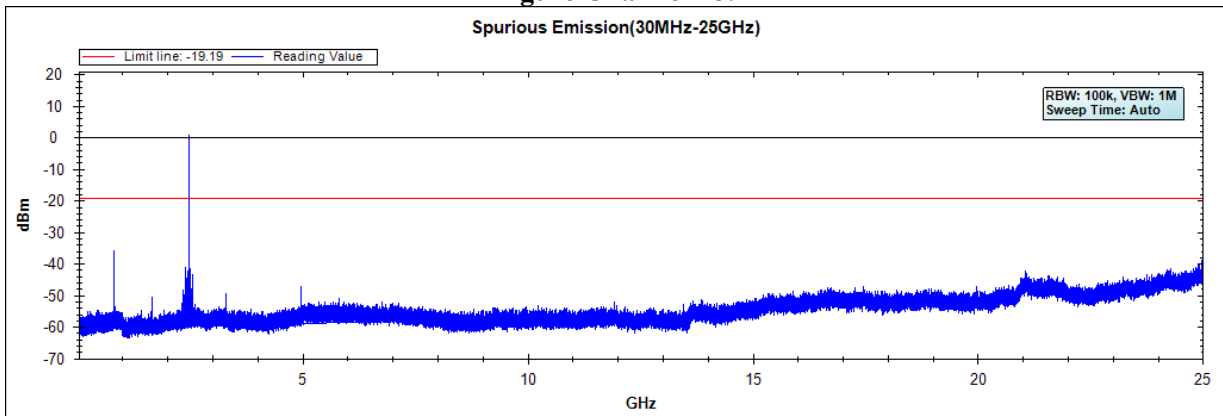

Figure Channel 78:



Note: The above test pattern is synthesized by multiple of the frequency range.

Product : Barcode Printer
Test Item : RF Antenna Conducted Test
Test Site : No.3 OATS
Test Mode : Mode 2: Transmit - 3Mbps (8DPSK)

Figure Channel 00:

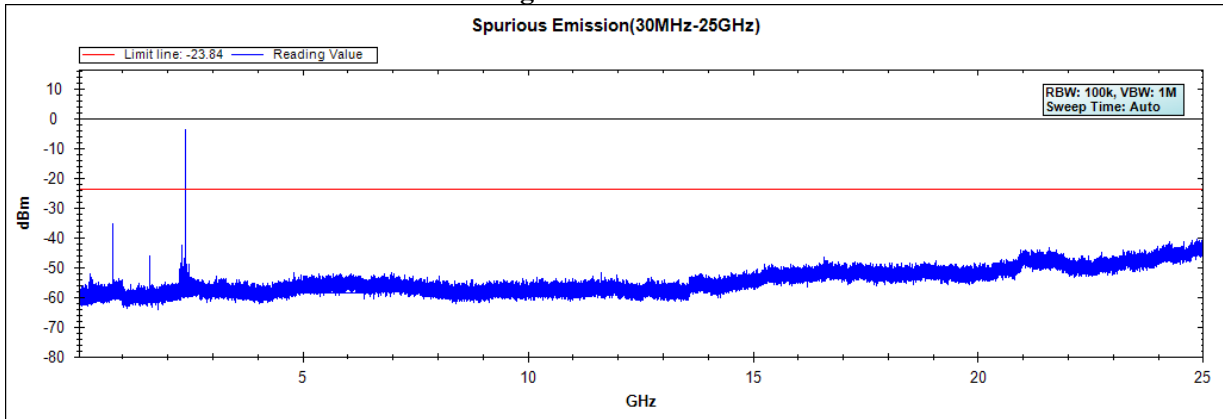

Figure Channel 39:

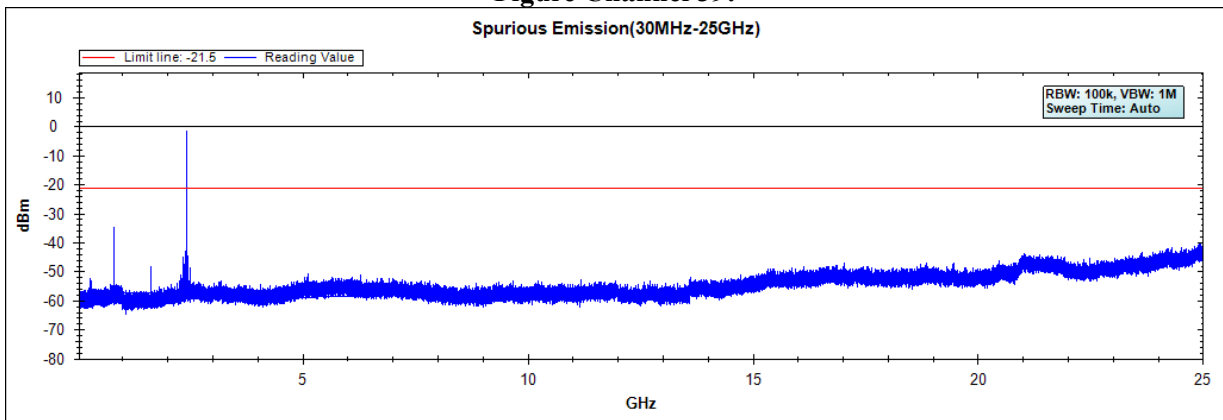
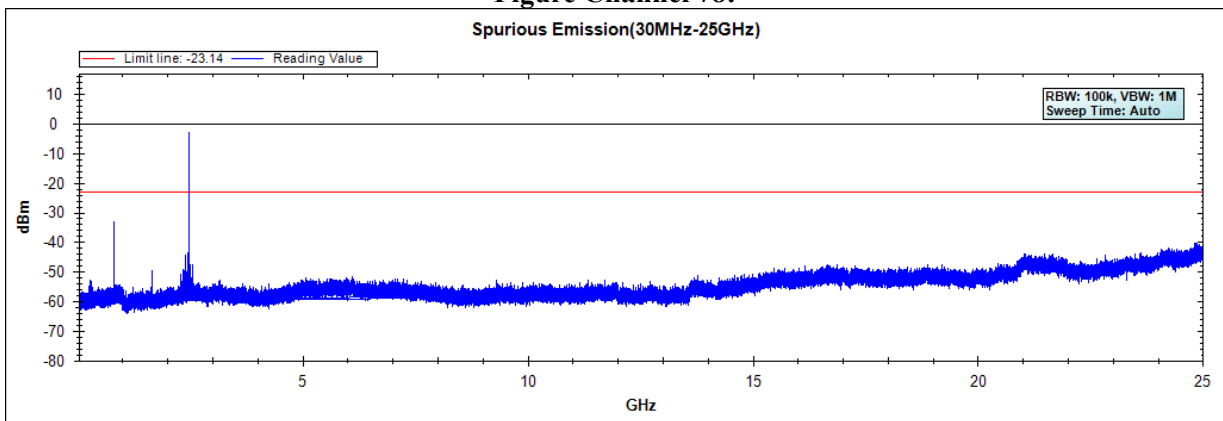

Figure Channel 78:



Note: The above test pattern is synthesized by multiple of the frequency range.

6. Band Edge

6.1. Test Equipment

RF Conducted Measurement

The following test equipments are used during the band edge tests:

	Equipment	Manufacturer	Model No./Serial No.	Last Cal.
	Spectrum Analyzer	R&S	FSP40 / 100170	Jun., 2014
	Spectrum Analyzer	Agilent	E4407B / US39440758	Jun., 2014
X	Spectrum Analyzer	Agilent	N9010A / MY48030495	Apr., 2014

RF Radiated Measurement:

The following test equipments are used during the band edge tests:

Test Site		Equipment	Manufacturer	Model No./Serial No.	Last Cal.
☒CB # 8	X	Spectrum Analyzer	R&S	FSP40/ 100339	Oct., 2014
	X	Horn Antenna	ETS-Lindgren	3117/ 35205	Mar., 2014
	X	Horn Antenna	Schwarzbeck	BBHA9170/209	Jan., 2015
	X	Horn Antenna	TRC	AH-0801/95051	Aug., 2014
	X	Pre-Amplifier	EMCI	EMC012630SE/980210	Jan., 2015
	X	Pre-Amplifier	MITEQ	JS41-001040000-58-5P/153945	Jul., 2014
	X	Pre-Amplifier	NARDA	DBL-1840N506/013	Jul., 2014

- Note:
1. All equipments are calibrated every one year.
 2. The test instruments marked by “X” are used to measure the final test results.

6.2. Test Setup

RF Conducted Measurement

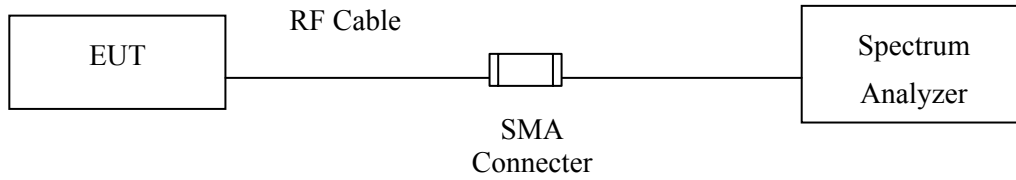

RF Radiated Measurement:

Above 1GHz

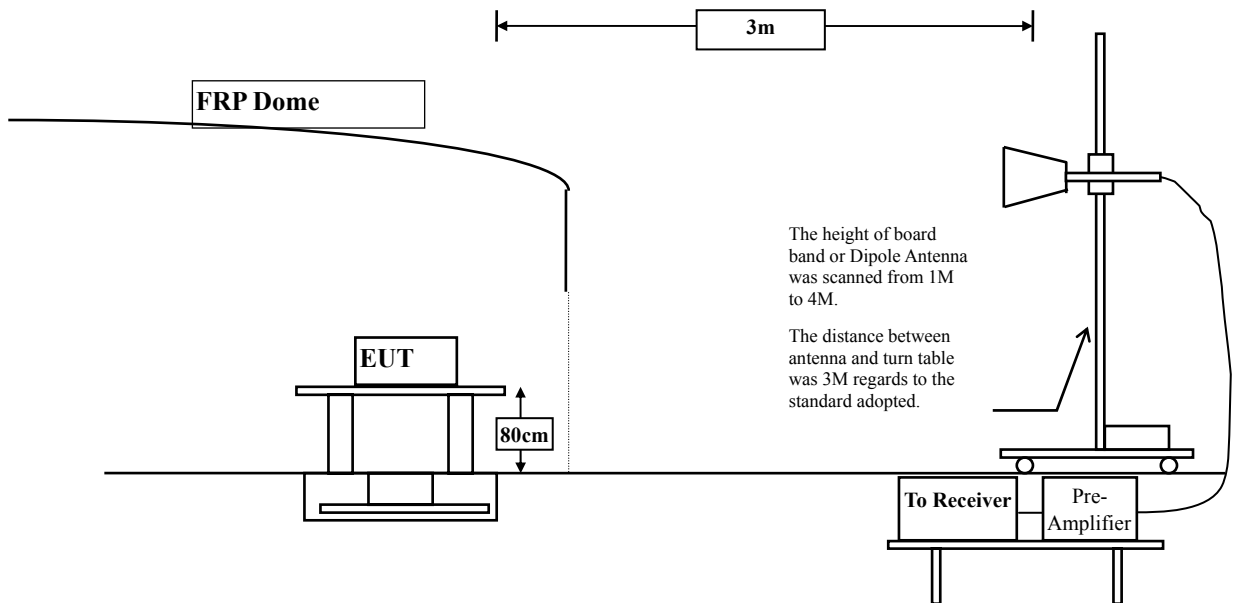

6.3. Limit

In any 100 kHz bandwidth outside the frequency band in which the spread spectrum intentional radiator is operating, the radio frequency power that is produced by the intentional radiator shall be at least 20 dB below that in the 100 kHz bandwidth within the band that contains the highest level of the desired power, based on either an RF conducted or a radiated measurement. Attenuation below the general limits specified in Section 15.209(a) is not required. In addition, radiated emissions which fall in the restricted bands, as defined in Section 15.205(a), must also comply with the radiated emission limits specified in Section 15.209(a) (see Section 15.205(c)).

6.4. Test Procedure

The EUT and its simulators are placed on a turn table which is 0.8 meter above ground. The turn table can rotate 360 degrees to determine the position of the maximum emission level. The EUT was positioned such that the distance from antenna to the EUT was 3 meters.

The antenna can move up and down between 1 meter and 4 meters to find out the maximum emission level.

Both horizontal and vertical polarization of the antenna are set on measurement. In order to find the maximum emission, all of the interface cables must be manipulated according to ANSI C63.10: 2013 on radiated measurement.

The bandwidth below 1GHz setting on the field strength meter is 120 kHz, above 1GHz are 1 MHz. The EUT was setup to ANSI C63.10, 2013; tested to FHSS test procedure of FCC Public Notice DA 00-705 for compliance to FCC 47CFR 15.247 requirements.

6.5. Uncertainty

± 3.9 dB above 1GHz

± 3.8 dB below 1GHz

6.6. Test Result of Band Edge

Product : Barcode Printer
 Test Item : Band Edge
 Test Site : No.3 OATS
 Test Mode : Mode 1: Transmit - 1Mbps (GFSK)

Fundamental Filed Strength

Antenna Pole	Frequency [MHz]	Correction Factor [dB/m]	Reading Level [dBuV]	Emission Level [dBuV/m]	Detector
Horizontal	2402	31.573	64.006	95.58	Peak
Horizontal	2402	31.573	53.062	84.636	Average
Vertical	2402	30.917	58.747	89.664	Peak
Vertical	2402	30.917	48.876	79.793	Average

Note: 1: Spectrum Analyzer setting:

Peak detector: RBW=1MHz, VBW=1MHz

Average detector: RBW=1MHz, VBW=10Hz

Band Edge Test Data

Antenna Pole	Test Frequency (MHz)	Fundamental (dBuV/m)	Δ (dB)	Band Edge Field Strength (dBuV/m)	Limit (dBuV/m)	Detector
Horizontal	2376.2	95.58	38.918	56.662	74.000	Peak
Horizontal	2376.2	84.636	33.744	50.892	54.000	Average
Vertical	2376.2	89.664	38.918	50.746	74.000	Peak
Vertical	2376.2	79.793	33.744	46.049	54.000	Average

Note:

The Band Edge Field Strength was calculated using the Fundamental and Conducted Band Edge measurements per the Marker-Delta Method with the following formula:

Band Edge field Strength = F - Δ

F = Fundamental field Strength (Peak or Average)

Δ = Conducted Band Edge Delta (Peak or Average)

Peak Detector of conducted Band Edge Delta

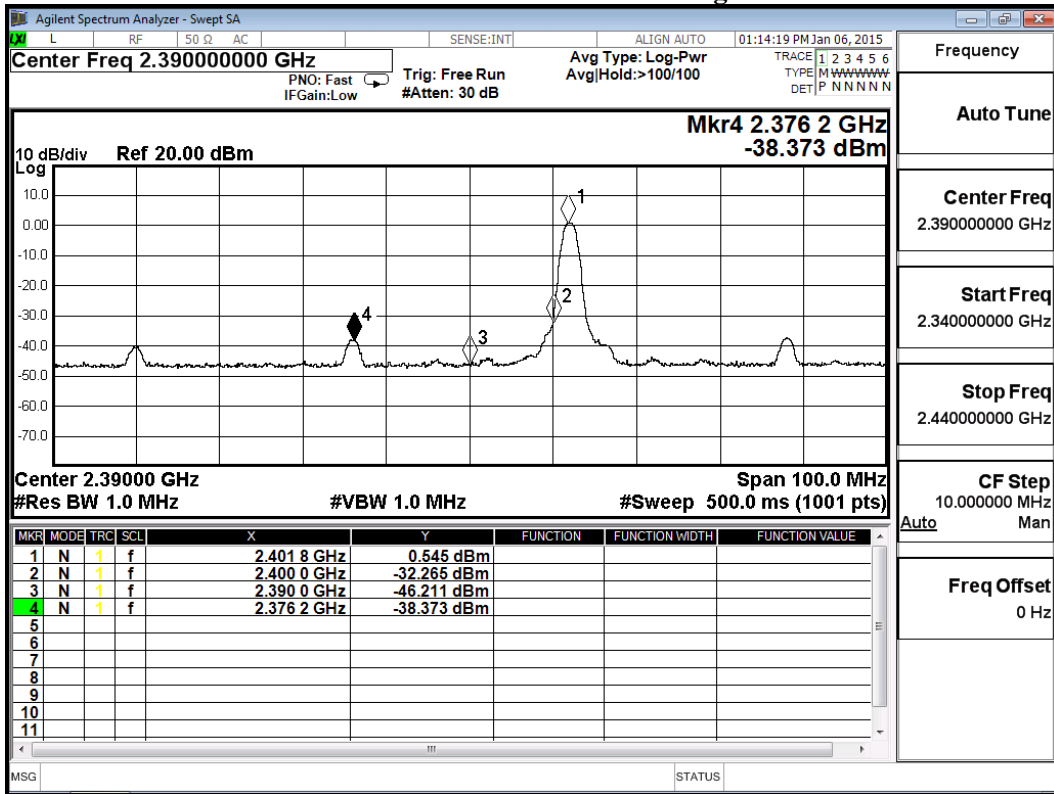

Average Detector of conducted Band Edge Delta

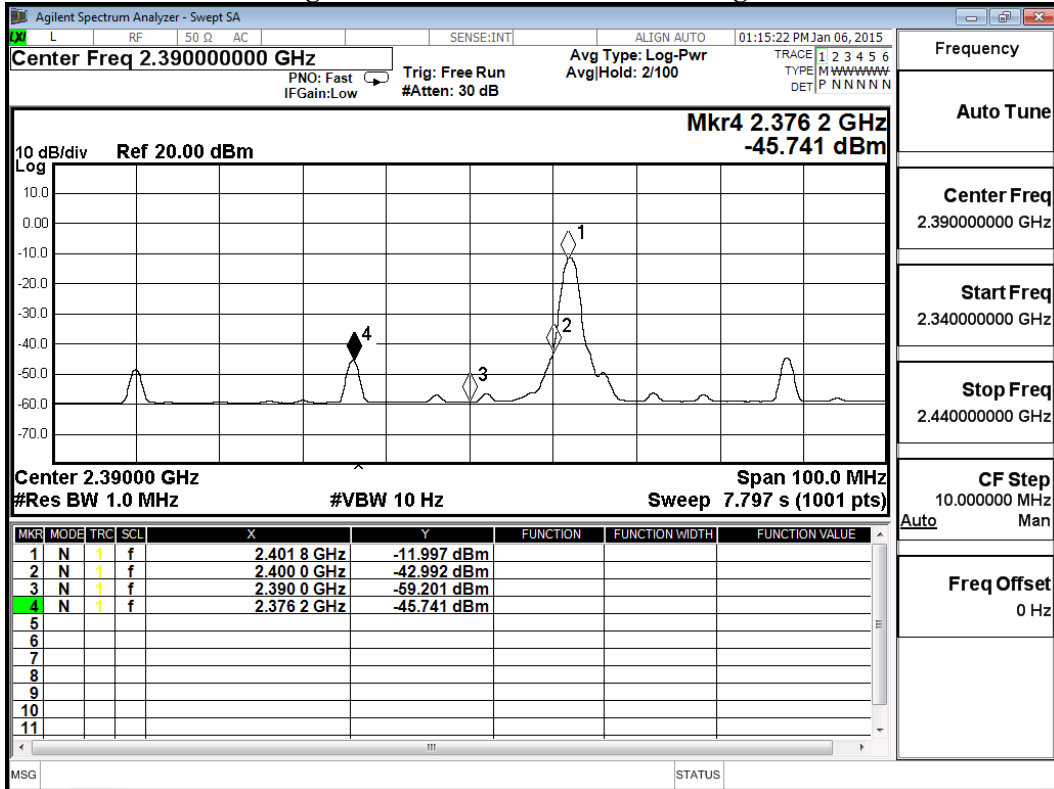

Product : Barcode Printer
 Test Item : Band Edge
 Test Site : No.3 OATS
 Test Mode : Mode 1: Transmit - 1Mbps (GFSK)

Fundamental Filed Strength

Antenna Pole	Frequency [MHz]	Correction Factor [dB/m]	Reading Level [dBuV]	Emission Level [dBuV/m]	Detector
Horizontal	2479.9	32.155	67.281	99.436	Peak
Horizontal	2480.1	-0.58	85.759	85.179	Average
Vertical	2479.9	31.411	62.902	94.313	Peak
Vertical	2480.1	-1.324	81.241	79.917	Average

Note: 1: Spectrum Analyzer setting:

Peak detector: RBW=1MHz, VBW=1MHz

Average detector: RBW=1MHz, VBW=10Hz

Band Edge Test Data

Antenna Pole	Test Frequency (MHz)	Fundamental (dBuV/m)	Δ (dB)	Band Edge Field Strength (dBuV/m)	Limit (dBuV/m)	Detector
Horizontal	2483.5	99.436	38.457	60.979	74.000	Peak
Horizontal	2483.5	85.179	33.762	51.417	54.000	Average
Vertical	2483.5	94.313	38.457	55.856	74.000	Peak
Vertical	2483.5	79.917	33.762	46.155	54.000	Average

Note:

The Band Edge Field Strength was calculated using the Fundamental and Conducted Band Edge measurements per the Marker-Delta Method with the following formula:

Band Edge field Strength = F - Δ

F = Fundamental field Strength (Peak or Average)

Δ = Conducted Band Edge Delta (Peak or Average)

Peak Detector of conducted Band Edge Delta

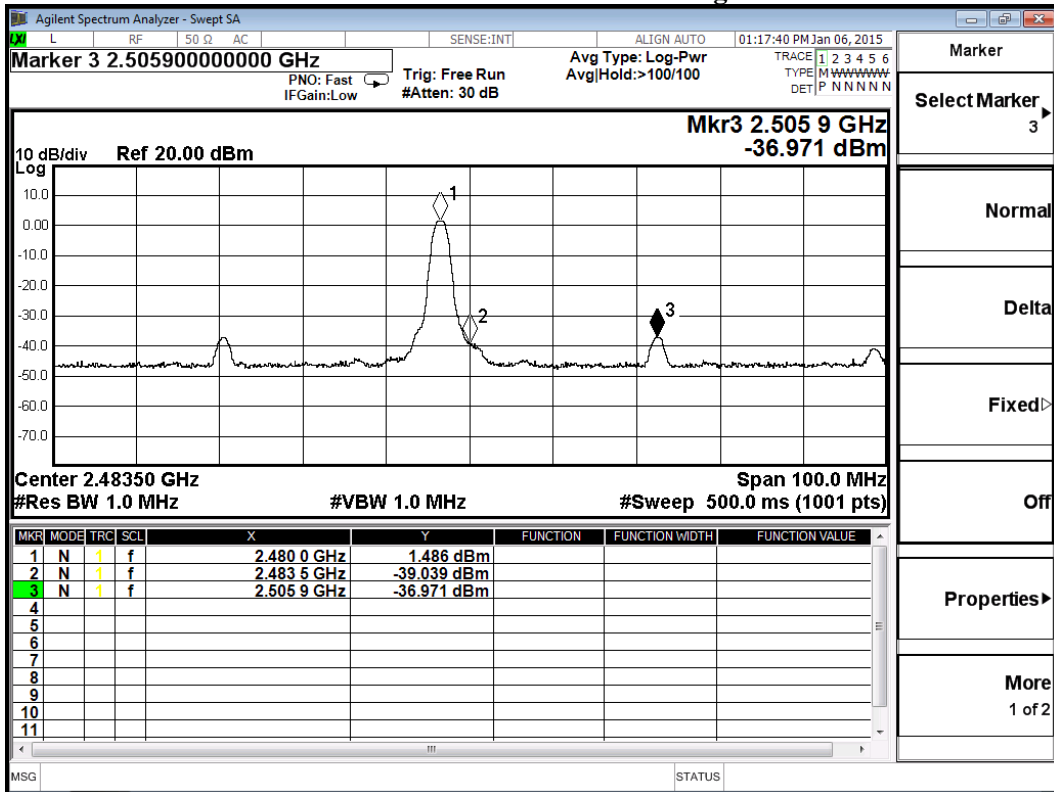

Average Detector of conducted Band Edge Delta

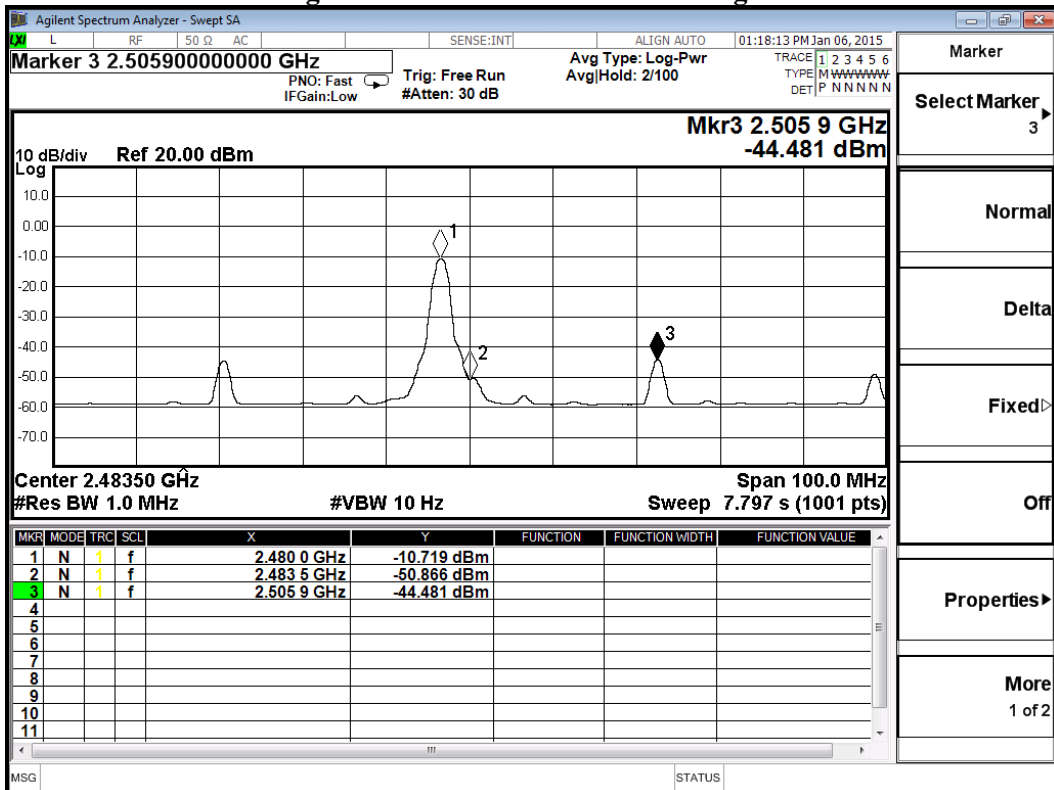

Product : Barcode Printer
 Test Item : Band Edge
 Test Site : No.3 OATS
 Test Mode : Mode 2: Transmit - 3Mbps (8DPSK)

Fundamental Filed Strength

Antenna Pole	Frequency [MHz]	Correction Factor [dB/m]	Reading Level [dBuV]	Emission Level [dBuV/m]	Detector
Horizontal	2402	31.573	62.168	93.742	Peak
Horizontal	2402	31.573	49.477	81.051	Average
Vertical	2402	30.917	56.38	87.297	Peak
Vertical	2402	30.917	44.656	75.573	Average

Note: 1: Spectrum Analyzer setting:

Peak detector: RBW=1MHz, VBW=1MHz

Average detector: RBW=1MHz, VBW=10Hz

Band Edge Test Data

Antenna Pole	Test Frequency (MHz)	Fundamental (dBuV/m)	Δ (dB)	Band Edge Field Strength (dBuV/m)	Limit (dBuV/m)	Detector
Horizontal	2375.9	93.742	38.753	54.989	74.000	Peak
Horizontal	2375.9	81.051	33.078	47.973	54.000	Average
Vertical	2375.9	87.297	38.753	48.544	74.000	Peak
Vertical	2375.9	75.573	33.078	42.495	54.000	Average

Note:

The Band Edge Field Strength was calculated using the Fundamental and Conducted Band Edge measurements per the Marker-Delta Method with the following formula:

Band Edge field Strength = F - Δ

F = Fundamental field Strength (Peak or Average)

Δ = Conducted Band Edge Delta (Peak or Average)

Peak Detector of conducted Band Edge Delta

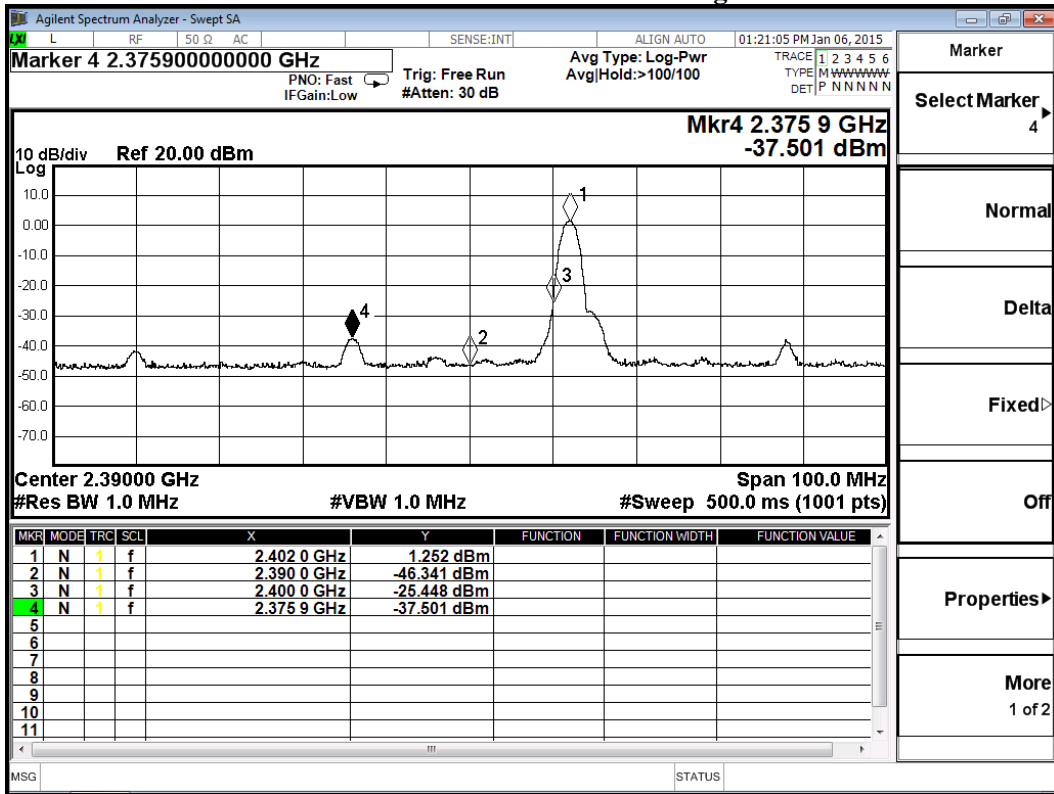

Average Detector of conducted Band Edge Delta

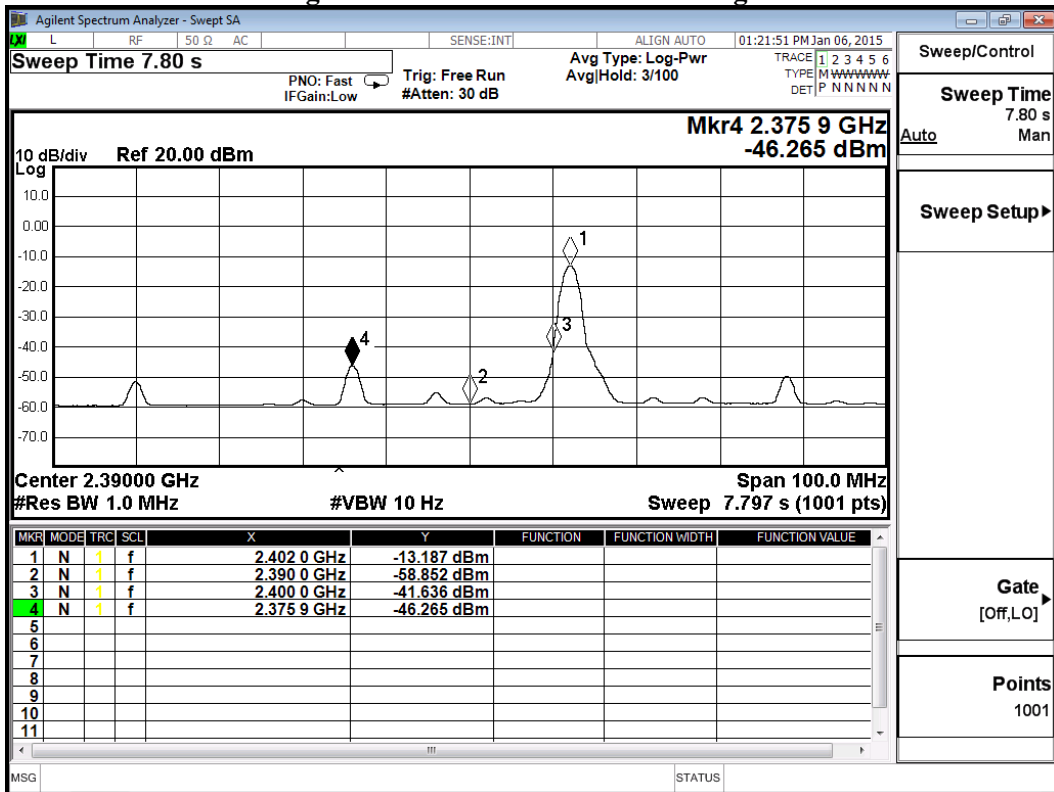

Product : Barcode Printer
 Test Item : Band Edge
 Test Site : No.3 OATS
 Test Mode : Mode 2: Transmit - 3Mbps (8DPSK)

Fundamental Filed Strength

Antenna Pole	Frequency [MHz]	Correction Factor [dB/m]	Reading Level [dBuV]	Emission Level [dBuV/m]	Detector
Horizontal	2480.1	32.157	64.977	97.133	Peak
Horizontal	2480.3	-0.579	81.599	81.02	Average
Vertical	2479.9	31.411	60.043	91.454	Peak
Vertical	2480.1	-1.324	76.682	75.358	Average

Note: 1: Spectrum Analyzer setting:

Peak detector: RBW=1MHz, VBW=1MHz

Average detector: RBW=1MHz, VBW=10Hz

Band Edge Test Data

Antenna Pole	Test Frequency (MHz)	Fundamental (dBuV/m)	Δ (dB)	Band Edge Field Strength (dBuV/m)	Limit (dBuV/m)	Detector
Horizontal	2483.5	97.133	34.182	62.951	74.000	Peak
Horizontal	2483.5	81.02	35.169	45.851	54.000	Average
Vertical	2483.5	91.454	34.182	57.272	74.000	Peak
Vertical	2483.5	75.358	35.169	40.189	54.000	Average

Note:

The Band Edge Field Strength was calculated using the Fundamental and Conducted Band Edge measurements per the Marker-Delta Method with the following formula:

Band Edge field Strength = F - Δ

F = Fundamental field Strength (Peak or Average)

Δ = Conducted Band Edge Delta (Peak or Average)

Peak Detector of conducted Band Edge Delta

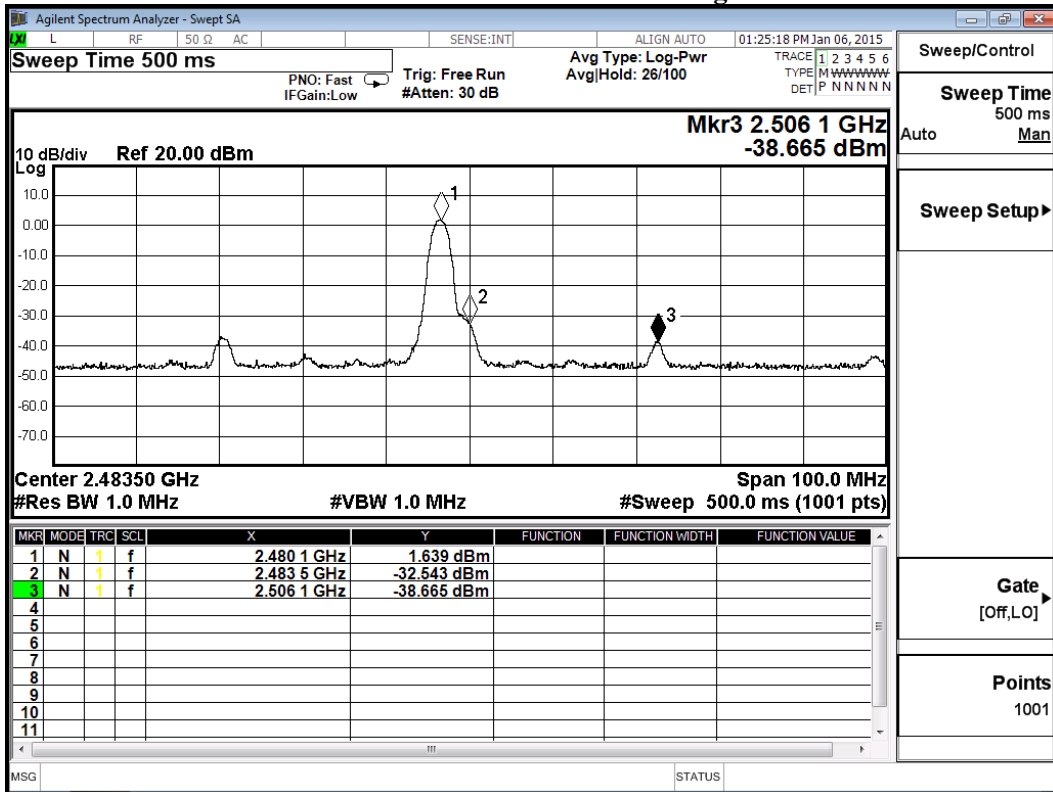

Average Detector of conducted Band Edge Delta

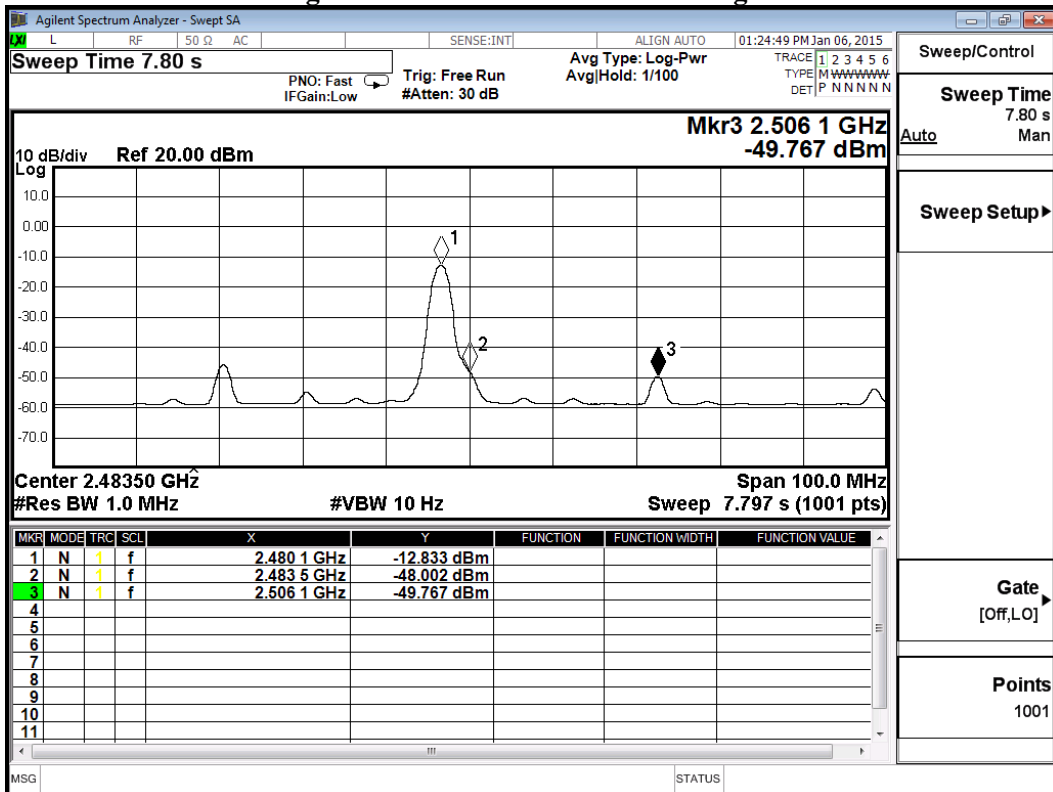

7. Channel Number

7.1. Test Equipment

	Equipment	Manufacturer	Model No./Serial No.	Last Cal.
	Spectrum Analyzer	R&S	FSP40 / 100170	Jun., 2014
	Spectrum Analyzer	Agilent	E4407B / US39440758	Jun., 2014
X	Spectrum Analyzer	Agilent	N9010A / MY48030495	Apr., 2014

Note: 1. All equipments are calibrated every one year.
 2. The test instruments marked by “X” are used to measure the final test results.

7.2. Test Setup

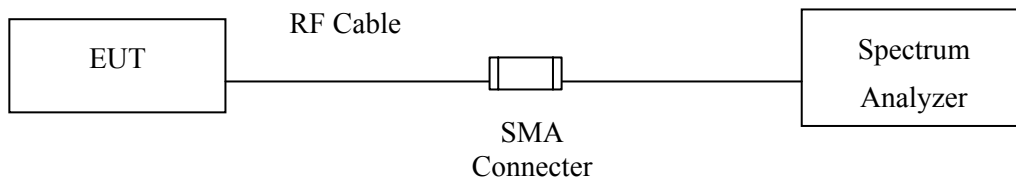

7.3. Limit

Frequency hopping systems operating in the 2400-2483.5 MHz bands shall use at least 75 hopping frequencies.

7.4. Test Procedure

The EUT was setup to ANSI C63.10: 2013; tested to FHSS test procedure of FCC Public Notice DA 00-705 for compliance to FCC 47CFR 15.247 requirements.

7.5. Uncertainty

N/A

7.6. Test Result of Channel Number

Product : Barcode Printer
 Test Item : Channel Number
 Test Site : No.3 OATS
 Test Mode : Mode 1: Transmit - 1Mbps (GFSK)

Frequency Range (MHz)	Measurement (Hopping Channel)	Required Limit (Hopping Channel)	Result
2402 ~ 2480	79	>75	Pass

2402-2421MHz

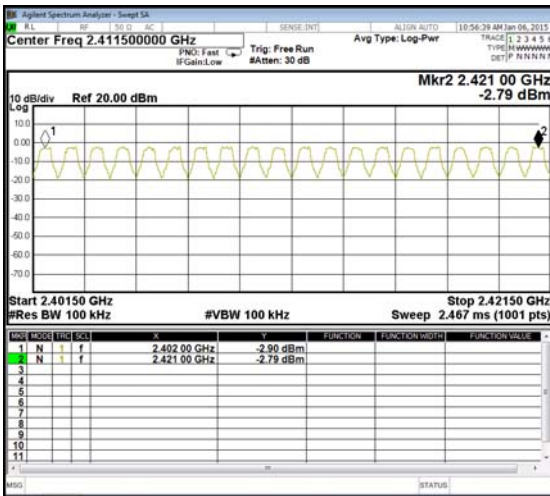

2422-2441MHz

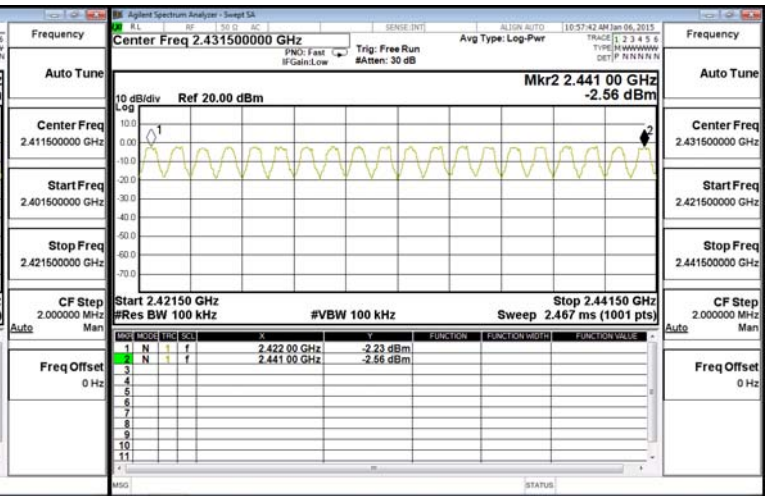

2442-2461MHz

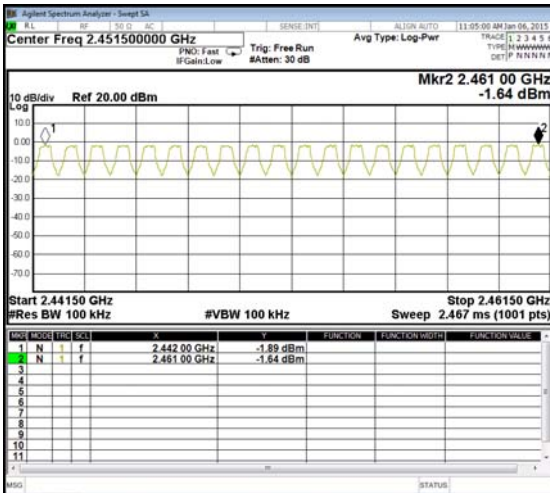

2462-2480MHz

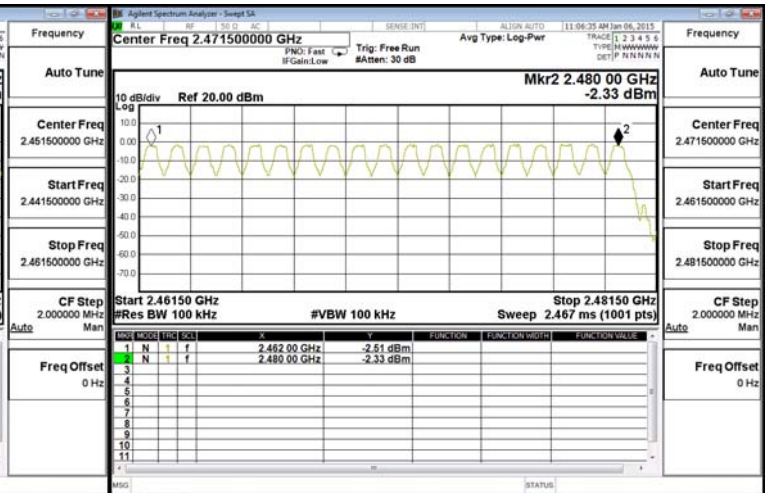

Product : Barcode Printer
 Test Item : Channel Number
 Test Site : No.3 OATS
 Test Mode : Mode 2: Transmit - 3Mbps (8DPSK)

Frequency Range (MHz)	Measurement (Hopping Channel)	Required Limit (Hopping Channel)	Result
2402 ~ 2480	79	>75	Pass

2402-2421MHz

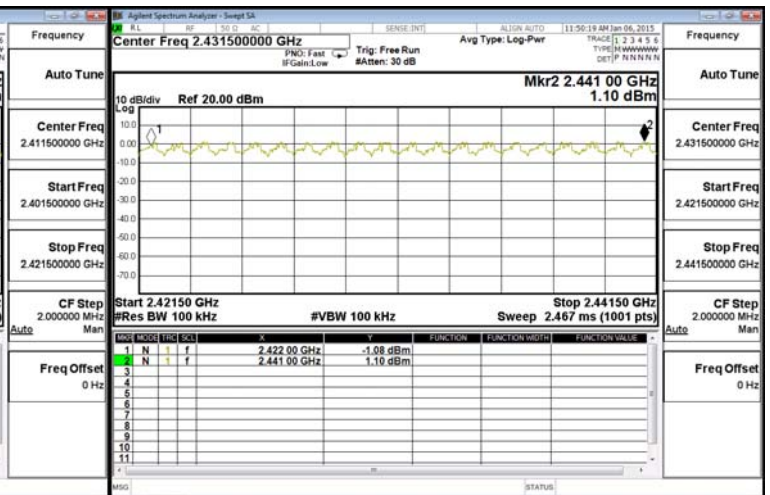
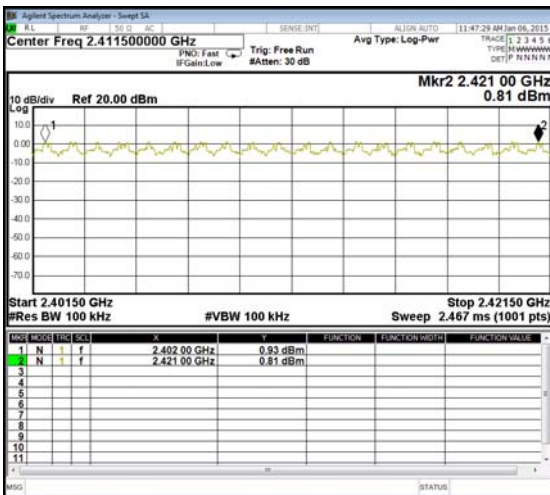

2442-2461MHz

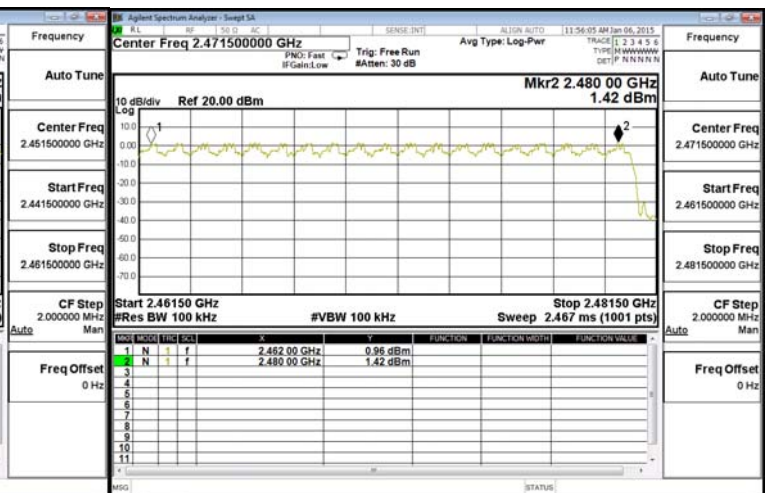
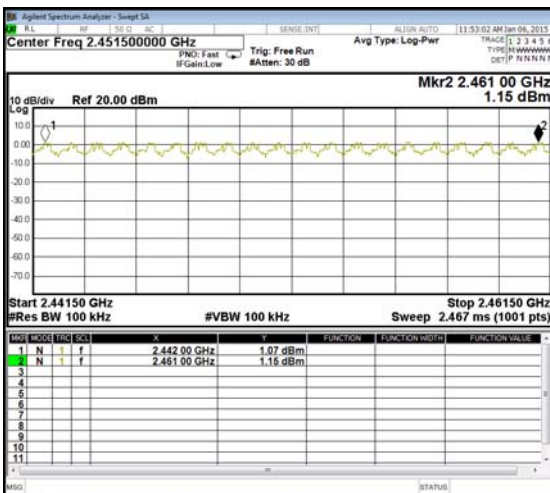

8. Channel Separation

8.1. Test Equipment

	Equipment	Manufacturer	Model No./Serial No.	Last Cal.
	Spectrum Analyzer	R&S	FSP40 / 100170	Jun., 2014
	Spectrum Analyzer	Agilent	E4407B / US39440758	Jun., 2014
X	Spectrum Analyzer	Agilent	N9010A / MY48030495	Apr., 2014

Note: 1. All equipments are calibrated every one year.
 2. The test instruments mark by “X” are used to measure the final test results.

8.2. Test Setup

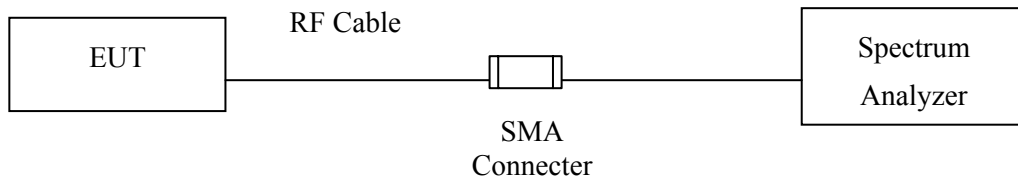

8.3. Limit

Frequency hopping systems shall have hopping channel carrier frequencies separated by a minimum of 25 kHz or the 20 dB bandwidth of the hopping channel, whichever is greater.

8.4. Test Procedure

The EUT was setup to ANSI C63.10: 2013; tested to FHSS test procedure of FCC Public Notice DA 00-705 for compliance to FCC 47CFR 15.247 requirements.

8.5. Uncertainty

± 150Hz

8.6. Test Result of Channel Separation

Product : Barcode Printer
 Test Item : Channel Separation
 Test Site : No.3 OATS
 Test Mode : Mode 1: Transmit - 1Mbps (GFSK)

Channel No.	Frequency (MHz)	Measurement Level (kHz)	Limit (kHz)	Limit of (2/3)*20dB Bandwidth (kHz)	Result
00	2402	1000	>25 kHz	766.7	Pass
39	2441	1000	>25 kHz	766.7	Pass
78	2480	1000	>25 kHz	766.7	Pass

NOTE: The 20dB Bandwidth is refer to section 10.

Channel 00 2402MHz

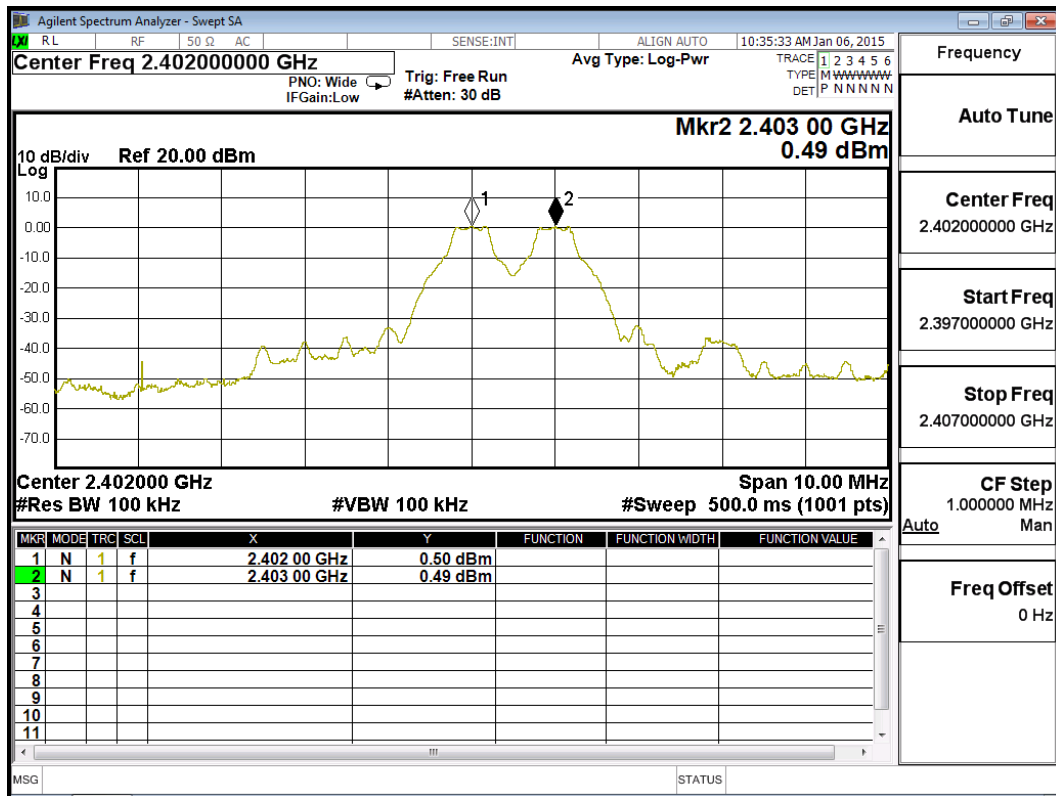

Channel 39 2441MHz

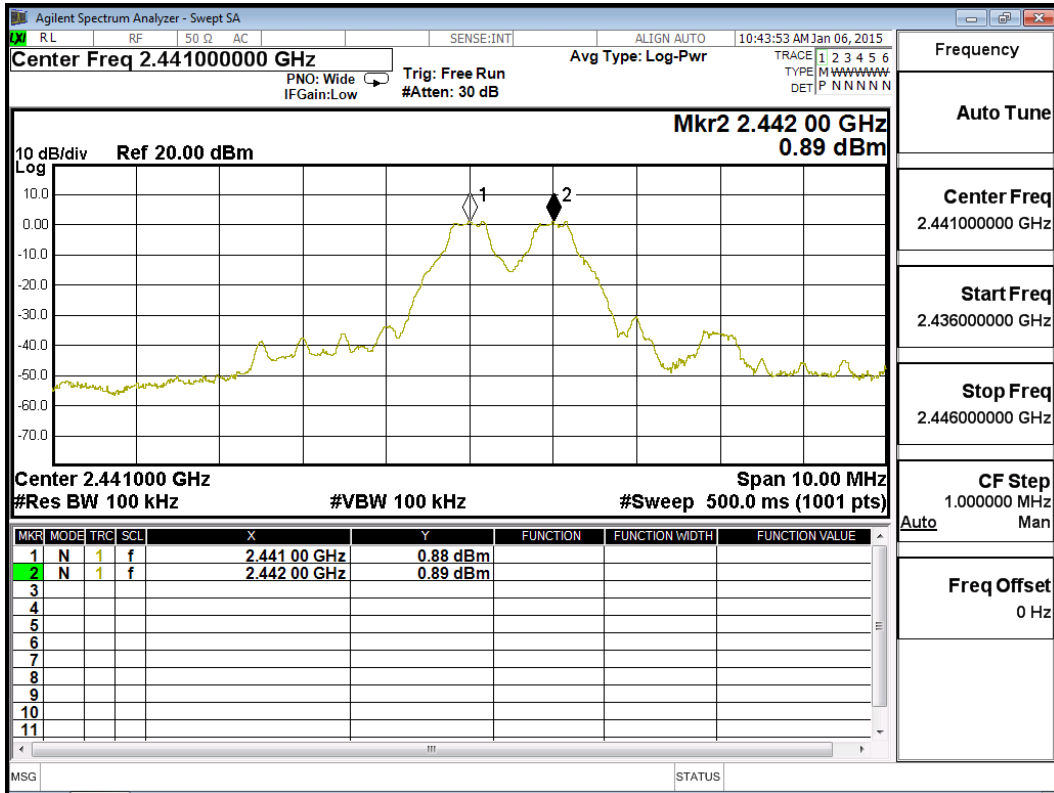

Channel 78 2480 MHz

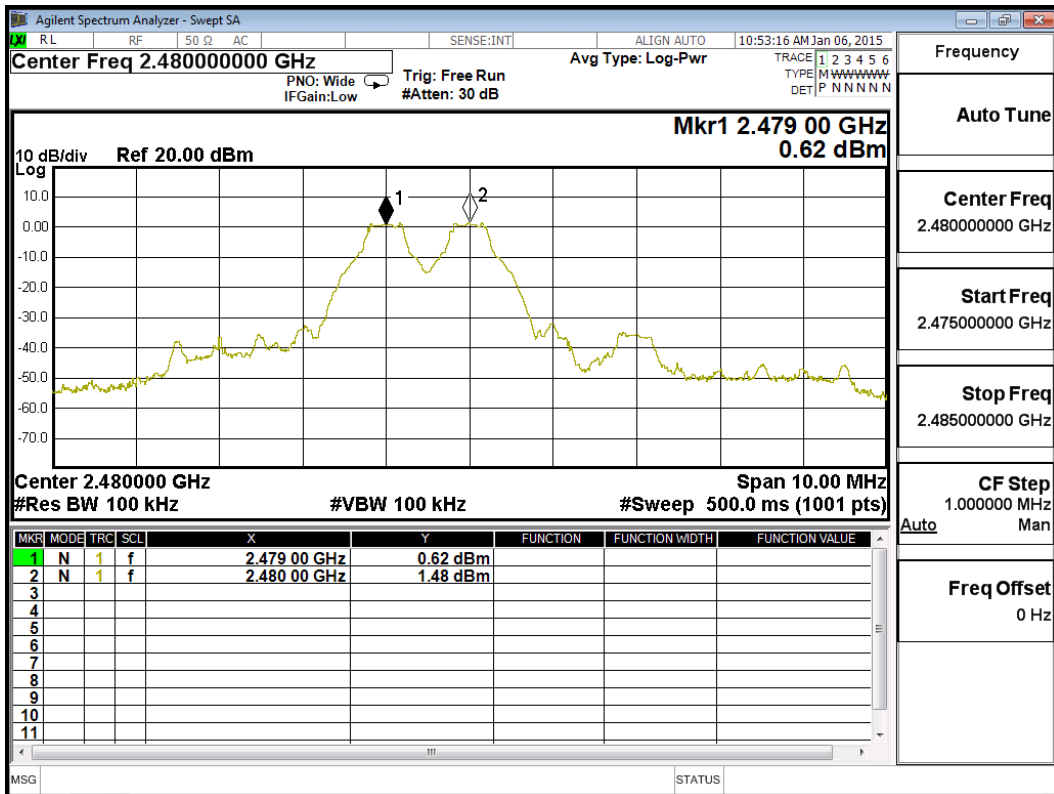

Product : Barcode Printer
 Test Item : Channel Separation
 Test Site : No.3 OATS
 Test Mode : Mode 2: Transmit - 3Mbps (8DPSK)

Channel No.	Frequency (MHz)	Measurement Level (kHz)	Limit (kHz)	Limit of (2/3)*20dB Bandwidth (kHz)	Result
00	2402	1000	>25 kHz	926.7	Pass
39	2441	1000	>25 kHz	926.7	Pass
78	2480	1000	>25 kHz	926.7	Pass

NOTE: The 20dB Bandwidth is refer to section 10.

Channel 00 2402MHz

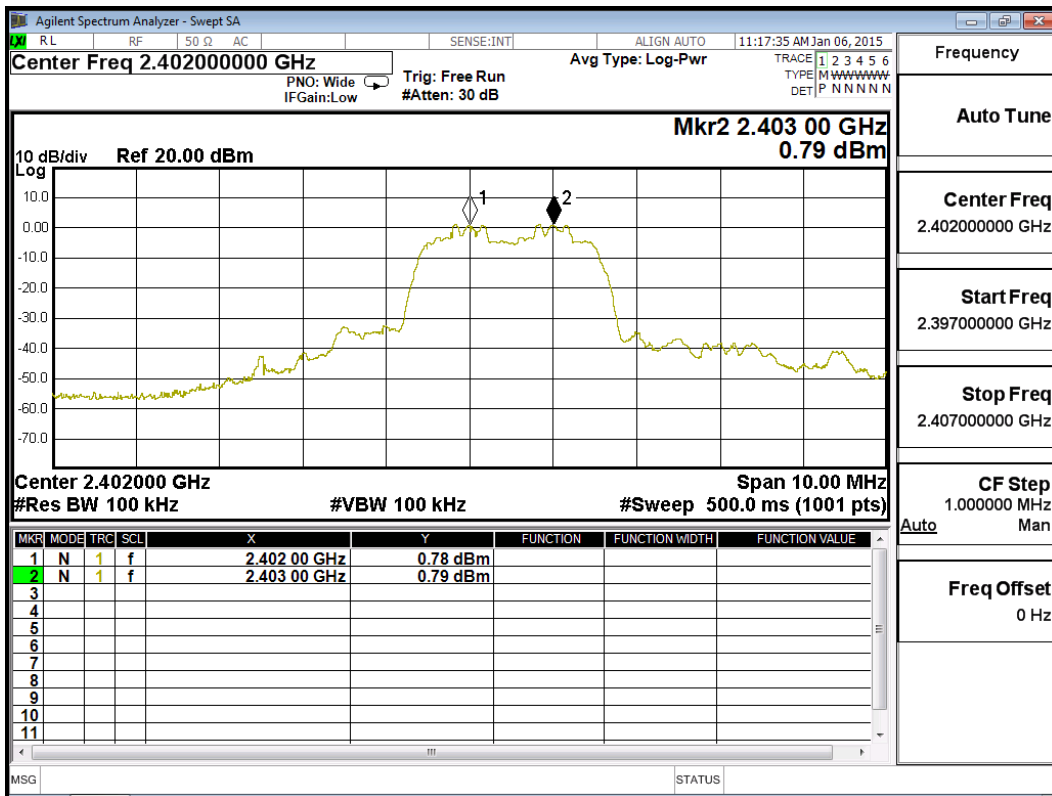

Channel 39 2441MHz

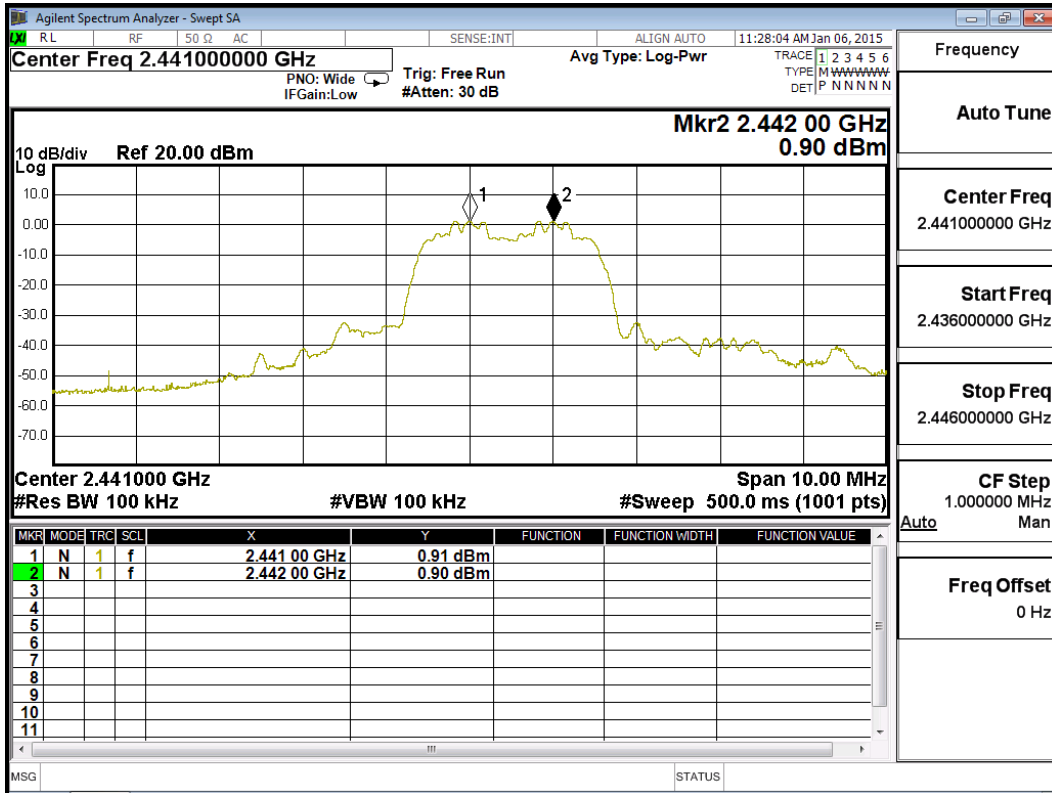

Channel 78 2480 MHz

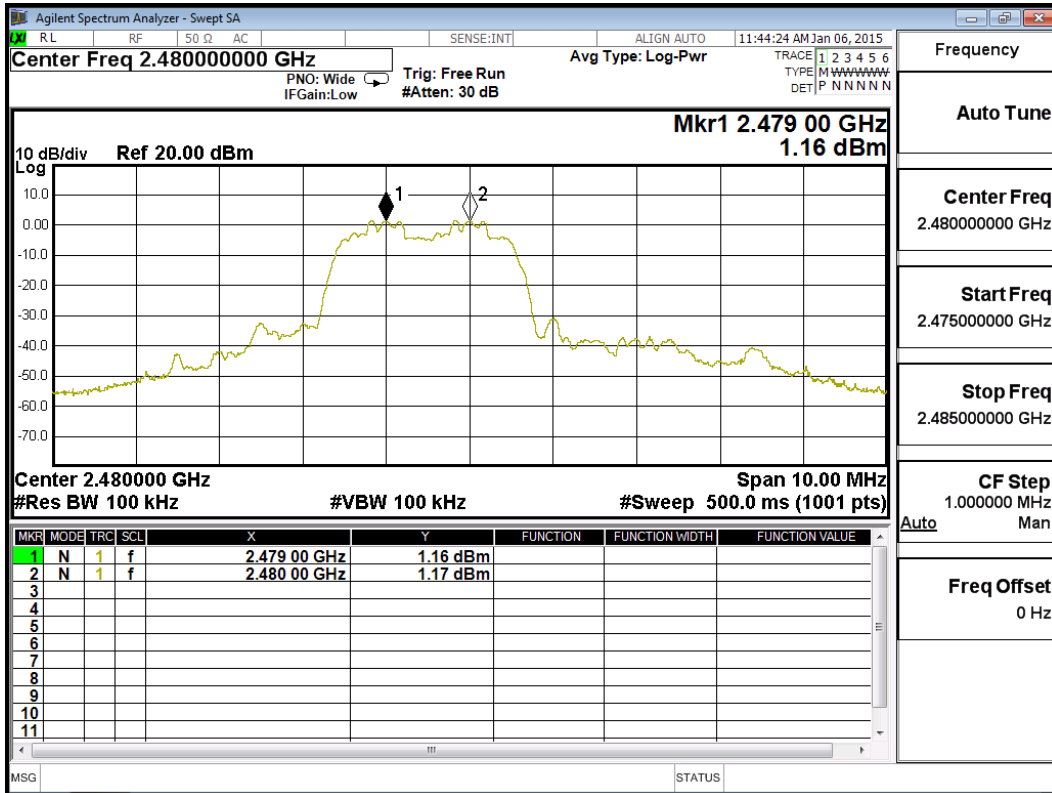

9. Dwell Time

9.1. Test Equipment

	Equipment	Manufacturer	Model No./Serial No.	Last Cal.
	Spectrum Analyzer	R&S	FSP40 / 100170	Jun., 2014
	Spectrum Analyzer	Agilent	E4407B / US39440758	Jun., 2014
X	Spectrum Analyzer	Agilent	N9010A / MY48030495	Apr., 2014

Note: 1. All equipments are calibrated every one year.
 2. The test instruments marked by “X” are used to measure the final test results.

9.2. Test Setup

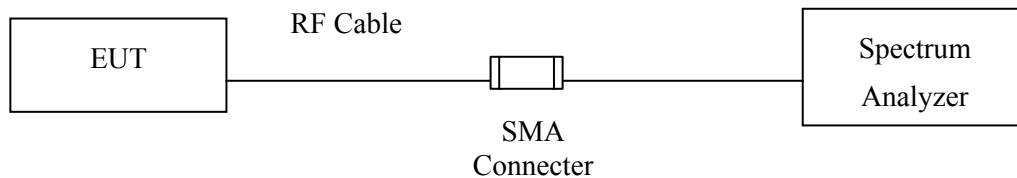

9.3. Limit

The dwell time shall be the average time of occupancy on any frequency shall not be greater than 0.4 seconds within a 30 second period.

9.4. Test Procedure

The EUT was setup to ANSI C63.10: 2013; tested to FHSS test procedure of FCC Public Notice DA 00-705 for compliance to FCC 47CFR 15.247 requirements.

9.5. Uncertainty

± 25msec

9.6. Test Result of Dwell Time

Product : Barcode Printer
 Test Item : Dwell Time
 Test Site : No.3 OATS
 Test Mode : Mode 1: Transmit - 1Mbps (GFSK) (Channel 00,39,78 –DH5)

Frequency (MHz)	Time slot length (ms)	Hopping of Number	Sweep time (ms)	Duty cycle	Dwell Time (Sec)	Limit (Sec)	Result
2402	2.900	14	50	0.81	0.325	0.4	Pass
2441	2.900	14	50	0.81	0.325	0.4	Pass
2480	2.900	13	50	0.75	0.302	0.4	Pass

Duty cycle = ((Time slot length(ms)*Hopping of Number) / Sweep time (ms)

Dwell time = (Duty cycle /79) * (79*0.4)

CH 00 Time Interval between hops

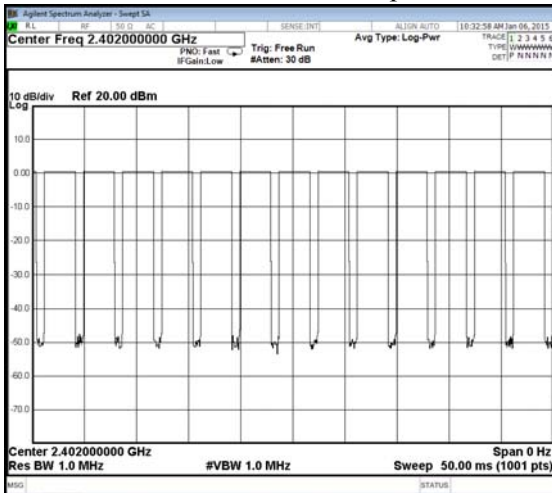

CH 00 Transmission Time

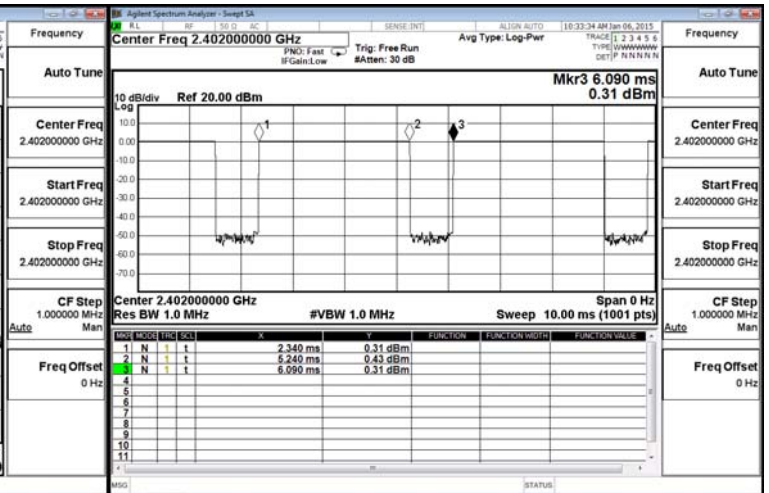

CH39 Time Interval between hops

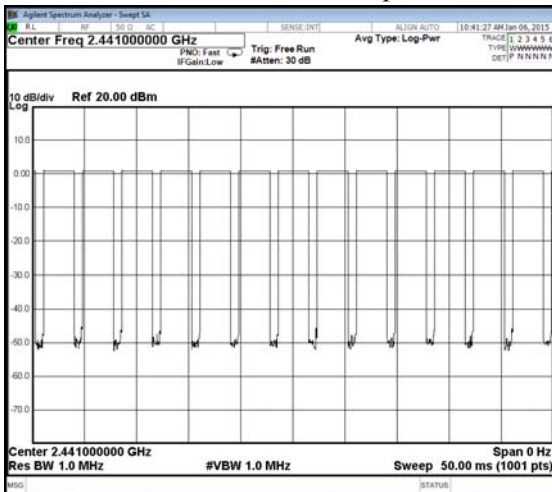

CH 39Transmission Time

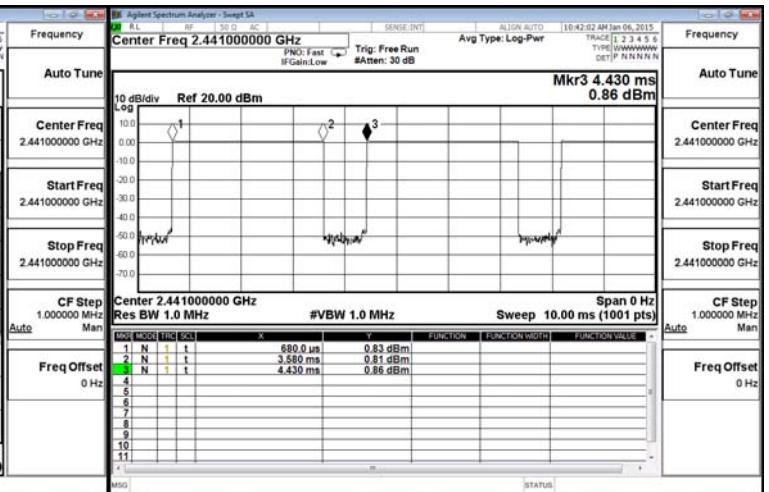

CH 78 Time Interval between hops

CH 78 Transmission Time

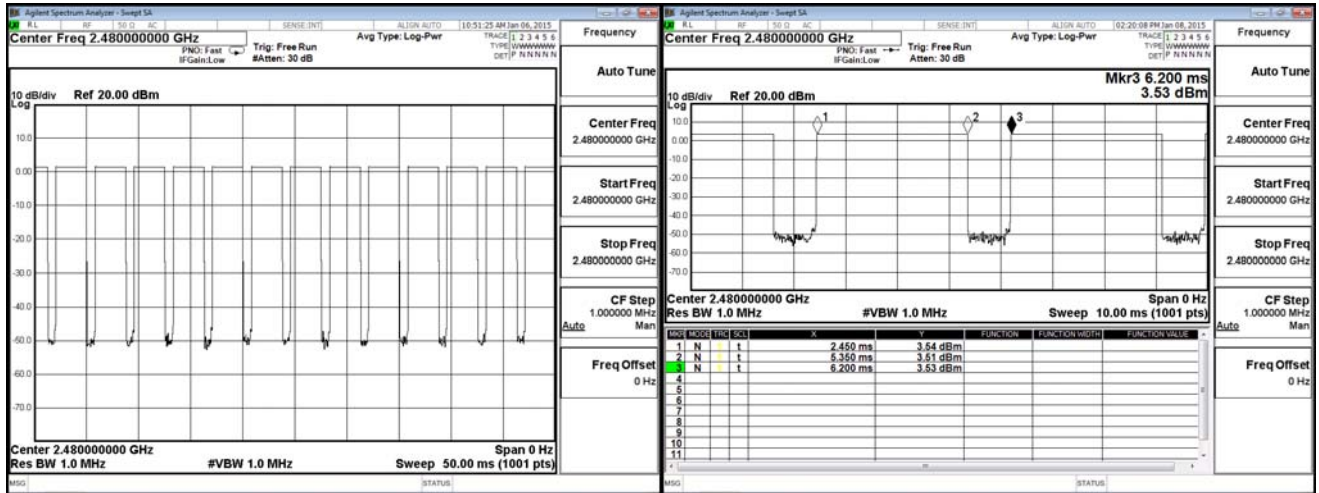

Note:

The dwell times of the packet type of DH1, DH3, and DH5 are tested. Only the worst case is shown on the report.

Product : Barcode Printer
 Test Item : Dwell Time
 Test Site : No.3 OATS
 Test Mode : Mode 2: Transmit - 3Mbps (8DPSK) (Channel 00,39,78 –DH5)

Frequency (MHz)	Time slot length (ms)	Hopping of Number	Sweep time (ms)	Duty cycle	Dwell Time (Sec)	Limit (Sec)	Result
2402	2.900	13	50	0.75	0.302	0.4	Pass
2441	2.890	13	50	0.75	0.301	0.4	Pass
2480	2.900	13	50	0.75	0.302	0.4	Pass

Duty cycle = ((Time slot length(ms)*Hopping of Number) / Sweep time (ms)

Dwell time = (Duty cycle /79) * (79*0.4)

CH 00 Time Interval between hops

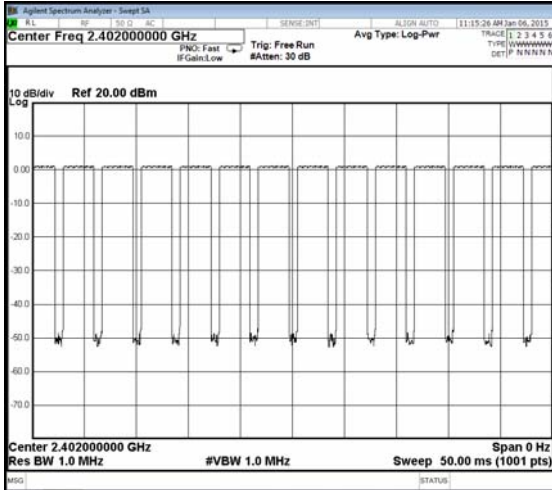

CH 00 Transmission Time

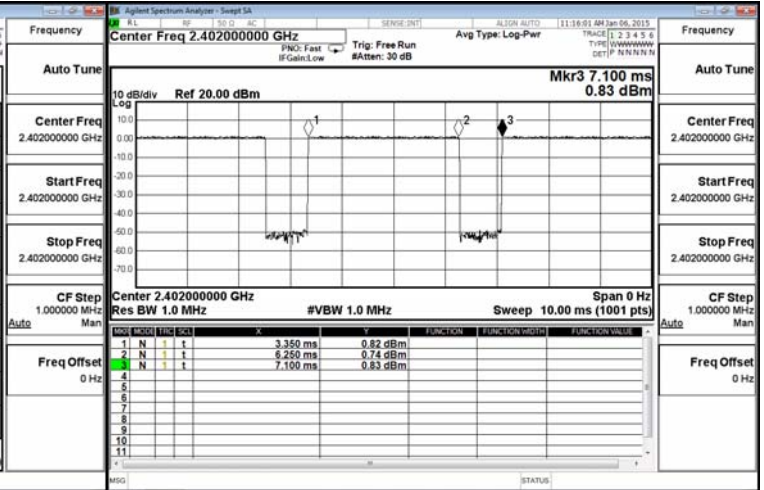

CH39 Time Interval between hops

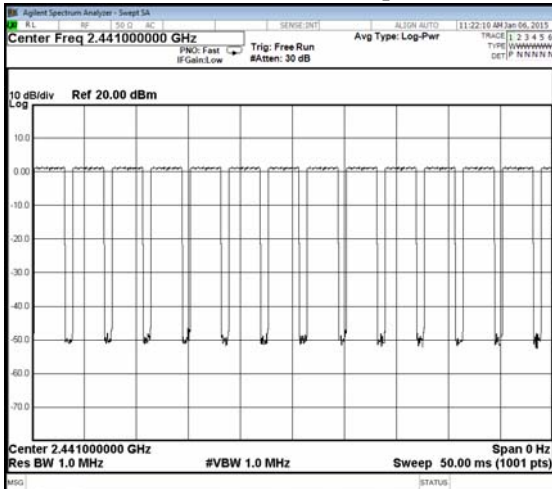

CH39 Transmission Time

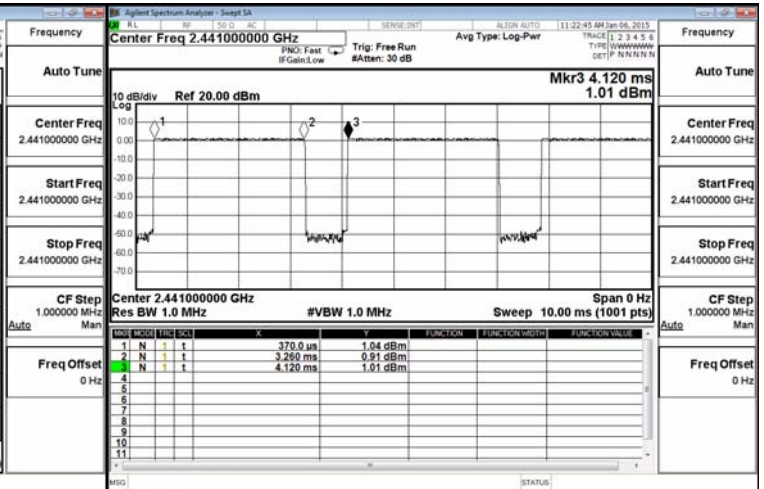

CH 78 Time Interval between hops

CH 78 Transmission Time

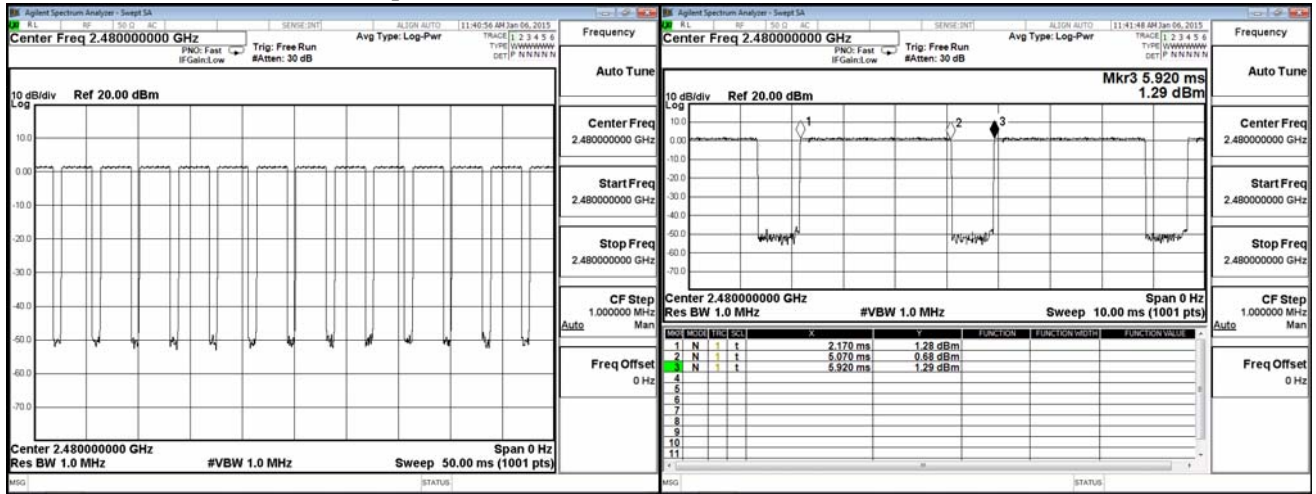

Note:

The dwell times of the packet type of DH1, DH3, and DH5 are tested. Only the worst case is shown on the report.

10. Occupied Bandwidth

10.1. Test Equipment

	Equipment	Manufacturer	Model No./Serial No.	Last Cal.
	Spectrum Analyzer	R&S	FSP40 / 100170	Jun., 2014
	Spectrum Analyzer	Agilent	E4407B / US39440758	Jun., 2014
X	Spectrum Analyzer	Agilent	N9010A / MY48030495	Apr., 2014

Note: 1. All equipments are calibrated every one year.
 2. The test instruments marked by “X” are used to measure the final test results.

10.2. Test Setup

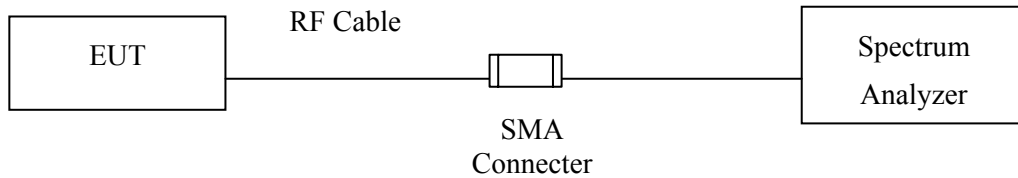

10.3. Limits

N/A

10.4. Test Procedure

The EUT was setup to ANSI C63.10: 2013; tested to FHSS test procedure of FCC Public Notice DA 00-705 for compliance to FCC 47CFR 15.247 requirements.

10.5. Uncertainty

± 150Hz

10.6. Test Result of Occupied Bandwidth

Product : Barcode Printer
 Test Item : Occupied Bandwidth Data
 Test Site : No.3 OATS
 Test Mode : Mode 1: Transmit - 1Mbps (GFSK)(2402MHz)

Channel No.	Frequency (MHz)	Measurement Level (kHz)	Required Limit (kHz)	Result
00	2402	1150	--	NA

Figure Channel 00:

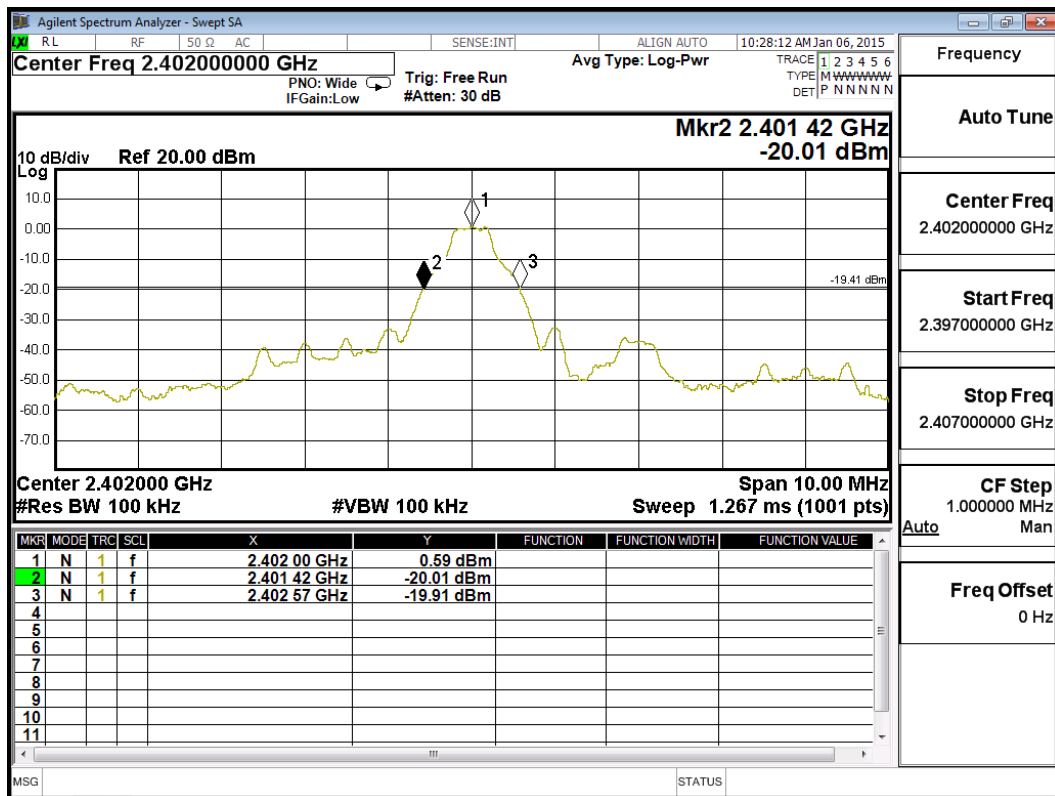

Product : Barcode Printer
 Test Item : Occupied Bandwidth Data
 Test Site : No.3 OATS
 Test Mode : Mode 1: Transmit - 1Mbps (GFSK)(2441MHz)

Channel No.	Frequency (MHz)	Measurement Level (kHz)	Required Limit (kHz)	Result
39	2441	1150	--	NA

Figure Channel 39:

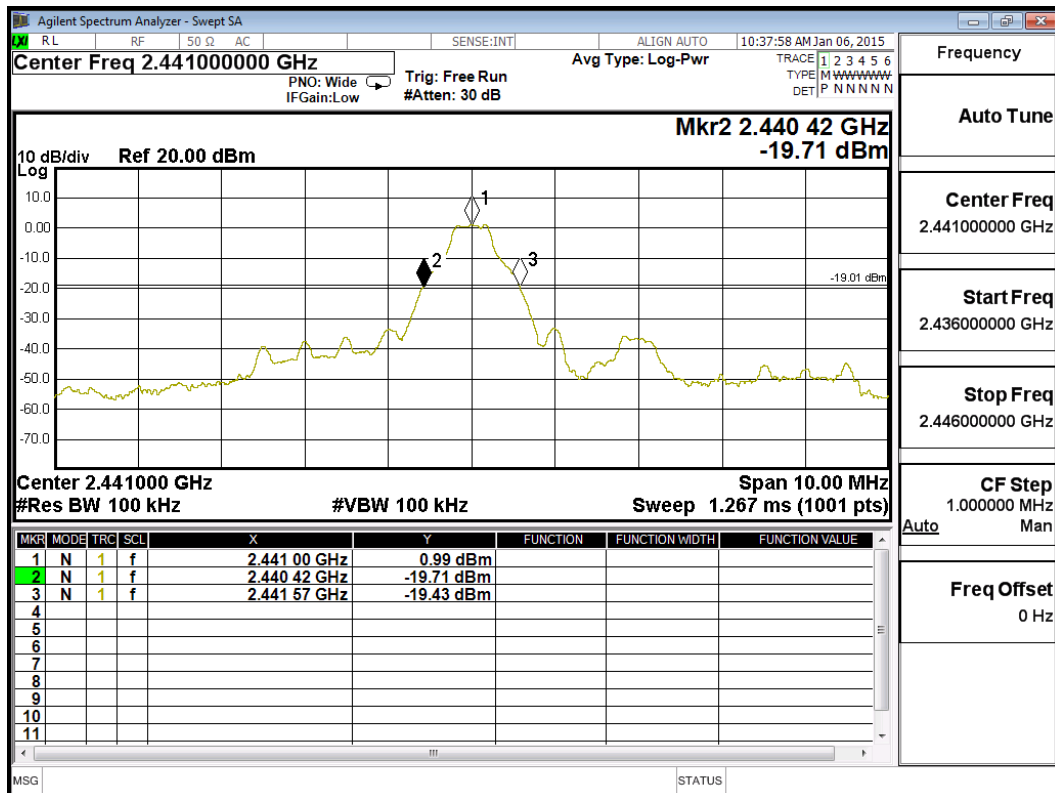

Product : Barcode Printer
 Test Item : Occupied Bandwidth Data
 Test Site : No.3 OATS
 Test Mode : Mode 1: Transmit - 1Mbps (GFSK)(2480MHz)

Channel No.	Frequency (MHz)	Measurement Level (kHz)	Required Limit (kHz)	Result
78	2480	1150	--	NA

Figure Channel 78:

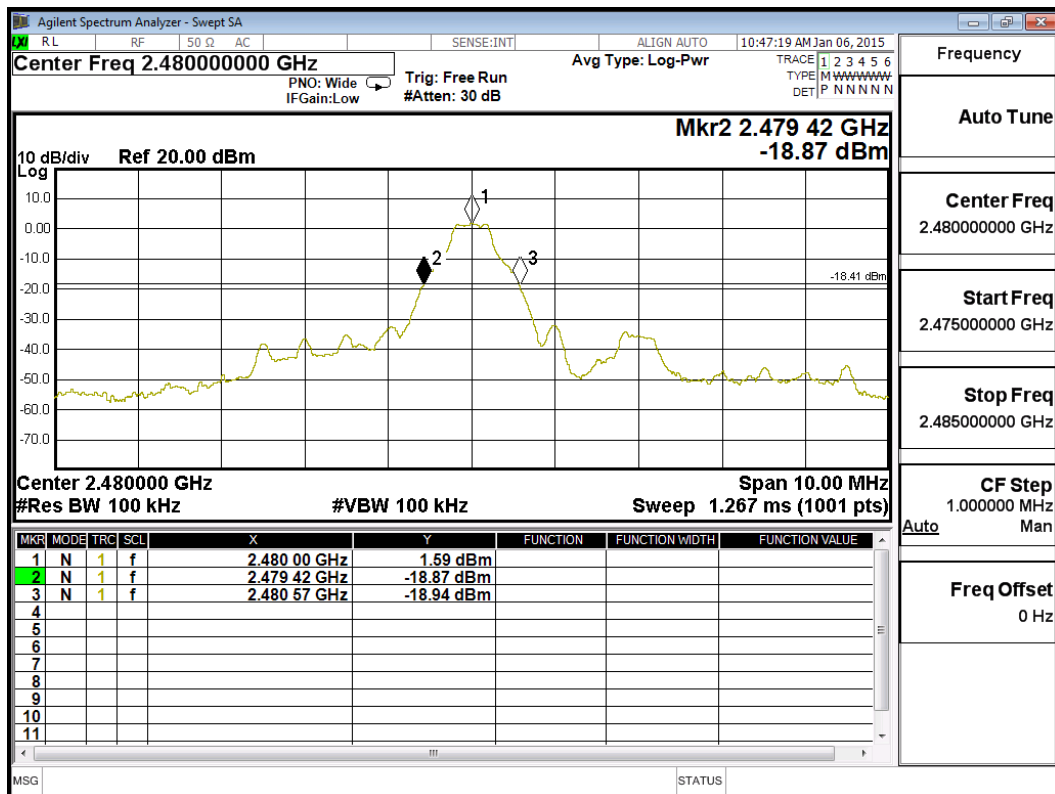

Product : Barcode Printer
 Test Item : Occupied Bandwidth Data
 Test Site : No.3 OATS
 Test Mode : Mode 2: Transmit - 3Mbps (8DPSK) (2402MHz)

Channel No.	Frequency (MHz)	Measurement Level (kHz)	Required Limit (kHz)	Result
00	2402	1390	--	NA

Figure Channel 00:

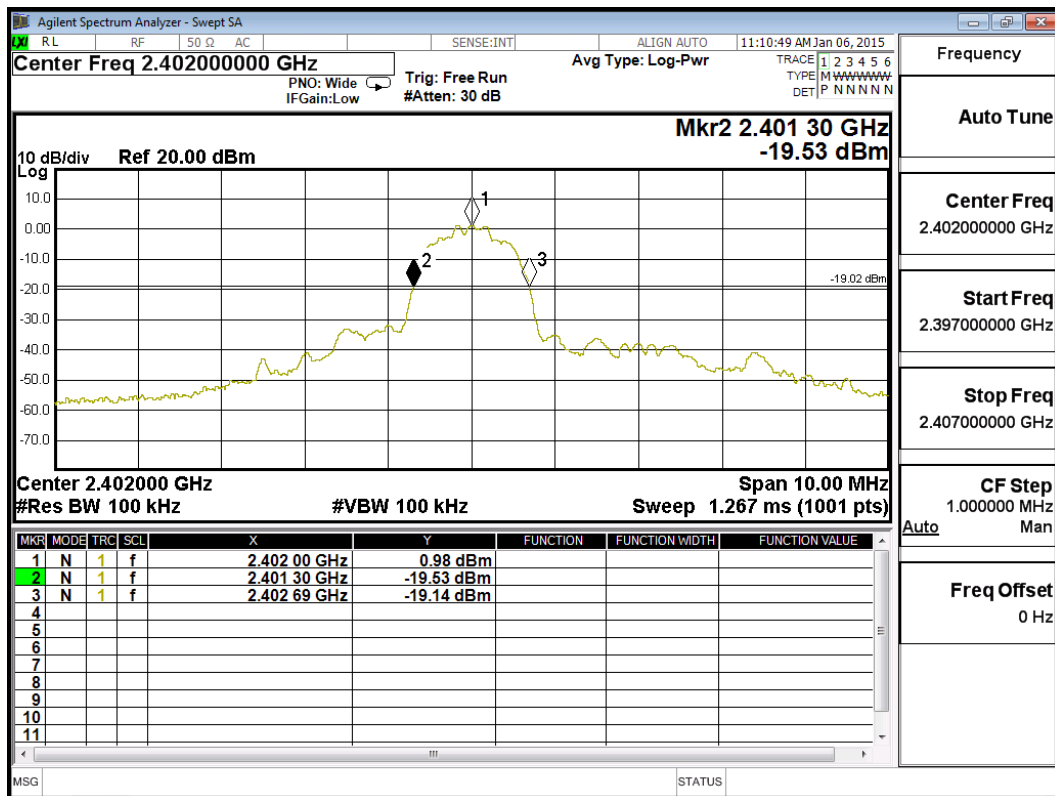

Product : Barcode Printer
 Test Item : Occupied Bandwidth Data
 Test Site : No.3 OATS
 Test Mode : Mode 2: Transmit - 3Mbps (8DPSK) (2441MHz)

Channel No.	Frequency (MHz)	Measurement Level (kHz)	Required Limit (kHz)	Result
39	2441	1390	--	NA

Figure Channel 39:

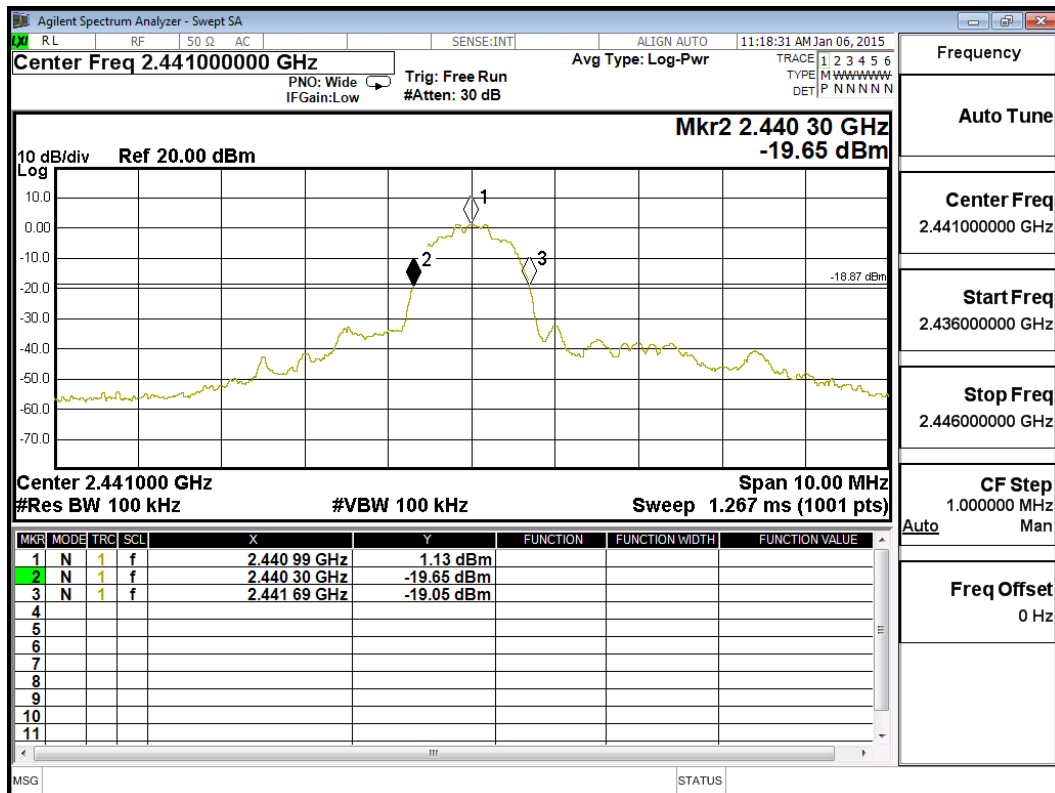

Product : Barcode Printer
 Test Item : Occupied Bandwidth Data
 Test Site : No.3 OATS
 Test Mode : Mode 2: Transmit - 3Mbps (8DPSK)(2480MHz)

Channel No.	Frequency (MHz)	Measurement Level (kHz)	Required Limit (kHz)	Result
78	2480	1390	--	NA

Figure Channel 78:

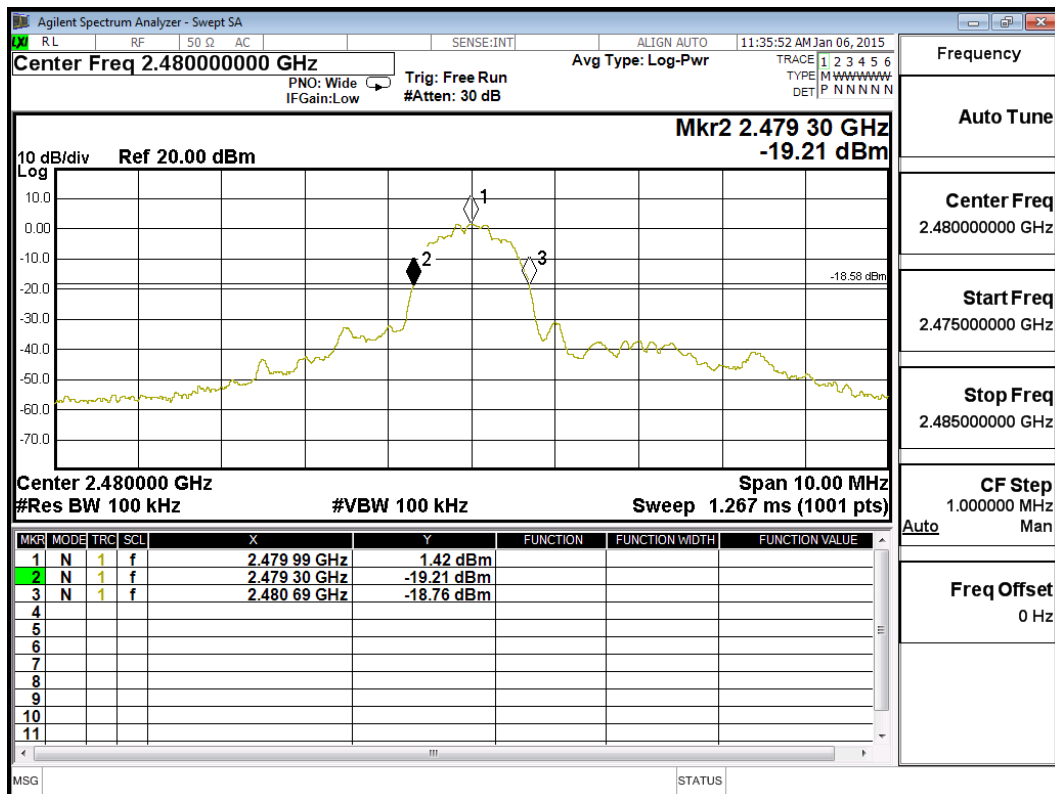

11. EMI Reduction Method During Compliance Testing

No modification was made during testing.

Attachment 1: EUT Test Photographs

Attachment 2: EUT Detailed Photographs