

TOSHIBA

B-FV4D SERIES Printer

Owner's Manual

B-FV4D-GS12-QM-R

B-FV4D-GS12-QM-R

B-FV4D-TS12-QM-R

B-FV4D-TS12-QM-R

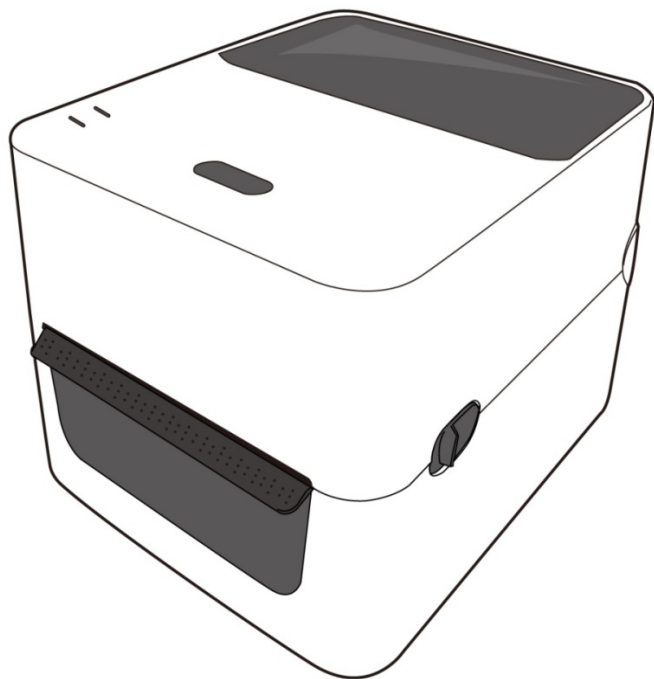

FCC Compliance Statement

This equipment has been tested and found to comply with the limits for a Class A digital device, pursuant to Part 15 of the FCC Rules. These limits are designed to provide reasonable protection against harmful interference in a residential installation. This equipment generates, uses, and can radiate radio frequency energy and, if not installed and used in accordance with the instructions, may cause harmful interference to radio communications. However, there is no guarantee that the interference will not occur in a particular installation. If this equipment does cause harmful interference to radio or television reception, which can be determined by turning the equipment off and on, the user is encouraged to try to correct the interference by the following measures:

- Reorient or relocate the receiving antenna.
- Increase the separation between the equipment and the receiver.
- Connect the equipment into a different outlet on a different circuit.
- Consult the dealer or an experience Radio/TV technician for help.

This unit was tested with shielded cables on the peripheral devices. Shielded cables must be used with the unit to insure compliance. The user is cautioned that any changes or modifications not expressly approved by Toshiba TEC Corporation could void the user's authority to operate the equipment.

Liability Disclaimer

Toshiba TEC Corporation takes steps to assure that the company's published engineering specifications and manuals are correct; however, errors do occur. Toshiba reserves the right to correct any such errors and disclaims any resulting liability. In no event shall Toshiba or anyone else involved in the creation, production, or delivery of the accompanying product (including hardware and software) be liable for any damages whatsoever (including, without limitation, damages for loss of business profits, business interruption, loss of business information, or other pecuniary loss) arising out of the use of or the results of use of or inability to use such product, even if Toshiba has been advised of the possibility of such damages.

Caution

Any changes or modifications not expressly approved by the party responsible for compliance could void the user's authority to operate the equipment.

Precautions for the handling of Wireless

Communication Devices

This product is classified as “wireless equipment for stations of low-power data transmissions systems” under the Wireless Telegraphy Act, and does not require a radio transmission license. The law prohibits modification of the interior of this product.

■ Regulatory Information

This product must be installed and used in strict accordance with the manufacturer’s instructions as described in the user documentation that comes with the product. This device complies with the following radio frequency and safety standards.

Standards below are certified under the operation with the provided antenna. Do not use this product with other antennas.

□ Europe - EU Declaration of Conformity

Hereby, TOSHIBA TEC, declares that B-FV4D series are in compliance with the essential requirements and other relevant provisions of Directive 1999/5/EC.

□ USA-Federal Communications Commission (FCC)

NOTE: This equipment has been tested and found to comply with the limits for a Class A digital device, pursuant to part 15 of the FCC Rules. These limits are designed to provide reasonable protection against harmful interference when the equipment is operated in a commercial environment. This equipment generates, uses, and can radiate radio frequency energy and, if not installed and used in accordance with the instruction manual, may cause harmful interference to radio communications. Operation of this equipment in a residential area is likely to cause harmful interference in which case the user will be required to correct the interference at his own expense.

CAUTION:

This device complies with Part 15 of the FCC Rules.

Operation is subject to the following two conditions:

- (1) this device may not cause harmful interference, and
- (2) this device must accept any interference received, including interference that may cause undesired operation.

Any changes or modifications not expressly approved by the grantee of this device could void the user's authority to operate the equipment.

RF EXPOSURE WARNING:

This equipment must be installed and operated in accordance with provided instructions and the antenna(s) used for this transmitter must be installed to provide a separation distance of at least 20 cm from all persons and must not be co-located or operating in conjunction with any other antenna or transmitter. End-users and installers must be provide with antenna installation instructions and transmitter operating conditions for satisfying RF exposure compliance.

☐ **Canada - Industry Canada (IC)**

This device complies with Canada licence-exempt RSS standard(s).

Operation is subject to the following two conditions:

- (1) this device may not cause interference, and
- (2) this device must accept any interference, including interference that may cause undesired operation of the device.

Cet appareil est conforme avec Industrie Canada exemptes de licence RSS standard(s).

Son fonctionnement est soumis aux deux conditions suivantes :

- (1) cet appareil ne doit pas causer d'interférence et
- (2) cet appareil doit accepter toute interférence, notamment les interférences qui peuvent affecter son fonctionnement.

Radio Frequency (RF) Exposure Information

The radiated output power of the Wireless Device is below the Industry Canada (IC) radio frequency exposure limits. The Wireless Device should be used in such a manner such that the potential for human contact during normal operation is minimized.

This device has been evaluated for and shown compliant with the IC Specific Absorption Rate ("SAR") limits when operated in portable exposure conditions.

Informations concernant l'exposition aux fréquences radio (RF)

La puissance de sortie émise par l'appareil de sans fil est inférieure à la limite d'exposition aux fréquences radio d'Industry Canada (IC). Utilisez l'appareil de sans fil de façon à minimiser les contacts humains lors du fonctionnement normal.

Ce périphérique a également été évalué et démontré conforme aux limites d'exposition aux RF d'IC dans des conditions d'exposition à des appareils mobiles (antennes sont supérieures à 20 cm à partir du corps d'une personne).

■ Approved Countries/Regions for use for the devices

This equipment is approved to the radio standard by the specific countries/regions. Please ask TOSHIBA TEC authorized dealer or service engineer.

■ Precaution for Use

- This product communicates with other devices by radio. Depending on the installation location, orientation, environment, etc., its communication performance may deteriorate or devices installed near by may be affected.
- Bluetooth® devices operate within the same radio frequency range and may interfere with one another. If you use Bluetooth®, you may occasionally experience a less than optimal network performance or even lose your network connection.
- If you should experience any such problem, immediately turn off your Bluetooth®.
- Keep away from a microwave.
Communication performance may deteriorate or a communication error may occur due to the radio emitted from a microwave.
- Do not use the product on a metal table or near a metal object.
Communication performance may be deteriorated.

* Bluetooth® is a registered trademark owned by Bluetooth SIG, Inc.

Contents

1	Introduction	1
1.1	Features.....	1
1.2	Unpacking	2
1.3	Understanding Your Printer	3
1.3.1	Perspective View.....	3
1.3.2	Back View.....	4
1.3.3	Interior View	5
1.4	Printer Lights	6
1.4.1	Status Lights	6
1.4.2	System Mode	7
2	Getting Started.....	8
2.1	Attaching Power	8
2.2	Turning On/Off the Printer.....	9
2.2.1	Turn On the Printer	9
2.2.2	Turn Off the Printer	10
2.3	Loading Media.....	11
2.3.1	Preparing Media.....	11
2.3.2	Placing Media Roll	11
2.3.3	Testing Media Feed	14
2.3.4	Media Types	15
3	Printer Operation	17
3.1	Media Sensor Calibration.....	17
3.2	Self Test and Dump Mode.....	18
3.2.1	Self Test	18
3.2.2	Dump Mode	20
3.3	Resetting Your Printer	20
3.4	Media Sensing.....	21
3.4.1	Transmissive Sensor	21
3.4.2	Reflective Sensor.....	22
3.5	Wireless Connection (Optional).....	23
3.5.1	Bluetooth	23
4	Maintenance	28
4.1	Cleaning.....	28
4.1.1	Printhead.....	28
4.1.2	Media Housing	29
4.1.3	Sensor.....	30
4.1.4	Platen Roller	31
4.2	Replacing RTC Battery (Optional).....	32

5	Troubleshooting	33
5.1	Printer Issues.....	33
5.2	Media Issues.....	34
5.3	Other Issues	36
6	Specifications	37
6.1	Printer	37
6.2	Media	39
6.3	Bar Code.....	40
6.4	Bluetooth	43
6.5	Electrical and Operating Environment.....	44
6.6	Physical Dimension	44
6.7	Interfaces.....	45
6.7.1	USB	45
6.7.2	Ethernet	46
6.7.3	RS-232C	47
6.7.4	Centronics	48

1 Introduction

Thank you for purchasing a Toshiba B-FV4D printer. This manual provides information about how to set up and operate your printer, load the media and solve common problems.

1.1 Features

- **Various Connectivity Options** USB, Ethernet, RS-232C, Centronics
- **Easy Operation** One-button design for easy control
- **High Print Resolution** 203 dpi for GS models, 300 dpi for TS models
- **Fast Print Speed** Max 6 inches/sec for GS models, max 4 inches/sec for TS models
- **Wireless Connection** Build a wireless printing environment with Bluetooth
- **External Memory** The extra USB port allows you to use a USB flash drive for storage
- **Accessories** It is easier to complete tasks with accessories: full cutter, partial cutter, peeler, external media stand

1.2 Unpacking

Make sure all of the following items are included in your package.

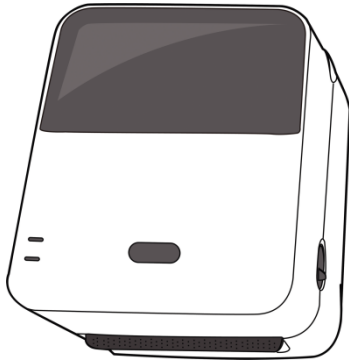

Toshiba B-FV4D Printer



Toshiba B-FV4D
Quick Installation
Guide

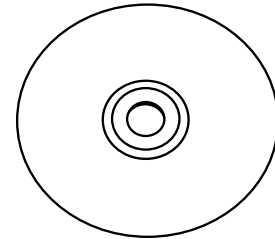

CD
Including document and
software

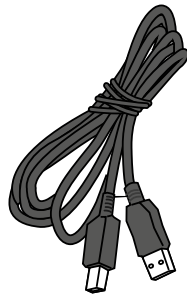

USB Cable

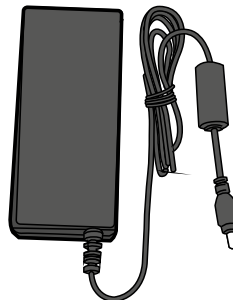

Power Supply

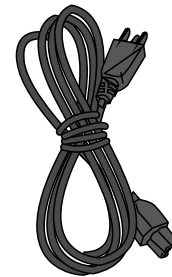

AC Power Cord

When you receive the printer, open the package immediately and inspect for shipping damage. If you discover any damage, contact the shipping company and file a claim. Toshiba is not responsible for any damage incurred during shipping. Save all package materials for the shipping company to inspect.



Note If any item is missing, please contact your local dealer.

1.3 Understanding Your Printer

1.3.1 Perspective View

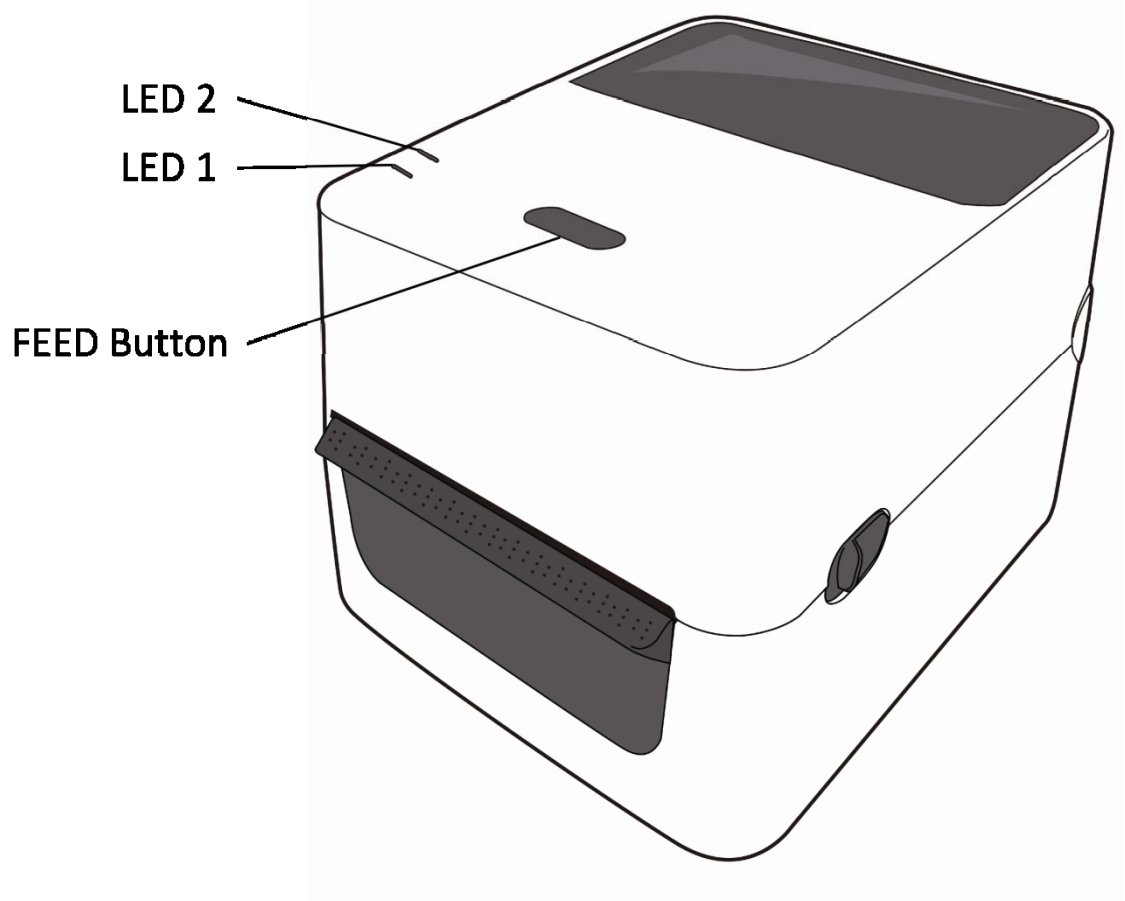

1.3.2 Back View

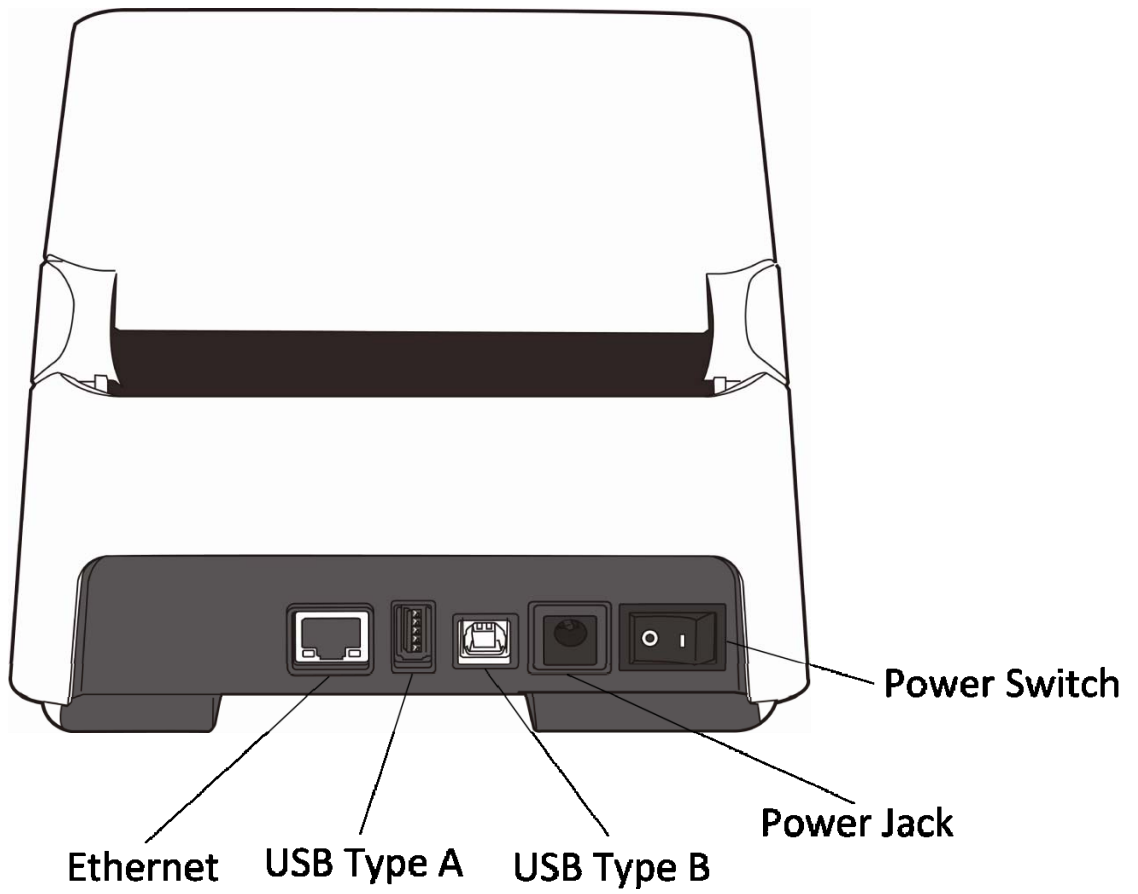

Optional Interfaces

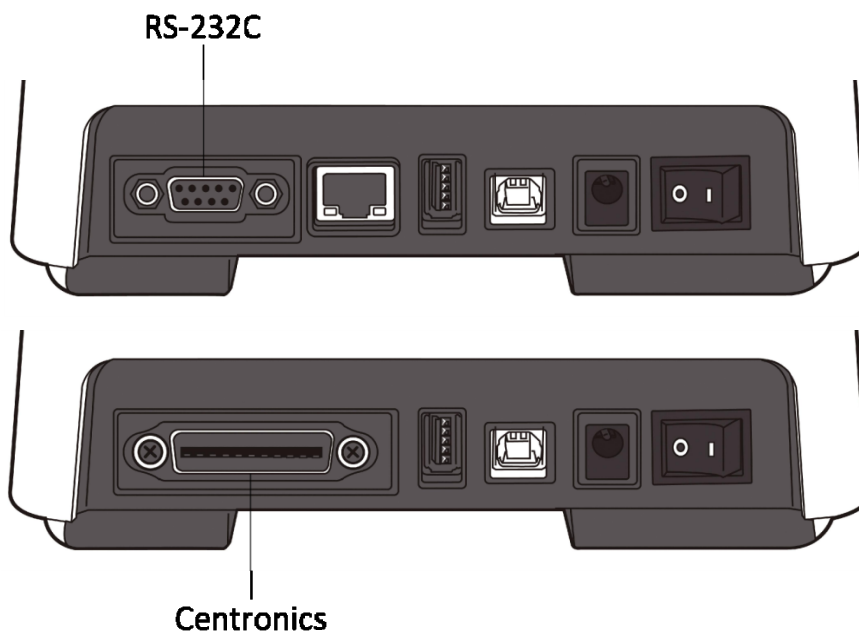

1.3.3 Interior View

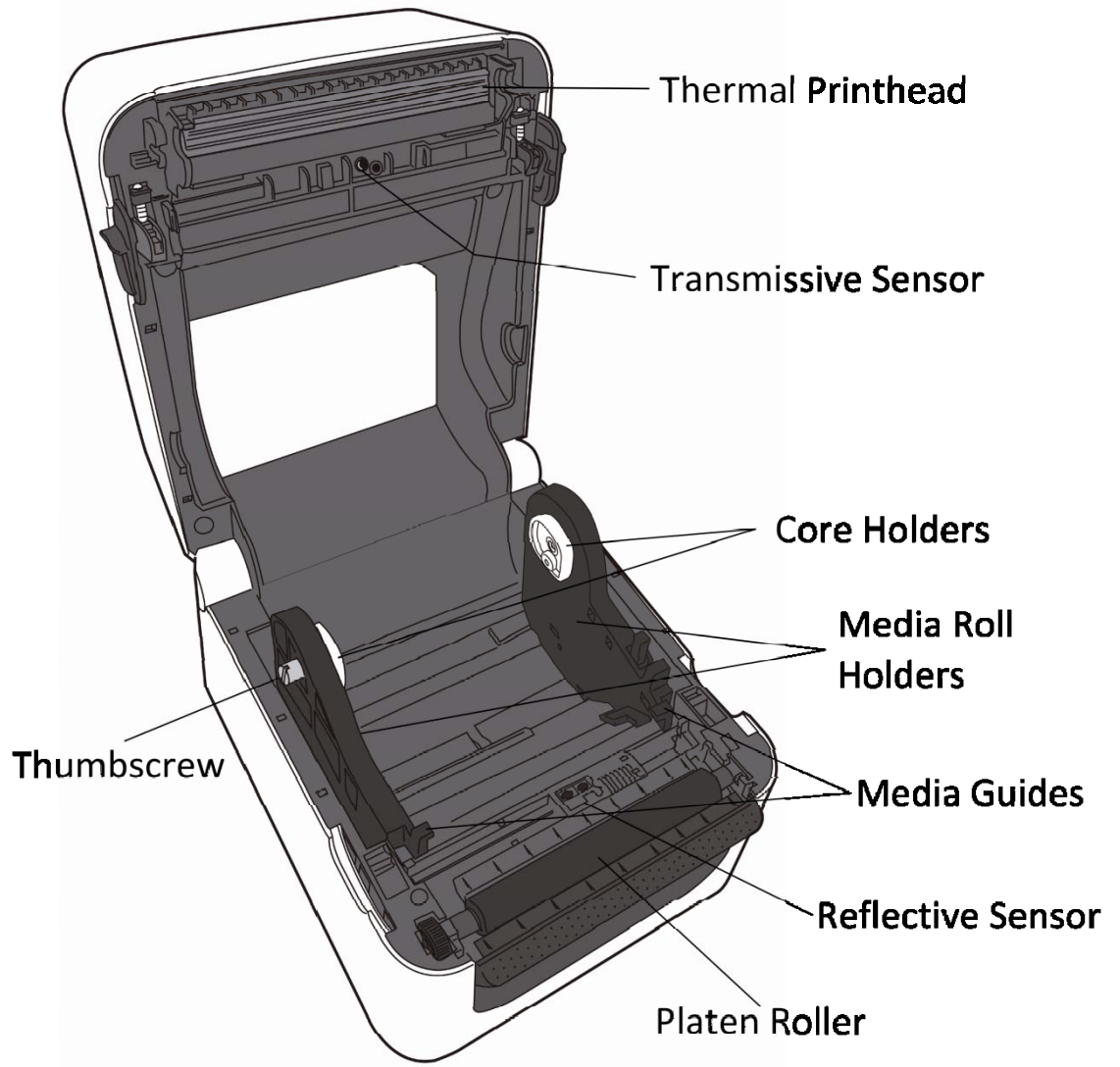

1.4 Printer Lights

There are two LED lights that show the status of your printer.

1.4.1 Status Lights

Status lights help you check printer's condition. The following tables show the blinking speed of status lights and the conditions they indicate.

Symbol	Blinking Speed	Blinking Interval
★	Fast	0.5 Second
⦿	Medium	1 Second
◇	Slow	2 Seconds

LED 1	LED 2	Description
Off	Off	The print module is opened when the printer is turned on.
Green	Off	In the online mode.
★Green	Off	The printer is transmitting data.
◇Green	Off	In a pause state.
Green	Green	The printer is writing data to the flash or USB memory.
Green	⦿Green	The USB memory is being initialized. The process takes about 15 seconds.
Orange	Green	Paper jam.
Orange	★Red	The media is out when the print data is sent to the printer.
Orange	Red	Paper end.
Red	Green	Communication error (RS-232C).
Red	★Green	Cutter error (with optional cutter).
		Flash ROM on the CPU board error or USB memory error.
Red	⦿Green	An erase error occurred when formatting the USB memory. Unable to save files due to insufficient USB memory.
Red	◇Green	Command error.
Red	★Orange	Head high temperature error.
Red	⦿Orange	The printhead is broken.
Red	⦿Red	Cover (Thermal Head) open error.
Red	◇Red	The RTC battery is low. (If the printer has a built-in RTC)

1.4.2 System Mode

The system mode consists of status light color combinations. It contains a list of commands for you to select and run.

To enter the system mode and run the command, do the following:

1. Turn off the printer.
2. Press and hold the **FEED** button, and turn on the printer.
3. Both status lights glow solid orange for a few seconds. Next, they turn to green shortly, and then turn to other colors.
4. When status lights show the color combination you need, release the **FEED** button immediately.
5. Press the **FEED** button to run the command.

The following table is the command list of the system mode.

LED 1	LED 2	Command
Green	Red	Transmissive Sensor Calibration (Section 3.1)
Green	Orange	Reflective Sensor Calibration (Section 3.1)
Red	Red	Resetting the Printer (Section 3.3)
Red	Orange	TPCL Auto Call Cancellation
Red	Green	Disable Checking RTC Battery Charge
Orange	Red	Disable BASIC Mode
Orange	Green	Self Test and Dump Mode (Section 3.2)



Note For information about TPCL Auto Call and BASIC Mode, please refer to B-FV4D technical manual.

2 Getting Started

This chapter describes how to set up your printer.

2.1 Attaching Power

1. Make sure the power switch is set to the **OFF** position.
2. Insert the power supply's connector into the printer power jack.
3. Insert the AC power cord into the power supply.
4. Plug the other end of the AC power cord into the wall socket.

Important Use only power supplies listed in the user instructions.

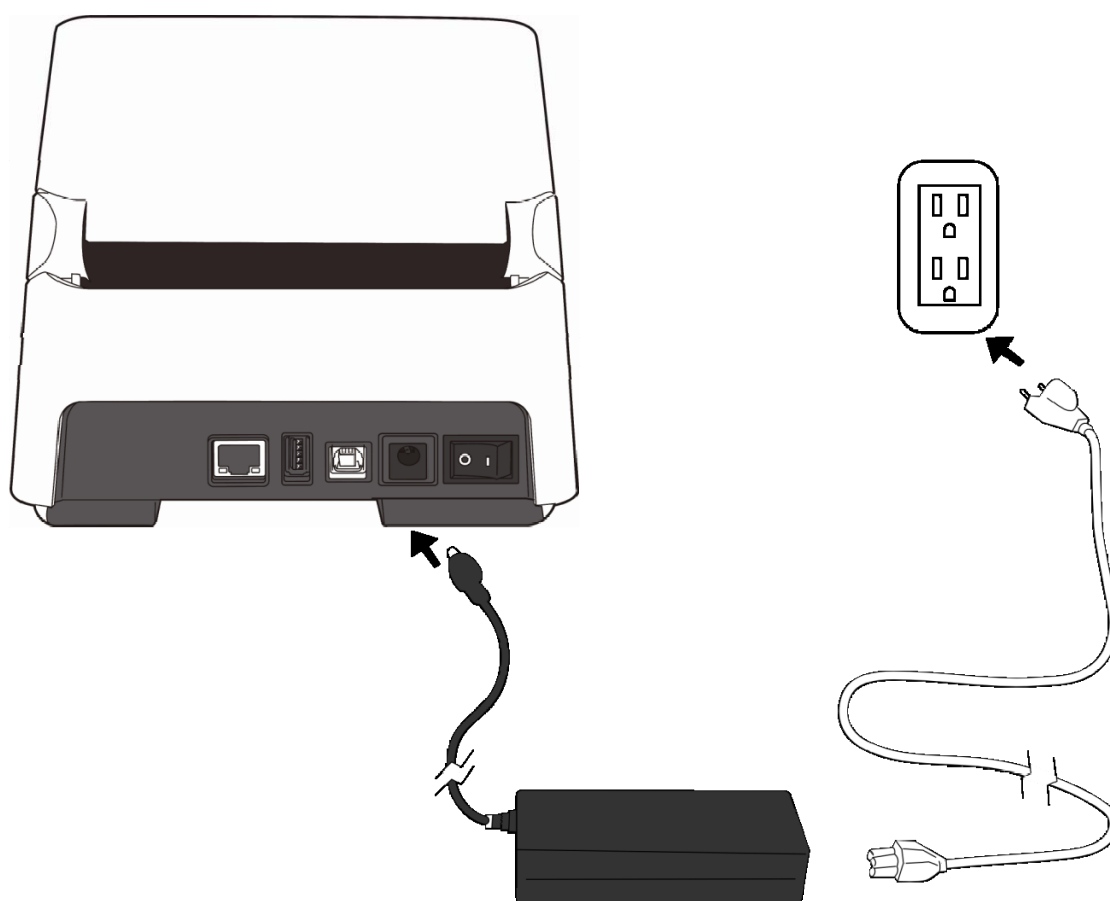

Warning Do not plug the AC power cord with wet hands, or operate the printer and the power supply in an area where they may get wet. Serious injury may result from these actions!

2.2 Turning On/Off the Printer

When the printer is connected to a host (the computer), it is good to turn on the printer before turning on the host, and turn off the host before turning off the printer.

2.2.1 Turn On the Printer

1. To turn on the printer, turn on the **Power Switch** as below. The “I” is the **ON** position.

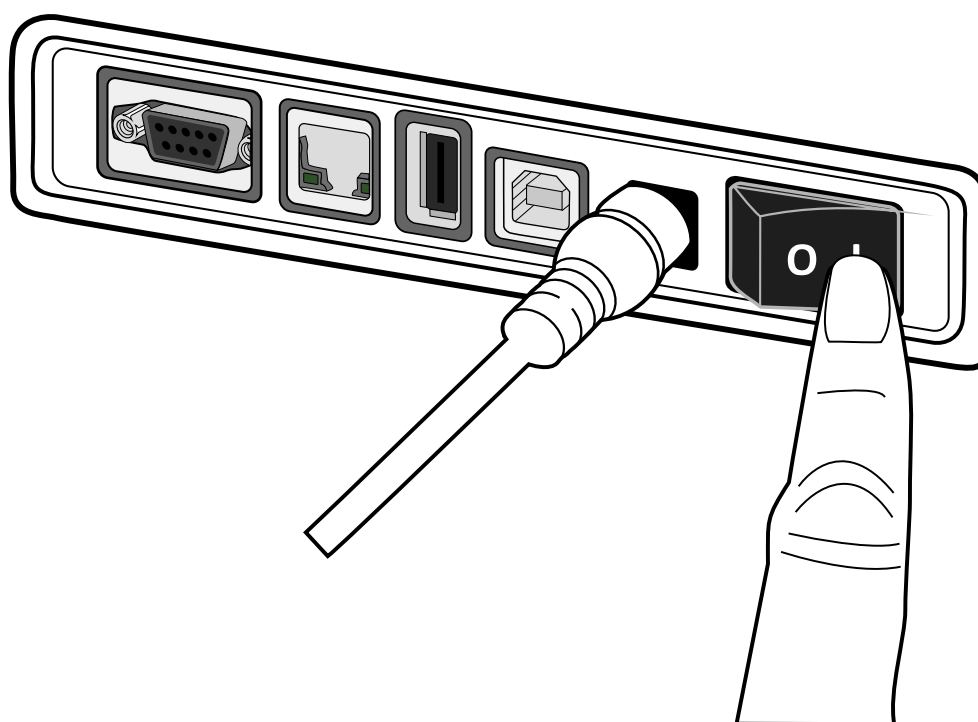

2. Both status lights glow solid orange for a few seconds, and then LED 2 goes out, while LED 1 turns to solid green.



Note If you connect the printer to the internet or insert a USB drive before turning on the printer, it will take longer for the printer to enter the online mode (LED 1 glows solid green) after you turn it on.

2.2.2 Turn Off the Printer

1. Make sure LED 2 is off and LED 1 is solid green before turning off the printer.
2. To turn off the printer, turn off the **Power Switch** as below. The “O” is the **OFF** position.

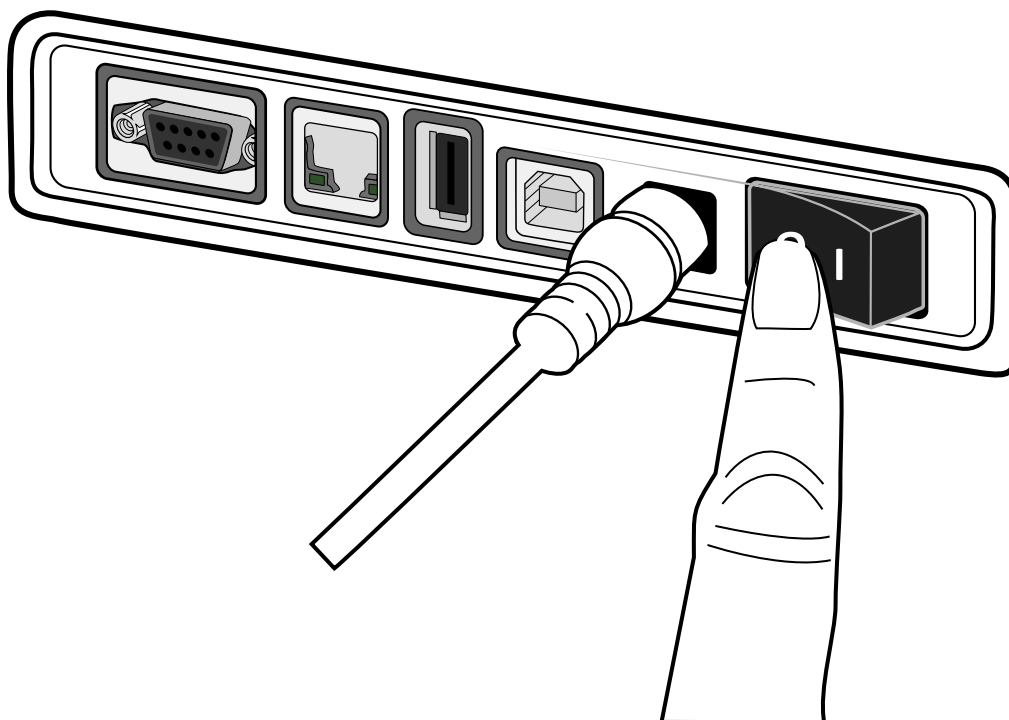

Caution Do not turn off the printer during data transmission.

2.3 Loading Media

There are various types and sizes for the media roll. Load the applicable media to satisfy your need.

2.3.1 Preparing Media

The inside wound and outside wound media roll can be loaded into the printer the same way. In case the media roll is dirty during shipping, handling or storage, remove the outside length of the media. It helps avoid dragging adhesive and dirty media between the printhead and platen roller.

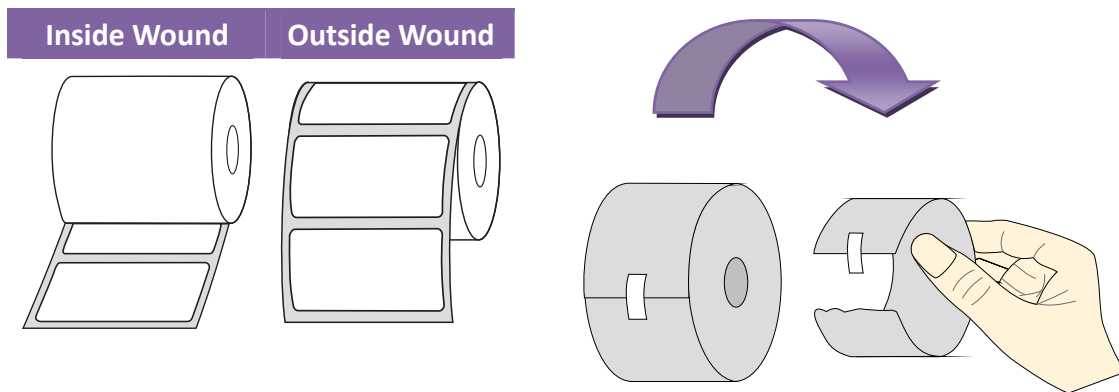

2.3.2 Placing Media Roll

1. Open the top cover of the printer.

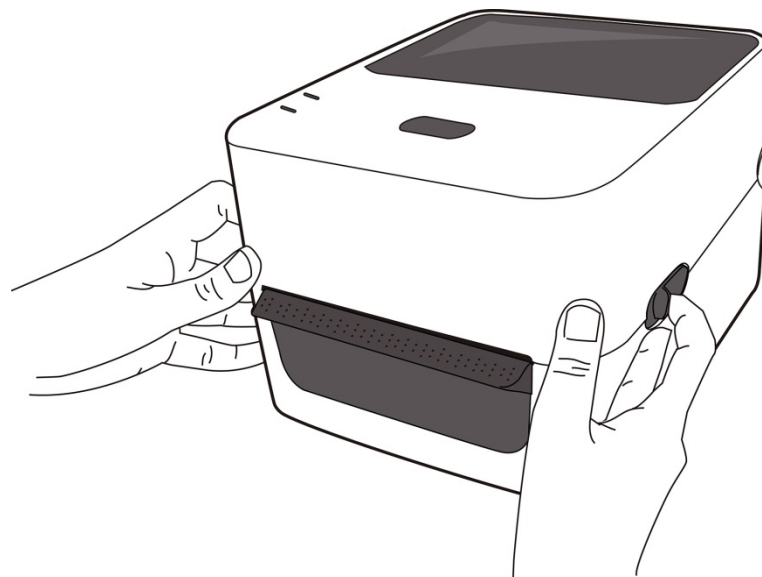

2. Press the holder lock on the **Media Roll Holders** to slide them outward, and place the media roll between the holders. Make sure the print side is up, and the media roll is clamped tightly by the holders.

Note The default core holder is set for 1.5-inch inside diameter (ID). To install a 1-inch ID media roll, use your hand or a coin to loosen two thumbscrews on both holders, turn over the core holders and secure them back.



3. Pull the media until it reaches out of the printer. Thread the media under the media guides.

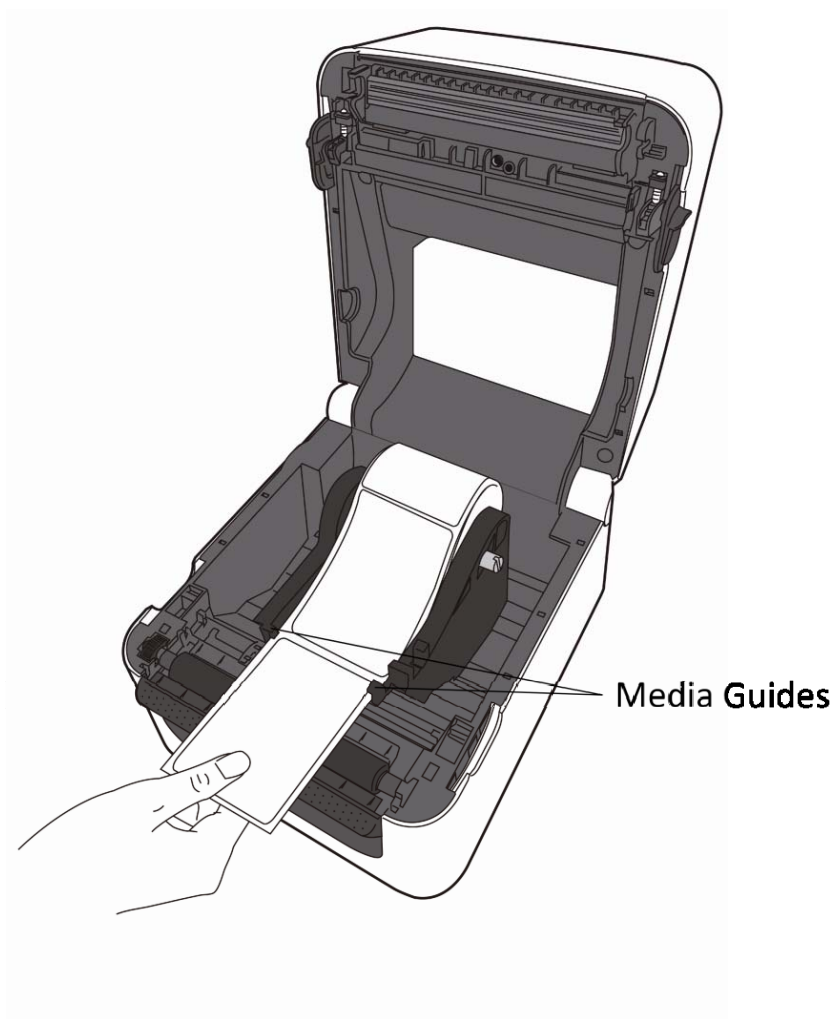

4. Close the top cover.

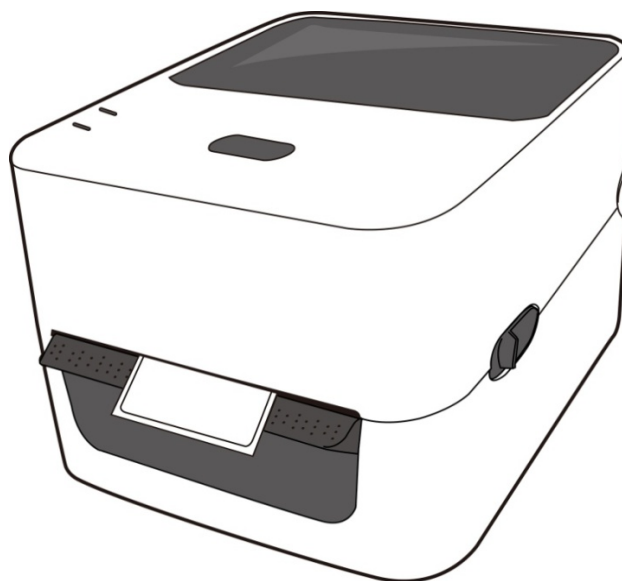

2.3.3 Testing Media Feed

1. Turn on the printer, and press the **FEED** button to feed a label.

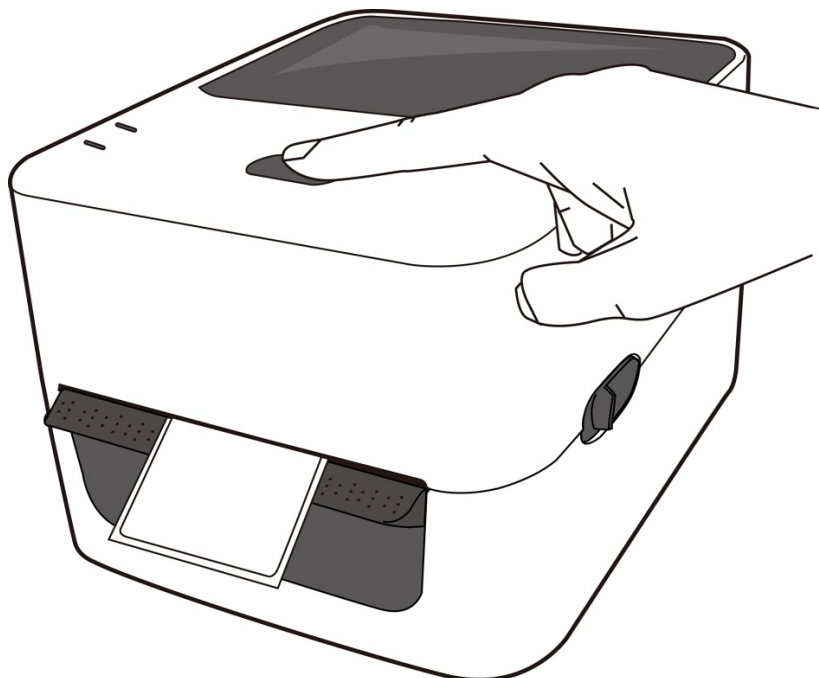

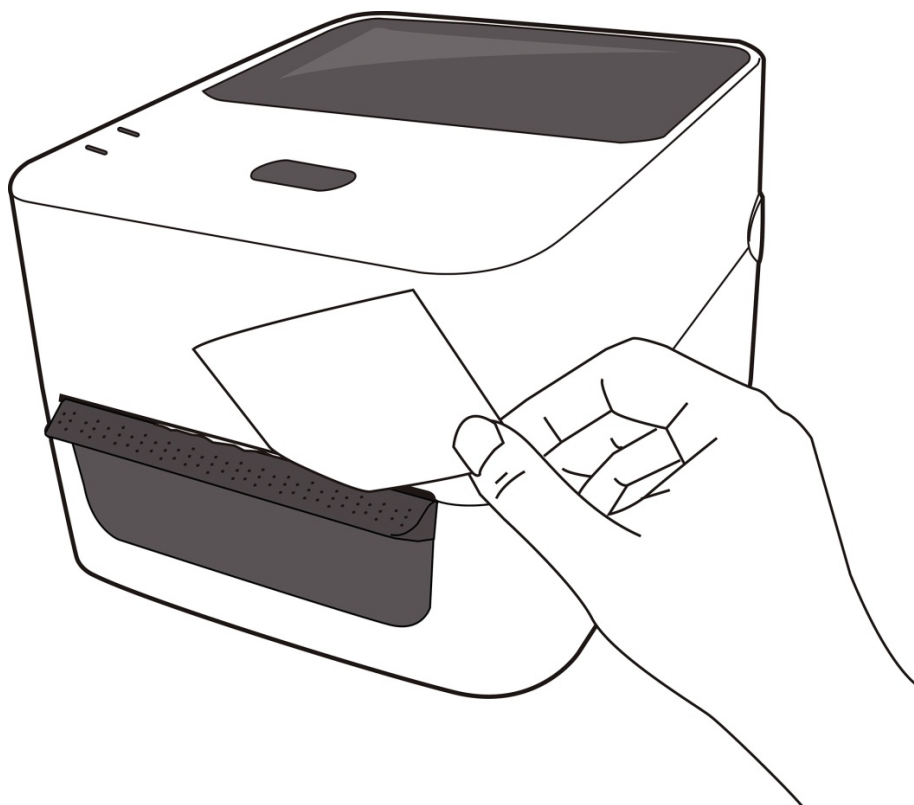

2. Flip the media and tear it along the edge of the top cover.

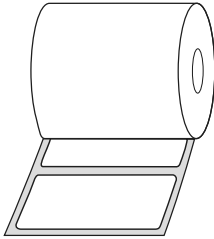
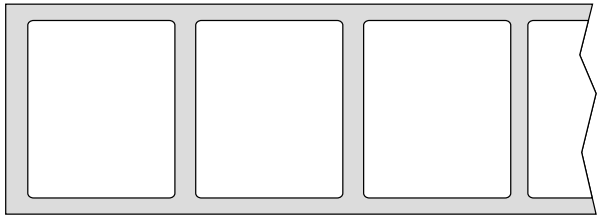
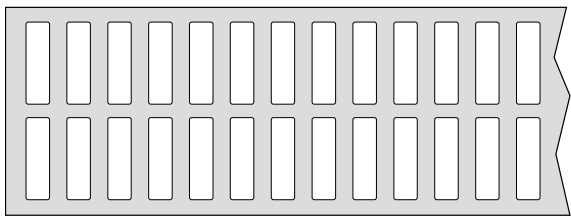
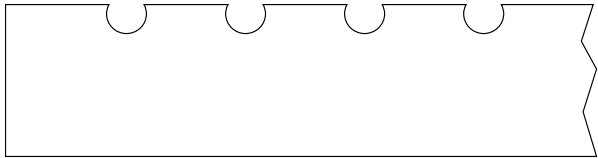

2.3.4 Media Types

Your printer supports various media types, including non-continuous media, continuous media, and fanfold media. The following table provides details about them.

Media Type	Looks Like	Description
Non-Continuous Media		<p>Non-continuous media is the typical media for bar code printing. Labels and tags are made of various materials, such as paper, fabric or cardstock, and are separated by gaps, holes, notches or black marks. Many labels are self-adhesive with liners, while some are linerless.</p>
		
		
		
		
		

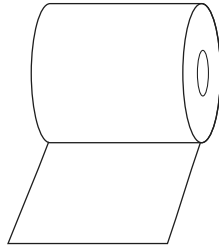
Continuous Media

Continuous media does not have gaps, holes, notches or black marks. It allows you to print data anywhere on the media. A cutter may be used for splitting labels. Mostly it is used for direct thermal printing.

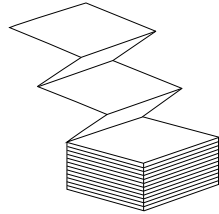
Fanfold Media

Fanfold media is in continuous form, but it can be used as non-continuous media, because its labels are separated by folds. Some fanfold media also has black marks or liners.

3 Printer Operation

This chapter provides information about printer operation.

3.1 Media Sensor Calibration

You will want the printer to work properly before starting your print jobs. To do this, you need to calibrate the media sensor. Toshiba B-FV4D provides transmissive and reflective sensor calibration. Take the following steps to use them.

1. Make sure the media is properly loaded, the print module is closed, and the printer's power switch is set to the **OFF** position.
2. Press and hold the **FEED** button, and turn on the printer.
3. Both status lights glow solid orange for a few seconds. Next, they turn to green shortly, and then turn to other colors. Do one of the following to select the sensor:
 - If you want to calibrate the transmissive sensor, when LED 1 turns to green and LED 2 turns to red, release the **FEED** button immediately.
 - If you want to calibrate the reflective sensor, when LED 1 turns to green and LED 2 turns to orange, release the **FEED** button immediately.
4. Press the **FEED** button. The media calibration is complete after the printer feeds 3-4 labels and stops.

3.2 Self Test and Dump Mode

The printer can run a self test to print a configuration label, which helps you understand current settings of the printer.

3.2.1 Self Test

1. Turn off the printer.
2. Press and hold the **FEED** button, and turn on the printer.
3. Both status lights glow solid orange for a few seconds. Next, they turn to green shortly, and then turn to other colors. When LED 1 turns to orange and LED 2 turns to green, release the **FEED** button.
4. Press the **FEED** button to print a configuration label.

Your configuration label should look like this:

```

B-FV4T-G PRINTER INFO.

PROGRAM VERSION 12SEP2014B-FV4 V1.3d
TPCL VERSION 20AUG2014 V1.2
CG VERSION 27FEB2014 V1.0
CHINESE VERSION 27FEB2014 V1.0
CODEPAGE VERSION 27FEB2014 V1.0
BOOT VERSION V1.3c
KERNEL FONT VER. 1.0.03
[PARAMETERS]
HW DETECT [0000100000010000]
TONE ADJUST(T) [---]
TONE ADJUST(D) [+00]
FEED ADJUST [+0.0mm]
CUT ADJUST [+0.0mm]
BACKFEED ADJUST [+0.0mm]
X COORD. ADJUST [+0.0mm]
CODEPAGE [PC-850]
ZERO SLASH [0]
FEED KEY [FEED]
EURO CODE [B0]
CONTROL CODE [AUTO]
MAXI CODE SPEC. [TYPE1]
SENSOR SELECT [Reflective]
PRINT SPEED [4ips]
FORWARD WAIT [ON]
AUTO CALIB. [OFF]
MULTI LABEL [OFF]
AUTO TPH CHK [OFF]
BASIC [OFF]
Reserved item1
Reserved item2
FLASH ROM [16MB]
SDRAM [32MB]
USB SERIAL NUM. [000000000001]
[INFORMATION]
INFORMATION [B-FV4 ]
[000000000001]
TOTAL FEED1 [0.00km]
TOTAL FEED2 [136cm]
[53.5inch]
TOTAL PRINT [0.00km]
TOTAL CUT [0]
[RS-232C]
BAUD RATE [9600]
BIT [8]
STOP BIT [1]
PARITY [None]
FLOW [XON/XOFF]
[LAN]
IP ADDRESS [192.168.010.020]
SUBNET MASK [255.255.255.000]
GATEWAY [000.000.000.000]
MAC ADDRESS [12-34-56-78-92-22]
DHCP [OFF]
DHCP CLIENT ID [FFFFFFFFFFFFFFFF]
[FFFFFFFFFFFFFFFF]
DHCP HOST NAME [ ]
[ ]
SOCKET COMM. [OFF]
SOCKET PORT [8000]

```

3.2.2 Dump Mode

The printer will enter the **Dump** mode after running a self test. In this mode, characters are printed in hexadecimal codes, allowing users and engineers to debug the system.

To return to the online mode:

- Turn off the printer, and turn it on again.

3.3 Resetting Your Printer

By resetting your printer, you can return your printer to the state it was in when you receive it. This can help you solve some problems caused by settings changed during the printing.

Do the following to reset your printer:

1. Turn off the printer.
2. Press and hold the **FEED** button, and turn on the printer.
3. Both status lights glow solid orange for a few seconds. Next, they turn to green shortly, and then turn to other colors. When both lights turn to red, release the **FEED** button immediately.
4. Press and hold the **FEED** button for 3 seconds and release it. Both status lights blink red three times, and turn to solid orange for a few seconds. After the printer is reset, LED 2 goes out while LED 1 turns to solid green.



Important In step 4, if you do not hold the **FEED** button long enough, LED 2 will blink orange three times while LED 1 goes out. It means the printer is not reset.

3.4 Media Sensing

B-FV4D printers offer two types of media sensor: transmissive and reflective. They are used for detecting specific media types.

3.4.1 Transmissive Sensor

The transmissive sensor is fixed and placed near the center of the printhead. It is used for detecting gaps across the entire width of the label.

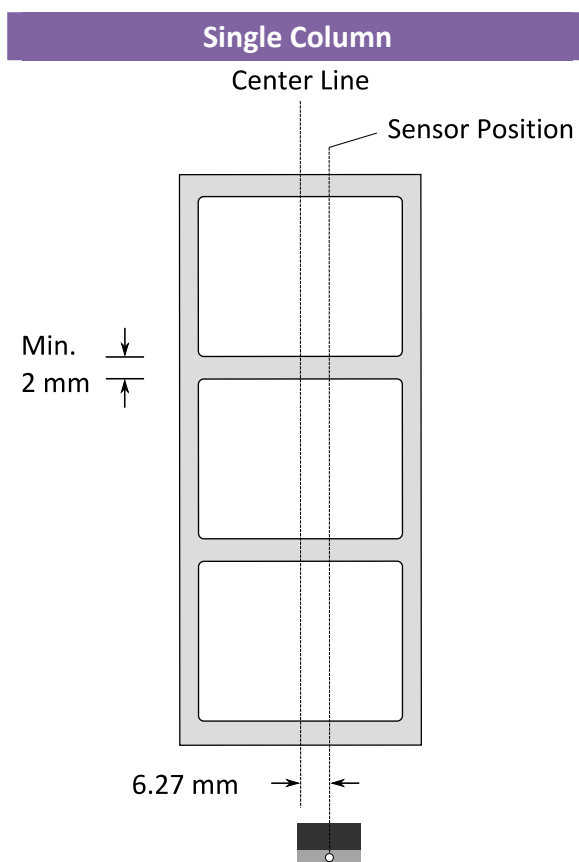

3.4.2 Reflective Sensor

The reflective sensor is movable within the entire width of the media. It detects gaps, notches and black marks not located at the center of the media.

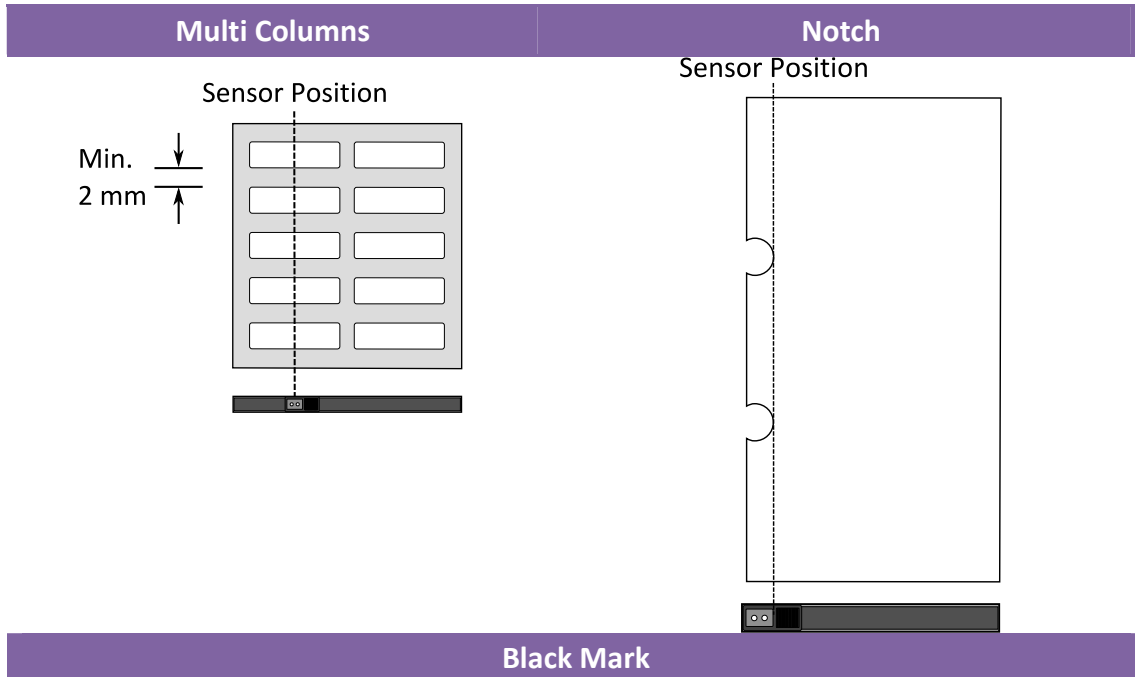

Flip the media so the black-mark side is facing down to align with the sensor.

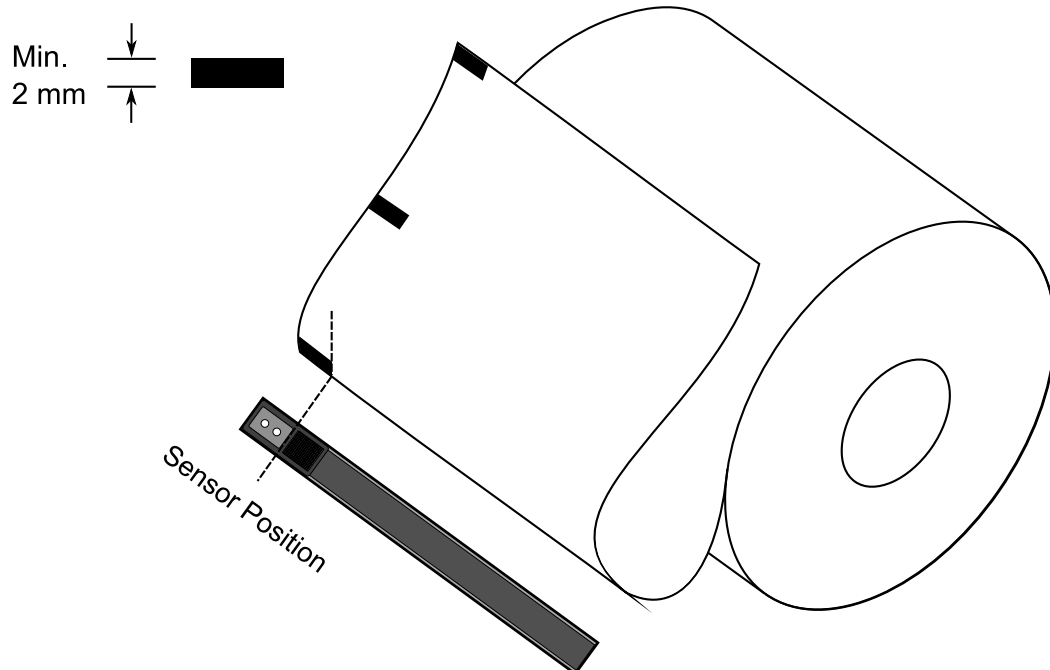

3.5 Wireless Connection (Optional)

Printers which have built-in Wi-Fi or Bluetooth are able to connect to the internet in a more flexible way. You can transmit data to your printers in any location within the range of the access point or Bluetooth.

3.5.1 Bluetooth

Before you use Bluetooth to connect your printer, make sure your computer or device has a built-in Bluetooth adapter. If your computer doesn't have it, get an adapter and plug it into the USB port. The Bluetooth setup screen may vary depending on your computer or device. In this article, we use a Windows XP computer as an example.

Do the following to set up a Bluetooth connection for your printer:

1. Click the Bluetooth icon in the notification area (system tray).



2. In the **Bluetooth Devices** dialog box, click **Add**.

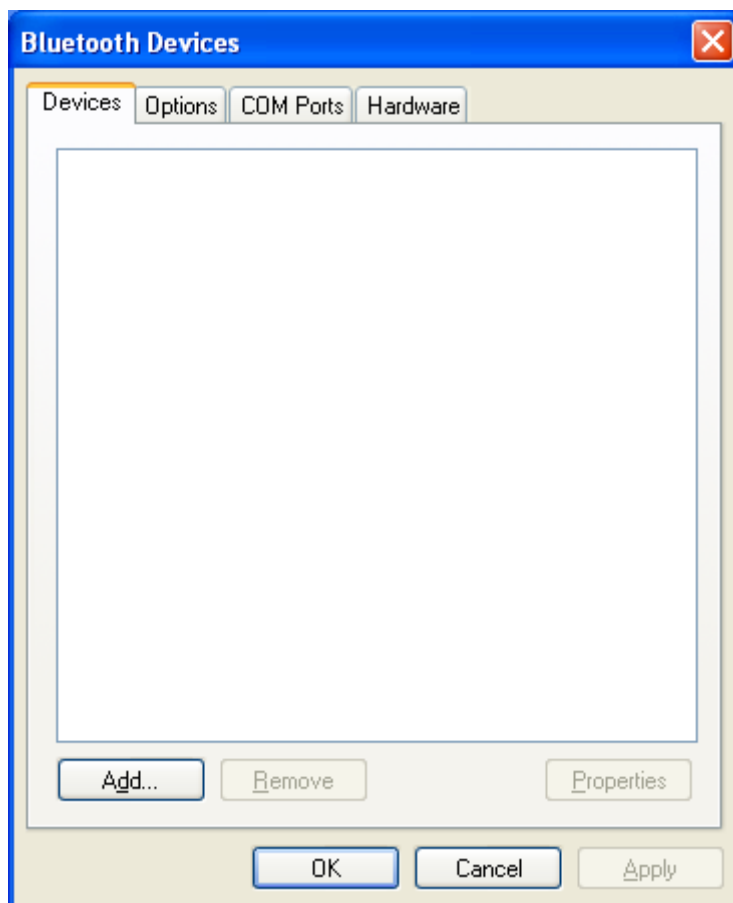

3. In the **Add Bluetooth Device Wizard** dialog box, select the **My device is set up and ready to be found** check box, and click **Next**.



4. Click **TOSHIBA B-FV4**, and click **Next**.

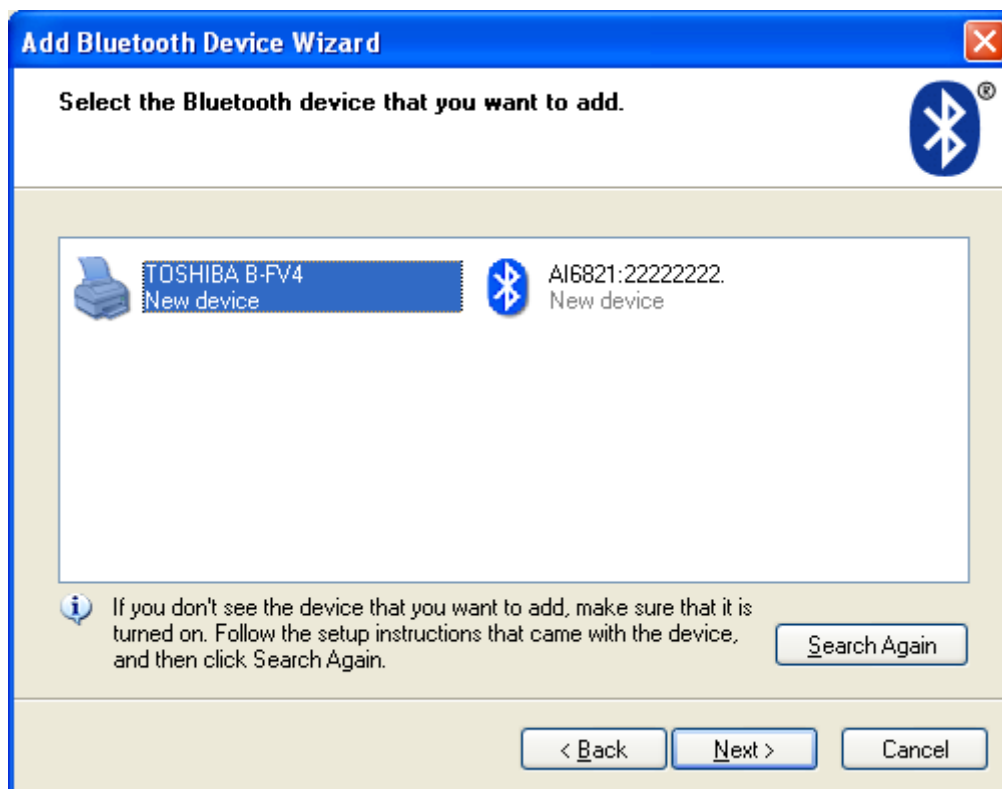

5. Click **Let me choose my own passkey**. The default key is **0000**. After entering the key, click **Next**.

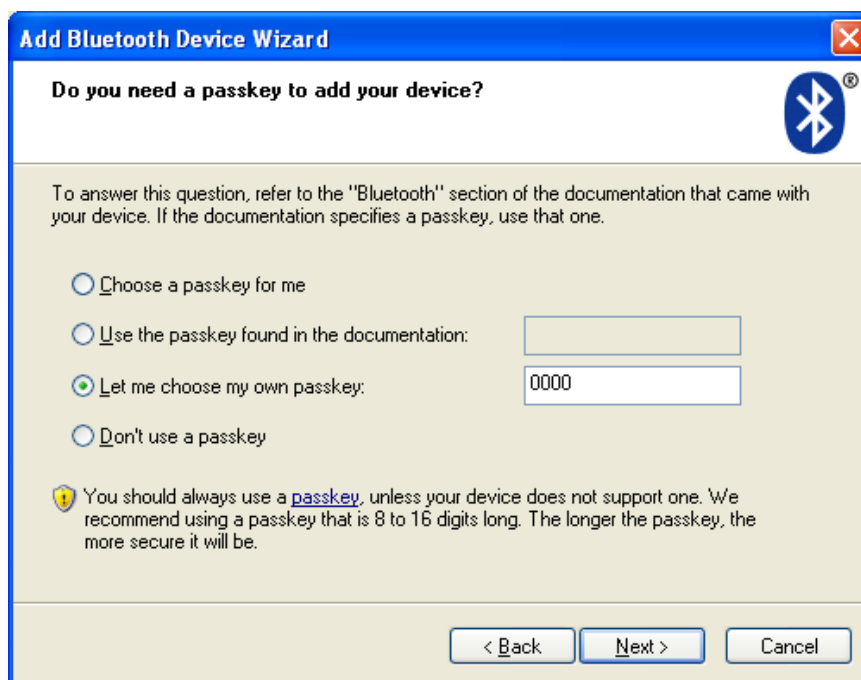

- The computer will try to connect the printer. If it succeeds, you'll see the successful message. Take a note of the outgoing COM port and click **Finish**.

Note If you forget the port number, in the **Bluetooth Devices** dialog box, click the **COM Ports** tab to see the virtual COM port assigned to the printer.



- Use any third-party application to transmit data to the printer, such as

Hyper Terminal. When you set up a connection in Hyper Terminal, choose the COM port you obtained in the previous step, so you can use Bluetooth to communicate with the printer.

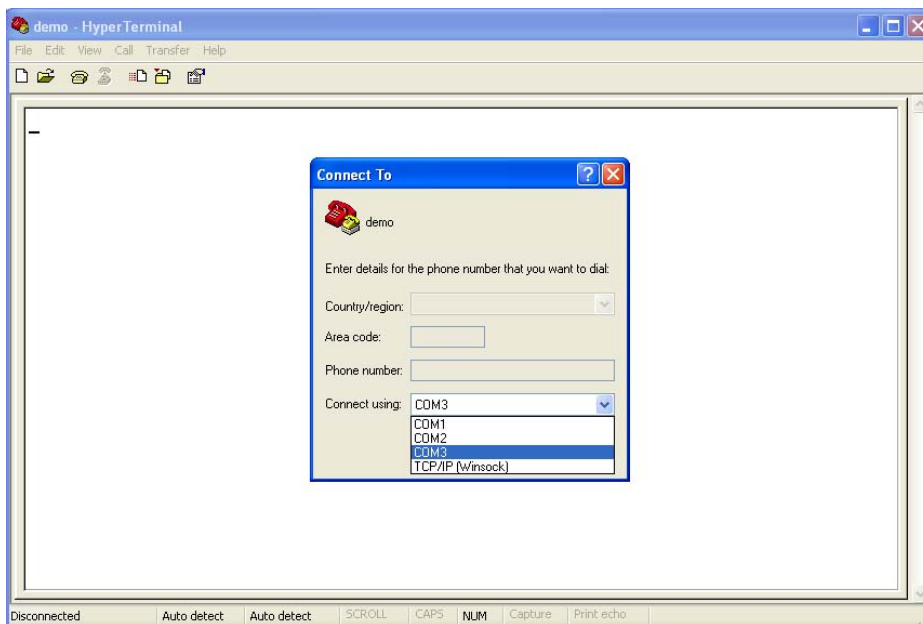

4 Maintenance

This chapter describes routine cleaning procedure.

4.1 Cleaning

To maintain print quality and prolong the printer's life, you need to perform some routine maintenance. Daily maintenance should be done for high volume printing, and weekly for low volume printing.



Caution Always turn off the printer before cleaning.

4.1.1 Printhead

It is essential to keep printhead clean if you want the best print quality. We strongly recommend that you clean the printhead when you load a new media roll. If the printer is operated in critical environment, or the print quality declines, you need to clean the printhead more frequently.

Keep in mind these things before you clean:

- Keep the water away in case of corrosion on heating elements.
- If you just finish printing, wait until the printhead cools down.
- Do not touch the printhead with bare hands or hard objects.

Cleaning steps:

1. Moisten a soft cloth or a cotton swab with ethyl alcohol.
2. Gently wipe the printhead in one direction. That is, wipe it only from left to right or vice versa. Do not wipe back-and-forth, in case dust or dirt attaches to the printhead again.

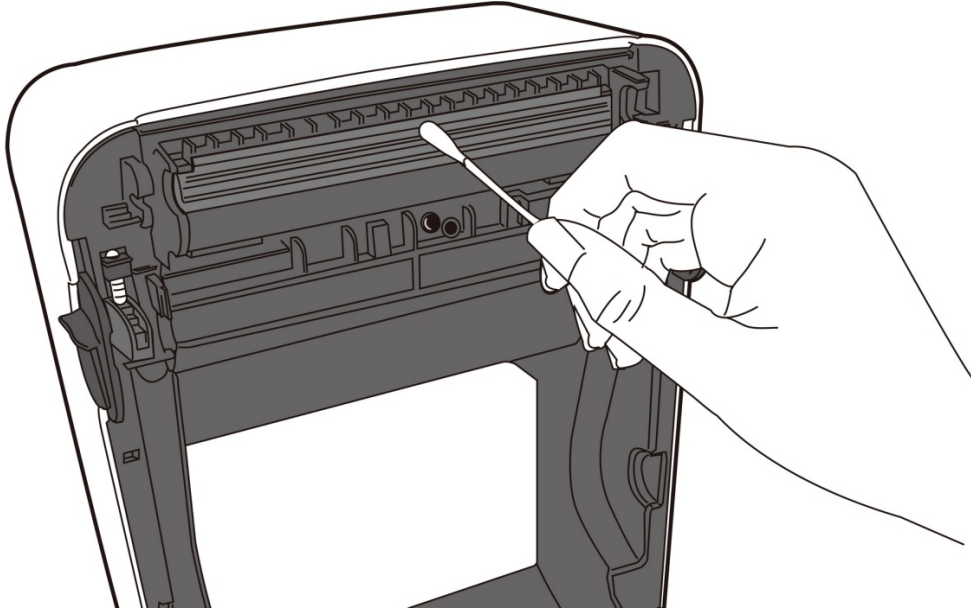

Important Printhead warranty becomes void if printhead's serial number is removed, altered, defected, or made illegible, under every circumstance.

4.1.2 Media Housing

Use a soft cloth to clean the dust, dirt or debris built up on the **Media Roll Holders**, **Media Guides** and media path.

1. Moisten a soft cloth with ethyl alcohol.
2. Wipe the **Media Roll Holders** to clean dust.
3. Wipe the **Media Guides** to clean dust and dirt.
4. Wipe the media path to clean paper debris.

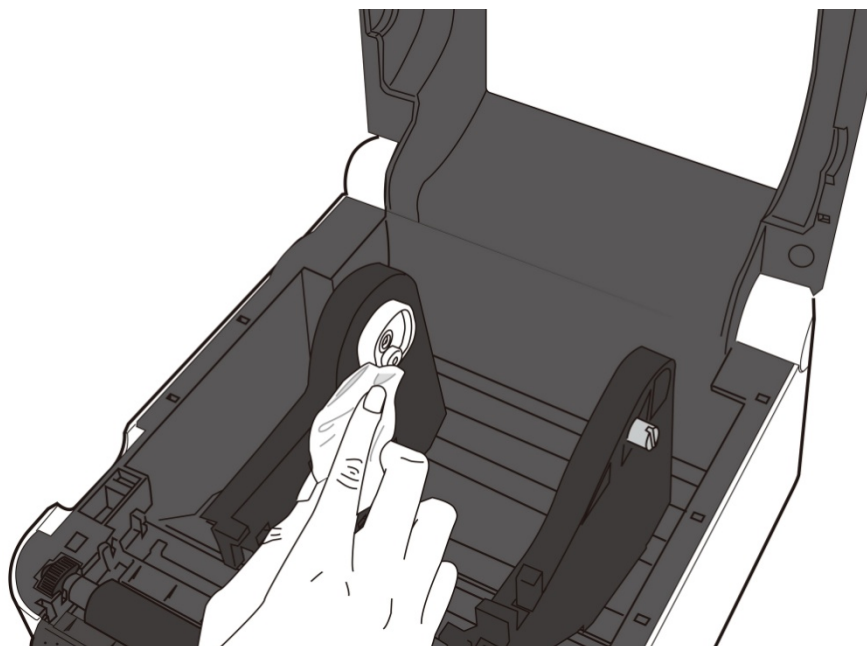

4.1.3 Sensor

Media sensors may not be able to detect the media correctly if it becomes dirty.

1. Moisten a soft cloth or a cotton swab with absolute ethyl alcohol.
2. Gently brush sensors to remove the dust away.
3. Use a dry cloth to clean the residue.

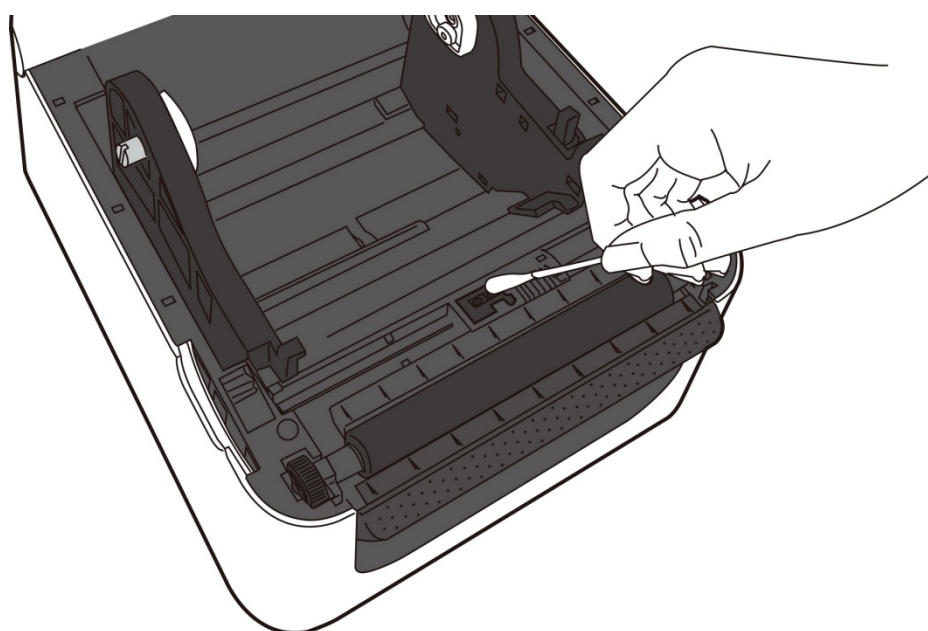

4.1.4 Platen Roller

The platen roller is also important for print quality. Dirty platen roller may damage the printhead. Clean the platen roller right away if the adhesive, dirt or dust accumulates on it.

1. Moisten a soft cloth with absolute ethyl alcohol.
2. Gently wipe the platen roller to remove the dust and adhesive.

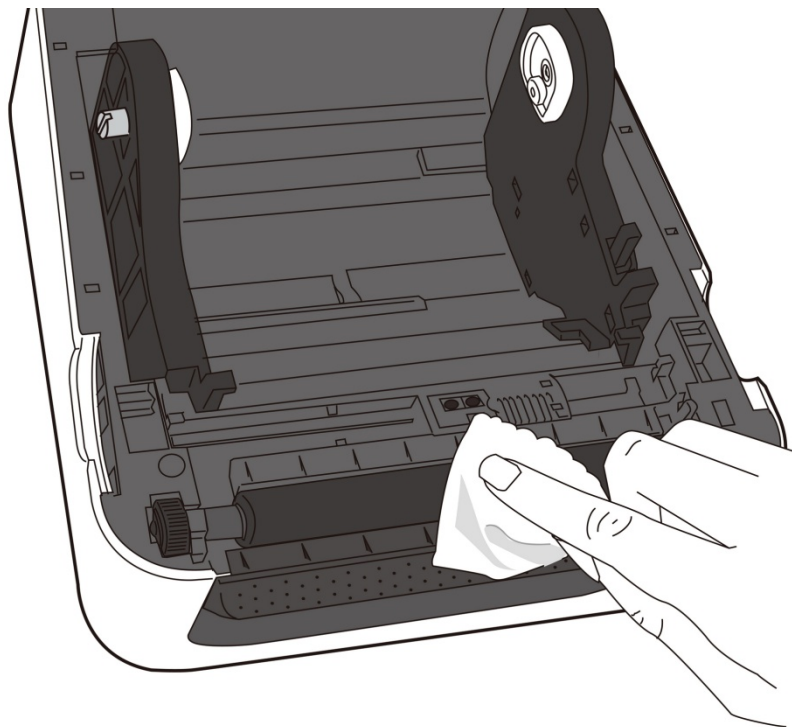

4.2 Replacing RTC Battery (Optional)

If your printer has a built-in real-time clock (RTC), you will find the RTC battery on the main board. The RTC battery keeps the RTC running when the printer is turned off, so the RTC can keep track of the current time. You can check the RTC battery from the status lights. If the RTC battery is low or out, you need to replace it with a new one.

Take the following steps to replace your RTC battery:

1. Turn on the printer.
2. Locate the battery on the main board.
3. Remove the old coin battery and install a new one.
4. Turn off the printer.

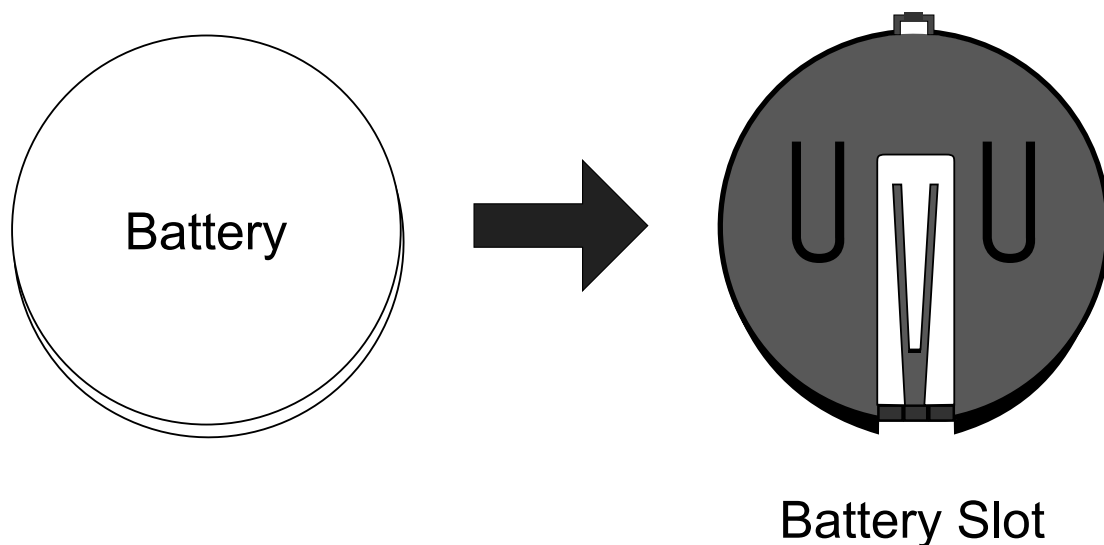

Caution Risk of explosion if battery is replaced by an incorrect type. Dispose of used batteries according to the instructions.

5 Troubleshooting

This chapter provides the information about printer problems and solutions.

5.1 Printer Issues

The printer won't turn on

- Did you attach the AC power cord?
- Make sure the power supply's connector is inserted into the printer power jack.
- Check the power connection from the wall socket to the printer. Test the power cord and the socket with other electrical devices.
- Disconnect the printer from the wall socket, and connect it again.

The printer turns itself off

- Turn on the printer again.
- Make sure the power supply's connector and the power cord are properly plugged.
- Make sure the power supply and the power cord are not damaged.
- Use the applicable power supply.
- If the printer keeps turning itself off, check the socket and make sure it has enough power for the printer.

The printer does not feed the media out

- The media is not loaded correctly. See Section 2.3, "Loading Media" to reload the media.
- If there is a paper jam, clear it.

5.2 Media Issues

The media is out

- Load a new media roll.

The paper is jammed

- Open the printer and clear the jammed paper.
- Make sure the paper is held properly by the **Media Guides**.

The printing position is not correct

- Did you use the correct media type for printing?
- The media is not loaded correctly. See Section 2.3, “Loading Media” to reload the media.
- The media sensor needs to be calibrated. See Section 3.1, “Media Sensor Calibration” to calibrate the sensor.
- The media sensor is dirty. Clean the media sensor.

Nothing is printed

- The media is not loaded correctly. See Section 2.3, “Loading Media” to reload the media.
- The print data might not be sent successfully. Make sure the interface is set correctly in the printer driver, and send the print data again.

The print quality is poor

- The printhead is dirty. Clean the printhead.
- The platen roller is dirty. Clean the platen roller.
- Adjust the print darkness, or lower the print speed.
- The media is incompatible for the printer. Use Toshiba-approved media roll instead.

5.3 Other Issues

There are broken lines in the printed label

- The printhead is dirty. Clean the printhead.

An error occurred when writing data to the USB memory

- Did you insert the USB drive?
- Make sure the USB drive is plugged tightly into the port.
- The USB drive might be broken. Replace it with another one.

The printer is unable to save files due to insufficient USB memory

- Delete the files on your USB drive to free some space, or replace your USB drive with an empty one.

The cutter is experiencing issues

- If there is a paper jam, clear it.
- The cutter has become loose. Fix the cutter in position and tighten it.
- The cutter blade is not sharp anymore. Replace your cutter with a new one.

The printhead temperature is extremely high

- The printhead temperature is controlled by the printer. If it is extremely high, the printer will stop printing automatically, until the printhead is cool down. After that, the printer will resume printing automatically, if there is any unfinished print job.

The printhead is broken

- Contact your local dealer for assistance.

6 Specifications

This chapter provides specifications for the printer.

6.1 Printer

Model	B-FV4D-GSXX-QM-R B-FV4D-GSXX-CN-R	B-FV4D-TSXX-QM-R B-FV4D-TSXX-CN-R
Print method	Direct Thermal	
Resolution	203 dpi (8 dots/mm)	300 dpi (12 dots/mm)
Media Alignment	Centered	
Operation Mode	Standard: Continuous mode , Tear-off mode Optional: Cutter mode , Peeler mode	
Sensor	Media Sensor: Gap Sensor (Transmissive, Fixed) I-Mark Sensor (Reflective, Movable) Head Open Switch	
Print Speed	2, 3, 4, 5, 6 inches/sec (50.8, 76.2, 101.6, 127, 152.4 mm/sec) 2 & 3 ips for peel off mode	2, 3, 4 inches/sec (50.8, 76.2, 101.6 mm/sec) 2 & 3 ips for peel off mode
Print Darkness	Darkness level – TPCL: -10 ~ +10, ZPL: 0 ~ 30 Default – TPCL: 00 (DT), ZPL: SD10	
Max Printable Area	Length 999 mm x Width 108 mm	Length 999 mm x Width 105.7 mm
Non-Printable Area	Pitch Direction - Top: 1 mm, Bottom: 1 mm (excluding liner) Width Direction - Left: 1 mm, Right: 1 mm (excluding liner)	
Print Ratio	Average print ratio within 15 % or less (whole print layout area) Full width with 1 mm pitch is required	
Interface	USB (Type A and Type B), Ethernet	
Optional Interface	RS-232C, Centronics (SPP Mode), Bluetooth	
Accessories	Peeler, Full Cutter, Partial Cutter, RTC, External Media Stand	
On-Board Memory	Standard Memory (Flash ROM): 16 MB User Memory: 3 MB	

	Standard Memory (SDRAM): 32 MB
External Memory	USB: Max 16 GB
Panel	2 LED, 1 Button
LED	1 st LED: Red and Green (Various Combinations: Orange) 2 nd LED: Red and Green (Various Combinations: Orange)
Font	Standard: See the TEC Command Reference Extended: Download with B-FV Setting Tool

6.2 Media

Properties	Description
Media Size	Continuous Mode Length: 8 mm ~ 997 mm Width: 22.4 mm ~ 115 mm (including liner 25.4 ~ 118 mm)
	Tear-Off Mode Length: 30 mm ~ 997 mm Width: 22.4 mm ~ 115 mm (including liner 25.4 ~ 118 mm)
	Peel-Off Mode Length: 35 mm ~ 150.4 mm Width: 22.4 mm ~ 115 mm (including liner 25.4 ~ 118 mm)
	Cut Mode Length: 35 mm ~ 993 mm Width: 22.4 mm ~ 115 mm (including liner 25.4 ~ 118 mm) Max Roll Diameter Size: 127 mm (5 inches) Max Roll Diameter Size for External Media Stand: 203.2 mm (8 inches)
Media Type	Direct Thermal Label Direct Thermal Tag Roll Paper (Inside Wound or Outside Wound) Fanfold Paper

6.3 Bar Code

Programming Language	TPCL	Non-TPCL
One Dimensional Bar Code	JAN8/EAN8	UPC-A
	JAN13/EAN13	UPC-E
	UPC-E	JAN/EAN
	EAN13+2 digits	CODE39
	EAN13+5 digits	CODE93
	CODE128 (with auto code selection)	CODE128
	CODE128 (without auto code selection)	GS1-128 (UCC/EAN128)
	CODE93	CODABAR (NW-7)
	UPC-E+2 digits	ITF
	UPC-E+5 digits	Industrial 2of5
	EAN8+2 digits	MSI
	EAN8+5 digits	UPC add-on code
	UPC-A	POSTNET
	UPC-A+2 digits	GS1 DataBar
	UPC-A+5 digits	Omnidirectional
	UCC/EAN128	GS1 DataBar Truncated
	POSTNET	GS1 DataBar Stacked
	RM4SCC	GS1 DataBar Stacked
	KIX CODE	Omnidirectional
	USPS Intelligent mail barcode	GS1 DataBar Limited
	MSI	GS1 DataBar Expanded
	Interleaved 2 of 5 (ITF)	GS1 DataBar Expanded Stacked
	CODE39 (standard)	
	NW7	
	CODE39 (full ASCII)	
	Industrial 2 of 5	
	Two Dimensional Bar Code	QR Code
PDF417		PDF417 (including MicroPDF)
MicroPDF		DataMatrix (ECC200)
DataMatrix (ECC200) (FNC1 supported)		GS1 DataMatrix

Programming Language	TPCL	Non-TPCL
	MaxiCode	MaxiCode
Composite Symbol	GS1 DataBar (Truncated)	EAN-13 Composite
	GS1 DataBar Stacked	(CC-A/CC-B)
	GS1 DataBar Stacked Omnidirectional	EAN-8 Composite (CC-A/CC-B)
	GS1 DataBar Limited	UPC-A Composite
	GS1 DataBar Expanded	(CC-A/CC-B)
	GS1 DataBar Expanded Stacked	UPC-E Composite (CC-A/CC-B)
	UPC-A	GS1 DataBar Composite
	UPC-E	(CC-A/CC-B)
	EAN-13	GS1 DataBar Truncated
	EAN-8	Composite (CC-A/CC-B)
	UCC/EAN-128 with CC-A or CC-B	GS1 DataBar Stacked Composite (CC-A/CC-B)
	UCC/EAN-128 with CC-C	GS1 DataBar Expanded Stacked Composite (CC-A/CC-B)
		GS1 DataBar Expanded Composite (CC-A/CC-B)
		GS1 DataBar Stacked Omnidirectional Composite (CC-A/CC-B)
		GS1 DataBar Limited Composite (CC-A/CC-B)
		GS1-128 Composite (CC-A/CC-B/CC-C)

6.4 Bluetooth

Properties	Bluetooth I/F
Standard	Bluetooth 2.1 + EDR or later
Enable Device	B-FV4 Series
Operating Temperature	41°F (5°C) ~ 104°F (40°C)
Storage Temperature	-4°F (-20°C) ~ 140°F (60°C)
Operating Humidity	25 ~ 85 % Non-condensing R.H
Storage Humidity	10 ~ 90 % Non-condensing R.H
Connection Form	Only one-to-one connection is supported.
Support Profile	Serial Port Profile (SPP) PIN code is supported.
Class of Radio Transmission	CLASS 2
Transmission Method	Bi-directional (Half-duplex)
Flow Control	Credit based flow control
Operating Mode	Slave Mode
Transmission Distance	3 m (360 degrees)
SR Mode in Page/Inquiry Scanning	R1 Scan Interval 1.28 sec. Scan Window 22.5 msec.
RF Frequency Range	2402 ~ 2480 MHz
Nominal Output Power	+4 dBm (2.51 mW) MAX

6.5 Electrical and Operating Environment

Properties	Range
Power Supply	Voltage: AC 100 V ~ 240 V \pm 10 % (full range) Frequency: 50 Hz - 60 Hz \pm 5 %
Power Consumption	90 W
Temperature	Operating: 5 °C ~ 40 °C Storage: -40 °C ~ 60 °C
Humidity	Operating: 25 %RH ~ 85 %RH (non-condensing) Storage: 10 %RH ~ 90 %RH (non-condensing)

6.6 Physical Dimension

Dimension	Size and Weight
Size	W 183.5 mm x D 225.5 mm x H 165.9 mm
Weight	Approx. 1.75 kg (excluding media and options) or less

6.7 Interfaces

This section provides information about IO port specifications for the printer.

6.7.1 USB

There are two common USB connectors. Typically, type A is found on hosts and hubs; type B is found on devices and hubs. The figure below shows their pinouts.

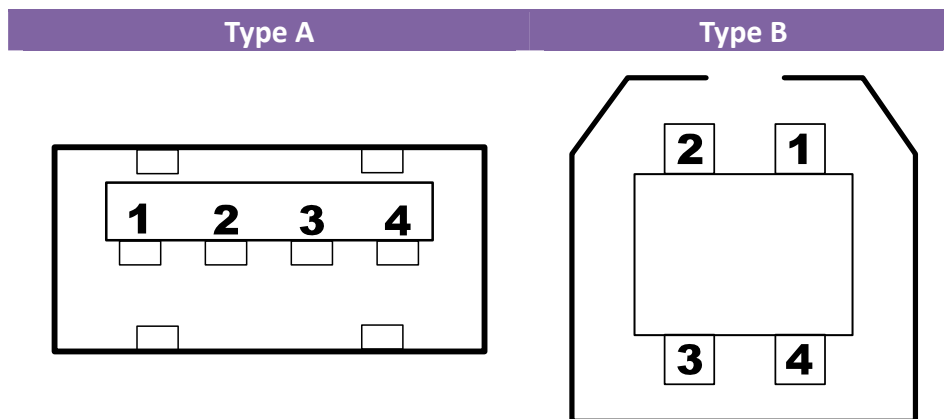

Pin	Signal	Description
1	VBUS	+5V
2	D-	Differential data signaling pair -
3	D+	Differential data signaling pair +
4	Ground	Ground

6.7.2 Ethernet

The Ethernet uses RJ-45 cable, which is 8P8C (8-Position 8-Contact). The figure below shows its pinout.

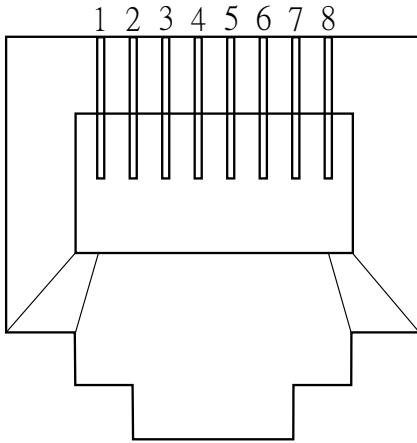

Pin	Signal
1	Transmit+
2	Transmit-
3	Receive+
4	Reserved
5	Reserved
6	Receive-
7	Reserved
8	Reserved

6.7.3 RS-232C

The RS-232C on the printer is DB9 female. It transmits data bit by bit in asynchronous start-stop mode. The figure below shows its pinout.

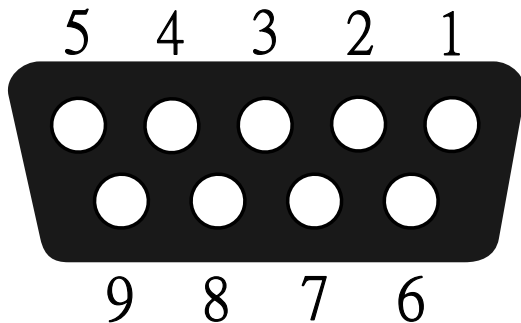

Pin	Signal	Description
1	+5V	Provide 5V Power
2	TxD	Transmit
3	RxD	Receive
4	CTS	Clear to Send
5	GND	Ground
6	RTS	Request to Send
7	NC	No Connection
8	RTS	Request to Send
9	NC	No Connection

Host (DB9)			Printer (DB9)		
Signal	Description	Pin	Pin	Description	Signal
CD	Carrier Detect	1	1	Provide 5V Power	+5V
RxD	Receive	2	2	Transmit	TxD
TxD	Transmit	3	3	Receive	RxD
DTR	Data Terminal Ready	4	4	Clear to Send	CTS
GND	Ground	5	5	Ground	GND
DSR	Data Set Ready	6	6	Request to Send	RTS
RTS	Request to Send	7	7	No Connection	NC
CTS	Clear to Send	8	8	Request to Send	RTS
CI		9	9	No Connection	NC

6.7.4 Centronics

The 36-pin Centronics on the printer uses parallel communication, and complies with IEEE 1284 compatibility mode (also called SPP, Standard Parallel Port). The figure below shows its pinout.

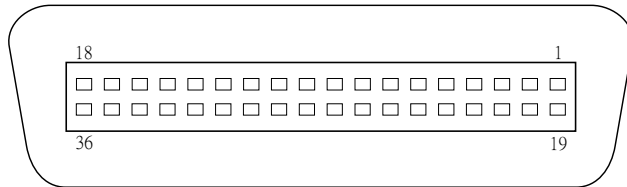

Pin	Signal Direction	Signal	Pin	Signal Direction	Signal
1	To Printer	DATA•STB	19	Ground	TWISTED PAIR GND (PIN1)
2	To Printer	Data 1	20	Ground	TWISTED PAIR GND (PIN2)
3	To Printer	Data 2	21	Ground	TWISTED PAIR GND (PIN3)
4	To Printer	Data 3	22	Ground	TWISTED PAIR GND (PIN4)
5	To Printer	Data 4	23	Ground	TWISTED PAIR GND (PIN5)
6	To Printer	Data 5	24	Ground	TWISTED PAIR GND (PIN6)
7	To Printer	Data 6	25	Ground	TWISTED PAIR GND (PIN7)
8	To Printer	Data 7	26	Ground	TWISTED PAIR GND (PIN8)
9	To Printer	Data 8	27	Ground	TWISTED PAIR GND (PIN9)
10	From Printer	/ACK	28	Ground	TWISTED PAIR GND (PIN10)
11	From Printer	BUSY	29	Ground	TWISTED PAIR GND (PIN11)
12	From Printer	PE	30	Ground	TWISTED PAIR GND (PIN31)
13	From Printer	SELECT	31	-	/INIT (Not Used)
14	-	/AUTOFD (Not Used)	32	From Printer	/FAULT
15	-	NC	33	Ground	GND
16-17	Ground	GND	34-35	-	NC
18	-	+5V	36	-	/SELECTIN (Not Used)

Installation Manual for the B-FV704D-BLTH-QM-R Bluetooth Interface

WARNING!

1. Carefully read and follow all the instructions in this manual. Failure to do so could create safety hazards such as fire or electric shocks.
 - *Instructions in this manual must be followed when installing option kits or adding cables to avoid system failures and to insure correct performance and operation.*
 - *Failure to follow the manual's instructions or any unauthorized modifications, substitution or change to this product will void the product warranty.*
2. Before installing this option, be sure to turn off the power switch and disconnect the power adapter connector from the printer.

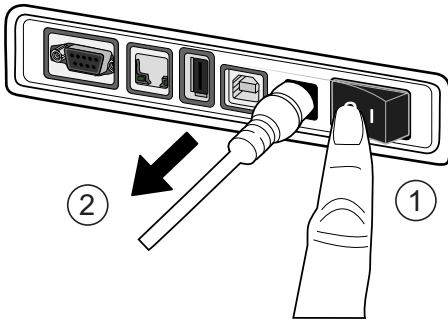

3. Take care not to trap or pinch your fingers or hands with the covers.
4. Before installing this option, remove the media from the printer.

1. APPLICABLE MODEL

This optional module is the Bluetooth interface, which is designed for the following models:

- B-FV4D Series

Remark:

This optional module complies with Bluetooth V2.1 + EDR standards.

Note:

This optional module and the B-FV700-WLAN-QM-R Wireless LAN Interface option cannot be installed at the same time.

2. PACKING LIST

All the following parts are supplied with the option. Make sure you have all the items shown listed below.

- Bluetooth Interface (1 pc.)



- M-3 P-Tite Screw (2 pcs.)



- Installation Manual (1 copy)

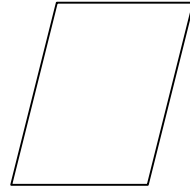

- RF Certification Label



3. INSTALLATION PROCEDURE

- 1) Turn off the printer power, disconnect the power plug from the AC outlet, and disconnect the AC adapter from the printer.
- 2) Place the printer on the soft cloth to prevent scratching the surface of the printer, and remove the 4 screws provided at the Bottom Cover.

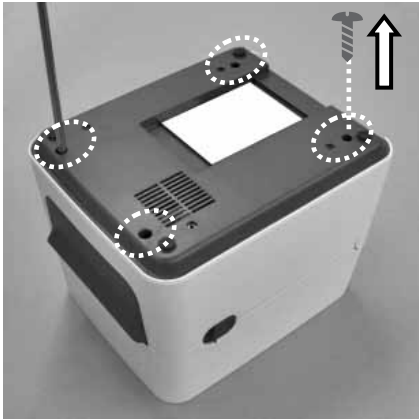

- 3) Remove the Bottom Cover by removing the 6 connectors from the main board.

Connectors to be detached

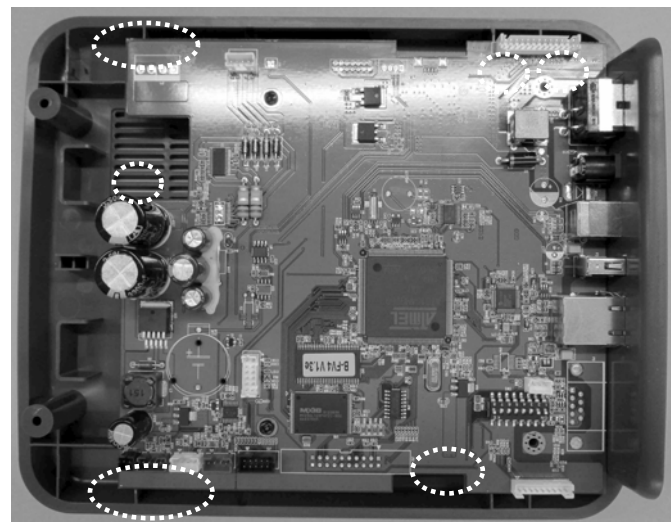
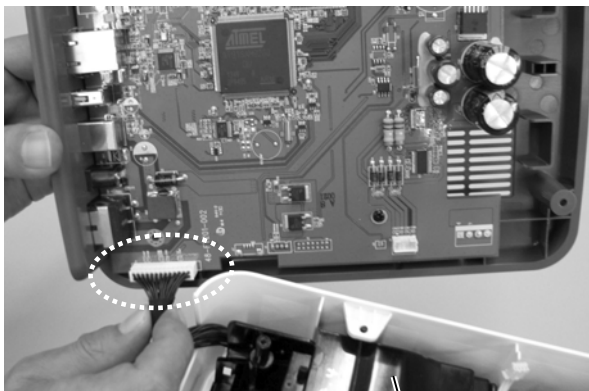

Bottom Cover

4) Remove the Printer Cover.

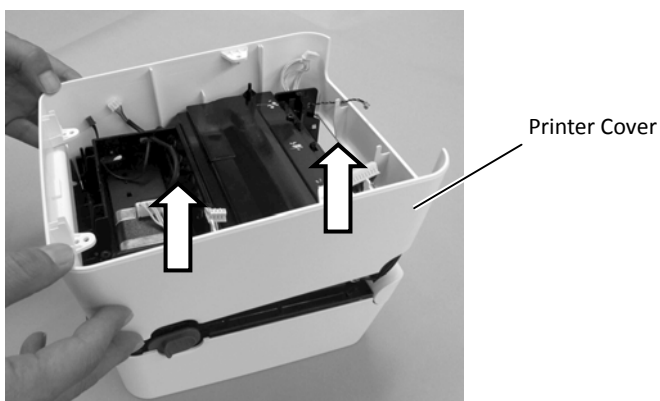

5) Secure the Bluetooth Interface with the 2 screws provided (M-3 P-Tite screws).

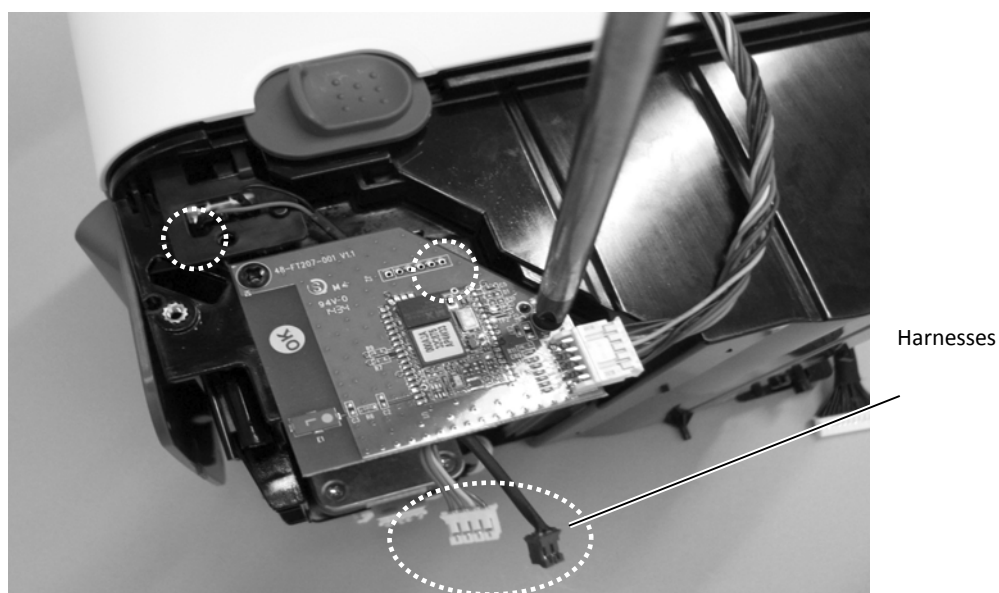

Note:

When securing the interface, prevent the two harnesses from being trapped between the interface board and the printer frame.

6) Attach the Printer Cover.

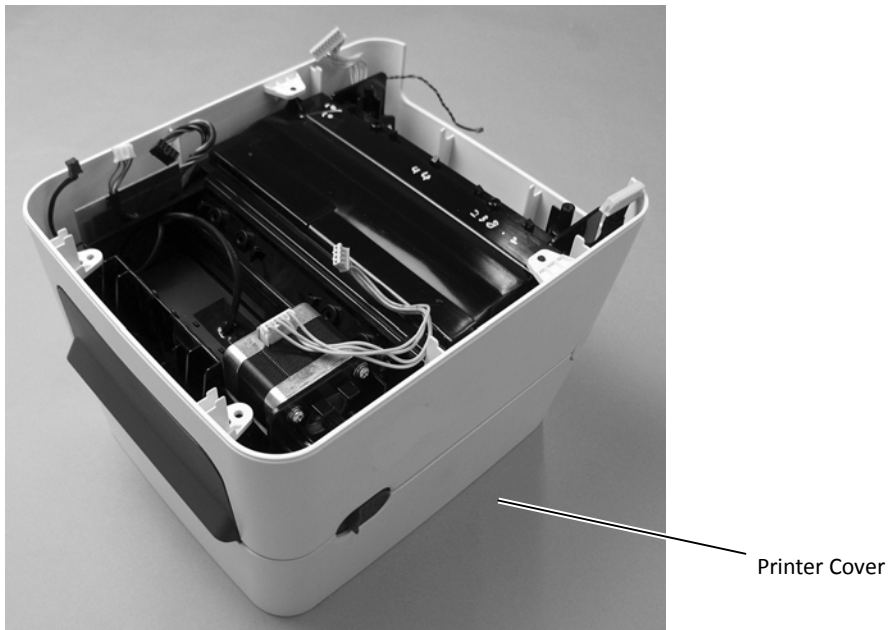

Note: When fitting the Printer Cover, prevent the harness from being trapped between the covers.

7) Connect the harness connector to the connector "J15" (black) on the main board.

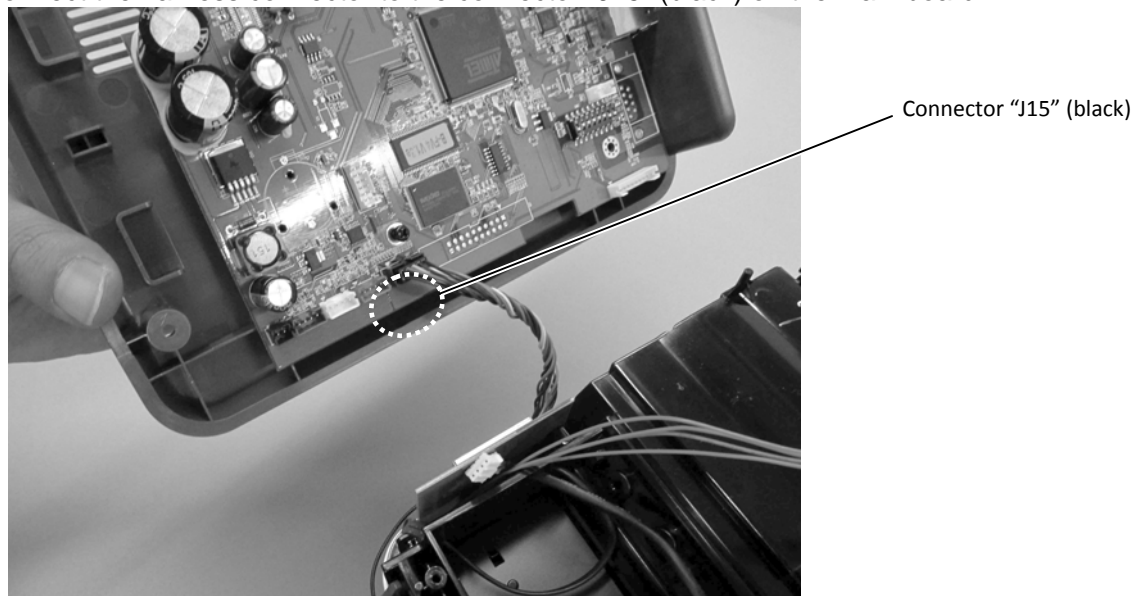

8) Return the 6 connectors to the original positions, which were removed in Step 3.

9) Fix the Bottom Cover by securing the 4 screws which were removed in Step 2.

Note: When fitting the Bottom Cover, prevent the harness from being trapped between the covers.

10) Peel off the backing sheet of the RF Certification Label and attach it to the position as shown below.

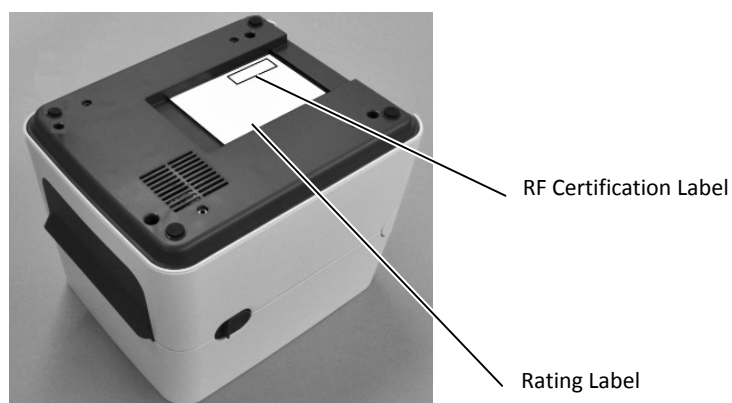

Note:

Be sure not to cover the contents described on the rating label when the RF Certification Label is attached to the upper right corner.

11) Close the Top Cover.

The installation is now completed.

TOSHIBA TEC CORPORATION

© 2015 TOSHIBA TEC CORPORATION All Rights Reserved
1-11-1, Osaki, Shinagawa-ku, Tokyo 141-8562, JAPAN