

XM SureConnect Vehicle Installation Guide

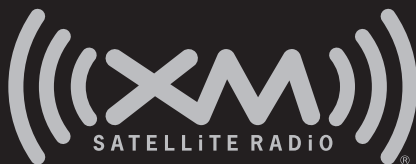

Important: Be sure to read the information on pages 4 and 5 carefully to determine if the XM SureConnect vehicle installation method is appropriate for your vehicle. Please reference the user and installation guides for your XM Satellite Radio receiver for additional information about optional installation methods like using the cassette adapter or Professional Wired FM.

FCC Information

Please note that the power cable that has been supplied with your device is supplied with permanently attached ferrite beads. It is the responsibility of the user to use the power cable with the ferrite beads.

The user is cautioned that changes or modifications not expressly approved by XM Satellite Radio Inc. can void the user's authority to operate this device.

This device complies with Part 15 of the FCC Rules. Operation is subject to the following two conditions:

- (1) This device may not cause harmful interference.
- (2) this device must accept any interference received, including interference that may cause undesired operation.

This equipment has been tested and found to comply with the limits for a Class B digital device, pursuant to Part 15 of the FCC Rules. These limits are designed to provide reasonable protection against harmful interference in a residential installation.

This equipment generates, uses, and can radiate radio frequency energy and, if not installed and used in accordance with the installation instructions, may cause harmful interference to radio communications. However, there is no guarantee that interference will not occur in a particular installation. If this equipment does cause harmful interference to radio or television reception, which can be determined by turning the equipment off and on, the user is encouraged to try to correct the interference by one or more of the following measures:

- Reorient or relocate the receiving antenna of the affected receiver.
- Increase the separation between the XM equipment and the affected receiver.
- Connect the XM equipment into an outlet on a circuit different from that to which the affected receiver is connected.
- Consult the dealer or an experienced radio/TV technician for help.



Warning: The FCC and FAA have not certified the receiver for use in any aircraft (neither portable nor permanent installation). Therefore, XM Satellite Radio cannot support this type of application or installation.

FCC Information	2
Choosing the Proper XM SureConnect Installation	4
Installation Locations	5
Installation Setup Overview for Option 1 and Option 2	6
Option 1	
External FM Antenna Coupling Clip Installation	8
External FM Antenna Cable Routing	9
Option 2	
Internal On-Glass FM Antenna Installation	10
Internal On-Glass Antenna Contact Bracket Installation	12
Internal On-Glass Antenna Cable Routing	14
Additional Information	15



Warning: This guide contains important installation information. Please read, understand, and follow the instructions in this guide. Failure to do so could result in personal injury, death, and/or damage to your XM Satellite Radio receiver, accessories, and/or to your vehicle or property.

Caution: Use your XM SureConnect accessory with only the enclosed components and approved connectors. Do not modify wires or other connectors in any way; you could cause a malfunction, which could damage your receiver and will void your warranty.

Choosing the Proper XM SureConnect Installation

To choose the proper XM SureConnect installation method, first you need to determine the location of your vehicle's FM antenna, and plan how to properly route the XM SureConnect cables to your FM antenna location.

The FM antenna type and location will determine which option you will need. The chart below and illustrations on page 5 will assist you in locating your vehicle's FM antenna from one of seven most common locations.

Note: XM SureConnect was not designed for use on retractable (automatic up and down) FM antennas and some FM antennas that are custom shapes that were designed to match the styling of the vehicle. If your vehicle has either of these types of FM antennas, you will not be able to use the XM SureConnect accessory. You will need to use the professional wired FM method of installation.

For best audio performance, you will either install the XM SureConnect by clipping directly to an external FM antenna (locations 1 through 4) or directly on an internal on-glass FM antenna (locations 5 through 7) using the window Contact Bracket included.

You will either use...

Option 1

or

Option 2

External FM Antenna	Internal On-Glass FM Antenna
1 Front fender	5 Located at top of windshield
2 Rear fender	6 Located at top of rear window
3 Roof top front	7 Located on rear side glass (in some SUVs)
4 Roof top back	

Installation Locations

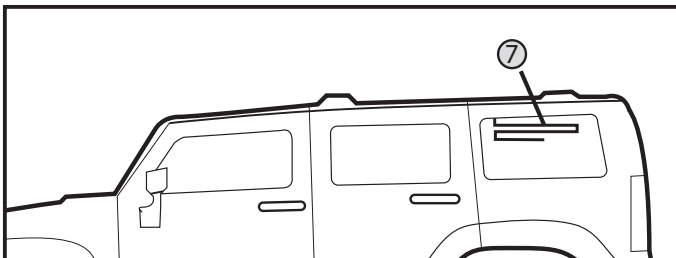
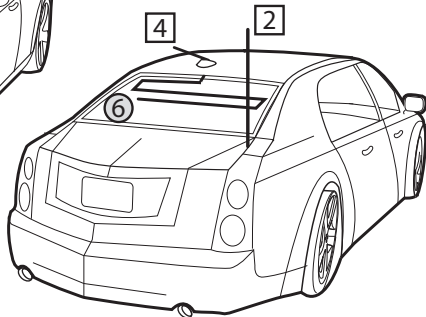
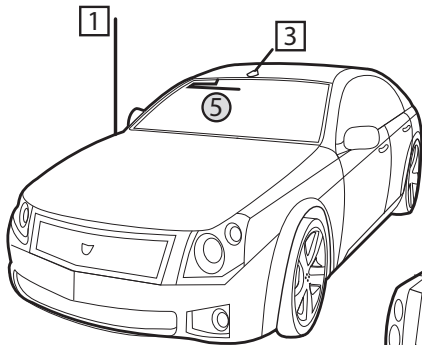

Installation Setup Overview for both Options 1 and 2

The following steps will guide you through the installation of your XM SureConnect using either option 1 or option 2.

1. Install your XM Radio in your vehicle as described in your XM Radio user and installation guides, but do not connect the XM antenna plug to the dock at this time.
2. Now that you have located your vehicle's FM antenna, determine the best routing method to get the XM SureConnect output cable to the FM antenna. For **external antennas** (Figure 1b), the Coupling Clip needs to be routed outside the vehicle. For **internal on-glass antennas** (Figure 1c), all routing is inside the passenger compartment and the Contact Bracket is used.
3. To route the output cable with Coupling Clip to your vehicle FM antenna, follow the instructions on the next pages . There are separate instructions for external antenna vs the internal on-glass antenna. Follow the instructions that apply to your vehicle's antenna type.

Note: This guide assumes you have already installed your XM antenna per the instructions in your XM radio user guide. The positions of the XM antenna in the illustrations on page 9 are for example only. There is no need to change your XM antenna installation.

4. Connect the XM antenna to the XM SureConnect antenna input, located on the coupler module about 2 feet from the end of the input cable (see Figure 1a). Tuck any excess input cable and the coupler module behind the dash or in another hidden location for a professional looking installation.
5. Now connect the XM SureConnect input cable to the XM radio or vehicle dock's XM antenna input.

Common connections for both options 1 and 2

Connecting the Components

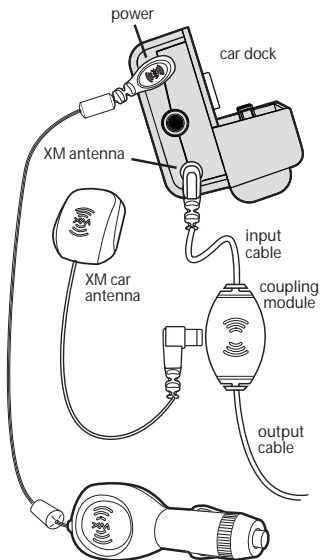

Figure 1a

Option 1

External Antenna

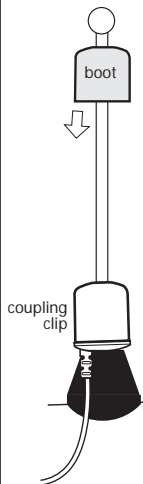

Figure 1b

Option 2

Internal on-glass antenna no boot necessary

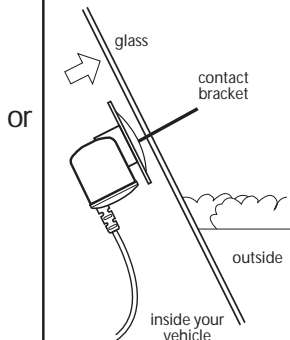

Figure 1c

Option 1: External FM Antenna Coupling Clip Installation

Note: If you determined you need to use Option 2, turn to page 10 and begin.

Step 1:

If you have an external or roof mount FM antenna, attach the Coupling Clip directly to the base of the antenna as illustrated in Figure 2. Cover the clip with the rubber boot provided to protect and secure the clip. Secure the cable inside the trunk or hood to avoid interference or accidental damage. Installing the Coupling Clip first will avoid having excess cable outside the vehicle.

- Snap the Antenna Coupling Clip into place.
- Slide the boot over the top of your antenna.
- Slide the boot down the antenna so it covers the clip.

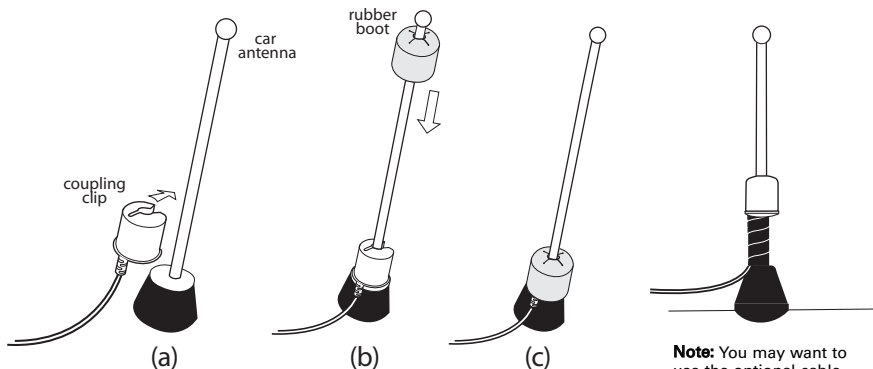

Figure 2

Note: You may want to use the optional cable wrap for a more secure solution.

External FM Antenna Cable Routing

In the front, route the cable across the weather seal near the bottom of the door to reduce water leaks. Once inside the car, tuck the XM SureConnect output cable into the door jam up to the dash or under the carpet as shown in Figure 3.

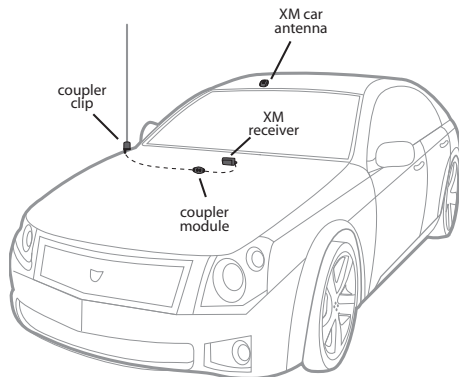

Figure 3

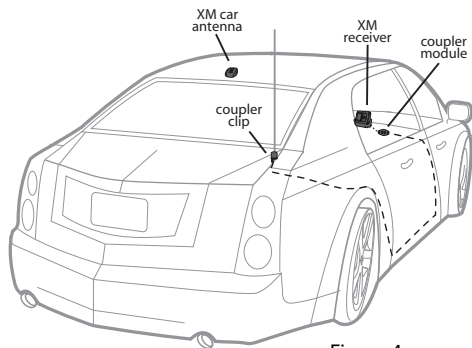

Figure 4

In the rear, always cross the weather seal at the lowest part of the trunk to reduce water leaks. Route the cable from the trunk into the vehicle through available wire channels. Next, route through the rear passenger compartment. Tuck the cable under the door jam trim or under the carpet to the XM Receiver as shown in Figure 4.

Note: XM antenna cables are not illustrated.

Option 2: Internal On-Glass FM Antenna Installation

Identifying the On-Glass FM Antenna in Your Vehicle

Useful Information for Step 1:

CAUTION: Do not attach the contact bracket to the rear defogger elements. In some vehicles they look similar to the FM Antenna.

You can distinguish the FM Antenna Elements from the Defogger Elements by several key features. See Figure 5.

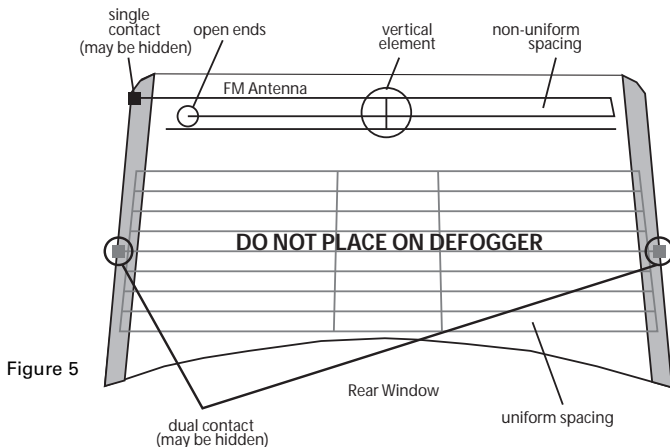

1. The FM antenna is typically found on the top 6 to 8 inches of the rear window while the Defogger is located below.
2. The FM antenna has open ends (connected to nothing) and the Defogger does not.
3. The FM antenna will have a single contact point and the Defogger will have two, which are typically on opposite sides of the window. The contact points may be hidden behind interior liners or exterior glass tinting but the key is to locate where the elements extend beyond the window edge. The FM antenna will have only one location while the defogger can have two or more.

Internal On-Glass FM Antenna Contact Bracket Installation

Step 1:

Install the Contact Bracket on the interior window surface over the antenna element using the adhesive pad provided and the following steps. It may be mounted either vertical or horizontal depending on the portion of the antenna element most easily accessed. Select a bracket position that allows room to attach the Coupling Clip and cleanly run cables without blocking the driver's view. Install the on-glass antenna Coupling Clip before routing the cable to avoid excess cable. See Figure 6.

- a. Clean the mounting location on the glass for the Contact Bracket with any household window cleaner that will remove grime. Be sure the surface is completely dry before proceeding. You may need to use your vehicle's air conditioning and/or defogger to keep the cleaned surface dry during the installation for the adhesive to set properly.
- b. Remove the red liner from the adhesive pad and press the Contact Bracket firmly to the identified mounting location on the glass. You can also view the alignment through the glass from outside the vehicle. You will have only a limited amount of time to reposition the Contact Bracket before the adhesive cures.
- c. The Contact Bracket has alignment arrows on the side opposite the adhesive pads. These arrows indicate the contact strip location on the base of the bracket. Align the arrows with the on-glass antenna element to ensure direct contact between the strip and the element. Press and hold the Contact Bracket in place for 10 to 15 seconds.
- d. Once the Bracket is in place, attach the Coupling Clip to the bracket flange and route any excess cable behind liners for a professional look.

Contact Bracket and Coupling Clip Installation (continued)

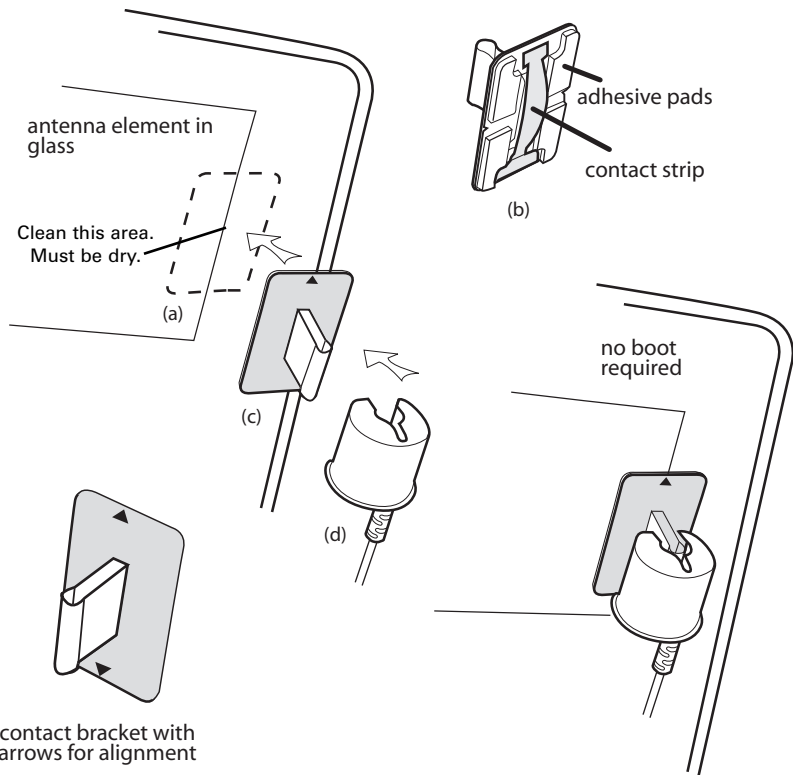

Figure 6

Internal On-Glass FM Antenna Cable Routing

Step 2:

In the rear, route the XM SureConnect output cable from the antenna element, along the window edge, down to the window liner. From the rear passenger compartment tuck the cable under the carpet or door jam trim until you reach the front dash area, ending at the XM Receiver. (See Figure 7.)

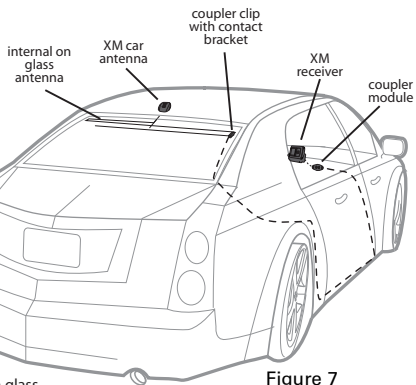

Figure 7

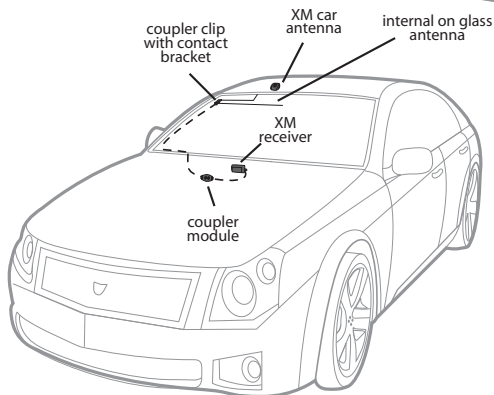

Figure 8

In the front, route the XM SureConnect output cable from the antenna element, along the windshield edge, down to the window liner along the floor and up to the dash as shown in Figure 8.

Note: XM antenna cables are not illustrated.

Note: When routing the XM SureConnect cable use pre-existing wire channels whenever possible to avoid loose wires on the interior of the vehicle which are susceptible to damage and to maintain a professional looking installation. Route cable carefully by taking notice of how doors open and close, as well as how seats move when they are adjusted so you can be certain there is ample clearance provided for the cable.

Avoid inadvertent damage that may be caused by kinking, crimping, twisting or chafing the cables. Secure and tie wrap the excess cable under your dash board, between the seat and the console, or on the floor under a seat or floor mat. Securing the excess cable will help to prevent it from interfering with the everyday use of your vehicle, improve the appearance of the installation, and avoid any undesirable accidental damage to the cables that might result in loss of satellite signal or XM SureConnect performance.

Important Information:

- When attempting to remove the XM SureConnect from either method of installation, be sure to remove the “boot” first if applicable and pull the Coupling Clip away by lifting from the end where the cable enters the clip. Squeezing the Coupling Clip in the middle may pinch the contacts inside and make removing the clip more difficult.
- Once installed, if you experience interference problems with your AM reception, your vehicle’s electrical system may require you to unplug the power adapter when your XM Satellite Radio is not in use.
- If you installed the XM SureConnect using Option 1, it is recommended that you use brushless or touchfree car washes or hand wash your vehicle to avoid damaging the XM SureConnect or your vehicle. Follow the information provided by the vehicle manufacturer for instructions on removing the FM antenna.

© 2006 XM Satellite Radio Inc.

The XM name and related logos are trademarks of XM Satellite Radio Inc.

