

LG Electronics Inc.
Digital Appliance Company, EMC Center

391-2, Ga Eum Jeong – Dong, Changwon City, Gyeong Nam
641-711, KOREA
Tel: + 82 55 260 3966, Fax: +82 55 260 3968

CERTIFICATION OF COMPLIANCE

Date of Issue: March 31, 2005

Test Report No: 05-LAE-M045

Test Site: LG Electronics Changwon EMC Center

This application is to [comply with the line conducted requirements for unintentional radiators and consumer Industrial, Scientific and Medical \(ISM\) device in ET Docket 98-80, FCC 02-157 on the previous granted model MX-1483GL, FCC ID: BEJX147XG dated 09/03/2003.](#)

Applicant:	LG Electronics Inc.
Regulation:	FCC Part 18 – ISM Consumer Device
Test Procedure:	MP-5: 1985
Equipment Class:	Industrial, Scientific, and Medical equipment
EUT Type:	Microwave oven
Magnetron Type:	2M246 (LG Electronics Inc.) 2M248J (Toshiba Hokuto Electronics Corp.)
Brand Name(s):	LG or GE
Model No.:	MX-1483G
FCC ID:	BEJX147XGA

This device has been verified to comply with the applicable requirements in the FCC Part 18 and was tested in accordance with the measurement procedures specified in MP-5: 1985.

I assure full responsibility for the completeness of these measurements and vouch for the qualifications of all persons taking them.



Kwan Y. Sung / Chief Research Engineer
Digital Appliance Company, EMC Center
LG Electronics Inc.

REPORT FOR A MICROWAVE OVEN

Scope - Measurement and determination of electromagnetic emissions (EME) of radio frequency devices including intentional and/or unintentional radiators for compliance with the technical rules and regulations of the Federal Communications Commission

EUT Type: Microwave oven
Model No.: MX-1483G
FCC ID: BEJX147XGA
Rule Part: FCC Part 18
Test Procedure: MP-5: 1985
Date of Test: February 1, 2005 - February 7, 2005
Date of Issue : March 31, 2005
Test Result: Pass

EMC Center authorizes the above-named applicant to reproduce this report provided it is reproduced in its entirety.

EMC Center reports apply only to the specific sample(s) tested under stated test conditions. It is the manufacturer's responsibility to assure that additional production unit of this model are manufactured with identical electrical and mechanical components.

This report is the confidential property of the client. As a mutual protection to our clients, the public and ourselves, extracts from the test report shall not be reproduced except in full without our written approval.

This report must not be used by the client to claim product endorsement by any agency of the U.S. Government.

The EMC Center facilities has been placed on file and the name of our organization added to the FCC's list for the FCC Part 15 and 18 of the Commission's Rules under Registration Number 93197.

Tested by:



Dong H. Kim / Senior Research Engineer
Digital Appliance Company, EMC Center
LG Electronics Inc.

Reviewed by:



Kwan Y. Sung / Chief Research Engineer
Digital Appliance Company, EMC Center
LG Electronics Inc.

CONTENTS

	Page
1. CLIENT INFORMATION.....	3
2. EQUIPMENT UNDER TEST (EUT).....	3
3. TEST SITE.....	4
4. CALIBRATIONS OF MEASURING INSTRUMENT.....	4
5. DESCRIPTION OF TEST CONDITION.....	4
5.1 POWER LINE CONDUCTED EMISSION MEASUREMENTS	4
5.2 RADIATED EMISSIONS MEASUREMENT	5
6. MEASURING INSTRUMENT	9
7. TEST DATA	10
7.1 INPUT POWER	10
7.2 RF POWER OUTPUT MEASUREMENT.....	11
7-3. FREQUENCY MEASUREMENTS	12
7-4. POWER DENSITY SAFETY CHECK	14
7-5. CONDUCTED EMISSIONS (SECTION 18.307)	15
7-6. RADIATED EMISSIONS (SECTION 18.305).....	16
APPENDIX A. TEST PLOT	18
APPENDIX B. LABELING REQUIREMENTS.....	26
APPENDIX C. BLOCK DIAGRAM / SCHEMATICS	27
APPENDIX D. TEST PHOTOS.....	28
APPENDIX E. EUT PHOTOS.....	30
APPENDIX F. OWNER'S MANUAL WITH REGARD TO FCC INSTRUCTION	34

1. CLIENT INFORMATION

The EUT has been tested by request of:

Company:	1. LG Electronics Inc. Cooking Appliances Division
(Manufacturer)	391-2, Ga Eum Jeong - Dong, Changwon City, Gyeong Nam, 641-711, Korea
	2. LG Electronics Tianjin Appliance Co., Ltd.
	Xing Dian Road, Bei Chen Distr., Tianjin 300402, People's Republic of China
Name of contact:	Jang Sup Lee
Telephone:	+82-551-260-3463
Fax:	+82-551-260-3223

2. EQUIPMENT UNDER TEST (EUT)

EUT is the LG Electronics Inc. Microwave Oven as followings:

Equipment:	Microwave oven
Model:	MX-1483G
Brand name:	LG or GE
Serial number:	N/A
Magnetron:	2M246 by LG Electronics Inc. 2M248J by Toshiba Hokuto Electronics Corp.
RF Frequency:	2,450 MHz
RF Power Output (IEC 705):	900 W
Power Consumption	
Microwave Mode:	1,500 W
Convection Mode:	1,700 W
Combination Mode:	1,650 W
Rated Input Voltage:	120 V~, 60 Hz
Rated Input Current	
Microwave Mode:	13.5 A
Convection Mode:	14.2 A
Combination Mode:	14.0 A
Cavity Volume:	1.4 Cu.ft
Oven Type:	Wall-mount or Countertop / Commercial Use
Mode Stirrer:	Turntable
Power Cord:	Shielded
Outer Dimensions (inch)	29.86 (W) * 16.53 (H) * 16.02 (D)

EMI suppression device(s) installed in production: See schematics (Appendix C)

EMI suppression device(s) added and/or modified during test: None

This application is to [comply with the line conducted requirements for unintentional radiators and consumer Industrial, Scientific and Medical \(ISM\) device in ET Docket 98-80, FCC 02-157 on the previous granted model MX-1483GL, FCC ID: BEJX147XG dated 09/03/2003.](#)

3. TEST SITE

Measurement of radiated emissions from EUT was made at semi-anechoic chamber that has been in compliance with Federal Communications Commissions (FCC) requirements of clause 2.948 according to ANSI C63.4-1992 on March 21, 2003.

4. CALIBRATIONS OF MEASURING INSTRUMENT

All measurement was made with instruments calibrated according to the recommendation by manufacturer. Measurement of radiated emissions and power line conducted emissions were made with instruments conforming to American National Standard Specification, ANSI C63.4-1992. The calibration of measuring instrument, including any accessories that may affect test results, was performed according to the recommendation by manufacturer.

5. DESCRIPTION OF TEST CONDITION

5.1 Power line conducted emission measurements

Power line conducted emission measurements were based on the std. CISPR 11:1998+A1:1999.

5.1.1 Shielded enclosure

The measurement for power-line emissions from EUT was made in shielded enclosure that provides sufficient shielding effectiveness enough not to affect test results.

5.1.2 Detector function selection and bandwidth

During conducted emission measurement, a radio noise meter that has a CISPR quasi-peak detector with 10 kHz IF bandwidth of 6 dB was utilized.

5.1.3 Frequency range to be scanned

For conducted emissions measurement, frequency range of 150 kHz to 30 MHz included, was investigated.

5.1.4 Unit of measurement

Test results for conducted emissions are reported in micro-volt.

5.1.5 Line impedance stabilization network (LISN)

A LISN with characteristics that conform to the requirements of ANSI C63.4-1992 was used for the measurement of conducted power-line radio noise; (50 micro-henries / 50 ohms). Chassis and earth-points for grounding of the LISN were earth-grounded.

5.1.6 Test conditions and configuration of EUT

The EUT was configured and operated in all modes of operation so as to find the maximum enumeration of emissions from EUT.

The EUT has designed to use the public AC lines with rated AC voltage as specified in owner's manual and Installation's manual of EUT and filtered to meet the requirement. AC

power was supplied to the EUT through LISN with characteristics described in 5.1.5 of part I of this report.

The EUT was placed on a 1 m×1.5 m×40 cm high wooden table which is placed on the earth-grounded conducting surface larger than 2 square meter. The vertical conducting surface was replaced with horizontal ground plane. Length of the power lead in excess of 80 cm horizontally separating the EUT from LISN was folded back-and-forth form at the center of the power cord not exceeding 40 cm in length.

The EUT was operated with a load of 1000 ml water initially at 20 °C ± 5 °C placed at the center of the load-carrying surface.

Each type of accessory provided by manufacturer or typically used and support equipment were connected to the EUT during measurement to the typical usage and applicable as nearly as practicable.

5.1.7 Measurement uncertainty

The measurement uncertainty describes the overall uncertainty of the given measured value during the operation of the EUT in the above-mentioned way.

The measurement uncertainty was calculated in accordance with NAMAS NIS 81: "The treatment of uncertainty in EMC measurement."
For calculated uncertainty of each item, refer the next page.

The measurement uncertainty was given with a confidence of 95%.

5.2 Radiated emissions measurement

5.2.1 Test site

Measurement was made in semi-anechoic chamber as described at Clause 3 in this report.

5.2.2 Detector function selection and bandwidth

In radiated emissions measurement, field strength meter that has CISPR quasi-peak and average detector was used. The bandwidth of the detector of instrument is 120 kHz for frequency range of 30 MHz – 1,000 MHz, and 1 MHz for frequency range of 1 GHz to 26 GHz. Emissions to be measured are detected in average mode.

5.2.3 Unit of measurement

Test results of radiated emissions measurement are reported in microvolts per meter at the specific distance. Using the unit of dBμV on the test instrument, the indication unit was converted to field strength unit of μV/m as following method;

$$F / S = 10^{(R+AF+CF)/20} (\mu V/m)$$

here,

F / S: Field Strength in μV/m, R: Meter Reading Level in dB(μV),

AF: Antenna Factor in dB/m

CF: Conversion Factor

* 30 MHz ~ 1 GHz: CF = CL

* Above 1 GHz: CF = CL – PG + FL + AL

CL: Cable Loss (dB)

FL: Filter Loss (dB)

PG: Preamplifier Gain (dB)

AL: Attenuator Loss (dB)

5.2.4 Antennas

Measurements were made using calibrated biconical antenna in range of 30 MHz to 300 MHz, log-periodic antenna in range of 300 MHz to 1,000 MHz and horn antenna in range of 1 to 26 GHz to determine the emission characteristics of the EUT. Measurements were also made for both horizontal and vertical polarization.

The horizontal distance between the receiving antenna and the closest periphery of the EUT was 3 meters for horn antenna and 10 meters for biconical and log-periodic antenna.

5.2.5 Frequency range to be scanned

For radiated emissions measurements, the spectrum in the range of 30 to 1,000 MHz and above, if found, was investigated.

5.2.6 Test conditions and configuration of EUT

The EUT was configured and operated in all modes of operation so as to find the maximum RF energy generated from EUT.

The power was furnished with rated (normal) AC 120 volts, as specified in the Owner's manual of EUT. The EUT was placed on a 1 m high non-metallic table. The turntable containing the system was rotated and the antenna height was varied 4 m to find the maximum RF energy detected from EUT.

Each type of accessory provided by manufacturer or typically used and support equipment were connected to the EUT during measurement to the typical usage and applicable as nearly as practicable.

5.2.7 Measurement uncertainty

The measurement uncertainty describes the overall uncertainty of the given measured value during the operation of the EUT in mentioned above way.

The measurement uncertainty was calculated in accordance with NAMAS NIS 81: "The treatment of uncertainty in EMC measurement."

For calculated uncertainty of each item, refer the next page.

The measurement uncertainty was given with a confidence of 95%.

< Fundamental Frequency Uncertainty (2,450 MHz) >

Symbol	Contribution	Value (dB)		Probability Distribution	Divisor	Standard Uncertainty	Standard Uncertainty Squared
			3 m			Horn Antenna (Value / Divisor)	
V ₁	Ambient signals				1	0.00	0.0
V ₂	Antenna factor calibration	Expanded Uncertainty	0.5	normal (k = 2)	2	0.25	0.1
V ₃	Cable loss calibration	Expanded Uncertainty	0.5	normal (k = 2)	2	0.25	0.1
V ₄	Receiver specification	Tolerance	1.0	rectangular	1.732	0.58	0.3
V ₅	Measurement distance variation	Tolerance	0.6	rectangular	1.732	0.35	0.1
V ₆	Site imperfections	Tolerance	2.0	rectangular	1.732	1.15	1.3
V ₇	Mismatch Receiver VRC: $\Gamma_1 = 0.33$ Antenna VRC: $\Gamma_g = 0.20$ Uncertainty limits $20\text{Log}(1 \pm \Gamma_1 \Gamma_g)$	Tolerance	0.6	U-shaped	1.414	0.42	0.2
V ₈	System repeatability (previous assessment of $s(q_k)$ from 5 repeats, 1 reading on EUT Repeatability of EUT*)		0.5	Std Deviation	1	0.50	0.3
	Combined standard uncertainty $u_c(y)$		1.53	normal			
	Expanded uncertainty U		3.06	normal (k = 2)			

$$u_c(y) = \sqrt{\left(\frac{0.0}{1}\right)^2 + \left(\frac{0.5}{2}\right)^2 + \left(\frac{0.5}{2}\right)^2 + \frac{1.0^2 + 0.6^2 + 2.0^2}{3} + \frac{0.6^2}{2} + 0.5^2}$$

The level of confidence will be approximately 95%. (The coverage factor: k=2)

$$U = 2 u_c(y) = 2 \times 1.53 = \pm 3.1 \text{ dB}$$

< Radiated Emission Uncertainty (Above 1 GHz) >

Symbol	Contribution	Value (dB)		Probability Distribution	Divisor	Standard Uncertainty	Standard Uncertainty Squared
			3 m			Horn Antenna (Value / Divisor)	
V ₁	Ambient signals			-	1	0.00	0.0
V ₂	Antenna factor calibration #1	Expanded Uncertainty	0.5	normal (k = 2)	2	0.25	0.1
V ₃	Antenna factor calibration #2	Expanded Uncertainty	0.5	normal (k = 2)	2	0.25	0.1
V ₄	Cable loss calibration	Expanded Uncertainty	0.5	normal (k = 2)	2	0.25	0.1
V ₅	Receiver specification	Tolerance	1.0	rectangular	1.732	0.58	0.3
V ₆	Highpass filter	Tolerance	1.0	rectangular	1.732	0.58	0.3
V ₇	Measurement distance variation	Tolerance	0.6	rectangular	1.732	0.35	0.1
V ₈	Site imperfections	Tolerance	2.0	rectangular	1.732	1.15	1.3
V ₉	Mismatch Receiver VRC: $\Gamma_1 = 0.33$ Antenna VRC: $\Gamma_g = 0.2$ Uncertainty limits $20\text{Log}(1 \pm \Gamma_1 \Gamma_g)$	Tolerance	0.6	U-shaped	1.414	0.42	0.2
V ₁₀	System repeatability (previous assessment of $s(q_k)$ from 5 repeats, 1 reading on EUT Repeatability of EUT*)		0.5	Std Deviation	1	0.50	0.3
	Combined standard uncertainty $u_c(y)$		1.65	normal			
	Expanded uncertainty U		3.31	normal (k = 2)			

$$u_c(y) = \sqrt{\left(\frac{0.0}{1}\right)^2 + \left(\frac{0.5}{2}\right)^2 + \left(\frac{0.5}{2}\right)^2 + \left(\frac{0.5}{2}\right)^2 + \frac{1.0^2 + 1.0^2 + 0.6^2 + 2.0^2}{3} + \frac{0.6^2}{2} + 0.5^2}$$

The level of confidence will be approximately 95%. (The coverage factor: k=2)

$$U = 2 u_c(y) = 2 \times 1.65 = \pm 3.4 \text{ dB}$$

< Electric Field Strength Uncertainty (30 MHz – 1 GHz) >

Symbol	Contribution	Value (dB)		Probability Distribution	Divisor	Standard Uncertainty	Standard Uncertainty Squared
		10 m				UltraLog Antenna (Value / Divisor)	
						10 m	
V ₁	Ambient signals			Std Deviation	1	0.00	0.0
V ₂	Antenna factor calibration	Tolerance	1.0	rectangular	1.732	0.58	0.3
V ₃	Cable loss calibration	Expanded Uncertainty	0.5	normal (k = 2)	2	0.25	0.1
V ₄	Receiver specification	Tolerance	1.0	rectangular	1.732	0.58	0.3
V ₅	Antenna directivity	Tolerance	3.0	rectangular	1.732	1.73	3.0
V ₆	Antenna factor variation with height	Tolerance	0.5	rectangular	1.732	0.29	0.1
V ₇	Antenna phase center variation	Tolerance	0.2	rectangular	1.732	0.1	0.0
V ₈	Antenna factor frequency interpolator	Tolerance	0.25	rectangular	1.732	0.14	0.0
V ₉	Measurement distance variation	Tolerance	0.4	rectangular	1.732	0.23	0.1
V ₁₀	Site imperfections	Tolerance	2.0	rectangular	1.732	1.15	1.3
V ₁₁	Mismatch Receiver VRC: $\Gamma_1 = 0.09$ Antenna VRC: $\Gamma_g = 0.33$ Uncertainty limits $20\text{Log}(1 \pm \Gamma_1 \Gamma_g)$	Tolerance	0.3	U-shaped	1.414	0.21	0.0
V ₁₂	System repeatability (previous assessment of $s(q_k)$ from 5 repeats, 1 reading on EUT Repeatability of EUT*)		0.5	Std Deviation	1	0.50	0.3
	Combined standard uncertainty $u_c(y)$		2.35	normal	2		
	Expanded uncertainty U		4.70	normal (k = 2)	2		

$$u_c(y) = \sqrt{\left(\frac{0.0}{1}\right)^2 + \left(\frac{0.5}{2}\right)^2 + \frac{1.0^2 + 1.0^2 + 3.0^2 + 0.5^2 + 0.2^2 + 0.25^2 + 0.4^2 + 2.0^2}{3} + \frac{0.30^2}{2} + 0.5^2}$$

The level of confidence will be approximately 95%. (The coverage factor: k=2)

$$U = 2 u_c(y) = 2 \times 2.35 = \pm 4.7 \text{ dB}$$

< Line Conducted Uncertainty >

Symbol	Contribution	Value (dB)		Probability Distribution	Divisor	Standard Uncertainty (dB)	Standard Uncertainty Squared
		150 kHz - 30 MHz (Value / Divisor)					
V ₁	Receiver specification	Tolerance	1.0	rectangular	1.732	0.58	0.3
V ₂	LISN coupling specification	Tolerance	1.0	rectangular	1.732	0.58	0.3
V ₃	Cable and input attenuator calibration	Expanded Uncertainty	0.5	normal (k = 2)	2	0.25	0.1
V ₄	Mismatch Receiver VRC: $\Gamma_1 = 0.09$ LISN VRC: $\Gamma_g = 0.8$ Uncertainty limits $20\text{Log}(1 \pm \Gamma_1 \Gamma_g)$	Tolerance	0.6	U-shaped	1.414	0.42	0.180
V ₅	System repeatability (previous assessment of $s(q_k)$ from 10 repeats, 1 reading on EUT)		0.35	standard deviation	1	0.35	0.12
	Combined standard uncertainty $u_c(y)$		1.02	normal			
	Expanded uncertainty U		2.03	normal (k = 2)			

$$u_c(y) = \sqrt{\frac{1.0^2 + 1.0^2}{3} + \left(\frac{0.5}{2}\right)^2 + \frac{0.6^2 + 0.35^2}{2}} = \text{dB}$$

The level of confidence will be approximately 95%. (The coverage factor: k=2)

$$U = 2 u_c(y) = 2 \times 1.02 = \pm 2.1 \text{ dB}$$

6. MEASURING INSTRUMENT

Instrument	Model	Cal. Due date	Serial No.	Control No.
Microwave Spectrum Analyzer	HP8566B	11/02/2005	3340A08173	99-IRE-05
RF Preselector	HP85685A	11/02/2005	3221A01441	99-IRE-04
Quasi-Peak Adapter	HP85650A	11/02/2005	3303A01732	99-TRE-01
R/B Spectrum Display	HP462	11/02/2005	3340A21397	99-IRE-02
Attenuator Switch Driver	HP11713A	11/02/2005	3334A11152	99-IRE-03
Preamplifier	HP8449B OPT H02	11/02/2005	3008A00525	99-IRE-06
Power Meter	HP436A	11/02/2005	2604A24567	99-IRE-12
Power Sensor	HP8481A	11/02/2005	2552A50829	99-IRE-14
Power Sensor	HP8482A	11/02/2005	2607A11242	99-IRE-15
Accessory Kit	-	-	7044/45-002	99-IRE-16
Horn Antenna	RGA-180 (Electro Metrics)	07/23/2005	2517	99-IRE-22
	RGA-60 (Electro Metrics)	07/22/2006	6104	99-IRE-21
	BBHA 9170 (Schwarz beck)	06/15/2005	168	03-IRE-34
Antenna Master	2070-2 (EMKO)	-	9903-2231	99-IRE-23
Ultra Log Antenna	HL562 (Chase)	06/09/2005	830547/007	99-IRE-27
High Pass Filter	11SH10- 2500/X1800-010	11/02/2005	2	99-IRE-07
EMI Receiver	ESI26 (R&S)	11/02/2005	835336/008	00-IRE-30
	ESIB7 (R&S)	06/28/2005	100090	02-IRE-32
LISN	ESH2-Z5 (R&S)	06/09/2005	825640/003	99-ICE-02
	ENV4200 (R&S)	11/01/2005	100024	02-ICE-07
Microwave Cable	Sucoflex 104	-	125484/4	-
Microwave Cable	Sucoflex 106	-	13417/6	-
Microwave Cable	Sucoflex 106	-	13419/6	-
Microwave Cable	Sucoflex 106	-	13418/6	-
Microwave Cable	Sucoflex 104	-	125483/4	-
Microwave Cable	Sucoflex 104	-	12548/4	-
Microwave Cable	Sucoflex 106	-	13416/6	-
Microwave Cable	Sucoflex 106	-	13416/6	-
Semi Anechoic Chamber	YES INC.	-	-	99-CFA-01
Shield Screen Room	YES INC.	-	-	99-CFA-02
Microwave Survey Meter	Holaday HI-1710/HI-2623	07/24/2005	93083	FJZ431HA

7. TEST DATA

7.1 Input Power

The input power was measured using Wattmeter. A 275 ml water load in a polypropylene beaker is placed in the center of the oven. The 275 ml water was chosen for its compatibility with UL procedure to determine input ratings. The oven was operated at the rated input and full output power for 6 minutes.

1) Magnetron type: 2M246 by LG

<u>Mode</u>	<u>Input Voltage</u>	<u>Current [A]</u>	<u>Power Consumption</u> <u>[W]</u>	<u>Manufacturer</u> <u>Rating [A]</u>
Microwave	120 Vac, 60 Hz	12.8	1,470	13.5

2) Magnetron type: 2M248J by Toshiba

<u>Mode</u>	<u>Input Voltage</u>	<u>Current [A]</u>	<u>Power Consumption</u> <u>[W]</u>	<u>Manufacturer</u> <u>Rating [A]</u>
Microwave	120 Vac, 60 Hz	12.9	1,27	13.5

7.2 RF Power Output Measurement

The Calorimetric Method was used to determine maximum output power. A 1,000 ml water load was placed in the center of the oven. A mercury thermometer was used to measure temperature rise. The test method described in MP-5 and IEC Publication 705/1998.

1) Magnetron type: 2M246 by LG

$$\text{Power [W]} = \frac{(4.187 \text{ Joules/Cal}) * (\text{Volume in ml}) * (\text{Temperature Rise})}{\text{Time in Seconds}}$$

<u>Quantity of Water</u>	<u>Starting Temperature</u>	<u>Final Temperature</u>	<u>Elapsed Time</u>
1,000 ml	20.5 °C	20.7 °C	120 Sec

$$\text{Power [W]} = \frac{4.187 * 1,000 * 20.2}{120}$$

$$\text{Power [W]} = 704.8 \text{ Watts}$$

2) Magnetron type: 2M248J by Toshiba

$$\text{Power [W]} = \frac{(4.187 \text{ Joules/Cal}) * (\text{Volume in ml}) * (\text{Temperature Rise})}{\text{Time in Seconds}}$$

<u>Quantity of Water</u>	<u>Starting Temperature</u>	<u>Final Temperature</u>	<u>Elapsed Time</u>
1000 ml	20.2 °C	40.6 °C	120 Sec

$$\text{Power [W]} = \frac{4.187 * 1000 * 20.4}{120}$$

$$\text{Power [W]} = 711.7 \text{ Watts}$$

7-3. Frequency measurements

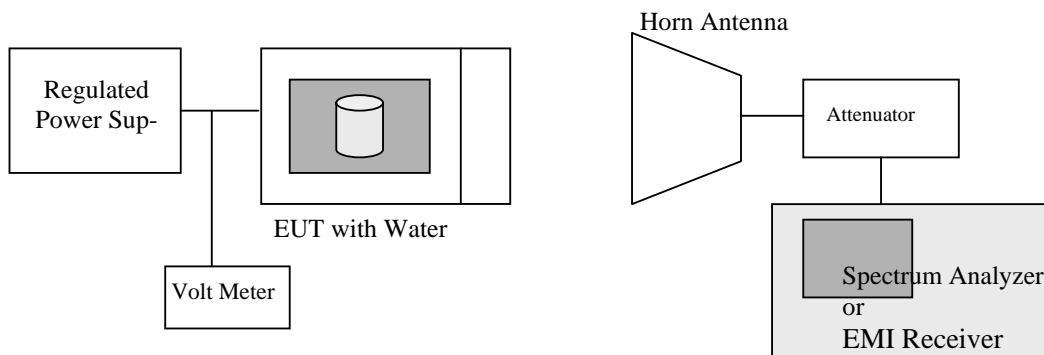

1) Magnetron type: 2M246 by LG

(1) Frequency vs Line Voltage Variation Test

Variation of line voltage from 80 % (96 V) to 125 % (150 V)

Load: 1,000 ml

Fundamental Frequency: 2,450 MHz

Limit: $2.4 \text{ GHz} < f < 2.5 \text{ GHz}$

Maximum Frequency Observed: 2,456 MHz

Minimum Frequency Observed: 2,452 MHz

Result: Pass

(2) Frequency vs Load Variation Test

Frequency was measured at the rated input voltage (AC 120 V).

Initial Load: 1,000 ml

Final Load: 200 ml

Fundamental Frequency: 2,450 MHz

Limit: $2.4 \text{ GHz} < f < 2.5 \text{ GHz}$

Maximum Frequency Observed: 2,458 MHz

Minimum Frequency Observed: 2,442 MHz

Result: Pass

2) Magnetron type: 2M248J by Toshiba

(2) Frequency vs. Line Voltage Variation Test

Variation of line voltage from 80 % (96 V) to 125 % (150 V)

Load: 1000 ml

Fundamental Frequency: 2,450 MHz

Limit: $2.4 \text{ GHz} < f < 2.5 \text{ GHz}$

Maximum Frequency Observed: 2,463 MHz

Minimum Frequency Observed: 2,450 MHz

Result: Pass

(2) Frequency vs. Load Variation Test

Frequency was measured at the rated input voltage (AC 120 V).

Initial Load: 1000 ml

Final Load: 200 ml

Fundamental Frequency: 2,450 MHz

Limit: $2.4 \text{ GHz} < f < 2.5 \text{ GHz}$

Maximum Frequency Observed: 2,473 MHz

Minimum Frequency Observed: 2,456 MHz

Result: Pass

7-4. Power Density Safety Check

The power density was checked to ensure that the power is not greater than 1.0 mW/cm^2 at any location of the oven. The 1.0 mW/cm^2 is in accordance with CDRH and UL923 standard.

A microwave survey meter was placed on all sides, door and viewing, bottom, top and rear. No power greater than 0.10 mW/cm^2 was observed and did not exceed the specified limits.

1) Magnetron type: 2M246 by LG

Maximum Leakage Microwave Observed: 0.09 mW/cm^2

Result: **Pass**

2) Magnetron type: 2M248J by Toshiba

Maximum Leakage Microwave Observed: 0.10 mW/cm^2

Result: **Pass**

7-5. Conducted emissions (Section 18.307)

Conducted emission was measured at a frequency range 150 kHz to 30 MHz. The Power Line disturbance voltage was measured with the equipment under test (EUT) in a shielded room. The EUT was connected to a line impedance stabilization network (LISN) placed on the floor. The EUT was placed on a non-metallic table 0.4 m above the metallic, grounded floor. The distance to other metallic surfaces was at least 0.4 m.

The line conducted emission measurement procedure and test configuration is based on CISPR 11:1998 and Amendment 1:1999.

Amplitude measurements were performed with a quasi-peak detector and, if required, with an average detector.

Below data are the highest levels in Microwave mode.

An overview sweep performed with peak detector is included in the APPENDIX A (Test Plot).

1) Magnetron type: 2M246 by LG

Frequency [MHz]	Quasi-Peak			Average		
	Disturbance Level [dBuV]	Permitted Limit [dBuV]	Margin [dB]	Disturbance Level [dBuV]	Permitted Limit [dBuV]	Margin [dB]
0.150	48.9	66.0	-17.1	19.6	56.0	-36.4
0.590	38.1	56.0	-17.9	11.9	46.0	-34.1
1.930	46.4	56.0	-9.6	19.6	46.0	-26.4
16.030	36.9	60.0	-23.1	34.6	50.0	-15.4
20.110	37.3	60.0	-22.7	37.0	50.0	-13.0

Remark: 1. "<<" means that disturbance level is lower than 20 dB below the limit.

2) Magnetron type: 2M248J by Toshiba

Frequency [MHz]	Quasi-Peak			Average		
	Disturbance Level [dBuV]	Permitted Limit [dBuV]	Margin [dB]	Disturbance Level [dBuV]	Permitted Limit [dBuV]	Margin [dB]
0.150	45.6	66.0	-20.4	16.4	56.0	-39.6
0.574	37.0	56.0	-19.0	11.4	46.0	-34.6
1.900	44.5	56.0	-11.5	14.6	46.0	-31.4
16.030	30.8	60.0	-29.2	28.6	50.0	-21.4
20.110	39.2	60.0	-20.8	38.7	50.0	-11.3

Remark: 1. "<<" means that disturbance level is lower than 20 dB below the limit.

7-6. Radiated emissions (Section 18.305)

Radiated emission was measured at a frequency range 30 MHz to 26 GHz. The EUT was supported by a 1 m high wood table, measurement above 1 GHz and below 1 GHz.

Preliminary measurements were made inside an anechoic chamber at 3 m to determine to emission characteristics of EUT. The EUT is configured and operated in a manner, which produces the maximum emission in a typical configuration. Final measurements were made outdoor in control room at 3-meter test method.

1) Magnetron type: 2M246 by LG

Test distance: 3 m

Freq. (MHz)	Ant. Factor [dB]	Cable Loss [dB]	Load [ml]	Load Location	Meter Reading [dB μ V]	Field Strength @ 3 m [dB μ V/m]	Field Strength @ 3 m [μ V/m]	Field Strength @ 300 m [μ V/m]	FCC Limit @ 300 m [μ V/m]
2,398	28.8	3.8	700	Center	24.5	57.1	716.1	7.2	29.7
2,512	29.1	3.8	700	Center	18.6	51.5	375.8	3.8	29.7
4,902	33.7	6.1	700	Center	22.5	62.3	1303.2	13.0	29.7
4,907	33.7	6.1	700	Rt. Front	22.7	62.5	1333.5	13.3	29.7
4,910	33.7	6.1	300	Center	23.1	62.9	1396.4	14.0	29.7
4,905	33.7	6.1	300	Rt. Front	22.4	62.2	1288.2	12.9	29.7
7,350	36.6	7.5	700	Center	12.1	56.2	645.7	6.5	29.7
7,346	36.6	7.5	700	Rt. Front	12.2	56.3	653.1	6.5	29.7
7,352	36.6	7.5	300	Center	12.1	56.2	645.7	6.5	29.7
7,349	36.6	7.5	300	Rt. Front	13.4	57.5	749.9	7.5	29.7
9,807	38.3	8.7	700	Center	10.3	57.3	732.8	7.3	29.7
14.71	39.8	12.4	700	Center	0.3	55.0	562.3	5.6	29.7
17.14	40.2	14.5	700	Center	-3.6	55.4	588.8	5.9	29.7

Other frequencies: No detected.

For measurement of 30 MHz – 1,000 MHz, refer to APPENDIX A (Test Plot).

2) Magnetron type: 2M248J by Toshiba

Test distance: 3 m

Freq. (MHz)	Ant. Factor [dB]	Cable Loss [dB]	Load [ml]	Load Location	Meter Reading [dBμV]	Field Strength @ 3 m [dBμV/m]	Field Strength @ 3 m [μV/m]	Field Strength @ 300 m [μV/m]	FCC Limit @ 300 m [μV/m]
2,398	28.8	3.8	700	Center	32.5	65.1	1798.9	18.0	29.8
2,563	29.1	3.8	700	Center	13.6	46.5	211.3	2.1	29.8
4,935	33.7	6.1	700	Center	10.5	50.3	327.3	3.3	29.8
4,927	33.7	6.1	700	Rt. Front	12.3	52.1	402.7	4.0	29.8
4,932	33.7	6.1	300	Center	10.8	50.6	338.8	3.4	29.8
4,930	33.7	6.1	300	Rt. Front	11.4	51.2	363.1	3.6	29.8
7,380	36.6	7.5	700	Center	7.1	51.2	363.1	3.6	29.8
7,390	36.6	7.5	700	Rt. Front	8.1	52.2	407.4	4.1	29.8
7,383	36.6	7.5	300	Center	7.9	52.0	398.1	4.0	29.8
7,386	36.6	7.5	300	Rt. Front	8.4	52.5	421.7	4.2	29.8
9,881	38.3	8.7	700	Center	3.4	50.4	331.1	3.3	29.8
14.73	40.2	14.5	700	Center	4.2	58.9	881.0	8.8	29.8
17.21	43.8	15.2	700	Center	-1.5	57.5	749.9	7.5	29.8

Other frequencies: No detected.

For measurement of 30 MHz – 1,000 MHz, refer to APPENDIX A (Test Plot).

Result: Pass

* Limit (at 300 m) = $25 * (\text{RF Power}/500)^{1/2}$ [μV/m]

* Field Strength below 1,000 MHz (at 300 m) [μV/m] = $10^{[(\text{Field strength at 10m(dBuV/m)}-29.5)/20]}$

* Field Strength above 1,000 MHz (at 300 m) [μV/m] = $K * 10^{[\text{Field strength at 3m(dBuV/m)} / 20]}$

NOTES:

- Two representative modes (full power and defrost) of operation were investigated.
- A glass beaker was used as the container and the test was made with a shelf in its initial normal position.
- Load for measurement of radiation on second and third harmonic: Two loads, one of 700 and the other of 300 ml, of water were used. Each load was tested both with the beaker located in the center of the oven and with it in the corner.
- Load for all other measurements: 700 ml of water, with the beaker located in the center of the oven
- All other emissions are non-significant.
- The tests were made with average detector for frequency range of 30 MHz to 26 GHz.

APPENDIX A. Test Plot

◆ 150 kHz ~ 30 MHz (Magnetron type: 2M246 by LG)

- Operating Mode: Maximum RF Power Output
- Detect Mode: Quasi-Peak/Average

<Phase: L1>

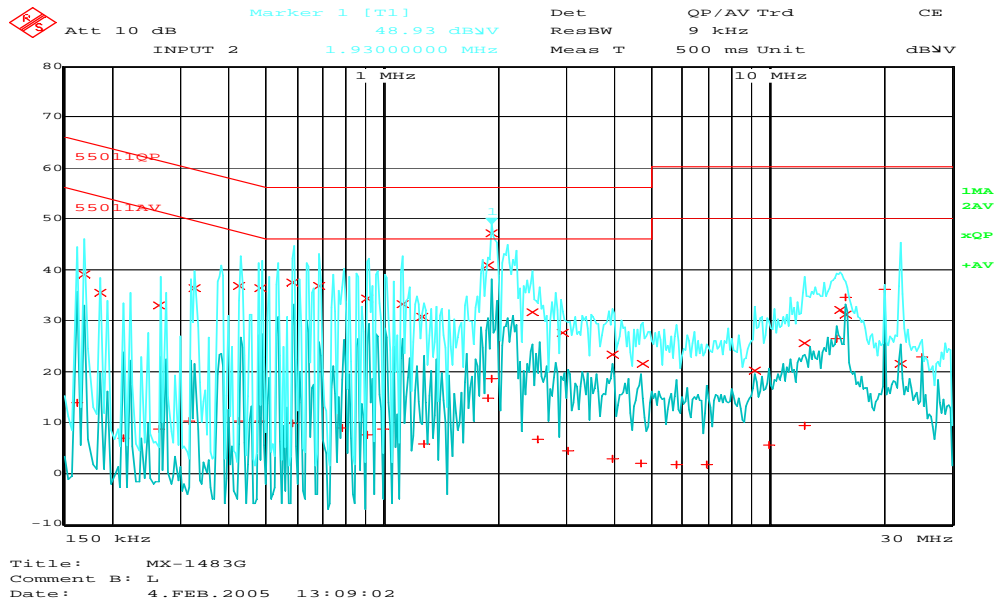

<Phase: N>

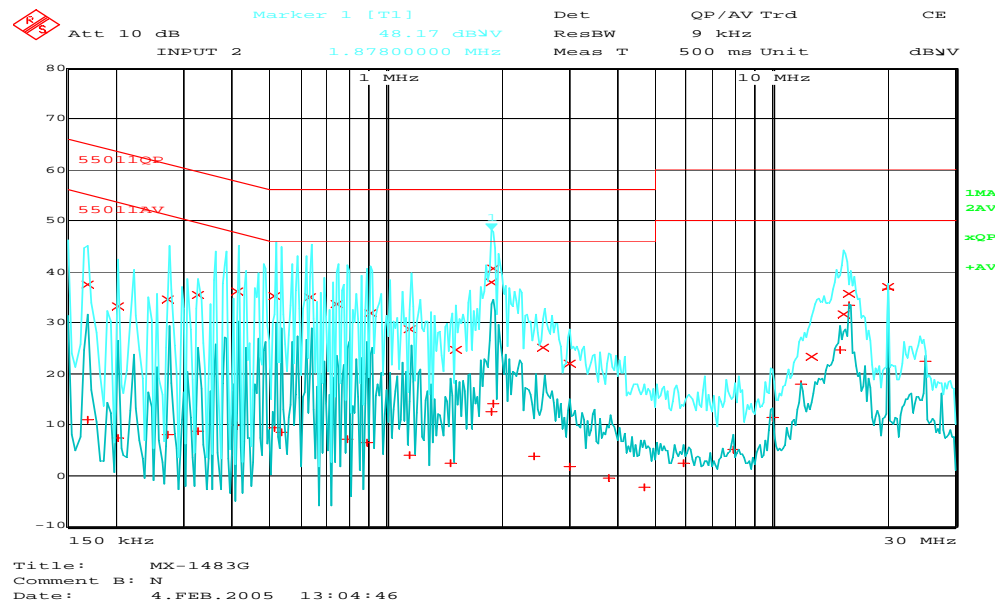

◆ 150 kHz ~ 30 MHz (Magnetron type: 2M248J by Toshiba)

- Operating Mode: Maximum RF Power Output
- Detect Mode: Quasi-Peak/Average

<Phase: L1>

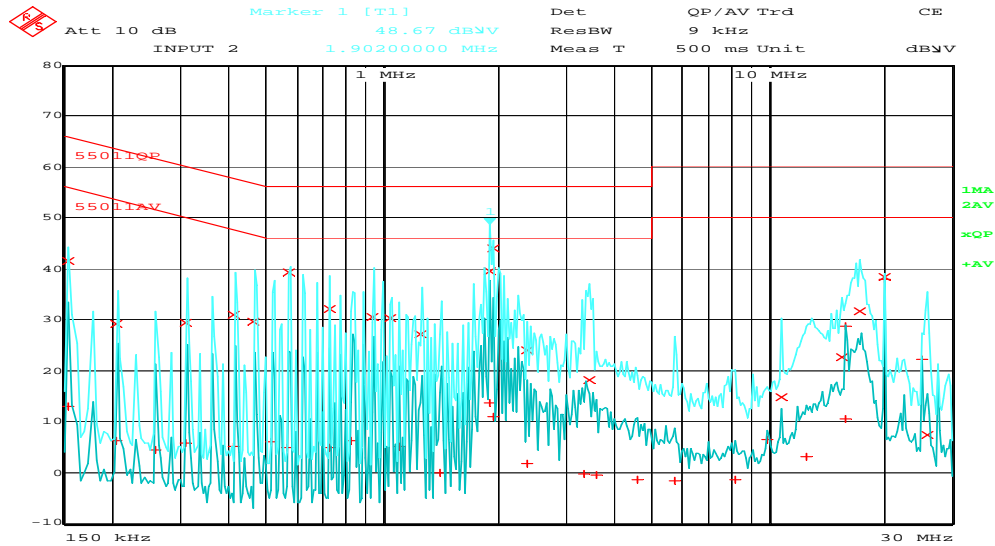

Title: MX-1483G
Comment B: L1
Date: 2.FEB.2005 10:23:26

<Phase: N>

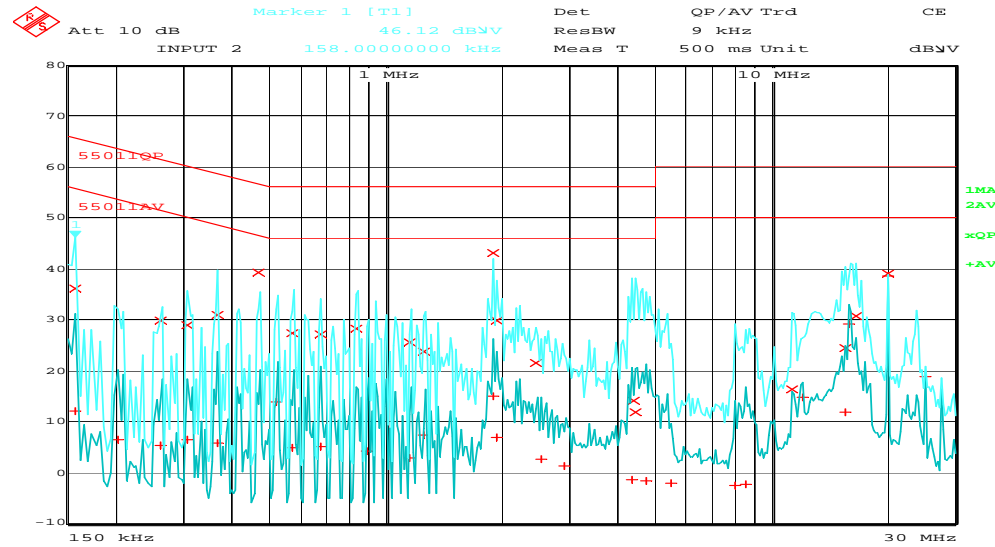

Title: MX-1483G
Comment B: N
Date: 2.FEB.2005 10:18:30

◆ 30 MHz ~ 1000 MHz (Magnetron type: 2M246 by LG)

- Operating Mode: Maximum RF Power Output
- Detect Mode: Peak
- Measurement Distance: 10 meters

<Antenna Polarization: Horizontal>

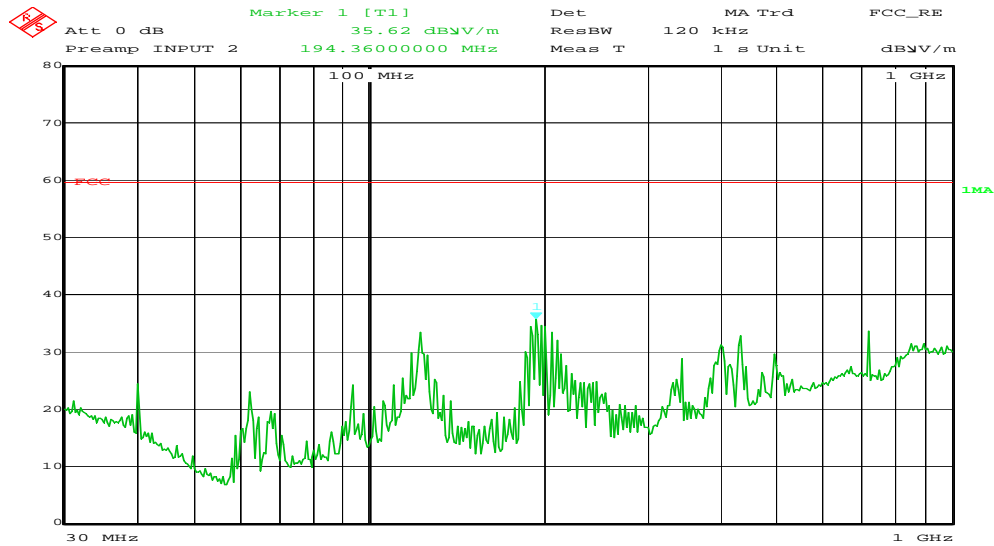

Title: MX-1483G
Comment B: ANT. HOR.
Date: 2.FEB.2005 11:51:33

<Antenna Polarization: Vertical>

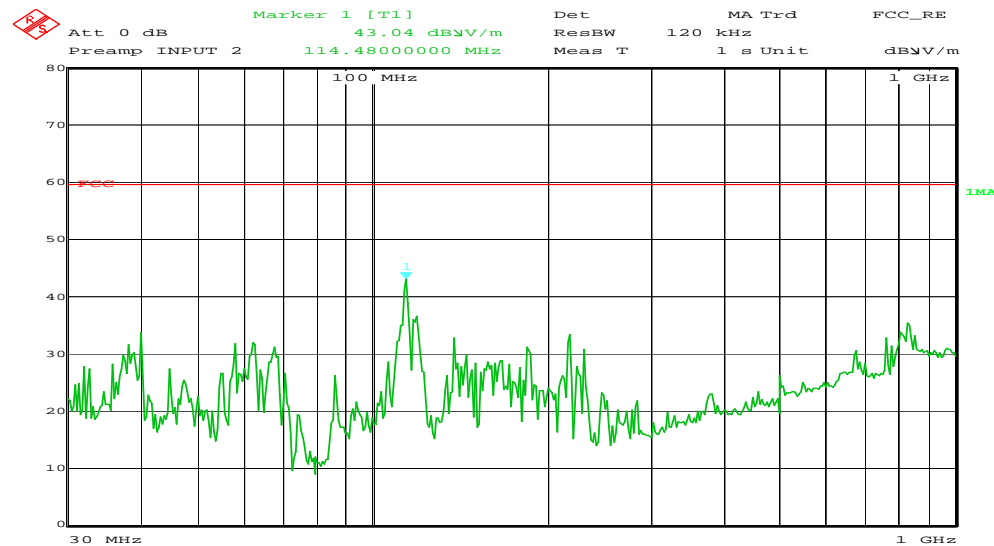

Title: MX-1483G
Comment B: ANT. VER.
Date: 2.FEB.2005 11:48:15

30 MHz ~ 1000 MHz (Magnetron type: 2M248J by Toshiba)

- Operating Mode: Maximum RF Power Output
- Detect Mode: Peak
- Measurement Distance: 10 meters

<Antenna Polarization: Horizontal>

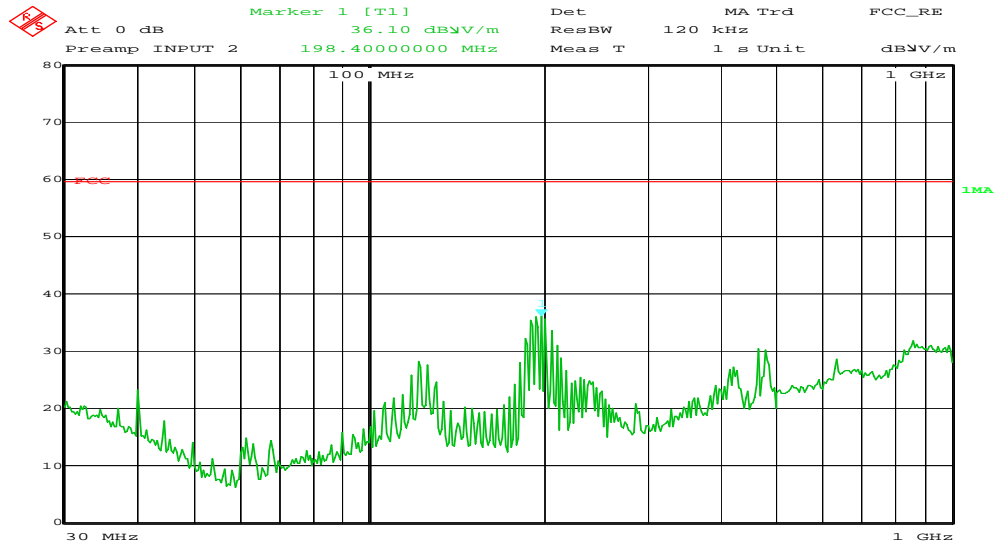

Title: MX-1483G
Comment B: ANT. HOR.
Date: 2.FEB.2005 10:47:40

<Antenna Polarization: Vertical>

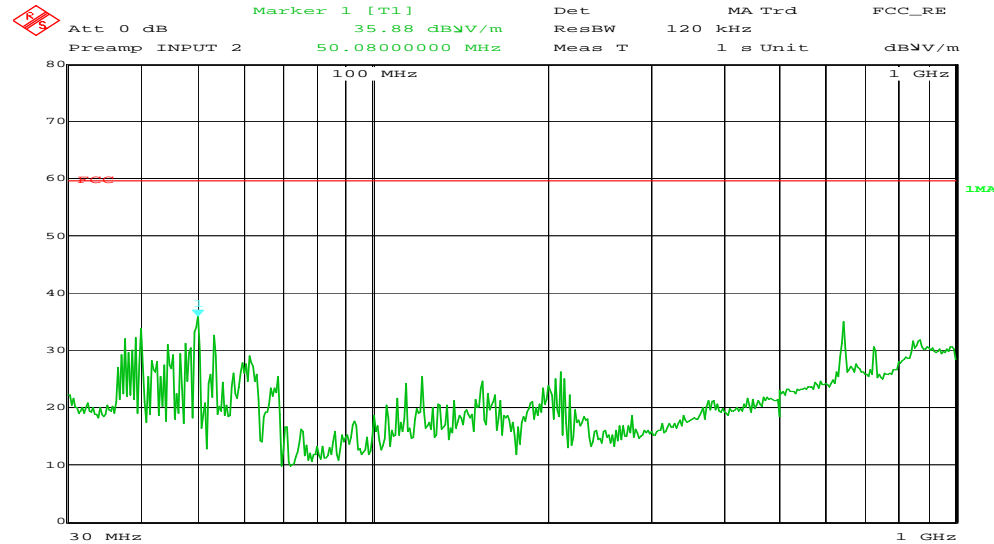

Title: MX-1483G
Comment B: ANT. VER.
Date: 2.FEB.2005 10:51:05

◆ Voltage Variation (Magnetron type: 2M246 by LG)

<Maximum Frequency Observed: 2,456 MHz>

Max/Ref Lvl	Marker 1 [T1]	RBW	1 MHz	RF Att	0 dB
140 dB μ V	114.90 dB μ V	VBW	1 MHz	Mixer	-10 dBm
92 dB μ V	2.45651303 GHz	SWT	5 ms	Unit	dB μ V

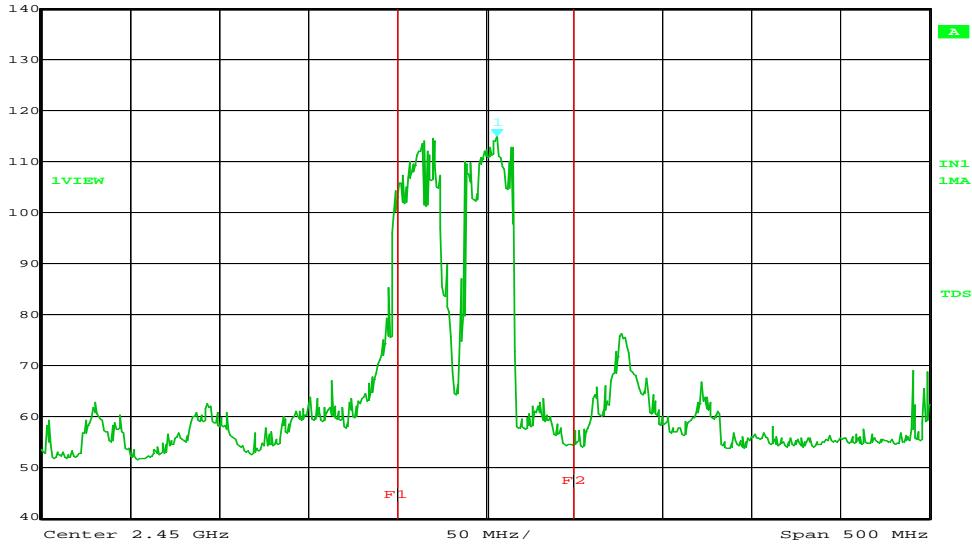

Title: MX-1483G
Comment A: Fund. Freq.
Date: 2.FEB.2005 14:52:50

<Minimum Frequency Observed: 2,452 MHz>

Max/Ref Lvl	Marker 1 [T1]	RBW	1 MHz	RF Att	0 dB
140 dB μ V	116.71 dB μ V	VBW	1 MHz	Mixer	-10 dBm
92 dB μ V	2.45250501 GHz	SWT	5 ms	Unit	dB μ V

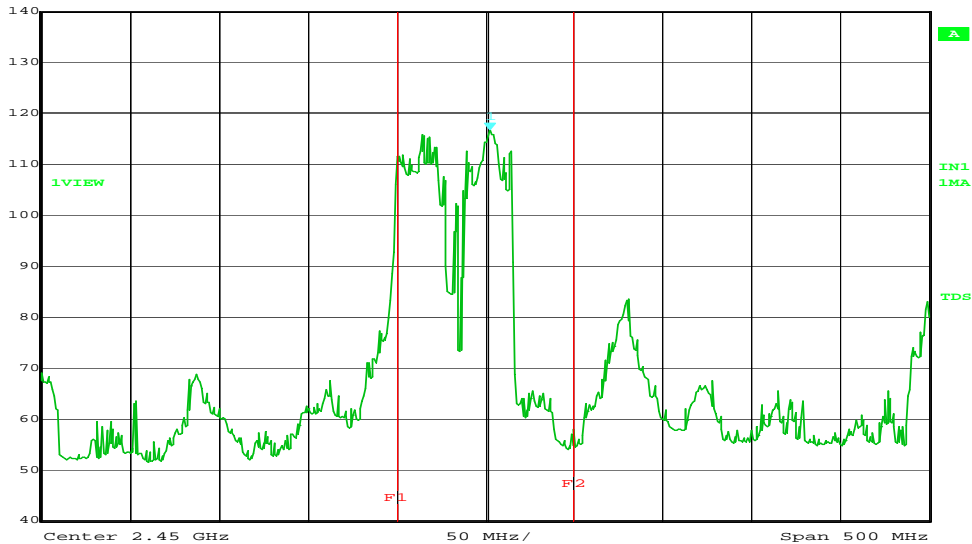

Title: MX-1483G
Comment A: Fund. Freq.
Date: 2.FEB.2005 15:26:01

◆ Voltage Variation (Magnetron type: 2M248J by Toshiba)

<Maximum Frequency Observed: 2,463 MHz>

Max/Ref Lvl	Marker 1 [T1]	RBW	1 MHz	RF Att	0 dB
140 dB μ V	118.74 dB μ V	VBW	1 MHz	Mixer	-10 dBm
92 dB μ V	2.46352705 GHz	SWT	5 ms	Unit	dB μ V

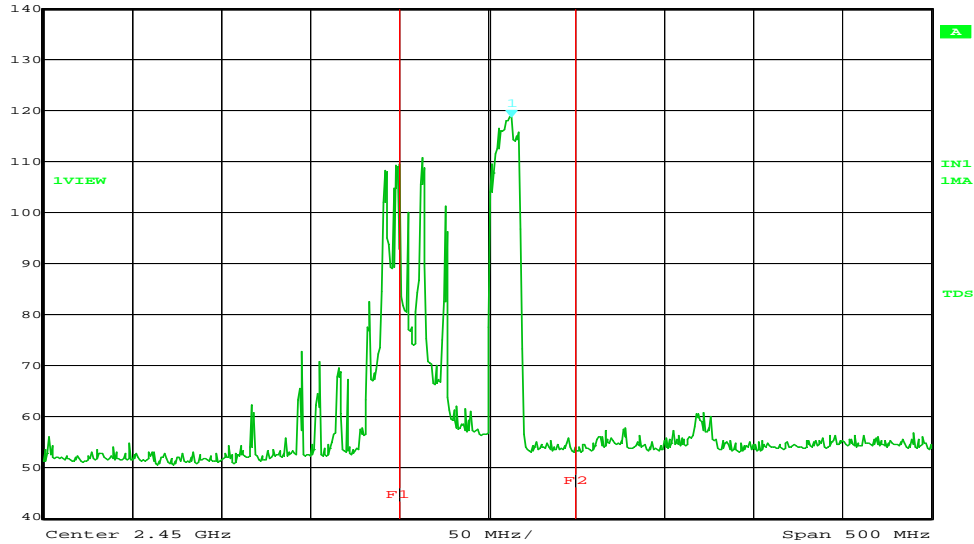

Title: MX-1483G
Comment A: Fund. Freq.
Date: 1.FEB.2005 10:15:33

<Minimum Frequency Observed: 2,450 MHz>

Max/Ref Lvl	Marker 1 [T1]	RBW	1 MHz	RF Att	0 dB
140 dB μ V	121.54 dB μ V	VBW	1 MHz	Mixer	-10 dBm
92 dB μ V	2.45050100 GHz	SWT	5 ms	Unit	dB μ V

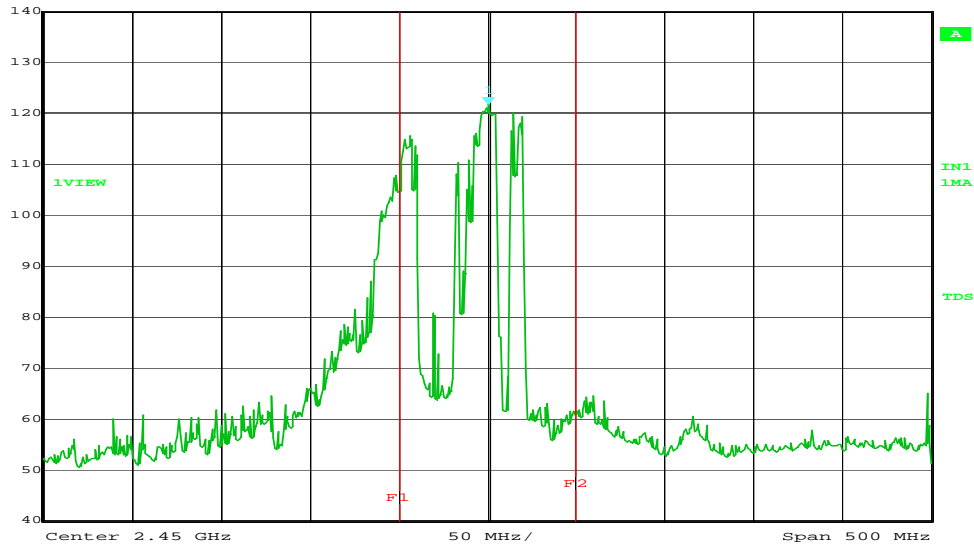

Title: MX-1483G
Comment A: Fund. Freq.
Date: 1.FEB.2005 09:24:28

◆ Load Variation (Magnetron type: 2M246 by LG)

<Maximum Frequency Observed: 2,458 MHz >

Max/Ref Lvl	Marker 1 [T1]	RBW	1 MHz	RF Att	0 dB
	140 dBμV	119.17 dBμV	VBW	1 MHz	Mixer -10 dBm
	92 dBμV	2.45851703 GHz	SWT	5 ms	Unit dBμV

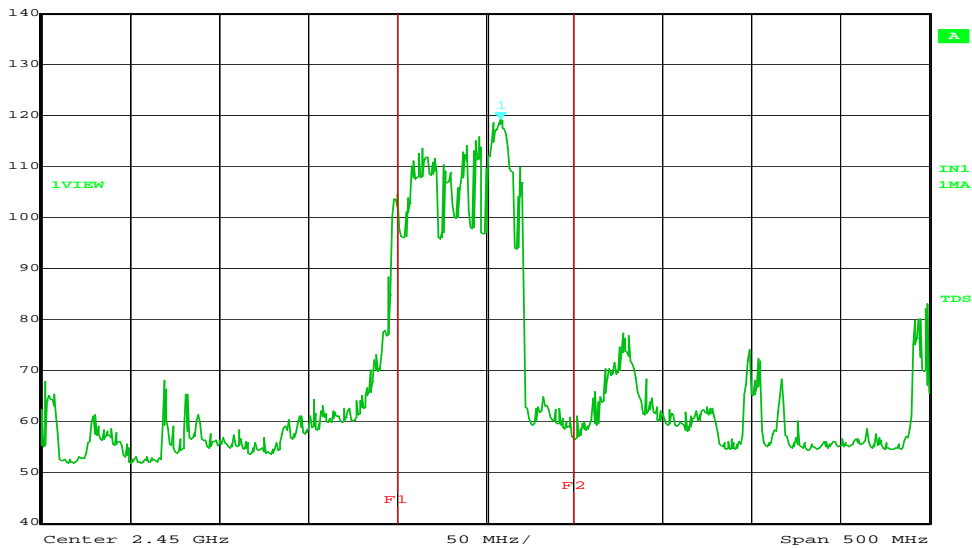

Title: MX-1483G
Comment A: Fund. Freq.
Date: 2.FEB.2005 15:44:33

< Minimum Frequency Observed: 2,442 MHz >

Max/Ref Lvl	Marker 1 [T1]	RBW	1 MHz	RF Att	0 dB
	140 dBμV	119.27 dBμV	VBW	1 MHz	Mixer -10 dBm
	92 dBμV	2.44248497 GHz	SWT	5 ms	Unit dBμV

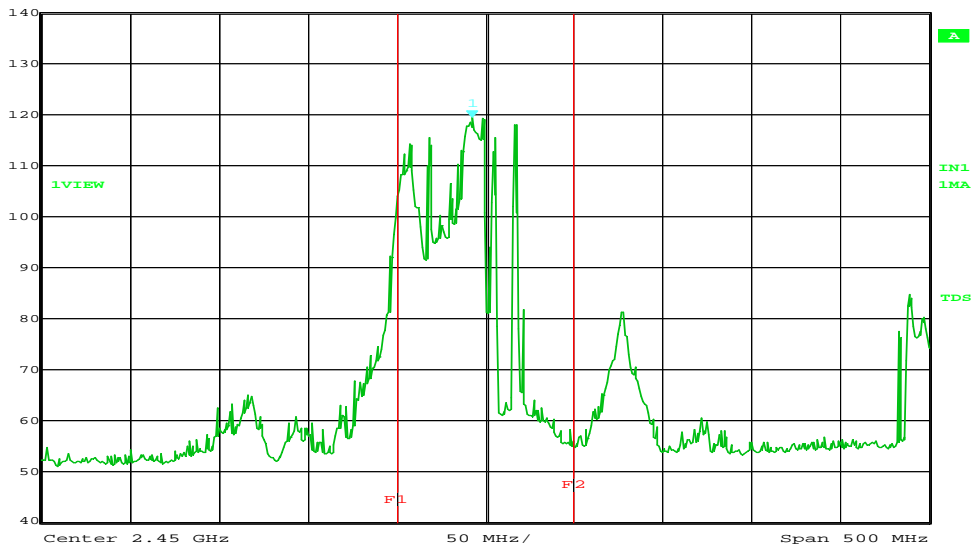

Title: MX-1483G
Comment A: Fund. Freq.
Date: 2.FEB.2005 16:31:08

◆ Load Variation (Magnetron type: 2M248J by Toshiba)

<Maximum Frequency Observed: 2,473 MHz >

Max/Ref Lvl 140 dBV 92 dBV
Marker 1 [T1] 122.75 dBV 2.47354709 GHz
RBW 1 MHz VBW 1 MHz SWT 5 ms
RF Att 0 dB Mixer Unit dBV

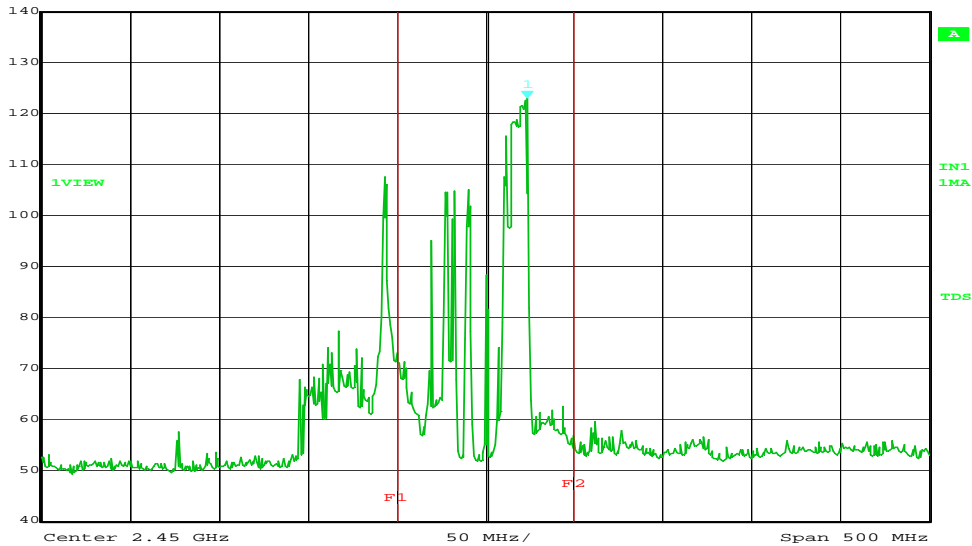

Title: MX-1483G
Comment A: Fund. Freq.
Date: 1.FEB.2005 11:16:15

< Minimum Frequency Observed: 2,456 MHz >

Max/Ref Lvl 140 dBV 92 dBV
Marker 1 [T1] 120.47 dBV 2.45651303 GHz
RBW 1 MHz VBW 1 MHz SWT 5 ms
RF Att 0 dB Mixer Unit dBV

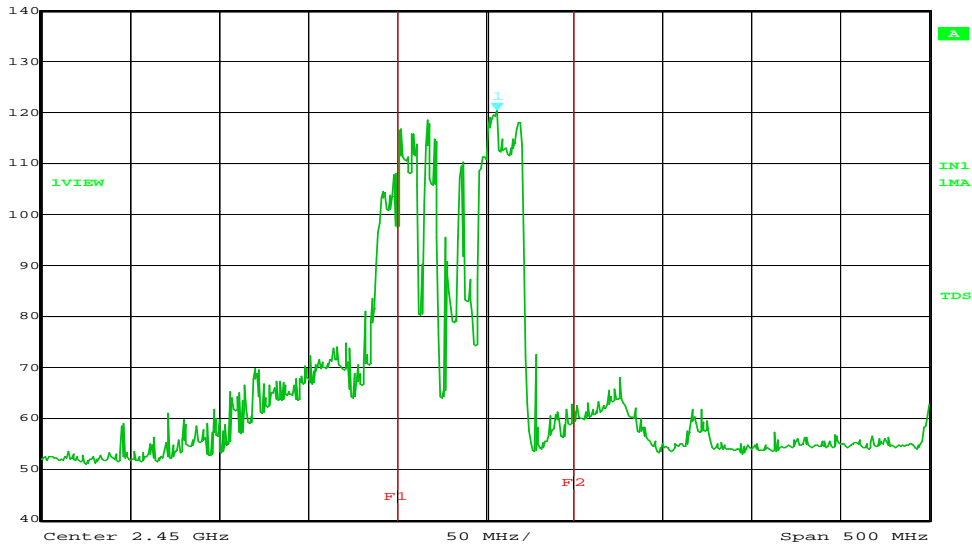

Title: MX-1483G
Comment A: Fund. Freq.
Date: 1.FEB.2005 10:53:45

APPENDIX B. Labeling Requirements

Labeling requirements per Section 2.925 and 15.19.

The label shown shall be permanently affixed at a conspicuous location on the device and be readily visible to the user at the time purchase.

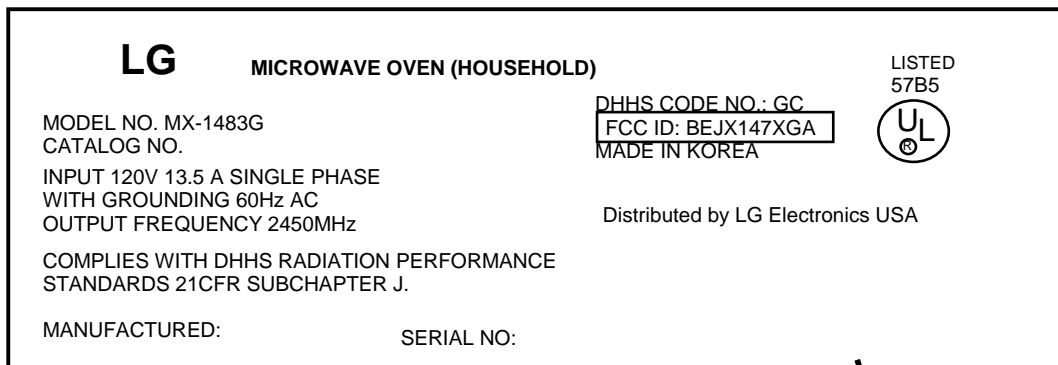

<Fig. 1. Sample Label of Nameplate>

* Alternate location:
The nameplate may be
alternatively affixed on
the left side of control
panel or internal surface
of oven cavity or rear
surface of oven.



< Fig. 2. Photo of the physical location of the label>

APPENDIX C. Block Diagram / Schematics

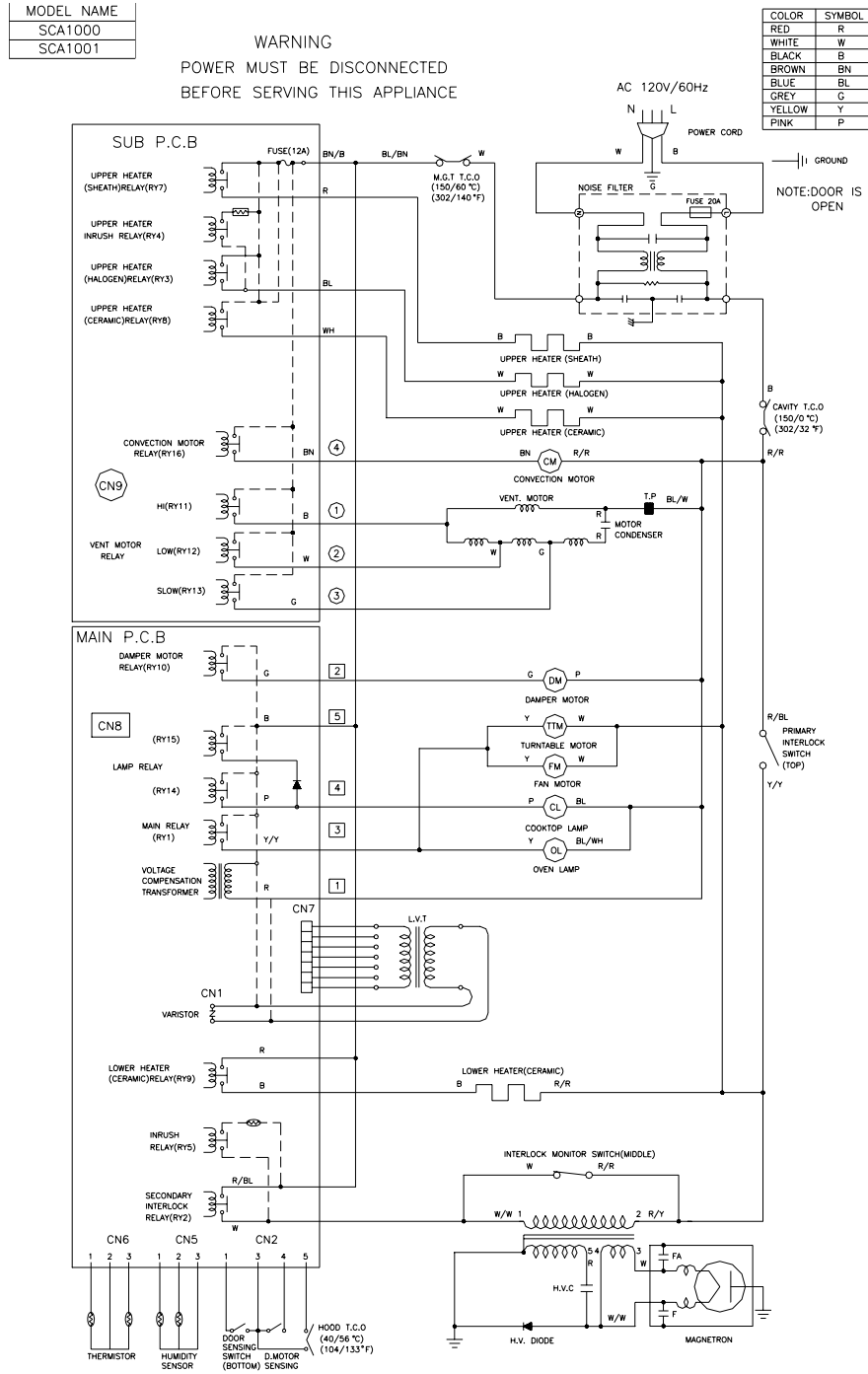

<Fig. 3. Schematic Diagram>

APPENDIX D. Test Photos

Test photos show the worst case configuration and cable placement with a minimum margin to the specifications.

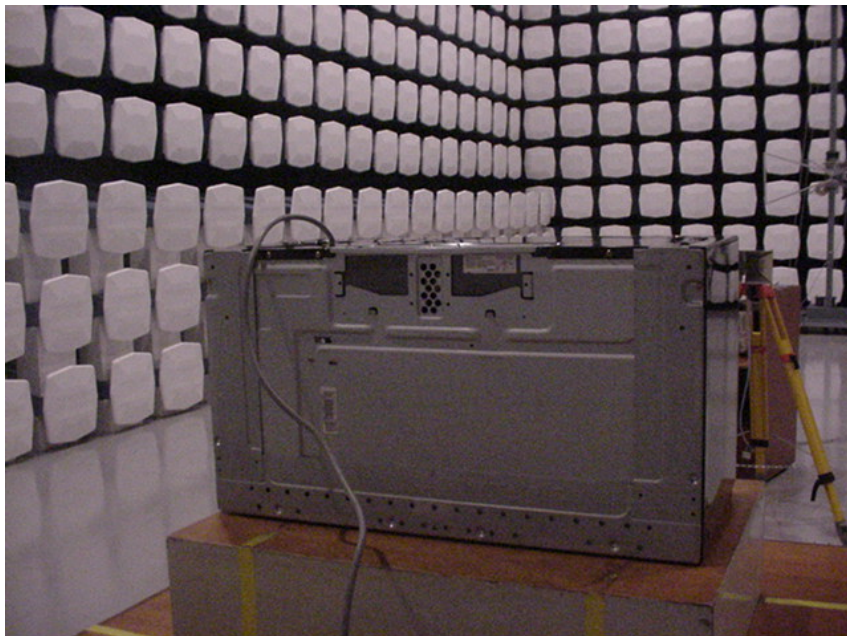
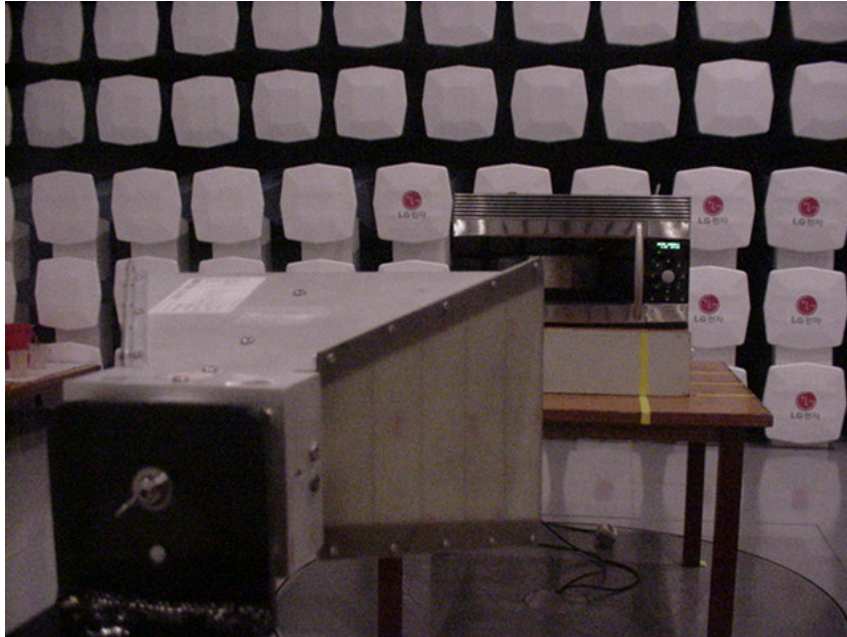

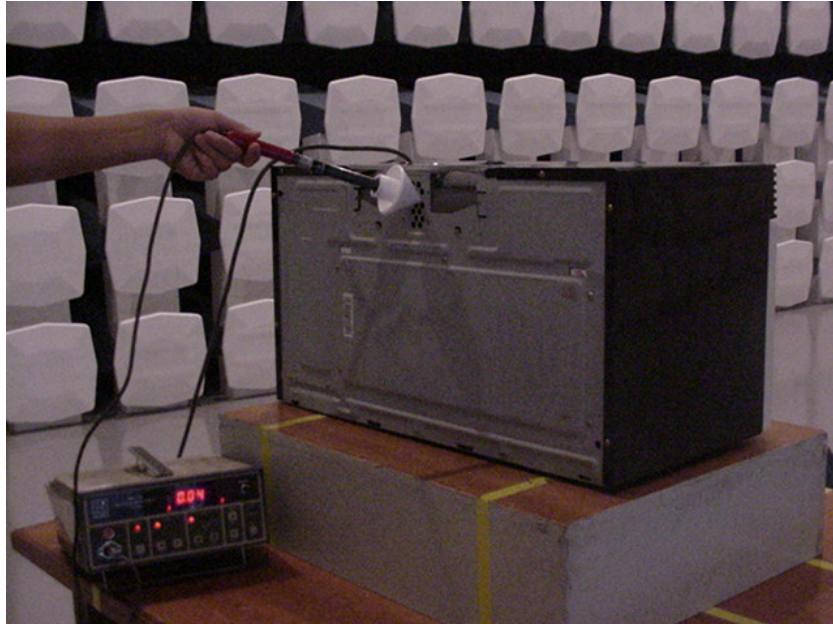
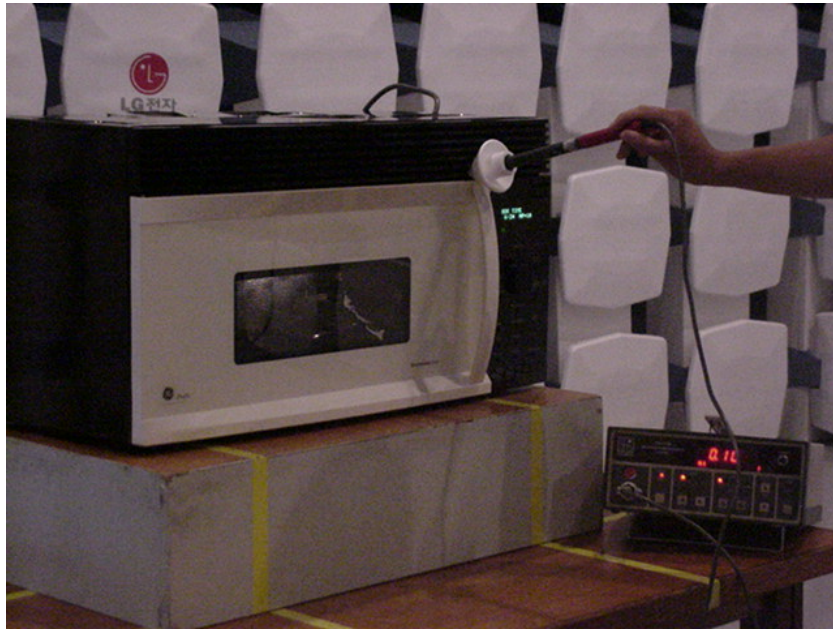

APPENDIX E. EUT Photos





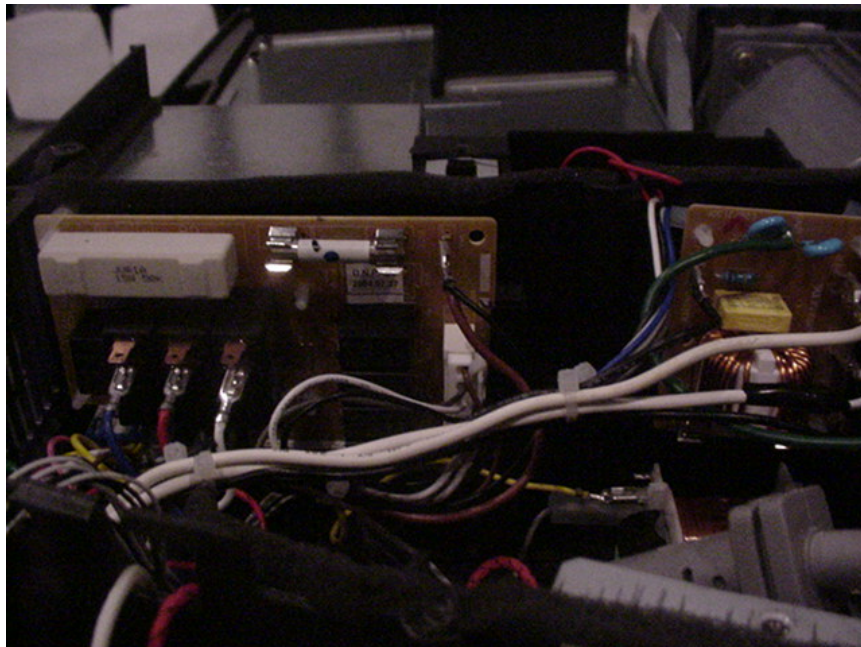
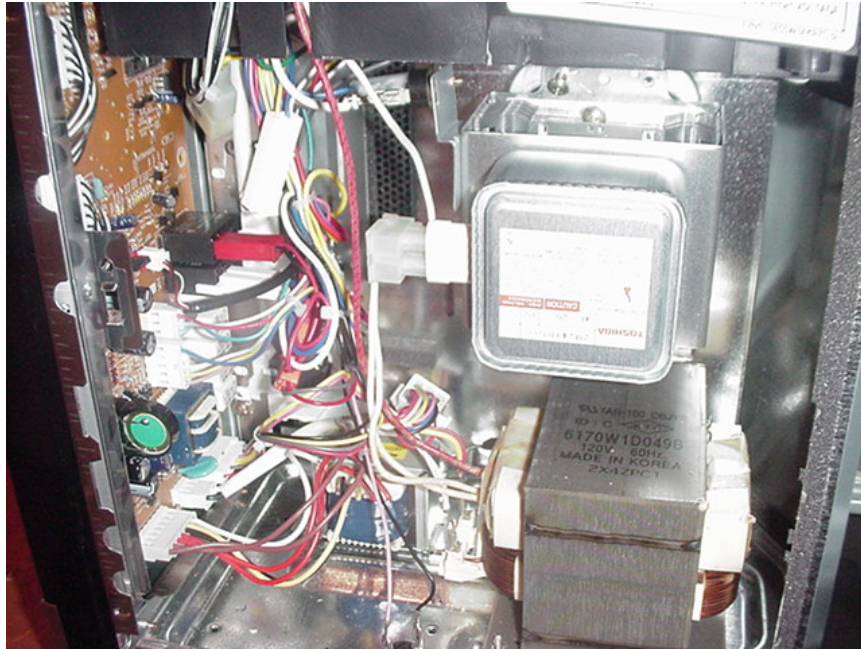

APPENDIX F. Owner's Manual with regard to FCC Instruction

SAFETY

- To avoid improperly cooking some foods.
 - Do not heat any types of baby bottles or baby food. Uneven heating may occur and possibly cause personal injury.
 - Do not heat small-necked containers, such as syrup bottles.
 - Do not deep-fat fry in your microwave oven.
 - Do not attempt home canning in your microwave oven.
 - Do not heat the following items in the microwave oven: whole eggs in the shell, water with oil or fat, sealed containers, or closed glass jars. These items may explode.
- Do not cover or block any openings in the oven.
- Use your oven only for the operations described in this manual.
- Do not run the oven empty, without food in it.
- Do not let cord hang over edge of table or counter.
- Preserve the oven floor:
 - Do not heat the oven floor excessively.
 - Do not allow the gray film on special microwave-cooking packages to touch the oven floor. Put the package on a microwavable dish.
 - Do not cook anything directly on the oven floor or turntable. Use a microwavable dish.
 - Keep a browning dish at least 3/16 inch above floor. Carefully read and follow the instructions for the browning dish. If you use a browning dish incorrectly, you could damage the oven floor.
- Install or locate this appliance only in accordance with the provided installation instructions.
- This appliance should be serviced only by qualified service personnel. Contact the nearest authorized service facility for examination, repair, or adjustment.

SAVE THESE INSTRUCTIONS

FEDERAL COMMUNICATIONS COMMISSION RADIO FREQUENCY INTERFERENCE STATEMENT (U.S.A. ONLY)

⚠ WARNING:

This equipment generates and uses ISM frequency energy and if not installed and used properly, that is in strict accordance with the manufacturer's instructions, may cause interference to radio and television reception. It has been type tested and found to comply with limits for ISM Equipment pursuant to part 18 of FCC Rules, which are designed to provide reasonable protection against such interference in a residential installation. However, there is no guarantee that interference will not occur in a particular installation. If this equipment does cause interference to radio or television reception, which can be determined by turning the equipment off and on, the user is encouraged to try to correct the interference by one or more of the following:

- Reorient the receiving antenna of the radio or television.
- Relocate the Microwave Oven with respect to the receiver.
- Move the microwave oven away from the receiver.
- Plug the microwave oven into a different outlet so that the microwave oven and the receiver are on different branch circuits.

The manufacturer is not responsible for any radio or TV interference caused by **unauthorized modification** to this microwave oven. It is the responsibility of the user to correct such interference.