

Band77-Part27\_50MHz\_DFT\_s\_OFDM\_SCS30kHz\_BPSK\_RB1\_1\_CH648334

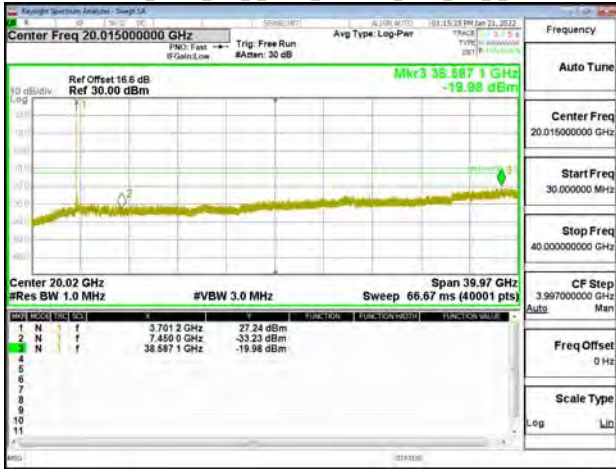

Band77-Part27\_60MHz\_DFT\_s\_OFDM\_SCS30kHz\_BPSK\_RB1\_1\_CH632000

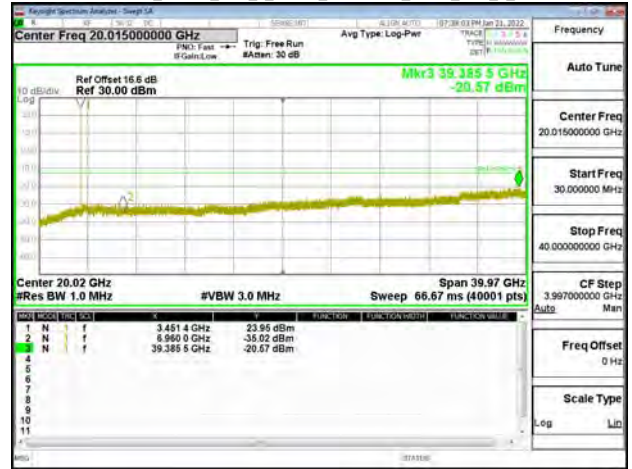

Band77-Part27\_50MHz\_DFT\_s\_OFDM\_SCS30kHz\_BPSK\_RB1\_1\_CH656000

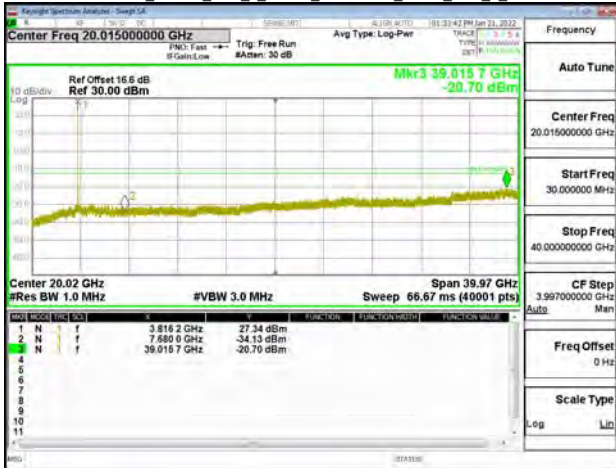

Band77-Part27\_60MHz\_DFT\_s\_OFDM\_SCS30kHz\_BPSK\_RB1\_1\_CH633334



Band77-Part27\_50MHz\_DFT\_s\_OFDM\_SCS30kHz\_BPSK\_RB1\_1\_CH663666



Band77-Part27\_60MHz\_DFT\_s\_OFDM\_SCS30kHz\_BPSK\_RB1\_1\_CH634666



Unless otherwise stated the results shown in this test report refer only to the sample(s) tested and such sample(s) are retained for 90 days only.  
除非另有說明，此報告結果僅對測試之樣品負責，同時此樣品僅保留90天。本報告未經本公司書面許可，不可部份複製。  
This document is issued by the Company subject to its General Conditions of Service printed overleaf, available on request or accessible at <http://www.sgs.com.tw/Terms-and-Conditions> and for electronic format documents, subject to Terms and Conditions for Electronic Documents at <http://www.sgs.com.tw/Terms-and-Conditions>. Attention is drawn to the limitation of liability, indemnification and jurisdiction issues defined therein. Any holder of this document is advised that information contained hereon reflects the Company's findings at the time of its intervention only and within the limits of Client's instructions, if any. The Company's sole responsibility is to its Client and this document does not exonerate parties to a transaction from exercising all their rights and obligations under the transaction documents. This document cannot be reproduced except in full, without prior written approval of the Company. Any unauthorized alteration, forgery or falsification of the content or appearance of this document is unlawful and offenders may be prosecuted to the fullest extent of the law.

Band77-Part27\_60MHz\_DFT\_s\_OFDM\_SCS30kHz\_BPSK\_RB1\_1\_CH648668

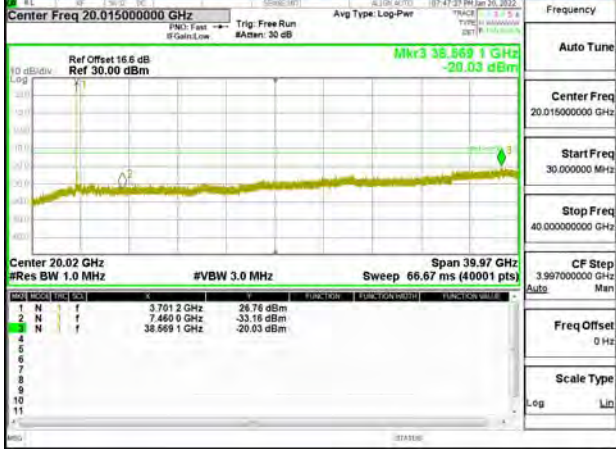

Band77-Part27\_70MHz\_DFT\_s\_OFDM\_SCS30kHz\_BPSK\_RB1\_1\_CH632334

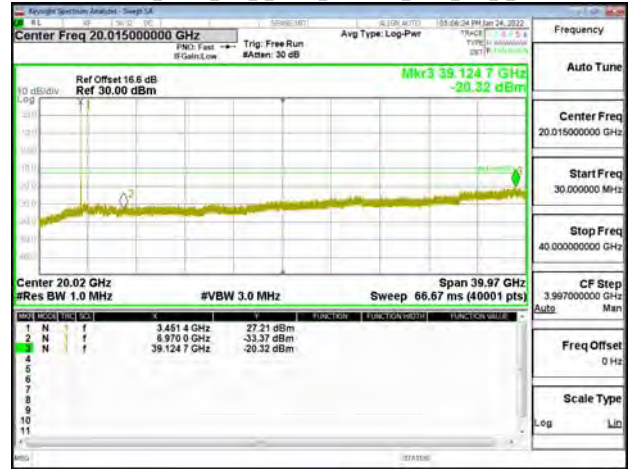

Band77-Part27\_60MHz\_DFT\_s\_OFDM\_SCS30kHz\_BPSK\_RB1\_1\_CH656000

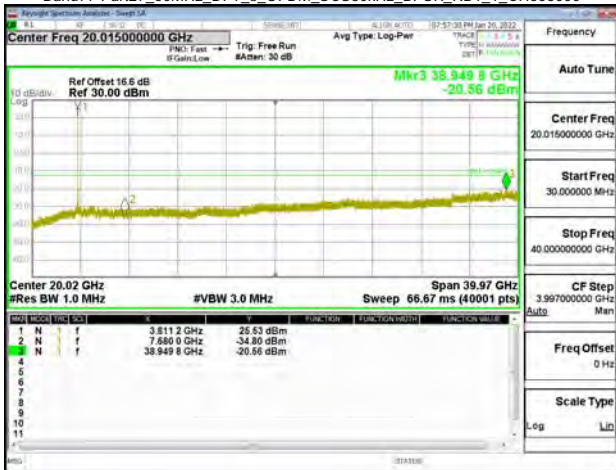

Band77-Part27\_70MHz\_DFT\_s\_OFDM\_SCS30kHz\_BPSK\_RB1\_1\_CH633334

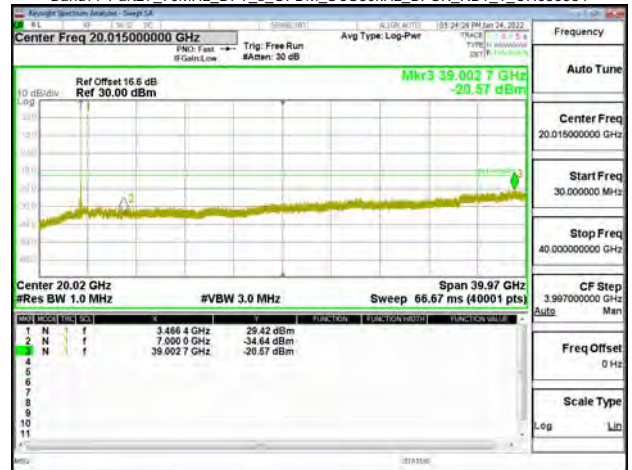

Band77-Part27\_60MHz\_DFT\_s\_OFDM\_SCS30kHz\_BPSK\_RB1\_1\_CH663332

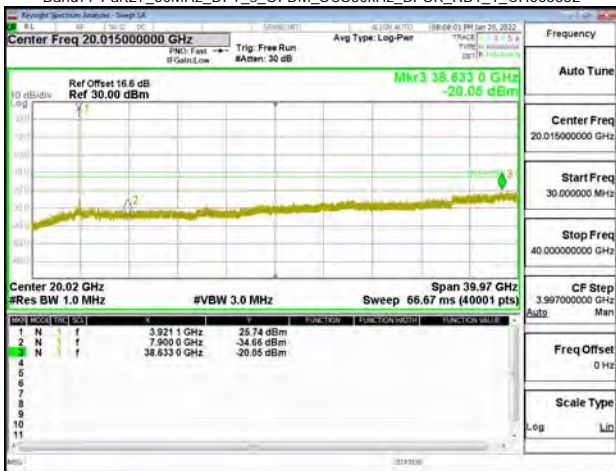

Band77-Part27\_70MHz\_DFT\_s\_OFDM\_SCS30kHz\_BPSK\_RB1\_1\_CH634332

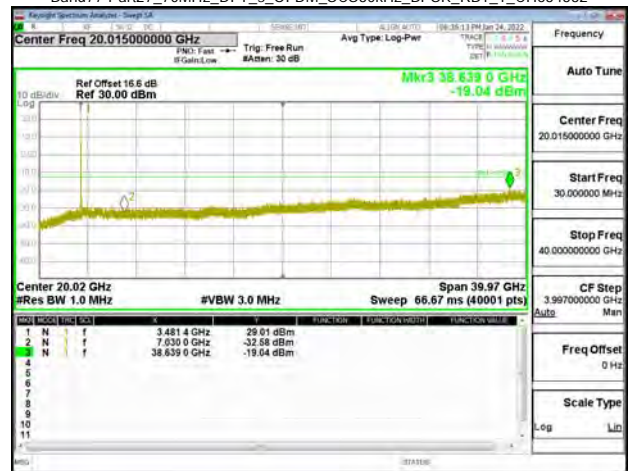

Unless otherwise stated the results shown in this test report refer only to the sample(s) tested and such sample(s) are retained for 90 days only.

除非另有說明，此報告結果僅對測試之樣品負責，同時此樣品僅保留90天。本報告未經本公司書面許可，不可部份複製。

This document is issued by the Company subject to its General Conditions of Service printed overleaf, available on request or accessible at <http://www.sgs.com.tw/Terms-and-Conditions> and for electronic format documents, subject to Terms and Conditions for Electronic Documents at <http://www.sgs.com.tw/Terms-and-Conditions>. Attention is drawn to the limitation of liability, indemnification and jurisdiction issues defined therein. Any holder of this document is advised that information contained hereon reflects the Company's findings at the time of its intervention only and within the limits of Client's instructions, if any. The Company's sole responsibility is to its Client and this document does not exonerate parties to a transaction from exercising all their rights and obligations under the transaction documents. This document cannot be reproduced except in full, without prior written approval of the Company. Any unauthorized alteration, forgery or falsification of the content or appearance of this document is unlawful and offenders may be prosecuted to the fullest extent of the law.

Band77-Part27\_70MHz\_DFT\_s\_OFDM\_SCS30kHz\_BPSK\_RB1\_1\_CH649000



Band77-Part27\_80MHz\_DFT\_s\_OFDM\_SCS30kHz\_BPSK\_RB1\_1\_CH632668



Band77-Part27\_70MHz\_DFT\_s\_OFDM\_SCS30kHz\_BPSK\_RB1\_1\_CH656000



Band77-Part27\_80MHz\_DFT\_s\_OFDM\_SCS30kHz\_BPSK\_RB1\_1\_CH633334



Band77-Part27\_70MHz\_DFT\_s\_OFDM\_SCS30kHz\_BPSK\_RB1\_1\_CH663000

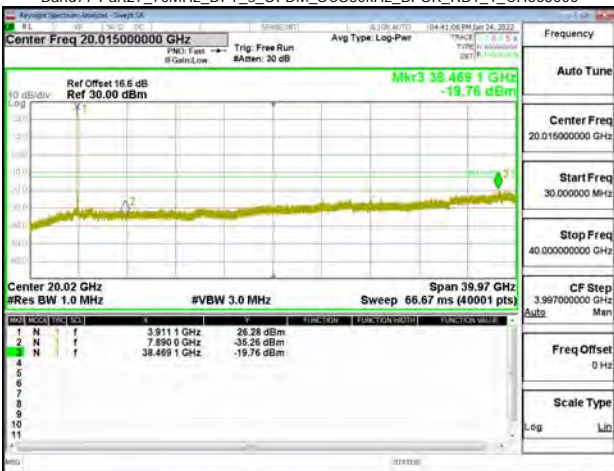

Band77-Part27\_80MHz\_DFT\_s\_OFDM\_SCS30kHz\_BPSK\_RB1\_1\_CH634000



Unless otherwise stated the results shown in this test report refer only to the sample(s) tested and such sample(s) are retained for 90 days only.

除非另有說明，此報告結果僅對測試之樣品負責，同時此樣品僅保留90天。本報告未經本公司書面許可，不可部份複製。

This document is issued by the Company subject to its General Conditions of Service printed overleaf, available on request or accessible at <http://www.sgs.com.tw/Terms-and-Conditions> and for electronic format documents, subject to Terms and Conditions for Electronic Documents at <http://www.sgs.com.tw/Terms-and-Conditions>. Attention is drawn to the limitation of liability, indemnification and jurisdiction issues defined therein. Any holder of this document is advised that information contained hereon reflects the Company's findings at the time of its intervention only and within the limits of Client's instructions, if any. The Company's sole responsibility is to its Client and this document does not exonerate parties to a transaction from exercising all their rights and obligations under the transaction documents. This document cannot be reproduced except in full, without prior written approval of the Company. Any unauthorized alteration, forgery or falsification of the content or appearance of this document is unlawful and offenders may be prosecuted to the fullest extent of the law.

Band77-Part27\_80MHz\_DFT\_s\_OFDM\_SCS30kHz\_BPSK\_RB1\_1\_CH649334



Band77-Part27\_90MHz\_DFT\_s\_OFDM\_SCS30kHz\_BPSK\_RB1\_1\_CH633000



Band77-Part27\_80MHz\_DFT\_s\_OFDM\_SCS30kHz\_BPSK\_RB1\_1\_CH656000

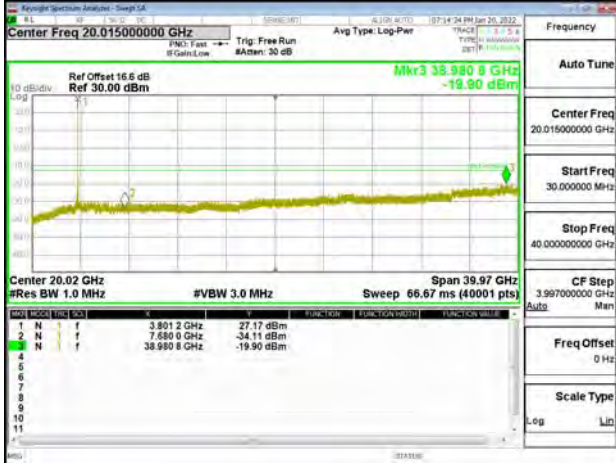

Band77-Part27\_90MHz\_DFT\_s\_OFDM\_SCS30kHz\_BPSK\_RB1\_1\_CH633334

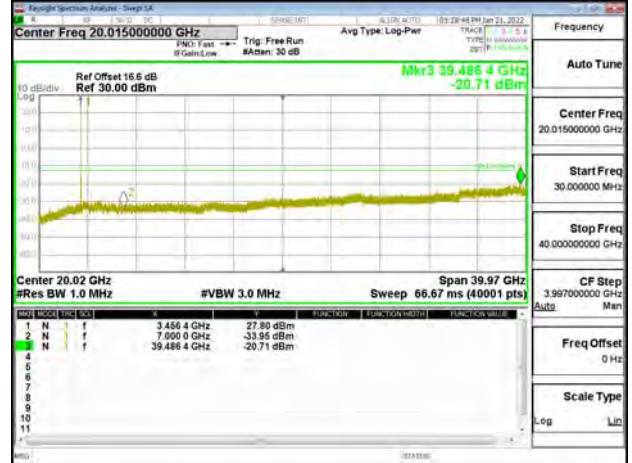

Band77-Part27\_80MHz\_DFT\_s\_OFDM\_SCS30kHz\_BPSK\_RB1\_1\_CH662666



Band77-Part27\_90MHz\_DFT\_s\_OFDM\_SCS30kHz\_BPSK\_RB1\_1\_CH633666

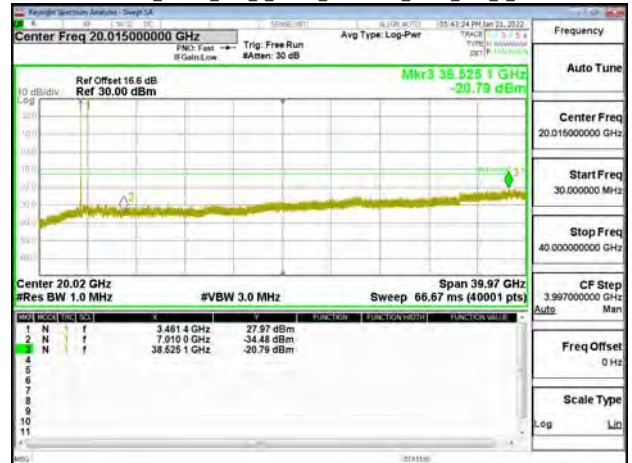

Unless otherwise stated the results shown in this test report refer only to the sample(s) tested and such sample(s) are retained for 90 days only.

除非另有說明，此報告結果僅對測試之樣品負責，同時此樣品僅保留90天。本報告未經本公司書面許可，不可部份複製。

This document is issued by the Company subject to its General Conditions of Service printed overleaf, available on request or accessible at <http://www.sgs.com.tw/Terms-and-Conditions> and for electronic format documents, subject to Terms and Conditions for Electronic Documents at <http://www.sgs.com.tw/Terms-and-Conditions>. Attention is drawn to the limitation of liability, indemnification and jurisdiction issues defined therein. Any holder of this document is advised that information contained hereon reflects the Company's findings at the time of its intervention only and within the limits of Client's instructions, if any. The Company's sole responsibility is to its Client and this document does not exonerate parties to a transaction from exercising all their rights and obligations under the transaction documents. This document cannot be reproduced except in full, without prior written approval of the Company. Any unauthorized alteration, forgery or falsification of the content or appearance of this document is unlawful and offenders may be prosecuted to the fullest extent of the law.

Band77-Part27\_90MHz\_DFT\_s\_OFDM\_SCS30kHz\_BPSK\_RB1\_1\_CH649668

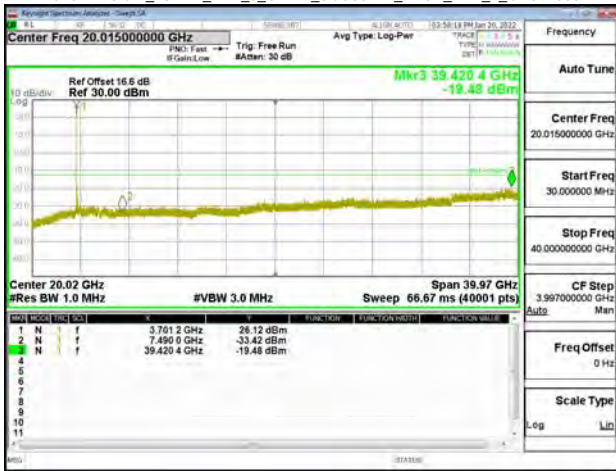

Band77-Part27\_100MHz\_DFT\_s\_OFDM\_SCS30kHz\_BPSK\_RB1\_1\_CH633334



Band77-Part27\_90MHz\_DFT\_s\_OFDM\_SCS30kHz\_BPSK\_RB1\_1\_CH656000

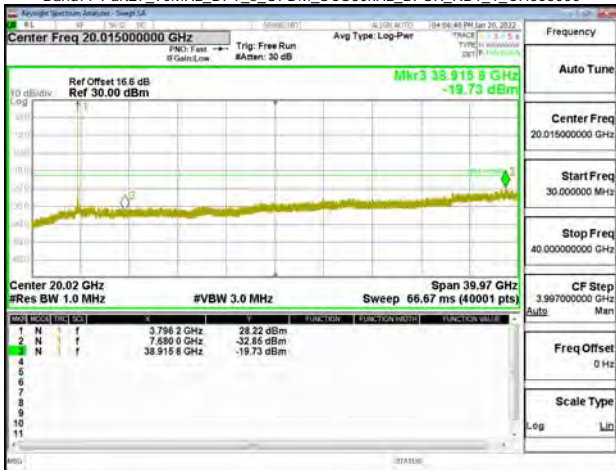

Band77-Part27\_100MHz\_DFT\_s\_OFDM\_SCS30kHz\_BPSK\_RB1\_1\_CH650000



Band77-Part27\_90MHz\_DFT\_s\_OFDM\_SCS30kHz\_BPSK\_RB1\_1\_CH662332

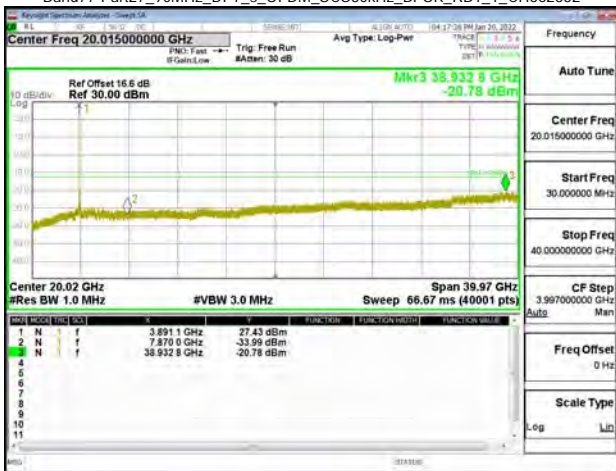

Band77-Part27\_100MHz\_DFT\_s\_OFDM\_SCS30kHz\_BPSK\_RB1\_1\_CH656000



Unless otherwise stated the results shown in this test report refer only to the sample(s) tested and such sample(s) are retained for 90 days only.

除非另有說明，此報告結果僅對測試之樣品負責，同時此樣品僅保留90天。本報告未經本公司書面許可，不可部份複製。  
This document is issued by the Company subject to its General Conditions of Service printed overleaf, available on request or accessible at <http://www.sgs.com.tw/Terms-and-Conditions> and for electronic format documents, subject to Terms and Conditions for Electronic Documents at <http://www.sgs.com.tw/Terms-and-Conditions>. Attention is drawn to the limitation of liability, indemnification and jurisdiction issues defined therein. Any holder of this document is advised that information contained hereon reflects the Company's findings at the time of its intervention only and within the limits of Client's instructions, if any. The Company's sole responsibility is to its Client and this document does not exonerate parties to a transaction from exercising all their rights and obligations under the transaction documents. This document cannot be reproduced except in full, without prior written approval of the Company. Any unauthorized alteration, forgery or falsification of the content or appearance of this document is unlawful and offenders may be prosecuted to the fullest extent of the law.

Band77-Part27\_100MHz\_DFT\_s\_OFDM\_SCS30kHz\_BPSK\_RB1\_1\_CH662000

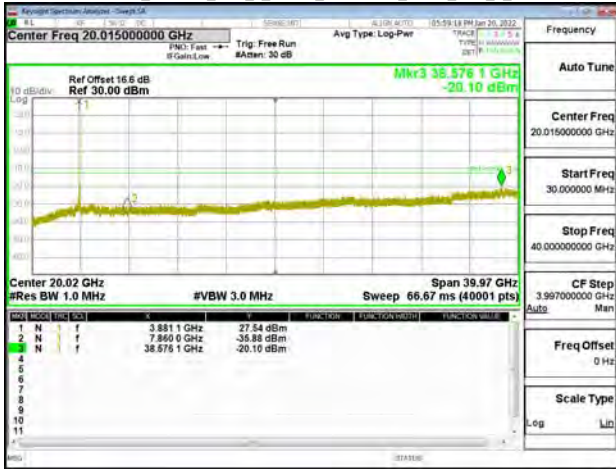

Unless otherwise stated the results shown in this test report refer only to the sample(s) tested and such sample(s) are retained for 90 days only.

除非另有說明，此報告結果僅對測試之樣品負責，同時此樣品僅保留90天。本報告未經本公司書面許可，不可部份複製。  
This document is issued by the Company subject to its General Conditions of Service printed overleaf, available on request or accessible at <http://www.sgs.com.tw/Terms-and-Conditions> and for electronic format documents, subject to Terms and Conditions for Electronic Documents at <http://www.sgs.com.tw/Terms-and-Conditions>. Attention is drawn to the limitation of liability, indemnification and jurisdiction issues defined therein. Any holder of this document is advised that information contained hereon reflects the Company's findings at the time of its intervention only and within the limits of Client's instructions, if any. The Company's sole responsibility is to its Client and this document does not exonerate parties to a transaction from exercising all their rights and obligations under the transaction documents. This document cannot be reproduced except in full, without prior written approval of the Company. Any unauthorized alteration, forgery or falsification of the content or appearance of this document is unlawful and offenders may be prosecuted to the fullest extent of the law.

## 10 FIELD STRENGTH OF SPURIOUS RADIATION MEASUREMENT

### 10.1 Standard Applicable

According to FCC §2.1053,

FCC §27.53(l)(2)

- (2) For mobile operations in the 3700-3980 MHz band, the conducted power of any emission outside the licensee's authorized bandwidth shall not exceed  $-13$  dBm/MHz. Compliance with this paragraph (l)(2) is based on the use of measurement instrumentation employing a resolution bandwidth of 1 megahertz or greater. However, in the 1 megahertz bands immediately outside and adjacent to the licensee's frequency block, the minimum resolution bandwidth for the measurement shall be either one percent of the emission bandwidth of the fundamental emission of the transmitter or 350 kHz. In the bands between 1 and 5 MHz removed from the licensee's frequency block, the minimum resolution bandwidth for the measurement shall be 500 kHz. The emission bandwidth is defined as the width of the signal between two points, one below the carrier center frequency and one above the carrier center frequency, outside of which all emissions are attenuated at least 26 dB below the transmitter power.

FCC §27.53(n)(2)

- (2) For mobile operations in the 3450-3550 MHz band, the conducted power of any emission outside the licensee's authorized bandwidth shall not exceed  $-13$  dBm/MHz. Compliance with this paragraph (n)(2) is based on the use of measurement instrumentation employing a resolution bandwidth of 1 megahertz or greater. However, in the 1 megahertz bands immediately outside and adjacent to the licensee's frequency block, a resolution bandwidth of at least one percent of the emission bandwidth of the fundamental emission of the transmitter may be employed, but limited to a maximum of 200 kHz. In the bands between 1 and 5 MHz removed from the licensee's frequency block, the minimum resolution bandwidth for the measurement shall be 500 kHz. The emission bandwidth is defined as the width of the signal between two points, one below the carrier center frequency and one above the carrier center frequency, outside of which all emissions are attenuated at least 26 dB below the transmitter power.

Unless otherwise stated the results shown in this test report refer only to the sample(s) tested and such sample(s) are retained for 90 days only.

除非另有說明，此報告結果僅對測試之樣品負責，同時此樣品僅保留90天。本報告未經本公司書面許可，不可部份複製。

This document is issued by the Company subject to its General Conditions of Service printed overleaf, available on request or accessible at <http://www.sgs.com.tw/Terms-and-Conditions> and for electronic format documents, subject to Terms and Conditions for Electronic Documents at <http://www.sgs.com.tw/Terms-and-Conditions>. Attention is drawn to the limitation of liability, indemnification and jurisdiction issues defined therein. Any holder of this document is advised that information contained hereon reflects the Company's findings at the time of its intervention only and within the limits of Client's instructions, if any. The Company's sole responsibility is to its Client and this document does not exonerate parties to a transaction from exercising all their rights and obligations under the transaction documents. This document cannot be reproduced except in full, without prior written approval of the Company. Any unauthorized alteration, forgery or falsification of the content or appearance of this document is unlawful and offenders may be prosecuted to the fullest extent of the law.

## 10.2 EUT Setup

### Radiated Emission Test Set-Up, Frequency Below 1000MHz

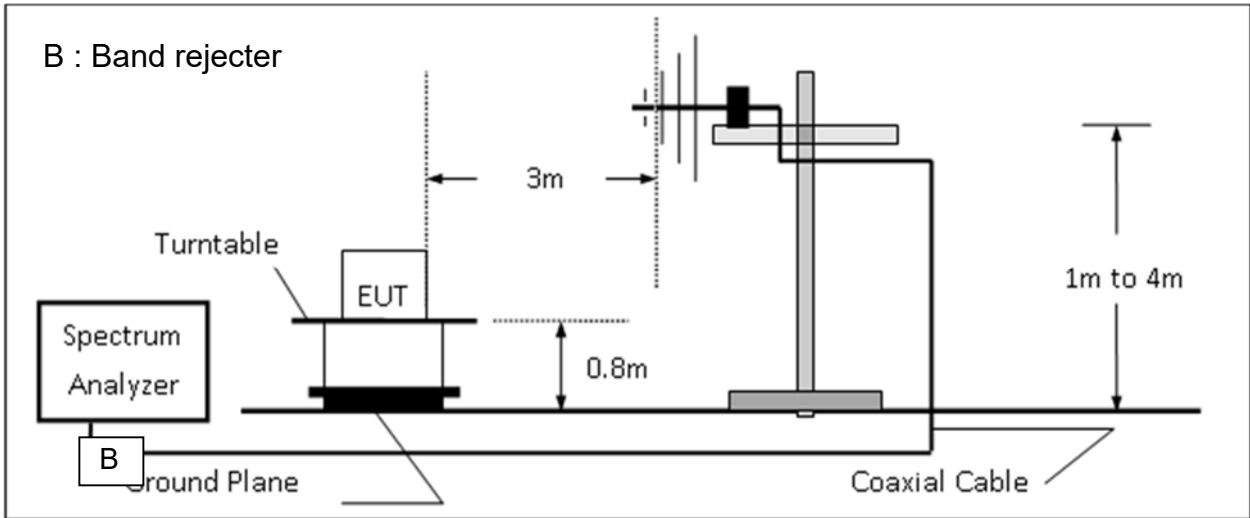

### Radiated Emission Test Set-UP Frequency Over 1 GHz

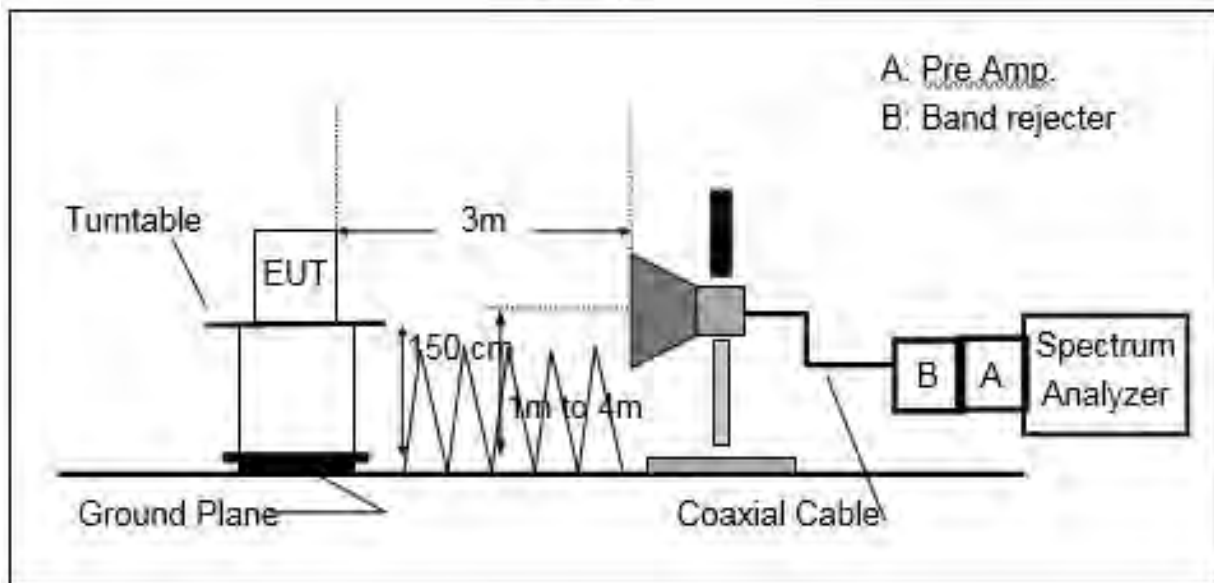

Unless otherwise stated the results shown in this test report refer only to the sample(s) tested and such sample(s) are retained for 90 days only.

除非另有說明，此報告結果僅對測試之樣品負責，同時此樣品僅保留90天。本報告未經本公司書面許可，不可部份複製。

This document is issued by the Company subject to its General Conditions of Service printed overleaf, available on request or accessible at <http://www.sgs.com.tw/Terms-and-Conditions> and for electronic format documents, subject to Terms and Conditions for Electronic Documents at <http://www.sgs.com.tw/Terms-and-Conditions>. Attention is drawn to the limitation of liability, indemnification and jurisdiction issues defined therein. Any holder of this document is advised that information contained hereon reflects the Company's findings at the time of its intervention only and within the limits of Client's instructions, if any. The Company's sole responsibility is to its Client and this document does not exonerate parties to a transaction from exercising all their rights and obligations under the transaction documents. This document cannot be reproduced except in full, without prior written approval of the Company. Any unauthorized alteration, forgery or falsification of the content or appearance of this document is unlawful and offenders may be prosecuted to the fullest extent of the law.



### 10.3 Measurement Procedure:

The EUT was placed on a non-conductive; the measurement antenna was placed at a distance of 3 meters from the EUT. During the tests, the antenna height and the EUT azimuth were varied in order to identify the maximum level of emissions from the EUT. This maximization process was repeated with the EUT positioned in each of its three orthogonal orientations.

The frequency range up to tenth harmonic was investigated for each of three fundamental frequencies (low, middle and high channels). Once spurious emission was identified, the power of the emission was determined using the substitution method.

The spurious emissions attenuation was calculated as the difference between radiated power at the fundamental frequency and the spurious emissions frequency.

$$\text{ERP (dBm)} = \text{SG Level(dBm)} + \text{Antenna Gain(dBd)} + \text{Cable Loss(dB)}$$

$$\text{EIRP (dBm)} = \text{SG Level(dBm)} + \text{Antenna Gain(dBi)} + \text{Cable Loss(dB)}$$

Unless otherwise stated the results shown in this test report refer only to the sample(s) tested and such sample(s) are retained for 90 days only.

除非另有說明，此報告結果僅對測試之樣品負責，同時此樣品僅保留90天。本報告未經本公司書面許可，不可部份複製。

This document is issued by the Company subject to its General Conditions of Service printed overleaf, available on request or accessible at <http://www.sgs.com.tw/Terms-and-Conditions> and for electronic format documents, subject to Terms and Conditions for Electronic Documents at <http://www.sgs.com.tw/Terms-and-Conditions>. Attention is drawn to the limitation of liability, indemnification and jurisdiction issues defined therein. Any holder of this document is advised that information contained hereon reflects the Company's findings at the time of its intervention only and within the limits of Client's instructions, if any. The Company's sole responsibility is to its Client and this document does not exonerate parties to a transaction from exercising all their rights and obligations under the transaction documents. This document cannot be reproduced except in full, without prior written approval of the Company. Any unauthorized alteration, forgery or falsification of the content or appearance of this document is unlawful and offenders may be prosecuted to the fullest extent of the law.

### 10.4 Measurement Result:

Report Number :ER/2021/C0138  
 Operation Mode :n77  
 Test Mode :Tx CH Low  
 EUT Pol :H Plane  
 Test Frequency :3465 MHz

Test Site :SAC 1  
 Test Date :2022-01-26  
 Temp./Humi. :23.8/68  
 Antenna Pol. :Vertical  
 Engineer :GN Lin

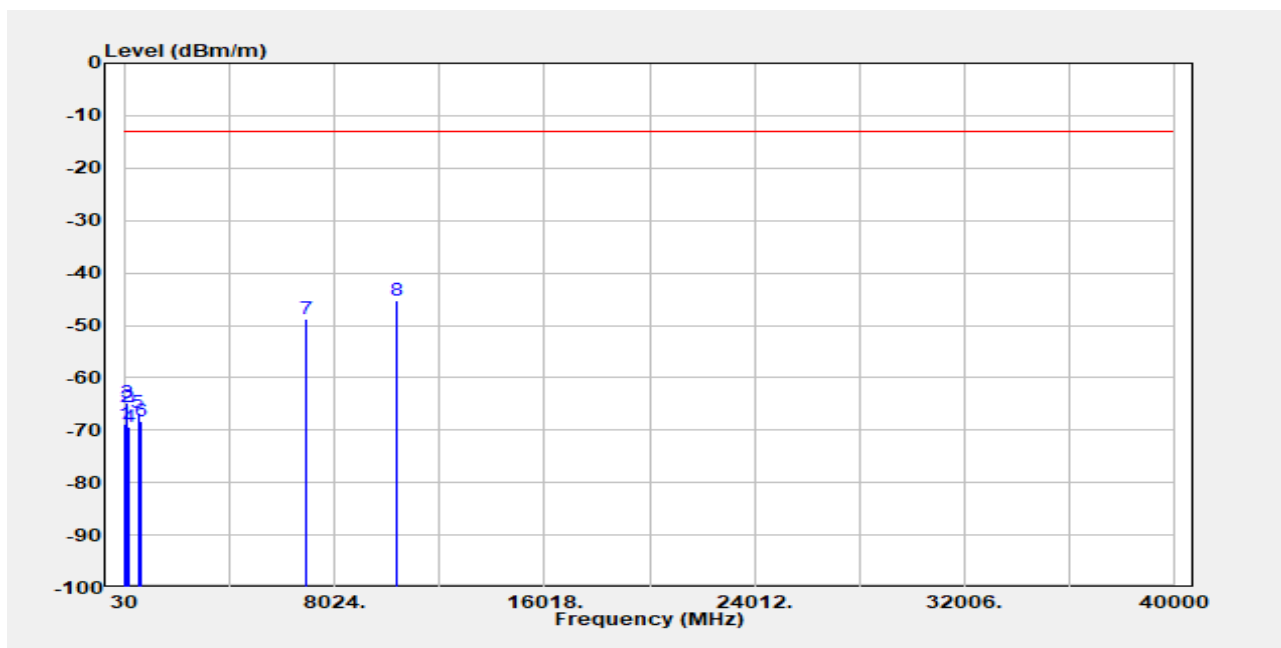

Freq. MHz	EIRP/ERP dBm	SG Output Level dBm	Antenna Gain dBi/dBd	Cable Loss dB	Limit dBm	Margin dB
36.47	-68.96	-54.65	-13.67	-0.64	-13.00	-55.96
78.50	-65.59	-61.18	-3.52	-0.89	-13.00	-52.59
99.52	-64.82	-63.09	-0.72	-1.01	-13.00	-51.82
170.65	-69.36	-67.87	-0.21	-1.27	-13.00	-56.36
500.45	-66.72	-68.56	4.25	-2.41	-13.00	-53.72
610.38	-68.26	-69.25	3.48	-2.50	-13.00	-55.26
6930.00	-48.84	-50.76	11.74	-9.82	-13.00	-35.84
10395.00	-45.38	-46.64	11.31	-10.05	-13.00	-32.38

Unless otherwise stated the results shown in this test report refer only to the sample(s) tested and such sample(s) are retained for 90 days only.

除非另有說明，此報告結果僅對測試之樣品負責，同時此樣品僅保留90天。本報告未經本公司書面許可，不可部份複製。

This document is issued by the Company subject to its General Conditions of Service printed overleaf, available on request or accessible at <http://www.sgs.com.tw/Terms-and-Conditions> and for electronic format documents, subject to Terms and Conditions for Electronic Documents at <http://www.sgs.com.tw/Terms-and-Conditions>. Attention is drawn to the limitation of liability, indemnification and jurisdiction issues defined therein. Any holder of this document is advised that information contained hereon reflects the Company's findings at the time of its intervention only and within the limits of Client's instructions, if any. The Company's sole responsibility is to its Client and this document does not exonerate parties to a transaction from exercising all their rights and obligations under the transaction documents. This document cannot be reproduced except in full, without prior written approval of the Company. Any unauthorized alteration, forgery or falsification of the content or appearance of this document is unlawful and offenders may be prosecuted to the fullest extent of the law.

Report Number :ER/2021/C0138  
 Operation Mode :n77  
 Test Mode :Tx CH Low  
 EUT Pol :H Plane  
 Test Frequency :3465 MHz

Test Site :SAC 1  
 Test Date :2022-01-26  
 Temp./Humi. :23.8/68  
 Antenna Pol. :Horizontal  
 Engineer :GN Lin

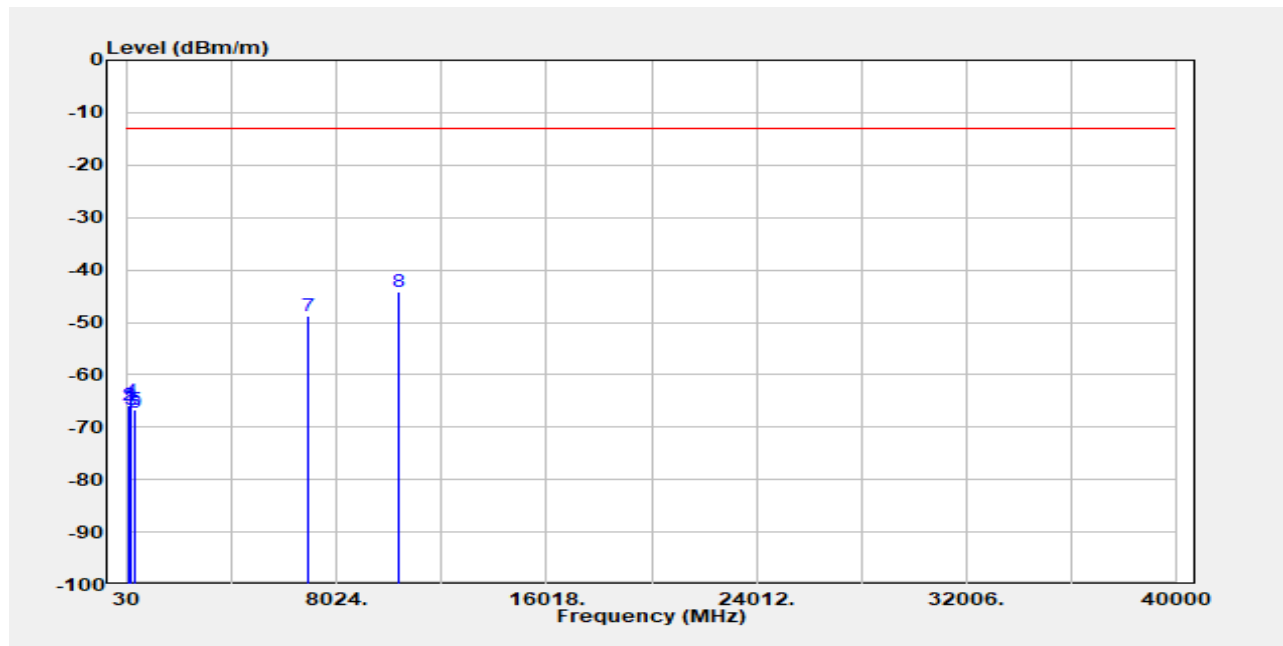

Freq. MHz	EIRP/ERP dBm	SG Output Level dBm	Antenna Gain dBi/dBd	Cable Loss dB	Limit dBm	Margin dB
78.50	-66.07	-61.66	-3.52	-0.89	-13.00	-53.07
89.82	-65.87	-64.46	-0.43	-0.98	-13.00	-52.87
156.10	-66.65	-64.09	-1.36	-1.21	-13.00	-53.65
170.65	-65.07	-63.59	-0.21	-1.27	-13.00	-52.07
335.55	-66.68	-69.07	4.28	-1.90	-13.00	-53.68
342.02	-67.10	-69.55	4.36	-1.92	-13.00	-54.10
6930.00	-48.85	-50.77	11.74	-9.82	-13.00	-35.85
10395.00	-44.22	-45.48	11.31	-10.05	-13.00	-31.22

Unless otherwise stated the results shown in this test report refer only to the sample(s) tested and such sample(s) are retained for 90 days only.

除非另有說明，此報告結果僅對測試之樣品負責，同時此樣品僅保留90天。本報告未經本公司書面許可，不可部份複製。  
 This document is issued by the Company subject to its General Conditions of Service printed overleaf, available on request or accessible at <http://www.sgs.com.tw/Terms-and-Conditions> and for electronic format documents, subject to Terms and Conditions for Electronic Documents at <http://www.sgs.com.tw/Terms-and-Conditions>. Attention is drawn to the limitation of liability, indemnification and jurisdiction issues defined therein. Any holder of this document is advised that information contained hereon reflects the Company's findings at the time of its intervention only and within the limits of Client's instructions, if any. The Company's sole responsibility is to its Client and this document does not exonerate parties to a transaction from exercising all their rights and obligations under the transaction documents. This document cannot be reproduced except in full, without prior written approval of the Company. Any unauthorized alteration, forgery or falsification of the content or appearance of this document is unlawful and offenders may be prosecuted to the fullest extent of the law.

Report Number :ER/2021/C0138  
 Operation Mode :n77  
 Test Mode :Tx CH Mid  
 EUT Pol :H Plane  
 Test Frequency :3500.01 MHz

Test Site :SAC 1  
 Test Date :2022-01-26  
 Temp./Humi. :23.8/68  
 Antenna Pol. :Vertical  
 Engineer :GN Lin

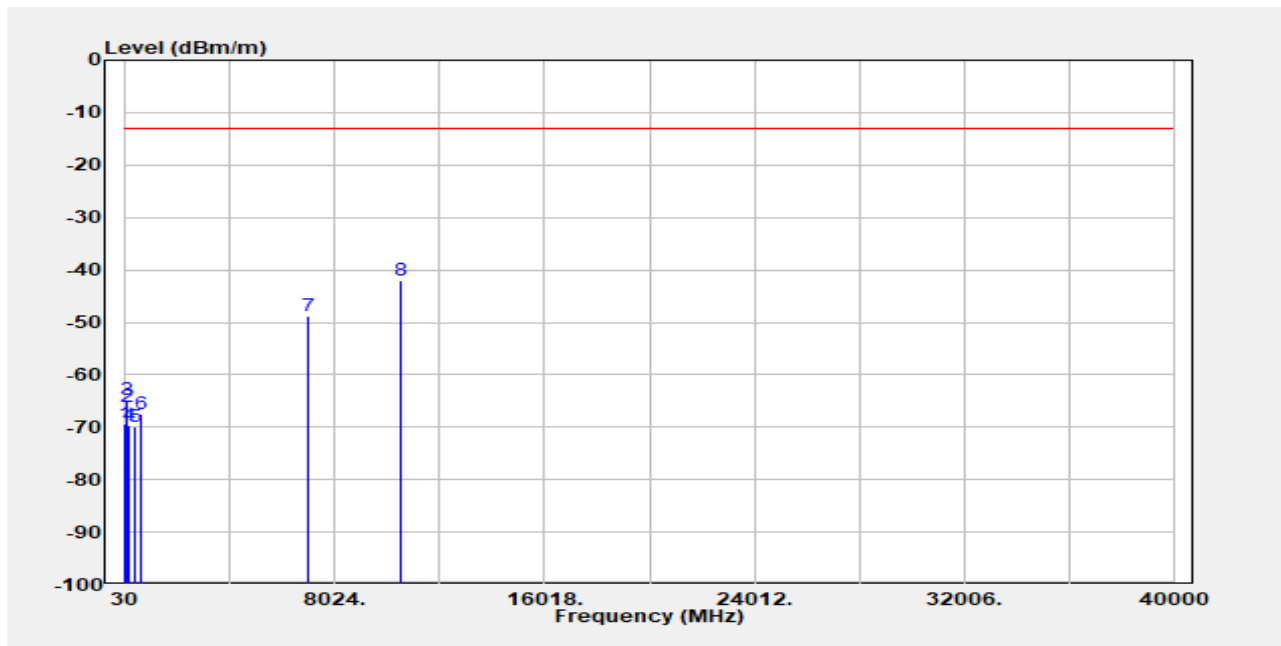

Freq. MHz	EIRP/ERP dBm	SG Output Level dBm	Antenna Gain dBi/dBd	Cable Loss dB	Limit dBm	Margin dB
36.47	-69.30	-54.98	-13.67	-0.64	-13.00	-56.30
78.50	-66.15	-61.74	-3.52	-0.89	-13.00	-53.15
99.52	-64.85	-63.12	-0.72	-1.01	-13.00	-51.85
170.65	-69.74	-68.25	-0.21	-1.27	-13.00	-56.74
348.48	-69.92	-72.43	4.52	-2.01	-13.00	-56.92
610.38	-67.44	-68.43	3.48	-2.50	-13.00	-54.44
7000.02	-48.74	-50.59	11.50	-9.65	-13.00	-35.74
10500.03	-41.99	-42.27	11.20	-10.92	-13.00	-28.99

Unless otherwise stated the results shown in this test report refer only to the sample(s) tested and such sample(s) are retained for 90 days only.

除非另有說明，此報告結果僅對測試之樣品負責，同時此樣品僅保留90天。本報告未經本公司書面許可，不可部份複製。

This document is issued by the Company subject to its General Conditions of Service printed overleaf, available on request or accessible at <http://www.sgs.com.tw/Terms-and-Conditions> and for electronic format documents, subject to Terms and Conditions for Electronic Documents at <http://www.sgs.com.tw/Terms-and-Conditions>. Attention is drawn to the limitation of liability, indemnification and jurisdiction issues defined therein. Any holder of this document is advised that information contained hereon reflects the Company's findings at the time of its intervention only and within the limits of Client's instructions, if any. The Company's sole responsibility is to its Client and this document does not exonerate parties to a transaction from exercising all their rights and obligations under the transaction documents. This document cannot be reproduced except in full, without prior written approval of the Company. Any unauthorized alteration, forgery or falsification of the content or appearance of this document is unlawful and offenders may be prosecuted to the fullest extent of the law.

Report Number :ER/2021/C0138  
 Operation Mode :n77  
 Test Mode :Tx CH Mid  
 EUT Pol :H Plane  
 Test Frequency :3500.01 MHz

Test Site :SAC 1  
 Test Date :2022-01-26  
 Temp./Humi. :23.8/68  
 Antenna Pol. :Horizontal  
 Engineer :GN Lin

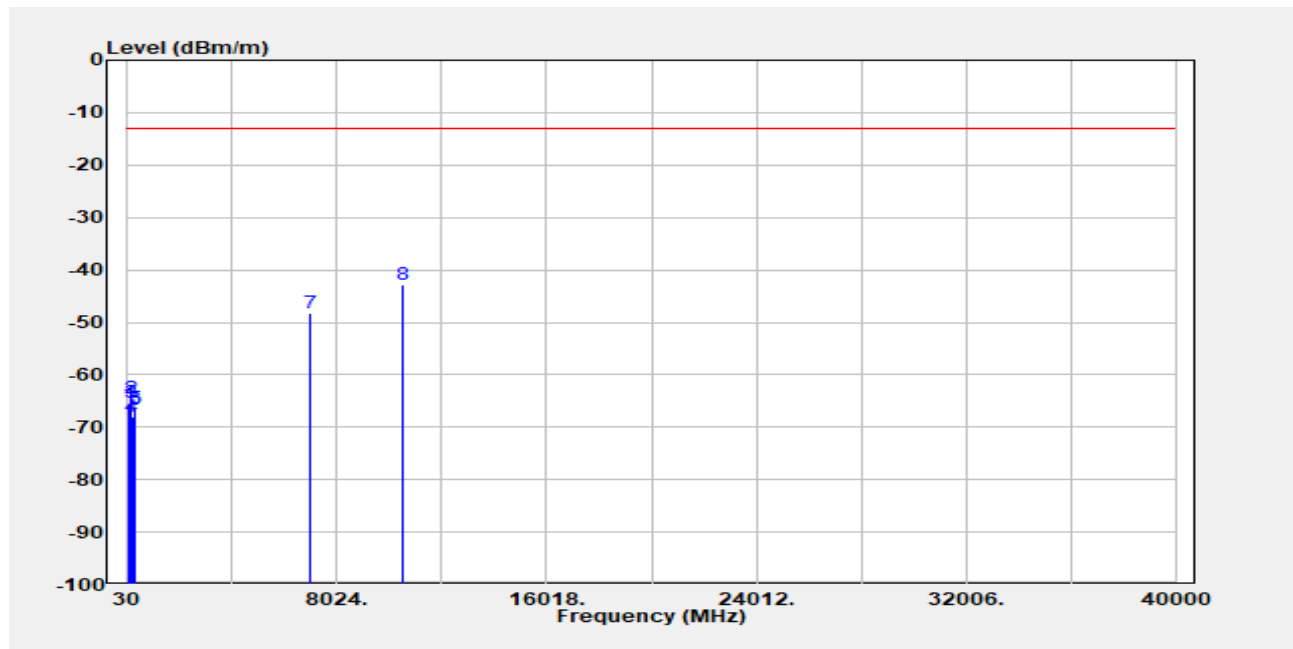

Freq. MHz	EIRP/ERP dBm	SG Output Level dBm	Antenna Gain dBi/dBd	Cable Loss dB	Limit dBm	Margin dB
89.82	-65.47	-64.06	-0.43	-0.98	-13.00	-52.47
156.10	-64.45	-61.88	-1.36	-1.21	-13.00	-51.45
170.65	-65.32	-63.83	-0.21	-1.27	-13.00	-52.32
191.67	-67.96	-70.02	3.50	-1.43	-13.00	-54.96
335.55	-66.39	-68.78	4.28	-1.90	-13.00	-53.39
342.02	-66.64	-69.08	4.36	-1.92	-13.00	-53.64
7000.02	-48.33	-50.18	11.50	-9.65	-13.00	-35.33
10500.03	-42.77	-43.05	11.20	-10.92	-13.00	-29.77

Unless otherwise stated the results shown in this test report refer only to the sample(s) tested and such sample(s) are retained for 90 days only.

除非另有說明，此報告結果僅對測試之樣品負責，同時此樣品僅保留90天。本報告未經本公司書面許可，不可部份複製。  
 This document is issued by the Company subject to its General Conditions of Service printed overleaf, available on request or accessible at <http://www.sgs.com.tw/Terms-and-Conditions> and for electronic format documents, subject to Terms and Conditions for Electronic Documents at <http://www.sgs.com.tw/Terms-and-Conditions>. Attention is drawn to the limitation of liability, indemnification and jurisdiction issues defined therein. Any holder of this document is advised that information contained hereon reflects the Company's findings at the time of its intervention only and within the limits of Client's instructions, if any. The Company's sole responsibility is to its Client and this document does not exonerate parties to a transaction from exercising all their rights and obligations under the transaction documents. This document cannot be reproduced except in full, without prior written approval of the Company. Any unauthorized alteration, forgery or falsification of the content or appearance of this document is unlawful and offenders may be prosecuted to the fullest extent of the law.

Report Number :ER/2021/C0138  
 Operation Mode :n77  
 Test Mode :Tx CH High  
 EUT Pol :H Plane  
 Test Frequency :3534.99 MHz

Test Site :SAC 1  
 Test Date :2022-01-26  
 Temp./Humi. :23.8/68  
 Antenna Pol. :Vertical  
 Engineer :GN Lin

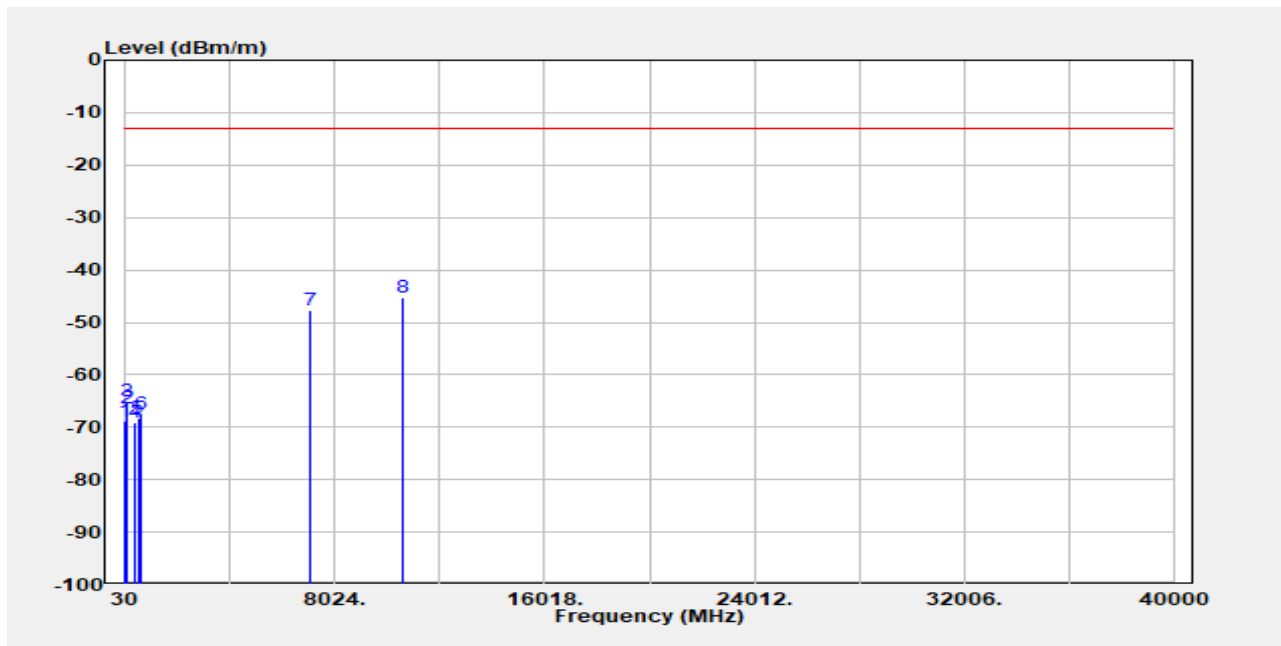

Freq. MHz	EIRP/ERP dBm	SG Output Level dBm	Antenna Gain dBi/dBd	Cable Loss dB	Limit dBm	Margin dB
36.47	-68.87	-54.55	-13.67	-0.64	-13.00	-55.87
78.50	-66.42	-62.01	-3.52	-0.89	-13.00	-53.42
99.52	-65.09	-63.36	-0.72	-1.01	-13.00	-52.09
348.48	-69.16	-71.67	4.52	-2.01	-13.00	-56.16
500.45	-68.42	-70.26	4.25	-2.41	-13.00	-55.42
610.38	-67.49	-68.47	3.48	-2.50	-13.00	-54.49
7069.98	-47.61	-49.00	11.18	-9.79	-13.00	-34.61
10604.97	-45.35	-45.17	11.30	-11.48	-13.00	-32.35

Unless otherwise stated the results shown in this test report refer only to the sample(s) tested and such sample(s) are retained for 90 days only.

除非另有說明，此報告結果僅對測試之樣品負責，同時此樣品僅保留90天。本報告未經本公司書面許可，不可部份複製。  
 This document is issued by the Company subject to its General Conditions of Service printed overleaf, available on request or accessible at <http://www.sgs.com.tw/Terms-and-Conditions> and for electronic format documents, subject to Terms and Conditions for Electronic Documents at <http://www.sgs.com.tw/Terms-and-Conditions>. Attention is drawn to the limitation of liability, indemnification and jurisdiction issues defined therein. Any holder of this document is advised that information contained hereon reflects the Company's findings at the time of its intervention only and within the limits of Client's instructions, if any. The Company's sole responsibility is to its Client and this document does not exonerate parties to a transaction from exercising all their rights and obligations under the transaction documents. This document cannot be reproduced except in full, without prior written approval of the Company. Any unauthorized alteration, forgery or falsification of the content or appearance of this document is unlawful and offenders may be prosecuted to the fullest extent of the law.

Report Number :ER/2021/C0138  
 Operation Mode :n77  
 Test Mode :Tx CH High  
 EUT Pol :H Plane  
 Test Frequency :3534.99 MHz

Test Site :SAC 1  
 Test Date :2022-01-26  
 Temp./Humi. :23.8/68  
 Antenna Pol. :Horizontal  
 Engineer :GN Lin

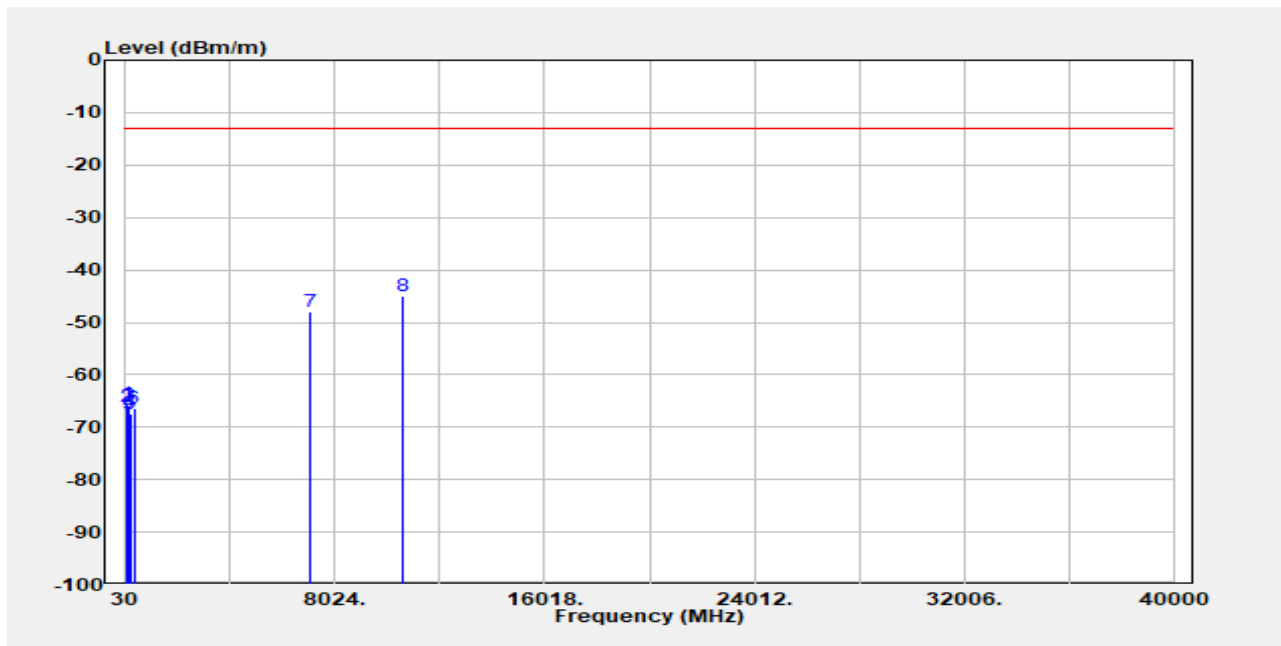

Freq. MHz	EIRP/ERP dBm	SG Output Level dBm	Antenna Gain dBi/dBd	Cable Loss dB	Limit dBm	Margin dB
78.50	-65.71	-61.30	-3.52	-0.89	-13.00	-52.71
89.82	-66.24	-64.83	-0.43	-0.98	-13.00	-53.24
156.10	-65.85	-63.28	-1.36	-1.21	-13.00	-52.85
170.65	-67.30	-65.82	-0.21	-1.27	-13.00	-54.30
191.67	-67.41	-69.47	3.50	-1.43	-13.00	-54.41
345.25	-66.36	-68.84	4.44	-1.97	-13.00	-53.36
7069.98	-47.87	-49.26	11.18	-9.79	-13.00	-34.87
10604.97	-44.88	-44.70	11.30	-11.48	-13.00	-31.88

Unless otherwise stated the results shown in this test report refer only to the sample(s) tested and such sample(s) are retained for 90 days only.

除非另有說明，此報告結果僅對測試之樣品負責，同時此樣品僅保留90天。本報告未經本公司書面許可，不可部份複製。

This document is issued by the Company subject to its General Conditions of Service printed overleaf, available on request or accessible at <http://www.sgs.com.tw/Terms-and-Conditions> and for electronic format documents, subject to Terms and Conditions for Electronic Documents at <http://www.sgs.com.tw/Terms-and-Conditions>. Attention is drawn to the limitation of liability, indemnification and jurisdiction issues defined therein. Any holder of this document is advised that information contained hereon reflects the Company's findings at the time of its intervention only and within the limits of Client's instructions, if any. The Company's sole responsibility is to its Client and this document does not exonerate parties to a transaction from exercising all their rights and obligations under the transaction documents. This document cannot be reproduced except in full, without prior written approval of the Company. Any unauthorized alteration, forgery or falsification of the content or appearance of this document is unlawful and offenders may be prosecuted to the fullest extent of the law.

Report Number :ER/2021/C0138  
 Operation Mode :n77  
 Test Mode :Tx CH Low  
 EUT Pol :H Plane  
 Test Frequency :3735 MHz

Test Site :SAC 1  
 Test Date :2022-01-26  
 Temp./Humi. :23.8/68  
 Antenna Pol. :Vertical  
 Engineer :GN Lin

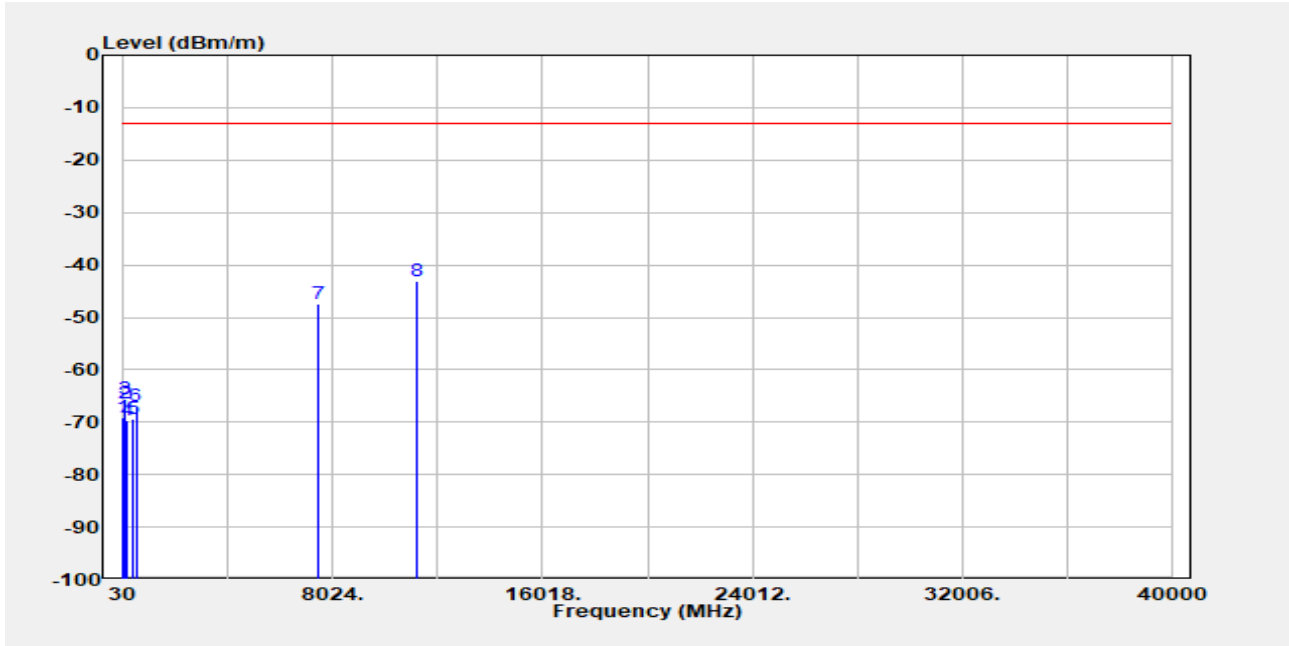

Freq. MHz	EIRP/ERP dBm	SG Output Level dBm	Antenna Gain dBi/dBd	Cable Loss dB	Limit dBm	Margin dB
36.47	-68.99	-54.67	-13.67	-0.64	-13.00	-55.99
78.50	-66.44	-62.03	-3.52	-0.89	-13.00	-53.44
99.52	-65.46	-63.73	-0.72	-1.01	-13.00	-52.46
156.10	-69.60	-67.03	-1.36	-1.21	-13.00	-56.60
348.48	-69.27	-71.78	4.52	-2.01	-13.00	-56.27
500.45	-66.81	-68.65	4.25	-2.41	-13.00	-53.81
7470.00	-47.29	-49.11	10.94	-9.12	-13.00	-34.29
11205.00	-43.12	-42.51	11.60	-12.21	-13.00	-30.12

Unless otherwise stated the results shown in this test report refer only to the sample(s) tested and such sample(s) are retained for 90 days only.

除非另有說明，此報告結果僅對測試之樣品負責，同時此樣品僅保留90天。本報告未經本公司書面許可，不可部份複製。

This document is issued by the Company subject to its General Conditions of Service printed overleaf, available on request or accessible at <http://www.sgs.com.tw/Terms-and-Conditions> and for electronic format documents, subject to Terms and Conditions for Electronic Documents at <http://www.sgs.com.tw/Terms-and-Conditions>. Attention is drawn to the limitation of liability, indemnification and jurisdiction issues defined therein. Any holder of this document is advised that information contained hereon reflects the Company's findings at the time of its intervention only and within the limits of Client's instructions, if any. The Company's sole responsibility is to its Client and this document does not exonerate parties to a transaction from exercising all their rights and obligations under the transaction documents. This document cannot be reproduced except in full, without prior written approval of the Company. Any unauthorized alteration, forgery or falsification of the content or appearance of this document is unlawful and offenders may be prosecuted to the fullest extent of the law.



Report Number :ER/2021/C0138  
 Operation Mode :n77  
 Test Mode :Tx CH Low  
 EUT Pol :H Plane  
 Test Frequency :3735 MHz

Test Site :SAC 1  
 Test Date :2022-01-26  
 Temp./Humi. :23.8/68  
 Antenna Pol. :Horizontal  
 Engineer :GN Lin

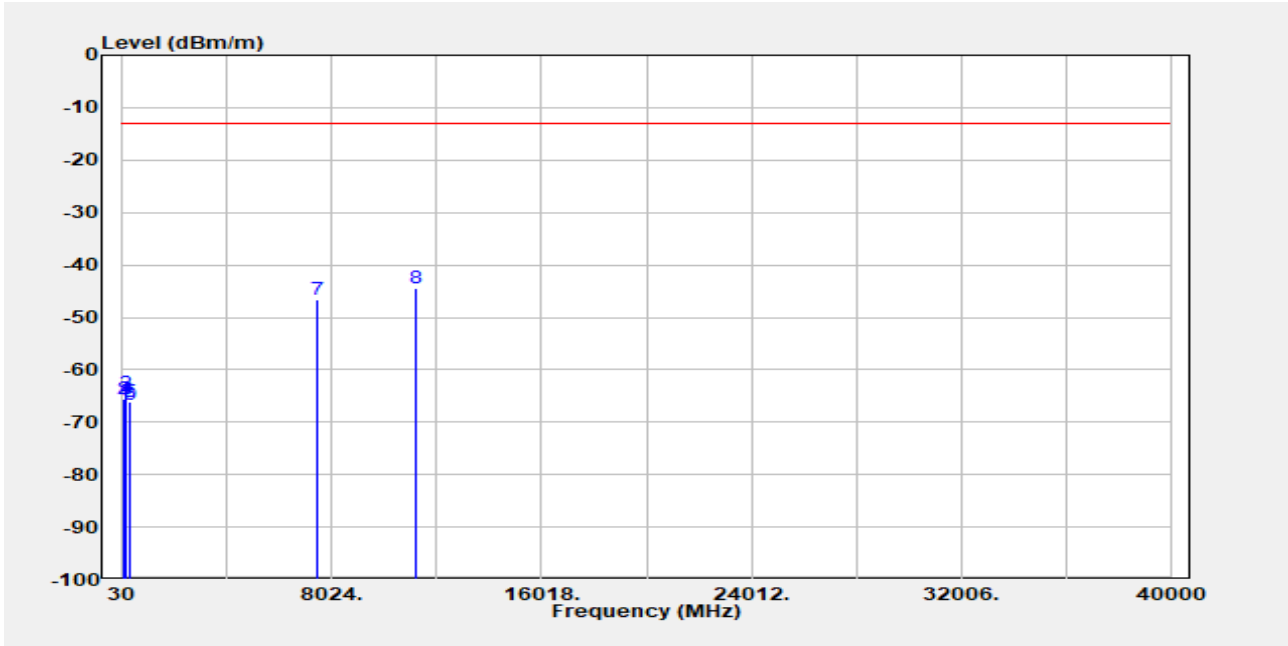

Freq. MHz	EIRP/ERP dBm	SG Output Level dBm	Antenna Gain dBi/dBd	Cable Loss dB	Limit dBm	Margin dB
78.50	-65.92	-61.51	-3.52	-0.89	-13.00	-52.92
89.82	-65.65	-64.24	-0.43	-0.98	-13.00	-52.65
156.10	-64.40	-61.83	-1.36	-1.21	-13.00	-51.40
170.65	-65.64	-64.16	-0.21	-1.27	-13.00	-52.64
335.55	-66.24	-68.62	4.28	-1.90	-13.00	-53.24
342.02	-66.58	-69.02	4.36	-1.92	-13.00	-53.58
7470.00	-46.60	-48.42	10.94	-9.12	-13.00	-33.60
11205.00	-44.56	-43.95	11.60	-12.21	-13.00	-31.56

Unless otherwise stated the results shown in this test report refer only to the sample(s) tested and such sample(s) are retained for 90 days only.

除非另有說明，此報告結果僅對測試之樣品負責，同時此樣品僅保留90天。本報告未經本公司書面許可，不可部份複製。

This document is issued by the Company subject to its General Conditions of Service printed overleaf, available on request or accessible at <http://www.sgs.com.tw/Terms-and-Conditions> and for electronic format documents, subject to Terms and Conditions for Electronic Documents at <http://www.sgs.com.tw/Terms-and-Conditions>. Attention is drawn to the limitation of liability, indemnification and jurisdiction issues defined therein. Any holder of this document is advised that information contained hereon reflects the Company's findings at the time of its intervention only and within the limits of Client's instructions, if any. The Company's sole responsibility is to its Client and this document does not exonerate parties to a transaction from exercising all their rights and obligations under the transaction documents. This document cannot be reproduced except in full, without prior written approval of the Company. Any unauthorized alteration, forgery or falsification of the content or appearance of this document is unlawful and offenders may be prosecuted to the fullest extent of the law.

Report Number :ER/2021/C0138  
 Operation Mode :n77  
 Test Mode :Tx CH Mid  
 EUT Pol :H Plane  
 Test Frequency :3840 MHz

Test Site :SAC 1  
 Test Date :2022-01-26  
 Temp./Humi. :23.8/68  
 Antenna Pol. :Vertical  
 Engineer :GN Lin

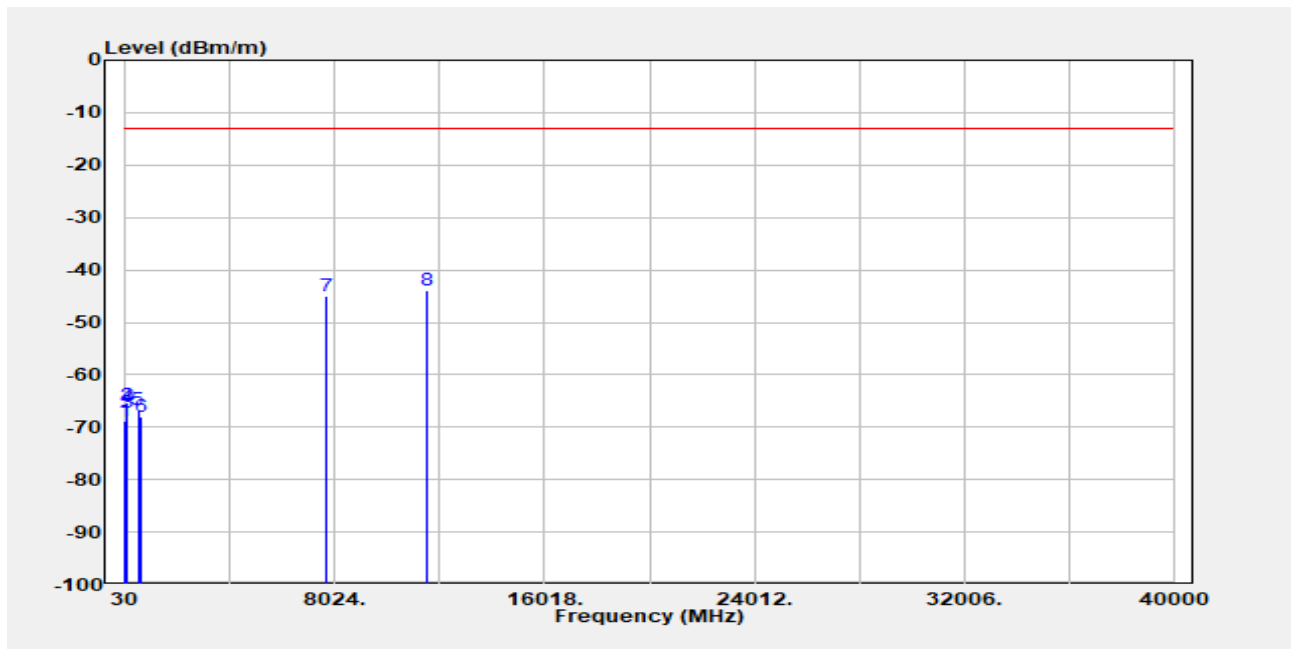

Freq. MHz	EIRP/ERP dBm	SG Output Level dBm	Antenna Gain dBi/dBd	Cable Loss dB	Limit dBm	Margin dB
36.47	-68.84	-54.52	-13.67	-0.64	-13.00	-55.84
78.50	-65.83	-61.42	-3.52	-0.89	-13.00	-52.83
89.82	-67.28	-65.87	-0.43	-0.98	-13.00	-54.28
99.52	-66.25	-64.52	-0.72	-1.01	-13.00	-53.25
500.45	-66.60	-68.44	4.25	-2.41	-13.00	-53.60
610.38	-67.95	-68.93	3.48	-2.50	-13.00	-54.95
7680.00	-45.08	-46.62	11.42	-9.88	-13.00	-32.08
11520.00	-44.02	-43.03	11.36	-12.35	-13.00	-31.02

Unless otherwise stated the results shown in this test report refer only to the sample(s) tested and such sample(s) are retained for 90 days only.

除非另有說明，此報告結果僅對測試之樣品負責，同時此樣品僅保留90天。本報告未經本公司書面許可，不可部份複製。

This document is issued by the Company subject to its General Conditions of Service printed overleaf, available on request or accessible at <http://www.sgs.com.tw/Terms-and-Conditions> and for electronic format documents, subject to Terms and Conditions for Electronic Documents at <http://www.sgs.com.tw/Terms-and-Conditions>. Attention is drawn to the limitation of liability, indemnification and jurisdiction issues defined therein. Any holder of this document is advised that information contained hereon reflects the Company's findings at the time of its intervention only and within the limits of Client's instructions, if any. The Company's sole responsibility is to its Client and this document does not exonerate parties to a transaction from exercising all their rights and obligations under the transaction documents. This document cannot be reproduced except in full, without prior written approval of the Company. Any unauthorized alteration, forgery or falsification of the content or appearance of this document is unlawful and offenders may be prosecuted to the fullest extent of the law.

Report Number :ER/2021/C0138  
 Operation Mode :n77  
 Test Mode :Tx CH Mid  
 EUT Pol :H Plane  
 Test Frequency :3840 MHz

Test Site :SAC 1  
 Test Date :2022-01-26  
 Temp./Humi. :23.8/68  
 Antenna Pol. :Horizontal  
 Engineer :GN Lin

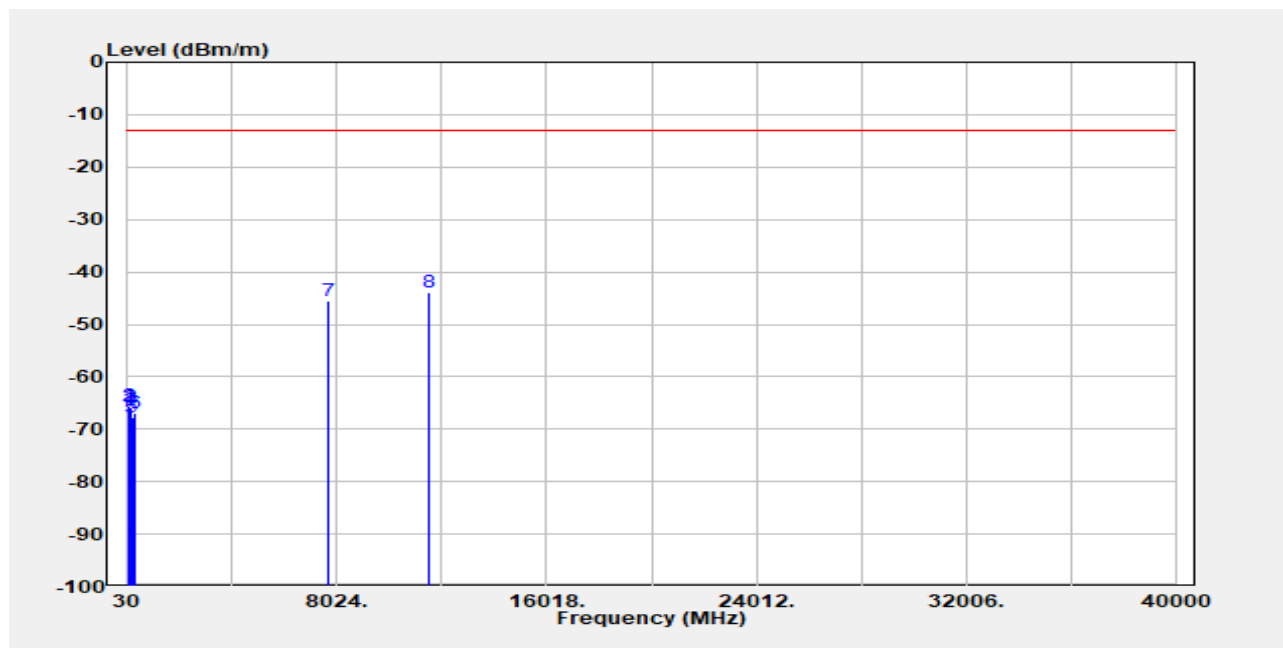

Freq. MHz	EIRP/ERP dBm	SG Output Level dBm	Antenna Gain dBi/dBd	Cable Loss dB	Limit dBm	Margin dB
78.50	-66.12	-61.71	-3.52	-0.89	-13.00	-53.12
89.82	-65.57	-64.16	-0.43	-0.98	-13.00	-52.57
156.10	-65.91	-63.34	-1.36	-1.21	-13.00	-52.91
170.65	-66.48	-64.99	-0.21	-1.27	-13.00	-53.48
191.67	-67.64	-69.70	3.50	-1.43	-13.00	-54.64
335.55	-66.92	-69.30	4.28	-1.90	-13.00	-53.92
7680.00	-45.61	-47.15	11.42	-9.88	-13.00	-32.61
11520.00	-43.85	-42.85	11.36	-12.35	-13.00	-30.85

Unless otherwise stated the results shown in this test report refer only to the sample(s) tested and such sample(s) are retained for 90 days only.

除非另有說明，此報告結果僅對測試之樣品負責，同時此樣品僅保留90天。本報告未經本公司書面許可，不可部份複製。

This document is issued by the Company subject to its General Conditions of Service printed overleaf, available on request or accessible at <http://www.sgs.com.tw/Terms-and-Conditions> and for electronic format documents, subject to Terms and Conditions for Electronic Documents at <http://www.sgs.com.tw/Terms-and-Conditions>. Attention is drawn to the limitation of liability, indemnification and jurisdiction issues defined therein. Any holder of this document is advised that information contained hereon reflects the Company's findings at the time of its intervention only and within the limits of Client's instructions, if any. The Company's sole responsibility is to its Client and this document does not exonerate parties to a transaction from exercising all their rights and obligations under the transaction documents. This document cannot be reproduced except in full, without prior written approval of the Company. Any unauthorized alteration, forgery or falsification of the content or appearance of this document is unlawful and offenders may be prosecuted to the fullest extent of the law.

Report Number :ER/2021/C0138  
 Operation Mode :n77  
 Test Mode :Tx CH High  
 EUT Pol :H Plane  
 Test Frequency :3945 MHz

Test Site :SAC 1  
 Test Date :2022-01-26  
 Temp./Humi. :23.8/68  
 Antenna Pol. :Vertical  
 Engineer :GN Lin

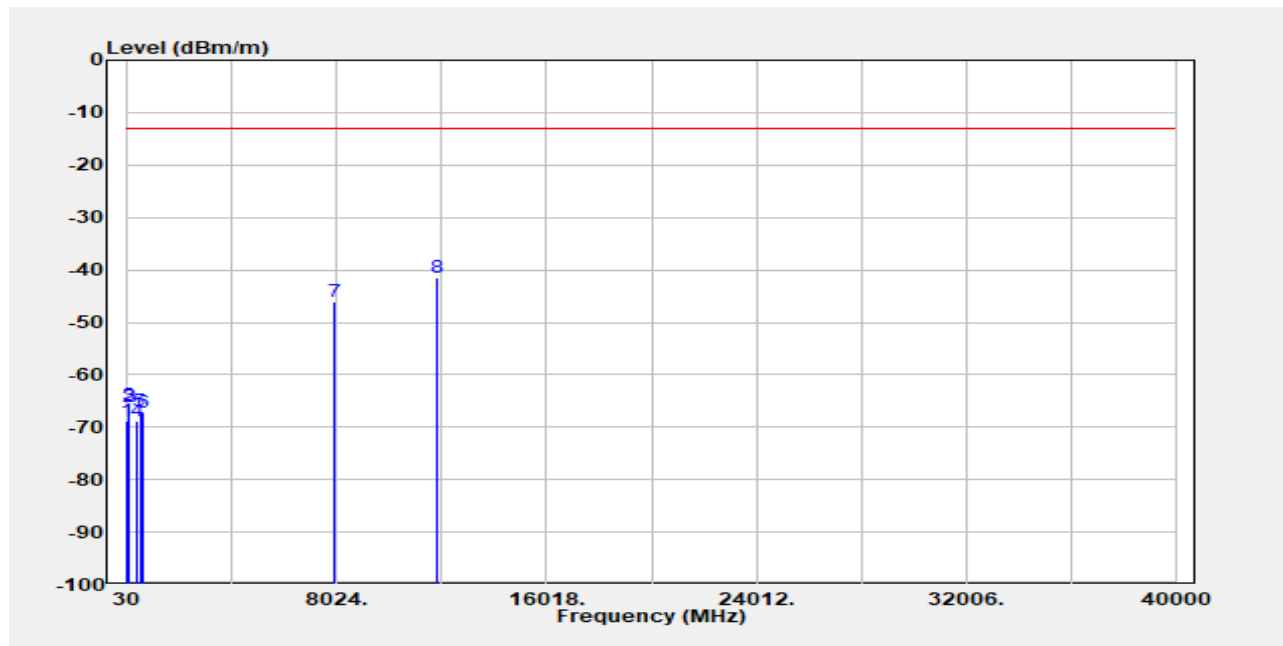

Freq. MHz	EIRP/ERP dBm	SG Output Level dBm	Antenna Gain dBi/dBd	Cable Loss dB	Limit dBm	Margin dB
36.47	-68.88	-54.57	-13.67	-0.64	-13.00	-55.88
78.50	-66.14	-61.73	-3.52	-0.89	-13.00	-53.14
99.52	-65.82	-64.09	-0.72	-1.01	-13.00	-52.82
348.48	-68.89	-71.40	4.52	-2.01	-13.00	-55.89
500.45	-66.94	-68.78	4.25	-2.41	-13.00	-53.94
610.38	-67.07	-68.06	3.48	-2.50	-13.00	-54.07
7890.00	-46.05	-46.64	11.22	-10.63	-13.00	-33.05
11835.00	-41.43	-41.72	12.61	-12.32	-13.00	-28.43

Unless otherwise stated the results shown in this test report refer only to the sample(s) tested and such sample(s) are retained for 90 days only.

除非另有說明，此報告結果僅對測試之樣品負責，同時此樣品僅保留90天。本報告未經本公司書面許可，不可部份複製。

This document is issued by the Company subject to its General Conditions of Service printed overleaf, available on request or accessible at <http://www.sgs.com.tw/Terms-and-Conditions> and for electronic format documents, subject to Terms and Conditions for Electronic Documents at <http://www.sgs.com.tw/Terms-and-Conditions>. Attention is drawn to the limitation of liability, indemnification and jurisdiction issues defined therein. Any holder of this document is advised that information contained hereon reflects the Company's findings at the time of its intervention only and within the limits of Client's instructions, if any. The Company's sole responsibility is to its Client and this document does not exonerate parties to a transaction from exercising all their rights and obligations under the transaction documents. This document cannot be reproduced except in full, without prior written approval of the Company. Any unauthorized alteration, forgery or falsification of the content or appearance of this document is unlawful and offenders may be prosecuted to the fullest extent of the law.

Report Number :ER/2021/C0138  
 Operation Mode :n77  
 Test Mode :Tx CH High  
 EUT Pol :H Plane  
 Test Frequency :3945 MHz

Test Site :SAC 1  
 Test Date :2022-01-26  
 Temp./Humi. :23.8/68  
 Antenna Pol. :Horizontal  
 Engineer :GN Lin

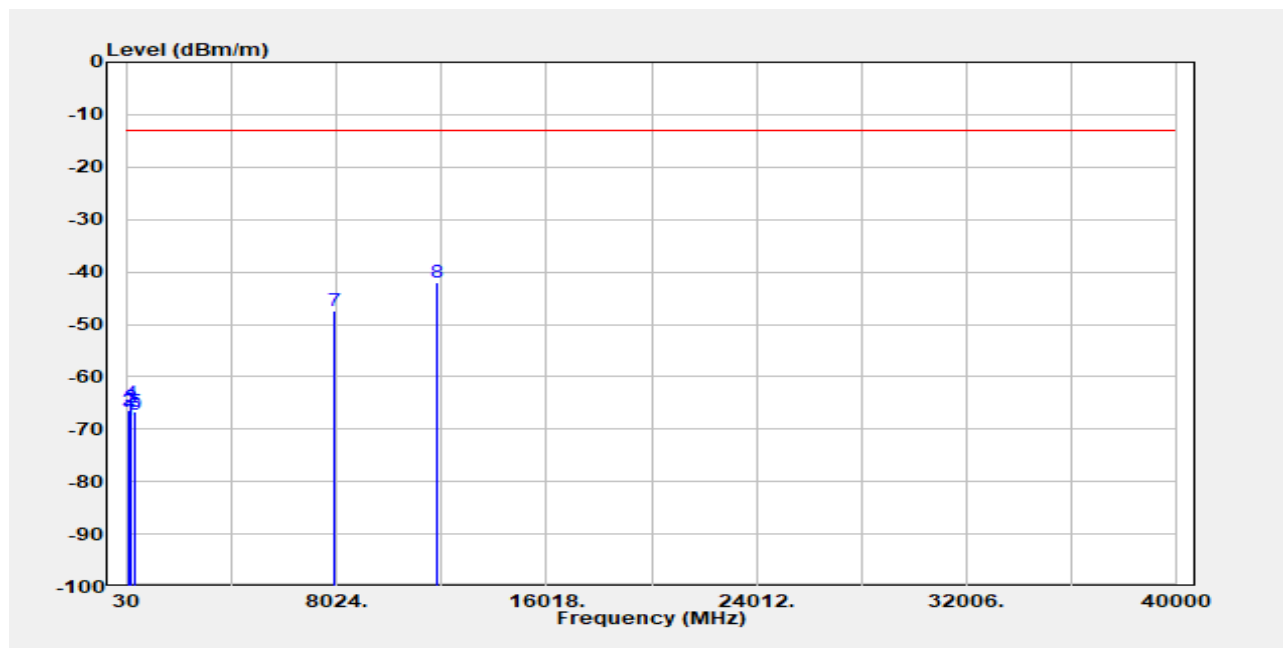

Freq. MHz	EIRP/ERP dBm	SG Output Level dBm	Antenna Gain dBi/dBd	Cable Loss dB	Limit dBm	Margin dB
78.50	-68.37	-63.96	-3.52	-0.89	-13.00	-55.37
89.82	-66.49	-65.08	-0.43	-0.98	-13.00	-53.49
156.10	-65.75	-63.19	-1.36	-1.21	-13.00	-52.75
170.65	-65.05	-63.57	-0.21	-1.27	-13.00	-52.05
335.55	-66.56	-68.94	4.28	-1.90	-13.00	-53.56
342.02	-67.24	-69.69	4.36	-1.92	-13.00	-54.24
7890.00	-47.40	-47.99	11.22	-10.63	-13.00	-34.40
11835.00	-42.04	-42.32	12.61	-12.32	-13.00	-29.04

Unless otherwise stated the results shown in this test report refer only to the sample(s) tested and such sample(s) are retained for 90 days only.

除非另有說明，此報告結果僅對測試之樣品負責，同時此樣品僅保留90天。本報告未經本公司書面許可，不可部份複製。

This document is issued by the Company subject to its General Conditions of Service printed overleaf, available on request or accessible at <http://www.sgs.com.tw/Terms-and-Conditions> and for electronic format documents, subject to Terms and Conditions for Electronic Documents at <http://www.sgs.com.tw/Terms-and-Conditions>. Attention is drawn to the limitation of liability, indemnification and jurisdiction issues defined therein. Any holder of this document is advised that information contained hereon reflects the Company's findings at the time of its intervention only and within the limits of Client's instructions, if any. The Company's sole responsibility is to its Client and this document does not exonerate parties to a transaction from exercising all their rights and obligations under the transaction documents. This document cannot be reproduced except in full, without prior written approval of the Company. Any unauthorized alteration, forgery or falsification of the content or appearance of this document is unlawful and offenders may be prosecuted to the fullest extent of the law.

## 11 FREQUENCY STABILITY MEASUREMENT

### 11.1 Standard Applicabl

The frequency stability shall be sufficient to ensure that the fundamental emission stays within the authorized frequency block.

### 11.2 Test Set-up

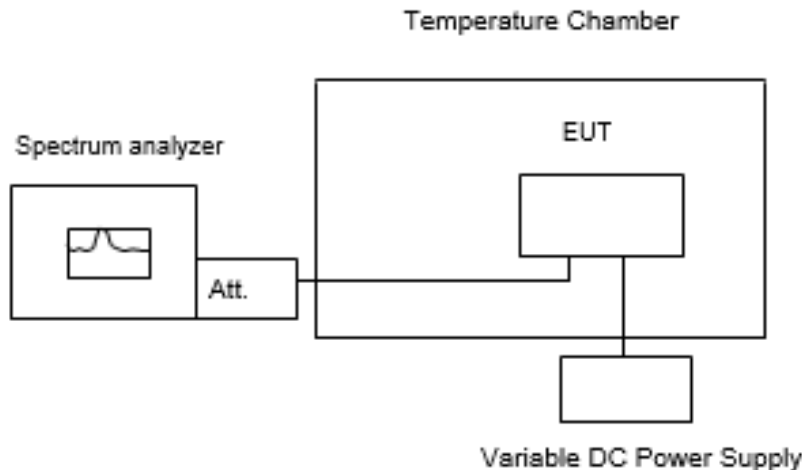

**Note:** Measurement setup for testing on Antenna connector

### 11.3 Measurement Procedure

The equipment under test was connected to an external AC or DC power supply and input rated voltage. RF output was connected to a frequency counter or spectrum analyzer via feed through attenuators. The EUT was placed inside the temperature chamber. Set the spectrum analyzer RBW low enough to obtain the desired frequency resolution and measure EUT 25°C operating frequency as reference frequency. Turn EUT off and set the chamber temperature to -30°C. After the temperature stabilized for approximately 30 minutes recorded the frequency. Repeat step measure with 10°C increased per stage until the highest temperature of +50°C reached.

Set chamber temperature to 25°C. Use a variable AC power supply / DC power source to power the EUT and set the voltage to rated voltage. Set the spectrum analyzer RBW low enough to obtain the desired frequency resolution and recorded the frequency. Reduce the input voltage to specify extreme voltage variation (+/- 15%) and endpoint as declared by the manufacturer, record the maximum frequency change.

Unless otherwise stated the results shown in this test report refer only to the sample(s) tested and such sample(s) are retained for 90 days only.

除非另有說明，此報告結果僅對測試之樣品負責，同時此樣品僅保留90天。本報告未經本公司書面許可，不可部份複製。

This document is issued by the Company subject to its General Conditions of Service printed overleaf, available on request or accessible at <http://www.sgs.com.tw/Terms-and-Conditions> and for electronic format documents, subject to Terms and Conditions for Electronic Documents at <http://www.sgs.com.tw/Terms-and-Conditions>. Attention is drawn to the limitation of liability, indemnification and jurisdiction issues defined therein. Any holder of this document is advised that information contained hereon reflects the Company's findings at the time of its intervention only and within the limits of Client's instructions, if any. The Company's sole responsibility is to its Client and this document does not exonerate parties to a transaction from exercising all their rights and obligations under the transaction documents. This document cannot be reproduced except in full, without prior written approval of the Company. Any unauthorized alteration, forgery or falsification of the content or appearance of this document is unlawful and offenders may be prosecuted to the fullest extent of the law.

### 11.4 Measurement Result

**Note:** The battery is rated 12.5V dc.

5G NR BAND n77/ Part27				
Reference Freq.:		Modulation.:		CP-OFDM QPSK
SCS.:	30 kHz	Bandwidth:		100MHz
CH	656000	Frequency(MHz):		3840.00
Freq. ERROR vs. VOLTAGE				
Power Supply Vdc	Temp. (°C)	Freq. (MHz)	Delta (Hz)	Limit = +/- 2.5 ppm (Hz)
14.375	25	3839.999996	-4	9600
12.5	25	3839.999993	-7	9600
10.625	25	3840.000009	9	9600
0 (End Point)	25	3840.000005	5	9600
Freq. ERROR vs. Temp.				
Power Supply Vdc	Temp. (°C)	Freq. (MHz)	Delta (Hz)	Limit = +/- 2.5 ppm (Hz)
12.5	-30	3839.999996	-4	9600
12.5	-20	3839.999995	-5	9600
12.5	-10	3840.000003	3	9600
12.5	0	3840.000011	11	9600
12.5	10	3840.000009	9	9600
12.5	20	3840.000010	10	9600
12.5	30	3839.999995	-5	9600
12.5	40	3840.000006	6	9600
12.5	50	3839.999999	-1	9600

Unless otherwise stated the results shown in this test report refer only to the sample(s) tested and such sample(s) are retained for 90 days only.

除非另有說明，此報告結果僅對測試之樣品負責，同時此樣品僅保留90天。本報告未經本公司書面許可，不可部份複製。

This document is issued by the Company subject to its General Conditions of Service printed overleaf, available on request or accessible at <http://www.sgs.com.tw/Terms-and-Conditions> and for electronic format documents, subject to Terms and Conditions for Electronic Documents at <http://www.sgs.com.tw/Terms-and-Conditions>. Attention is drawn to the limitation of liability, indemnification and jurisdiction issues defined therein. Any holder of this document is advised that information contained hereon reflects the Company's findings at the time of its intervention only and within the limits of Client's instructions, if any. The Company's sole responsibility is to its Client and this document does not exonerate parties to a transaction from exercising all their rights and obligations under the transaction documents. This document cannot be reproduced except in full, without prior written approval of the Company. Any unauthorized alteration, forgery or falsification of the content or appearance of this document is unlawful and offenders may be prosecuted to the fullest extent of the law.

5G NR BAND n77/ Part27				
Reference Freq.:		Modulation.:		CP-OFDM QPSK
SCS.:	30	kHz	Bandwidth:	100MHz
CH	633334		Frequency(MHz):	3500.01
Freq. ERROR vs. VOLTAGE				
Power Supply Vdc	Temp. (°C)	Freq. (MHz)	Delta (Hz)	Limit = +/- 2.5 ppm (Hz)
14.375	25	3500.009996	-4	8750
12.5	25	3500.009993	-7	8750
10.625	25	3500.010009	9	8750
0 (End Point)	25	3500.010005	5	8750
Freq. ERROR vs. Temp.				
Power Supply Vdc	Temp. (°C)	Freq. (MHz)	Delta (Hz)	Limit = +/- 2.5 ppm (Hz)
12.5	-30	3500.009996	-4	8750
12.5	-20	3500.009995	-5	8750
12.5	-10	3500.010003	3	8750
12.5	0	3500.010011	11	8750
12.5	10	3500.010009	9	8750
12.5	20	3500.010010	10	8750
12.5	30	3500.009995	-5	8750
12.5	40	3500.010006	6	8750
12.5	50	3500.009999	-1	8750

Unless otherwise stated the results shown in this test report refer only to the sample(s) tested and such sample(s) are retained for 90 days only.

除非另有說明，此報告結果僅對測試之樣品負責，同時此樣品僅保留90天。本報告未經本公司書面許可，不可部份複製。

This document is issued by the Company subject to its General Conditions of Service printed overleaf, available on request or accessible at <http://www.sgs.com.tw/Terms-and-Conditions> and for electronic format documents, subject to Terms and Conditions for Electronic Documents at <http://www.sgs.com.tw/Terms-and-Conditions>. Attention is drawn to the limitation of liability, indemnification and jurisdiction issues defined therein. Any holder of this document is advised that information contained hereon reflects the Company's findings at the time of its intervention only and within the limits of Client's instructions, if any. The Company's sole responsibility is to its Client and this document does not exonerate parties to a transaction from exercising all their rights and obligations under the transaction documents. This document cannot be reproduced except in full, without prior written approval of the Company. Any unauthorized alteration, forgery or falsification of the content or appearance of this document is unlawful and offenders may be prosecuted to the fullest extent of the law.



## 12 PEAK TO AVERAGE RATIO

### 12.1 Standard Applicable

The peak-to-average ratio (PAR) of the transmission may not exceed 13dB.

### 12.2 Test SET-UP

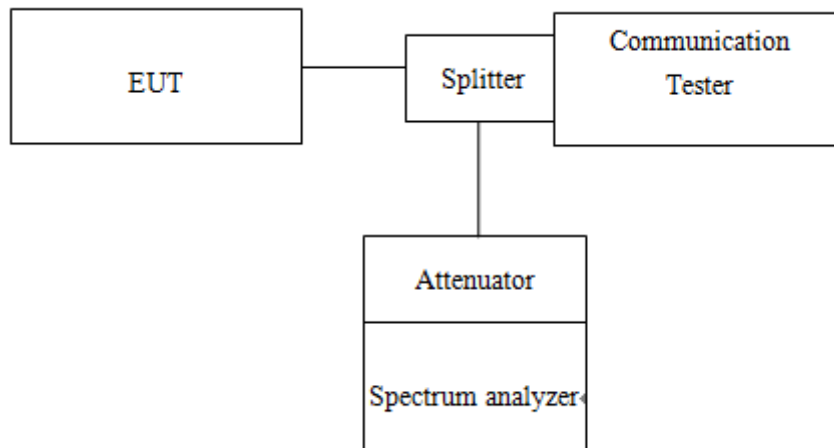

### 12.3 Measurement Procedure

1. KDB 971168 D01 is employed as the following procedure is proper adjusted accordingly:
2. The spectrum set follow:
  - a) Set the analyzer center frequency to the OBW center frequency.
  - b) Set the span to  $2 \times$  to  $3 \times$  the OBW.
  - c) Set the RBW to the specified reference bandwidth
  - d) Set the VBW  $\geq 3 \times$  RBW.
  - e) Detector = peak.
  - f) Sweep time  $\geq 10 \times$  (number of points in sweep)  $\times$  (transmission symbol period).
  - g) Trace mode = max hold.
  - h) Allow trace to fully stabilize.
  - i) Use the peak marker function to determine the maximum amplitude level within the specified reference bandwidth (PSD).

Unless otherwise stated the results shown in this test report refer only to the sample(s) tested and such sample(s) are retained for 90 days only.

除非另有說明，此報告結果僅對測試之樣品負責，同時此樣品僅保留90天。本報告未經本公司書面許可，不可部份複製。

This document is issued by the Company subject to its General Conditions of Service printed overleaf, available on request or accessible at <http://www.sgs.com.tw/Terms-and-Conditions> and for electronic format documents, subject to Terms and Conditions for Electronic Documents at <http://www.sgs.com.tw/Terms-and-Conditions>. Attention is drawn to the limitation of liability, indemnification and jurisdiction issues defined therein. Any holder of this document is advised that information contained hereon reflects the Company's findings at the time of its intervention only and within the limits of Client's instructions, if any. The Company's sole responsibility is to its Client and this document does not exonerate parties to a transaction from exercising all their rights and obligations under the transaction documents. This document cannot be reproduced except in full, without prior written approval of the Company. Any unauthorized alteration, forgery or falsification of the content or appearance of this document is unlawful and offenders may be prosecuted to the fullest extent of the law.

### 12.4 Measurement Result

5G NR BAND n77 Part27(3700 to 3980 MHz)							
DFT-S-OFDM_SCS 30 kHz							
Channel bandwidth: 20MHz							
Freq. (MHz)	CH	PAPR (dB)					
		256QAM	Limit				
3710.01	647334	9.52	13				
3840.00	656000	11.52	13				
3969.99	664666	10.45	13				

5G NR BAND n77 Part27(3700 to 3980 MHz)							
DFT-S-OFDM_SCS 30 kHz							
Channel bandwidth: 30MHz				Channel bandwidth: 40MHz			
Freq. (MHz)	CH	PAPR (dB)		Freq. (MHz)	CH	PAPR (dB)	
		256QAM	Limit			256QAM	Limit
3715.02	647668	11.71	13	3720.00	648000	10.54	13
3840.00	656000	10.17	13	3840.00	656000	10.91	13
3765.00	651000	10.33	13	3960.00	664000	10.71	13

5G NR BAND n77 Part27(3700 to 3980 MHz)							
DFT-S-OFDM_SCS 30 kHz							
Channel bandwidth: 50MHz				Channel bandwidth: 60MHz			
Freq. (MHz)	CH	PAPR (dB)		Freq. (MHz)	CH	PAPR (dB)	
		256QAM	Limit			256QAM	Limit
3725.01	648334	11.84	13	3730.02	648668	10.39	13
3840.00	656000	10.46	13	3840.00	656000	10.87	13
3954.99	663666	11.76	13	3949.98	663332	11.03	13

5G NR BAND n77 Part27(3700 to 3980 MHz)							
DFT-S-OFDM_SCS 30 kHz							
Channel bandwidth: 70MHz				Channel bandwidth: 80MHz			
Freq. (MHz)	CH	PAPR (dB)		Freq. (MHz)	CH	PAPR (dB)	
		256QAM	Limit			256QAM	Limit
3735.00	649000	10.46	13	3740.01	649334	11.18	13
3840.00	656000	11.41	13	3840.00	656000	11.01	13
3945.00	663000	10.97	13	3939.99	662666	12.66	13

5G NR BAND n77 Part27(3700 to 3980 MHz)							
DFT-S-OFDM_SCS 30 kHz							
Channel bandwidth: 90MHz				Channel bandwidth: 100MHz			
Freq. (MHz)	CH	PAPR (dB)		Freq. (MHz)	CH	PAPR (dB)	
		256QAM	Limit			256QAM	Limit
3745.02	649668	10.96	13	3750.00	650000	11.37	13
3840.00	656000	10.62	13	3840.00	656000	10.53	13
3934.98	662332	10.36	13	3930.00	662000	11.71	13

5G NR BAND n77 Part27(3450 to 3550 MHz)							
DFT-S-OFDM_SCS 30 kHz							
Channel bandwidth: 20MHz							
Freq. (MHz)	CH	PAPR (dB)					
		256QAM	Limit				
3460.02	630668	10.18	13				
3500.01	633334	9.77	13				
3540.00	636000	9.10	13				

5G NR BAND n77 Part27(3450 to 3550 MHz)							
DFT-S-OFDM_SCS 30 kHz							
Channel bandwidth: 30MHz				Channel bandwidth: 40MHz			
Freq. (MHz)	CH	PAPR (dB)		Freq. (MHz)	CH	PAPR (dB)	
		256QAM	Limit			256QAM	Limit
3465.00	631000	10.37	13	3470.01	631334	10.43	13
3500.01	633334	10.54	13	3500.01	633334	10.98	13
3534.99	635666	10.37	13	3529.98	635332	10.43	13

5G NR BAND n77 Part27(3450 to 3550 MHz)							
DFT-S-OFDM_SCS 30 kHz							
Channel bandwidth: 50MHz				Channel bandwidth: 60MHz			
Freq. (MHz)	CH	PAPR (dB)		Freq. (MHz)	CH	PAPR (dB)	
		256QAM	Limit			256QAM	Limit
3475.02	631668	11.84	13	3480.00	632000	10.89	13
3500.01	633334	10.47	13	3500.01	633334	11.77	13
3525.00	635000	11.76	13	3519.99	634666	11.31	13

5G NR BAND n77 Part27(3450 to 3550 MHz)							
DFT-S-OFDM_SCS 30 kHz							
Channel bandwidth: 70MHz				Channel bandwidth: 80MHz			
Freq. (MHz)	CH	PAPR (dB)		Freq. (MHz)	CH	PAPR (dB)	
		256QAM	Limit			256QAM	Limit
3485.01	632334	10.67	13	3490.02	632668	11.32	13
3500.01	633334	11.50	13	3500.01	633334	11.55	13
3514.98	634332	12.11	13	3510.00	634000	11.53	13

5G NR BAND n77 Part27(3450 to 3550 MHz)							
DFT-S-OFDM_SCS 30 kHz							
Channel bandwidth: 90MHz				Channel bandwidth: 100MHz			
Freq. (MHz)	CH	PAPR (dB)		Freq. (MHz)	CH	PAPR (dB)	
		256QAM	Limit			256QAM	Limit
3495.00	633000	11.66	13				
3500.01	633334	12.28	13	3500.01	633334	10.99	13
3504.99	633666	11.29	13				

Unless otherwise stated the results shown in this test report refer only to the sample(s) tested and such sample(s) are retained for 90 days only.

除非另有說明，此報告結果僅對測試之樣品負責，同時此樣品僅保留90天。本報告未經本公司書面許可，不可部份複製。

This document is issued by the Company subject to its General Conditions of Service printed overleaf, available on request or accessible at <http://www.sgs.com.tw/Terms-and-Conditions> and for electronic format documents, subject to Terms and Conditions for Electronic Documents at <http://www.sgs.com.tw/Terms-and-Conditions>. Attention is drawn to the limitation of liability, indemnification and jurisdiction issues defined therein. Any holder of this document is advised that information contained herein reflects the Company's findings at the time of its intervention only and within the limits of Client's instructions, if any. The Company's sole responsibility is to its Client and this document does not exonerate parties to a transaction from exercising all their rights and obligations under the transaction documents. This document cannot be reproduced except in full, without prior written approval of the Company. Any unauthorized alteration, forgery or falsification of the content or appearance of this document is unlawful and offenders may be prosecuted to the fullest extent of the law.

Band77-Part27\_20MHz\_DFT\_s\_OFDM\_SCS30kHz\_256QAM\_RB50\_0\_CH630668



Band77-Part27\_30MHz\_DFT\_s\_OFDM\_SCS30kHz\_256QAM\_RB75\_0\_CH631000

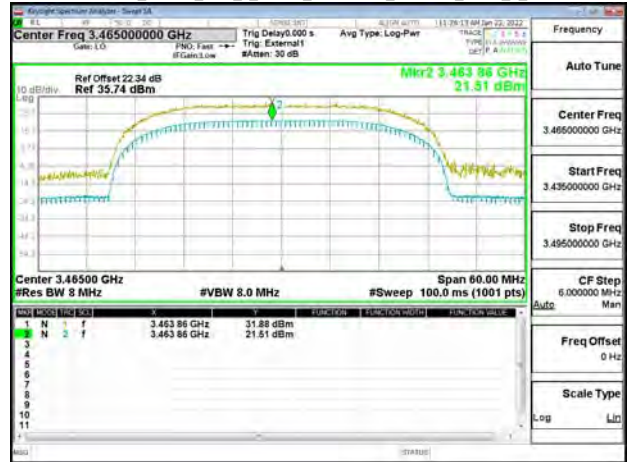

Band77-Part27\_20MHz\_DFT\_s\_OFDM\_SCS30kHz\_256QAM\_RB50\_0\_CH633334



Band77-Part27\_30MHz\_DFT\_s\_OFDM\_SCS30kHz\_256QAM\_RB75\_0\_CH633334



Band77-Part27\_20MHz\_DFT\_s\_OFDM\_SCS30kHz\_256QAM\_RB50\_0\_CH636000



Band77-Part27\_30MHz\_DFT\_s\_OFDM\_SCS30kHz\_256QAM\_RB75\_0\_CH635666



Unless otherwise stated the results shown in this test report refer only to the sample(s) tested and such sample(s) are retained for 90 days only.

除非另有說明，此報告結果僅對測試之樣品負責，同時此樣品僅保留90天。本報告未經本公司書面許可，不可部份複製。

This document is issued by the Company subject to its General Conditions of Service printed overleaf, available on request or accessible at <http://www.sgs.com.tw/Terms-and-Conditions> and for electronic format documents, subject to Terms and Conditions for Electronic Documents at <http://www.sgs.com.tw/Terms-and-Conditions>. Attention is drawn to the limitation of liability, indemnification and jurisdiction issues defined therein. Any holder of this document is advised that information contained herein reflects the Company's findings at the time of its intervention only and within the limits of Client's instructions, if any. The Company's sole responsibility is to its Client and this document does not exonerate parties to a transaction from exercising all their rights and obligations under the transaction documents. This document cannot be reproduced except in full, without prior written approval of the Company. Any unauthorized alteration, forgery or falsification of the content or appearance of this document is unlawful and offenders may be prosecuted to the fullest extent of the law.

Band77-Part27\_40MHz\_DFT\_s\_OFDM\_SCS30kHz\_256QAM\_RB100\_0\_CH631334



Band77-Part27\_50MHz\_DFT\_s\_OFDM\_SCS30kHz\_256QAM\_RB128\_0\_CH631668



Band77-Part27\_40MHz\_DFT\_s\_OFDM\_SCS30kHz\_256QAM\_RB100\_0\_CH633334



Band77-Part27\_50MHz\_DFT\_s\_OFDM\_SCS30kHz\_256QAM\_RB128\_0\_CH633334



Band77-Part27\_40MHz\_DFT\_s\_OFDM\_SCS30kHz\_256QAM\_RB100\_0\_CH635332



Band77-Part27\_50MHz\_DFT\_s\_OFDM\_SCS30kHz\_256QAM\_RB128\_0\_CH635000



Unless otherwise stated the results shown in this test report refer only to the sample(s) tested and such sample(s) are retained for 90 days only.

除非另有說明，此報告結果僅對測試之樣品負責，同時此樣品僅保留90天。本報告未經本公司書面許可，不可部份複製。

This document is issued by the Company subject to its General Conditions of Service printed overleaf, available on request or accessible at <http://www.sgs.com.tw/Terms-and-Conditions> and for electronic format documents, subject to Terms and Conditions for Electronic Documents at <http://www.sgs.com.tw/Terms-and-Conditions>. Attention is drawn to the limitation of liability, indemnification and jurisdiction issues defined therein. Any holder of this document is advised that information contained herein reflects the Company's findings at the time of its intervention only and within the limits of Client's instructions, if any. The Company's sole responsibility is to its Client and this document does not exonerate parties to a transaction from exercising all their rights and obligations under the transaction documents. This document cannot be reproduced except in full, without prior written approval of the Company. Any unauthorized alteration, forgery or falsification of the content or appearance of this document is unlawful and offenders may be prosecuted to the fullest extent of the law.

Band77-Part27\_60MHz\_DFT\_s\_OFDM\_SCS30kHz\_256QAM\_RB162\_0\_CH632000



Band77-Part27\_70MHz\_DFT\_s\_OFDM\_SCS30kHz\_256QAM\_RB180\_0\_CH632334

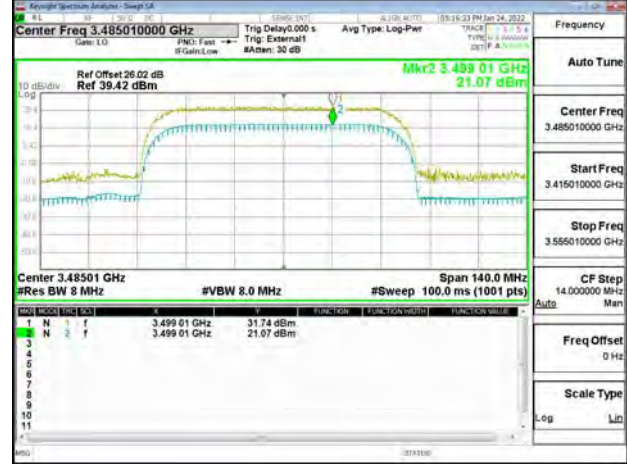

Band77-Part27\_60MHz\_DFT\_s\_OFDM\_SCS30kHz\_256QAM\_RB162\_0\_CH633334



Band77-Part27\_70MHz\_DFT\_s\_OFDM\_SCS30kHz\_256QAM\_RB180\_0\_CH633334

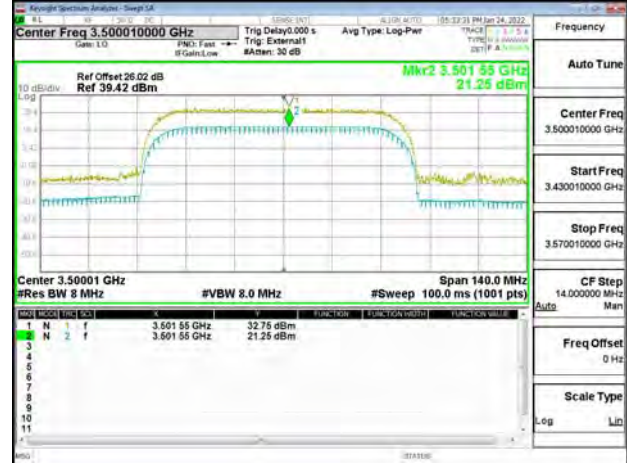

Band77-Part27\_60MHz\_DFT\_s\_OFDM\_SCS30kHz\_256QAM\_RB162\_0\_CH634666

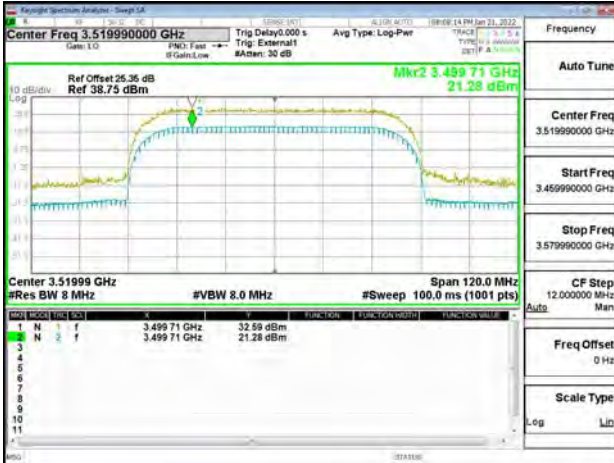

Band77-Part27\_70MHz\_DFT\_s\_OFDM\_SCS30kHz\_256QAM\_RB180\_0\_CH634332



Unless otherwise stated the results shown in this test report refer only to the sample(s) tested and such sample(s) are retained for 90 days only.

除非另有說明，此報告結果僅對測試之樣品負責，同時此樣品僅保留90天。本報告未經本公司書面許可，不可部份複製。

This document is issued by the Company subject to its General Conditions of Service printed overleaf, available on request or accessible at <http://www.sgs.com.tw/Terms-and-Conditions> and for electronic format documents, subject to Terms and Conditions for Electronic Documents at <http://www.sgs.com.tw/Terms-and-Conditions>. Attention is drawn to the limitation of liability, indemnification and jurisdiction issues defined therein. Any holder of this document is advised that information contained herein reflects the Company's findings at the time of its intervention only and within the limits of Client's instructions, if any. The Company's sole responsibility is to its Client and this document does not exonerate parties to a transaction from exercising all their rights and obligations under the transaction documents. This document cannot be reproduced except in full, without prior written approval of the Company. Any unauthorized alteration, forgery or falsification of the content or appearance of this document is unlawful and offenders may be prosecuted to the fullest extent of the law.

Band77-Part27\_80MHz\_DFT\_s\_OFDM\_SCS30kHz\_256QAM\_RB216\_0\_CH632668



Band77-Part27\_90MHz\_DFT\_s\_OFDM\_SCS30kHz\_256QAM\_RB243\_0\_CH633000



Band77-Part27\_80MHz\_DFT\_s\_OFDM\_SCS30kHz\_256QAM\_RB216\_0\_CH633334

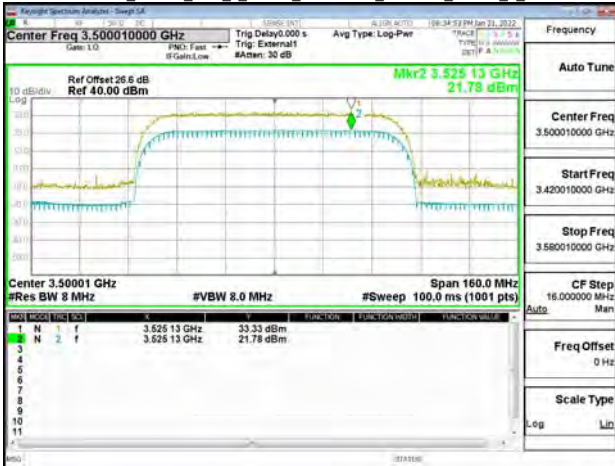

Band77-Part27\_90MHz\_DFT\_s\_OFDM\_SCS30kHz\_256QAM\_RB243\_0\_CH633334



Band77-Part27\_80MHz\_DFT\_s\_OFDM\_SCS30kHz\_256QAM\_RB216\_0\_CH634000



Band77-Part27\_90MHz\_DFT\_s\_OFDM\_SCS30kHz\_256QAM\_RB243\_0\_CH633666



Unless otherwise stated the results shown in this test report refer only to the sample(s) tested and such sample(s) are retained for 90 days only.

除非另有說明，此報告結果僅對測試之樣品負責，同時此樣品僅保留90天。本報告未經本公司書面許可，不可部份複製。

This document is issued by the Company subject to its General Conditions of Service printed overleaf, available on request or accessible at <http://www.sgs.com.tw/Terms-and-Conditions> and for electronic format documents, subject to Terms and Conditions for Electronic Documents at <http://www.sgs.com.tw/Terms-and-Conditions>. Attention is drawn to the limitation of liability, indemnification and jurisdiction issues defined therein. Any holder of this document is advised that information contained herein reflects the Company's findings at the time of its intervention only and within the limits of Client's instructions, if any. The Company's sole responsibility is to its Client and this document does not exonerate parties to a transaction from exercising all their rights and obligations under the transaction documents. This document cannot be reproduced except in full, without prior written approval of the Company. Any unauthorized alteration, forgery or falsification of the content or appearance of this document is unlawful and offenders may be prosecuted to the fullest extent of the law.

Band77-Part27\_100MHz\_DFT\_s\_OFDM\_SCS30kHz\_256QAM\_RB270\_0\_CH633334



Band77-Part27\_20MHz\_DFT\_s\_OFDM\_SCS30kHz\_256QAM\_RB50\_0\_CH646666

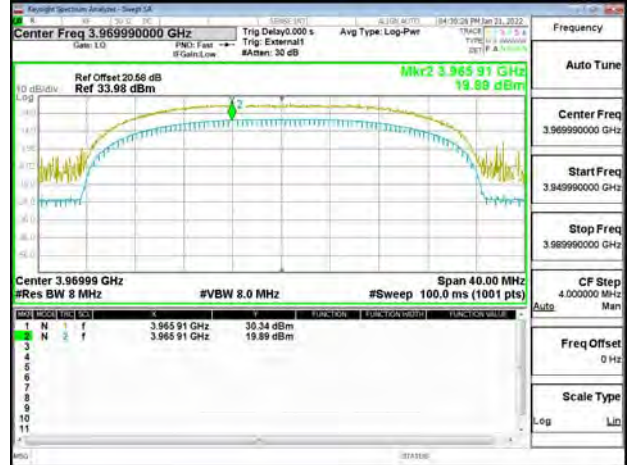

Band77-Part27\_20MHz\_DFT\_s\_OFDM\_SCS30kHz\_256QAM\_RB50\_0\_CH647334



Band77-Part27\_30MHz\_DFT\_s\_OFDM\_SCS30kHz\_256QAM\_RB75\_0\_CH647668



Band77-Part27\_20MHz\_DFT\_s\_OFDM\_SCS30kHz\_256QAM\_RB50\_0\_CH656000

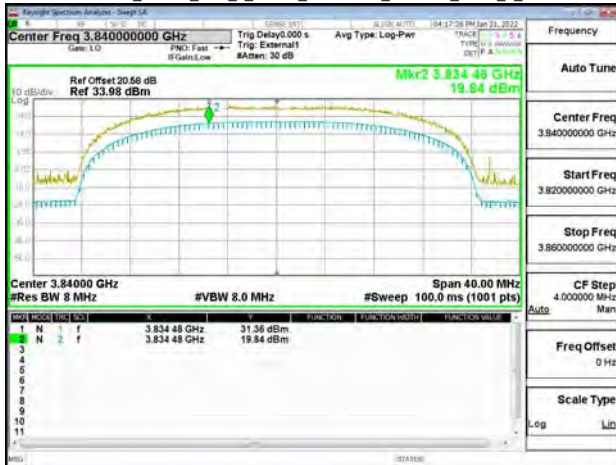

Band77-Part27\_30MHz\_DFT\_s\_OFDM\_SCS30kHz\_256QAM\_RB75\_0\_CH651000

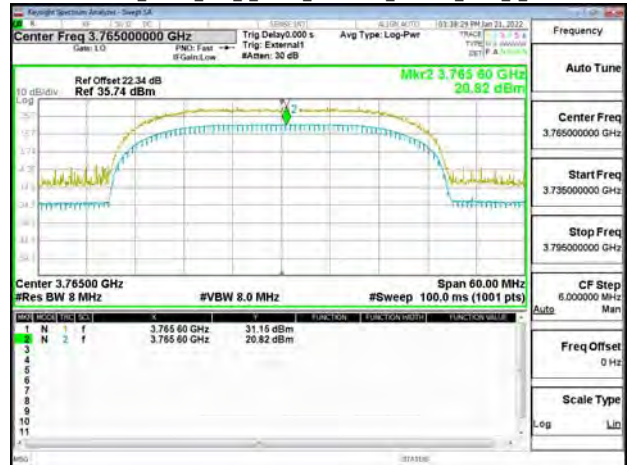

Unless otherwise stated the results shown in this test report refer only to the sample(s) tested and such sample(s) are retained for 90 days only.

除非另有說明，此報告結果僅對測試之樣品負責，同時此樣品僅保留90天。本報告未經本公司書面許可，不可部份複製。此文件是根據本公司之一般條件及服務印出，可供索取或於 <http://www.sgs.com.tw/Terms-and-Conditions> 及電子格式文件，受條款及條件之限制。任何持有此文件者，應被告知其中所載之資訊僅反映本公司之發現，且其效力僅限於其權利及義務之範圍內。本公司之唯一責任是向其客戶，且此文件並不為任何交易之保證。任何未經本公司書面批准之更改、偽造或偽造之內容或外觀，或此文件之內容或外觀之任何更改，均將被視為非法，且將被追究法律責任。

Band77-Part27\_30MHz\_DFT\_s\_OFDM\_SCS30kHz\_256QAM\_RB75\_0\_CH656000



Band77-Part27\_40MHz\_DFT\_s\_OFDM\_SCS30kHz\_256QAM\_RB100\_0\_CH64000

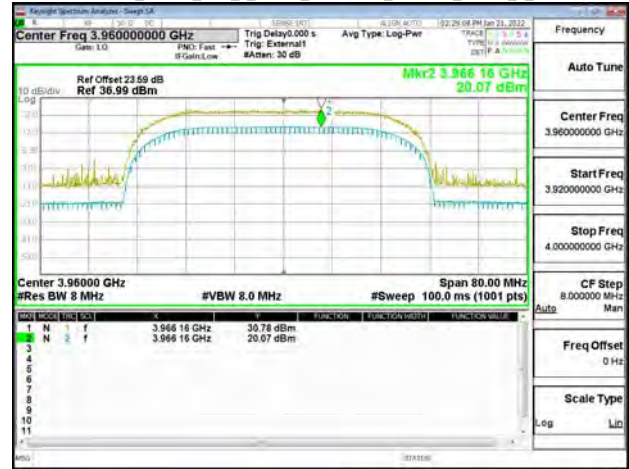

Band77-Part27\_40MHz\_DFT\_s\_OFDM\_SCS30kHz\_256QAM\_RB100\_0\_CH648000



Band77-Part27\_50MHz\_DFT\_s\_OFDM\_SCS30kHz\_256QAM\_RB128\_0\_CH648334



Band77-Part27\_40MHz\_DFT\_s\_OFDM\_SCS30kHz\_256QAM\_RB100\_0\_CH656000

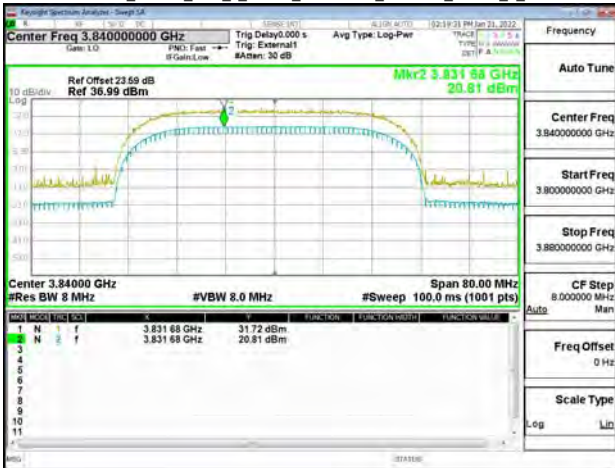

Band77-Part27\_50MHz\_DFT\_s\_OFDM\_SCS30kHz\_256QAM\_RB128\_0\_CH656000



Unless otherwise stated the results shown in this test report refer only to the sample(s) tested and such sample(s) are retained for 90 days only.

除非另有說明，此報告結果僅對測試之樣品負責，同時此樣品僅保留90天。本報告未經本公司書面許可，不可部份複製。

This document is issued by the Company subject to its General Conditions of Service printed overleaf, available on request or accessible at <http://www.sgs.com.tw/Terms-and-Conditions> and for electronic format documents, subject to Terms and Conditions for Electronic Documents at <http://www.sgs.com.tw/Terms-and-Conditions>. Attention is drawn to the limitation of liability, indemnification and jurisdiction issues defined therein. Any holder of this document is advised that information contained herein reflects the Company's findings at the time of its intervention only and within the limits of Client's instructions, if any. The Company's sole responsibility is to its Client and this document does not exonerate parties to a transaction from exercising all their rights and obligations under the transaction documents. This document cannot be reproduced except in full, without prior written approval of the Company. Any unauthorized alteration, forgery or falsification of the content or appearance of this document is unlawful and offenders may be prosecuted to the fullest extent of the law.



Band77-Part27\_50MHz\_DFT\_s\_OFDM\_SCS30kHz\_256QAM\_RB128\_0\_CH663666



Band77-Part27\_60MHz\_DFT\_s\_OFDM\_SCS30kHz\_256QAM\_RB162\_0\_CH663332

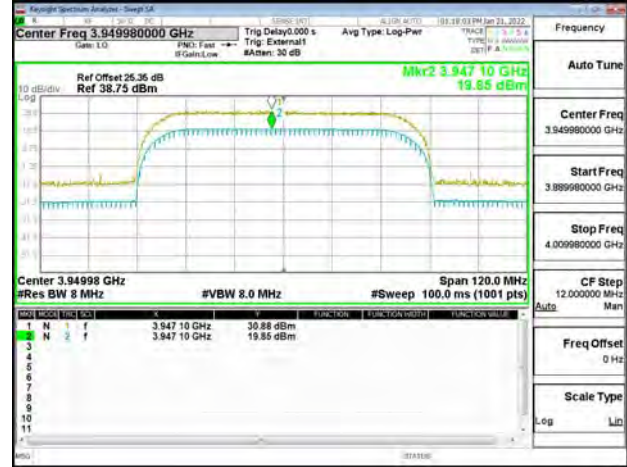

Band77-Part27\_60MHz\_DFT\_s\_OFDM\_SCS30kHz\_256QAM\_RB162\_0\_CH648668



Band77-Part27\_70MHz\_DFT\_s\_OFDM\_SCS30kHz\_256QAM\_RB180\_0\_CH649000



Band77-Part27\_60MHz\_DFT\_s\_OFDM\_SCS30kHz\_256QAM\_RB162\_0\_CH656000

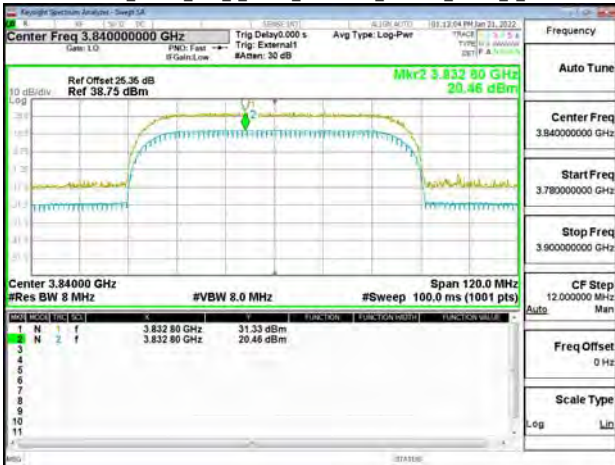

Band77-Part27\_70MHz\_DFT\_s\_OFDM\_SCS30kHz\_256QAM\_RB180\_0\_CH656000

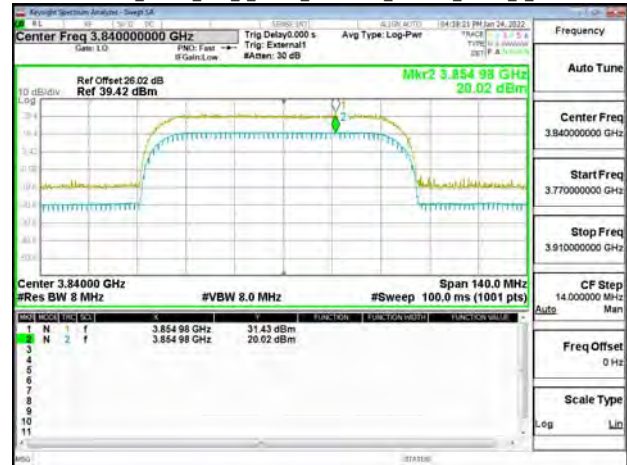

Unless otherwise stated the results shown in this test report refer only to the sample(s) tested and such sample(s) are retained for 90 days only.

除非另有說明，此報告結果僅對測試之樣品負責，同時此樣品僅保留90天。本報告未經本公司書面許可，不可部份複製。  
This document is issued by the Company subject to its General Conditions of Service printed overleaf, available on request or accessible at <http://www.sgs.com.tw/Terms-and-Conditions> and for electronic format documents, subject to Terms and Conditions for Electronic Documents at <http://www.sgs.com.tw/Terms-and-Conditions>. Attention is drawn to the limitation of liability, indemnification and jurisdiction issues defined therein. Any holder of this document is advised that information contained herein reflects the Company's findings at the time of its intervention only and within the limits of Client's instructions, if any. The Company's sole responsibility is to its Client and this document does not exonerate parties to a transaction from exercising all their rights and obligations under the transaction documents. This document cannot be reproduced except in full, without prior written approval of the Company. Any unauthorized alteration, forgery or falsification of the content or appearance of this document is unlawful and offenders may be prosecuted to the fullest extent of the law.

Band77-Part27\_70MHz\_DFT\_s\_OFDM\_SCS30kHz\_256QAM\_RB180\_0\_CH663000



Band77-Part27\_80MHz\_DFT\_s\_OFDM\_SCS30kHz\_256QAM\_RB216\_0\_CH662666

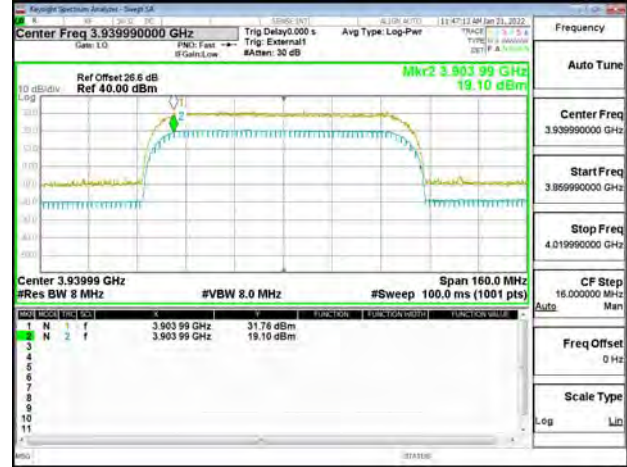

Band77-Part27\_80MHz\_DFT\_s\_OFDM\_SCS30kHz\_256QAM\_RB216\_0\_CH649334



Band77-Part27\_90MHz\_DFT\_s\_OFDM\_SCS30kHz\_256QAM\_RB243\_0\_CH649668



Band77-Part27\_80MHz\_DFT\_s\_OFDM\_SCS30kHz\_256QAM\_RB216\_0\_CH656000



Band77-Part27\_90MHz\_DFT\_s\_OFDM\_SCS30kHz\_256QAM\_RB243\_0\_CH656000



Unless otherwise stated the results shown in this test report refer only to the sample(s) tested and such sample(s) are retained for 90 days only.

除非另有說明，此報告結果僅對測試之樣品負責，同時此樣品僅保留90天。本報告未經本公司書面許可，不可部份複製。

This document is issued by the Company subject to its General Conditions of Service printed overleaf, available on request or accessible at <http://www.sgs.com.tw/Terms-and-Conditions> and for electronic format documents, subject to Terms and Conditions for Electronic Documents at <http://www.sgs.com.tw/Terms-and-Conditions>. Attention is drawn to the limitation of liability, indemnification and jurisdiction issues defined therein. Any holder of this document is advised that information contained herein reflects the Company's findings at the time of its intervention only and within the limits of Client's instructions, if any. The Company's sole responsibility is to its Client and this document does not exonerate parties to a transaction from exercising all their rights and obligations under the transaction documents. This document cannot be reproduced except in full, without prior written approval of the Company. Any unauthorized alteration, forgery or falsification of the content or appearance of this document is unlawful and offenders may be prosecuted to the fullest extent of the law.

Band77-Part27\_90MHz\_DFT\_s\_OFDM\_SCS30kHz\_256QAM\_RB243\_0\_CH662332



Band77-Part27\_100MHz\_DFT\_s\_OFDM\_SCS30kHz\_256QAM\_RB270\_0\_CH656000



Band77-Part27\_100MHz\_DFT\_s\_OFDM\_SCS30kHz\_256QAM\_RB270\_0\_CH650000

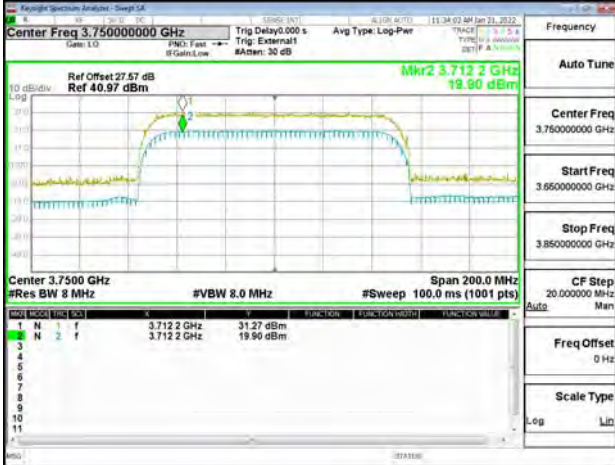

Band77-Part27\_100MHz\_DFT\_s\_OFDM\_SCS30kHz\_256QAM\_RB270\_0\_CH662000



~ End of Report ~

Unless otherwise stated the results shown in this test report refer only to the sample(s) tested and such sample(s) are retained for 90 days only.

除非另有說明，此報告結果僅對測試之樣品負責，同時此樣品僅保留90天。本報告未經本公司書面許可，不可部份複製。  
This document is issued by the Company subject to its General Conditions of Service printed overleaf, available on request or accessible at <http://www.sgs.com.tw/Terms-and-Conditions> and for electronic format documents, subject to Terms and Conditions for Electronic Documents at <http://www.sgs.com.tw/Terms-and-Conditions>. Attention is drawn to the limitation of liability, indemnification and jurisdiction issues defined therein. Any holder of this document is advised that information contained hereon reflects the Company's findings at the time of its intervention only and within the limits of Client's instructions, if any. The Company's sole responsibility is to its Client and this document does not exonerate parties to a transaction from exercising all their rights and obligations under the transaction documents. This document cannot be reproduced except in full, without prior written approval of the Company. Any unauthorized alteration, forgery or falsification of the content or appearance of this document is unlawful and offenders may be prosecuted to the fullest extent of the law.