

# ELECTROMAGNETIC EMISSIONS COMPLIANCE REPORT



**Applicant:** LG Electronics Inc.  
10, Magokjungang 10-ro, Gangseo-gu, Seoul, Korea

**Product Name:** Module

**Brand Name:** LG Electronics Inc.

**Model No.:** TM05NNNABM0

**Model Difference:** N/A

**Report Number:** ER/2021/C0138

**FCC ID** BEJTM05NNNABM0

**Issue Date:** March 24, 2022

**Date of Test:** January 19, 2022 ~ January 26, 2022

**Date of EUT Received:** December 27, 2021

Jet Lu

Approved By \_\_\_\_\_

Jet Lu

## We hereby certify that:

The above equipment was tested by SGS Taiwan Ltd. Central RF Lab The test data, data evaluation, test procedures, and equipment configurations shown in this report were made in accordance with the procedures given in ANSI C63.26-2015 and the energy emitted by the sample EUT comply with FCC rule part §2 and §27 subpart O.

The results of this report relate only to the sample identified in this report.

Unless otherwise stated the results shown in this test report refer only to the sample(s) tested and such sample(s) are retained for 90 days only.

除非另有說明，此報告結果僅對測試之樣品負責，同時此樣品僅保留90天。本報告未經本公司書面許可，不可部份複製。

This document is issued by the Company subject to its General Conditions of Service printed overleaf, available on request or accessible at <http://www.sgs.com.tw/Terms-and-Conditions> and for electronic format documents, subject to Terms and Conditions for Electronic Documents at <http://www.sgs.com.tw/Terms-and-Conditions>. Attention is drawn to the limitation of liability, indemnification and jurisdiction issues defined therein. Any holder of this document is advised that information contained hereon reflects the Company's findings at the time of its intervention only and within the limits of Client's instructions, if any. The Company's sole responsibility is to its Client and this document does not exonerate parties to a transaction from exercising all their rights and obligations under the transaction documents. This document cannot be reproduced except in full, without prior written approval of the Company. Any unauthorized alteration, forgery or falsification of the content or appearance of this document is unlawful and offenders may be prosecuted to the fullest extent of the law.

Revision History					
Report Number	Revision	Description	Issue Date	Revised By	Remark
ER/2021/C0138	00	Original	February 17, 2022	Yuri Tsai	
ER/2021/C0138	01	update general information on page 6~7	March 24, 2022	Yuri Tsai	*

**Note:**

- 1、The remark "\*" indicates modification of the report upon requests from certification body.

Unless otherwise stated the results shown in this test report refer only to the sample(s) tested and such sample(s) are retained for 90 days only.

除非另有說明，此報告結果僅對測試之樣品負責，同時此樣品僅保留90天。本報告未經本公司書面許可，不可部份複製。  
 This document is issued by the Company subject to its General Conditions of Service printed overleaf, available on request or accessible at <http://www.sgs.com.tw/Terms-and-Conditions> and for electronic format documents, subject to Terms and Conditions for Electronic Documents at <http://www.sgs.com.tw/Terms-and-Conditions>. Attention is drawn to the limitation of liability, indemnification and jurisdiction issues defined therein. Any holder of this document is advised that information contained hereon reflects the Company's findings at the time of its intervention only and within the limits of Client's instructions, if any. The Company's sole responsibility is to its Client and this document does not exonerate parties to a transaction from exercising all their rights and obligations under the transaction documents. This document cannot be reproduced except in full, without prior written approval of the Company. Any unauthorized alteration, forgery or falsification of the content or appearance of this document is unlawful and offenders may be prosecuted to the fullest extent of the law.

## Contents

<b>1</b>	<b>GENERAL PRODUCT INFORMATION.....</b>	<b>4</b>
<b>2</b>	<b>SYSTEM TEST CONFIGURATION.....</b>	<b>11</b>
<b>3</b>	<b>SUMMARY OF TEST RESULTS.....</b>	<b>14</b>
<b>4</b>	<b>DESCRIPTION OF TEST MODES.....</b>	<b>15</b>
<b>5</b>	<b>MEASUREMENT UNCERTAINTY.....</b>	<b>16</b>
<b>6</b>	<b>MEASUREMENT EQUIPMENT USED.....</b>	<b>17</b>
<b>7</b>	<b>MAXMUM OUTPUT POWER.....</b>	<b>19</b>
<b>8</b>	<b>OCCUPIED BANDWIDTH MEASUREMENT.....</b>	<b>31</b>
<b>9</b>	<b>OUT OF BAND EMISSION AT ANTENNA TERMINALS.....</b>	<b>80</b>
<b>10</b>	<b>FIELD STRENGTH OF SPURIOUS RADIATION MEASUREMENT.....</b>	<b>144</b>
<b>11</b>	<b>FREQUENCY STABILITY MEASUREMENT.....</b>	<b>159</b>
<b>12</b>	<b>PEAK TO AVERAGE RATIO.....</b>	<b>162</b>

Unless otherwise stated the results shown in this test report refer only to the sample(s) tested and such sample(s) are retained for 90 days only.

除非另有說明，此報告結果僅對測試之樣品負責，同時此樣品僅保留90天。本報告未經本公司書面許可，不可部份複製。  
 This document is issued by the Company subject to its General Conditions of Service printed overleaf, available on request or accessible at <http://www.sgs.com.tw/Terms-and-Conditions> and for electronic format documents, subject to Terms and Conditions for Electronic Documents at <http://www.sgs.com.tw/Terms-and-Conditions>. Attention is drawn to the limitation of liability, indemnification and jurisdiction issues defined therein. Any holder of this document is advised that information contained hereon reflects the Company's findings at the time of its intervention only and within the limits of Client's instructions, if any. The Company's sole responsibility is to its Client and this document does not exonerate parties to a transaction from exercising all their rights and obligations under the transaction documents. This document cannot be reproduced except in full, without prior written approval of the Company. Any unauthorized alteration, forgery or falsification of the content or appearance of this document is unlawful and offenders may be prosecuted to the fullest extent of the law.

# 1 GENERAL PRODUCT INFORMATION

## 1.1 Product Description

Product Name:	Module
Brand Name:	LG Electronics Inc.
Model No.:	TM05NNNABM0
Model Difference:	N/A
HW Version:	Rev.D2
SW Version:	v004.147.065
EUT Series No.:	1112VICL055155
Power Supply:	12.5V

Unless otherwise stated the results shown in this test report refer only to the sample(s) tested and such sample(s) are retained for 90 days only.

除非另有說明，此報告結果僅對測試之樣品負責，同時此樣品僅保留90天。本報告未經本公司書面許可，不可部份複製。

This document is issued by the Company subject to its General Conditions of Service printed overleaf, available on request or accessible at <http://www.sgs.com.tw/Terms-and-Conditions> and for electronic format documents, subject to Terms and Conditions for Electronic Documents at <http://www.sgs.com.tw/Terms-and-Conditions>. Attention is drawn to the limitation of liability, indemnification and jurisdiction issues defined therein. Any holder of this document is advised that information contained hereon reflects the Company's findings at the time of its intervention only and within the limits of Client's instructions, if any. The Company's sole responsibility is to its Client and this document does not exonerate parties to a transaction from exercising all their rights and obligations under the transaction documents. This document cannot be reproduced except in full, without prior written approval of the Company. Any unauthorized alteration, forgery or falsification of the content or appearance of this document is unlawful and offenders may be prosecuted to the fullest extent of the law.

### 1.2 Operation Frequency Range

NR Band 77 (lower)	
BW (MHz)	Operation Frequency (MHz)
20	3460.0 - 3540.0
30	3465.0 - 3535.0
40	3470.0 - 3530.0
50	3475.0 - 3525.0
60	3480.0 - 3520.0
70	3485.0 - 3515.0
80	3490.0 - 3510.0
90	3495.0 - 3505.0
100	3500.0 - 3500.0

NR Band 77 (upper)	
BW (MHz)	Operation Frequency (MHz)
20	3710.0 - 3970.0
30	3715.0 - 3965.0
40	3720.0 - 3960.0
50	3725.0 - 3955.0
60	3730.0 - 3950.0
70	3735.0 - 3945.0
80	3740.0 - 3940.0
90	3745.0 - 3935.0
100	3750.0 - 3930.0

### 1.3 Antenna Designation

Type	Modulation	Frequency (MHz)	Peak Antenna Gain (dBi)
External	5G NR n77	3400 ~ 3800	3.85

**Note:** Antenna information is provided by the applicant.

Unless otherwise stated the results shown in this test report refer only to the sample(s) tested and such sample(s) are retained for 90 days only.

除非另有說明，此報告結果僅對測試之樣品負責，同時此樣品僅保留90天。本報告未經本公司書面許可，不可部份複製。  
 This document is issued by the Company subject to its General Conditions of Service printed overleaf, available on request or accessible at <http://www.sgs.com.tw/Terms-and-Conditions> and for electronic format documents, subject to Terms and Conditions for Electronic Documents at <http://www.sgs.com.tw/Terms-and-Conditions>. Attention is drawn to the limitation of liability, indemnification and jurisdiction issues defined therein. Any holder of this document is advised that information contained hereon reflects the Company's findings at the time of its intervention only and within the limits of Client's instructions, if any. The Company's sole responsibility is to its Client and this document does not exonerate parties to a transaction from exercising all their rights and obligations under the transaction documents. This document cannot be reproduced except in full, without prior written approval of the Company. Any unauthorized alteration, forgery or falsification of the content or appearance of this document is unlawful and offenders may be prosecuted to the fullest extent of the law.

### 1.4 Type of Emission & Max ERP/EIRP Power Measurement Result:

5G NR Band n77_Part27_Uplink frequency band : 3700 to 3980 MHz									
Bandwidth (MHz)	Low Frequency (MHz)	Upper Frequency (MHz)	Modulation	Conducted Average (dBm)	ERP Average (dBm)	ERP Average (W)	99% BW (MHz)	99% BW (kHz)	Type of Emission
20	3710.01	3969.99	DFT-s PI/2 BPSK	25.3	29.15	0.822	17.833	17833.0	17M8G7W
			DFT-s QPSK	25.28	29.13	0.818	17.836	17836.0	17M8G7W
			DFT-s QAM	24.37	28.22	0.664	17.829	17829.0	17M8D7W
			CP QPSK	23.73	27.58	0.573	17.836	17836.0	17M8G7W
			CP QAM	23.29	27.14	0.518	17.829	17829.0	17M8D7W
30	3715.02	3765	DFT-s PI/2 BPSK	25.22	29.07	0.807	26.821	26821.0	26M8G7W
			DFT-s QPSK	25.18	29.03	0.800	26.772	26772.0	26M8G7W
			DFT-s QAM	24.5	28.35	0.684	26.81	26810.0	26M8D7W
			CP QPSK	23.81	27.66	0.583	26.772	26772.0	26M8G7W
			CP QAM	23.12	26.97	0.498	26.81	26810.0	26M8D7W
40	3720	3960	DFT-s PI/2 BPSK	25.23	29.08	0.809	35.783	35783.0	35M8G7W
			DFT-s QPSK	25.16	29.01	0.796	35.824	35824.0	35M8G7W
			DFT-s QAM	24.27	28.12	0.649	35.806	35806.0	35M8D7W
			CP QPSK	23.85	27.7	0.589	35.824	35824.0	35M8G7W
			CP QAM	23.59	27.44	0.555	35.806	35806.0	35M8D7W
50	3725.01	3954.99	DFT-s PI/2 BPSK	25.13	28.98	0.791	45.735	45735.0	45M7G7W
			DFT-s QPSK	25.09	28.94	0.783	45.812	45812.0	45M8G7W
			DFT-s QAM	24.03	27.88	0.614	45.817	45817.0	45M8D7W
			CP QPSK	23.62	27.47	0.558	45.812	45812.0	45M8G7W
			CP QAM	23.2	27.05	0.507	45.817	45817.0	45M8D7W
60	3730.02	3949.98	DFT-s PI/2 BPSK	25.13	28.98	0.791	57.869	57869.0	57M9G7W
			DFT-s QPSK	25.09	28.94	0.783	57.924	57924.0	57M9G7W
			DFT-s QAM	24.12	27.97	0.627	57.937	57937.0	57M9D7W
			CP QPSK	23.65	27.5	0.562	57.924	57924.0	57M9G7W
			CP QAM	23.22	27.07	0.509	57.937	57937.0	57M9D7W
70	3735	3945	DFT-s PI/2 BPSK	25.32	29.17	0.826	64.215	64215.0	64M2G7W
			DFT-s QPSK	25.24	29.09	0.811	64.361	64361.0	64M4G7W
			DFT-s QAM	24.46	28.31	0.678	64.316	64316.0	64M3D7W
			CP QPSK	23.82	27.67	0.585	64.361	64361.0	64M4G7W
			CP QAM	23.4	27.25	0.531	64.316	64316.0	64M3D7W
80	3740.01	3939.99	DFT-s PI/2 BPSK	25.15	29	0.794	77.157	77157.0	77M2G7W
			DFT-s QPSK	25.1	28.95	0.785	77.168	77168.0	77M2G7W
			DFT-s QAM	24.12	27.97	0.627	77.143	77143.0	77M1D7W
			CP QPSK	23.65	27.5	0.562	77.168	77168.0	77M2G7W
			CP QAM	23.29	27.14	0.518	77.143	77143.0	77M1D7W
90	3745.02	3934.98	DFT-s PI/2 BPSK	25.2	29.05	0.804	86.751	86751.0	86M8G7W
			DFT-s QPSK	25.18	29.03	0.800	86.716	86716.0	86M7G7W
			DFT-s QAM	24.2	28.05	0.638	86.765	86765.0	86M8D7W
			CP QPSK	23.72	27.57	0.571	86.716	86716.0	86M7G7W
			CP QAM	23.35	27.2	0.525	86.765	86765.0	86M8D7W
100	3750	3930	DFT-s PI/2 BPSK	25.2	29.05	0.804	96.441	96441.0	96M4G7W
			DFT-s QPSK	25.13	28.98	0.791	96.374	96374.0	96M4G7W
			DFT-s QAM	24.21	28.06	0.640	96.495	96495.0	96M5D7W
			CP QPSK	23.56	27.41	0.551	96.374	96374.0	96M4G7W
			CP QAM	23.39	27.24	0.530	96.495	96495.0	96M5D7W

Unless otherwise stated the results shown in this test report refer only to the sample(s) tested and such sample(s) are retained for 90 days only.

除非另有說明，此報告結果僅對測試之樣品負責，同時此樣品僅保留90天。本報告未經本公司書面許可，不可部份複製。

This document is issued by the Company subject to its General Conditions of Service printed overleaf, available on request or accessible at <http://www.sgs.com.tw/Terms-and-Conditions> and for electronic format documents, subject to Terms and Conditions for Electronic Documents at <http://www.sgs.com.tw/Terms-and-Conditions>. Attention is drawn to the limitation of liability, indemnification and jurisdiction issues defined therein. Any holder of this document is advised that information contained hereon reflects the Company's findings at the time of its intervention only and within the limits of Client's instructions, if any. The Company's sole responsibility is to its Client and this document does not exonerate parties to a transaction from exercising all their rights and obligations under the transaction documents. This document cannot be reproduced except in full, without prior written approval of the Company. Any unauthorized alteration, forgery or falsification of the content or appearance of this document is unlawful and offenders may be prosecuted to the fullest extent of the law.

5G NR Band n77_Part27_Uplink frequency band : 3450 to 3550 MHz									
Bandwidth (MHz)	Low Frequency (MHz)	Upper Frequency (MHz)	Modulation	Conducted Average (dBm)	ERP Average (dBm)	ERP Average (W)	99% BW (MHz)	99% BW (kHz)	Type of Emission
20	3460.02	3540	DFT-s PI/2 BPSK	25.64	29.49	0.889	17.871	17871.0	17M9G7W
			DFT-s QPSK	25.62	29.47	0.885	17.887	17887.0	17M9G7W
			DFT-s QAM	24.83	28.68	0.738	17.899	17899.0	17M9D7W
			CP QPSK	24.17	28.02	0.634	17.887	17887.0	17M9G7W
			CP QAM	23.31	27.16	0.520	17.899	17899.0	17M9D7W
30	3465	3534.99	DFT-s PI/2 BPSK	25.69	29.54	0.899	26.859	26859.0	26M9G7W
			DFT-s QPSK	25.66	29.51	0.893	26.777	26777.0	26M8G7W
			DFT-s QAM	24.75	28.6	0.724	26.803	26803.0	26M8D7W
			CP QPSK	24.35	28.2	0.661	26.777	26777.0	26M8G7W
			CP QAM	23.83	27.68	0.586	26.803	26803.0	26M8D7W
40	3470.01	3529.98	DFT-s PI/2 BPSK	25.69	29.54	0.899	35.723	35723.0	35M7G7W
			DFT-s QPSK	25.65	29.5	0.891	35.735	35735.0	35M7G7W
			DFT-s QAM	24.68	28.53	0.713	35.747	35747.0	35M7D7W
			CP QPSK	24.25	28.1	0.646	35.735	35735.0	35M7G7W
			CP QAM	23.93	27.78	0.600	35.747	35747.0	35M7D7W
50	3475.02	3525	DFT-s PI/2 BPSK	25.68	29.53	0.897	45.65	45650.0	45M7G7W
			DFT-s QPSK	25.61	29.46	0.883	45.697	45697.0	45M7G7W
			DFT-s QAM	24.57	28.42	0.695	45.714	45714.0	45M7D7W
			CP QPSK	24.18	28.03	0.635	45.697	45697.0	45M7G7W
			CP QAM	23.51	27.36	0.545	45.714	45714.0	45M7D7W
60	3480	3519.99	DFT-s PI/2 BPSK	25.63	29.48	0.887	57.755	57755.0	57M8G7W
			DFT-s QPSK	25.61	29.46	0.883	57.777	57777.0	57M8G7W
			DFT-s QAM	24.53	28.38	0.689	57.872	57872.0	57M9D7W
			CP QPSK	24.08	27.93	0.621	57.777	57777.0	57M8G7W
			CP QAM	23.88	27.73	0.593	57.872	57872.0	57M9D7W
70	3485.01	3514.98	DFT-s PI/2 BPSK	25.58	29.43	0.877	64.205	64205.0	64M2G7W
			DFT-s QPSK	25.57	29.42	0.875	64.305	64305.0	64M3G7W
			DFT-s QAM	24.68	28.53	0.713	64.278	64278.0	64M3D7W
			CP QPSK	24.13	27.98	0.628	64.305	64305.0	64M3G7W
			CP QAM	23.64	27.49	0.561	64.278	64278.0	64M3D7W
80	3490.02	3510	DFT-s PI/2 BPSK	25.63	29.48	0.887	77.014	77014.0	77M0G7W
			DFT-s QPSK	25.6	29.45	0.881	76.967	76967.0	77M0G7W
			DFT-s QAM	24.64	28.49	0.706	77.014	77014.0	77M0D7W
			CP QPSK	24.13	27.98	0.628	76.967	76967.0	77M0G7W
			CP QAM	23.48	27.33	0.541	77.014	77014.0	77M0D7W
90	3495	3504.99	DFT-s PI/2 BPSK	25.57	29.42	0.875	86.623	86623.0	86M6G7W
			DFT-s QPSK	25.55	29.4	0.871	86.593	86593.0	86M6G7W
			DFT-s QAM	24.66	28.51	0.710	86.656	86656.0	86M7D7W
			CP QPSK	24.21	28.06	0.640	86.593	86593.0	86M6G7W
			CP QAM	23.8	27.65	0.582	86.656	86656.0	86M7D7W
100	3500.01	3500.01	DFT-s PI/2 BPSK	25.56	29.41	0.873	96.149	96149.0	96M1G7W
			DFT-s QPSK	25.54	29.39	0.869	96.252	96252.0	96M3G7W
			DFT-s QAM	24.46	28.31	0.678	96.345	96345.0	96M3D7W
			CP QPSK	24.22	28.07	0.641	96.252	96252.0	96M3G7W
			CP QAM	23.52	27.37	0.546	96.345	96345.0	96M3D7W

Unless otherwise stated the results shown in this test report refer only to the sample(s) tested and such sample(s) are retained for 90 days only.

除非另有說明，此報告結果僅對測試之樣品負責，同時此樣品僅保留90天。本報告未經本公司書面許可，不可部份複製。

This document is issued by the Company subject to its General Conditions of Service printed overleaf, available on request or accessible at <http://www.sgs.com.tw/Terms-and-Conditions> and for electronic format documents, subject to Terms and Conditions for Electronic Documents at <http://www.sgs.com.tw/Terms-and-Conditions>. Attention is drawn to the limitation of liability, indemnification and jurisdiction issues defined therein. Any holder of this document is advised that information contained hereon reflects the Company's findings at the time of its intervention only and within the limits of Client's instructions, if any. The Company's sole responsibility is to its Client and this document does not exonerate parties to a transaction from exercising all their rights and obligations under the transaction documents. This document cannot be reproduced except in full, without prior written approval of the Company. Any unauthorized alteration, forgery or falsification of the content or appearance of this document is unlawful and offenders may be prosecuted to the fullest extent of the law.

## 1.5 Test Methodology of Applied Standards

FCC 47 CFR Part 2, 270

ANSI C63.26-2015

KDB971168 D01 Power Meas license Digital System v03r01

KDB412172 D01 Determining ERP and EIRP v01r01

Unless otherwise stated the results shown in this test report refer only to the sample(s) tested and such sample(s) are retained for 90 days only.

除非另有說明，此報告結果僅對測試之樣品負責，同時此樣品僅保留90天。本報告未經本公司書面許可，不可部份複製。

This document is issued by the Company subject to its General Conditions of Service printed overleaf, available on request or accessible at <http://www.sgs.com.tw/Terms-and-Conditions> and for electronic format documents, subject to Terms and Conditions for Electronic Documents at <http://www.sgs.com.tw/Terms-and-Conditions>. Attention is drawn to the limitation of liability, indemnification and jurisdiction issues defined therein. Any holder of this document is advised that information contained hereon reflects the Company's findings at the time of its intervention only and within the limits of Client's instructions, if any. The Company's sole responsibility is to its Client and this document does not exonerate parties to a transaction from exercising all their rights and obligations under the transaction documents. This document cannot be reproduced except in full, without prior written approval of the Company. Any unauthorized alteration, forgery or falsification of the content or appearance of this document is unlawful and offenders may be prosecuted to the fullest extent of the law.



### 1.6 Test Facility

Laboratory	Test Site Address	Test Site Name	FCC Designation number	IC CAB identifier
SGS Taiwan Ltd. Central RF Lab. (TAF code 3702)	No.134, Wu Kung Road, New Taipei Industrial Park, Wuku District, New Taipei City, Taiwan.	SAC 1	TW0027	TW3702
		SAC 3		
		Conduction 1		
		Conducted 1		
		Conducted 2		
		Conducted 3		
		Conducted 4		
		Conducted 5		
		Conducted 6		
		Conduction C		
	SAC C			
	SAC D			
	SAC G			
	Conducted A			
	Conducted B			
	Conducted C			
	Conducted D			
	Conducted E			
	Conducted F			
	Conducted G			
<p><b>Note:</b> Test site name is remarked on the equipment list in each section of this report as an indication where measurements occurred in specific test site and address.</p>				

Unless otherwise stated the results shown in this test report refer only to the sample(s) tested and such sample(s) are retained for 90 days only.

除非另有說明，此報告結果僅對測試之樣品負責，同時此樣品僅保留90天。本報告未經本公司書面許可，不可部份複製。

This document is issued by the Company subject to its General Conditions of Service printed overleaf, available on request or accessible at <http://www.sgs.com.tw/Terms-and-Conditions> and for electronic format documents, subject to Terms and Conditions for Electronic Documents at <http://www.sgs.com.tw/Terms-and-Conditions>. Attention is drawn to the limitation of liability, indemnification and jurisdiction issues defined therein. Any holder of this document is advised that information contained hereon reflects the Company's findings at the time of its intervention only and within the limits of Client's instructions, if any. The Company's sole responsibility is to its Client and this document does not exonerate parties to a transaction from exercising all their rights and obligations under the transaction documents. This document cannot be reproduced except in full, without prior written approval of the Company. Any unauthorized alteration, forgery or falsification of the content or appearance of this document is unlawful and offenders may be prosecuted to the fullest extent of the law.

### 1.7 Special Accessories

No special accessories were used during testing.

### 1.8 Equipment Modifications

There was no modifications incorporated into the EUT.

### 1.9 Radiated Emission Test Sites For Measurements From 9 kHz To 30 MHz

Radiated emission below 30MHz is measured in a 9m\*6m\*6m semi-anechoic chamber, the measurements correspond to those obtained at an open-field test site.

There is a comparison data of both open-field test site and semi-Anechoic chamber, and the result came out very similar.

Unless otherwise stated the results shown in this test report refer only to the sample(s) tested and such sample(s) are retained for 90 days only.

除非另有說明，此報告結果僅對測試之樣品負責，同時此樣品僅保留90天。本報告未經本公司書面許可，不可部份複製。

This document is issued by the Company subject to its General Conditions of Service printed overleaf, available on request or accessible at <http://www.sgs.com.tw/Terms-and-Conditions> and for electronic format documents, subject to Terms and Conditions for Electronic Documents at <http://www.sgs.com.tw/Terms-and-Conditions>. Attention is drawn to the limitation of liability, indemnification and jurisdiction issues defined therein. Any holder of this document is advised that information contained hereon reflects the Company's findings at the time of its intervention only and within the limits of Client's instructions, if any. The Company's sole responsibility is to its Client and this document does not exonerate parties to a transaction from exercising all their rights and obligations under the transaction documents. This document cannot be reproduced except in full, without prior written approval of the Company. Any unauthorized alteration, forgery or falsification of the content or appearance of this document is unlawful and offenders may be prosecuted to the fullest extent of the law.

## 2 SYSTEM TEST CONFIGURATION

### 2.1 EUT Configuration

The EUT configuration for testing is installed on RF field strength measurement to meet the Commissions requirement and operating in a manner which intends to maximize its emission characteristics in a continuous normal application.

### 2.2 EUT Exercise

The EUT (Transmitter) was operated in the continuous transmission mode employed with the simulator of the Base Station that fixates at test default channels to fix the Tx frequency which was for the purpose of the measurements.

### 2.3 Test Procedure

#### 2.3.1 Conducted Measurement at Antenna Port

The EUT is placed on a table which is 0.8 m above ground plane. A low loss of RF cable was used to connect the antenna port of EUT to measurement equipment.

#### 2.3.2 Radiated Emissions (ERP/EIRP)

The EUT is placed on a turn table, for emission measurements below 1 GHz is 0.8 m above ground plane, for emission measurements above 1 GHz, the table height shall be 1.5 m. The turn table shall rotate 360 degrees to determine the position of maximum emission level. EUT is set 3m away from the receiving antenna which varied from 1m to 4m to find out the highest emission. And also, each emission was to be maximized by changing the polarization of receiving antenna both Horizontal and Vertical. In order to find out the max. emission, the relative positions of this hand-held transmitter (EUT) was rotated through three orthogonal axes and measurement procedures for electric field radiated emissions above 1 GHz the EUT measurement is to be made “while keeping the antenna in the ‘cone of radiation’ from that area and pointed at the area both in azimuth and elevation, with polarization oriented for maximum response.” is still within the 3dB illumination BW of the measurement antenna.

### 2.4 Measurement Results Explanation Example

#### For all conducted test items:

The offset level is set in the spectrum analyzer to compensate the RF cable loss and attenuation factor between EUT conducted port and spectrum analyzer. With the offset compensation, the spectrum analyzer reading level is exactly EUT RF output level.

#### Note:

The spectrum analyzer offset is derived from RF cable loss and attenuator factor. Following shows an offset computation in physical test.

	RF cable loss (dB)	Attenuation factor(dB)	offset(dB)
High Band (Above 1 GHz)	6.6	10	16.6

Unless otherwise stated the results shown in this test report refer only to the sample(s) tested and such sample(s) are retained for 90 days only.

除非另有說明，此報告結果僅對測試之樣品負責，同時此樣品僅保留90天。本報告未經本公司書面許可，不可部份複製。

This document is issued by the Company subject to its General Conditions of Service printed overleaf, available on request or accessible at <http://www.sgs.com.tw/Terms-and-Conditions> and for electronic format documents, subject to Terms and Conditions for Electronic Documents at <http://www.sgs.com.tw/Terms-and-Conditions>. Attention is drawn to the limitation of liability, indemnification and jurisdiction issues defined therein. Any holder of this document is advised that information contained hereon reflects the Company's findings at the time of its intervention only and within the limits of Client's instructions, if any. The Company's sole responsibility is to its Client and this document does not exonerate parties to a transaction from exercising all their rights and obligations under the transaction documents. This document cannot be reproduced except in full, without prior written approval of the Company. Any unauthorized alteration, forgery or falsification of the content or appearance of this document is unlawful and offenders may be prosecuted to the fullest extent of the law.

## 2.5 Final Amplifier Voltage and Current Information:

5G NR BAND n77		
CP-OFDM_SCS 30 kHz		
Test mode	DC voltage (V)	DC current (mA)
Bandwidth:20MHz Mod:256QAM	12.5	345
Bandwidth:30MHz Mod:256QAM	12.5	332
Bandwidth:40MHz Mod:256QAM	12.5	356
Bandwidth:50MHz Mod:256QAM	12.5	383
Bandwidth:60MHz Mod:256QAM	12.5	317
Bandwidth:70MHz Mod:256QAM	12.5	310
Bandwidth:80MHz Mod:256QAM	12.5	329
Bandwidth:90MHz Mod:256QAM	12.5	336
Bandwidth:100MHz Mod:256QAM	12.5	372
5G NR BAND n77		
CP-OFDM_SCS 30 kHz		
Test mode	DC voltage (V)	DC current (mA)
Bandwidth:20MHz Mod:256QAM	12.5	343
Bandwidth:30MHz Mod:256QAM	12.5	327
Bandwidth:40MHz Mod:256QAM	12.5	354
Bandwidth:50MHz Mod:256QAM	12.5	318
Bandwidth:60MHz Mod:256QAM	12.5	345
Bandwidth:70MHz Mod:256QAM	12.5	326
Bandwidth:80MHz Mod:256QAM	12.5	374
Bandwidth:90MHz Mod:256QAM	12.5	365
Bandwidth:100MHz Mod:256QAM	12.5	348

Unless otherwise stated the results shown in this test report refer only to the sample(s) tested and such sample(s) are retained for 90 days only.

除非另有說明，此報告結果僅對測試之樣品負責，同時此樣品僅保留90天。本報告未經本公司書面許可，不可部份複製。

This document is issued by the Company subject to its General Conditions of Service printed overleaf, available on request or accessible at <http://www.sgs.com.tw/Terms-and-Conditions> and for electronic format documents, subject to Terms and Conditions for Electronic Documents at <http://www.sgs.com.tw/Terms-and-Conditions>. Attention is drawn to the limitation of liability, indemnification and jurisdiction issues defined therein. Any holder of this document is advised that information contained hereon reflects the Company's findings at the time of its intervention only and within the limits of Client's instructions, if any. The Company's sole responsibility is to its Client and this document does not exonerate parties to a transaction from exercising all their rights and obligations under the transaction documents. This document cannot be reproduced except in full, without prior written approval of the Company. Any unauthorized alteration, forgery or falsification of the content or appearance of this document is unlawful and offenders may be prosecuted to the fullest extent of the law.

## 2.6 Test Configuration

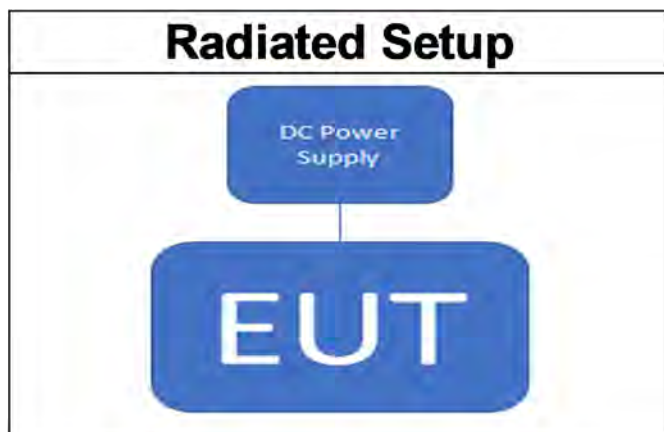
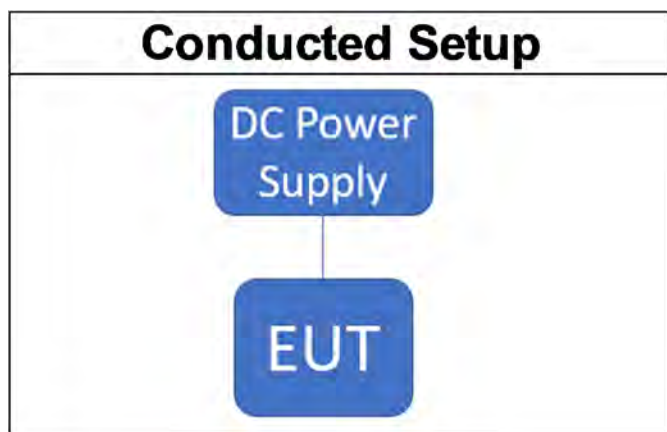

**Note:** Radio Communication Analyzer is placed in remote side for radiated test.

## 2.7 Control Unit(s)

Conducted Emission Test Site: Conducted 3					
EQUIPMENT TYPE	MFR	MODEL NUMBER	SERIAL NUMBER	LAST CAL.	CAL DUE.
Test Software	SGS	Radio Test Software	Ver. 21	N.C.R	N.C.R

Radiated Emission Test Site: SAC 1					
EQUIPMENT TYPE	MFR	MODEL NUMBER	SERIAL NUMBER	LAST CAL.	CAL DUE.
Test Software	Audix	e3	Ver. 9.210322	N.C.R	N.C.R
Mobil radio antenna	HKL	AG307	5A2D602-02	N/A	N/A

Unless otherwise stated the results shown in this test report refer only to the sample(s) tested and such sample(s) are retained for 90 days only.

除非另有說明，此報告結果僅對測試之樣品負責，同時此樣品僅保留90天。本報告未經本公司書面許可，不可部份複製。

This document is issued by the Company subject to its General Conditions of Service printed overleaf, available on request or accessible at <http://www.sgs.com.tw/Terms-and-Conditions> and for electronic format documents, subject to Terms and Conditions for Electronic Documents at <http://www.sgs.com.tw/Terms-and-Conditions>. Attention is drawn to the limitation of liability, indemnification and jurisdiction issues defined therein. Any holder of this document is advised that information contained hereon reflects the Company's findings at the time of its intervention only and within the limits of Client's instructions, if any. The Company's sole responsibility is to its Client and this document does not exonerate parties to a transaction from exercising all their rights and obligations under the transaction documents. This document cannot be reproduced except in full, without prior written approval of the Company. Any unauthorized alteration, forgery or falsification of the content or appearance of this document is unlawful and offenders may be prosecuted to the fullest extent of the law.

### 3 SUMMARY OF TEST RESULTS

FCC Rules	Description Of Test	Result
§2.1046(a)	RF Power Output	Compliant
§27.50(j)(3) §27.50 (k)(3)	EIRP measurement	Compliant
§2.1049(h)	99% & 26dB Occupied Bandwidth	Compliant
§2.1051 §27.53(l)(2) §27.53 (n)(2)	Out of Band Emissions at Antenna Terminals and Band Edge / Emission mask requirements	Compliant
§2.1053 §27.53(l)(2) §27.53 (n)(2)	Field Strength of Spurious Radiation	Compliant
§27.50(j)(4) §27.50 (k)(4)	Peak to Average Ratio	Compliant
§2.1055(a)(1) §27.54	Frequency Stability	Compliant

Unless otherwise stated the results shown in this test report refer only to the sample(s) tested and such sample(s) are retained for 90 days only.

除非另有說明，此報告結果僅對測試之樣品負責，同時此樣品僅保留90天。本報告未經本公司書面許可，不可部份複製。  
This document is issued by the Company subject to its General Conditions of Service printed overleaf, available on request or accessible at <http://www.sgs.com.tw/Terms-and-Conditions> and for electronic format documents, subject to Terms and Conditions for Electronic Documents at <http://www.sgs.com.tw/Terms-and-Conditions>. Attention is drawn to the limitation of liability, indemnification and jurisdiction issues defined therein. Any holder of this document is advised that information contained hereon reflects the Company's findings at the time of its intervention only and within the limits of Client's instructions, if any. The Company's sole responsibility is to its Client and this document does not exonerate parties to a transaction from exercising all their rights and obligations under the transaction documents. This document cannot be reproduced except in full, without prior written approval of the Company. Any unauthorized alteration, forgery or falsification of the content or appearance of this document is unlawful and offenders may be prosecuted to the fullest extent of the law.

## 4 DESCRIPTION OF TEST MODES

### 4.1 The Worst Test Modes and Channel Details

1. The EUT has been tested under operating condition.
2. The field strength of radiated emission was measured as the EUT positioned in different orthogonal planes (E1/E2/H) based on actual usage of the EUT to pre-scan the emissions for determining the worst case scenario.

### 4.2 Measurement Configuration

#### 4.2.1 SA Mode

Test Items	Band	Test Channel			Bandwidth (MHz)										Modulation DFT-s-OFDM					Modulation CP-OFDM					RB #						
		L	M	H	20	30	40	50	60	70	80	90	100	BPSK	QPSK	16 QAM	64 QAM	256 QAM	QPSK	16 QAM	64 QAM	256 QAM	Edge 1RB_Left	Edge 1RB_Right	Inner 1RB_Left	Inner 1RB_Right	Inner Full	Outer Full			
Conducted Power	77	v	v	v	v	v	v	v	v	v	v	v	v	v	v	v	v	v	v	v	v	v				v	v	v	v		
Frequency Stability																															
Occupied Bandwidth		v	v	v	v	v	v	v	v	v	v	v	v	v	v	v	v	v	v	v	v	v									v
Mask		v		v																v				v	v						v
Conducted Emission		v	v	v	v	v	v	v	v	v	v	v	v	v	v	v	v	v	v								v				
CCDF		v	v	v	v	v	v	v	v	v	v	v	v	v	v	v	v	v	v												v
Radiated Emission		v	v	v							v																v				

Unless otherwise stated the results shown in this test report refer only to the sample(s) tested and such sample(s) are retained for 90 days only.

除非另有說明，此報告結果僅對測試之樣品負責，同時此樣品僅保留90天。本報告未經本公司書面許可，不可部份複製。

This document is issued by the Company subject to its General Conditions of Service printed overleaf, available on request or accessible at <http://www.sgs.com.tw/Terms-and-Conditions> and for electronic format documents, subject to Terms and Conditions for Electronic Documents at <http://www.sgs.com.tw/Terms-and-Conditions>. Attention is drawn to the limitation of liability, indemnification and jurisdiction issues defined therein. Any holder of this document is advised that information contained hereon reflects the Company's findings at the time of its intervention only and within the limits of Client's instructions, if any. The Company's sole responsibility is to its Client and this document does not exonerate parties to a transaction from exercising all their rights and obligations under the transaction documents. This document cannot be reproduced except in full, without prior written approval of the Company. Any unauthorized alteration, forgery or falsification of the content or appearance of this document is unlawful and offenders may be prosecuted to the fullest extent of the law.

## 5 MEASUREMENT UNCERTAINTY

Test Items	Uncertainty
RF Power Output	+/- 1 dB
ERP/ EIRP measurement	+/- 3 dB
	+/- 3 dB
Emission Bandwidth	+/- 1.53 Hz
Out of Band Emissions at Antenna Terminals and Band Edge	+/- 1.68 dB
Peak to Average Ratio	+/- 1 dB
Frequency Stability vs. Temperature	+/- 1.53 Hz
Frequency Stability vs. Voltage	+/- 1.53 Hz
Temperature	+/- 0.4 °C
Humidity	+/- 3.5 %
DC / AC Power Source	+/- 1 %

Radiated Spurious Emission Measurement Uncertainty		
<b>Polarization: Vertical</b>	+/- 2.57 dB	9kHz~30MHz
	+/- 4.85 dB	30MHz - 1000MHz
	+/- 4.45 dB	1GHz - 18GHz
	+/- 4.24 dB	18GHz - 40GHz
<b>Polarization: Horizontal</b>	+/- 2.57 dB	9kHz~30MHz
	+/- 4.37 dB	30MHz - 1000MHz
	+/- 4.45 dB	1GHz - 18GHz
	+/- 4.24 dB	18GHz - 40GHz

This uncertainty represents an expanded uncertainty expressed at approximately the 95% confidence level using a coverage factor of k=2.

Unless otherwise stated the results shown in this test report refer only to the sample(s) tested and such sample(s) are retained for 90 days only.

除非另有說明，此報告結果僅對測試之樣品負責，同時此樣品僅保留90天。本報告未經本公司書面許可，不可部份複製。

This document is issued by the Company subject to its General Conditions of Service printed overleaf, available on request or accessible at <http://www.sgs.com.tw/Terms-and-Conditions> and for electronic format documents, subject to Terms and Conditions for Electronic Documents at <http://www.sgs.com.tw/Terms-and-Conditions>. Attention is drawn to the limitation of liability, indemnification and jurisdiction issues defined therein. Any holder of this document is advised that information contained hereon reflects the Company's findings at the time of its intervention only and within the limits of Client's instructions, if any. The Company's sole responsibility is to its Client and this document does not exonerate parties to a transaction from exercising all their rights and obligations under the transaction documents. This document cannot be reproduced except in full, without prior written approval of the Company. Any unauthorized alteration, forgery or falsification of the content or appearance of this document is unlawful and offenders may be prosecuted to the fullest extent of the law.



## 6 MEASUREMENT EQUIPMENT USED

### 6.1 Conducted Measurement

Conducted Emission Test Site: Conducted 3					
EQUIPMENT TYPE	MFR	MODEL NUMBER	SERIAL NUMBER	LAST CAL.	CAL DUE.
EXA Spectrum Analyzer	Agilent	N9010A	MY54200716	10/13/2021	10/12/2022
Radio Communication Test Station	Anritsu	MT8000A	6262036842	11/28/2021	11/27/2022
Temperature Chamber	Giant Force	GTH-150-40-CP-AR	MAA0512-018	05/19/2021	05/18/2022
DC Power Supply	Gwinstek	SPS-3610	GEV856757	10/12/2021	10/11/2022
Attenuator	Mini-Circuit	BW-S10W2+	4	12/14/2021	12/13/2022
DC Block	Mini-Circuits	BLK-18-S+	1	12/14/2021	12/13/2022
Power Divider	RF-LAMBAD	RFLT2W1G18G	11-JSPF412-017	12/14/2021	12/13/2022

Unless otherwise stated the results shown in this test report refer only to the sample(s) tested and such sample(s) are retained for 90 days only.

除非另有說明，此報告結果僅對測試之樣品負責，同時此樣品僅保留90天。本報告未經本公司書面許可，不可部份複製。

This document is issued by the Company subject to its General Conditions of Service printed overleaf, available on request or accessible at <http://www.sgs.com.tw/Terms-and-Conditions> and for electronic format documents, subject to Terms and Conditions for Electronic Documents at <http://www.sgs.com.tw/Terms-and-Conditions>. Attention is drawn to the limitation of liability, indemnification and jurisdiction issues defined therein. Any holder of this document is advised that information contained hereon reflects the Company's findings at the time of its intervention only and within the limits of Client's instructions, if any. The Company's sole responsibility is to its Client and this document does not exonerate parties to a transaction from exercising all their rights and obligations under the transaction documents. This document cannot be reproduced except in full, without prior written approval of the Company. Any unauthorized alteration, forgery or falsification of the content or appearance of this document is unlawful and offenders may be prosecuted to the fullest extent of the law.

## 6.2 Radiated Measurement

Radiated Emission Test Site: SAC 1					
EQUIPMENT TYPE	MFR	MODEL NUMBER	SERIAL NUMBER	LAST CAL.	CAL DUE.
Bi-log Antenna	SCHWARZBECK	VULB9168	300	10/19/2021	10/18/2022
Horn Antenna	SCHWARZBECK	BBHA9120D	D803	12/20/2021	12/19/2022
Bi-log Antenna	TESEO	CBL 6112D	35242 & AT-N0555	01/03/2022	01/02/2023
Horn Antenna	SCHWARZBECK	BBHA9120D	603	05/18/2021	05/17/2022
Horn Antenna	SCHWARZBECK	BBHA9170	184	12/16/2021	12/15/2022
Horn Antenna	SCHWARZBECK	BBHA9170	185	08/06/2021	08/05/2022
Site Cal	SGS	SAC I chamber	N/A	01/01/2022	12/31/2022
Spectrum Analyzer	Agilent	E4446A	MY51100003	10/26/2021	10/25/2022
Radio Communication Test Station	Anritsu	MT8000A	6262036842	11/28/2021	11/27/2022
Pre-Amplifier	EMC Instruments	EMC184045B	980135	10/27/2021	10/26/2022
Pre-Amplifier	HP	8449B	3008A01973	12/16/2021	12/15/2022
Pre-Amplifier	HP	8447D	2944A09469	12/16/2021	12/15/2022
Signal Generator	R&S	SMBV100A	263084	01/11/2022	01/10/2023
Bandreject Filter 3300-3800	Micro-Tronics	WI	1	12/14/2021	12/13/2022
High Pass Filter	WI	WHKX6.0/18G-10SS	WHKX6.0/18G-10SS	12/14/2021	12/13/2022
Coaxial Cable	Huber Suhner	succoflex 102	MY2622/2	12/16/2021	12/15/2022
Coaxial Cable	Huber Suhner	succoflex 104A	800086/4a	12/16/2021	12/15/2022
Coaxial Cable	Huber Suhner	EMC 104-SM-SM-2000	160123	12/16/2021	12/15/2022
Coaxial Cable	Huber Suhner	SUCOFLEX 102	MY2630/2	12/16/2021	12/15/2022
Coaxial Cable	Huber Suhner	SUCOFLEX 102	MY22962/2	12/16/2021	12/15/2022

Unless otherwise stated the results shown in this test report refer only to the sample(s) tested and such sample(s) are retained for 90 days only.

除非另有說明，此報告結果僅對測試之樣品負責，同時此樣品僅保留90天。本報告未經本公司書面許可，不可部份複製。

This document is issued by the Company subject to its General Conditions of Service printed overleaf, available on request or accessible at <http://www.sgs.com.tw/Terms-and-Conditions> and for electronic format documents, subject to Terms and Conditions for Electronic Documents at <http://www.sgs.com.tw/Terms-and-Conditions>. Attention is drawn to the limitation of liability, indemnification and jurisdiction issues defined therein. Any holder of this document is advised that information contained hereon reflects the Company's findings at the time of its intervention only and within the limits of Client's instructions, if any. The Company's sole responsibility is to its Client and this document does not exonerate parties to a transaction from exercising all their rights and obligations under the transaction documents. This document cannot be reproduced except in full, without prior written approval of the Company. Any unauthorized alteration, forgery or falsification of the content or appearance of this document is unlawful and offenders may be prosecuted to the fullest extent of the law.

## 7 MAXMUM OUTPUT POWER

### 7.1 Standard Applicable

A base station simulator was used to establish communication with the EUT. Its parameters were set to transmit the maximum power on the EUT. The measured power in the radio frequency on the transmitter output terminals.

#### 7.1.1 EIRP LIMIT

According to FCC §2.1046

##### FCC 27.50(j)(3)

Mobile and portable stations are limited to 1 Watt EIRP. Mobile and portable stations operating in these bands must employ a means for limiting power to the minimum necessary for successful communications.

##### FCC 27.50(k)(3)

Mobile devices are limited to 1Watt (30 dBm) EIRP. Mobile devices operating in these bands must employ a means for limiting power to the minimum necessary for successful communications.

Unless otherwise stated the results shown in this test report refer only to the sample(s) tested and such sample(s) are retained for 90 days only.

除非另有說明，此報告結果僅對測試之樣品負責，同時此樣品僅保留90天。本報告未經本公司書面許可，不可部份複製。

This document is issued by the Company subject to its General Conditions of Service printed overleaf, available on request or accessible at <http://www.sgs.com.tw/Terms-and-Conditions> and for electronic format documents, subject to Terms and Conditions for Electronic Documents at <http://www.sgs.com.tw/Terms-and-Conditions>. Attention is drawn to the limitation of liability, indemnification and jurisdiction issues defined therein. Any holder of this document is advised that information contained hereon reflects the Company's findings at the time of its intervention only and within the limits of Client's instructions, if any. The Company's sole responsibility is to its Client and this document does not exonerate parties to a transaction from exercising all their rights and obligations under the transaction documents. This document cannot be reproduced except in full, without prior written approval of the Company. Any unauthorized alteration, forgery or falsification of the content or appearance of this document is unlawful and offenders may be prosecuted to the fullest extent of the law.

## 7.2 Test Set-up

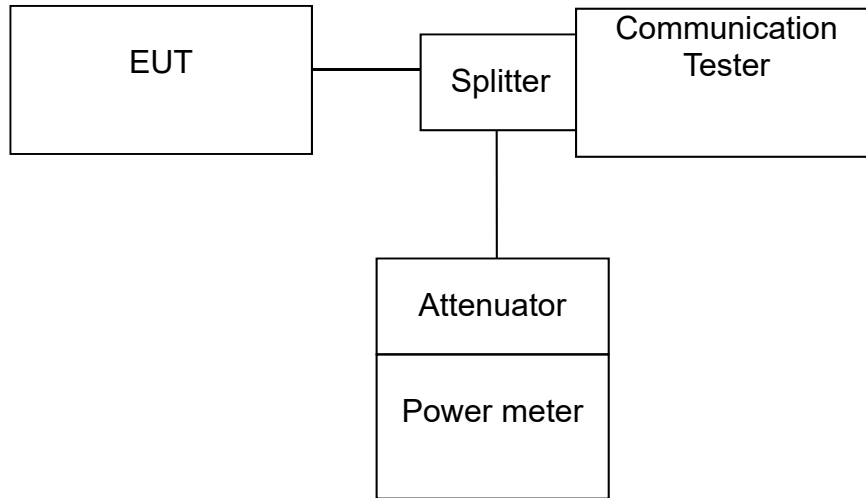

**Note:** Measurement setup for testing on Antenna connector

## 7.3 Output Power Measurement Applicable Guidance

The transmitter output was connected to a calibrated attenuator, the other end of which was connected to a power meter. Transmitter output was read off the power meter in dBm. The power output at the transmitter antenna port was determined by adding the value of the attenuator to the power meter reading.

Unless otherwise stated the results shown in this test report refer only to the sample(s) tested and such sample(s) are retained for 90 days only.

除非另有說明，此報告結果僅對測試之樣品負責，同時此樣品僅保留90天。本報告未經本公司書面許可，不可部份複製。

This document is issued by the Company subject to its General Conditions of Service printed overleaf, available on request or accessible at <http://www.sgs.com.tw/Terms-and-Conditions> and for electronic format documents, subject to Terms and Conditions for Electronic Documents at <http://www.sgs.com.tw/Terms-and-Conditions>. Attention is drawn to the limitation of liability, indemnification and jurisdiction issues defined therein. Any holder of this document is advised that information contained hereon reflects the Company's findings at the time of its intervention only and within the limits of Client's instructions, if any. The Company's sole responsibility is to its Client and this document does not exonerate parties to a transaction from exercising all their rights and obligations under the transaction documents. This document cannot be reproduced except in full, without prior written approval of the Company. Any unauthorized alteration, forgery or falsification of the content or appearance of this document is unlawful and offenders may be prosecuted to the fullest extent of the law.

#### 7.4 Determining ERP and/or EIRP from conducted RF output power measurements

According to KDB 412172 D01 Power Approach,

$$EIRP = P_T + G_T - L_C,$$

$$ERP = EIRP - 2.15,$$

Where:

- ERP or EIRP = effective radiated power or equivalent isotropically radiated power (expressed in the same units as  $P_T$ , typically dBW, dBm, or power spectral density (PSD)<sup>2</sup>), relative to either a dipole antenna (ERP) or an isotropic antenna (EIRP);
- $P_T$  = transmitter output power, expressed in dBW, dBm, or PSD;
- $G_T$  = gain of the transmitting antenna, in dBd (ERP) or dBi (EIRP);
- $L_C$  = signal attenuation in the connecting cable between the transmitter and antenna, in dB.

Unless otherwise stated the results shown in this test report refer only to the sample(s) tested and such sample(s) are retained for 90 days only.

除非另有說明，此報告結果僅對測試之樣品負責，同時此樣品僅保留90天。本報告未經本公司書面許可，不可部份複製。

This document is issued by the Company subject to its General Conditions of Service printed overleaf, available on request or accessible at <http://www.sgs.com.tw/Terms-and-Conditions> and for electronic format documents, subject to Terms and Conditions for Electronic Documents at <http://www.sgs.com.tw/Terms-and-Conditions>. Attention is drawn to the limitation of liability, indemnification and jurisdiction issues defined therein. Any holder of this document is advised that information contained hereon reflects the Company's findings at the time of its intervention only and within the limits of Client's instructions, if any. The Company's sole responsibility is to its Client and this document does not exonerate parties to a transaction from exercising all their rights and obligations under the transaction documents. This document cannot be reproduced except in full, without prior written approval of the Company. Any unauthorized alteration, forgery or falsification of the content or appearance of this document is unlawful and offenders may be prosecuted to the fullest extent of the law.

7.5 Measurement Results:

5G NR Band n77_Part27: 3450 to 3550 MHz					Conducted Average (dBm)			EIRP (dBm)		
Antenna Gain(dBi)			3.85		Channel (ARFCH)/ Frequency(MHz)			Channel (ARFCH)/ Frequency(MHz)		
EIRP Limit (W)			1		Low	Mid	High	Low	Mid	High
BW (MHz)	SCS (kHz)	Modulation	RB Allocation	RB Offset	630668	633334	636000	630668	633334	636000
					3460.02	3500.01	3540	3460.02	3500.01	3540
20	30	DFT-s PI/2 BPSK	1	1	25.61	25.64	25.41	29.46	29.49	29.26
			1	49	25.55	25.19	25.31	29.40	29.04	29.16
			25	12	25.57	25.58	25.58	29.42	29.43	29.43
			50	0	25.07	25.14	25.25	28.92	28.99	29.10
		DFT-s QPSK	1	1	25.58	25.62	25.40	29.43	29.47	29.25
			1	49	25.03	25.62	25.31	28.88	29.47	29.16
			25	12	25.56	25.58	25.62	29.41	29.43	29.47
		DFT-s 16QAM	1	1	24.43	24.62	24.83	28.28	28.47	28.68
		DFT-s 64QAM	1	1	23.12	22.94	23.29	26.97	26.79	27.14
		DFT-s 256QAM	1	1	21.24	21.29	21.37	25.09	25.14	25.22
		CP QPSK	1	1	24.17	22.71	22.75	28.02	26.56	26.60
		CP 16QAM	1	1	23.31	22.61	22.81	27.16	26.46	26.66
		CP 64QAM	1	1	22.16	22.14	22.30	26.01	25.99	26.15
CP 256QAM	1	1	19.27	19.36	19.53	23.12	23.21	23.38		
5G NR Band n77_Part27: 3450 to 3550 MHz					Conducted Average (dBm)			EIRP (dBm)		
Antenna Gain(dBi)			3.85		Channel (ARFCH)/ Frequency(MHz)			Channel (ARFCH)/ Frequency(MHz)		
EIRP Limit (W)			1		Low	Mid	High	Low	Mid	High
BW (MHz)	SCS (kHz)	Modulation	RB Allocation	RB Offset	631000	633334	635666	631000	633334	635666
					3465	3500.01	3534.99	3465	3500.01	3534.99
30	30	DFT-s PI/2 BPSK	1	1	25.55	25.68	25.69	29.40	29.53	29.54
			1	76	25.53	25.50	25.11	29.38	29.35	28.96
			36	18	25.43	25.64	25.67	29.28	29.49	29.52
			75	0	25.04	25.18	25.34	28.89	29.03	29.19
		DFT-s QPSK	1	1	25.48	25.60	25.63	29.33	29.45	29.48
			1	76	25.49	24.90	25.15	29.34	28.75	29.00
			36	18	25.44	25.62	25.66	29.29	29.47	29.51
		75	0	24.46	24.66	24.92	28.31	28.51	28.77	
		DFT-s 16QAM	1	1	24.53	24.61	24.75	28.38	28.46	28.60
		DFT-s 64QAM	1	1	22.96	23.09	23.20	26.81	26.94	27.05
		DFT-s 256QAM	1	1	20.91	20.75	21.64	24.76	24.60	25.49
		CP QPSK	1	1	24.02	24.04	24.35	27.87	27.89	28.20
		CP 16QAM	1	1	23.69	23.30	23.83	27.54	27.15	27.68
CP 64QAM	1	1	22.08	22.03	22.45	25.93	25.88	26.30		
CP 256QAM	1	1	18.96	19.32	19.22	22.81	23.17	23.07		

Unless otherwise stated the results shown in this test report refer only to the sample(s) tested and such sample(s) are retained for 90 days only.

除非另有說明，此報告結果僅對測試之樣品負責，同時此樣品僅保留90天。本報告未經本公司書面許可，不可部份複製。

This document is issued by the Company subject to its General Conditions of Service printed overleaf, available on request or accessible at <http://www.sgs.com.tw/Terms-and-Conditions> and for electronic format documents, subject to Terms and Conditions for Electronic Documents at <http://www.sgs.com.tw/Terms-and-Conditions>. Attention is drawn to the limitation of liability, indemnification and jurisdiction issues defined therein. Any holder of this document is advised that information contained hereon reflects the Company's findings at the time of its intervention only and within the limits of Client's instructions, if any. The Company's sole responsibility is to its Client and this document does not exonerate parties to a transaction from exercising all their rights and obligations under the transaction documents. This document cannot be reproduced except in full, without prior written approval of the Company. Any unauthorized alteration, forgery or falsification of the content or appearance of this document is unlawful and offenders may be prosecuted to the fullest extent of the law.

5G NR Band n77_Part27: 3450 to 3550 MHz					Conducted Average (dBm)			EIRP (dBm)			
Antenna Gain(dBi)			3.85		Channel (ARFCH)/ Freqency(MHz)			Channel (ARFCH)/ Freqency(MHz)			
EIRP Limit (W)			1		Low	Mid	High	Low	Mid	High	
BW (MHz)	SCS (kHz)	Modulation	RB Allocation	RB Offset	631334	633334	635332	631334	633334	635332	
					3470.01	3500.01	3529.98	3470.01	3500.01	3529.98	
40	30	DFT-s PI/2 BPSK	1	1	25.69	25.61	25.63	29.54	29.46	29.48	
			1	104	25.58	24.89	24.92	29.43	28.74	28.77	
			50	25	25.60	25.62	25.61	29.45	29.47	29.46	
			100	0	25.12	25.12	25.27	28.97	28.97	29.12	
		DFT-s QPSK	1	1	25.57	25.58	25.63	29.42	29.43	29.48	
			1	104	24.73	24.87	24.88	28.58	28.72	28.73	
			50	25	25.61	25.62	25.65	29.46	29.47	29.50	
				100	0	24.60	24.65	24.76	28.45	28.50	28.61
		DFT-s 16QAM	1	1	24.50	24.68	24.63	28.35	28.53	28.48	
		DFT-s 64QAM	1	1	23.28	23.11	23.27	27.13	26.96	27.12	
		DFT-s 256QAM	1	1	21.17	21.16	21.07	25.02	25.01	24.92	
		CP QPSK	1	1	24.12	24.08	24.25	27.97	27.93	28.10	
		CP 16QAM	1	1	23.93	23.81	23.66	27.78	27.66	27.51	
CP 64QAM	1	1	22.13	22.26	22.19	25.98	26.11	26.04			
CP 256QAM	1	1	19.14	19.25	19.51	22.99	23.10	23.36			

5G NR Band n77_Part27: 3450 to 3550 MHz					Conducted Average (dBm)			EIRP (dBm)			
Antenna Gain(dBi)			3.85		Channel (ARFCH)/ Freqency(MHz)			Channel (ARFCH)/ Freqency(MHz)			
EIRP Limit (W)			1		Low	Mid	High	Low	Mid	High	
BW (MHz)	SCS (kHz)	Modulation	RB Allocation	RB Offset	631668	633334	635000	631668	633334	635000	
					3475.02	3500.01	3525	3475.02	3500.01	3525	
50	30	DFT-s PI/2 BPSK	1	1	25.49	25.55	25.68	29.34	29.40	29.53	
			1	131	25.43	25.34	25.48	29.28	29.19	29.33	
			64	32	25.41	25.51	25.62	29.26	29.36	29.47	
			128	0	24.97	25.12	25.12	28.82	28.97	28.97	
		DFT-s QPSK	1	1	25.47	25.46	25.51	29.32	29.31	29.36	
			1	131	25.46	25.37	25.44	29.31	29.22	29.29	
			64	32	25.45	25.00	25.61	29.30	28.85	29.46	
				128	0	24.44	24.59	24.63	28.29	28.44	28.48
		DFT-s 16QAM	1	1	24.26	24.50	24.57	28.11	28.35	28.42	
		DFT-s 64QAM	1	1	23.24	22.97	23.01	27.09	26.82	26.86	
		DFT-s 256QAM	1	1	20.75	21.02	21.04	24.60	24.87	24.89	
		CP QPSK	1	1	23.87	24.18	24.04	27.72	28.03	27.89	
		CP 16QAM	1	1	23.23	23.25	23.51	27.08	27.10	27.36	
CP 64QAM	1	1	22.28	22.16	22.22	26.13	26.01	26.07			
CP 256QAM	1	1	18.89	18.79	19.01	22.74	22.64	22.86			

Unless otherwise stated the results shown in this test report refer only to the sample(s) tested and such sample(s) are retained for 90 days only.

除非另有說明，此報告結果僅對測試之樣品負責，同時此樣品僅保留90天。本報告未經本公司書面許可，不可部份複製。

This document is issued by the Company subject to its General Conditions of Service printed overleaf, available on request or accessible at <http://www.sgs.com.tw/Terms-and-Conditions> and for electronic format documents, subject to Terms and Conditions for Electronic Documents at <http://www.sgs.com.tw/Terms-and-Conditions>. Attention is drawn to the limitation of liability, indemnification and jurisdiction issues defined therein. Any holder of this document is advised that information contained hereon reflects the Company's findings at the time of its intervention only and within the limits of Client's instructions, if any. The Company's sole responsibility is to its Client and this document does not exonerate parties to a transaction from exercising all their rights and obligations under the transaction documents. This document cannot be reproduced except in full, without prior written approval of the Company. Any unauthorized alteration, forgery or falsification of the content or appearance of this document is unlawful and offenders may be prosecuted to the fullest extent of the law.

5G NR Band n77_Part27: 3450 to 3550 MHz					Conducted Average (dBm)			EIRP (dBm)			
Antenna Gain(dBi)			3.85		Channel (ARFCH)/ Freqency(MHz)			Channel (ARFCH)/ Freqency(MHz)			
EIRP Limit (W)			1		Low	Mid	High	Low	Mid	High	
BW (MHz)	SCS (kHz)	Modulation	RB Allocation	RB Offset	632000	633334	634666	632000	633334	634666	
					3480	3500.01	3519.99	3480	3500.01	3519.99	
60	30	DFT-s PI/2 BPSK	1	1	25.56	25.63	25.53	29.41	29.48	29.38	
			1	160	25.04	25.16	25.21	28.89	29.01	29.06	
			81	40	25.53	25.54	25.58	29.38	29.39	29.43	
			162	0	25.13	25.11	25.19	28.98	28.96	29.04	
		DFT-s QPSK	1	1	25.51	25.54	24.45	29.36	29.39	28.30	
			1	160	25.04	25.10	25.23	28.89	28.95	29.08	
			81	40	25.55	25.53	25.61	29.40	29.38	29.46	
				162	0	24.53	24.62	24.86	28.38	28.47	28.71
		DFT-s 16QAM	1	1	24.53	24.47	24.46	28.38	28.32	28.31	
		DFT-s 64QAM	1	1	23.12	22.93	23.14	26.97	26.78	26.99	
		DFT-s 256QAM	1	1	20.98	21.17	21.19	24.83	25.02	25.04	
		CP QPSK	1	1	23.98	24.08	24.03	27.83	27.93	27.88	
		CP 16QAM	1	1	23.88	23.53	23.68	27.73	27.38	27.53	
CP 64QAM	1	1	22.03	21.78	22.04	25.88	25.63	25.89			
CP 256QAM	1	1	19.16	19.18	19.21	23.01	23.03	23.06			

5G NR Band n77_Part27: 3450 to 3550 MHz					Conducted Average (dBm)			EIRP (dBm)			
Antenna Gain(dBi)			3.85		Channel (ARFCH)/ Freqency(MHz)			Channel (ARFCH)/ Freqency(MHz)			
EIRP Limit (W)			1		Low	Mid	High	Low	Mid	High	
BW (MHz)	SCS (kHz)	Modulation	RB Allocation	RB Offset	632334	633334	634332	632334	633334	634332	
					3485.01	3500.01	3514.98	3485.01	3500.01	3514.98	
70	30	DFT-s PI/2 BPSK	1	1	25.51	25.58	25.57	29.36	29.43	29.42	
			1	187	24.99	25.11	25.19	28.84	28.96	29.04	
			90	45	25.45	25.55	25.56	29.30	29.40	29.41	
			180	0	25.03	25.17	25.25	28.88	29.02	29.10	
		DFT-s QPSK	1	1	25.48	25.42	25.54	29.33	29.27	29.39	
			1	187	25.00	25.08	25.19	28.85	28.93	29.04	
			90	45	25.45	25.56	25.57	29.30	29.41	29.42	
				180	0	24.53	24.67	24.73	28.38	28.52	28.58
		DFT-s 16QAM	1	1	24.68	24.48	24.49	28.53	28.33	28.34	
		DFT-s 64QAM	1	1	23.00	23.05	23.13	26.85	26.90	26.98	
		DFT-s 256QAM	1	1	21.13	20.99	21.22	24.98	24.84	25.07	
		CP QPSK	1	1	23.86	24.13	24.10	27.71	27.98	27.95	
		CP 16QAM	1	1	23.58	23.53	23.64	27.43	27.38	27.49	
CP 64QAM	1	1	22.04	22.03	22.16	25.89	25.88	26.01			
CP 256QAM	1	1	19.20	19.19	19.20	23.05	23.04	23.05			

Unless otherwise stated the results shown in this test report refer only to the sample(s) tested and such sample(s) are retained for 90 days only.

除非另有說明，此報告結果僅對測試之樣品負責，同時此樣品僅保留90天。本報告未經本公司書面許可，不可部份複製。

This document is issued by the Company subject to its General Conditions of Service printed overleaf, available on request or accessible at <http://www.sgs.com.tw/Terms-and-Conditions> and for electronic format documents, subject to Terms and Conditions for Electronic Documents at <http://www.sgs.com.tw/Terms-and-Conditions>. Attention is drawn to the limitation of liability, indemnification and jurisdiction issues defined therein. Any holder of this document is advised that information contained herein reflects the Company's findings at the time of its intervention only and within the limits of Client's instructions, if any. The Company's sole responsibility is to its Client and this document does not exonerate parties to a transaction from exercising all their rights and obligations under the transaction documents. This document cannot be reproduced except in full, without prior written approval of the Company. Any unauthorized alteration, forgery or falsification of the content or appearance of this document is unlawful and offenders may be prosecuted to the fullest extent of the law.



5G NR Band n77_Part27: 3450 to 3550 MHz					Conducted Average (dBm)			EIRP (dBm)				
Antenna Gain(dBi)			3.85		Channel (ARFCH)/ Freqency(MHz)			Channel (ARFCH)/ Freqency(MHz)				
EIRP Limit (W)			1		Low	Mid	High	Low	Mid	High		
BW (MHz)	SCS (kHz)	Modulation	RB Allocation	RB Offset	632668	633334	634000	632668	633334	634000		
					3490.02	3500.01	3510	3490.02	3500.01	3510		
80	30	DFT-s PI/2 BPSK	1	1	25.57	25.59	25.63	29.42	29.44	29.48		
			1	215	24.88	24.85	24.96	28.73	28.70	28.81		
			108	54	25.55	25.53	25.62	29.40	29.38	29.47		
			216	0	25.13	25.08	25.18	28.98	28.93	29.03		
		DFT-s QPSK	1	1	25.56	25.55	25.56	29.41	29.40	29.41		
			1	215	24.89	24.93	24.90	28.74	28.78	28.75		
			108	54	25.53	25.55	25.60	29.38	29.40	29.45		
				DFT-s 16QAM	1	1	24.55	24.64	24.43	28.40	28.49	28.28
				DFT-s 64QAM	1	1	23.05	23.14	23.11	26.90	26.99	26.96
				DFT-s 256QAM	1	1	21.20	20.98	21.16	25.05	24.83	25.01
				CP QPSK	1	1	24.13	24.10	24.07	27.98	27.95	27.92
				CP 16QAM	1	1	23.48	23.35	23.36	27.33	27.20	27.21
				CP 64QAM	1	1	22.25	22.16	22.12	26.10	26.01	25.97
		CP 256QAM	1	1	19.13	19.28	19.03	22.98	23.13	22.88		

5G NR Band n77_Part27: 3450 to 3550 MHz					Conducted Average (dBm)			EIRP (dBm)				
Antenna Gain(dBi)			3.85		Channel (ARFCH)/ Freqency(MHz)			Channel (ARFCH)/ Freqency(MHz)				
EIRP Limit (W)			1		Low	Mid	High	Low	Mid	High		
BW (MHz)	SCS (kHz)	Modulation	RB Allocation	RB Offset	633000	633334	633666	633000	633334	633666		
					3495	3500.01	3504.99	3495	3500.01	3504.99		
90	30	DFT-s PI/2 BPSK	1	1	25.57	25.56	25.55	29.42	29.41	29.40		
			1	243	24.72	24.95	24.89	28.57	28.80	28.74		
			120	60	25.53	25.51	25.56	29.38	29.36	29.41		
			243	0	25.05	25.14	25.20	28.90	28.99	29.05		
		DFT-s QPSK	1	1	25.53	25.55	25.51	29.38	29.40	29.36		
			1	243	24.74	24.98	24.96	28.59	28.83	28.81		
			120	60	25.45	25.53	25.54	29.30	29.38	29.39		
					243	0	24.54	24.63	24.74	28.39	28.48	28.59
				DFT-s 16QAM	1	1	24.62	24.66	24.47	28.47	28.51	28.32
				DFT-s 64QAM	1	1	23.11	23.10	23.26	26.96	26.95	27.11
				DFT-s 256QAM	1	1	21.03	21.10	20.73	24.88	24.95	24.58
				CP QPSK	1	1	24.15	24.21	24.21	28.00	28.06	28.06
				CP 16QAM	1	1	23.55	23.26	23.80	27.40	27.11	27.65
		CP 64QAM	1	1	22.05	22.21	22.23	25.90	26.06	26.08		
		CP 256QAM	1	1	19.14	18.95	19.25	22.99	22.80	23.10		

Unless otherwise stated the results shown in this test report refer only to the sample(s) tested and such sample(s) are retained for 90 days only.

除非另有說明，此報告結果僅對測試之樣品負責，同時此樣品僅保留90天。本報告未經本公司書面許可，不可部份複製。

This document is issued by the Company subject to its General Conditions of Service printed overleaf, available on request or accessible at <http://www.sgs.com.tw/Terms-and-Conditions> and for electronic format documents, subject to Terms and Conditions for Electronic Documents at <http://www.sgs.com.tw/Terms-and-Conditions>. Attention is drawn to the limitation of liability, indemnification and jurisdiction issues defined therein. Any holder of this document is advised that information contained herein reflects the Company's findings at the time of its intervention only and within the limits of Client's instructions, if any. The Company's sole responsibility is to its Client and this document does not exonerate parties to a transaction from exercising all their rights and obligations under the transaction documents. This document cannot be reproduced except in full, without prior written approval of the Company. Any unauthorized alteration, forgery or falsification of the content or appearance of this document is unlawful and offenders may be prosecuted to the fullest extent of the law.

5G NR Band n77_Part27: 3450 to 3550 MHz					Conducted Average (dBm)			EIRP (dBm)		
Antenna Gain(dBi)			3.85		Channel (ARFCH)/ Freqency(MHz)			Channel (ARFCH)/ Freqency(MHz)		
EIRP Limit (W)			1			Mid			Mid	
BW (MHz)	SCS (kHz)	Modulation	RB Allocation	RB Offset		633334			633334	
						3500.01			3500.01	
100	30	DFT-s PI/2 BPSK	1	1		25.56			29.41	
			1	271		24.80			28.65	
			135	67		25.51			29.36	
			270	0		25.12			28.97	
		DFT-s QPSK	1	1		25.54			29.39	
			1	271		24.81			28.66	
			135	67		25.53			29.38	
			270	0		24.61			28.46	
		DFT-s 16QAM	1	1		24.46			28.31	
		DFT-s 64QAM	1	1		23.09			26.94	
		DFT-s 256QAM	1	1		20.81			24.66	
		CP QPSK	1	1		24.22			28.07	
CP 16QAM	1	1		23.52			27.37			
CP 64QAM	1	1		22.33			26.18			
CP 256QAM	1	1		19.43			23.28			

5G NR Band n77_Part27: 3700 to 3980 MHz					Conducted Average (dBm)			EIRP (dBm)		
Antenna Gain(dBi)			3.85		Channel (ARFCH)/ Freqency(MHz)			Channel (ARFCH)/ Freqency(MHz)		
EIRP Limit (W)			1		Low	Mid	High	Low	Mid	High
BW (MHz)	SCS (kHz)	Modulation	RB Allocation	RB Offset	647334	656000	664666	647334	656000	664666
					3710.01	3840	3969.99	3710.01	3840	3969.99
20	30	DFT-s PI/2 BPSK	1	1	25.30	25.10	24.66	29.15	28.95	28.51
			1	49	25.11	24.97	24.62	28.96	28.82	28.47
			25	12	25.23	24.99	24.64	29.08	28.84	28.49
			50	0	24.73	24.52	24.10	28.58	28.37	27.95
		DFT-s QPSK	1	1	25.28	25.12	24.67	29.13	28.97	28.52
			1	49	25.16	24.95	24.64	29.01	28.80	28.49
			25	12	25.23	24.94	24.60	29.08	28.79	28.45
			50	0	24.27	23.99	23.64	28.12	27.84	27.49
		DFT-s 16QAM	1	1	24.37	24.12	23.47	28.22	27.97	27.32
		DFT-s 64QAM	1	1	22.65	22.62	22.31	26.50	26.47	26.16
		DFT-s 256QAM	1	1	20.80	20.81	20.22	24.65	24.66	24.07
		CP QPSK	1	1	23.73	23.24	23.04	27.58	27.09	26.89
		CP 16QAM	1	1	23.29	23.07	22.80	27.14	26.92	26.65
		CP 64QAM	1	1	21.93	21.56	21.22	25.78	25.41	25.07
CP 256QAM	1	1	18.77	18.72	18.17	22.62	22.57	22.02		

Unless otherwise stated the results shown in this test report refer only to the sample(s) tested and such sample(s) are retained for 90 days only.

除非另有說明，此報告結果僅對測試之樣品負責，同時此樣品僅保留90天。本報告未經本公司書面許可，不可部份複製。

This document is issued by the Company subject to its General Conditions of Service printed overleaf, available on request or accessible at <http://www.sgs.com.tw/Terms-and-Conditions> and for electronic format documents, subject to Terms and Conditions for Electronic Documents at <http://www.sgs.com.tw/Terms-and-Conditions>. Attention is drawn to the limitation of liability, indemnification and jurisdiction issues defined therein. Any holder of this document is advised that information contained hereon reflects the Company's findings at the time of its intervention only and within the limits of Client's instructions, if any. The Company's sole responsibility is to its Client and this document does not exonerate parties to a transaction from exercising all their rights and obligations under the transaction documents. This document cannot be reproduced except in full, without prior written approval of the Company. Any unauthorized alteration, forgery or falsification of the content or appearance of this document is unlawful and offenders may be prosecuted to the fullest extent of the law.

5G NR Band n77_Part27: 3700 to 3980 MHz					Conducted Average (dBm)			EIRP (dBm)				
Antenna Gain(dBi)			3.85		Channel (ARFCH)/ Freqency(MHz)			Channel (ARFCH)/ Freqency(MHz)				
EIRP Limit (W)			1		Low	Mid	High	Low	Mid	High		
BW (MHz)	SCS (kHz)	Modulation	RB Allocation	RB Offset	647668	656000	651000	647668	656000	651000		
					3715.02	3840	3765	3715.02	3840	3765		
30	30	DFT-s PI/2 BPSK	1	1	25.10	25.22	24.93	28.95	29.07	28.78		
			1	76	24.99	25.02	25.17	28.84	28.87	29.02		
			36	18	25.02	25.04	25.02	28.87	28.89	28.87		
			75	0	24.58	24.59	24.56	28.43	28.44	28.41		
		DFT-s QPSK	1	1	25.07	25.13	24.95	28.92	28.98	28.80		
			1	76	24.92	24.98	25.18	28.77	28.83	29.03		
			36	18	25.02	25.05	25.04	28.87	28.90	28.89		
				DFT-s 16QAM	1	1	24.24	24.50	24.09	28.09	28.35	27.94
				DFT-s 64QAM	1	1	22.61	22.62	22.46	26.46	26.47	26.31
				DFT-s 256QAM	1	1	20.64	20.64	20.77	24.49	24.49	24.62
				CP QPSK	1	1	23.31	23.81	23.34	27.16	27.66	27.19
				CP 16QAM	1	1	23.12	22.87	22.85	26.97	26.72	26.70
				CP 64QAM	1	1	21.45	21.97	21.42	25.30	25.82	25.27
		CP 256QAM	1	1	18.44	18.84	18.39	22.29	22.69	22.24		

5G NR Band n77_Part27: 3700 to 3980 MHz					Conducted Average (dBm)			EIRP (dBm)				
Antenna Gain(dBi)			3.85		Channel (ARFCH)/ Freqency(MHz)			Channel (ARFCH)/ Freqency(MHz)				
EIRP Limit (W)			1		Low	Mid	High	Low	Mid	High		
BW (MHz)	SCS (kHz)	Modulation	RB Allocation	RB Offset	648000	656000	664000	648000	656000	664000		
					3720	3840	3960	3720	3840	3960		
40	30	DFT-s PI/2 BPSK	1	1	25.15	25.23	24.46	29.00	29.08	28.31		
			1	104	25.12	24.98	24.62	28.97	28.83	28.47		
			50	25	25.06	25.08	24.47	28.91	28.93	28.32		
			100	0	24.63	24.62	24.06	28.48	28.47	27.91		
		DFT-s QPSK	1	1	25.11	25.16	24.51	28.96	29.01	28.36		
			1	104	25.06	24.98	24.73	28.91	28.83	28.58		
			50	25	25.09	25.07	24.49	28.94	28.92	28.34		
				DFT-s 16QAM	1	1	24.04	24.27	23.30	27.89	28.12	27.15
				DFT-s 64QAM	1	1	22.93	22.96	22.33	26.78	26.81	26.18
				DFT-s 256QAM	1	1	20.82	20.77	20.13	24.67	24.62	23.98
				CP QPSK	1	1	23.67	23.85	23.09	27.52	27.70	26.94
				CP 16QAM	1	1	23.11	23.59	22.78	26.96	27.44	26.63
				CP 64QAM	1	1	21.77	21.90	21.17	25.62	25.75	25.02
		CP 256QAM	1	1	18.79	18.84	18.26	22.64	22.69	22.11		

Unless otherwise stated the results shown in this test report refer only to the sample(s) tested and such sample(s) are retained for 90 days only.

除非另有說明，此報告結果僅對測試之樣品負責，同時此樣品僅保留90天。本報告未經本公司書面許可，不可部份複製。

This document is issued by the Company subject to its General Conditions of Service printed overleaf, available on request or accessible at <http://www.sgs.com.tw/Terms-and-Conditions> and for electronic format documents, subject to Terms and Conditions for Electronic Documents at <http://www.sgs.com.tw/Terms-and-Conditions>. Attention is drawn to the limitation of liability, indemnification and jurisdiction issues defined therein. Any holder of this document is advised that information contained hereon reflects the Company's findings at the time of its intervention only and within the limits of Client's instructions, if any. The Company's sole responsibility is to its Client and this document does not exonerate parties to a transaction from exercising all their rights and obligations under the transaction documents. This document cannot be reproduced except in full, without prior written approval of the Company. Any unauthorized alteration, forgery or falsification of the content or appearance of this document is unlawful and offenders may be prosecuted to the fullest extent of the law.

5G NR Band n77_Part27: 3700 to 3980 MHz					Conducted Average (dBm)			EIRP (dBm)			
Antenna Gain(dBi)			3.85		Channel (ARFCH)/ Freqency(MHz)			Channel (ARFCH)/ Freqency(MHz)			
EIRP Limit (W)			1		Low	Mid	High	Low	Mid	High	
BW (MHz)	SCS (kHz)	Modulation	RB Allocation	RB Offset	648334	656000	663666	648334	656000	663666	
					3725.01	3840	3954.99	3725.01	3840	3954.99	
50	30	DFT-s PI/2 BPSK	1	1	25.13	24.97	24.58	28.98	28.82	28.43	
			1	131	25.01	24.84	24.45	28.86	28.69	28.30	
			64	32	25.00	24.93	24.51	28.85	28.78	28.36	
			128	0	24.51	24.42	24.03	28.36	28.27	27.88	
		DFT-s QPSK	1	1	25.09	24.95	24.55	28.94	28.80	28.40	
			1	131	25.04	24.91	24.46	28.89	28.76	28.31	
			64	32	25.00	24.93	24.43	28.85	28.78	28.28	
				128	0	24.07	23.94	23.47	27.92	27.79	27.32
		DFT-s 16QAM	1	1	24.03	23.91	23.31	27.88	27.76	27.16	
		DFT-s 64QAM	1	1	22.52	22.53	22.08	26.37	26.38	25.93	
		DFT-s 256QAM	1	1	20.51	20.23	20.18	24.36	24.08	24.03	
		CP QPSK	1	1	23.62	23.18	23.18	27.47	27.03	27.03	
		CP 16QAM	1	1	23.20	22.92	22.43	27.05	26.77	26.28	
CP 64QAM	1	1	21.58	21.69	21.09	25.43	25.54	24.94			
CP 256QAM	1	1	18.49	18.65	18.21	22.34	22.50	22.06			

5G NR Band n77_Part27: 3700 to 3980 MHz					Conducted Average (dBm)			EIRP (dBm)			
Antenna Gain(dBi)			3.85		Channel (ARFCH)/ Freqency(MHz)			Channel (ARFCH)/ Freqency(MHz)			
EIRP Limit (W)			1		Low	Mid	High	Low	Mid	High	
BW (MHz)	SCS (kHz)	Modulation	RB Allocation	RB Offset	648668	656000	663332	648668	656000	663332	
					3730.02	3840	3949.98	3730.02	3840	3949.98	
60	30	DFT-s PI/2 BPSK	1	1	25.04	25.13	24.55	28.89	28.98	28.40	
			1	160	24.90	24.85	24.51	28.75	28.70	28.36	
			81	40	24.96	25.01	24.49	28.81	28.86	28.34	
			162	0	24.44	24.57	23.98	28.29	28.42	27.83	
		DFT-s QPSK	1	1	25.00	25.09	24.59	28.85	28.94	28.44	
			1	160	24.95	24.83	24.57	28.80	28.68	28.42	
			81	40	24.96	25.06	24.46	28.81	28.91	28.31	
				162	0	23.96	24.02	23.58	27.81	27.87	27.43
		DFT-s 16QAM	1	1	23.82	24.12	23.53	27.67	27.97	27.38	
		DFT-s 64QAM	1	1	22.36	22.78	22.03	26.21	26.63	25.88	
		DFT-s 256QAM	1	1	20.39	20.60	20.11	24.24	24.45	23.96	
		CP QPSK	1	1	23.43	23.65	23.16	27.28	27.50	27.01	
		CP 16QAM	1	1	23.11	23.22	22.69	26.96	27.07	26.54	
CP 64QAM	1	1	21.51	21.73	21.06	25.36	25.58	24.91			
CP 256QAM	1	1	18.62	18.61	18.17	22.47	22.46	22.02			

Unless otherwise stated the results shown in this test report refer only to the sample(s) tested and such sample(s) are retained for 90 days only.

除非另有說明，此報告結果僅對測試之樣品負責，同時此樣品僅保留90天。本報告未經本公司書面許可，不可部份複製。

This document is issued by the Company subject to its General Conditions of Service printed overleaf, available on request or accessible at <http://www.sgs.com.tw/Terms-and-Conditions> and for electronic format documents, subject to Terms and Conditions for Electronic Documents at <http://www.sgs.com.tw/Terms-and-Conditions>. Attention is drawn to the limitation of liability, indemnification and jurisdiction issues defined therein. Any holder of this document is advised that information contained herein reflects the Company's findings at the time of its intervention only and within the limits of Client's instructions, if any. The Company's sole responsibility is to its Client and this document does not exonerate parties to a transaction from exercising all their rights and obligations under the transaction documents. This document cannot be reproduced except in full, without prior written approval of the Company. Any unauthorized alteration, forgery or falsification of the content or appearance of this document is unlawful and offenders may be prosecuted to the fullest extent of the law.

5G NR Band n77_Part27: 3700 to 3980 MHz					Conducted Average (dBm)			EIRP (dBm)		
Antenna Gain(dBi)			3.85		Channel (ARFCH)/ Freqency(MHz)			Channel (ARFCH)/ Freqency(MHz)		
EIRP Limit (W)			1		Low	Mid	High	Low	Mid	High
BW (MHz)	SCS (kHz)	Modulation	RB Allocation	RB Offset	649000	656000	663000	649000	656000	663000
					3735	3840	3945	3735	3840	3945
70	30	DFT-s PI/2 BPSK	1	1	25.15	25.32	24.72	29.00	29.17	28.57
			1	187	25.08	24.98	24.70	28.93	28.83	28.55
			90	45	24.99	25.15	24.61	28.84	29.00	28.46
			180	0	24.51	24.68	24.12	28.36	28.53	27.97
		DFT-s QPSK	1	1	25.12	25.24	24.71	28.97	29.09	28.56
			1	187	25.13	24.93	24.65	28.98	28.78	28.50
			90	45	25.05	25.17	24.51	28.90	29.02	28.36
			180	0	24.10	24.12	23.61	27.95	27.97	27.46
		DFT-s 16QAM	1	1	23.72	24.46	23.86	27.57	28.31	27.71
		DFT-s 64QAM	1	1	22.57	22.84	22.57	26.42	26.69	26.42
		DFT-s 256QAM	1	1	20.50	20.84	20.22	24.35	24.69	24.07
		CP QPSK	1	1	23.60	23.82	23.36	27.45	27.67	27.21
		CP 16QAM	1	1	23.16	23.40	22.81	27.01	27.25	26.66
CP 64QAM	1	1	21.76	21.85	21.27	25.61	25.70	25.12		
CP 256QAM	1	1	18.34	18.86	18.39	22.19	22.71	22.24		

5G NR Band n77_Part27: 3700 to 3980 MHz					Conducted Average (dBm)			EIRP (dBm)		
Antenna Gain(dBi)			3.85		Channel (ARFCH)/ Freqency(MHz)			Channel (ARFCH)/ Freqency(MHz)		
EIRP Limit (W)			1		Low	Mid	High	Low	Mid	High
BW (MHz)	SCS (kHz)	Modulation	RB Allocation	RB Offset	649334	656000	662666	649334	656000	662666
					3740.01	3840	3939.99	3740.01	3840	3939.99
80	30	DFT-s PI/2 BPSK	1	1	25.15	25.08	24.80	29.00	28.93	28.65
			1	215	25.02	24.81	24.48	28.87	28.66	28.33
			108	54	24.97	24.96	24.44	28.82	28.81	28.29
			216	0	24.51	24.54	24.12	28.36	28.39	27.97
		DFT-s QPSK	1	1	15.07	25.10	24.88	18.92	28.95	28.73
			1	215	25.04	24.81	24.47	28.89	28.66	28.32
			108	54	24.93	24.98	24.44	28.78	28.83	28.29
			216	0	23.95	24.08	23.65	27.80	27.93	27.50
		DFT-s 16QAM	1	1	23.68	24.12	23.86	27.53	27.97	27.71
		DFT-s 64QAM	1	1	22.36	22.67	22.55	26.21	26.52	26.40
		DFT-s 256QAM	1	1	20.36	20.58	20.39	24.21	24.43	24.24
		CP QPSK	1	1	23.57	23.65	23.60	27.42	27.50	27.45
		CP 16QAM	1	1	23.06	23.06	23.29	26.91	26.91	27.14
CP 64QAM	1	1	21.73	21.95	21.55	25.58	25.80	25.40		
CP 256QAM	1	1	18.52	18.66	18.64	22.37	22.51	22.49		

Unless otherwise stated the results shown in this test report refer only to the sample(s) tested and such sample(s) are retained for 90 days only.

除非另有說明，此報告結果僅對測試之樣品負責，同時此樣品僅保留90天。本報告未經本公司書面許可，不可部份複製。

This document is issued by the Company subject to its General Conditions of Service printed overleaf, available on request or accessible at <http://www.sgs.com.tw/Terms-and-Conditions> and for electronic format documents, subject to Terms and Conditions for Electronic Documents at <http://www.sgs.com.tw/Terms-and-Conditions>. Attention is drawn to the limitation of liability, indemnification and jurisdiction issues defined therein. Any holder of this document is advised that information contained hereon reflects the Company's findings at the time of its intervention only and within the limits of Client's instructions, if any. The Company's sole responsibility is to its Client and this document does not exonerate parties to a transaction from exercising all their rights and obligations under the transaction documents. This document cannot be reproduced except in full, without prior written approval of the Company. Any unauthorized alteration, forgery or falsification of the content or appearance of this document is unlawful and offenders may be prosecuted to the fullest extent of the law.

5G NR Band n77_Part27: 3700 to 3980 MHz					Conducted Average (dBm)			EIRP (dBm)		
Antenna Gain(dBi)			3.85		Channel (ARFCH)/ Freqency(MHz)			Channel (ARFCH)/ Freqency(MHz)		
EIRP Limit (W)			1		Low	Mid	High	Low	Mid	High
BW (MHz)	SCS (kHz)	Modulation	RB Allocation	RB Offset	649668	656000	662332	649668	656000	662332
					3745.02	3840	3934.98	3745.02	3840	3934.98
90	30	DFT-s PI/2 BPSK	1	1	25.20	25.14	24.86	29.05	28.99	28.71
			1	243	24.97	24.68	24.39	28.82	28.53	28.24
			120	60	24.82	24.98	24.52	28.67	28.83	28.37
			243	0	24.44	24.47	24.12	28.29	28.32	27.97
		DFT-s QPSK	1	1	25.15	25.18	24.85	29.00	29.03	28.70
			1	243	24.91	24.73	24.39	28.76	28.58	28.24
			120	60	24.87	24.92	24.54	28.72	28.77	28.39
			243	0	23.93	23.92	23.66	27.78	27.77	27.51
		DFT-s 16QAM	1	1	24.01	24.20	23.24	27.86	28.05	27.09
		DFT-s 64QAM	1	1	22.46	22.64	22.25	26.31	26.49	26.10
		DFT-s 256QAM	1	1	20.88	20.44	20.30	24.73	24.29	24.15
		CP QPSK	1	1	23.48	23.72	23.43	27.33	27.57	27.28
CP 16QAM	1	1	22.91	23.35	22.89	26.76	27.20	26.74		
CP 64QAM	1	1	21.62	22.16	21.45	25.47	26.01	25.30		
CP 256QAM	1	1	18.64	18.79	18.57	22.49	22.64	22.42		

5G NR Band n77_Part27: 3700 to 3980 MHz					Conducted Average (dBm)			EIRP (dBm)		
Antenna Gain(dBi)			3.85		Channel (ARFCH)/ Freqency(MHz)			Channel (ARFCH)/ Freqency(MHz)		
EIRP Limit (W)			1		Low	Mid	High	Low	Mid	High
BW (MHz)	SCS (kHz)	Modulation	RB Allocation	RB Offset	650000	656000	662000	650000	656000	662000
					3750	3840	3930	3750	3840	3930
100	30	DFT-s PI/2 BPSK	1	1	25.20	25.08	24.87	29.05	28.93	28.72
			1	271	24.97	24.47	24.21	28.82	28.32	28.06
			135	67	24.90	24.98	24.71	28.75	28.83	28.56
			270	0	24.46	24.47	24.21	28.31	28.32	28.06
		DFT-s QPSK	1	1	25.13	25.10	24.92	28.98	28.95	28.77
			1	271	24.95	24.82	24.76	28.80	28.67	28.61
			135	67	24.91	25.02	24.68	28.76	28.87	28.53
			270	0	23.96	24.03	23.70	27.81	27.88	27.55
		DFT-s 16QAM	1	1	23.08	24.21	23.80	26.93	28.06	27.65
		DFT-s 64QAM	1	1	22.51	22.59	22.59	26.36	26.44	26.44
		DFT-s 256QAM	1	1	20.47	20.83	20.46	24.32	24.68	24.31
		CP QPSK	1	1	23.56	23.38	23.51	27.41	27.23	27.36
CP 16QAM	1	1	22.95	23.39	22.84	26.80	27.24	26.69		
CP 64QAM	1	1	21.61	21.81	21.57	25.46	25.66	25.42		
CP 256QAM	1	1	18.48	18.79	18.45	22.33	22.64	22.30		

Unless otherwise stated the results shown in this test report refer only to the sample(s) tested and such sample(s) are retained for 90 days only.

除非另有說明，此報告結果僅對測試之樣品負責，同時此樣品僅保留90天。本報告未經本公司書面許可，不可部份複製。

This document is issued by the Company subject to its General Conditions of Service printed overleaf, available on request or accessible at <http://www.sgs.com.tw/Terms-and-Conditions> and for electronic format documents, subject to Terms and Conditions for Electronic Documents at <http://www.sgs.com.tw/Terms-and-Conditions>. Attention is drawn to the limitation of liability, indemnification and jurisdiction issues defined therein. Any holder of this document is advised that information contained hereon reflects the Company's findings at the time of its intervention only and within the limits of Client's instructions, if any. The Company's sole responsibility is to its Client and this document does not exonerate parties to a transaction from exercising all their rights and obligations under the transaction documents. This document cannot be reproduced except in full, without prior written approval of the Company. Any unauthorized alteration, forgery or falsification of the content or appearance of this document is unlawful and offenders may be prosecuted to the fullest extent of the law.

## 8 OCCUPIED BANDWIDTH MEASUREMENT

### 8.1 Standard Applicable

The occupied bandwidth is the frequency bandwidth such that, below its lower and above its upper frequency limits, the mean powers radiated are each equal to 0.5 percent of the total mean power.

### 8.2 Test Set-up

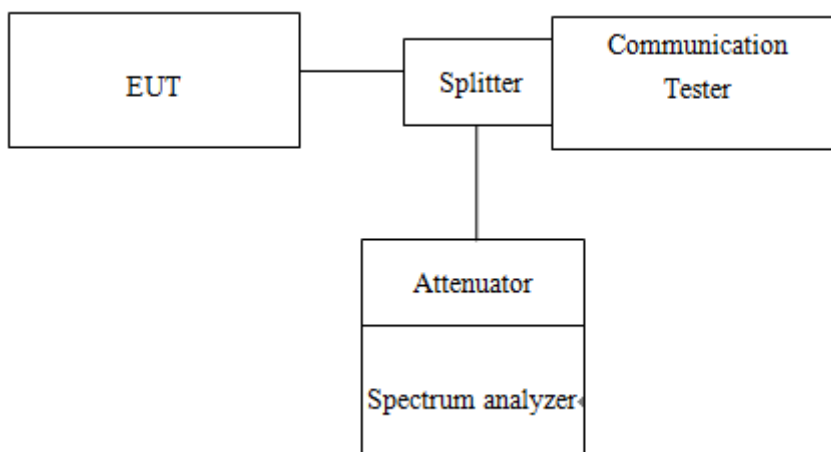

### 8.3 Measurement Procedure

#### 99% & 26dB Bandwidth with detector peak

The EUT's output RF connector was connected with a short cable to the spectrum analyzer, RBW was set to about 1% of emission BW, VBW= 3 times RBW, -26dBc display line was placed on the screen (or 26dB bandwidth), the occupied bandwidth is the delta frequency between the two points where the display line intersects the signal trace. Then set RBW to 99% bandwidth, RBW= 1%, VBW= 3 RBW, with span > 2 \* Signal BW, set % Power = 99%.

### 8.4 Measurement Result

5G NR BAND n77_Part27 Channel bandwidth: 20MHz(3450 to 3550 MHz)											
DFT-S-OFDM_SCS 30 kHz											
Freq. (MHz)	CH	99% BW (MHz)					26 dB BW (MHz)				
		BPSK	QPSK	16QAM	64QAM	256QAM	BPSK	QPSK	16QAM	64QAM	256QAM
3460.02	630668	17.871	17.864	17.871	17.864	17.860	19.08	19.09	19.40	19.12	19.10
3500.01	633334	17.869	17.887	17.881	17.899	17.859	19.12	19.06	19.10	19.02	19.10
3540	636000	17.859	17.871	17.896	17.866	17.890	19.08	19.18	19.23	19.15	19.08

Unless otherwise stated the results shown in this test report refer only to the sample(s) tested and such sample(s) are retained for 90 days only.

除非另有說明，此報告結果僅對測試之樣品負責，同時此樣品僅保留90天。本報告未經本公司書面許可，不可部份複製。

This document is issued by the Company subject to its General Conditions of Service printed overleaf, available on request or accessible at <http://www.sgs.com.tw/Terms-and-Conditions> and for electronic format documents, subject to Terms and Conditions for Electronic Documents at <http://www.sgs.com.tw/Terms-and-Conditions>. Attention is drawn to the limitation of liability, indemnification and jurisdiction issues defined therein. Any holder of this document is advised that information contained hereon reflects the Company's findings at the time of its intervention only and within the limits of Client's instructions, if any. The Company's sole responsibility is to its Client and this document does not exonerate parties to a transaction from exercising all their rights and obligations under the transaction documents. This document cannot be reproduced except in full, without prior written approval of the Company. Any unauthorized alteration, forgery or falsification of the content or appearance of this document is unlawful and offenders may be prosecuted to the fullest extent of the law.

5G NR BAND n77_Part27 Channel bandwidth: 30MHz(3450 to 3550 MHz)											
DFT-S-OFDM_SCS 30 kHz											
Freq. (MHz)	CH	99% BW (MHz)					26 dB BW (MHz)				
		BPSK	QPSK	16QAM	64QAM	256QAM	BPSK	QPSK	16QAM	64QAM	256QAM
3465	631000	26.765	26.758	26.785	26.800	26.765	28.14	28.40	28.18	28.30	28.38
3500.01	633334	26.859	26.777	26.778	26.756	26.795	28.18	28.31	28.29	28.19	28.17
3534.99	635666	26.802	26.770	26.797	26.791	26.803	28.27	28.26	28.21	28.27	28.3
5G NR BAND n77_Part27 Channel bandwidth: 40MHz(3450 to 3550 MHz)											
DFT-S-OFDM_SCS 30 kHz											
Freq. (MHz)	CH	99% BW (MHz)					26 dB BW (MHz)				
		BPSK	QPSK	16QAM	64QAM	256QAM	BPSK	QPSK	16QAM	64QAM	256QAM
3470.01	631334	35.662	35.735	35.676	35.649	35.645	37.46	37.38	37.49	37.62	37.50
3500.01	633334	35.723	35.663	35.729	35.747	35.705	37.43	37.47	37.49	37.49	37.56
3529.98	635332	35.657	35.711	35.696	35.707	35.732	37.5	37.57	37.57	37.49	37.43
5G NR BAND n77_Part27 Channel bandwidth: 50MHz(3450 to 3550 MHz)											
DFT-S-OFDM_SCS 30 kHz											
Freq. (MHz)	CH	99% BW (MHz)					26 dB BW (MHz)				
		BPSK	QPSK	16QAM	64QAM	256QAM	BPSK	QPSK	16QAM	64QAM	256QAM
3475.02	631668	45.598	45.689	45.714	45.675	45.663	47.66	47.58	47.63	47.78	47.63
3500.01	633334	45.650	45.662	45.672	45.646	45.693	47.56	47.69	47.61	47.60	47.65
3525	635000	45.619	45.697	45.606	45.713	45.674	47.61	47.65	47.66	47.59	47.66
5G NR BAND n77_Part27 Channel bandwidth: 60MHz(3450 to 3550 MHz)											
DFT-S-OFDM_SCS 30 kHz											
Freq. (MHz)	CH	99% BW (MHz)					26 dB BW (MHz)				
		BPSK	QPSK	16QAM	64QAM	256QAM	BPSK	QPSK	16QAM	64QAM	256QAM
3480	632000	57.720	57.737	57.773	57.791	57.827	60.19	60.15	60.07	59.96	60.18
3500.01	633334	57.755	57.758	57.872	57.763	57.764	60.09	60.15	60.04	60.17	60.13
3519.99	634666	57.750	57.777	57.768	57.864	57.791	59.99	60.25	60.14	60.16	60.08
5G NR BAND n77_Part27 Channel bandwidth: 70MHz(3450 to 3550 MHz)											
DFT-S-OFDM_SCS 30 kHz											
Freq. (MHz)	CH	99% BW (MHz)					26 dB BW (MHz)				
		BPSK	QPSK	16QAM	64QAM	256QAM	BPSK	QPSK	16QAM	64QAM	256QAM
3485.01	632334	64.088	64.118	64.272	64.125	64.152	66.7	66.68	66.57	66.63	66.61
3500.01	633334	64.205	64.305	64.212	64.159	64.278	66.62	66.74	66.56	66.6	66.5
3514.98	634332	64.202	64.099	64.106	64.221	64.057	66.55	66.59	66.64	66.64	66.63

Unless otherwise stated the results shown in this test report refer only to the sample(s) tested and such sample(s) are retained for 90 days only.

除非另有說明，此報告結果僅對測試之樣品負責，同時此樣品僅保留90天。本報告未經本公司書面許可，不可部份複製。

This document is issued by the Company subject to its General Conditions of Service printed overleaf, available on request or accessible at <http://www.sgs.com.tw/Terms-and-Conditions> and for electronic format documents, subject to Terms and Conditions for Electronic Documents at <http://www.sgs.com.tw/Terms-and-Conditions>. Attention is drawn to the limitation of liability, indemnification and jurisdiction issues defined therein. Any holder of this document is advised that information contained hereon reflects the Company's findings at the time of its intervention only and within the limits of Client's instructions, if any. The Company's sole responsibility is to its Client and this document does not exonerate parties to a transaction from exercising all their rights and obligations under the transaction documents. This document cannot be reproduced except in full, without prior written approval of the Company. Any unauthorized alteration, forgery or falsification of the content or appearance of this document is unlawful and offenders may be prosecuted to the fullest extent of the law.



5G NR BAND n77_Part27 Channel bandwidth: 80MHz(3450 to 3550 MHz)											
DFT-S-OFDM_SCS 30 kHz											
Freq. (MHz)	CH	99% BW (MHz)					26 dB BW (MHz)				
		BPSK	QPSK	16QAM	64QAM	256QAM	BPSK	QPSK	16QAM	64QAM	256QAM
3490.02	632668	76.819	76.952	77.003	76.984	77.007	79.83	79.83	79.89	79.78	79.80
3500.01	633334	77.014	76.948	77.010	76.888	77.005	79.91	79.77	79.78	79.74	79.71
3510	634000	76.98	76.967	77.008	76.978	77.014	79.85	79.89	79.91	79.79	79.90
5G NR BAND n77_Part27 Channel bandwidth: 90MHz(3450 to 3550 MHz)											
DFT-S-OFDM_SCS 30 kHz											
Freq. (MHz)	CH	99% BW (MHz)					26 dB BW (MHz)				
		BPSK	QPSK	16QAM	64QAM	256QAM	BPSK	QPSK	16QAM	64QAM	256QAM
3495	633000	86.623	86.565	86.499	86.599	86.554	89.62	89.76	89.60	89.76	89.80
3500.01	633334	86.558	86.593	86.656	86.647	86.654	89.61	89.79	89.76	89.70	89.59
3504.99	633666	86.604	86.537	86.597	86.592	86.623	89.63	89.76	89.75	89.68	89.74
5G NR BAND n77_Part27 Channel bandwidth: 100MHz(3450 to 3550 MHz)											
DFT-S-OFDM_SCS 30 kHz											
Freq. (MHz)	CH	99% BW (MHz)					26 dB BW (MHz)				
		BPSK	QPSK	16QAM	64QAM	256QAM	BPSK	QPSK	16QAM	64QAM	256QAM
3500.01	633334	96.149	96.252	96.252	96.345	96.220	99.54	99.60	99.47	99.48	99.54
5G NR BAND n77_Part27 Channel bandwidth: 20MHz(3700 to 3980 MHz)											
DFT-S-OFDM_SCS 30 kHz											
Freq. (MHz)	CH	99% BW (MHz)					26 dB BW (MHz)				
		BPSK	QPSK	16QAM	64QAM	256QAM	BPSK	QPSK	16QAM	64QAM	256QAM
3710.0	647334	17.817	17.776	17.817	17.829	17.806	18.98	18.68	18.77	19.16	18.71
3840.0	656000	17.825	17.806	17.777	17.755	17.804	19.00	18.70	18.92	18.57	18.69
3970.0	664666	17.833	17.836	17.828	17.738	17.818	18.66	18.68	18.83	18.56	18.59
5G NR BAND n77_Part27 Channel bandwidth: 30MHz(3700 to 3980 MHz)											
DFT-S-OFDM_SCS 30 kHz											
Freq. (MHz)	CH	99% BW (MHz)					26 dB BW (MHz)				
		BPSK	QPSK	16QAM	64QAM	256QAM	BPSK	QPSK	16QAM	64QAM	256QAM
3715.0	647668	26.821	26.772	26.749	26.683	26.810	27.92	27.90	27.97	27.78	27.73
3840.0	656000	26.716	26.629	26.751	26.755	26.783	27.84	27.84	27.87	28.16	28.03
3765.0	651000	26.702	26.762	26.656	26.802	26.747	27.73	28.14	27.49	27.80	28.15

Unless otherwise stated the results shown in this test report refer only to the sample(s) tested and such sample(s) are retained for 90 days only.

除非另有說明，此報告結果僅對測試之樣品負責，同時此樣品僅保留90天。本報告未經本公司書面許可，不可部份複製。

This document is issued by the Company subject to its General Conditions of Service printed overleaf, available on request or accessible at <http://www.sgs.com.tw/Terms-and-Conditions> and for electronic format documents, subject to Terms and Conditions for Electronic Documents at <http://www.sgs.com.tw/Terms-and-Conditions>. Attention is drawn to the limitation of liability, indemnification and jurisdiction issues defined therein. Any holder of this document is advised that information contained hereon reflects the Company's findings at the time of its intervention only and within the limits of Client's instructions, if any. The Company's sole responsibility is to its Client and this document does not exonerate parties to a transaction from exercising all their rights and obligations under the transaction documents. This document cannot be reproduced except in full, without prior written approval of the Company. Any unauthorized alteration, forgery or falsification of the content or appearance of this document is unlawful and offenders may be prosecuted to the fullest extent of the law.

5G NR BAND n77_Part27 Channel bandwidth: 40MHz(3700 to 3980 MHz)											
DFT-S-OFDM_SCS 30 kHz											
Freq. (MHz)	CH	99% BW (MHz)					26 dB BW (MHz)				
		BPSK	QPSK	16QAM	64QAM	256QAM	BPSK	QPSK	16QAM	64QAM	256QAM
3720.0	648000	35.756	35.824	35.684	35.537	35.692	37.08	36.97	36.97	37.03	37.04
3840.0	656000	35.640	35.639	35.806	35.780	35.652	36.97	37.26	37.04	37.27	37.02
3960.0	664000	35.783	35.783	35.770	35.560	35.774	37.15	37.15	37.13	37.00	37.01
5G NR BAND n77_Part27 Channel bandwidth: 50MHz(3700 to 3980 MHz)											
DFT-S-OFDM_SCS 30 kHz											
Freq. (MHz)	CH	99% BW (MHz)					26 dB BW (MHz)				
		BPSK	QPSK	16QAM	64QAM	256QAM	BPSK	QPSK	16QAM	64QAM	256QAM
3725.0	648334	45.686	45.601	45.708	45.816	45.690	47.24	47.16	47.24	47.11	47.29
3840.0	656000	45.735	45.653	45.660	45.715	45.787	47.23	47.16	46.96	47.24	47.08
3955.0	663666	45.720	45.812	45.817	45.780	45.546	47.18	47.21	47.14	47.33	47.20
5G NR BAND n77_Part27 Channel bandwidth: 60MHz(3700 to 3980 MHz)											
DFT-S-OFDM_SCS 30 kHz											
Freq. (MHz)	CH	99% BW (MHz)					26 dB BW (MHz)				
		BPSK	QPSK	16QAM	64QAM	256QAM	BPSK	QPSK	16QAM	64QAM	256QAM
3730.0	648668	57.804	57.841	57.837	57.797	57.790	59.70	59.87	59.70	59.82	59.78
3840.0	656000	57.838	57.844	57.864	57.882	57.766	59.70	59.83	59.98	59.62	59.61
3950.0	663332	57.869	57.924	57.937	57.795	57.811	59.76	59.74	59.78	59.60	59.64
5G NR BAND n77_Part27 Channel bandwidth: 70MHz(3700 to 3980 MHz)											
DFT-S-OFDM_SCS 30 kHz											
Freq. (MHz)	CH	99% BW (MHz)					26 dB BW (MHz)				
		BPSK	QPSK	16QAM	64QAM	256QAM	BPSK	QPSK	16QAM	64QAM	256QAM
3735.0	649000	64.189	64.179	64.186	64.316	64.086	66.35	66.45	66.33	66.16	66.34
3840.0	656000	64.215	63.900	64.040	64.227	64.153	66.28	66.58	66.21	66.23	66.34
3945.0	663000	64.058	64.361	64.293	64.164	64.138	66.40	66.37	66.45	66.41	66.11
5G NR BAND n77_Part27 Channel bandwidth: 80MHz(3700 to 3980 MHz)											
DFT-S-OFDM_SCS 30 kHz											
Freq. (MHz)	CH	99% BW (MHz)					26 dB BW (MHz)				
		BPSK	QPSK	16QAM	64QAM	256QAM	BPSK	QPSK	16QAM	64QAM	256QAM
3740.0	649334	77.157	76.997	77.111	77.061	76.995	79.61	79.54	79.57	79.62	79.48
3840.0	656000	76.935	76.982	77.070	77.116	77.094	79.50	79.57	79.75	79.52	79.53
3940.0	662666	76.975	77.168	77.126	77.051	77.143	79.58	79.55	79.47	79.59	79.54

Unless otherwise stated the results shown in this test report refer only to the sample(s) tested and such sample(s) are retained for 90 days only.

除非另有說明，此報告結果僅對測試之樣品負責，同時此樣品僅保留90天。本報告未經本公司書面許可，不可部份複製。

This document is issued by the Company subject to its General Conditions of Service printed overleaf, available on request or accessible at <http://www.sgs.com.tw/Terms-and-Conditions> and for electronic format documents, subject to Terms and Conditions for Electronic Documents at <http://www.sgs.com.tw/Terms-and-Conditions>. Attention is drawn to the limitation of liability, indemnification and jurisdiction issues defined therein. Any holder of this document is advised that information contained hereon reflects the Company's findings at the time of its intervention only and within the limits of Client's instructions, if any. The Company's sole responsibility is to its Client and this document does not exonerate parties to a transaction from exercising all their rights and obligations under the transaction documents. This document cannot be reproduced except in full, without prior written approval of the Company. Any unauthorized alteration, forgery or falsification of the content or appearance of this document is unlawful and offenders may be prosecuted to the fullest extent of the law.

5G NR BAND n77_Part27 Channel bandwidth: 90MHz(3700 to 3980 MHz)											
DFT-S-OFDM_SCS 30 kHz											
Freq. (MHz)	CH	99% BW (MHz)					26 dB BW (MHz)				
		BPSK	QPSK	16QAM	64QAM	256QAM	BPSK	QPSK	16QAM	64QAM	256QAM
3745.0	649668	86.749	86.716	86.627	86.699	86.506	89.55	89.47	89.51	89.48	89.52
3840.0	656000	84.215	86.486	86.739	86.465	86.346	89.51	89.50	89.42	89.45	89.33
3934.98	662332	86.751	86.686	86.431	86.765	86.532	89.31	89.60	89.40	89.34	89.57

5G NR BAND n77_Part27 Channel bandwidth: 100MHz(3700 to 3980 MHz)											
DFT-S-OFDM_SCS 30 kHz											
Freq. (MHz)	CH	99% BW (MHz)					26 dB BW (MHz)				
		BPSK	QPSK	16QAM	64QAM	256QAM	BPSK	QPSK	16QAM	64QAM	256QAM
3750.0	650000	96.122	96.154	96.194	96.204	96.232	99.26	99.32	99.28	99.39	99.35
3840.0	656000	96.073	96.254	96.495	95.964	96.114	99.29	99.24	99.42	99.31	99.39
3930.0	662000	96.441	96.374	96.413	96.242	96.344	99.32	99.41	99.23	99.27	99.39

Unless otherwise stated the results shown in this test report refer only to the sample(s) tested and such sample(s) are retained for 90 days only.

除非另有說明，此報告結果僅對測試之樣品負責，同時此樣品僅保留90天。本報告未經本公司書面許可，不可部份複製。  
 This document is issued by the Company subject to its General Conditions of Service printed overleaf, available on request or accessible at <http://www.sgs.com.tw/Terms-and-Conditions> and for electronic format documents, subject to Terms and Conditions for Electronic Documents at <http://www.sgs.com.tw/Terms-and-Conditions>. Attention is drawn to the limitation of liability, indemnification and jurisdiction issues defined therein. Any holder of this document is advised that information contained hereon reflects the Company's findings at the time of its intervention only and within the limits of Client's instructions, if any. The Company's sole responsibility is to its Client and this document does not exonerate parties to a transaction from exercising all their rights and obligations under the transaction documents. This document cannot be reproduced except in full, without prior written approval of the Company. Any unauthorized alteration, forgery or falsification of the content or appearance of this document is unlawful and offenders may be prosecuted to the fullest extent of the law.







Band77-Part27\_30MHz\_DFT\_s\_OFDM\_SCS30kHz\_QPSK\_RB75\_0\_CH631000

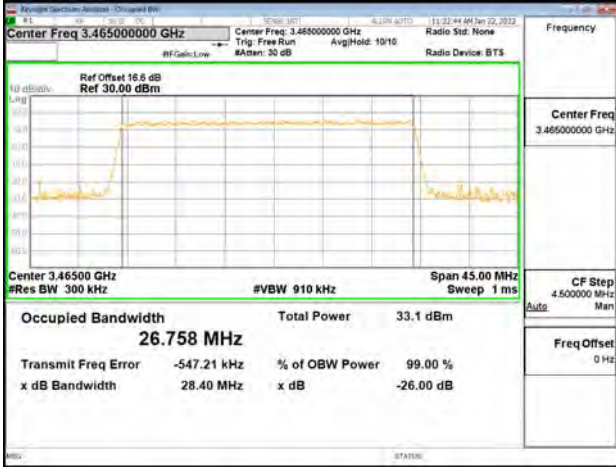

Band77-Part27\_30MHz\_DFT\_s\_OFDM\_SCS30kHz\_16QAM\_RB75\_0\_CH631000

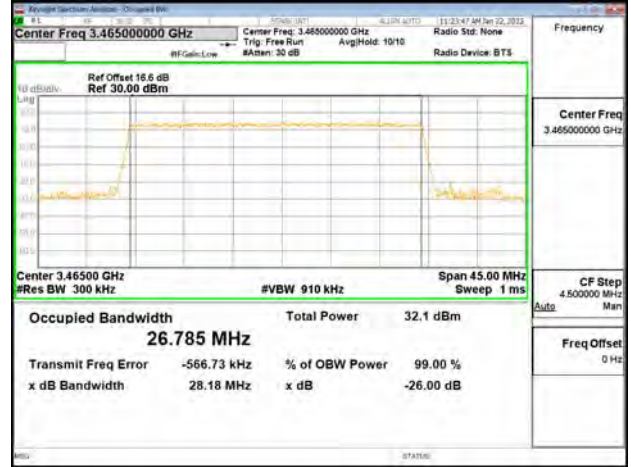

Band77-Part27\_30MHz\_DFT\_s\_OFDM\_SCS30kHz\_QPSK\_RB75\_0\_CH633334



Band77-Part27\_30MHz\_DFT\_s\_OFDM\_SCS30kHz\_16QAM\_RB75\_0\_CH633334

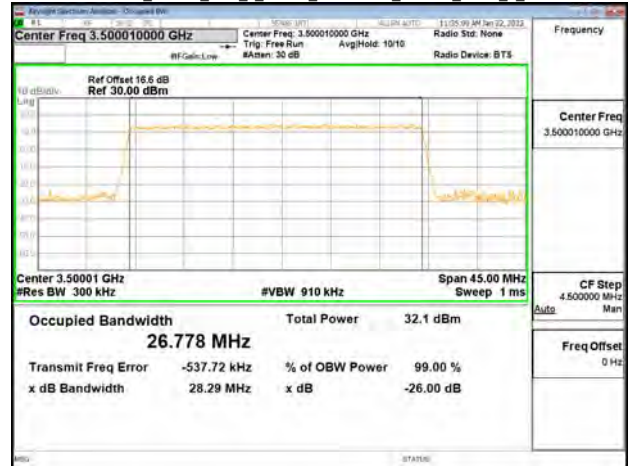

Band77-Part27\_30MHz\_DFT\_s\_OFDM\_SCS30kHz\_QPSK\_RB75\_0\_CH635666



Band77-Part27\_30MHz\_DFT\_s\_OFDM\_SCS30kHz\_16QAM\_RB75\_0\_CH635666



Unless otherwise stated the results shown in this test report refer only to the sample(s) tested and such sample(s) are retained for 90 days only.

除非另有說明，此報告結果僅對測試之樣品負責，同時此樣品僅保留90天。本報告未經本公司書面許可，不可部份複製。  
This document is issued by the Company subject to its General Conditions of Service printed overleaf, available on request or accessible at <http://www.sgs.com.tw/Terms-and-Conditions> and for electronic format documents, subject to Terms and Conditions for Electronic Documents at <http://www.sgs.com.tw/Terms-and-Conditions>. Attention is drawn to the limitation of liability, indemnification and jurisdiction issues defined therein. Any holder of this document is advised that information contained hereon reflects the Company's findings at the time of its intervention only and within the limits of Client's instructions, if any. The Company's sole responsibility is to its Client and this document does not exonerate parties to a transaction from exercising all their rights and obligations under the transaction documents. This document cannot be reproduced except in full, without prior written approval of the Company. Any unauthorized alteration, forgery or falsification of the content or appearance of this document is unlawful and offenders may be prosecuted to the fullest extent of the law.





Band77-Part27\_40MHz\_DFT\_s\_OFDM\_SCS30kHz\_BPSK\_RB100\_0\_CH631334

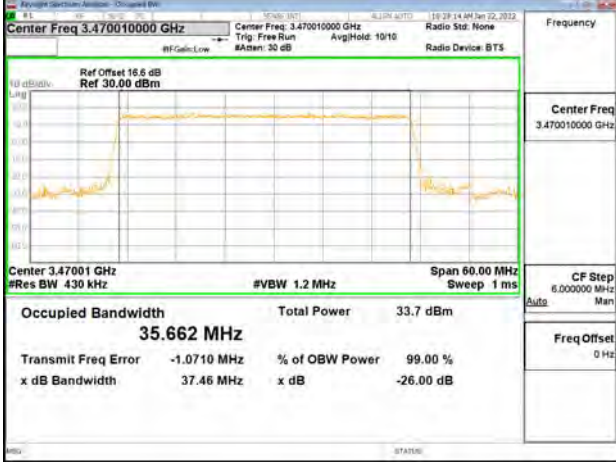

Band77-Part27\_40MHz\_DFT\_s\_OFDM\_SCS30kHz\_QPSK\_RB100\_0\_CH631334



Band77-Part27\_40MHz\_DFT\_s\_OFDM\_SCS30kHz\_BPSK\_RB100\_0\_CH633334

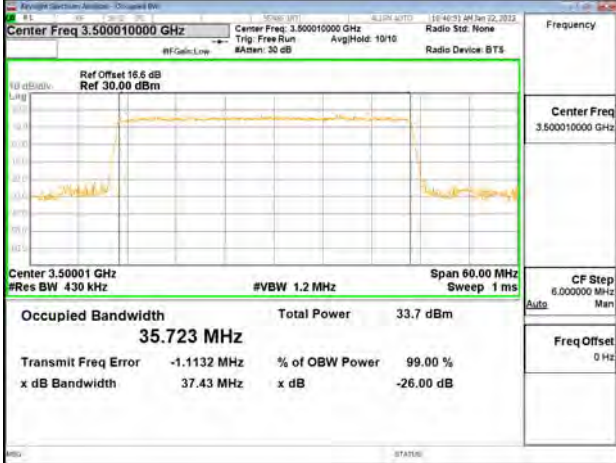

Band77-Part27\_40MHz\_DFT\_s\_OFDM\_SCS30kHz\_QPSK\_RB100\_0\_CH633334



Band77-Part27\_40MHz\_DFT\_s\_OFDM\_SCS30kHz\_BPSK\_RB100\_0\_CH635332

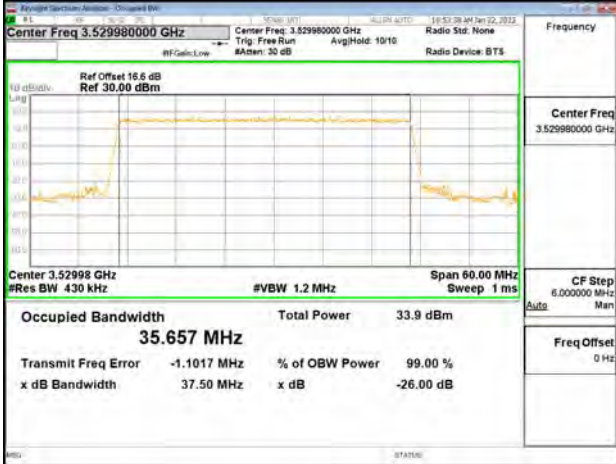

Band77-Part27\_40MHz\_DFT\_s\_OFDM\_SCS30kHz\_QPSK\_RB100\_0\_CH635332

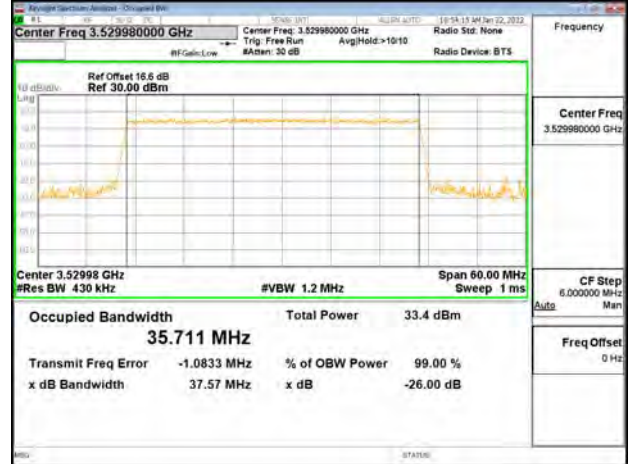

Unless otherwise stated the results shown in this test report refer only to the sample(s) tested and such sample(s) are retained for 90 days only.

除非另有說明，此報告結果僅對測試之樣品負責，同時此樣品僅保留90天。本報告未經本公司書面許可，不可部份複製。  
This document is issued by the Company subject to its General Conditions of Service printed overleaf, available on request or accessible at <http://www.sgs.com.tw/Terms-and-Conditions> and for electronic format documents, subject to Terms and Conditions for Electronic Documents at <http://www.sgs.com.tw/Terms-and-Conditions>. Attention is drawn to the limitation of liability, indemnification and jurisdiction issues defined therein. Any holder of this document is advised that information contained hereon reflects the Company's findings at the time of its intervention only and within the limits of Client's instructions, if any. The Company's sole responsibility is to its Client and this document does not exonerate parties to a transaction from exercising all their rights and obligations under the transaction documents. This document cannot be reproduced except in full, without prior written approval of the Company. Any unauthorized alteration, forgery or falsification of the content or appearance of this document is unlawful and offenders may be prosecuted to the fullest extent of the law.

Band77-Part27\_40MHz\_DFT\_s\_OFDM\_SCS30kHz\_16QAM\_RB100\_0\_CH631334

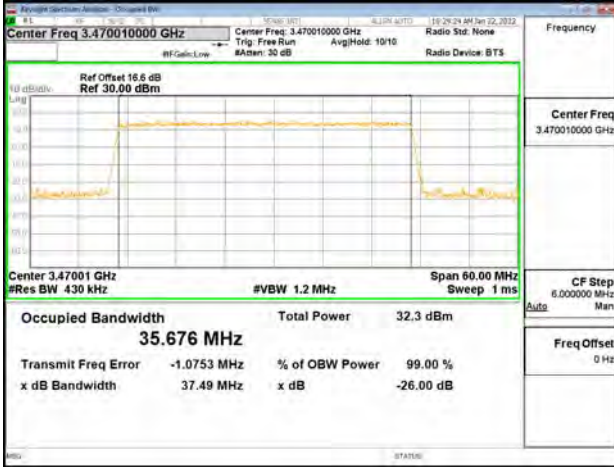

Band77-Part27\_40MHz\_DFT\_s\_OFDM\_SCS30kHz\_64QAM\_RB100\_0\_CH631334

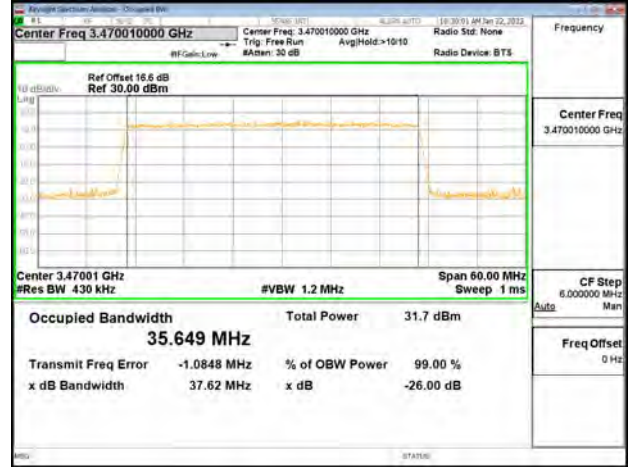

Band77-Part27\_40MHz\_DFT\_s\_OFDM\_SCS30kHz\_16QAM\_RB100\_0\_CH633334



Band77-Part27\_40MHz\_DFT\_s\_OFDM\_SCS30kHz\_64QAM\_RB100\_0\_CH633334



Band77-Part27\_40MHz\_DFT\_s\_OFDM\_SCS30kHz\_16QAM\_RB100\_0\_CH635332



Band77-Part27\_40MHz\_DFT\_s\_OFDM\_SCS30kHz\_64QAM\_RB100\_0\_CH635332



Unless otherwise stated the results shown in this test report refer only to the sample(s) tested and such sample(s) are retained for 90 days only.  
 除非另有說明，此報告結果僅對測試之樣品負責，同時此樣品僅保留90天。本報告未經本公司書面許可，不可部份複製。  
 This document is issued by the Company subject to its General Conditions of Service printed overleaf, available on request or accessible at <http://www.sgs.com.tw/Terms-and-Conditions> and for electronic format documents, subject to Terms and Conditions for Electronic Documents at <http://www.sgs.com.tw/Terms-and-Conditions>. Attention is drawn to the limitation of liability, indemnification and jurisdiction issues defined therein. Any holder of this document is advised that information contained hereon reflects the Company's findings at the time of its intervention only and within the limits of Client's instructions, if any. The Company's sole responsibility is to its Client and this document does not exonerate parties to a transaction from exercising all their rights and obligations under the transaction documents. This document cannot be reproduced except in full, without prior written approval of the Company. Any unauthorized alteration, forgery or falsification of the content or appearance of this document is unlawful and offenders may be prosecuted to the fullest extent of the law.

Band77-Part27\_40MHz\_DFT\_s\_OFDM\_SCS30kHz\_256QAM\_RB100\_0\_CH631334



Band77-Part27\_50MHz\_DFT\_s\_OFDM\_SCS30kHz\_BPSK\_RB128\_0\_CH631668



Band77-Part27\_40MHz\_DFT\_s\_OFDM\_SCS30kHz\_256QAM\_RB100\_0\_CH633334

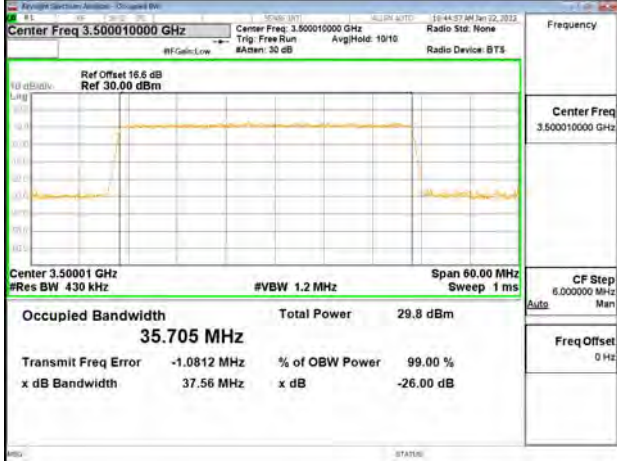

Band77-Part27\_50MHz\_DFT\_s\_OFDM\_SCS30kHz\_BPSK\_RB128\_0\_CH633334

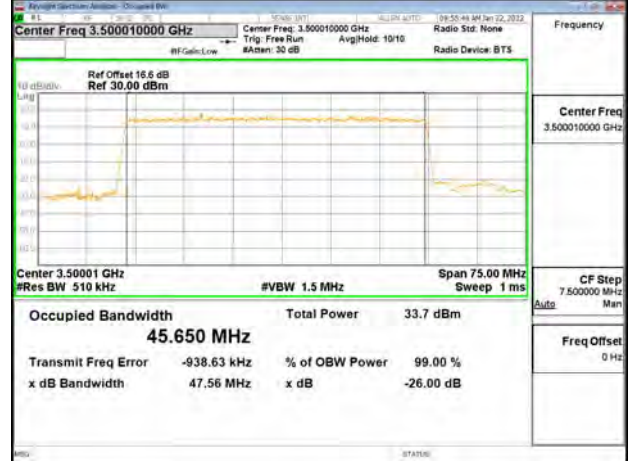

Band77-Part27\_40MHz\_DFT\_s\_OFDM\_SCS30kHz\_256QAM\_RB100\_0\_CH635332



Band77-Part27\_50MHz\_DFT\_s\_OFDM\_SCS30kHz\_BPSK\_RB128\_0\_CH635000

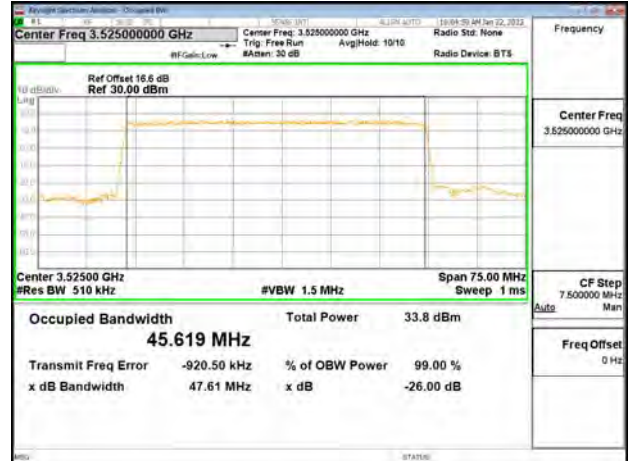

Unless otherwise stated the results shown in this test report refer only to the sample(s) tested and such sample(s) are retained for 90 days only.

除非另有說明，此報告結果僅對測試之樣品負責，同時此樣品僅保留90天。本報告未經本公司書面許可，不可部份複製。

This document is issued by the Company subject to its General Conditions of Service printed overleaf, available on request or accessible at <http://www.sgs.com.tw/Terms-and-Conditions> and for electronic format documents, subject to Terms and Conditions for Electronic Documents at <http://www.sgs.com.tw/Terms-and-Conditions>. Attention is drawn to the limitation of liability, indemnification and jurisdiction issues defined therein. Any holder of this document is advised that information contained hereon reflects the Company's findings at the time of its intervention only and within the limits of Client's instructions, if any. The Company's sole responsibility is to its Client and this document does not exonerate parties to a transaction from exercising all their rights and obligations under the transaction documents. This document cannot be reproduced except in full, without prior written approval of the Company. Any unauthorized alteration, forgery or falsification of the content or appearance of this document is unlawful and offenders may be prosecuted to the fullest extent of the law.

Band77-Part27\_50MHz\_DFT\_s\_OFDM\_SCS30kHz\_QPSK\_RB128\_0\_CH631668

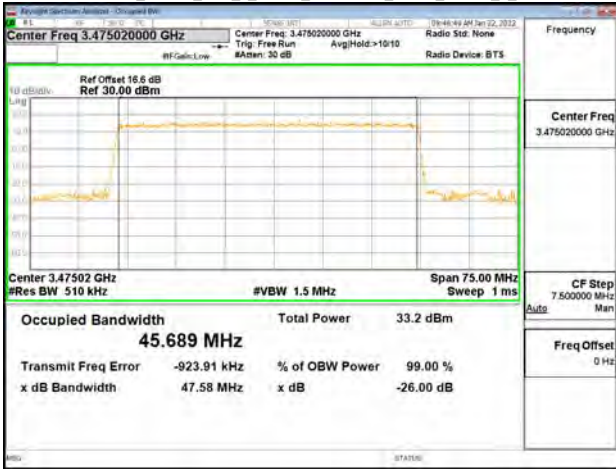

Band77-Part27\_50MHz\_DFT\_s\_OFDM\_SCS30kHz\_16QAM\_RB128\_0\_CH631668

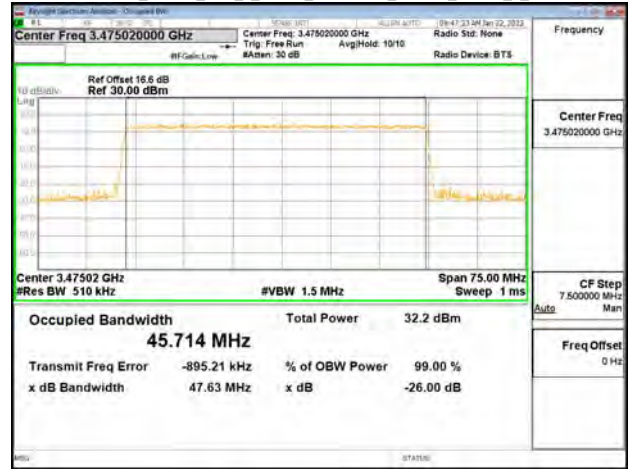

Band77-Part27\_50MHz\_DFT\_s\_OFDM\_SCS30kHz\_QPSK\_RB128\_0\_CH633334



Band77-Part27\_50MHz\_DFT\_s\_OFDM\_SCS30kHz\_16QAM\_RB128\_0\_CH633334



Band77-Part27\_50MHz\_DFT\_s\_OFDM\_SCS30kHz\_QPSK\_RB128\_0\_CH635000



Band77-Part27\_50MHz\_DFT\_s\_OFDM\_SCS30kHz\_16QAM\_RB128\_0\_CH635000



Unless otherwise stated the results shown in this test report refer only to the sample(s) tested and such sample(s) are retained for 90 days only.

除非另有說明，此報告結果僅對測試之樣品負責，同時此樣品僅保留90天。本報告未經本公司書面許可，不可部份複製。  
 This document is issued by the Company subject to its General Conditions of Service printed overleaf, available on request or accessible at <http://www.sgs.com.tw/Terms-and-Conditions> and for electronic format documents, subject to Terms and Conditions for Electronic Documents at <http://www.sgs.com.tw/Terms-and-Conditions>. Attention is drawn to the limitation of liability, indemnification and jurisdiction issues defined therein. Any holder of this document is advised that information contained hereon reflects the Company's findings at the time of its intervention only and within the limits of Client's instructions, if any. The Company's sole responsibility is to its Client and this document does not exonerate parties to a transaction from exercising all their rights and obligations under the transaction documents. This document cannot be reproduced except in full, without prior written approval of the Company. Any unauthorized alteration, forgery or falsification of the content or appearance of this document is unlawful and offenders may be prosecuted to the fullest extent of the law.

Band77-Part27\_50MHz\_DFT\_s\_OFDM\_SCS30kHz\_64QAM\_RB128\_0\_CH631668

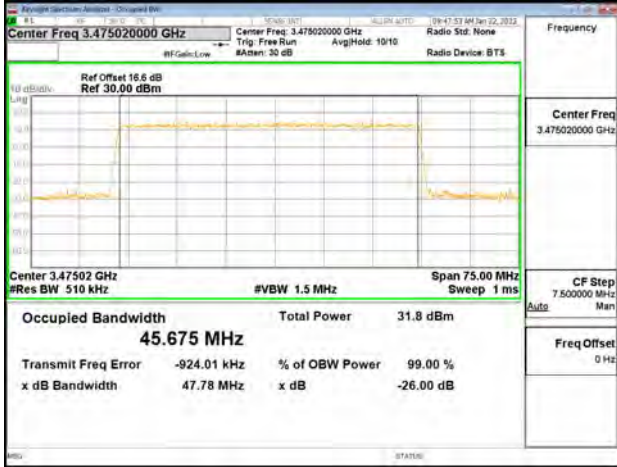

Band77-Part27\_50MHz\_DFT\_s\_OFDM\_SCS30kHz\_256QAM\_RB128\_0\_CH631668

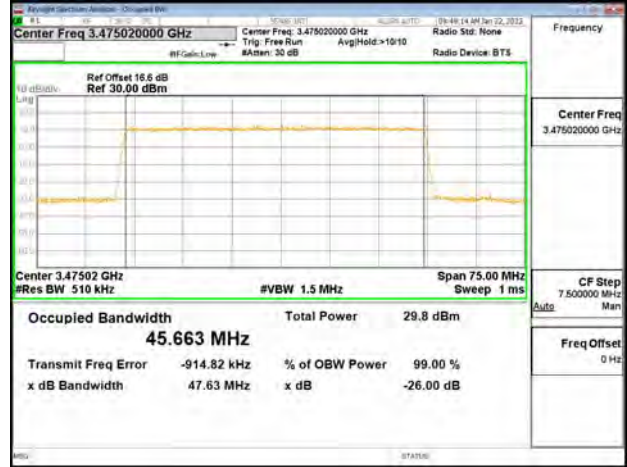

Band77-Part27\_50MHz\_DFT\_s\_OFDM\_SCS30kHz\_64QAM\_RB128\_0\_CH633334

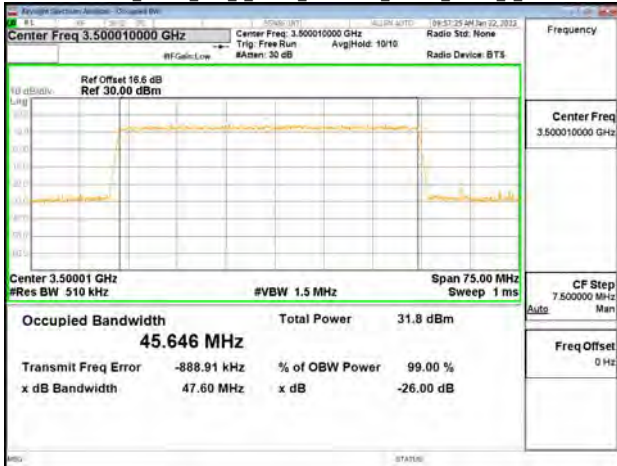

Band77-Part27\_50MHz\_DFT\_s\_OFDM\_SCS30kHz\_256QAM\_RB128\_0\_CH633334

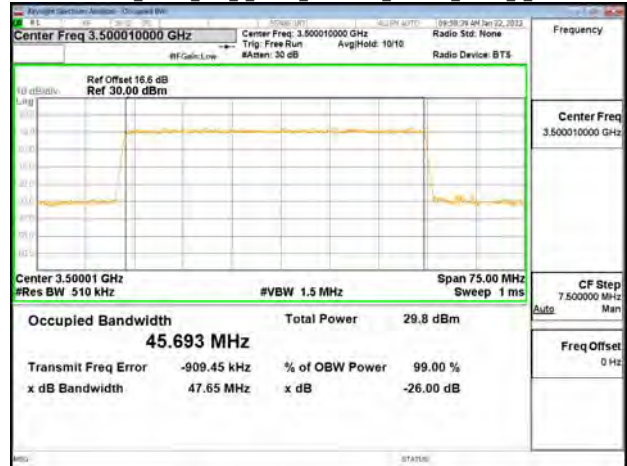

Band77-Part27\_50MHz\_DFT\_s\_OFDM\_SCS30kHz\_64QAM\_RB128\_0\_CH635000



Band77-Part27\_50MHz\_DFT\_s\_OFDM\_SCS30kHz\_256QAM\_RB128\_0\_CH635000

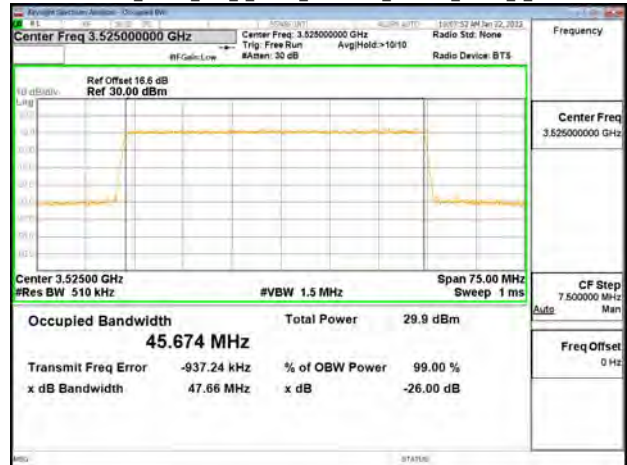

Unless otherwise stated the results shown in this test report refer only to the sample(s) tested and such sample(s) are retained for 90 days only.

除非另有說明，此報告結果僅對測試之樣品負責，同時此樣品僅保留90天。本報告未經本公司書面許可，不可部份複製。

This document is issued by the Company subject to its General Conditions of Service printed overleaf, available on request or accessible at <http://www.sgs.com.tw/Terms-and-Conditions> and for electronic format documents, subject to Terms and Conditions for Electronic Documents at <http://www.sgs.com.tw/Terms-and-Conditions>. Attention is drawn to the limitation of liability, indemnification and jurisdiction issues defined therein. Any holder of this document is advised that information contained hereon reflects the Company's findings at the time of its intervention only and within the limits of Client's instructions, if any. The Company's sole responsibility is to its Client and this document does not exonerate parties to a transaction from exercising all their rights and obligations under the transaction documents. This document cannot be reproduced except in full, without prior written approval of the Company. Any unauthorized alteration, forgery or falsification of the content or appearance of this document is unlawful and offenders may be prosecuted to the fullest extent of the law.

Band77-Part27\_60MHz\_DFT\_s\_OFDM\_SCS30kHz\_BPSK\_RB162\_0\_CH632000

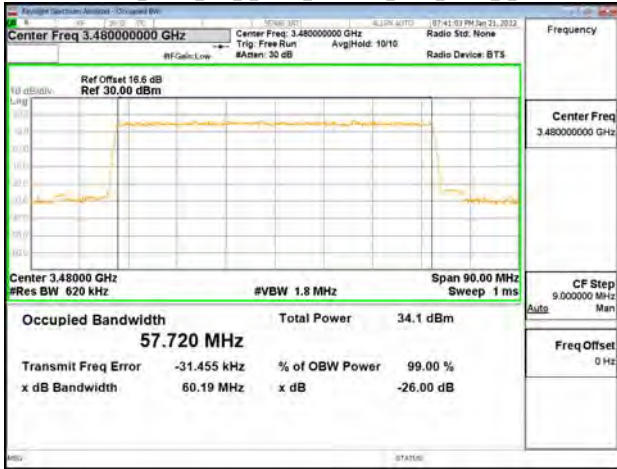

Band77-Part27\_60MHz\_DFT\_s\_OFDM\_SCS30kHz\_QPSK\_RB162\_0\_CH632000

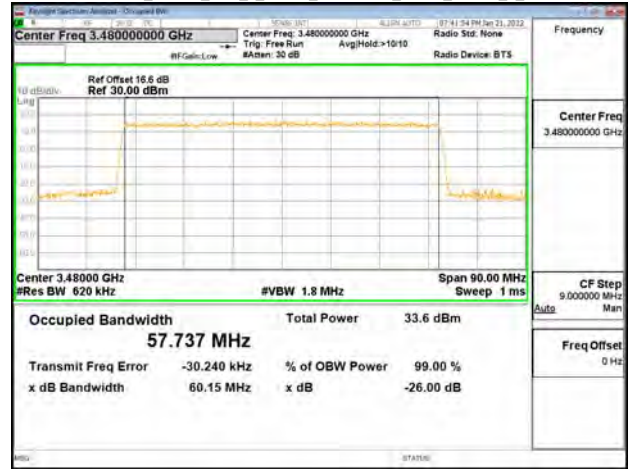

Band77-Part27\_60MHz\_DFT\_s\_OFDM\_SCS30kHz\_BPSK\_RB162\_0\_CH633334

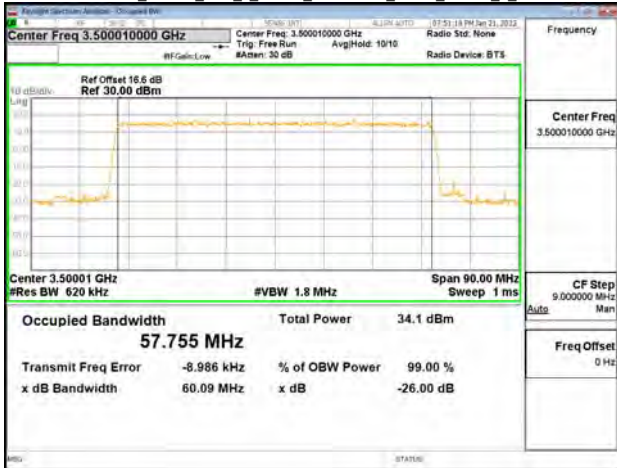

Band77-Part27\_60MHz\_DFT\_s\_OFDM\_SCS30kHz\_QPSK\_RB162\_0\_CH633334



Band77-Part27\_60MHz\_DFT\_s\_OFDM\_SCS30kHz\_BPSK\_RB162\_0\_CH634666

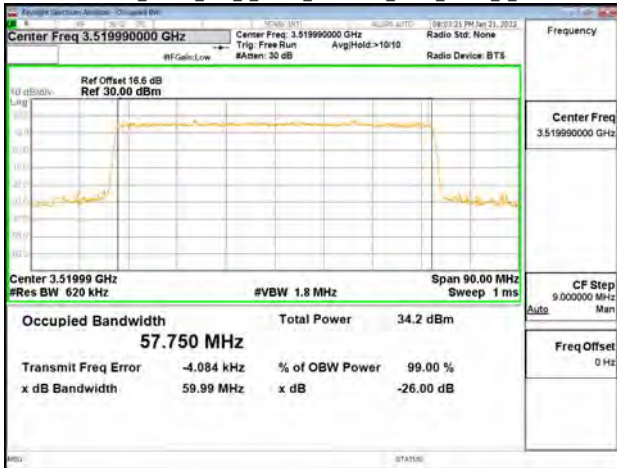

Band77-Part27\_60MHz\_DFT\_s\_OFDM\_SCS30kHz\_QPSK\_RB162\_0\_CH634666

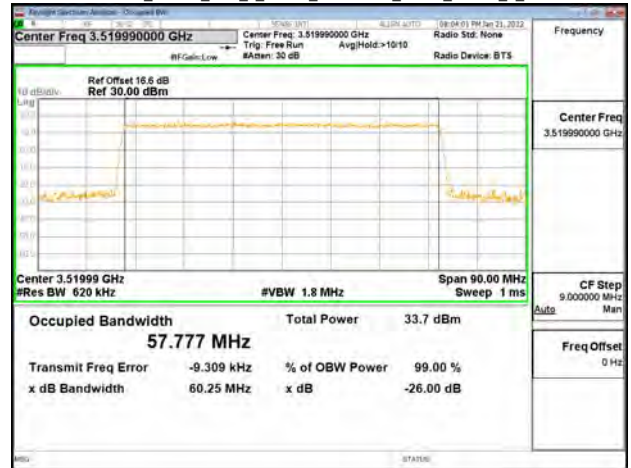

Unless otherwise stated the results shown in this test report refer only to the sample(s) tested and such sample(s) are retained for 90 days only.

除非另有說明，此報告結果僅對測試之樣品負責，同時此樣品僅保留90天。本報告未經本公司書面許可，不可部份複製。

This document is issued by the Company subject to its General Conditions of Service printed overleaf, available on request or accessible at <http://www.sgs.com.tw/Terms-and-Conditions> and for electronic format documents, subject to Terms and Conditions for Electronic Documents at <http://www.sgs.com.tw/Terms-and-Conditions>. Attention is drawn to the limitation of liability, indemnification and jurisdiction issues defined therein. Any holder of this document is advised that information contained hereon reflects the Company's findings at the time of its intervention only and within the limits of Client's instructions, if any. The Company's sole responsibility is to its Client and this document does not exonerate parties to a transaction from exercising all their rights and obligations under the transaction documents. This document cannot be reproduced except in full, without prior written approval of the Company. Any unauthorized alteration, forgery or falsification of the content or appearance of this document is unlawful and offenders may be prosecuted to the fullest extent of the law.

Band77-Part27\_60MHz\_DFT\_s\_OFDM\_SCS30kHz\_16QAM\_RB162\_0\_CH632000

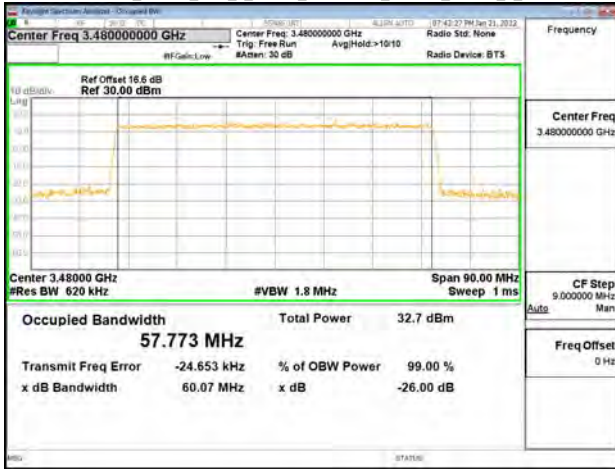

Band77-Part27\_60MHz\_DFT\_s\_OFDM\_SCS30kHz\_64QAM\_RB162\_0\_CH632000

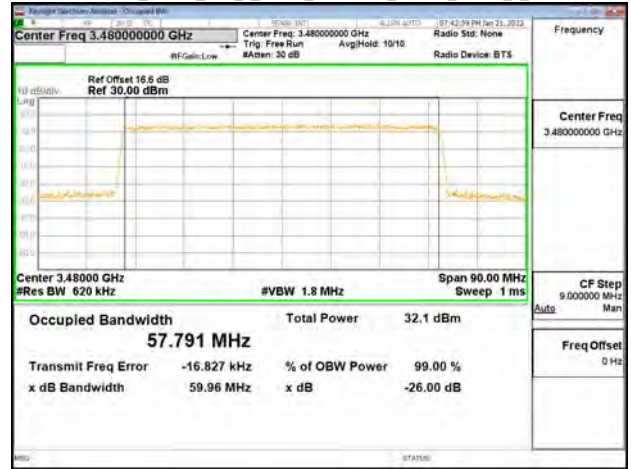

Band77-Part27\_60MHz\_DFT\_s\_OFDM\_SCS30kHz\_16QAM\_RB162\_0\_CH633334



Band77-Part27\_60MHz\_DFT\_s\_OFDM\_SCS30kHz\_64QAM\_RB162\_0\_CH633334

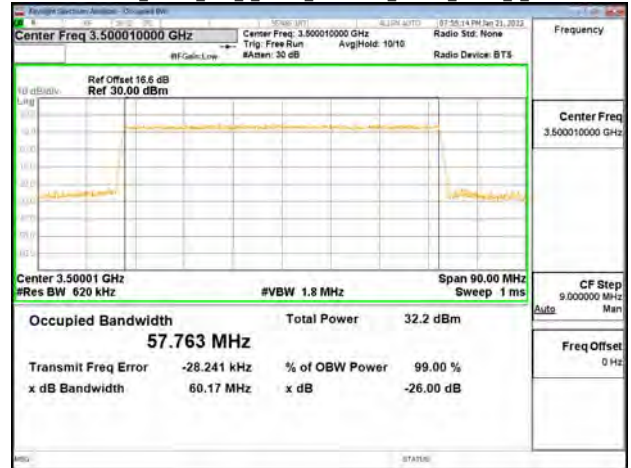

Band77-Part27\_60MHz\_DFT\_s\_OFDM\_SCS30kHz\_16QAM\_RB162\_0\_CH634666

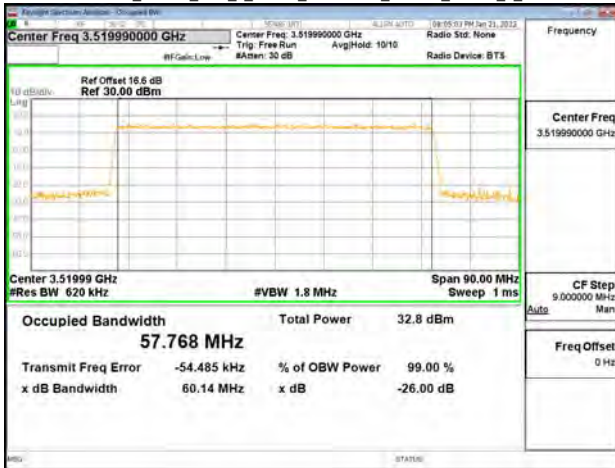

Band77-Part27\_60MHz\_DFT\_s\_OFDM\_SCS30kHz\_64QAM\_RB162\_0\_CH634666

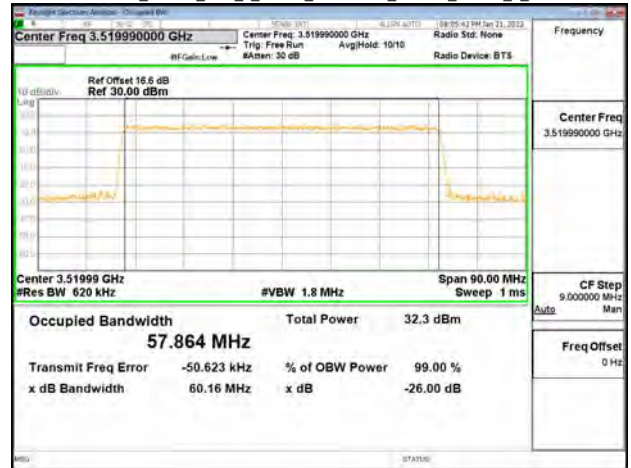

Unless otherwise stated the results shown in this test report refer only to the sample(s) tested and such sample(s) are retained for 90 days only.

除非另有說明，此報告結果僅對測試之樣品負責，同時此樣品僅保留90天。本報告未經本公司書面許可，不可部份複製。  
This document is issued by the Company subject to its General Conditions of Service printed overleaf, available on request or accessible at <http://www.sgs.com.tw/Terms-and-Conditions> and for electronic format documents, subject to Terms and Conditions for Electronic Documents at <http://www.sgs.com.tw/Terms-and-Conditions>. Attention is drawn to the limitation of liability, indemnification and jurisdiction issues defined therein. Any holder of this document is advised that information contained hereon reflects the Company's findings at the time of its intervention only and within the limits of Client's instructions, if any. The Company's sole responsibility is to its Client and this document does not exonerate parties to a transaction from exercising all their rights and obligations under the transaction documents. This document cannot be reproduced except in full, without prior written approval of the Company. Any unauthorized alteration, forgery or falsification of the content or appearance of this document is unlawful and offenders may be prosecuted to the fullest extent of the law.

Band77-Part27\_60MHz\_DFT\_s\_OFDM\_SCS30kHz\_256QAM\_RB162\_0\_CH632000

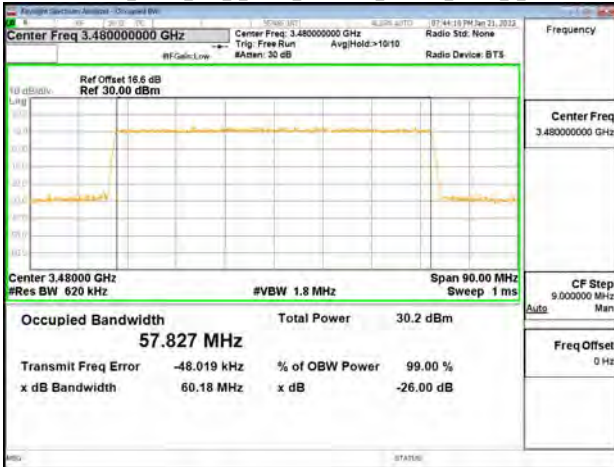

Band77-Part27\_70MHz\_DFT\_s\_OFDM\_SCS30kHz\_BPSK\_RB180\_0\_CH632334

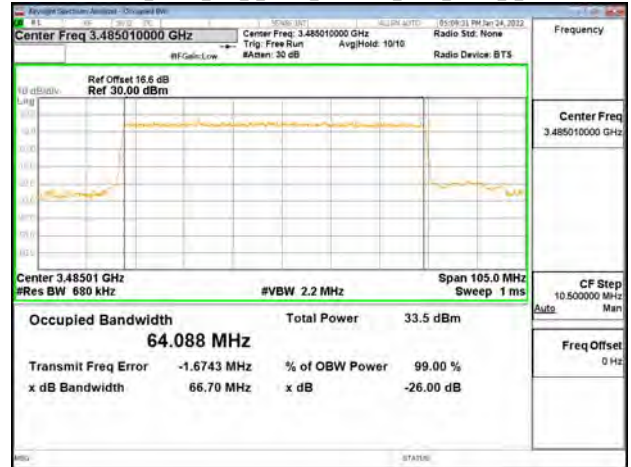

Band77-Part27\_60MHz\_DFT\_s\_OFDM\_SCS30kHz\_256QAM\_RB162\_0\_CH633334



Band77-Part27\_70MHz\_DFT\_s\_OFDM\_SCS30kHz\_BPSK\_RB180\_0\_CH633334

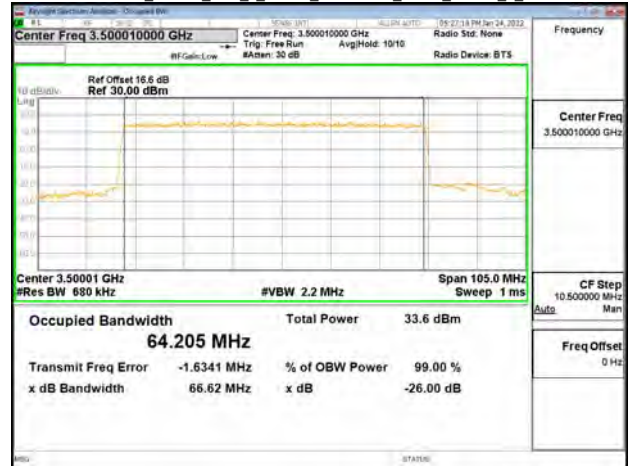

Band77-Part27\_60MHz\_DFT\_s\_OFDM\_SCS30kHz\_256QAM\_RB162\_0\_CH634666

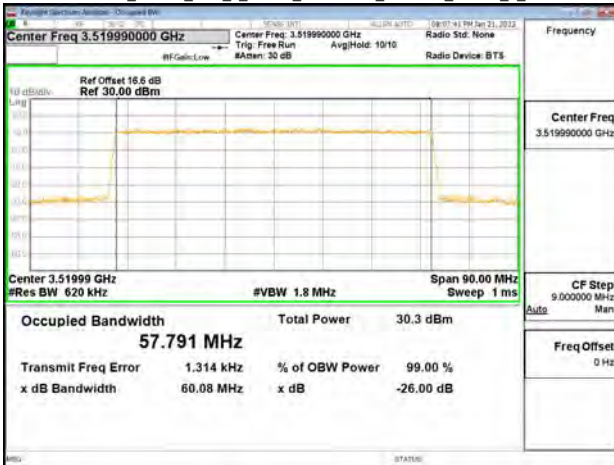

Band77-Part27\_70MHz\_DFT\_s\_OFDM\_SCS30kHz\_BPSK\_RB180\_0\_CH634332



Unless otherwise stated, the results shown in this test report refer only to the sample(s) tested and such sample(s) are retained for 90 days only.

除非另有說明，此報告結果僅對測試之樣品負責，同時此樣品僅保留90天。本報告未經本公司書面許可，不可部份複製。

This document is issued by the Company subject to its General Conditions of Service printed overleaf, available on request or accessible at <http://www.sgs.com.tw/Terms-and-Conditions> and for electronic format documents, subject to Terms and Conditions for Electronic Documents at <http://www.sgs.com.tw/Terms-and-Conditions>. Attention is drawn to the limitation of liability, indemnification and jurisdiction issues defined therein. Any holder of this document is advised that information contained hereon reflects the Company's findings at the time of its intervention only and within the limits of Client's instructions, if any. The Company's sole responsibility is to its Client and this document does not exonerate parties to a transaction from exercising all their rights and obligations under the transaction documents. This document cannot be reproduced except in full, without prior written approval of the Company. Any unauthorized alteration, forgery or falsification of the content or appearance of this document is unlawful and offenders may be prosecuted to the fullest extent of the law.



Band77-Part27\_70MHz\_DFT\_s\_OFDM\_SCS30kHz\_QPSK\_RB180\_0\_CH632334

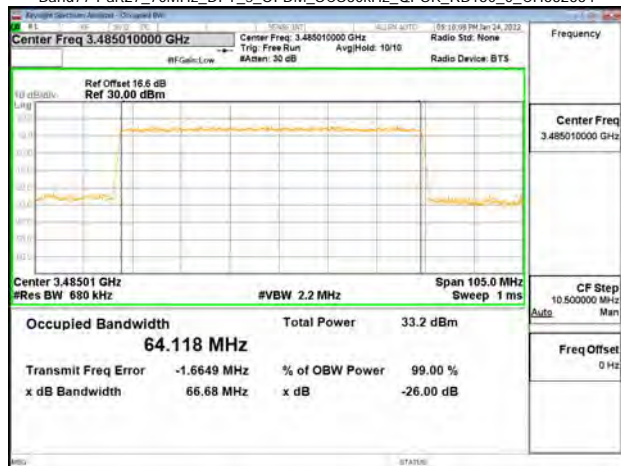

Band77-Part27\_70MHz\_DFT\_s\_OFDM\_SCS30kHz\_16QAM\_RB180\_0\_CH632334

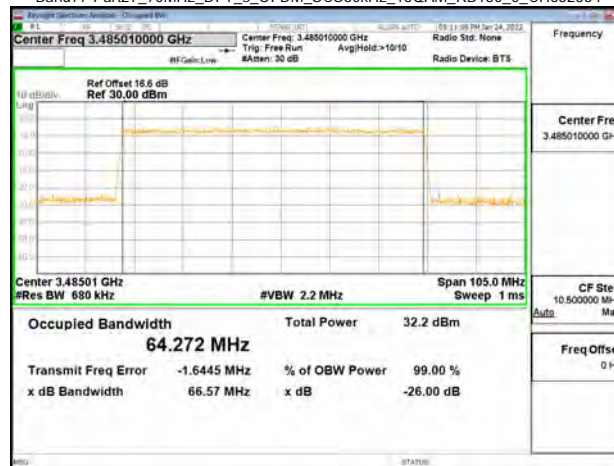

Band77-Part27\_70MHz\_DFT\_s\_OFDM\_SCS30kHz\_QPSK\_RB180\_0\_CH633334



Band77-Part27\_70MHz\_DFT\_s\_OFDM\_SCS30kHz\_16QAM\_RB180\_0\_CH633334



Band77-Part27\_70MHz\_DFT\_s\_OFDM\_SCS30kHz\_QPSK\_RB180\_0\_CH634332

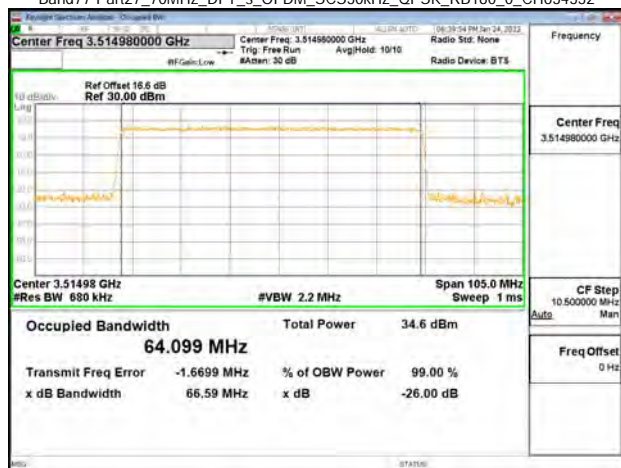

Band77-Part27\_70MHz\_DFT\_s\_OFDM\_SCS30kHz\_16QAM\_RB180\_0\_CH634332



Unless otherwise stated the results shown in this test report refer only to the sample(s) tested and such sample(s) are retained for 90 days only.

除非另有說明，此報告結果僅對測試之樣品負責，同時此樣品僅保留90天。本報告未經本公司書面許可，不可部份複製。

This document is issued by the Company subject to its General Conditions of Service printed overleaf, available on request or accessible at <http://www.sgs.com.tw/Terms-and-Conditions> and for electronic format documents, subject to Terms and Conditions for Electronic Documents at <http://www.sgs.com.tw/Terms-and-Conditions>. Attention is drawn to the limitation of liability, indemnification and jurisdiction issues defined therein. Any holder of this document is advised that information contained hereon reflects the Company's findings at the time of its intervention only and within the limits of Client's instructions, if any. The Company's sole responsibility is to its Client and this document does not exonerate parties to a transaction from exercising all their rights and obligations under the transaction documents. This document cannot be reproduced except in full, without prior written approval of the Company. Any unauthorized alteration, forgery or falsification of the content or appearance of this document is unlawful and offenders may be prosecuted to the fullest extent of the law.

Band77-Part27\_70MHz\_DFT\_s\_OFDM\_SCS30kHz\_64QAM\_RB180\_0\_CH632334

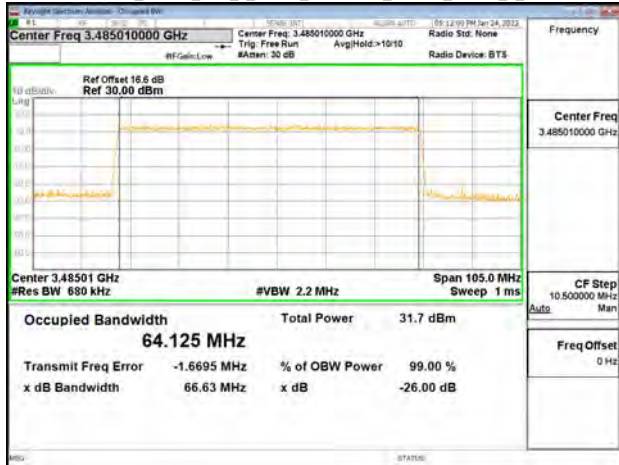

Band77-Part27\_70MHz\_DFT\_s\_OFDM\_SCS30kHz\_256QAM\_RB180\_0\_CH632334



Band77-Part27\_70MHz\_DFT\_s\_OFDM\_SCS30kHz\_64QAM\_RB180\_0\_CH633334

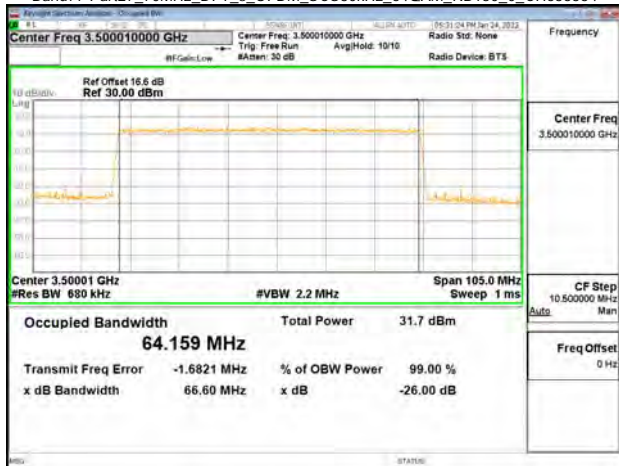

Band77-Part27\_70MHz\_DFT\_s\_OFDM\_SCS30kHz\_256QAM\_RB180\_0\_CH633334



Band77-Part27\_70MHz\_DFT\_s\_OFDM\_SCS30kHz\_64QAM\_RB180\_0\_CH634332



Band77-Part27\_70MHz\_DFT\_s\_OFDM\_SCS30kHz\_256QAM\_RB180\_0\_CH634332

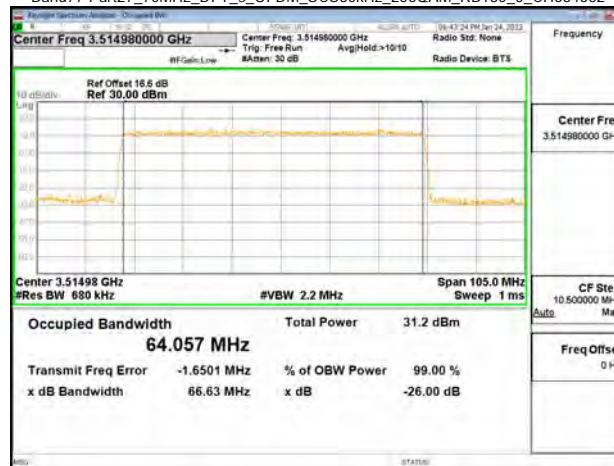

Unless otherwise stated the results shown in this test report refer only to the sample(s) tested and such sample(s) are retained for 90 days only.

除非另有說明，此報告結果僅對測試之樣品負責，同時此樣品僅保留90天。本報告未經本公司書面許可，不可部份複製。

This document is issued by the Company subject to its General Conditions of Service printed overleaf, available on request or accessible at <http://www.sgs.com.tw/Terms-and-Conditions> and for electronic format documents, subject to Terms and Conditions for Electronic Documents at <http://www.sgs.com.tw/Terms-and-Conditions>. Attention is drawn to the limitation of liability, indemnification and jurisdiction issues defined therein. Any holder of this document is advised that information contained hereon reflects the Company's findings at the time of its intervention only and within the limits of Client's instructions, if any. The Company's sole responsibility is to its Client and this document does not exonerate parties to a transaction from exercising all their rights and obligations under the transaction documents. This document cannot be reproduced except in full, without prior written approval of the Company. Any unauthorized alteration, forgery or falsification of the content or appearance of this document is unlawful and offenders may be prosecuted to the fullest extent of the law.

Band77-Part27\_80MHz\_DFT\_s\_OFDM\_SCS30kHz\_BPSK\_RB216\_0\_CH632668

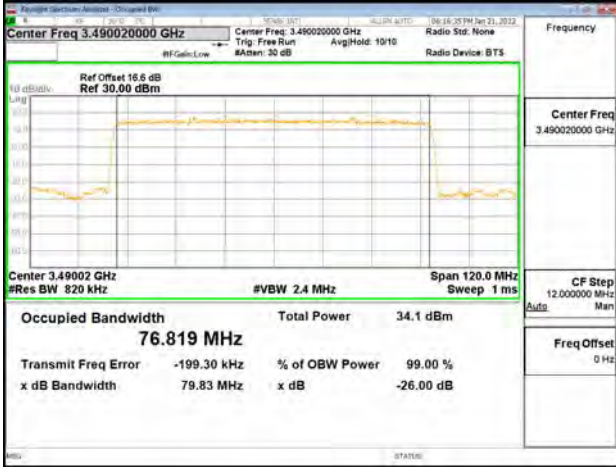

Band77-Part27\_80MHz\_DFT\_s\_OFDM\_SCS30kHz\_QPSK\_RB216\_0\_CH632668

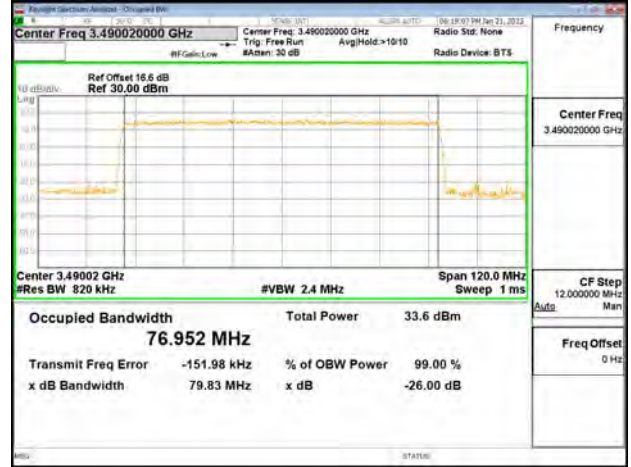

Band77-Part27\_80MHz\_DFT\_s\_OFDM\_SCS30kHz\_BPSK\_RB216\_0\_CH633334

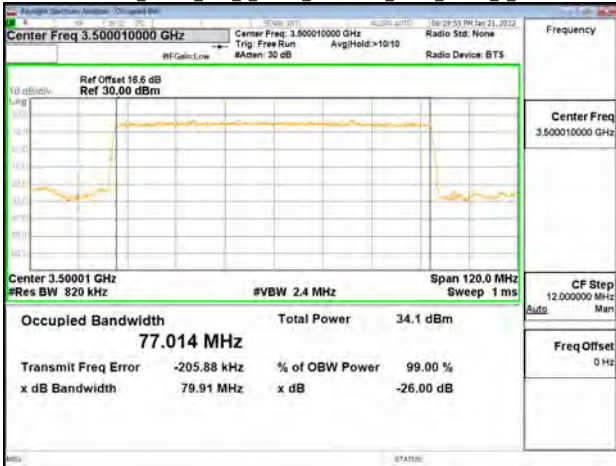

Band77-Part27\_80MHz\_DFT\_s\_OFDM\_SCS30kHz\_QPSK\_RB216\_0\_CH633334



Band77-Part27\_80MHz\_DFT\_s\_OFDM\_SCS30kHz\_BPSK\_RB216\_0\_CH634000



Band77-Part27\_80MHz\_DFT\_s\_OFDM\_SCS30kHz\_QPSK\_RB216\_0\_CH634000



Unless otherwise stated the results shown in this test report refer only to the sample(s) tested and such sample(s) are retained for 90 days only.

除非另有說明，此報告結果僅對測試之樣品負責，同時此樣品僅保留90天。本報告未經本公司書面許可，不可部份複製。

This document is issued by the Company subject to its General Conditions of Service printed overleaf, available on request or accessible at <http://www.sgs.com.tw/Terms-and-Conditions> and for electronic format documents, subject to Terms and Conditions for Electronic Documents at <http://www.sgs.com.tw/Terms-and-Conditions>. Attention is drawn to the limitation of liability, indemnification and jurisdiction issues defined therein. Any holder of this document is advised that information contained hereon reflects the Company's findings at the time of its intervention only and within the limits of Client's instructions, if any. The Company's sole responsibility is to its Client and this document does not exonerate parties to a transaction from exercising all their rights and obligations under the transaction documents. This document cannot be reproduced except in full, without prior written approval of the Company. Any unauthorized alteration, forgery or falsification of the content or appearance of this document is unlawful and offenders may be prosecuted to the fullest extent of the law.

Band77-Part27\_80MHz\_DFT\_s\_OFDM\_SCS30kHz\_16QAM\_RB216\_0\_CH632668

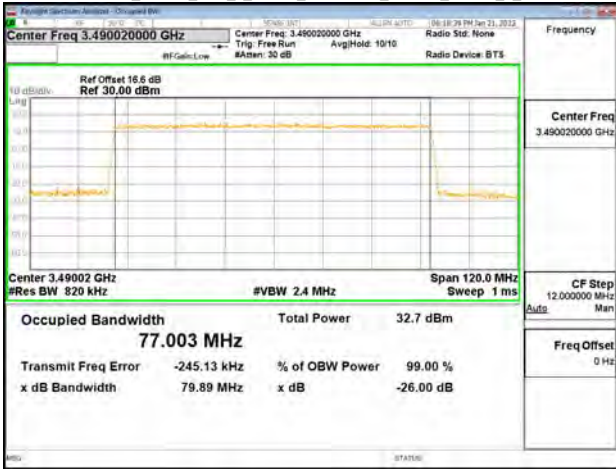

Band77-Part27\_80MHz\_DFT\_s\_OFDM\_SCS30kHz\_64QAM\_RB216\_0\_CH632668

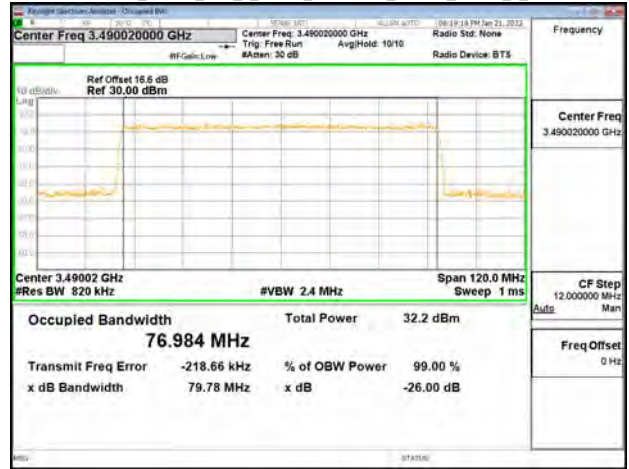

Band77-Part27\_80MHz\_DFT\_s\_OFDM\_SCS30kHz\_16QAM\_RB216\_0\_CH633334

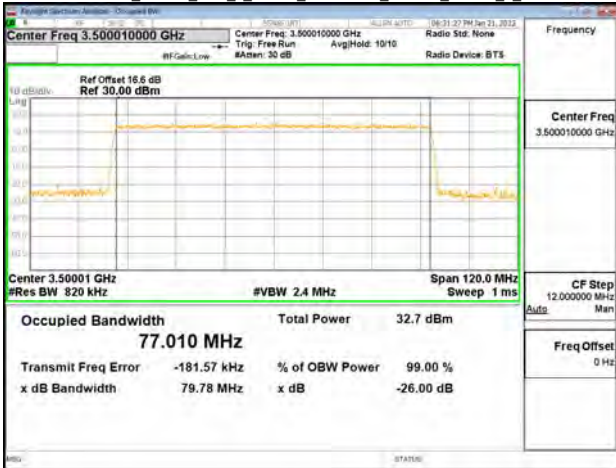

Band77-Part27\_80MHz\_DFT\_s\_OFDM\_SCS30kHz\_64QAM\_RB216\_0\_CH633334



Band77-Part27\_80MHz\_DFT\_s\_OFDM\_SCS30kHz\_16QAM\_RB216\_0\_CH634000



Band77-Part27\_80MHz\_DFT\_s\_OFDM\_SCS30kHz\_64QAM\_RB216\_0\_CH634000



Unless otherwise stated the results shown in this test report refer only to the sample(s) tested and such sample(s) are retained for 90 days only.

除非另有說明，此報告結果僅對測試之樣品負責，同時此樣品僅保留90天。本報告未經本公司書面許可，不可部份複製。

This document is issued by the Company subject to its General Conditions of Service printed overleaf, available on request or accessible at <http://www.sgs.com.tw/Terms-and-Conditions> and for electronic format documents, subject to Terms and Conditions for Electronic Documents at <http://www.sgs.com.tw/Terms-and-Conditions>. Attention is drawn to the limitation of liability, indemnification and jurisdiction issues defined therein. Any holder of this document is advised that information contained hereon reflects the Company's findings at the time of its intervention only and within the limits of Client's instructions, if any. The Company's sole responsibility is to its Client and this document does not exonerate parties to a transaction from exercising all their rights and obligations under the transaction documents. This document cannot be reproduced except in full, without prior written approval of the Company. Any unauthorized alteration, forgery or falsification of the content or appearance of this document is unlawful and offenders may be prosecuted to the fullest extent of the law.

Band77-Part27\_80MHz\_DFT\_s\_OFDM\_SCS30kHz\_256QAM\_RB216\_0\_CH632668

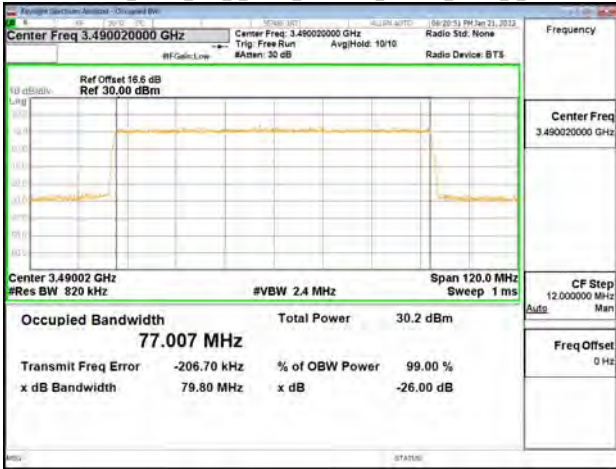

Band77-Part27\_90MHz\_DFT\_s\_OFDM\_SCS30kHz\_BPSK\_RB243\_0\_CH633000

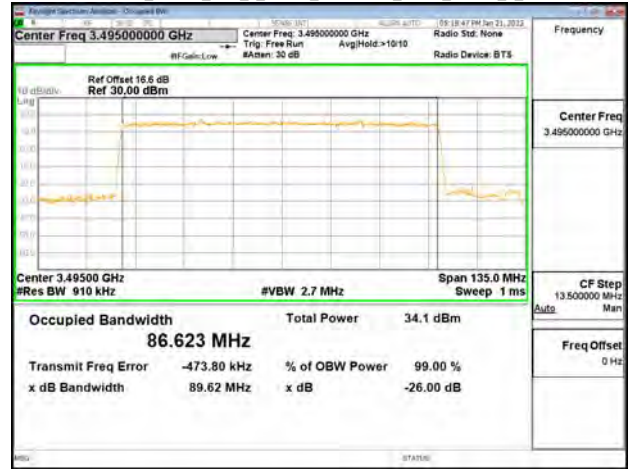

Band77-Part27\_80MHz\_DFT\_s\_OFDM\_SCS30kHz\_256QAM\_RB216\_0\_CH633334



Band77-Part27\_90MHz\_DFT\_s\_OFDM\_SCS30kHz\_BPSK\_RB243\_0\_CH633334

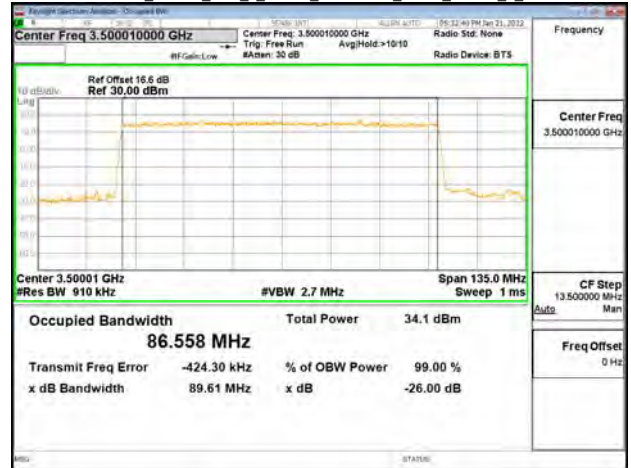

Band77-Part27\_80MHz\_DFT\_s\_OFDM\_SCS30kHz\_256QAM\_RB216\_0\_CH634000

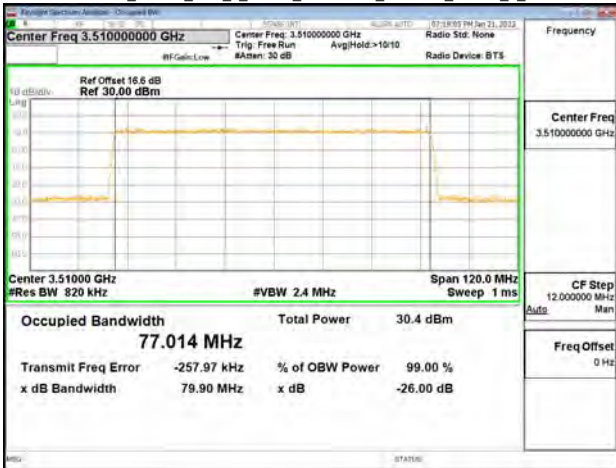

Band77-Part27\_90MHz\_DFT\_s\_OFDM\_SCS30kHz\_BPSK\_RB243\_0\_CH633666

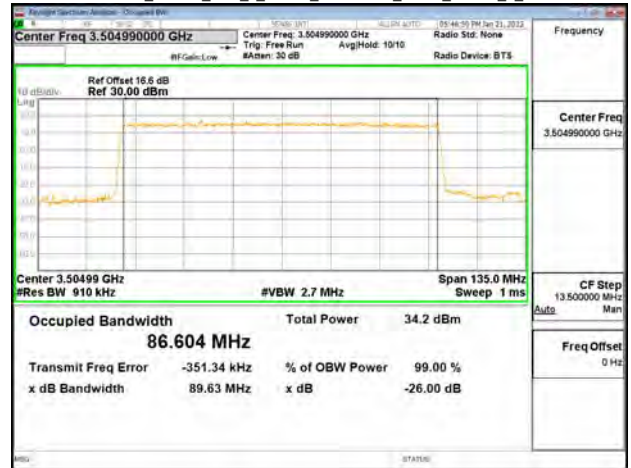

Unless otherwise stated the results shown in this test report refer only to the sample(s) tested and such sample(s) are retained for 90 days only.

除非另有說明，此報告結果僅對測試之樣品負責，同時此樣品僅保留90天。本報告未經本公司書面許可，不可部份複製。

This document is issued by the Company subject to its General Conditions of Service printed overleaf, available on request or accessible at <http://www.sgs.com.tw/Terms-and-Conditions> and for electronic format documents, subject to Terms and Conditions for Electronic Documents at <http://www.sgs.com.tw/Terms-and-Conditions>. Attention is drawn to the limitation of liability, indemnification and jurisdiction issues defined therein. Any holder of this document is advised that information contained hereon reflects the Company's findings at the time of its intervention only and within the limits of Client's instructions, if any. The Company's sole responsibility is to its Client and this document does not exonerate parties to a transaction from exercising all their rights and obligations under the transaction documents. This document cannot be reproduced except in full, without prior written approval of the Company. Any unauthorized alteration, forgery or falsification of the content or appearance of this document is unlawful and offenders may be prosecuted to the fullest extent of the law.

Band77-Part27\_90MHz\_DFT\_s\_OFDM\_SCS30kHz\_QPSK\_RB243\_0\_CH633000



Band77-Part27\_90MHz\_DFT\_s\_OFDM\_SCS30kHz\_16QAM\_RB243\_0\_CH633000

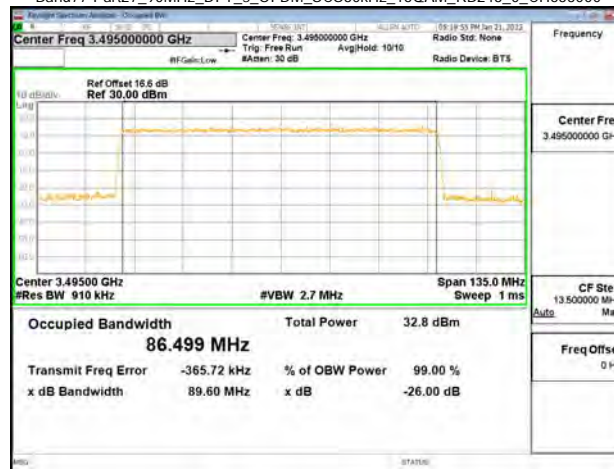

Band77-Part27\_90MHz\_DFT\_s\_OFDM\_SCS30kHz\_QPSK\_RB243\_0\_CH633334



Band77-Part27\_90MHz\_DFT\_s\_OFDM\_SCS30kHz\_16QAM\_RB243\_0\_CH633334

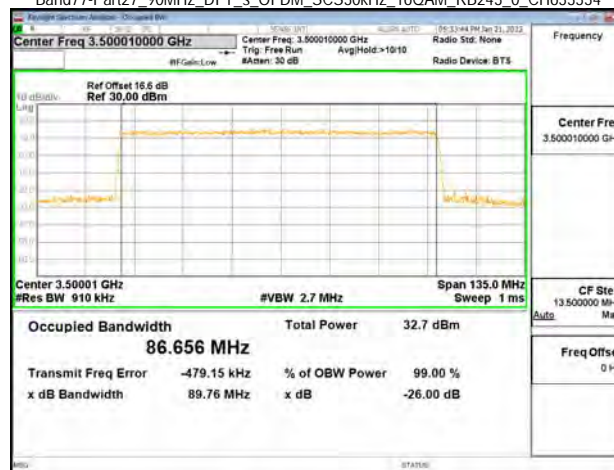

Band77-Part27\_90MHz\_DFT\_s\_OFDM\_SCS30kHz\_QPSK\_RB243\_0\_CH633666

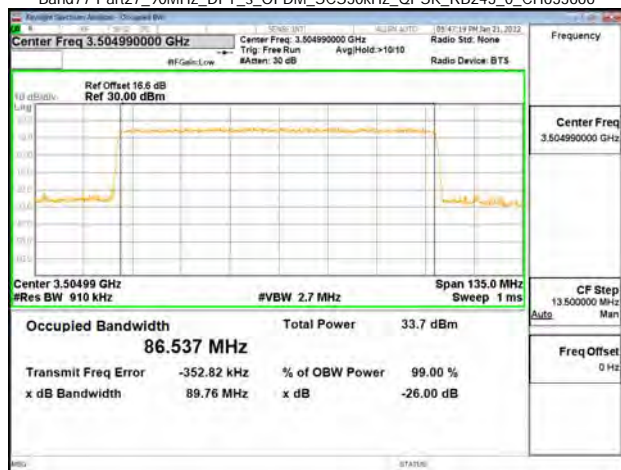

Band77-Part27\_90MHz\_DFT\_s\_OFDM\_SCS30kHz\_16QAM\_RB243\_0\_CH633666



Unless otherwise stated the results shown in this test report refer only to the sample(s) tested and such sample(s) are retained for 90 days only.

除非另有說明，此報告結果僅對測試之樣品負責，同時此樣品僅保留90天。本報告未經本公司書面許可，不可部份複製。

This document is issued by the Company subject to its General Conditions of Service printed overleaf, available on request or accessible at <http://www.sgs.com.tw/Terms-and-Conditions> and for electronic format documents, subject to Terms and Conditions for Electronic Documents at <http://www.sgs.com.tw/Terms-and-Conditions>. Attention is drawn to the limitation of liability, indemnification and jurisdiction issues defined therein. Any holder of this document is advised that information contained hereon reflects the Company's findings at the time of its intervention only and within the limits of Client's instructions, if any. The Company's sole responsibility is to its Client and this document does not exonerate parties to a transaction from exercising all their rights and obligations under the transaction documents. This document cannot be reproduced except in full, without prior written approval of the Company. Any unauthorized alteration, forgery or falsification of the content or appearance of this document is unlawful and offenders may be prosecuted to the fullest extent of the law.

Band77-Part27\_90MHz\_DFT\_s\_OFDM\_SCS30kHz\_64QAM\_RB243\_0\_CH633000

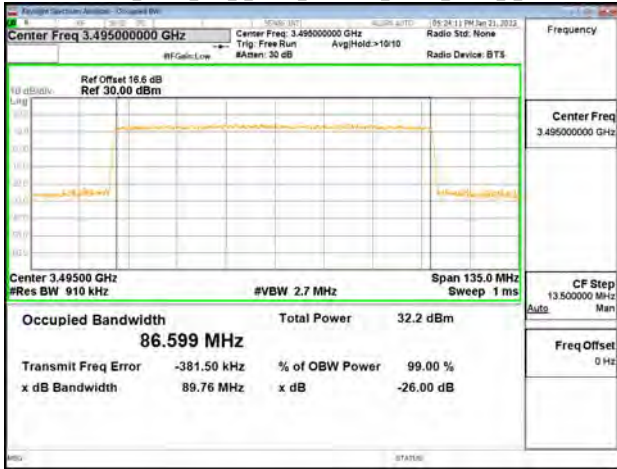

Band77-Part27\_90MHz\_DFT\_s\_OFDM\_SCS30kHz\_256QAM\_RB243\_0\_CH633000

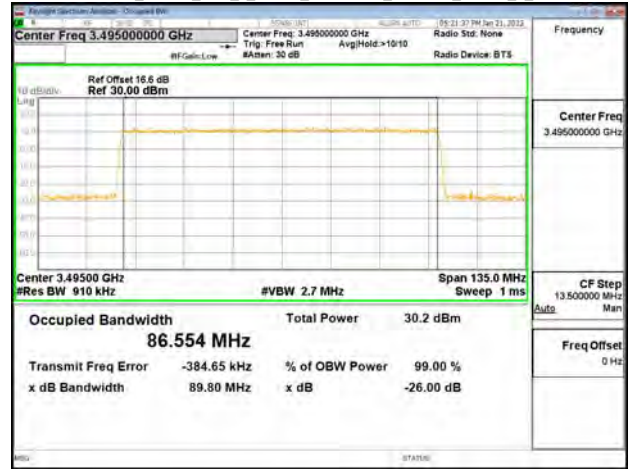

Band77-Part27\_90MHz\_DFT\_s\_OFDM\_SCS30kHz\_64QAM\_RB243\_0\_CH633334

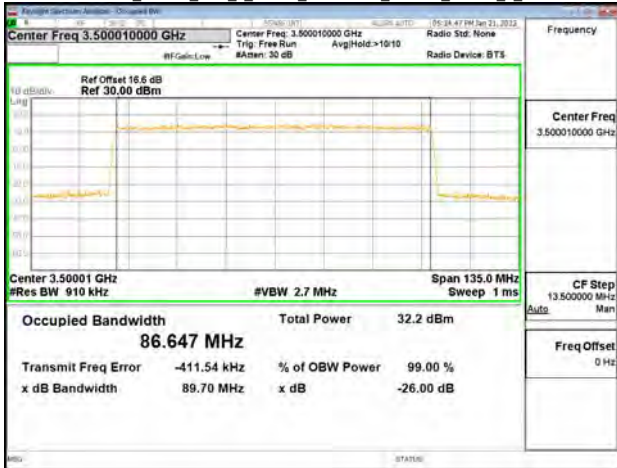

Band77-Part27\_90MHz\_DFT\_s\_OFDM\_SCS30kHz\_256QAM\_RB243\_0\_CH633334



Band77-Part27\_90MHz\_DFT\_s\_OFDM\_SCS30kHz\_64QAM\_RB243\_0\_CH633666



Band77-Part27\_90MHz\_DFT\_s\_OFDM\_SCS30kHz\_256QAM\_RB243\_0\_CH633666



Unless otherwise stated the results shown in this test report refer only to the sample(s) tested and such sample(s) are retained for 90 days only.

除非另有說明，此報告結果僅對測試之樣品負責，同時此樣品僅保留90天。本報告未經本公司書面許可，不可部份複製。

This document is issued by the Company subject to its General Conditions of Service printed overleaf, available on request or accessible at <http://www.sgs.com.tw/Terms-and-Conditions> and for electronic format documents, subject to Terms and Conditions for Electronic Documents at <http://www.sgs.com.tw/Terms-and-Conditions>. Attention is drawn to the limitation of liability, indemnification and jurisdiction issues defined therein. Any holder of this document is advised that information contained hereon reflects the Company's findings at the time of its intervention only and within the limits of Client's instructions, if any. The Company's sole responsibility is to its Client and this document does not exonerate parties to a transaction from exercising all their rights and obligations under the transaction documents. This document cannot be reproduced except in full, without prior written approval of the Company. Any unauthorized alteration, forgery or falsification of the content or appearance of this document is unlawful and offenders may be prosecuted to the fullest extent of the law.

Band77-Part27\_100MHz\_DFT\_s\_OFDM\_SCS30kHz\_BPSK\_RB270\_0\_CH633334

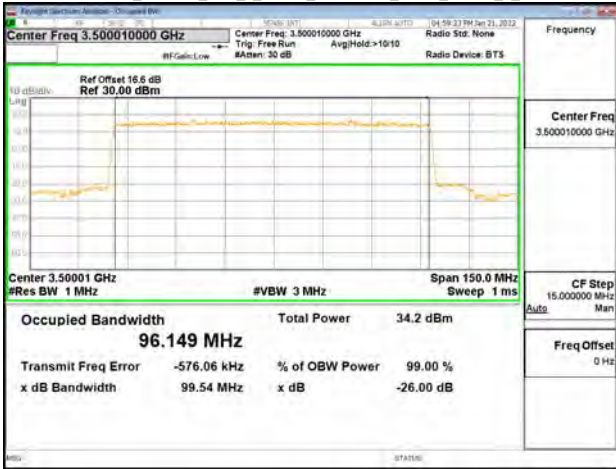

Band77-Part27\_100MHz\_DFT\_s\_OFDM\_SCS30kHz\_64QAM\_RB270\_0\_CH633334

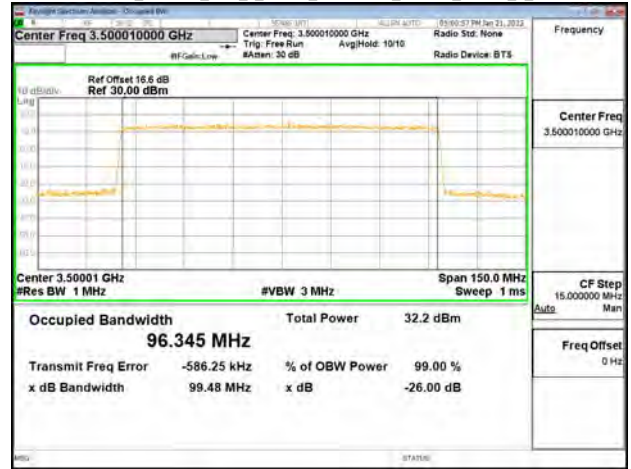

Band77-Part27\_100MHz\_DFT\_s\_OFDM\_SCS30kHz\_QPSK\_RB270\_0\_CH633334

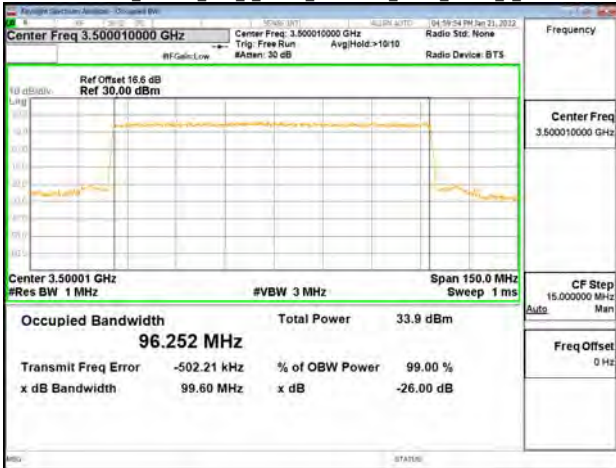

Band77-Part27\_100MHz\_DFT\_s\_OFDM\_SCS30kHz\_256QAM\_RB270\_0\_CH633334

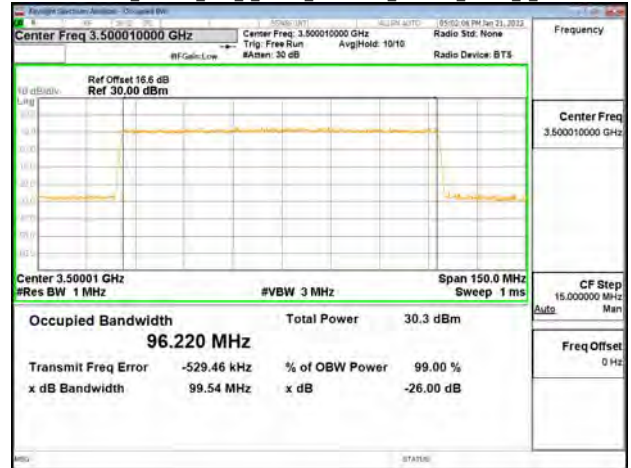

Band77-Part27\_100MHz\_DFT\_s\_OFDM\_SCS30kHz\_16QAM\_RB270\_0\_CH633334

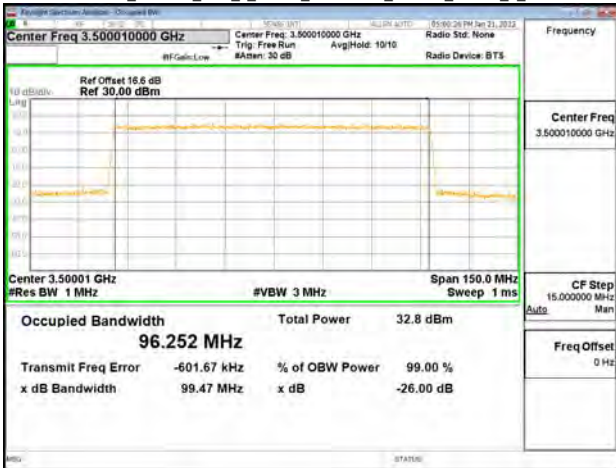

Band77-Part27\_20MHz\_DFT\_s\_OFDM\_SCS30kHz\_BPSK\_RB50\_0\_CH647334



Unless otherwise stated the results shown in this test report refer only to the sample(s) tested and such sample(s) are retained for 90 days only.

除非另有說明，此報告結果僅對測試之樣品負責，同時此樣品僅保留90天。本報告未經本公司書面許可，不可部份複製。

This document is issued by the Company subject to its General Conditions of Service printed overleaf, available on request or accessible at <http://www.sgs.com.tw/Terms-and-Conditions> and for electronic format documents, subject to Terms and Conditions for Electronic Documents at <http://www.sgs.com.tw/Terms-and-Conditions>. Attention is drawn to the limitation of liability, indemnification and jurisdiction issues defined therein. Any holder of this document is advised that information contained hereon reflects the Company's findings at the time of its intervention only and within the limits of Client's instructions, if any. The Company's sole responsibility is to its Client and this document does not exonerate parties to a transaction from exercising all their rights and obligations under the transaction documents. This document cannot be reproduced except in full, without prior written approval of the Company. Any unauthorized alteration, forgery or falsification of the content or appearance of this document is unlawful and offenders may be prosecuted to the fullest extent of the law.



Band77-Part27\_20MHz\_DFT\_s\_OFDM\_SCS30kHz\_BPSK\_RB50\_0\_CH665000



Band77-Part27\_20MHz\_DFT\_s\_OFDM\_SCS30kHz\_QPSK\_RB50\_0\_CH665000



Band77-Part27\_20MHz\_DFT\_s\_OFDM\_SCS30kHz\_BPSK\_RB50\_0\_CH664666



Band77-Part27\_20MHz\_DFT\_s\_OFDM\_SCS30kHz\_QPSK\_RB50\_0\_CH664666



Band77-Part27\_20MHz\_DFT\_s\_OFDM\_SCS30kHz\_QPSK\_RB50\_0\_CH647334



Band77-Part27\_20MHz\_DFT\_s\_OFDM\_SCS30kHz\_16QAM\_RB50\_0\_CH647334



Unless otherwise stated the results shown in this test report refer only to the sample(s) tested and such sample(s) are retained for 90 days only.

除非另有說明，此報告結果僅對測試之樣品負責，同時此樣品僅保留90天。本報告未經本公司書面許可，不可部份複製。

This document is issued by the Company subject to its General Conditions of Service printed overleaf, available on request or accessible at <http://www.sgs.com.tw/Terms-and-Conditions> and for electronic format documents, subject to Terms and Conditions for Electronic Documents at <http://www.sgs.com.tw/Terms-and-Conditions>. Attention is drawn to the limitation of liability, indemnification and jurisdiction issues defined therein. Any holder of this document is advised that information contained hereon reflects the Company's findings at the time of its intervention only and within the limits of Client's instructions, if any. The Company's sole responsibility is to its Client and this document does not exonerate parties to a transaction from exercising all their rights and obligations under the transaction documents. This document cannot be reproduced except in full, without prior written approval of the Company. Any unauthorized alteration, forgery or falsification of the content or appearance of this document is unlawful and offenders may be prosecuted to the fullest extent of the law.

Band77-Part27\_20MHz\_DFT\_s\_OFDM\_SCS30kHz\_16QAM\_RB50\_0\_CH656000

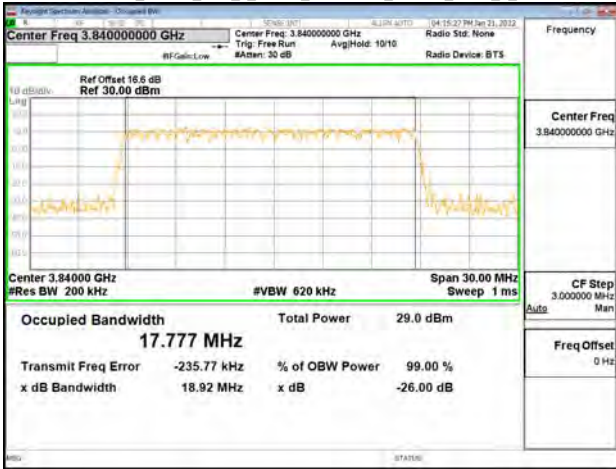

Band77-Part27\_20MHz\_DFT\_s\_OFDM\_SCS30kHz\_64QAM\_RB50\_0\_CH656000

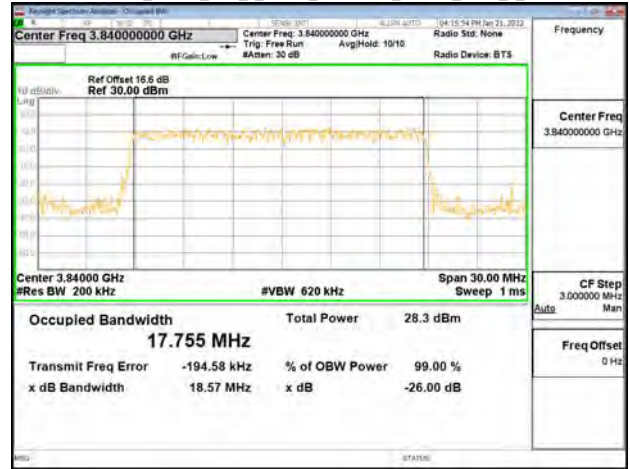

Band77-Part27\_20MHz\_DFT\_s\_OFDM\_SCS30kHz\_16QAM\_RB50\_0\_CH664666



Band77-Part27\_20MHz\_DFT\_s\_OFDM\_SCS30kHz\_64QAM\_RB50\_0\_CH664666



Band77-Part27\_20MHz\_DFT\_s\_OFDM\_SCS30kHz\_64QAM\_RB50\_0\_CH647334



Band77-Part27\_20MHz\_DFT\_s\_OFDM\_SCS30kHz\_256QAM\_RB50\_0\_CH647334

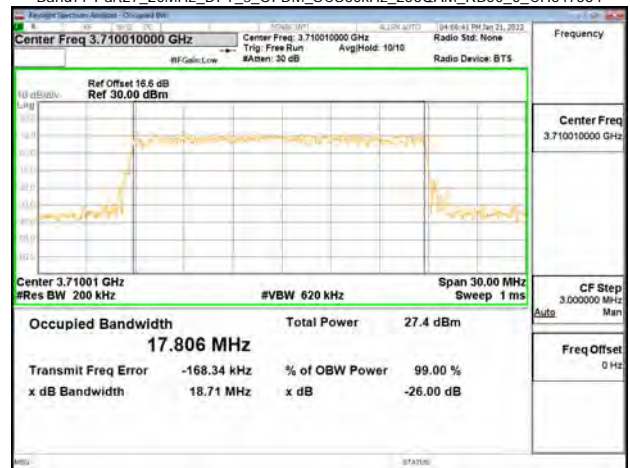

Unless otherwise stated the results shown in this test report refer only to the sample(s) tested and such sample(s) are retained for 90 days only.

除非另有說明，此報告結果僅對測試之樣品負責，同時此樣品僅保留90天。本報告未經本公司書面許可，不可部份複製。

This document is issued by the Company subject to its General Conditions of Service printed overleaf, available on request or accessible at <http://www.sgs.com.tw/Terms-and-Conditions> and for electronic format documents, subject to Terms and Conditions for Electronic Documents at <http://www.sgs.com.tw/Terms-and-Conditions>. Attention is drawn to the limitation of liability, indemnification and jurisdiction issues defined therein. Any holder of this document is advised that information contained hereon reflects the Company's findings at the time of its intervention only and within the limits of Client's instructions, if any. The Company's sole responsibility is to its Client and this document does not exonerate parties to a transaction from exercising all their rights and obligations under the transaction documents. This document cannot be reproduced except in full, without prior written approval of the Company. Any unauthorized alteration, forgery or falsification of the content or appearance of this document is unlawful and offenders may be prosecuted to the fullest extent of the law.





Band77-Part27\_30MHz\_DFT\_s\_OFDM\_SCS30kHz\_64QAM\_RB75\_0\_CH651000

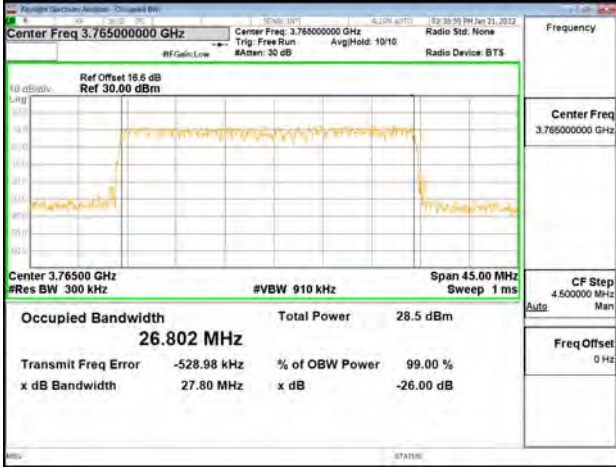

Band77-Part27\_30MHz\_DFT\_s\_OFDM\_SCS30kHz\_256QAM\_RB75\_0\_CH651000



Band77-Part27\_30MHz\_DFT\_s\_OFDM\_SCS30kHz\_64QAM\_RB75\_0\_CH656000

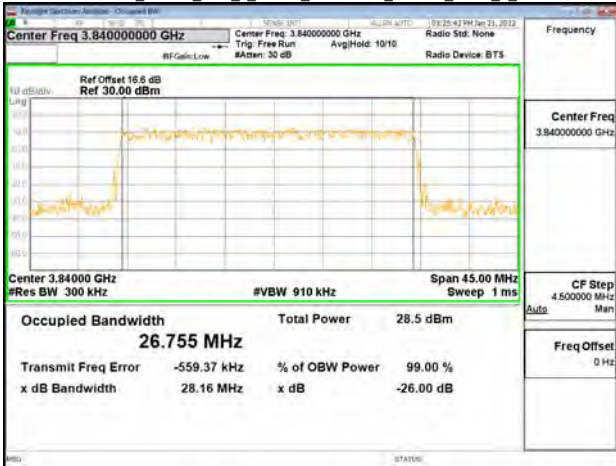

Band77-Part27\_30MHz\_DFT\_s\_OFDM\_SCS30kHz\_256QAM\_RB75\_0\_CH656000

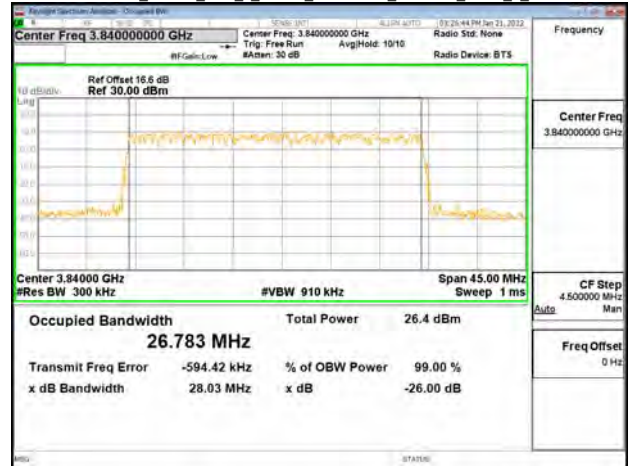

Band77-Part27\_30MHz\_DFT\_s\_OFDM\_SCS30kHz\_256QAM\_RB75\_0\_CH647668



Band77-Part27\_40MHz\_DFT\_s\_OFDM\_SCS30kHz\_BPSK\_RB100\_0\_CH648000



Unless otherwise stated the results shown in this test report refer only to the sample(s) tested and such sample(s) are retained for 90 days only.

除非另有說明，此報告結果僅對測試之樣品負責，同時此樣品僅保留90天。本報告未經本公司書面許可，不可部份複製。

This document is issued by the Company subject to its General Conditions of Service printed overleaf, available on request or accessible at <http://www.sgs.com.tw/Terms-and-Conditions> and for electronic format documents, subject to Terms and Conditions for Electronic Documents at <http://www.sgs.com.tw/Terms-and-Conditions>. Attention is drawn to the limitation of liability, indemnification and jurisdiction issues defined therein. Any holder of this document is advised that information contained hereon reflects the Company's findings at the time of its intervention only and within the limits of Client's instructions, if any. The Company's sole responsibility is to its Client and this document does not exonerate parties to a transaction from exercising all their rights and obligations under the transaction documents. This document cannot be reproduced except in full, without prior written approval of the Company. Any unauthorized alteration, forgery or falsification of the content or appearance of this document is unlawful and offenders may be prosecuted to the fullest extent of the law.



Band77-Part27\_40MHz\_DFT\_s\_OFDM\_SCS30kHz\_16QAM\_RB100\_0\_CH656000

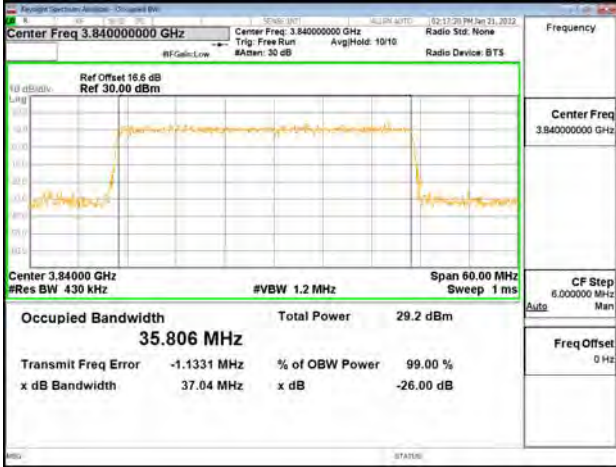

Band77-Part27\_40MHz\_DFT\_s\_OFDM\_SCS30kHz\_64QAM\_RB100\_0\_CH656000



Band77-Part27\_40MHz\_DFT\_s\_OFDM\_SCS30kHz\_16QAM\_RB100\_0\_CH664000



Band77-Part27\_40MHz\_DFT\_s\_OFDM\_SCS30kHz\_64QAM\_RB100\_0\_CH664000



Band77-Part27\_40MHz\_DFT\_s\_OFDM\_SCS30kHz\_64QAM\_RB100\_0\_CH648000



Band77-Part27\_40MHz\_DFT\_s\_OFDM\_SCS30kHz\_256QAM\_RB100\_0\_CH648000



Unless otherwise stated the results shown in this test report refer only to the sample(s) tested and such sample(s) are retained for 90 days only.

除非另有說明，此報告結果僅對測試之樣品負責，同時此樣品僅保留90天。本報告未經本公司書面許可，不可部份複製。  
This document is issued by the Company subject to its General Conditions of Service printed overleaf, available on request or accessible at <http://www.sgs.com.tw/Terms-and-Conditions> and for electronic format documents, subject to Terms and Conditions for Electronic Documents at <http://www.sgs.com.tw/Terms-and-Conditions>. Attention is drawn to the limitation of liability, indemnification and jurisdiction issues defined therein. Any holder of this document is advised that information contained hereon reflects the Company's findings at the time of its intervention only and within the limits of Client's instructions, if any. The Company's sole responsibility is to its Client and this document does not exonerate parties to a transaction from exercising all their rights and obligations under the transaction documents. This document cannot be reproduced except in full, without prior written approval of the Company. Any unauthorized alteration, forgery or falsification of the content or appearance of this document is unlawful and offenders may be prosecuted to the fullest extent of the law.

Band77-Part27\_40MHz\_DFT\_s\_OFDM\_SCS30kHz\_256QAM\_RB100\_0\_CH656000

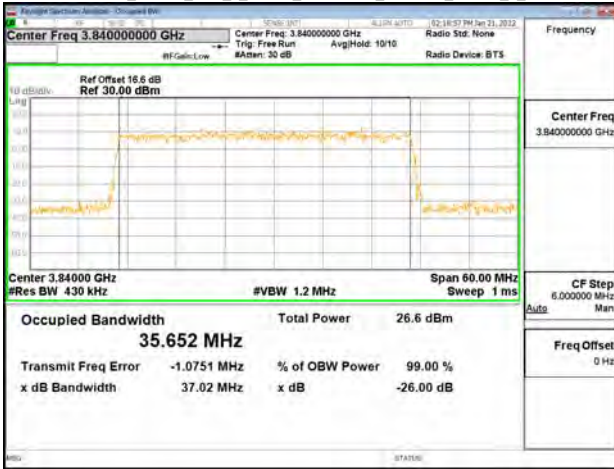

Band77-Part27\_50MHz\_DFT\_s\_OFDM\_SCS30kHz\_BPSK\_RB128\_0\_CH656000



Band77-Part27\_40MHz\_DFT\_s\_OFDM\_SCS30kHz\_256QAM\_RB100\_0\_CH640000



Band77-Part27\_50MHz\_DFT\_s\_OFDM\_SCS30kHz\_BPSK\_RB128\_0\_CH663666



Band77-Part27\_50MHz\_DFT\_s\_OFDM\_SCS30kHz\_BPSK\_RB128\_0\_CH648334

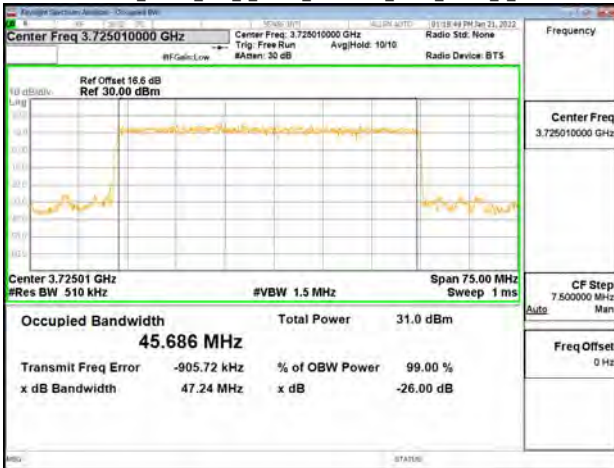

Band77-Part27\_50MHz\_DFT\_s\_OFDM\_SCS30kHz\_QPSK\_RB128\_0\_CH648334



Unless otherwise stated the results shown in this test report refer only to the sample(s) tested and such sample(s) are retained for 90 days only.

除非另有說明，此報告結果僅對測試之樣品負責，同時此樣品僅保留90天。本報告未經本公司書面許可，不可部份複製。

This document is issued by the Company subject to its General Conditions of Service printed overleaf, available on request or accessible at <http://www.sgs.com.tw/Terms-and-Conditions> and for electronic format documents, subject to Terms and Conditions for Electronic Documents at <http://www.sgs.com.tw/Terms-and-Conditions>. Attention is drawn to the limitation of liability, indemnification and jurisdiction issues defined therein. Any holder of this document is advised that information contained hereon reflects the Company's findings at the time of its intervention only and within the limits of Client's instructions, if any. The Company's sole responsibility is to its Client and this document does not exonerate parties to a transaction from exercising all their rights and obligations under the transaction documents. This document cannot be reproduced except in full, without prior written approval of the Company. Any unauthorized alteration, forgery or falsification of the content or appearance of this document is unlawful and offenders may be prosecuted to the fullest extent of the law.



Band77-Part27\_50MHz\_DFT\_s\_OFDM\_SCS30kHz\_QPSK\_RB128\_0\_CH656000



Band77-Part27\_50MHz\_DFT\_s\_OFDM\_SCS30kHz\_16QAM\_RB128\_0\_CH656000



Band77-Part27\_50MHz\_DFT\_s\_OFDM\_SCS30kHz\_QPSK\_RB128\_0\_CH663666



Band77-Part27\_50MHz\_DFT\_s\_OFDM\_SCS30kHz\_16QAM\_RB128\_0\_CH663666



Band77-Part27\_50MHz\_DFT\_s\_OFDM\_SCS30kHz\_16QAM\_RB128\_0\_CH648334



Band77-Part27\_50MHz\_DFT\_s\_OFDM\_SCS30kHz\_64QAM\_RB128\_0\_CH648334



Unless otherwise stated the results shown in this test report refer only to the sample(s) tested and such sample(s) are retained for 90 days only.

除非另有說明，此報告結果僅對測試之樣品負責，同時此樣品僅保留90天。本報告未經本公司書面許可，不可部份複製。

This document is issued by the Company subject to its General Conditions of Service printed overleaf, available on request or accessible at <http://www.sgs.com.tw/Terms-and-Conditions> and for electronic format documents, subject to Terms and Conditions for Electronic Documents at <http://www.sgs.com.tw/Terms-and-Conditions>. Attention is drawn to the limitation of liability, indemnification and jurisdiction issues defined therein. Any holder of this document is advised that information contained hereon reflects the Company's findings at the time of its intervention only and within the limits of Client's instructions, if any. The Company's sole responsibility is to its Client and this document does not exonerate parties to a transaction from exercising all their rights and obligations under the transaction documents. This document cannot be reproduced except in full, without prior written approval of the Company. Any unauthorized alteration, forgery or falsification of the content or appearance of this document is unlawful and offenders may be prosecuted to the fullest extent of the law.

Band77-Part27\_50MHz\_DFT\_s\_OFDM\_SCS30kHz\_64QAM\_RB128\_0\_CH656000



Band77-Part27\_50MHz\_DFT\_s\_OFDM\_SCS30kHz\_256QAM\_RB128\_0\_CH656000



Band77-Part27\_50MHz\_DFT\_s\_OFDM\_SCS30kHz\_64QAM\_RB128\_0\_CH663666



Band77-Part27\_50MHz\_DFT\_s\_OFDM\_SCS30kHz\_256QAM\_RB128\_0\_CH663666



Band77-Part27\_50MHz\_DFT\_s\_OFDM\_SCS30kHz\_256QAM\_RB128\_0\_CH648334



Band77-Part27\_60MHz\_DFT\_s\_OFDM\_SCS30kHz\_BPSK\_RB162\_0\_CH648668



Unless otherwise stated the results shown in this test report refer only to the sample(s) tested and such sample(s) are retained for 90 days only.

除非另有說明，此報告結果僅對測試之樣品負責，同時此樣品僅保留90天。本報告未經本公司書面許可，不可部份複製。

This document is issued by the Company subject to its General Conditions of Service printed overleaf, available on request or accessible at <http://www.sgs.com.tw/Terms-and-Conditions> and for electronic format documents, subject to Terms and Conditions for Electronic Documents at <http://www.sgs.com.tw/Terms-and-Conditions>. Attention is drawn to the limitation of liability, indemnification and jurisdiction issues defined therein. Any holder of this document is advised that information contained hereon reflects the Company's findings at the time of its intervention only and within the limits of Client's instructions, if any. The Company's sole responsibility is to its Client and this document does not exonerate parties to a transaction from exercising all their rights and obligations under the transaction documents. This document cannot be reproduced except in full, without prior written approval of the Company. Any unauthorized alteration, forgery or falsification of the content or appearance of this document is unlawful and offenders may be prosecuted to the fullest extent of the law.

Band77-Part27\_60MHz\_DFT\_s\_OFDM\_SCS30kHz\_BPSK\_RB162\_0\_CH656000



Band77-Part27\_60MHz\_DFT\_s\_OFDM\_SCS30kHz\_QPSK\_RB162\_0\_CH656000



Band77-Part27\_60MHz\_DFT\_s\_OFDM\_SCS30kHz\_BPSK\_RB162\_0\_CH663332

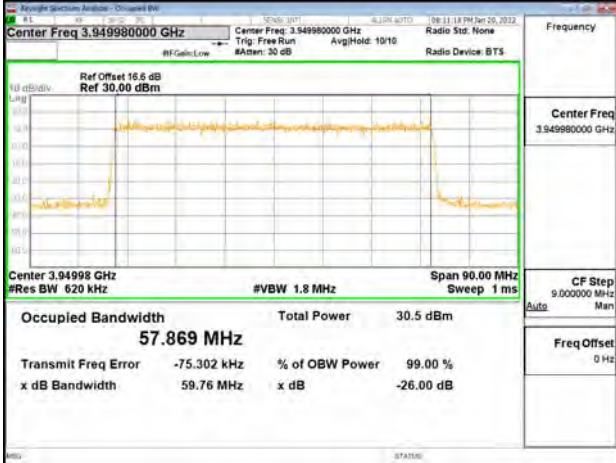

Band77-Part27\_60MHz\_DFT\_s\_OFDM\_SCS30kHz\_QPSK\_RB162\_0\_CH663332



Band77-Part27\_60MHz\_DFT\_s\_OFDM\_SCS30kHz\_QPSK\_RB162\_0\_CH648668



Band77-Part27\_60MHz\_DFT\_s\_OFDM\_SCS30kHz\_16QAM\_RB162\_0\_CH648668



Unless otherwise stated the results shown in this test report refer only to the sample(s) tested and such sample(s) are retained for 90 days only.

除非另有說明，此報告結果僅對測試之樣品負責，同時此樣品僅保留90天。本報告未經本公司書面許可，不可部份複製。

This document is issued by the Company subject to its General Conditions of Service printed overleaf, available on request or accessible at <http://www.sgs.com.tw/Terms-and-Conditions> and for electronic format documents, subject to Terms and Conditions for Electronic Documents at <http://www.sgs.com.tw/Terms-and-Conditions>. Attention is drawn to the limitation of liability, indemnification and jurisdiction issues defined therein. Any holder of this document is advised that information contained hereon reflects the Company's findings at the time of its intervention only and within the limits of Client's instructions, if any. The Company's sole responsibility is to its Client and this document does not exonerate parties to a transaction from exercising all their rights and obligations under the transaction documents. This document cannot be reproduced except in full, without prior written approval of the Company. Any unauthorized alteration, forgery or falsification of the content or appearance of this document is unlawful and offenders may be prosecuted to the fullest extent of the law.

Band77-Part27\_60MHz\_DFT\_s\_OFDM\_SCS30kHz\_16QAM\_RB162\_0\_CH656000

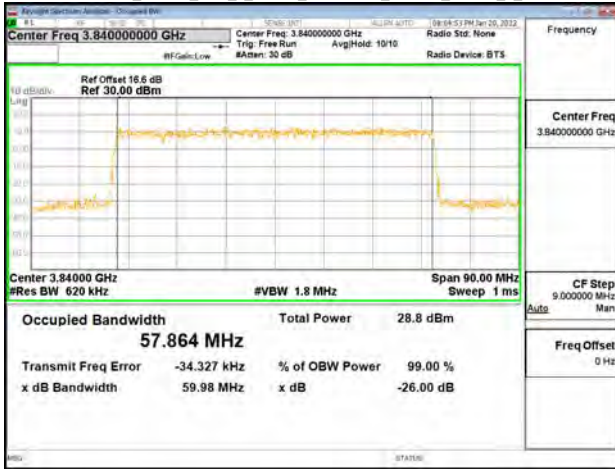

Band77-Part27\_60MHz\_DFT\_s\_OFDM\_SCS30kHz\_64QAM\_RB162\_0\_CH656000



Band77-Part27\_60MHz\_DFT\_s\_OFDM\_SCS30kHz\_16QAM\_RB162\_0\_CH663332



Band77-Part27\_60MHz\_DFT\_s\_OFDM\_SCS30kHz\_64QAM\_RB162\_0\_CH663332

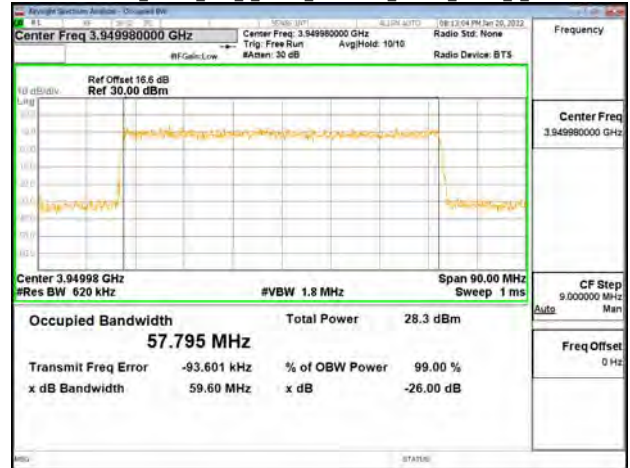

Band77-Part27\_60MHz\_DFT\_s\_OFDM\_SCS30kHz\_64QAM\_RB162\_0\_CH648668



Band77-Part27\_60MHz\_DFT\_s\_OFDM\_SCS30kHz\_256QAM\_RB162\_0\_CH648668

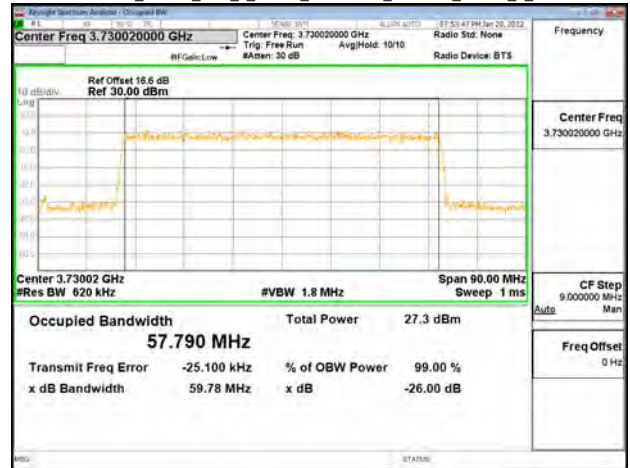

Unless otherwise stated, the results shown in this test report refer only to the sample(s) tested and such sample(s) are retained for 90 days only.

除非另有說明，此報告結果僅對測試之樣品負責，同時此樣品僅保留90天。本報告未經本公司書面許可，不可部份複製。

This document is issued by the Company subject to its General Conditions of Service printed overleaf, available on request or accessible at <http://www.sgs.com.tw/Terms-and-Conditions> and for electronic format documents, subject to Terms and Conditions for Electronic Documents at <http://www.sgs.com.tw/Terms-and-Conditions>. Attention is drawn to the limitation of liability, indemnification and jurisdiction issues defined therein. Any holder of this document is advised that information contained hereon reflects the Company's findings at the time of its intervention only and within the limits of Client's instructions, if any. The Company's sole responsibility is to its Client and this document does not exonerate parties to a transaction from exercising all their rights and obligations under the transaction documents. This document cannot be reproduced except in full, without prior written approval of the Company. Any unauthorized alteration, forgery or falsification of the content or appearance of this document is unlawful and offenders may be prosecuted to the fullest extent of the law.

Band77-Part27\_60MHz\_DFT\_s\_OFDM\_SCS30kHz\_256QAM\_RB162\_0\_CH656000

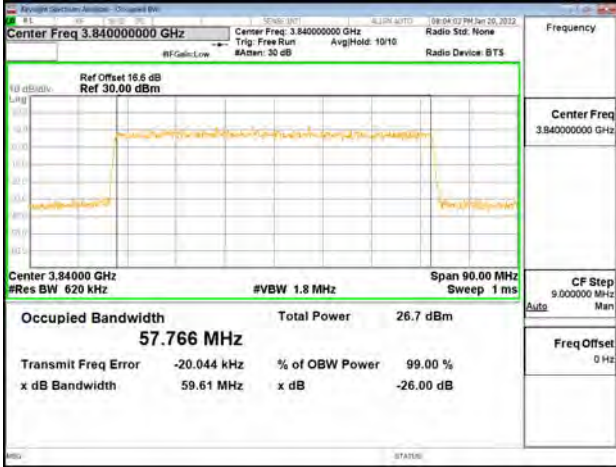

Band77-Part27\_70MHz\_DFT\_s\_OFDM\_SCS30kHz\_BPSK\_RB180\_0\_CH656000

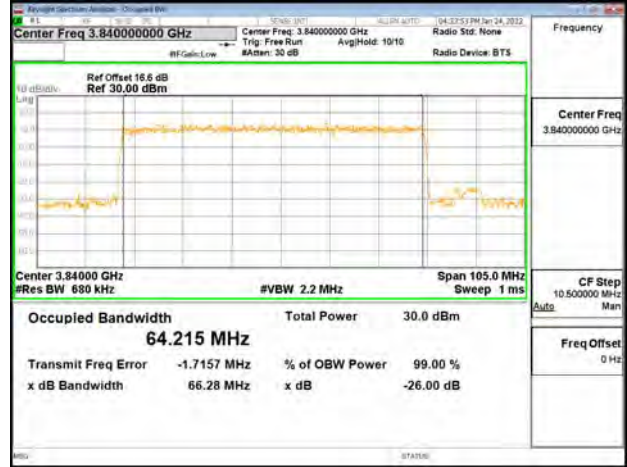

Band77-Part27\_60MHz\_DFT\_s\_OFDM\_SCS30kHz\_256QAM\_RB162\_0\_CH663332

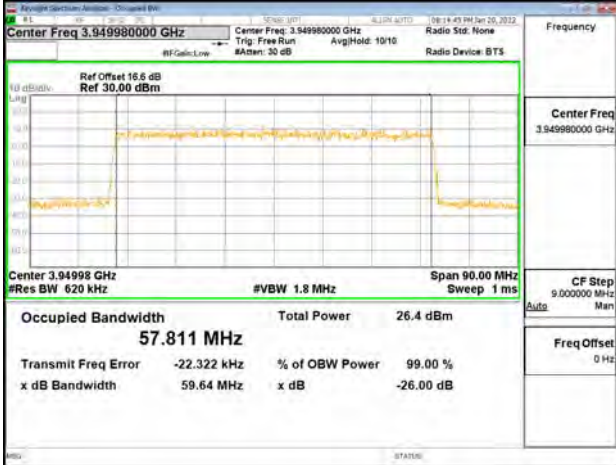

Band77-Part27\_70MHz\_DFT\_s\_OFDM\_SCS30kHz\_BPSK\_RB180\_0\_CH663000

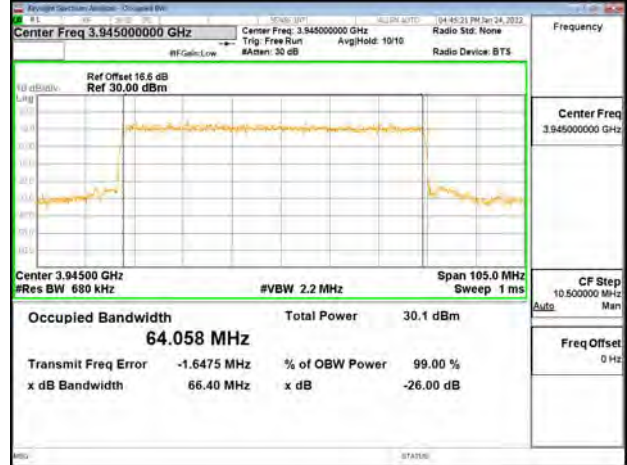

Band77-Part27\_70MHz\_DFT\_s\_OFDM\_SCS30kHz\_BPSK\_RB180\_0\_CH649000



Band77-Part27\_70MHz\_DFT\_s\_OFDM\_SCS30kHz\_QPSK\_RB180\_0\_CH649000

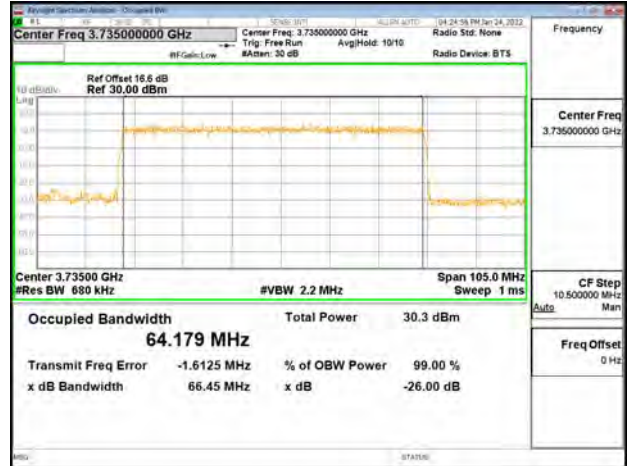

Unless otherwise stated the results shown in this test report refer only to the sample(s) tested and such sample(s) are retained for 90 days only.

除非另有說明，此報告結果僅對測試之樣品負責，同時此樣品僅保留90天。本報告未經本公司書面許可，不可部份複製。

This document is issued by the Company subject to its General Conditions of Service printed overleaf, available on request or accessible at <http://www.sgs.com.tw/Terms-and-Conditions> and for electronic format documents, subject to Terms and Conditions for Electronic Documents at <http://www.sgs.com.tw/Terms-and-Conditions>. Attention is drawn to the limitation of liability, indemnification and jurisdiction issues defined therein. Any holder of this document is advised that information contained hereon reflects the Company's findings at the time of its intervention only and within the limits of Client's instructions, if any. The Company's sole responsibility is to its Client and this document does not exonerate parties to a transaction from exercising all their rights and obligations under the transaction documents. This document cannot be reproduced except in full, without prior written approval of the Company. Any unauthorized alteration, forgery or falsification of the content or appearance of this document is unlawful and offenders may be prosecuted to the fullest extent of the law.

Band77-Part27\_70MHz\_DFT\_s\_OFDM\_SCS30kHz\_QPSK\_RB180\_0\_CH66000

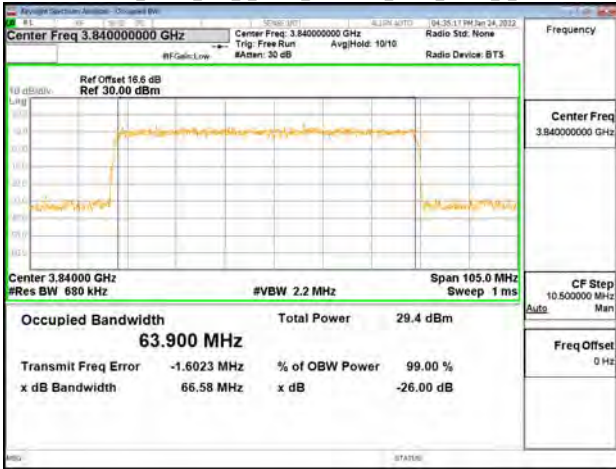

Band77-Part27\_70MHz\_DFT\_s\_OFDM\_SCS30kHz\_16QAM\_RB180\_0\_CH66000

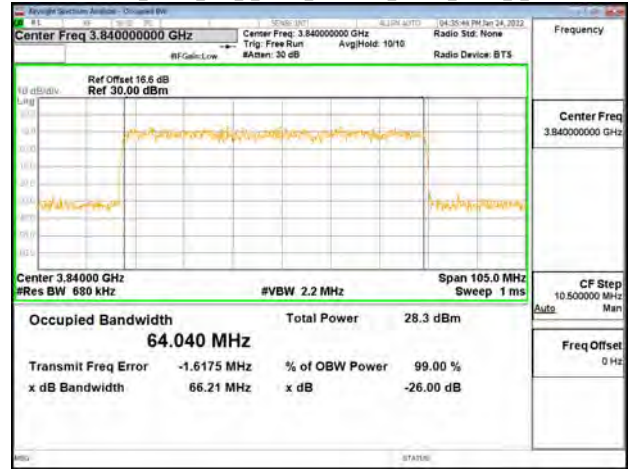

Band77-Part27\_70MHz\_DFT\_s\_OFDM\_SCS30kHz\_QPSK\_RB180\_0\_CH663000



Band77-Part27\_70MHz\_DFT\_s\_OFDM\_SCS30kHz\_16QAM\_RB180\_0\_CH663000



Band77-Part27\_70MHz\_DFT\_s\_OFDM\_SCS30kHz\_16QAM\_RB180\_0\_CH649000



Band77-Part27\_70MHz\_DFT\_s\_OFDM\_SCS30kHz\_64QAM\_RB180\_0\_CH649000



Unless otherwise stated the results shown in this test report refer only to the sample(s) tested and such sample(s) are retained for 90 days only.

除非另有說明，此報告結果僅對測試之樣品負責，同時此樣品僅保留90天。本報告未經本公司書面許可，不可部份複製。

This document is issued by the Company subject to its General Conditions of Service printed overleaf, available on request or accessible at <http://www.sgs.com.tw/Terms-and-Conditions> and for electronic format documents, subject to Terms and Conditions for Electronic Documents at <http://www.sgs.com.tw/Terms-and-Conditions>. Attention is drawn to the limitation of liability, indemnification and jurisdiction issues defined therein. Any holder of this document is advised that information contained hereon reflects the Company's findings at the time of its intervention only and within the limits of Client's instructions, if any. The Company's sole responsibility is to its Client and this document does not exonerate parties to a transaction from exercising all their rights and obligations under the transaction documents. This document cannot be reproduced except in full, without prior written approval of the Company. Any unauthorized alteration, forgery or falsification of the content or appearance of this document is unlawful and offenders may be prosecuted to the fullest extent of the law.

Band77-Part27\_70MHz\_DFT\_s\_OFDM\_SCS30kHz\_64QAM\_RB180\_0\_CH656000



Band77-Part27\_70MHz\_DFT\_s\_OFDM\_SCS30kHz\_256QAM\_RB180\_0\_CH656000



Band77-Part27\_70MHz\_DFT\_s\_OFDM\_SCS30kHz\_64QAM\_RB180\_0\_CH663000

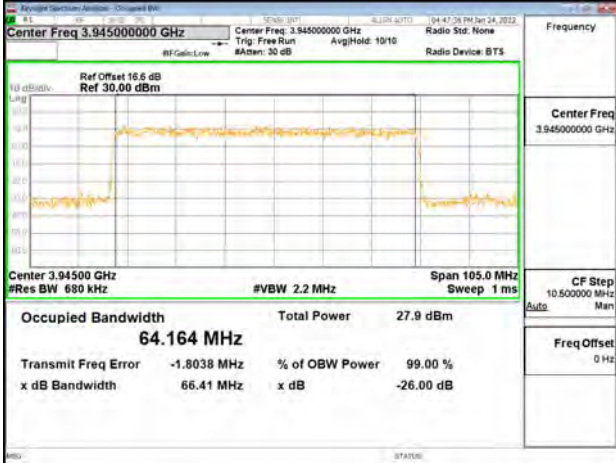

Band77-Part27\_70MHz\_DFT\_s\_OFDM\_SCS30kHz\_256QAM\_RB180\_0\_CH663000

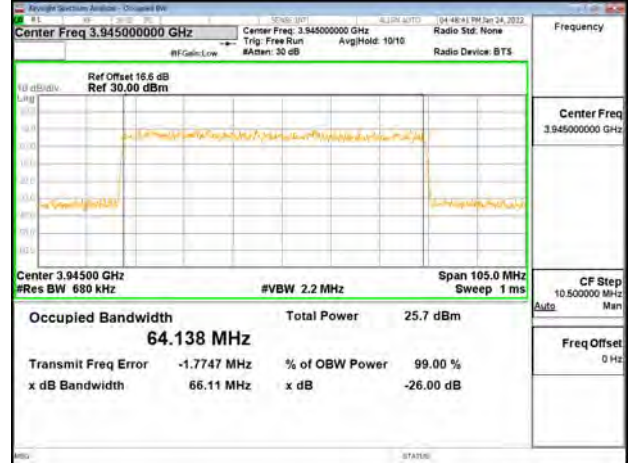

Band77-Part27\_70MHz\_DFT\_s\_OFDM\_SCS30kHz\_256QAM\_RB180\_0\_CH649000



Band77-Part27\_80MHz\_DFT\_s\_OFDM\_SCS30kHz\_BPSK\_RB216\_0\_CH649334



Unless otherwise stated, the results shown in this test report refer only to the sample(s) tested and such sample(s) are representative for 90 days only.

除非另有說明，此報告結果僅對測試之樣品負責，同時此樣品僅保留90天。本報告未經本公司書面許可，不可部份複製。

This document is issued by the Company subject to its General Conditions of Service printed overleaf, available on request or accessible at <http://www.sgs.com.tw/Terms-and-Conditions> and for electronic format documents, subject to Terms and Conditions for Electronic Documents at <http://www.sgs.com.tw/Terms-and-Conditions>. Attention is drawn to the limitation of liability, indemnification and jurisdiction issues defined therein. Any holder of this document is advised that information contained hereon reflects the Company's findings at the time of its intervention only and within the limits of Client's instructions, if any. The Company's sole responsibility is to its Client and this document does not exonerate parties to a transaction from exercising all their rights and obligations under the transaction documents. This document cannot be reproduced except in full, without prior written approval of the Company. Any unauthorized alteration, forgery or falsification of the content or appearance of this document is unlawful and offenders may be prosecuted to the fullest extent of the law.

Band77-Part27\_80MHz\_DFT\_s\_OFDM\_SCS30kHz\_BPSK\_RB216\_0\_CH656000

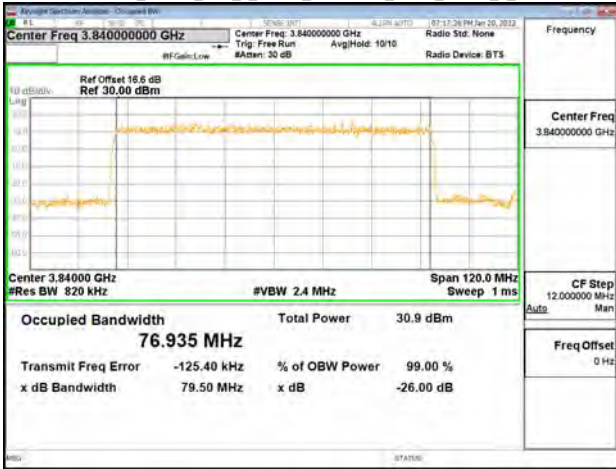

Band77-Part27\_80MHz\_DFT\_s\_OFDM\_SCS30kHz\_QPSK\_RB216\_0\_CH656000

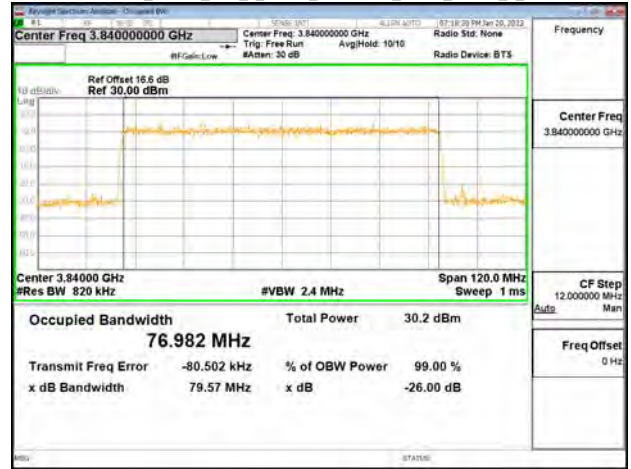

Band77-Part27\_80MHz\_DFT\_s\_OFDM\_SCS30kHz\_BPSK\_RB216\_0\_CH662666

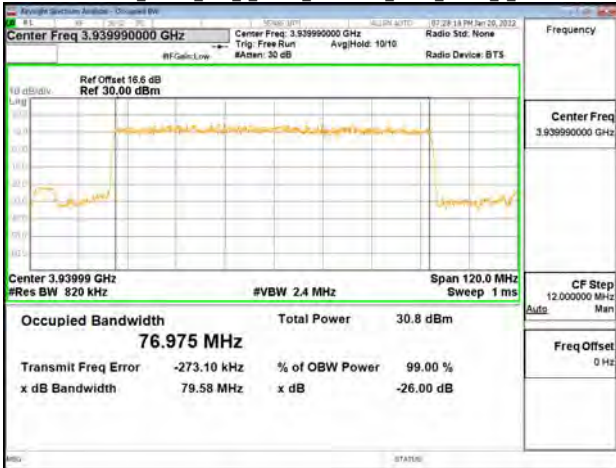

Band77-Part27\_80MHz\_DFT\_s\_OFDM\_SCS30kHz\_QPSK\_RB216\_0\_CH662666



Band77-Part27\_80MHz\_DFT\_s\_OFDM\_SCS30kHz\_QPSK\_RB216\_0\_CH649334



Band77-Part27\_80MHz\_DFT\_s\_OFDM\_SCS30kHz\_16QAM\_RB216\_0\_CH649334



Unless otherwise stated the results shown in this test report refer only to the sample(s) tested and such sample(s) are retained for 90 days only.

除非另有說明，此報告結果僅對測試之樣品負責，同時此樣品僅保留90天。本報告未經本公司書面許可，不可部份複製。

This document is issued by the Company subject to its General Conditions of Service printed overleaf, available on request or accessible at <http://www.sgs.com.tw/Terms-and-Conditions> and for electronic format documents, subject to Terms and Conditions for Electronic Documents at <http://www.sgs.com.tw/Terms-and-Conditions>. Attention is drawn to the limitation of liability, indemnification and jurisdiction issues defined therein. Any holder of this document is advised that information contained hereon reflects the Company's findings at the time of its intervention only and within the limits of Client's instructions, if any. The Company's sole responsibility is to its Client and this document does not exonerate parties to a transaction from exercising all their rights and obligations under the transaction documents. This document cannot be reproduced except in full, without prior written approval of the Company. Any unauthorized alteration, forgery or falsification of the content or appearance of this document is unlawful and offenders may be prosecuted to the fullest extent of the law.



Band77-Part27\_80MHz\_DFT\_s\_OFDM\_SCS30kHz\_16QAM\_RB216\_0\_CH656000

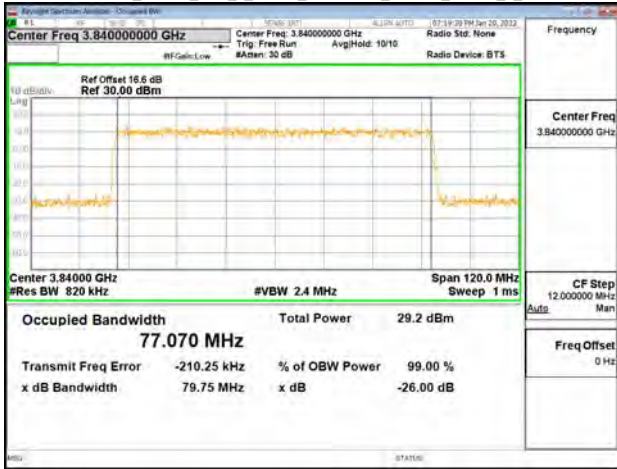

Band77-Part27\_80MHz\_DFT\_s\_OFDM\_SCS30kHz\_64QAM\_RB216\_0\_CH656000

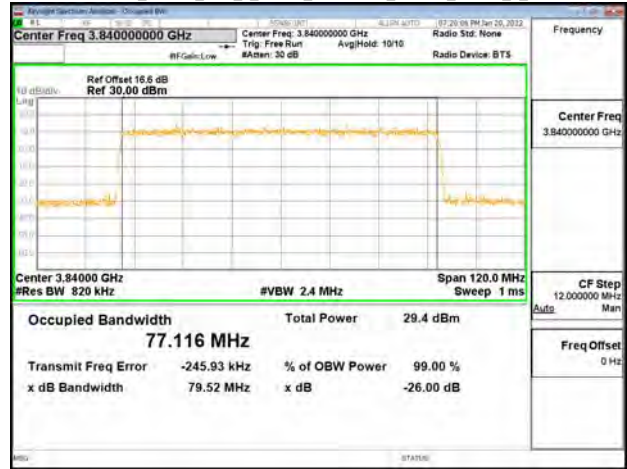

Band77-Part27\_80MHz\_DFT\_s\_OFDM\_SCS30kHz\_16QAM\_RB216\_0\_CH662666



Band77-Part27\_80MHz\_DFT\_s\_OFDM\_SCS30kHz\_64QAM\_RB216\_0\_CH662666



Band77-Part27\_80MHz\_DFT\_s\_OFDM\_SCS30kHz\_64QAM\_RB216\_0\_CH649334



Band77-Part27\_80MHz\_DFT\_s\_OFDM\_SCS30kHz\_256QAM\_RB216\_0\_CH649334

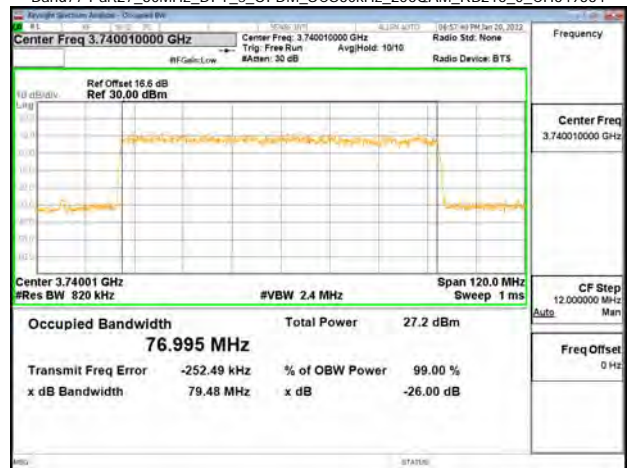

Unless otherwise stated the results shown in this test report refer only to the sample(s) tested and such sample(s) are retained for 90 days only.

除非另有說明，此報告結果僅對測試之樣品負責，同時此樣品僅保留90天。本報告未經本公司書面許可，不可部份複製。  
This document is issued by the Company subject to its General Conditions of Service printed overleaf, available on request or accessible at <http://www.sgs.com.tw/Terms-and-Conditions> and for electronic format documents, subject to Terms and Conditions for Electronic Documents at <http://www.sgs.com.tw/Terms-and-Conditions>. Attention is drawn to the limitation of liability, indemnification and jurisdiction issues defined therein. Any holder of this document is advised that information contained hereon reflects the Company's findings at the time of its intervention only and within the limits of Client's instructions, if any. The Company's sole responsibility is to its Client and this document does not exonerate parties to a transaction from exercising all their rights and obligations under the transaction documents. This document cannot be reproduced except in full, without prior written approval of the Company. Any unauthorized alteration, forgery or falsification of the content or appearance of this document is unlawful and offenders may be prosecuted to the fullest extent of the law.

Band77-Part27\_80MHz\_DFT\_s\_OFDM\_SCS30kHz\_256QAM\_RB216\_0\_CH656000

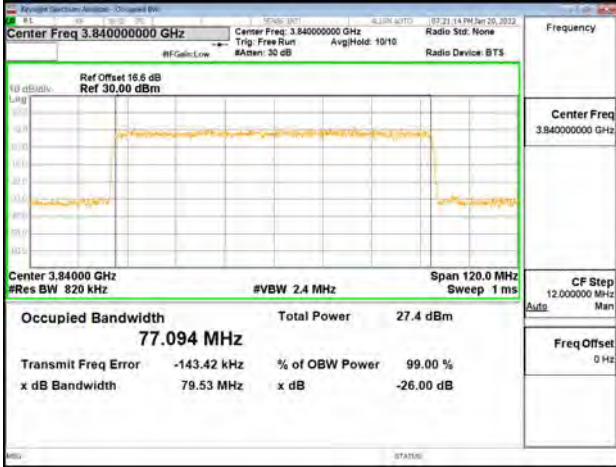

Band77-Part27\_90MHz\_DFT\_s\_OFDM\_SCS30kHz\_BPSK\_RB243\_0\_CH656000



Band77-Part27\_80MHz\_DFT\_s\_OFDM\_SCS30kHz\_256QAM\_RB216\_0\_CH662666



Band77-Part27\_90MHz\_DFT\_s\_OFDM\_SCS30kHz\_BPSK\_RB243\_0\_CH662332

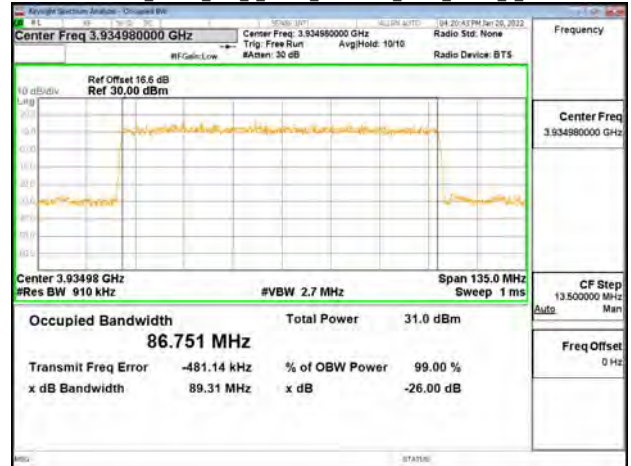

Band77-Part27\_90MHz\_DFT\_s\_OFDM\_SCS30kHz\_BPSK\_RB243\_0\_CH649668



Band77-Part27\_90MHz\_DFT\_s\_OFDM\_SCS30kHz\_QPSK\_RB243\_0\_CH649668



Unless otherwise stated the results shown in this test report refer only to the sample(s) tested and such sample(s) are tested for 90 days only.

除非另有說明，此報告結果僅對測試之樣品負責，同時此樣品僅保留90天。本報告未經本公司書面許可，不可部份複製。

This document is issued by the Company subject to its General Conditions of Service printed overleaf, available on request or accessible at <http://www.sgs.com.tw/Terms-and-Conditions> and for electronic format documents, subject to Terms and Conditions for Electronic Documents at <http://www.sgs.com.tw/Terms-and-Conditions>. Attention is drawn to the limitation of liability, indemnification and jurisdiction issues defined therein. Any holder of this document is advised that information contained hereon reflects the Company's findings at the time of its intervention only and within the limits of Client's instructions, if any. The Company's sole responsibility is to its Client and this document does not exonerate parties to a transaction from exercising all their rights and obligations under the transaction documents. This document cannot be reproduced except in full, without prior written approval of the Company. Any unauthorized alteration, forgery or falsification of the content or appearance of this document is unlawful and offenders may be prosecuted to the fullest extent of the law.

Band77-Part27\_90MHz\_DFT\_s\_OFDM\_SCS30kHz\_QPSK\_RB243\_0\_CH656000

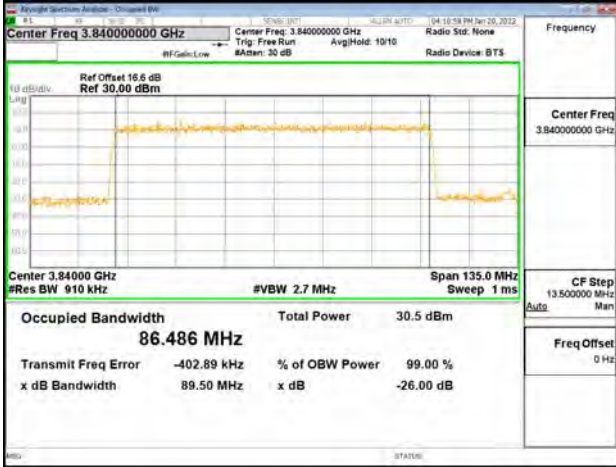

Band77-Part27\_90MHz\_DFT\_s\_OFDM\_SCS30kHz\_16QAM\_RB243\_0\_CH656000

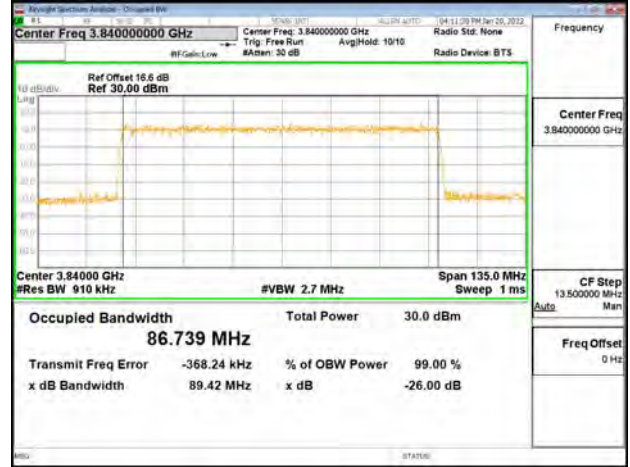

Band77-Part27\_90MHz\_DFT\_s\_OFDM\_SCS30kHz\_QPSK\_RB243\_0\_CH662332

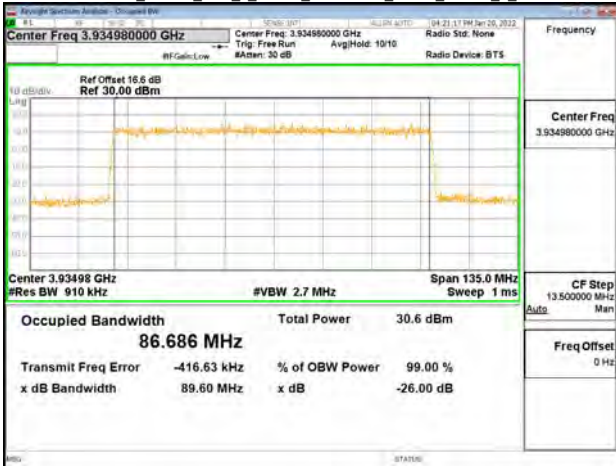

Band77-Part27\_90MHz\_DFT\_s\_OFDM\_SCS30kHz\_16QAM\_RB243\_0\_CH662332



Band77-Part27\_90MHz\_DFT\_s\_OFDM\_SCS30kHz\_16QAM\_RB243\_0\_CH649668



Band77-Part27\_90MHz\_DFT\_s\_OFDM\_SCS30kHz\_64QAM\_RB243\_0\_CH649668



Unless otherwise stated the results shown in this test report refer only to the sample(s) tested and such sample(s) are retained for 90 days only.

除非另有說明，此報告結果僅對測試之樣品負責，同時此樣品僅保留90天。本報告未經本公司書面許可，不可部份複製。

This document is issued by the Company subject to its General Conditions of Service printed overleaf, available on request or accessible at <http://www.sgs.com.tw/Terms-and-Conditions> and for electronic format documents, subject to Terms and Conditions for Electronic Documents at <http://www.sgs.com.tw/Terms-and-Conditions>. Attention is drawn to the limitation of liability, indemnification and jurisdiction issues defined therein. Any holder of this document is advised that information contained hereon reflects the Company's findings at the time of its intervention only and within the limits of Client's instructions, if any. The Company's sole responsibility is to its Client and this document does not exonerate parties to a transaction from exercising all their rights and obligations under the transaction documents. This document cannot be reproduced except in full, without prior written approval of the Company. Any unauthorized alteration, forgery or falsification of the content or appearance of this document is unlawful and offenders may be prosecuted to the fullest extent of the law.

Band77-Part27\_90MHz\_DFT\_s\_OFDM\_SCS30kHz\_64QAM\_RB243\_0\_CH656000



Band77-Part27\_90MHz\_DFT\_s\_OFDM\_SCS30kHz\_256QAM\_RB243\_0\_CH656000

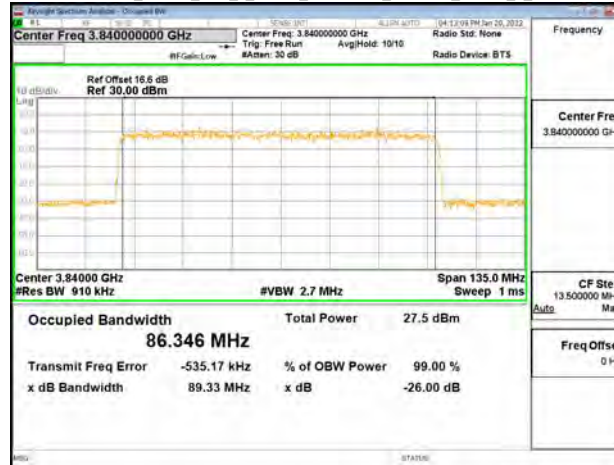

Band77-Part27\_90MHz\_DFT\_s\_OFDM\_SCS30kHz\_64QAM\_RB243\_0\_CH662332



Band77-Part27\_90MHz\_DFT\_s\_OFDM\_SCS30kHz\_256QAM\_RB243\_0\_CH662332



Band77-Part27\_90MHz\_DFT\_s\_OFDM\_SCS30kHz\_256QAM\_RB243\_0\_CH649668



Band77-Part27\_100MHz\_DFT\_s\_OFDM\_SCS30kHz\_BPSK\_RB270\_0\_CH650000



Unless otherwise stated the results shown in this test report refer only to the sample(s) tested and such sample(s) are retained for 90 days only.

除非另有說明，此報告結果僅對測試之樣品負責，同時此樣品僅保留90天。本報告未經本公司書面許可，不可部份複製。

This document is issued by the Company subject to its General Conditions of Service printed overleaf, available on request or accessible at <http://www.sgs.com.tw/Terms-and-Conditions> and for electronic format documents, subject to Terms and Conditions for Electronic Documents at <http://www.sgs.com.tw/Terms-and-Conditions>. Attention is drawn to the limitation of liability, indemnification and jurisdiction issues defined therein. Any holder of this document is advised that information contained hereon reflects the Company's findings at the time of its intervention only and within the limits of Client's instructions, if any. The Company's sole responsibility is to its Client and this document does not exonerate parties to a transaction from exercising all their rights and obligations under the transaction documents. This document cannot be reproduced except in full, without prior written approval of the Company. Any unauthorized alteration, forgery or falsification of the content or appearance of this document is unlawful and offenders may be prosecuted to the fullest extent of the law.

Band77-Part27\_100MHz\_DFT\_s\_OFDM\_SCS30kHz\_BPSK\_RB270\_0\_CH656000

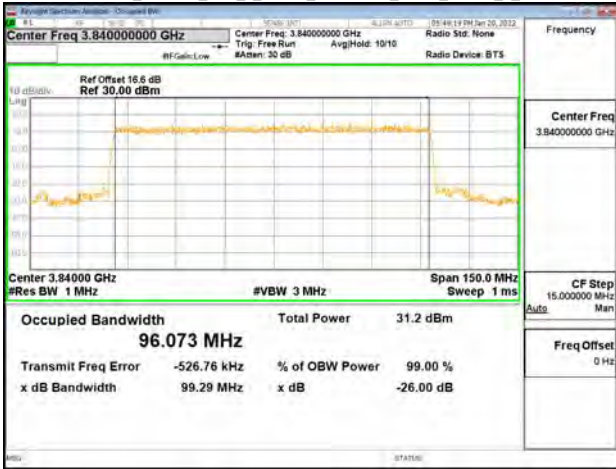

Band77-Part27\_100MHz\_DFT\_s\_OFDM\_SCS30kHz\_QPSK\_RB270\_0\_CH656000

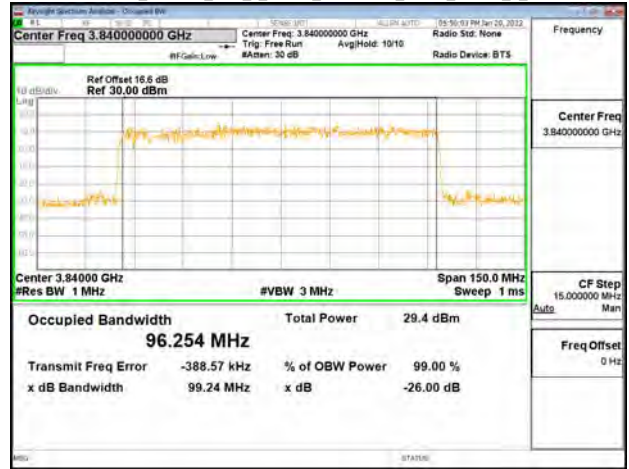

Band77-Part27\_100MHz\_DFT\_s\_OFDM\_SCS30kHz\_BPSK\_RB270\_0\_CH662000



Band77-Part27\_100MHz\_DFT\_s\_OFDM\_SCS30kHz\_QPSK\_RB270\_0\_CH662000

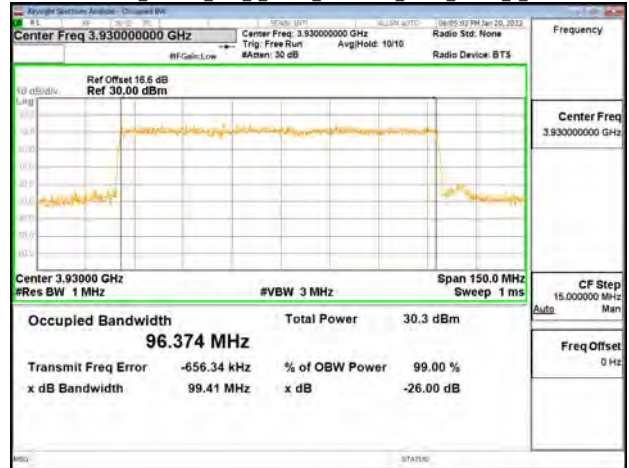

Band77-Part27\_100MHz\_DFT\_s\_OFDM\_SCS30kHz\_QPSK\_RB270\_0\_CH650000

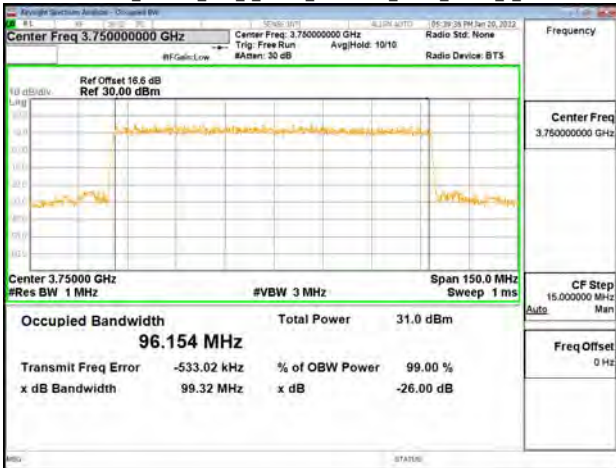

Band77-Part27\_100MHz\_DFT\_s\_OFDM\_SCS30kHz\_16QAM\_RB270\_0\_CH650000

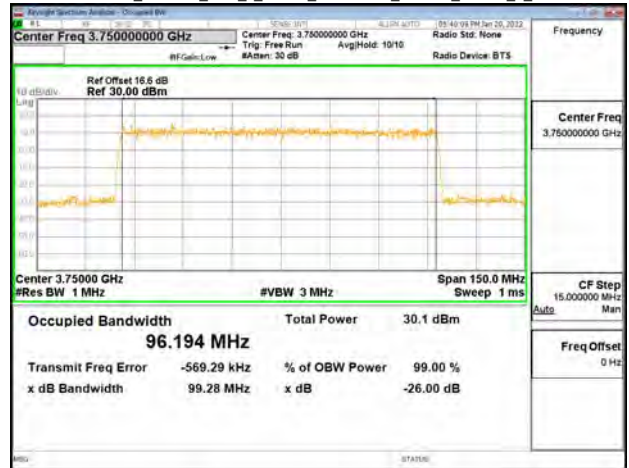

Unless otherwise stated the results shown in this test report refer only to the sample(s) tested and such sample(s) are retained for 90 days only.

除非另有說明，此報告結果僅對測試之樣品負責，同時此樣品僅保留90天。本報告未經本公司書面許可，不可部份複製。

This document is issued by the Company subject to its General Conditions of Service printed overleaf, available on request or accessible at <http://www.sgs.com.tw/Terms-and-Conditions> and for electronic format documents, subject to Terms and Conditions for Electronic Documents at <http://www.sgs.com.tw/Terms-and-Conditions>. Attention is drawn to the limitation of liability, indemnification and jurisdiction issues defined therein. Any holder of this document is advised that information contained hereon reflects the Company's findings at the time of its intervention only and within the limits of Client's instructions, if any. The Company's sole responsibility is to its Client and this document does not exonerate parties to a transaction from exercising all their rights and obligations under the transaction documents. This document cannot be reproduced except in full, without prior written approval of the Company. Any unauthorized alteration, forgery or falsification of the content or appearance of this document is unlawful and offenders may be prosecuted to the fullest extent of the law.

Band77-Part27\_100MHz\_DFT\_s\_OFDM\_SCS30kHz\_16QAM\_RB270\_0\_CH656000



Band77-Part27\_100MHz\_DFT\_s\_OFDM\_SCS30kHz\_64QAM\_RB270\_0\_CH656000

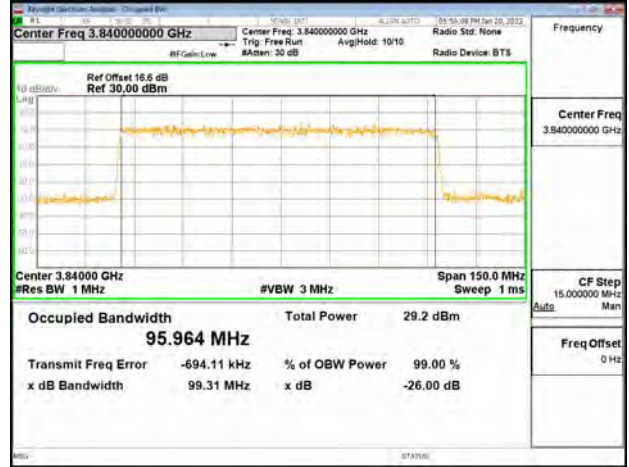

Band77-Part27\_100MHz\_DFT\_s\_OFDM\_SCS30kHz\_16QAM\_RB270\_0\_CH62000



Band77-Part27\_100MHz\_DFT\_s\_OFDM\_SCS30kHz\_64QAM\_RB270\_0\_CH62000



Band77-Part27\_100MHz\_DFT\_s\_OFDM\_SCS30kHz\_64QAM\_RB270\_0\_CH650000



Band77-Part27\_100MHz\_DFT\_s\_OFDM\_SCS30kHz\_256QAM\_RB270\_0\_CH650000



Unless otherwise stated the results shown in this test report refer only to the sample(s) tested and such sample(s) are retained for 90 days only.

除非另有說明，此報告結果僅對測試之樣品負責，同時此樣品僅保留90天。本報告未經本公司書面許可，不可部份複製。

This document is issued by the Company subject to its General Conditions of Service printed overleaf, available on request or accessible at <http://www.sgs.com.tw/Terms-and-Conditions> and for electronic format documents, subject to Terms and Conditions for Electronic Documents at <http://www.sgs.com.tw/Terms-and-Conditions>. Attention is drawn to the limitation of liability, indemnification and jurisdiction issues defined therein. Any holder of this document is advised that information contained hereon reflects the Company's findings at the time of its intervention only and within the limits of Client's instructions, if any. The Company's sole responsibility is to its Client and this document does not exonerate parties to a transaction from exercising all their rights and obligations under the transaction documents. This document cannot be reproduced except in full, without prior written approval of the Company. Any unauthorized alteration, forgery or falsification of the content or appearance of this document is unlawful and offenders may be prosecuted to the fullest extent of the law.

Band7-Part27\_100MHz\_DFT\_s\_OFDM\_SCS30kHz\_256QAM\_RB270\_0\_CH656000

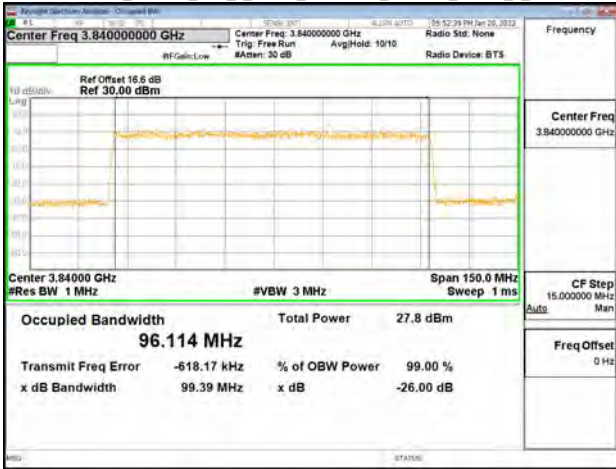

Band7-Part27\_100MHz\_DFT\_s\_OFDM\_SCS30kHz\_256QAM\_RB270\_0\_CH662000



Unless otherwise stated the results shown in this test report refer only to the sample(s) tested and such sample(s) are retained for 90 days only.

除非另有說明，此報告結果僅對測試之樣品負責，同時此樣品僅保留90天。本報告未經本公司書面許可，不可部份複製。

This document is issued by the Company subject to its General Conditions of Service printed overleaf, available on request or accessible at <http://www.sgs.com.tw/Terms-and-Conditions> and for electronic format documents, subject to Terms and Conditions for Electronic Documents at <http://www.sgs.com.tw/Terms-and-Conditions>. Attention is drawn to the limitation of liability, indemnification and jurisdiction issues defined therein. Any holder of this document is advised that information contained hereon reflects the Company's findings at the time of its intervention only and within the limits of Client's instructions, if any. The Company's sole responsibility is to its Client and this document does not exonerate parties to a transaction from exercising all their rights and obligations under the transaction documents. This document cannot be reproduced except in full, without prior written approval of the Company. Any unauthorized alteration, forgery or falsification of the content or appearance of this document is unlawful and offenders may be prosecuted to the fullest extent of the law.

## 9 OUT OF BAND EMISSION AT ANTENNA TERMINALS

### 9.1 Standard Applicable

#### FCC §27.53(l)

(2) For mobile operations in the 3700-3980 MHz band, the conducted power of any emission outside the licensee's authorized bandwidth shall not exceed  $-13$  dBm/MHz. Compliance with this paragraph (l)(2) is based on the use of measurement instrumentation employing a resolution bandwidth of 1 megahertz or greater. However, in the 1 megahertz bands immediately outside and adjacent to the licensee's frequency block, the minimum resolution bandwidth for the measurement shall be either one percent of the emission bandwidth of the fundamental emission of the transmitter or 350 kHz. In the bands between 1 and 5 MHz removed from the licensee's frequency block, the minimum resolution bandwidth for the measurement shall be 500 kHz. The emission bandwidth is defined as the width of the signal between two points, one below the carrier center frequency and one above the carrier center frequency, outside of which all emissions are attenuated at least 26 dB below the transmitter power.

#### FCC §27.53(n)

(2) For mobile operations in the 3450-3550 MHz band, the conducted power of any emission outside the licensee's authorized bandwidth shall not exceed  $-13$  dBm/MHz. Compliance with this paragraph (n)(2) is based on the use of measurement instrumentation employing a resolution bandwidth of 1 megahertz or greater. However, in the 1 megahertz bands immediately outside and adjacent to the licensee's frequency block, a resolution bandwidth of at least one percent of the emission bandwidth of the fundamental emission of the transmitter may be employed, but limited to a maximum of 200 kHz. In the bands between 1 and 5 MHz removed from the licensee's frequency block, the minimum resolution bandwidth for the measurement shall be 500 kHz. The emission bandwidth is defined as the width of the signal between two points, one below the carrier center frequency and one above the carrier center frequency, outside of which all emissions are attenuated at least 26 dB below the transmitter power.

### 9.2 Test SET-UP

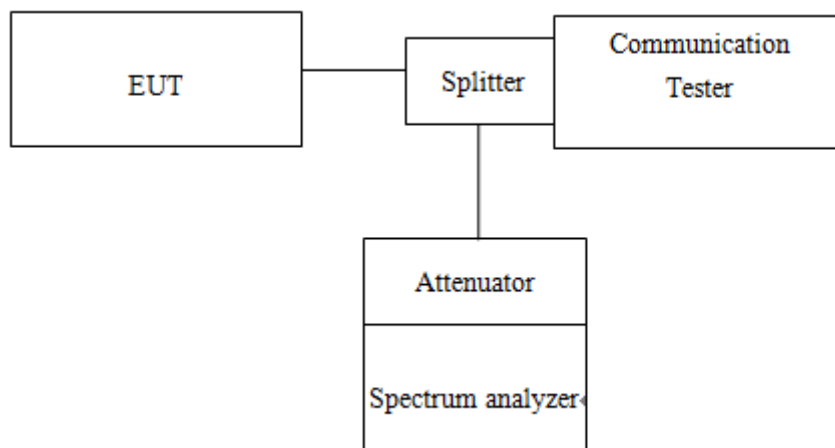

Unless otherwise stated the results shown in this test report refer only to the sample(s) tested and such sample(s) are retained for 90 days only.

除非另有說明，此報告結果僅對測試之樣品負責，同時此樣品僅保留90天。本報告未經本公司書面許可，不可部份複製。

This document is issued by the Company subject to its General Conditions of Service printed overleaf, available on request or accessible at <http://www.sgs.com.tw/Terms-and-Conditions> and for electronic format documents, subject to Terms and Conditions for Electronic Documents at <http://www.sgs.com.tw/Terms-and-Conditions>. Attention is drawn to the limitation of liability, indemnification and jurisdiction issues defined therein. Any holder of this document is advised that information contained hereon reflects the Company's findings at the time of its intervention only and within the limits of Client's instructions, if any. The Company's sole responsibility is to its Client and this document does not exonerate parties to a transaction from exercising all their rights and obligations under the transaction documents. This document cannot be reproduced except in full, without prior written approval of the Company. Any unauthorized alteration, forgery or falsification of the content or appearance of this document is unlawful and offenders may be prosecuted to the fullest extent of the law.



### 9.3 Measurement Procedure

#### 9.3.1 Conducted Emission

The RF output of the transceiver was connected to a spectrum analyzer through appropriate attenuation. The resolution bandwidth of the spectrum analyzer was set at 1MHz, sufficient scans were taken to show the out of band Emissions if any up to 10th harmonic.

1. To connect Antenna Port of EUT to Spectrum.
2. Set RBW = 1MHz & VBW = 1MHz on Spectrum.
3. Allow trace to fully stabilize
4. Repeat above procedures until all default test channel measured were complete.

#### 9.3.2 Emissions Adjacent to License Frequency Block

1. To connect Antenna Port of EUT to Spectrum.
2. The band edge of low and high channels for the highest RF powers was measured. Setting RBW according to each rule part required.
3. Allow trace to fully stabilize
4. Repeat above procedures until all default test channel measured were complete.

### 9.4 Measurement Result:

Refer to next pages.

Unless otherwise stated the results shown in this test report refer only to the sample(s) tested and such sample(s) are retained for 90 days only.

除非另有說明，此報告結果僅對測試之樣品負責，同時此樣品僅保留90天。本報告未經本公司書面許可，不可部份複製。

This document is issued by the Company subject to its General Conditions of Service printed overleaf, available on request or accessible at <http://www.sgs.com.tw/Terms-and-Conditions> and for electronic format documents, subject to Terms and Conditions for Electronic Documents at <http://www.sgs.com.tw/Terms-and-Conditions>. Attention is drawn to the limitation of liability, indemnification and jurisdiction issues defined therein. Any holder of this document is advised that information contained hereon reflects the Company's findings at the time of its intervention only and within the limits of Client's instructions, if any. The Company's sole responsibility is to its Client and this document does not exonerate parties to a transaction from exercising all their rights and obligations under the transaction documents. This document cannot be reproduced except in full, without prior written approval of the Company. Any unauthorized alteration, forgery or falsification of the content or appearance of this document is unlawful and offenders may be prosecuted to the fullest extent of the law.

Band77-Part27\_20MHz\_DFT\_s\_OFDM\_SCS30kHz\_BPSK\_RB1\_0\_CH630668

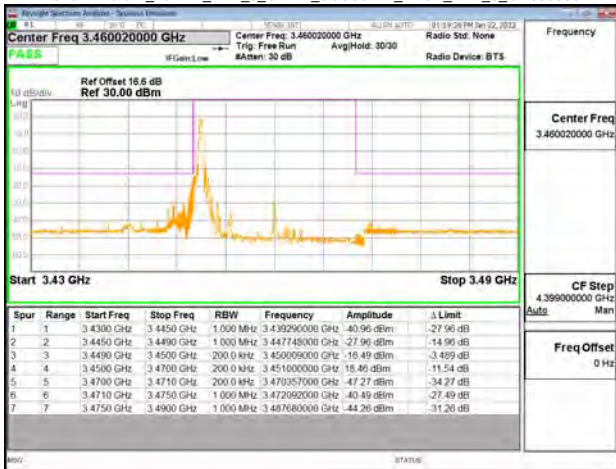

Band77-Part27\_20MHz\_DFT\_s\_OFDM\_SCS30kHz\_BPSK\_RB1\_0\_CH647334



Band77-Part27\_20MHz\_DFT\_s\_OFDM\_SCS30kHz\_BPSK\_RB1\_0\_CH633334

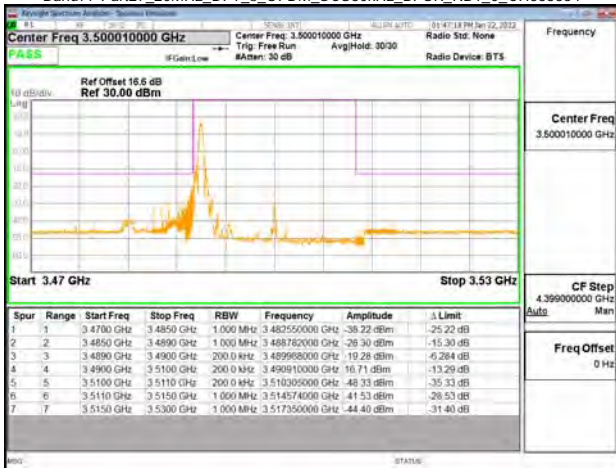

Band77-Part27\_20MHz\_DFT\_s\_OFDM\_SCS30kHz\_BPSK\_RB1\_0\_CH656000



Band77-Part27\_20MHz\_DFT\_s\_OFDM\_SCS30kHz\_BPSK\_RB1\_0\_CH636000

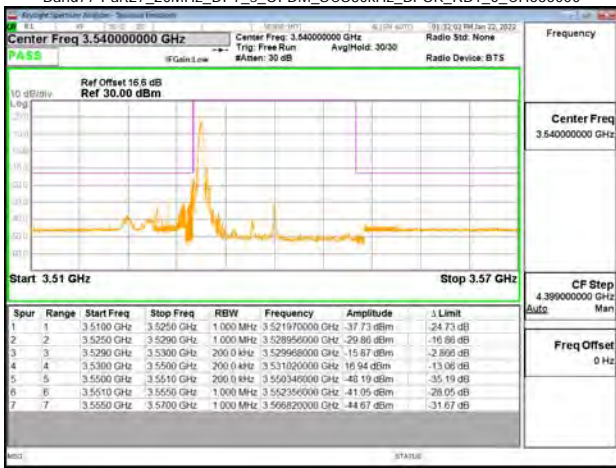

Band77-Part27\_20MHz\_DFT\_s\_OFDM\_SCS30kHz\_BPSK\_RB1\_0\_CH664666

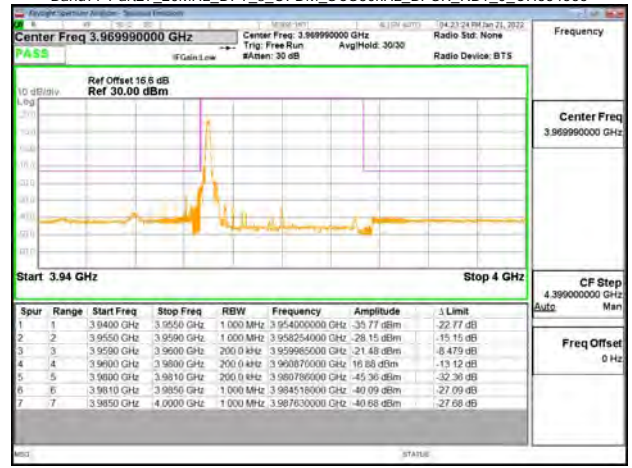

Unless otherwise stated the results shown in this test report refer only to the sample(s) tested and such sample(s) are retained for 90 days only.

除非另有說明，此報告結果僅對測試之樣品負責，同時此樣品僅保留90天。本報告未經本公司書面許可，不可部份複製。

This document is issued by the Company subject to its General Conditions of Service printed overleaf, available on request or accessible at <http://www.sgs.com.tw/Terms-and-Conditions> and for electronic format documents, subject to Terms and Conditions for Electronic Documents at <http://www.sgs.com.tw/Terms-and-Conditions>. Attention is drawn to the limitation of liability, indemnification and jurisdiction issues defined therein. Any holder of this document is advised that information contained herein reflects the Company's findings at the time of its intervention only and within the limits of Client's instructions, if any. The Company's sole responsibility is to its Client and this document does not exonerate parties to a transaction from exercising all their rights and obligations under the transaction documents. This document cannot be reproduced except in full, without prior written approval of the Company. Any unauthorized alteration, forgery or falsification of the content or appearance of this document is unlawful and offenders may be prosecuted to the fullest extent of the law.

Band77-Part27\_20MHz\_DFT\_s\_OFDM\_SCS30kHz\_BPSK\_RB1\_50\_CH630668

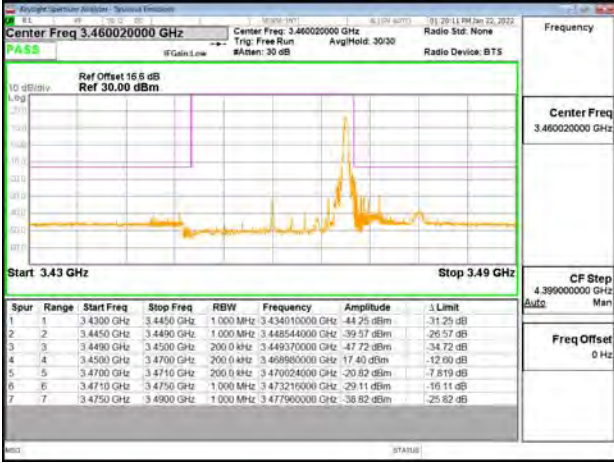

Band77-Part27\_20MHz\_DFT\_s\_OFDM\_SCS30kHz\_BPSK\_RB1\_50\_CH647334

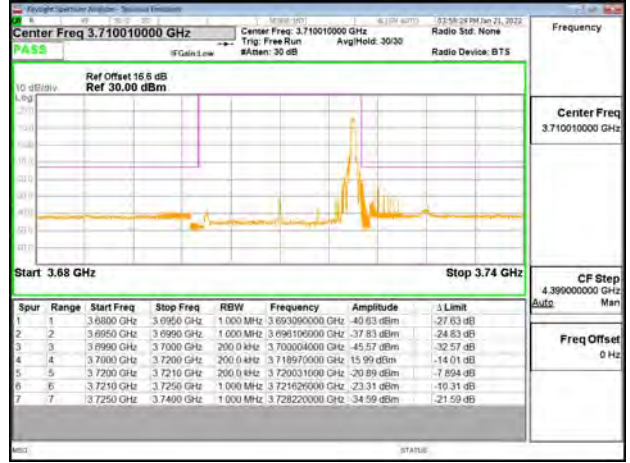

Band77-Part27\_20MHz\_DFT\_s\_OFDM\_SCS30kHz\_BPSK\_RB1\_50\_CH633334

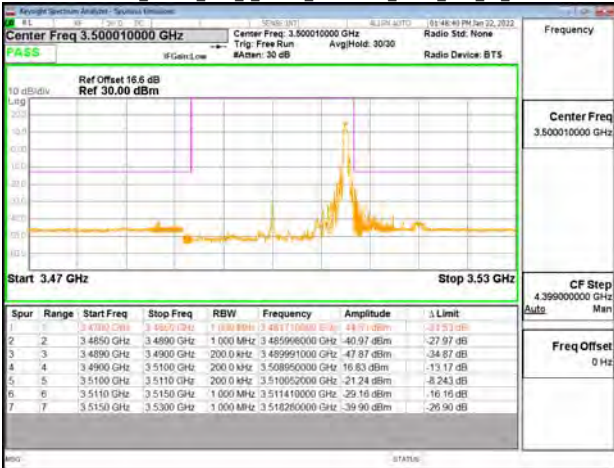

Band77-Part27\_20MHz\_DFT\_s\_OFDM\_SCS30kHz\_BPSK\_RB1\_50\_CH656000

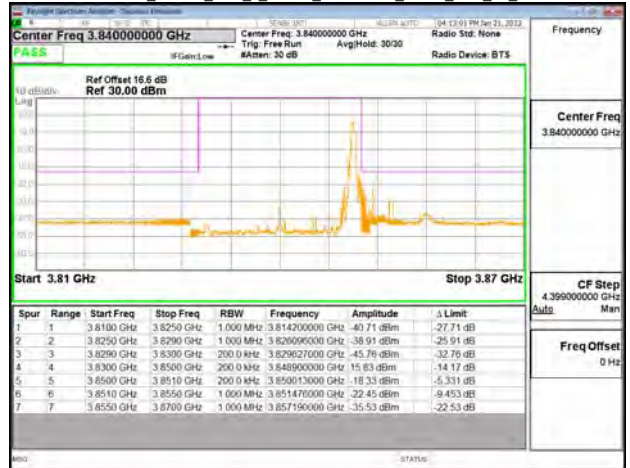

Band77-Part27\_20MHz\_DFT\_s\_OFDM\_SCS30kHz\_BPSK\_RB1\_50\_CH636000

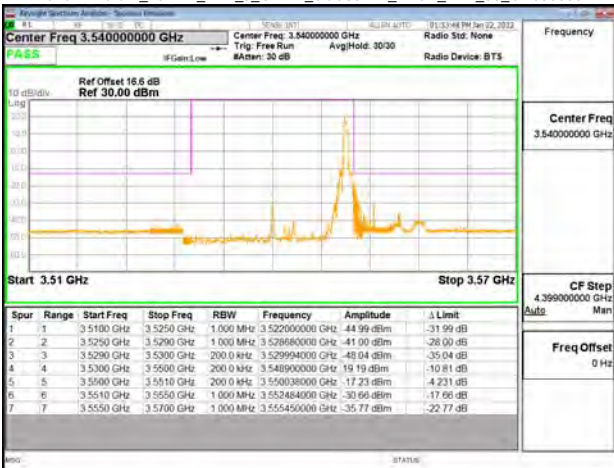

Band77-Part27\_20MHz\_DFT\_s\_OFDM\_SCS30kHz\_BPSK\_RB1\_50\_CH664666

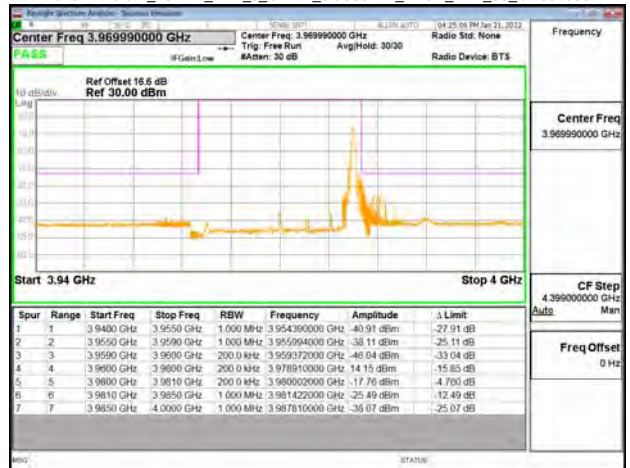

Unless otherwise stated the results shown in this test report refer only to the sample(s) tested and such sample(s) are retained for 90 days only.

除非另有說明，此報告結果僅對測試之樣品負責，同時此樣品僅保留90天。本報告未經本公司書面許可，不可部份複製。

This document is issued by the Company subject to its General Conditions of Service printed overleaf, available on request or accessible at <http://www.sgs.com.tw/Terms-and-Conditions> and for electronic format documents, subject to Terms and Conditions for Electronic Documents at <http://www.sgs.com.tw/Terms-and-Conditions>. Attention is drawn to the limitation of liability, indemnification and jurisdiction issues defined therein. Any holder of this document is advised that information contained herein reflects the Company's findings at the time of its intervention only and within the limits of Client's instructions, if any. The Company's sole responsibility is to its Client and this document does not exonerate parties to a transaction from exercising all their rights and obligations under the transaction documents. This document cannot be reproduced except in full, without prior written approval of the Company. Any unauthorized alteration, forgery or falsification of the content or appearance of this document is unlawful and offenders may be prosecuted to the fullest extent of the law.

Band77-Part27\_20MHz\_DFT\_s\_OFDM\_SCS30kHz\_BPSK\_RB50\_0\_CH630668

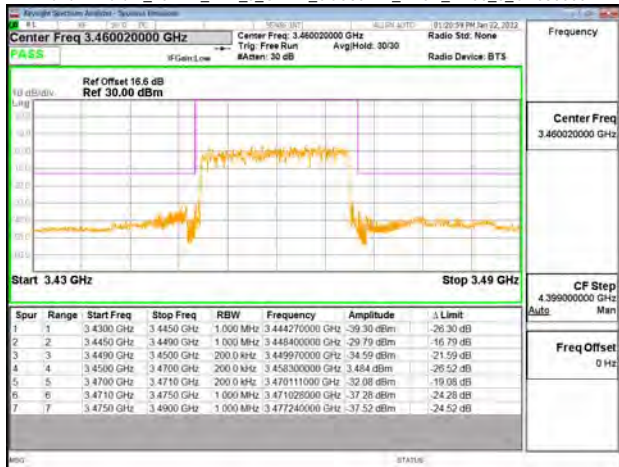

Band77-Part27\_20MHz\_DFT\_s\_OFDM\_SCS30kHz\_BPSK\_RB50\_0\_CH647334



Band77-Part27\_20MHz\_DFT\_s\_OFDM\_SCS30kHz\_BPSK\_RB50\_0\_CH633334



Band77-Part27\_20MHz\_DFT\_s\_OFDM\_SCS30kHz\_BPSK\_RB50\_0\_CH656000



Band77-Part27\_20MHz\_DFT\_s\_OFDM\_SCS30kHz\_BPSK\_RB50\_0\_CH636000



Band77-Part27\_20MHz\_DFT\_s\_OFDM\_SCS30kHz\_BPSK\_RB50\_0\_CH664666



Unless otherwise stated the results shown in this test report refer only to the sample(s) tested and such sample(s) are retained for 90 days only.

除非另有說明，此報告結果僅對測試之樣品負責，同時此樣品僅保留90天。本報告未經本公司書面許可，不可部份複製。

This document is issued by the Company subject to its General Conditions of Service printed overleaf, available on request or accessible at <http://www.sgs.com.tw/Terms-and-Conditions> and for electronic format documents, subject to Terms and Conditions for Electronic Documents at <http://www.sgs.com.tw/Terms-and-Conditions>. Attention is drawn to the limitation of liability, indemnification and jurisdiction issues defined therein. Any holder of this document is advised that information contained herein reflects the Company's findings at the time of its intervention only and within the limits of Client's instructions, if any. The Company's sole responsibility is to its Client and this document does not exonerate parties to a transaction from exercising all their rights and obligations under the transaction documents. This document cannot be reproduced except in full, without prior written approval of the Company. Any unauthorized alteration, forgery or falsification of the content or appearance of this document is unlawful and offenders may be prosecuted to the fullest extent of the law.

Band77-Part27\_20MHz\_CP\_OFDM\_SCS30kHz\_QPSK\_RB1\_0\_CH630668

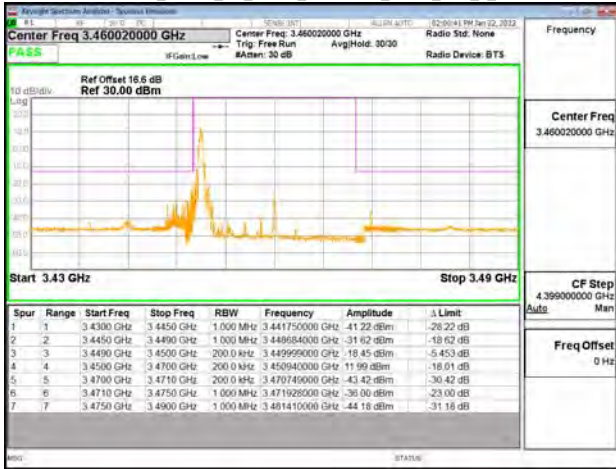

Band77-Part27\_20MHz\_CP\_OFDM\_SCS30kHz\_QPSK\_RB1\_0\_CH647334

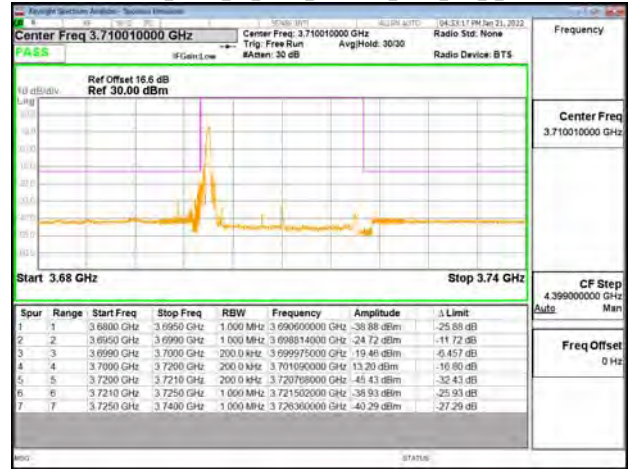

Band77-Part27\_20MHz\_CP\_OFDM\_SCS30kHz\_QPSK\_RB1\_0\_CH633334

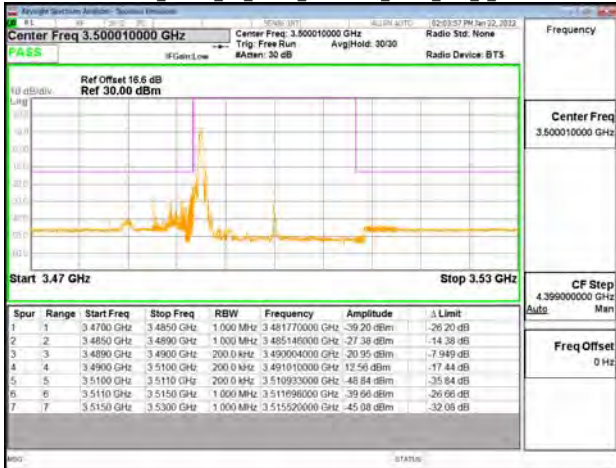

Band77-Part27\_20MHz\_CP\_OFDM\_SCS30kHz\_QPSK\_RB1\_0\_CH656000

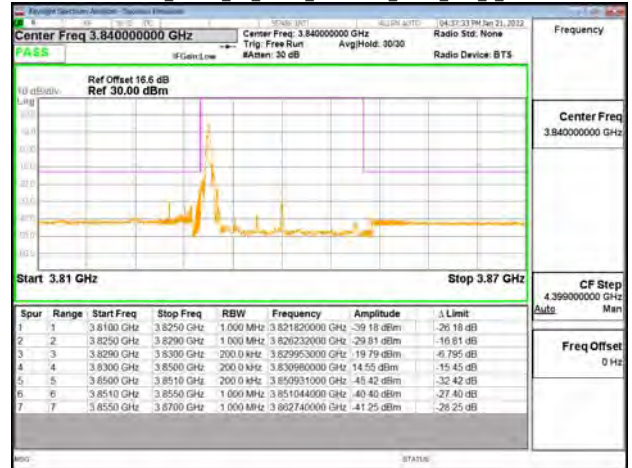

Band77-Part27\_20MHz\_CP\_OFDM\_SCS30kHz\_QPSK\_RB1\_0\_CH636000

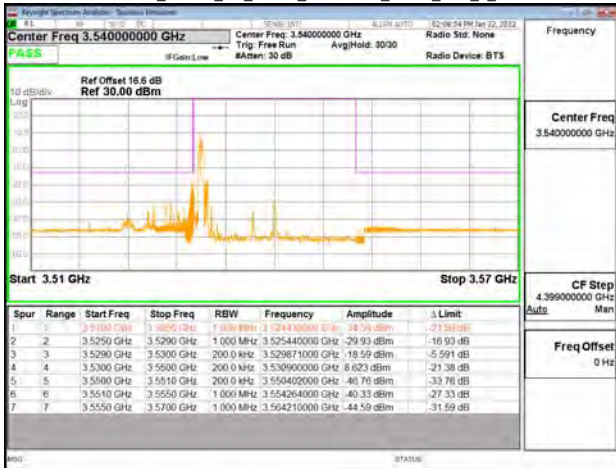

Band77-Part27\_20MHz\_CP\_OFDM\_SCS30kHz\_QPSK\_RB1\_0\_CH646666

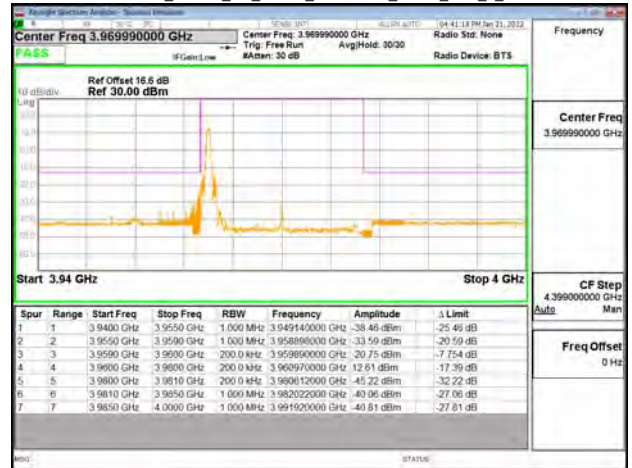

Unless otherwise stated the results shown in this test report refer only to the sample(s) tested and such sample(s) are retained for 90 days only.

除非另有說明，此報告結果僅對測試之樣品負責，同時此樣品僅保留90天。本報告未經本公司書面許可，不可部份複製。

This document is issued by the Company subject to its General Conditions of Service printed overleaf, available on request or accessible at <http://www.sgs.com.tw/Terms-and-Conditions> and for electronic format documents, subject to Terms and Conditions for Electronic Documents at <http://www.sgs.com.tw/Terms-and-Conditions>. Attention is drawn to the limitation of liability, indemnification and jurisdiction issues defined therein. Any holder of this document is advised that information contained herein reflects the Company's findings at the time of its intervention only and within the limits of Client's instructions, if any. The Company's sole responsibility is to its Client and this document does not exonerate parties to a transaction from exercising all their rights and obligations under the transaction documents. This document cannot be reproduced except in full, without prior written approval of the Company. Any unauthorized alteration, forgery or falsification of the content or appearance of this document is unlawful and offenders may be prosecuted to the fullest extent of the law.

Band77-Part27\_20MHz\_CP\_OFDM\_SCS30kHz\_QPSK\_RB1\_50\_CH630668

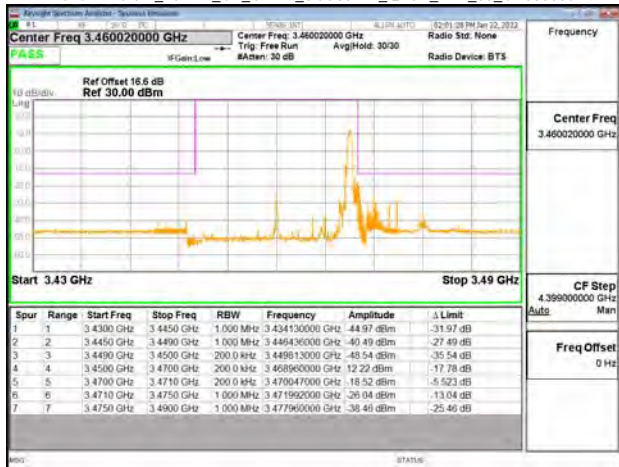

Band77-Part27\_20MHz\_CP\_OFDM\_SCS30kHz\_QPSK\_RB1\_50\_CH647334

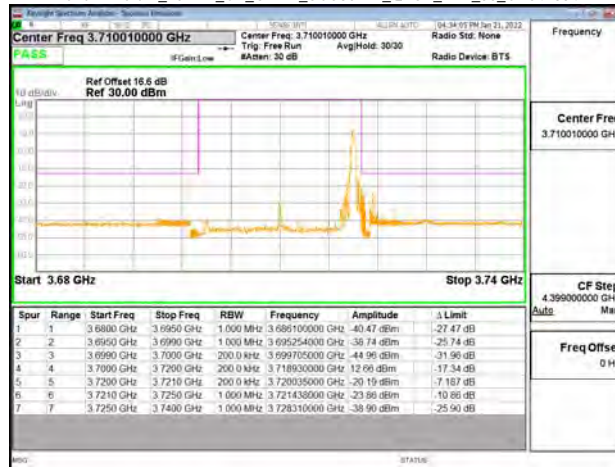

Band77-Part27\_20MHz\_CP\_OFDM\_SCS30kHz\_QPSK\_RB1\_50\_CH633334

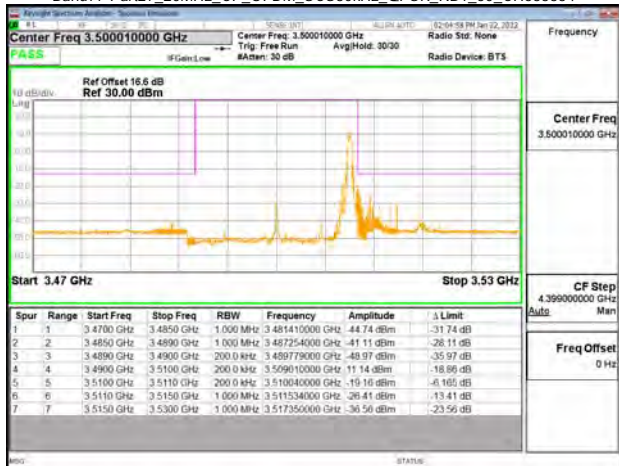

Band77-Part27\_20MHz\_CP\_OFDM\_SCS30kHz\_QPSK\_RB1\_50\_CH656000

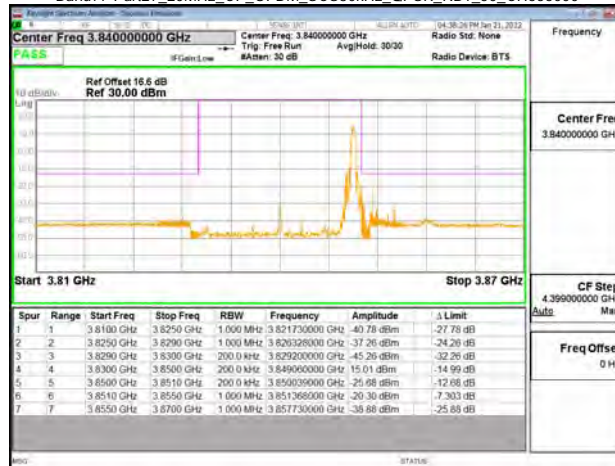

Band77-Part27\_20MHz\_CP\_OFDM\_SCS30kHz\_QPSK\_RB1\_50\_CH636000

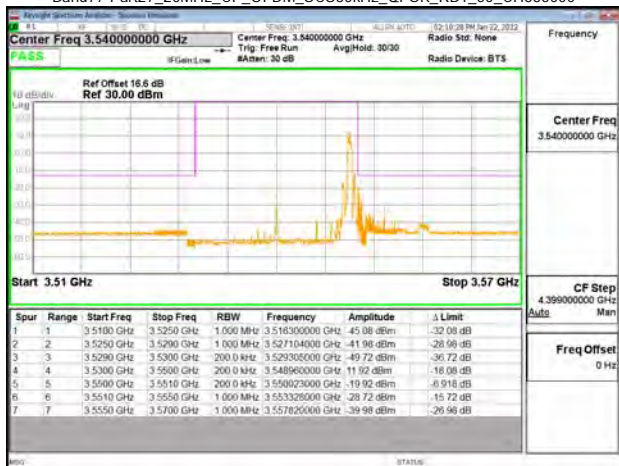

Band77-Part27\_20MHz\_CP\_OFDM\_SCS30kHz\_QPSK\_RB1\_50\_CH664666

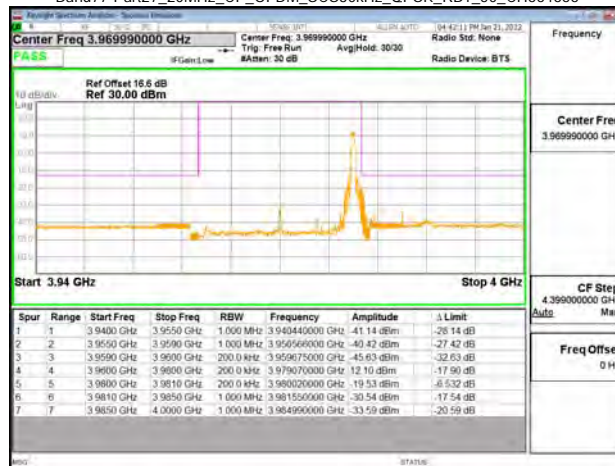

Unless otherwise stated the results shown in this test report refer only to the sample(s) tested and such sample(s) are retained for 90 days only.

除非另有說明，此報告結果僅對測試之樣品負責，同時此樣品僅保留90天。本報告未經本公司書面許可，不可部份複製。

This document is issued by the Company subject to its General Conditions of Service printed overleaf, available on request or accessible at <http://www.sgs.com.tw/Terms-and-Conditions> and for electronic format documents, subject to Terms and Conditions for Electronic Documents at <http://www.sgs.com.tw/Terms-and-Conditions>. Attention is drawn to the limitation of liability, indemnification and jurisdiction issues defined therein. Any holder of this document is advised that information contained herein reflects the Company's findings at the time of its intervention only and within the limits of Client's instructions, if any. The Company's sole responsibility is to its Client and this document does not exonerate parties to a transaction from exercising all their rights and obligations under the transaction documents. This document cannot be reproduced except in full, without prior written approval of the Company. Any unauthorized alteration, forgery or falsification of the content or appearance of this document is unlawful and offenders may be prosecuted to the fullest extent of the law.

Band77-Part27\_20MHz\_CP\_OFDM\_SCS30kHz\_QPSK\_RB51\_0\_CH630668



Band77-Part27\_20MHz\_CP\_OFDM\_SCS30kHz\_QPSK\_RB51\_0\_CH647334



Band77-Part27\_20MHz\_CP\_OFDM\_SCS30kHz\_QPSK\_RB51\_0\_CH633334

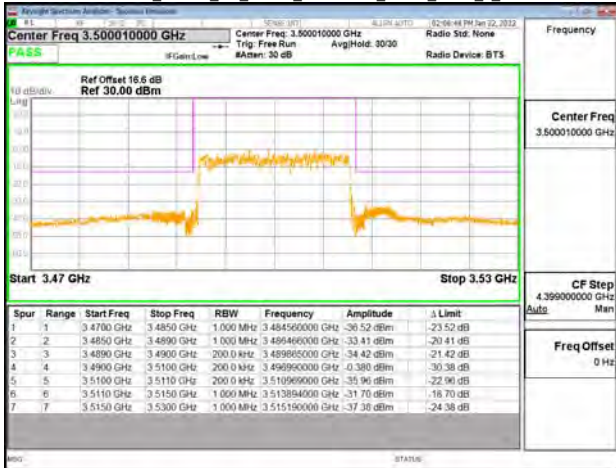

Band77-Part27\_20MHz\_CP\_OFDM\_SCS30kHz\_QPSK\_RB51\_0\_CH656000

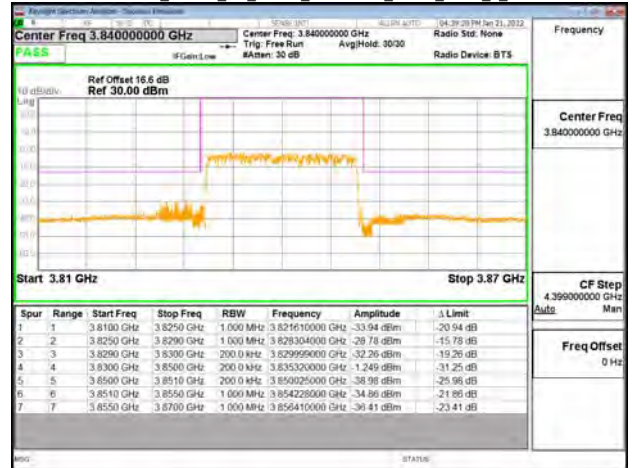

Band77-Part27\_20MHz\_CP\_OFDM\_SCS30kHz\_QPSK\_RB51\_0\_CH636000



Band77-Part27\_20MHz\_CP\_OFDM\_SCS30kHz\_QPSK\_RB51\_0\_CH664666



Unless otherwise stated the results shown in this test report refer only to the sample(s) tested and such sample(s) are retained for 90 days only. 除非另有說明，此報告結果僅對測試之樣品負責，同時此樣品僅保留90天。本報告未經本公司書面許可，不可部份複製。

This document is issued by the Company subject to its General Conditions of Service printed overleaf, available on request or accessible at <http://www.sgs.com.tw/Terms-and-Conditions> and for electronic format documents, subject to Terms and Conditions for Electronic Documents at <http://www.sgs.com.tw/Terms-and-Conditions>. Attention is drawn to the limitation of liability, indemnification and jurisdiction issues defined therein. Any holder of this document is advised that information contained herein reflects the Company's findings at the time of its intervention only and within the limits of Client's instructions, if any. The Company's sole responsibility is to its Client and this document does not exonerate parties to a transaction from exercising all their rights and obligations under the transaction documents. This document cannot be reproduced except in full, without prior written approval of the Company. Any unauthorized alteration, forgery or falsification of the content or appearance of this document is unlawful and offenders may be prosecuted to the fullest extent of the law.

Band77-Part27\_30MHz\_DFT\_s\_OFDM\_SCS30kHz\_BPSK\_RB1\_0\_CH631000

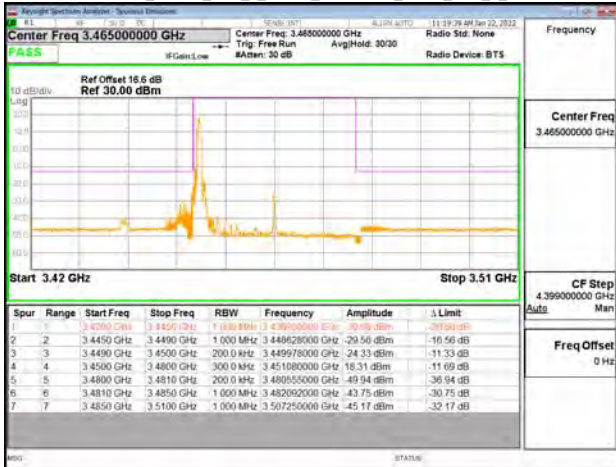

Band77-Part27\_30MHz\_DFT\_s\_OFDM\_SCS30kHz\_BPSK\_RB1\_0\_CH647668

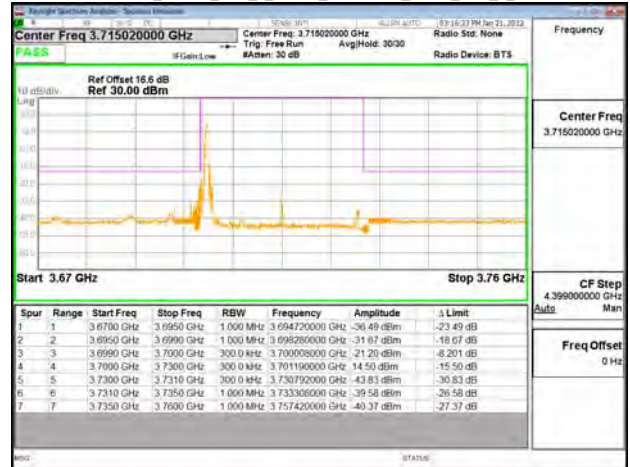

Band77-Part27\_30MHz\_DFT\_s\_OFDM\_SCS30kHz\_BPSK\_RB1\_0\_CH633334

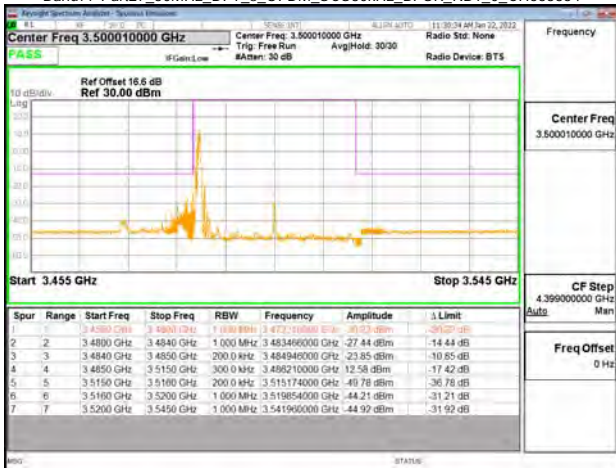

Band77-Part27\_30MHz\_DFT\_s\_OFDM\_SCS30kHz\_BPSK\_RB1\_0\_CH651000

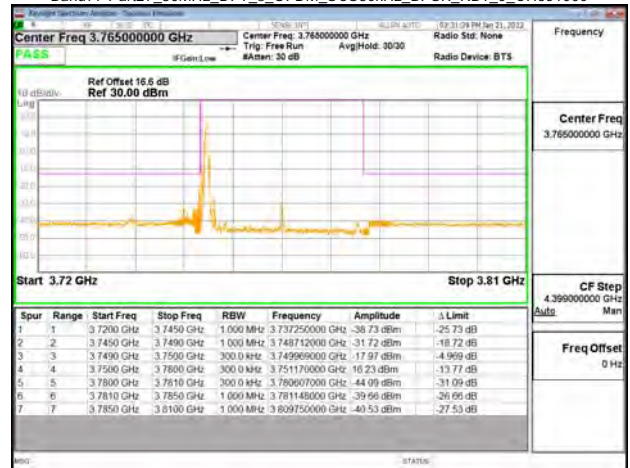

Band77-Part27\_30MHz\_DFT\_s\_OFDM\_SCS30kHz\_BPSK\_RB1\_0\_CH635666

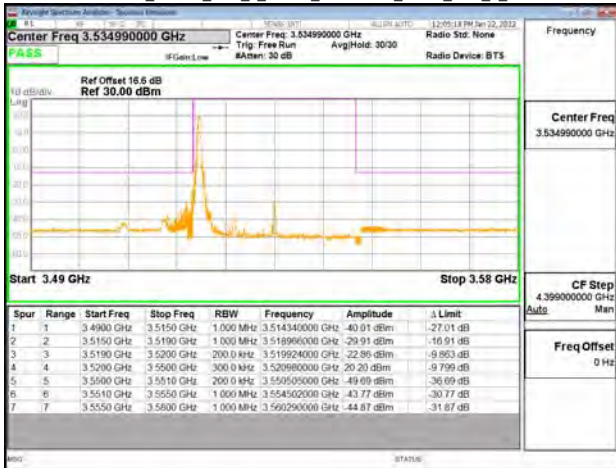

Band77-Part27\_30MHz\_DFT\_s\_OFDM\_SCS30kHz\_BPSK\_RB1\_0\_CH656000



Unless otherwise stated the results shown in this test report refer only to the sample(s) tested and such sample(s) are retained for 90 days only.

除非另有說明，此報告結果僅對測試之樣品負責，同時此樣品僅保留90天。本報告未經本公司書面許可，不可部份複製。

This document is issued by the Company subject to its General Conditions of Service printed overleaf, available on request or accessible at <http://www.sgs.com.tw/Terms-and-Conditions> and for electronic format documents, subject to Terms and Conditions for Electronic Documents at <http://www.sgs.com.tw/Terms-and-Conditions>. Attention is drawn to the limitation of liability, indemnification and jurisdiction issues defined therein. Any holder of this document is advised that information contained herein reflects the Company's findings at the time of its intervention only and within the limits of Client's instructions, if any. The Company's sole responsibility is to its Client and this document does not exonerate parties to a transaction from exercising all their rights and obligations under the transaction documents. This document cannot be reproduced except in full, without prior written approval of the Company. Any unauthorized alteration, forgery or falsification of the content or appearance of this document is unlawful and offenders may be prosecuted to the fullest extent of the law.