

TEST REPORT

of

FCC Part 2 Subpart J and Part 90 Subpart S

FCC ID: BEJTM05GTJN2

Equipment Under Test : Car Telematics Device
Model Name : TM05GTJN2
Variant Model Name(s) : -
Applicant : LG Electronics USA
Manufacturer : LG Electronics Inc.
Date of Receipt : 2020.11.16
Date of Test(s) : 2021.01.13 ~ 2021.02.05
Date of Issue : 2021.02.08

In the configuration tested, the EUT complied with the standards specified above. This test report does not assure KOLAS accreditation.

- 1) The results of this test report are effective only to the items tested.
- 2) The SGS Korea is not responsible for the sampling, the results of this test report apply to the sample as received.
- 3) This test report cannot be reproduced, except in full, without prior written permission of the Company.

Tested by:



Nancy Park

**Technical
Manager:**



Jinhyoung Cho

SGS Korea Co., Ltd. Gunpo Laboratory



INDEX

<u>Table of Contents</u>	Page
1. General Information -----	3
2. Spurious Radiated Emission -----	7
3. Conducted Output Power -----	14
4. Occupied Bandwidth -----	16
5. Spurious Emissions at Antenna Terminal -----	20
6. Band Edge -----	26
7. Frequency Stability -----	35

1. General Information

1.1. Testing Laboratory

SGS Korea Co., Ltd. (Gunpo Laboratory)

- 10-2, LS-ro 182beon-gil, Gunpo-si, Gyeonggi-do, Korea, 15807
- 4, LS-ro 182beon-gil, Gunpo-si, Gyeonggi-do, Korea, 15807

All SGS services are rendered in accordance with the applicable SGS conditions of service available on request and accessible at <http://www.sgs.com/en/Terms-and-Conditions.aspx>.

Phone No. : +82 31 688 0901
 Fax No. : +82 31 688 0921

1.2. Details of Applicant

Applicant : LG Electronics USA
 Address : 111 Sylvan Avenue, North Building, Englewood Cliffs, New Jersey, United States, 07632
 Contact Person : Kim, Dae-woong
 Phone No. : +1 201 266 2215

1.3. Details of Manufacturer

Company : LG Electronics Inc.
 Address : 10, Magokjungang 10-ro, Gangseo-gu, Seoul, Korea, 07796

1.4. Description of EUT

Kind of Product	Car Telematics Device
Model Name	TM05GTJN2
Serial Number	001VITA000080
Power Supply	DC 12 V
Rated Power	23 dB m
Frequency Range	814 MHz ~ 824 MHz
Emission Designator	LTE Band 26 (1.4 MHz): 1M09G7D (QPSK) / 1M09D7D (16QAM) LTE Band 26 (3 MHz): 2M68G7D (QPSK) / 2M68D7D (16QAM) LTE Band 26 (5 MHz): 4M50G7D (QPSK) / 4M52D7D (16QAM) LTE Band 26 (10 MHz): 8M94G7D (QPSK) / 8M94D7D (16QAM) LTE Band 26 (15 MHz): 13M5G7D (QPSK) / 13M5D7D (16QAM)
Modulation Technique	QPSK, 16QAM, 64QAM
Antenna Type	External antenna
Antenna gain	-3.18 dB i
H/W Version	Rev.D
S/W Version	V9.1.02

1.5. Test Equipment List

Equipment	Manufacturer	Model	S/N	Cal. Date	Cal. Interval	Cal. Due
Signal Generator	R&S	SMR40	100272	Jun. 18, 2020	Annual	Jun. 18, 2021
Signal Generator	R&S	SMBV100A	255834	Jun. 03, 2020	Annual	Jun. 03, 2021
Spectrum Analyzer	R&S	FSV30	103101	Jun. 01, 2020	Annual	Jun. 01, 2021
Spectrum Analyzer	Agilent	N9020A	MY53421758	Sep. 04, 2020	Annual	Sep. 04, 2021
Mobile Test Unit	R&S	CMW500	144034	Feb. 28, 2020	Annual	Feb. 28, 2021
Mobile Test Unit	Anritsu	MT8821C	6262192291	Oct. 08, 2020	Annual	Oct. 08, 2021
Power Meter	Anritsu	ML2495A	1223004	Jun. 01, 2020	Annual	Jun. 01, 2021
Power Sensor	Anritsu	MA2411B	1207272	Jun. 01, 2020	Annual	Jun. 01, 2021
Temperature Chamber	ESPEC CORP.	PL-1J	15000796	Nov. 06, 2020	Annual	Nov. 06, 2021
High Pass Filter	Wainwright Instrument GmbH	WHKX10-900-1000-18000-40SS	7	Mar. 04, 2020	Annual	Mar. 04, 2021
Directional Coupler	KRYTAR	152613	122660	Jun. 11, 2020	Annual	Jun. 11, 2021
DC Power Supply	Agilent	U8002A	MY53150029	Jun. 04, 2020	Annual	Jun. 04, 2021
Preamplifier	H.P.	8447F	2944A03909	Aug. 06, 2020	Annual	Aug. 06, 2021
Signal Conditioning Unit	R&S	SCU-18	10117	Jun. 10, 2020	Annual	Jun. 10, 2021
Test Receiver	R&S	ESU26	100109	Feb. 18, 2020	Annual	Feb. 18, 2021
Loop Antenna	Schwarzbeck Mess-Elektronik	FMZB 1519	1519-039	Aug. 22, 2019	Biennial	Aug. 22, 2021
Bilog Antenna	Schwarzbeck Mess-Elektronik	VULB 9163	396	Mar. 21, 2019	Biennial	Mar. 21, 2021
Horn Antenna	R&S	HF906	100326	Feb. 14, 2020	Annual	Feb. 14, 2021
Horn Antenna	R&S	HF907	102270	Feb. 14, 2020	Annual	Feb. 14, 2021
Antenna Master	Innco systems GmbH	MM4000	N/A	N.C.R.	N/A	N.C.R.
Turn Table	Innco systems GmbH	DS 1200S	N/A	N.C.R.	N/A	N.C.R.
Controller	Innco systems GmbH	CONTROLLER CO3000-4P	CO3000/963/383 30516/L	N.C.R.	N/A	N.C.R.
Anechoic Chamber	SY Corporation	L x W x H (9.6 m x 6.4 m x 6.4 m)	N/A	N.C.R.	N/A	N.C.R.
Coaxial Cable	RFONE	MWX221-NMSNMS (4 m)	J1023142	Dec. 01, 2020	Semi-annual	Jun. 01, 2021
Coaxial Cable	RFONE	SFX086-NMNM-10M (10 m)	20200324001	Dec. 01, 2020	Semi-annual	Jun. 01, 2021
Coaxial Cable	Rosenberger	LA1-C006-1500	131014 07/20	Aug. 21, 2020	Semi-annual	Feb. 21, 2021
Coaxial Cable	Rosenberger	LA1-C006-1500	131014 10/20	Aug. 21, 2020	Semi-annual	Feb. 21, 2021
Coaxial Cable	Rosenberger	LA1-C006-1500	131014 11/20	Aug. 21, 2020	Semi-annual	Feb. 21, 2021

► **Support Equipment**

Description	Manufacturer	Model	Serial Number
N/A	-	-	-

1.6. Summary of Test Results

The EUT has been tested according to the following specifications:

APPLIED STANDARD: FCC Part 2 and 90		
Section	Test Item(s)	Result
§2.1046 §90.635(b)	E.R.P./E.I.R.P.	Complied
§2.1053 §90.691(a)	Spurious Radiated Emission	Complied
§2.1046	Conducted Output Power	Complied
§2.1049	Occupied Bandwidth	Complied
§2.1051 §90.691(a)	Spurious Emission at Antenna Terminal	Complied
§90.691(a)	Band Edge	Complied
§2.1055 §90.213(a)	Frequency Stability	Complied

1.7. Sample Calculation for Offset

Where relevant, the following sample calculation is provided:

1.7.1. Conducted Test

Offset value (dB) = Directional Coupler (dB) + Cable loss (dB)

1.7.2. Radiation Test

- E.I.R.P. (dB m) = Measured level (dB μ V) + Antenna factor (dB) + Cable loss (dB) + 20 Log D - 104.5; where D is the measurement distance in meters.
- E.R.P. (dB m) = E.I.R.P. (dB m) - 2.15 (dB)

1.8. Measurement Uncertainty

Where relevant, the following measurement uncertainty levels have been estimated for tests performed on the apparatus:

Parameter	Uncertainty	
Radiated Emission, 9 kHz to 30 MHz	H	± 3.66 dB
	V	± 3.66 dB
Radiated Emission, below 1 GHz	H	± 4.90 dB
	V	± 4.82 dB
Radiated Emission, above 1 GHz	H	± 3.62 dB
	V	± 3.64 dB

Uncertainty figures are valid to a confidence level of 95 %.

1.9. Test Report Revision

Revision	Report Number	Date of Issue	Description
0	F690501-RF-RTL001648	2021.02.08	Initial

2. Spurious Radiated Emission

2.1. Test Setup

The diagram below shows the test setup that is utilized to make the measurements for emission from 9 kHz to 30 MHz.

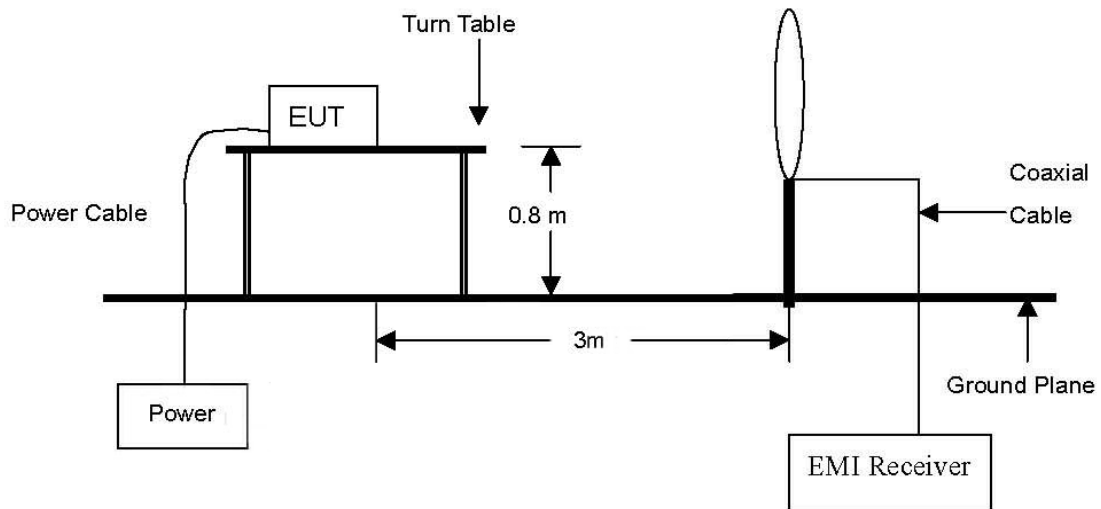

The diagram below shows the test setup that is utilized to make the measurements for emission from 30 MHz to 1 GHz.

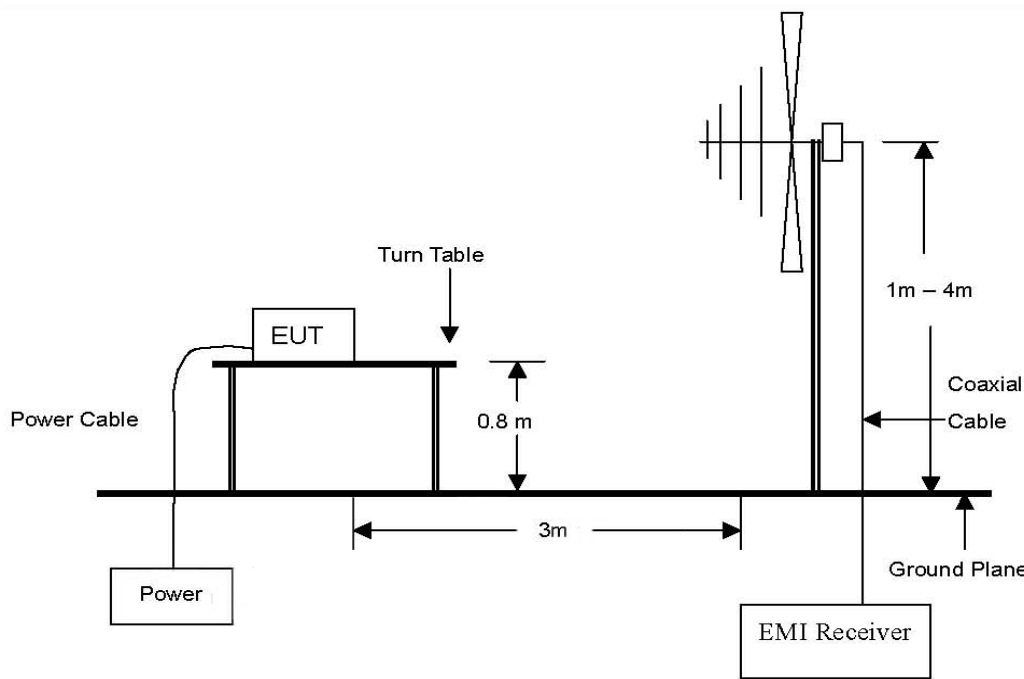

The diagram below shows the test setup that is utilized to make the measurements for emission from 1 GHz to 9 GHz.

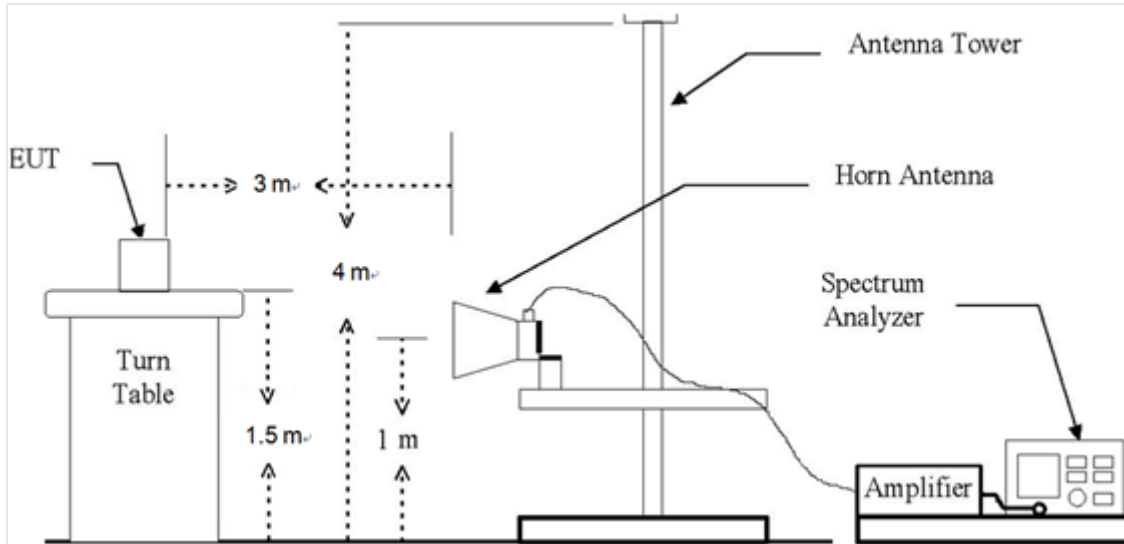

2.2. Limit

2.2.1. Limit of E.R.P./E.I.R.P.

- §90.635(b), the maximum output power of the transmitter for mobile stations is 100 watts (20 dB W).

2.2.2. Limit of Spurious Radiated Emission

- §90.691(a), out-of-band emission requirement shall apply only to the “outer” channels included in an EA license and to spectrum adjacent to interior channels used by incumbent licensees. The emission limits are as follows:

(1) For any frequency removed from the EA licensee's frequency block by up to and including 37.5 kHz, the power of any emission shall be attenuated below the transmitter power (P) in watts by at least $116 \text{ Log}_{10} (f / 6.1)$ decibels or $50 + 10 \text{ Log}_{10} (P)$ decibels or 80 decibels, whichever is the lesser attenuation, where f is the frequency removed from the center of the outer channel in the block in kilohertz and where f is greater than 12.5 kHz.

(2) For any frequency removed from the EA licensee's frequency block greater than 37.5 kHz, the power of any emission shall be attenuated below the transmitter power (P) in watts by at least $43 + 10 \text{ Log}_{10} (P)$ decibels or 80 decibels, whichever is the lesser attenuation, where f is the frequency removed from the center of the outer channel in the block in kilohertz and where f is greater than 37.5 kHz.

2.3. Test Procedure: Based on ANSI/TIA 603E: 2016 and ANSI C63.26-2015

1. On a test site, the EUT shall be placed at 0.8 m or 1.5 m height on a turn table, and in the position close to normal use as declared by the applicant.
2. The test antenna shall be oriented initially for vertical polarization located 3 m from EUT to correspond to the fundamental frequency of the transmitter.
3. The output of the test antenna shall be connected to the measuring receiver and the peak detector is used for the measurement.
4. The maximized power level is recorded using the spectrum analyzer "Channel Power" function with the integration band set to the emissions occupied bandwidth, $RBW = 1-5\%$ of the OBW (not to exceed 1 MHz), $VBW \geq 3 \times RBW$, Detector = power averaging (rms), sweep time = auto, trace average at least 100 traces in power averaging (rms) mode, per the guidelines of KDB 971168 D01 Power Meas License Digital Systems v03r01.
5. Radiated spurious emissions measurement method was set as follows:
RBW = 100 kHz for emissions below 1 GHz and 1 MHz for emissions above 1 GHz, $VBW \geq 3 \times RBW$,
Detector = RMS, trace mode = max hold, per the guidelines of ANSI C63.26-2015 and KDB 971168 D01 Power Meas License Digital Systems v03r01.
6. The transmitter shall be switched on, the measuring receiver shall be tuned to the frequency of the transmitter under test.
7. The test antenna shall be raised and lowered through the specified range of height until the maximum signal level is detected by the measuring receiver.
8. The transmitter shall be rotated through 360° in the horizontal plane, until the maximum signal level is detected by the measuring receiver.
9. The test antenna shall be raised and lowered again through the specified range of height until the maximum signal level is detected by the measuring receiver.
10. The maximum signal level detected by the measuring receiver shall be noted.
11. In necessary, the input attenuator setting on the measuring receiver shall be adjusted in order to increase the sensitivity of the measuring receiver.
12. The test antenna shall be raised and lowered through the specified range of height to ensure that the maximum signal is received.
13. The measurement shall be repeated with the test antenna orientated for horizontal polarization.

2.4. Test Result for E.R.P./E.I.R.P.

Ambient temperature : (23 ± 1) °C
 Relative humidity : 47 % R.H.

Band	Frequency (MHz)	Maximum Conducted Power (dB m)	Maximum Conducted Power (W)	Antenna Gain (dB i)	Maximum E.I.R.P. (dB m)	Maximum E.I.R.P. (W)	Maximum E.R.P. (dB m)	Maximum E.R.P. (W)	Output Power Limit
26	814 ~ 824	25.50	0.355	-3.18	22.32	0.171	20.17	0.104	100 W E.R.P.

Remark;

1. E.I.R.P. (dB m) = Maximum Conducted Power (dB m) + Antenna Gain (dB i)
2. E.R.P. (dB m) = E.I.R.P. (dB m) - 2.15 (dB); where E.R.P. and E.I.R.P. are expressed in consistent units.

2.5. Spurious Radiated Emission

LTE band 26 (1.4 MHz – QPSK)

Frequency (MHz)	Measured Level (dB μ V)	Ant. Pol.	AF (dB/m)	AMP+CL (dB)	E (dB μ V/m)	CF (dB)	E.R.P. (dB m)	Limit (dB m)	Margin (dB)
Low Channel (814.7 MHz)									
Above 0.009	Not detected	-	-	-	-	-	-	-	-
Middle Channel (819.0 MHz)									
Above 0.009	Not detected	-	-	-	-	-	-	-	-
High Channel (823.3 MHz)									
Above 0.009	Not detected	-	-	-	-	-	-	-	-

* 1.4 BW 1 RB size / 0 Offset for B26

LTE band 26 (3 MHz – QPSK)

Frequency (MHz)	Measured Level (dB μ V)	Ant. Pol.	AF (dB/m)	AMP+CL (dB)	E (dB μ V/m)	CF (dB)	E.R.P. (dB m)	Limit (dB m)	Margin (dB)
Low Channel (815.5 MHz)									
Above 0.009	Not detected	-	-	-	-	-	-	-	-
Middle Channel (819.0 MHz)									
Above 0.009	Not detected	-	-	-	-	-	-	-	-
High Channel (822.5 MHz)									
Above 0.009	Not detected	-	-	-	-	-	-	-	-

* 3 BW 1 RB size / 0 Offset for B26

LTE band 26 (5 MHz – QPSK)

Frequency (MHz)	Measured Level (dB μ V)	Ant. Pol.	AF (dB/m)	AMP+CL (dB)	E (dB μ V/m)	CF (dB)	E.R.P. (dB m)	Limit (dB m)	Margin (dB)
Low Channel (816.5 MHz)									
Above 0.009	Not detected	-	-	-	-	-	-	-	-
Middle Channel (819.0 MHz)									
Above 0.009	Not detected	-	-	-	-	-	-	-	-
High Channel (821.5 MHz)									
Above 0.009	Not detected	-	-	-	-	-	-	-	-

* 5 BW 1 RB size / 0 Offset for B26

LTE band 26 (10 MHz – QPSK)

Frequency (MHz)	Measured Level (dB μ V)	Ant. Pol.	AF (dB/m)	AMP+CL (dB)	E (dB μ V/m)	CF (dB)	E.R.P. (dB m)	Limit (dB m)	Margin (dB)
Middle Channel (819.0 MHz)									
Above 0.009	Not detected	-	-	-	-	-	-	-	-

* 10 BW 1 RB size / 0 Offset for B26

LTE band 26 (15 MHz – QPSK)

Frequency (MHz)	Measured Level (dB μ V)	Ant. Pol.	AF (dB/m)	AMP+CL (dB)	E (dB μ V/m)	CF (dB)	E.R.P. (dB m)	Limit (dB m)	Margin (dB)
Middle Channel (821.5 MHz)									
Above 0.009	Not detected	-	-	-	-	-	-	-	-

* 15 BW 1 RB size / 0 Offset for B26

Remark;

1. E (dB μ V/m) = Measured Level (dB μ V) + Antenna Factor (dB/m) + Cable Loss (dB).
2. E.I.R.P. (dB m) = E (dB μ V/m) + 20 log D - 104.8; where D is the measurement distance in meters.
3. E.R.P. (dB m) = E.I.R.P. (dB m) - 2.15 (dB); where E.R.P. and E.I.R.P. are expressed in consistent units.
4. CF (dB) (E.R.P.) = 20 log D - 104.8 - 2.15.
5. AF = Antenna Factor, CL = Cable Loss, CF = Conversion Factor.

3. Conducted Output Power

3.1. Limit

CFR 47, Section FCC §2.1046.

3.2. Test Procedure

Output power shall be measured at the RF output terminals for all configurations.

1. The RF output of the transmitter was connected to the input of the mobile test unit in order to establish communication with the EUT.
2. The EUT was set up for the max. output power with pseudo random data modulation by using mobile test unit parameters.
3. The measurement performed using a wideband RF power meter.
4. This EUT was tested under all configurations and the highest power was investigated and reported.

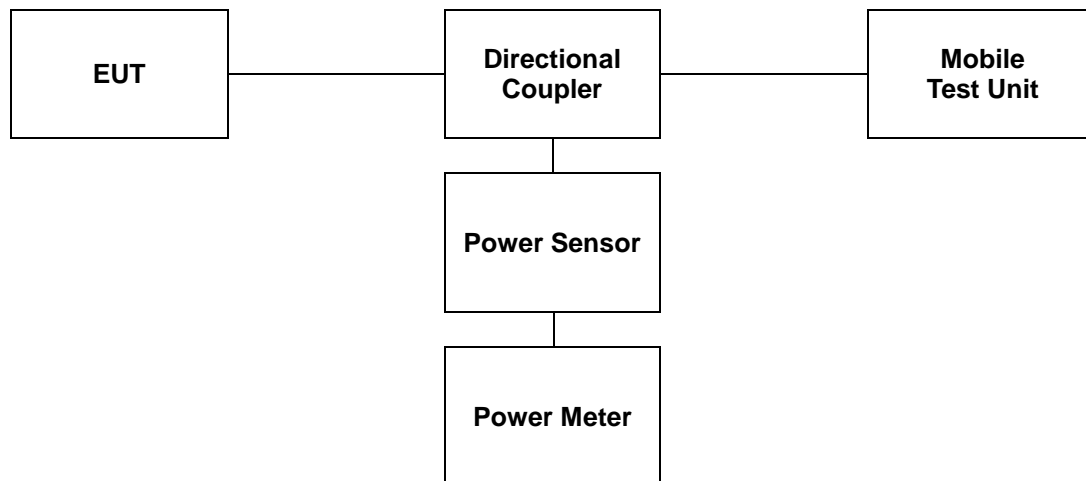

3.3. Test Result

Ambient temperature : (23 ± 1) °C
 Relative humidity : 47 % R.H.

Band	Bandwidth (MHz)	RB Size	RB Offset	Conducted Output Power (dB m)								
				QPSK			16QAM			64QAM		
				26697	26740	26783	26697	26740	26783	26697	26740	26783
				814.7 (MHz)	819.0 (MHz)	823.3 (MHz)	814.7 (MHz)	819.0 (MHz)	823.3 (MHz)	814.7 (MHz)	819.0 (MHz)	823.3 (MHz)
26	1.4	1	0	22.30	22.19	22.22	21.52	21.30	21.48	21.24	21.34	21.31
		1	3	22.41	22.27	22.38	21.31	21.43	21.44	21.41	21.25	21.22
		1	5	22.32	22.22	22.25	21.44	21.31	21.35	21.37	21.34	21.31
		3	0	22.20	22.14	22.24	21.15	21.24	21.24	21.24	21.23	21.21
		3	2	22.47	22.30	22.41	21.15	21.21	21.20	21.35	21.21	21.19
		3	3	22.15	22.11	22.19	21.19	21.21	21.21	21.32	21.29	21.25
	Bandwidth (MHz)	RB Size	RB Offset	26705	26740	26775	26705	26740	26775	26705	26740	26775
				815.5 (MHz)	819.0 (MHz)	822.5 (MHz)	815.5 (MHz)	819.0 (MHz)	822.5 (MHz)	815.5 (MHz)	819.0 (MHz)	822.5 (MHz)
	3	1	0	22.26	22.30	22.32	21.35	21.38	21.39	21.32	21.34	21.39
		1	8	22.32	22.41	22.40	21.30	21.35	21.35	21.31	21.36	21.35
		1	14	22.25	22.28	22.29	21.32	21.36	21.34	21.30	21.34	21.34
		8	0	21.16	21.21	21.24	20.31	20.33	20.35	20.31	20.30	20.35
		8	4	21.15	21.18	21.19	20.35	20.31	20.30	20.35	20.35	20.34
		8	7	21.11	21.15	21.16	20.34	20.30	20.32	20.34	20.36	20.31
	Bandwidth (MHz)	RB Size	RB Offset	26715	26740	26765	26715	26740	26765	26715	26740	26765
				816.5 (MHz)	819.0 (MHz)	821.5 (MHz)	816.5 (MHz)	819.0 (MHz)	821.5 (MHz)	816.5 (MHz)	819.0 (MHz)	821.5 (MHz)
	5	1	0	22.25	22.19	22.30	21.48	21.30	21.38	21.24	21.34	21.34
		1	12	22.34	22.29	22.35	21.34	21.43	21.35	21.41	21.25	21.36
		1	24	22.28	22.24	22.27	21.40	21.31	21.36	21.37	21.34	21.34
		12	0	21.12	21.14	21.18	20.14	20.24	20.36	20.24	20.23	20.30
		12	7	21.41	21.13	21.17	20.17	20.23	20.23	20.35	20.21	20.35
		12	13	21.05	21.11	21.12	20.18	20.21	20.31	20.32	20.29	20.36
	Bandwidth (MHz)	RB Size	RB Offset	26740	26740	26740	26740	26740	26740	26740	26740	
				819.0 (MHz)	819.0 (MHz)	819.0 (MHz)	819.0 (MHz)	819.0 (MHz)	819.0 (MHz)	819.0 (MHz)	819.0 (MHz)	
	10	1	0	22.13			21.23			21.32		
		1	25	22.24			21.34			21.25		
		1	49	22.20			21.23			21.25		
		25	0	21.15			20.21			20.23		
		25	12	21.13			20.23			20.24		
		25	25	21.11			20.21			20.23		
Bandwidth (MHz)	RB Size	RB Offset	26765	26765	26765	26765	26765	26765	26765			
			821.5 (MHz)	821.5 (MHz)	821.5 (MHz)	821.5 (MHz)	821.5 (MHz)	821.5 (MHz)	821.5 (MHz)			
15	1	0	22.55			21.39			21.34			
	1	37	22.45			21.41			21.38			
	1	74	22.37			21.35			21.33			
	36	0	21.28			20.38			20.31			
	36	20	21.27			20.26			20.34			
	36	39	21.22			20.33			20.37			
Bandwidth (MHz)	RB Size	RB Offset	21.35			20.31			20.36			
			21.35			20.31			20.36			

4. Occupied Bandwidth

4.1. Limit

CFR 47, Section FCC §2.1049

4.2. Test Procedure

The test follows section 5.4.4 of ANSI C63.26-2015.

- a. The spectrum analyzer center frequency is set to the nominal EUT channel center frequency. The frequency span for the spectrum analyzer shall be set wide enough to capture all modulation products including the emission skirts (typically a span of $1.5 \times \text{OBW}$ is sufficient).
- b. The nominal IF filter 3 dB bandwidth (RBW) shall be in the range of 1 % to 5 % of the anticipated OBW, and the VBW shall be set $\geq 3 \times \text{RBW}$.
- c. Set the reference level of the instrument as required to prevent the signal amplitude from exceeding the maximum spectrum analyzer input mixer level for linear operation. See guidance provided in 4.2.3.
- d. Set the detection mode to peak, and the trace mode to max-hold.
- e. If the instrument does not have a 99 % OBW function, recover the trace data points and sum directly in linear power terms. Place the recovered amplitude data points, beginning at the lowest frequency, in a running sum until 0.5 % of the total is reached. Record that frequency as the lower OBW frequency. Repeat the process until 99.5 % of the total is reached and record that frequency as the upper OBW frequency. The 99 % power OBW can be determined by computing the difference these two frequencies.
- f. The OBW shall be reported and plot(s) of the measuring instrument display shall be provided with the test report. The frequency and amplitude axis and scale shall be clearly labeled. Tabular data can be reported in addition to the plot(s).

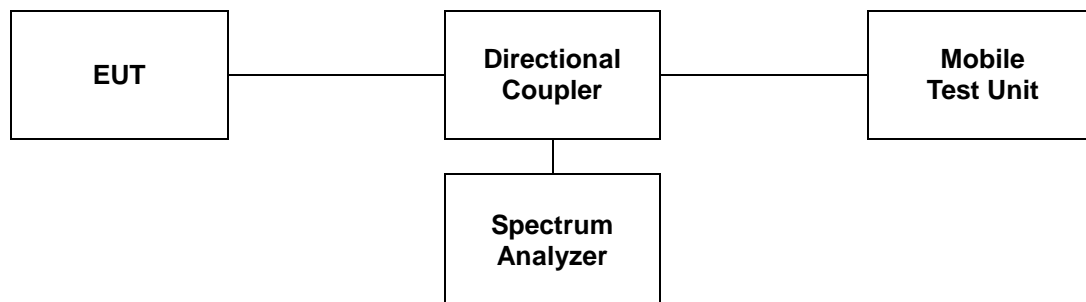

4.3 Test Results

Ambient temperature : (23 ± 1) °C
 Relative humidity : 47 % R.H.

Band	Bandwidth (MHz)	Frequency (MHz)	Occupied Bandwidth (MHz)	
			QPSK	16QAM
26	1.4	819.0	1.090	1.090
	3		2.683	2.683
	5		4.501	4.515
	10		8.944	8.944
	15	821.5	13.459	13.459

Note;

There is no limit required and power is the same for low, middle and high channel; therefore, All channels were tested but only middle channel was reported.

- Test plots

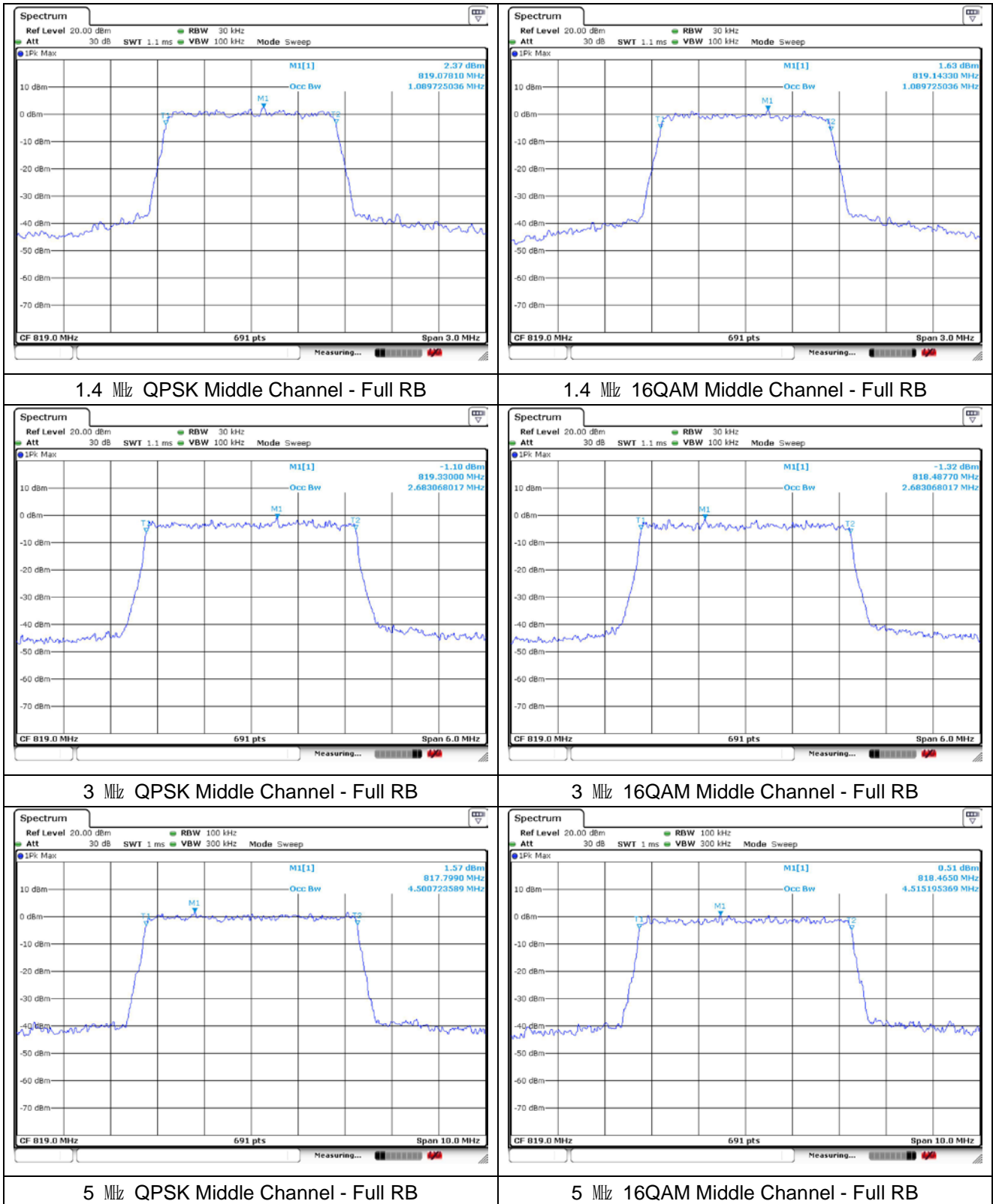

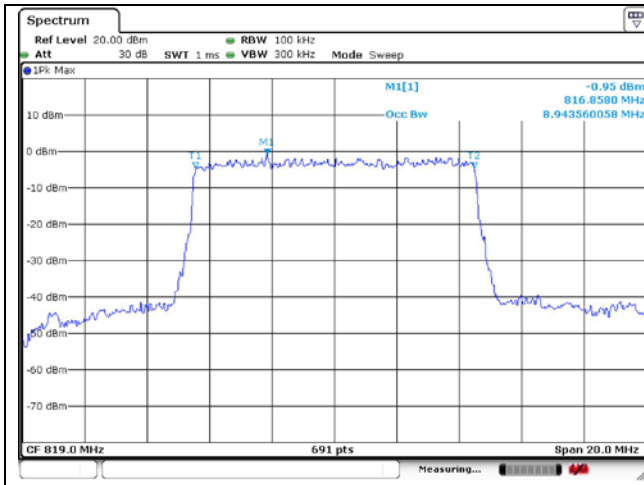

10 MHz QPSK Middle Channel - Full RB

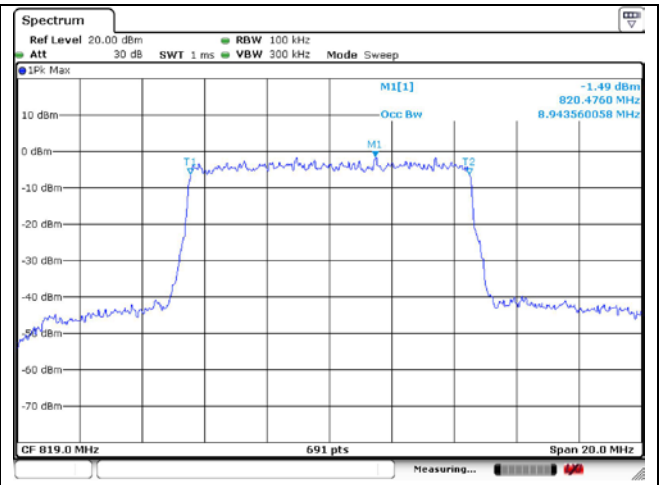

10 MHz 16QAM Middle Channel - Full RB

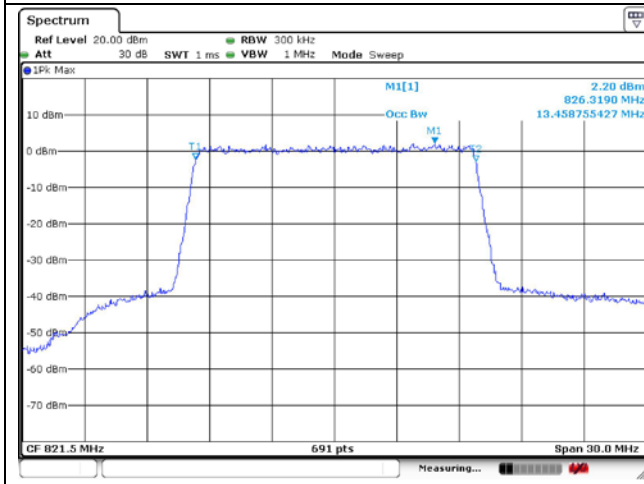

15 MHz QPSK Low Channel - Full RB

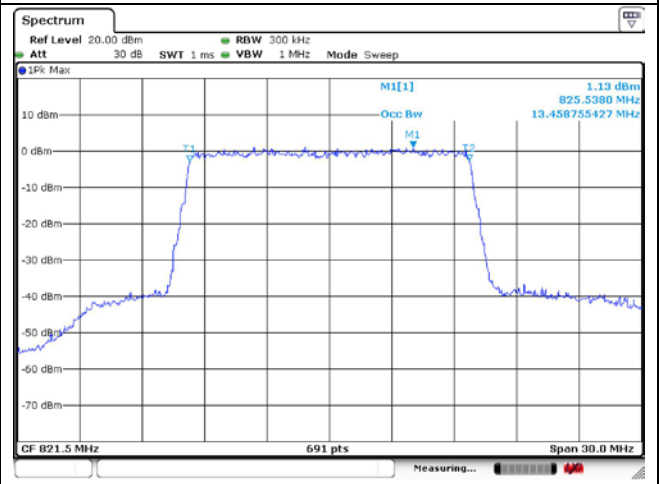

15 MHz 16QAM Low Channel - Full RB

5. Spurious Emissions at Antenna Terminal

5.1. Limit

- §90.691(a), out-of-band emission requirement shall apply only to the “outer” channels included in an EA license and to spectrum adjacent to interior channels used by incumbent licensees. The emission limits are as follows:

(1) For any frequency removed from the EA licensee's frequency block by up to and including 37.5 kHz, the power of any emission shall be attenuated below the transmitter power (P) in watts by at least $116 \text{ Log}_{10} (f / 6.1)$ decibels or $50 + 10 \text{ Log}_{10} (P)$ decibels or 80 decibels, whichever is the lesser attenuation, where f is the frequency removed from the center of the outer channel in the block in kilohertz and where f is greater than 12.5 kHz.

(2) For any frequency removed from the EA licensee's frequency block greater than 37.5 kHz, the power of any emission shall be attenuated below the transmitter power (P) in watts by at least $43 + 10 \text{ Log}_{10} (P)$ decibels or 80 decibels, whichever is the lesser attenuation, where f is the frequency removed from the center of the outer channel in the block in kilohertz and where f is greater than 37.5 kHz.

5.2. Test Procedure

The test follows section 5.7 of ANSI C63.26-2015.

1. Start frequency was set to 9 kHz and stop frequency was set to at least 10* the fundamental frequency.
2. Detector = Peak.
3. Trace mode = Max hold.
4. Sweep time = Auto couple.
5. The trace was allowed to stabilize.
6. Please see notes below for RBW and VBW settings.
7. For plots showing conducted spurious emissions from 9 kHz to 9 GHz, all path loss of wide frequency range was investigated and compensated to spectrum analyzer as correction factor.

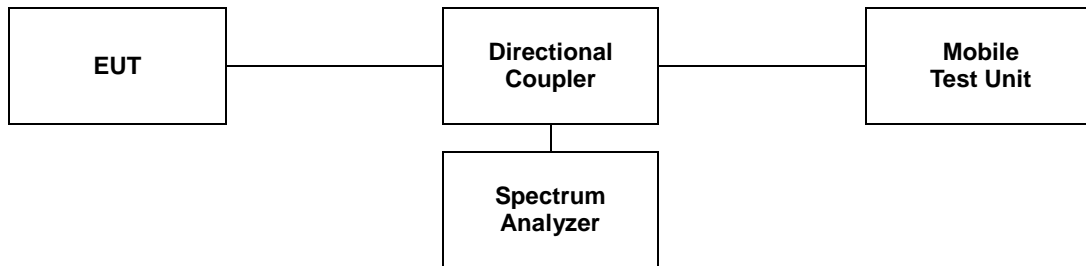

Note;

Compliance with the applicable limits is based on the use of measurement instrumentation employing a resolution bandwidth of 100 kHz or greater for frequencies less than 1 GHz and frequencies greater than 1 GHz. However, in the 1 MHz bands immediately outside and adjacent to the frequency block a resolution bandwidth of at least one percent of the emission bandwidth of the fundamental emission of the transmitter may be employed. The emission bandwidth is defined as the width of the signal between two points, one below the carrier center frequency and one above the carrier center frequency, outside of which all emissions are attenuated at least 26 dB below the transmitter power.

5.3. Test Results

Ambient temperature : (23 ± 1) °C
 Relative humidity : 47 % R.H.

- Test plots

LTE band 26 (1.4 MHz)

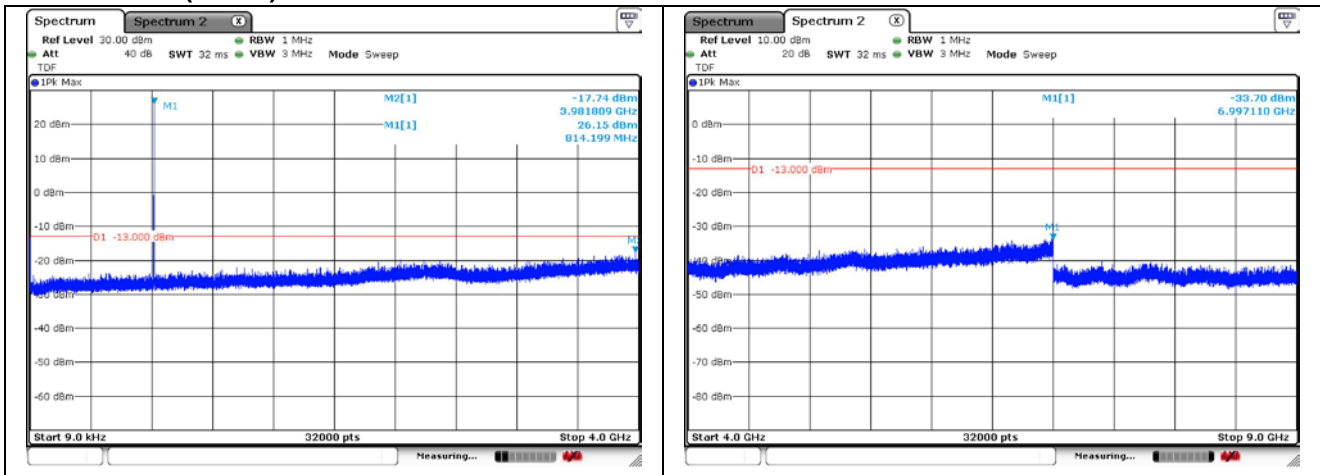

QPSK Low Channel - 1 RB

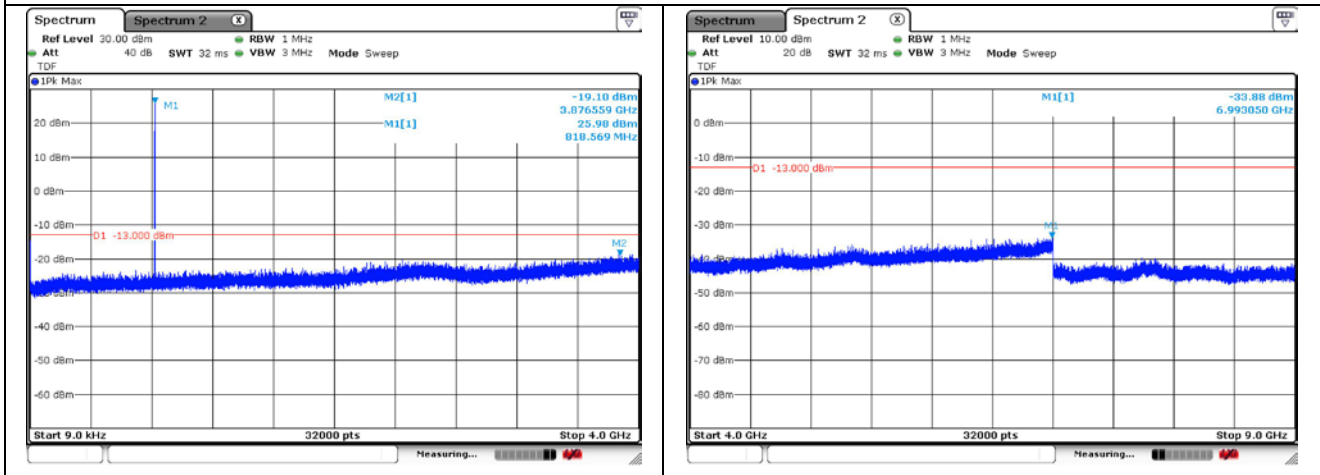

QPSK Middle Channel - 1 RB

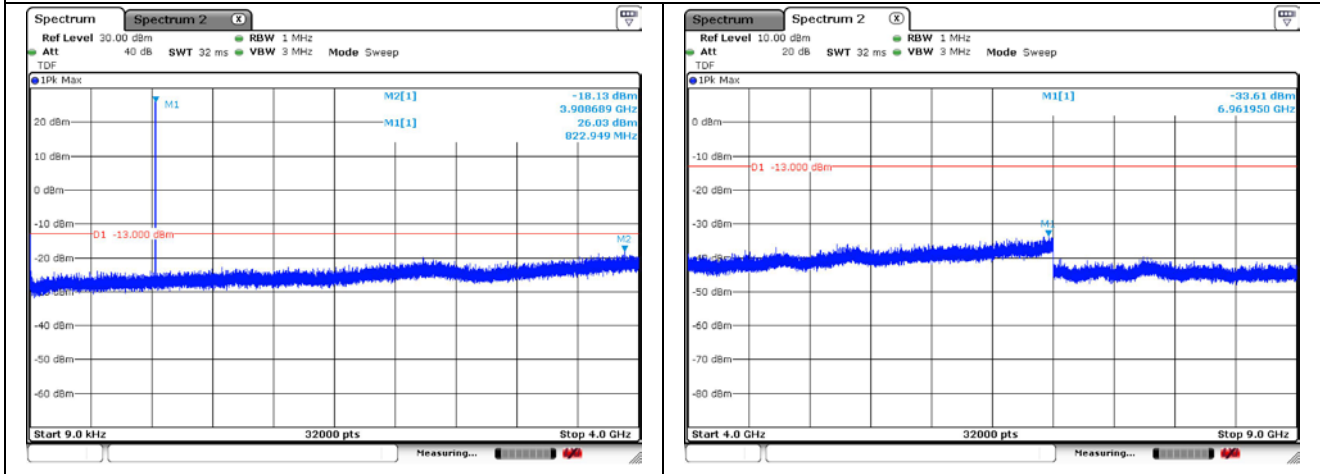

QPSK High Channel - 1 RB

LTE band 26 (3 MHz)

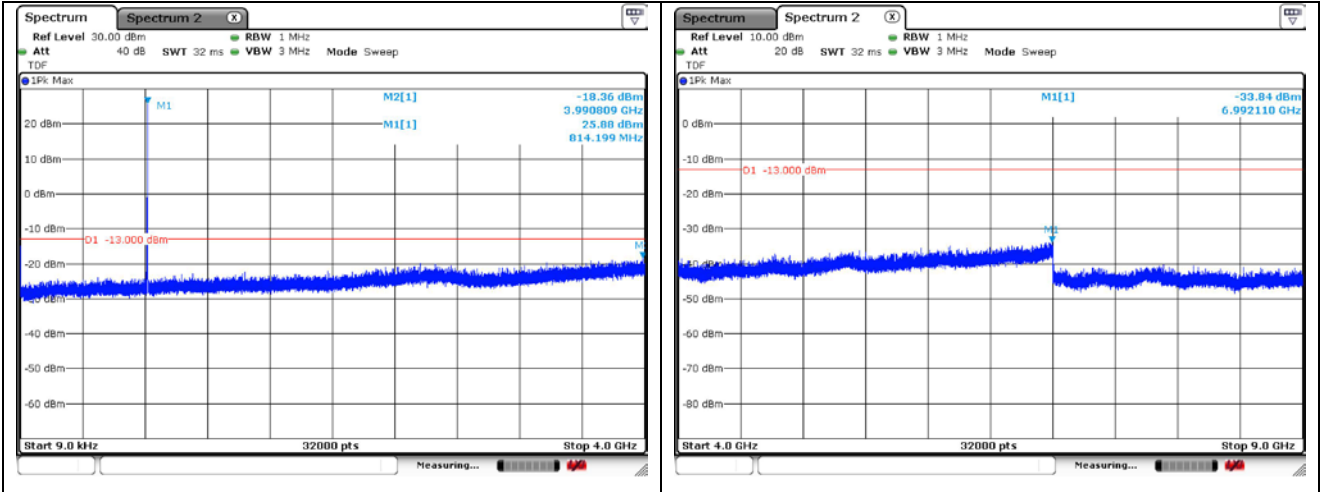

QPSK Low Channel - 1 RB

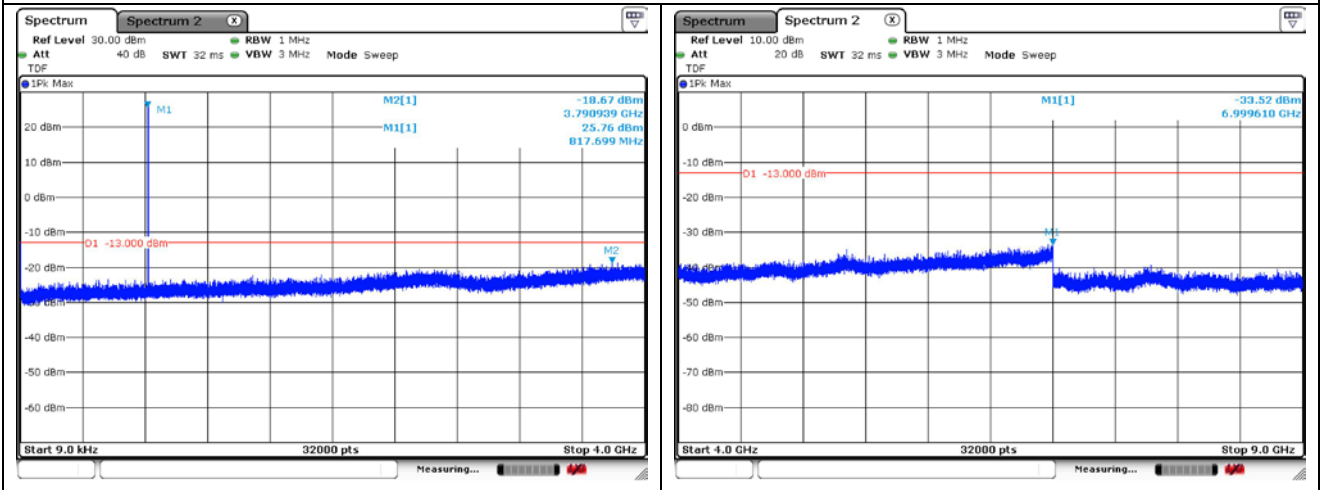

QPSK Middle Channel - 1 RB

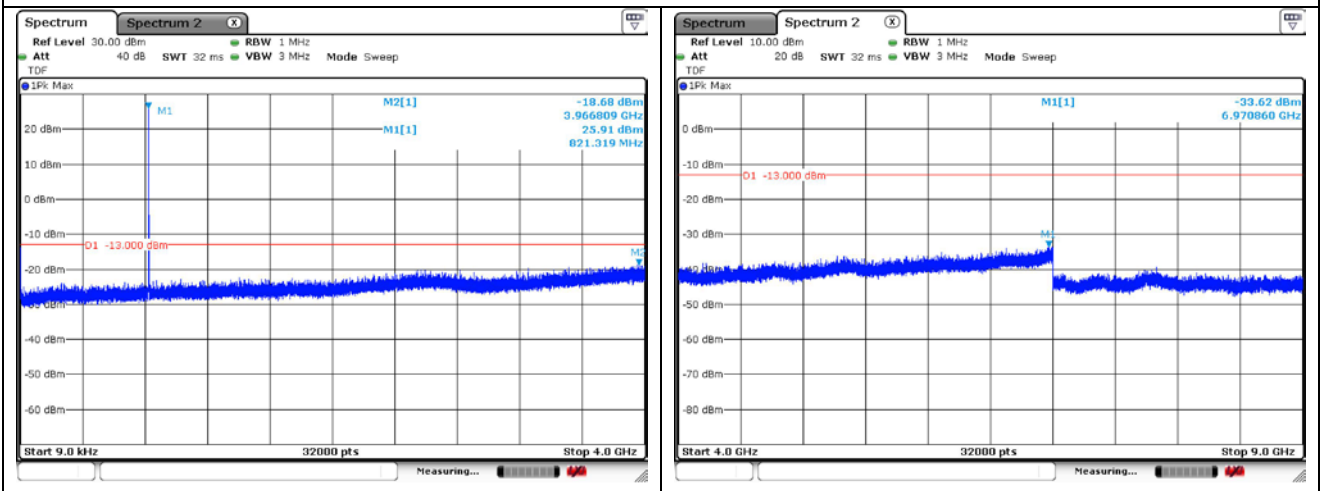

QPSK High Channel - 1 RB

LTE band 26 (5 MHz)

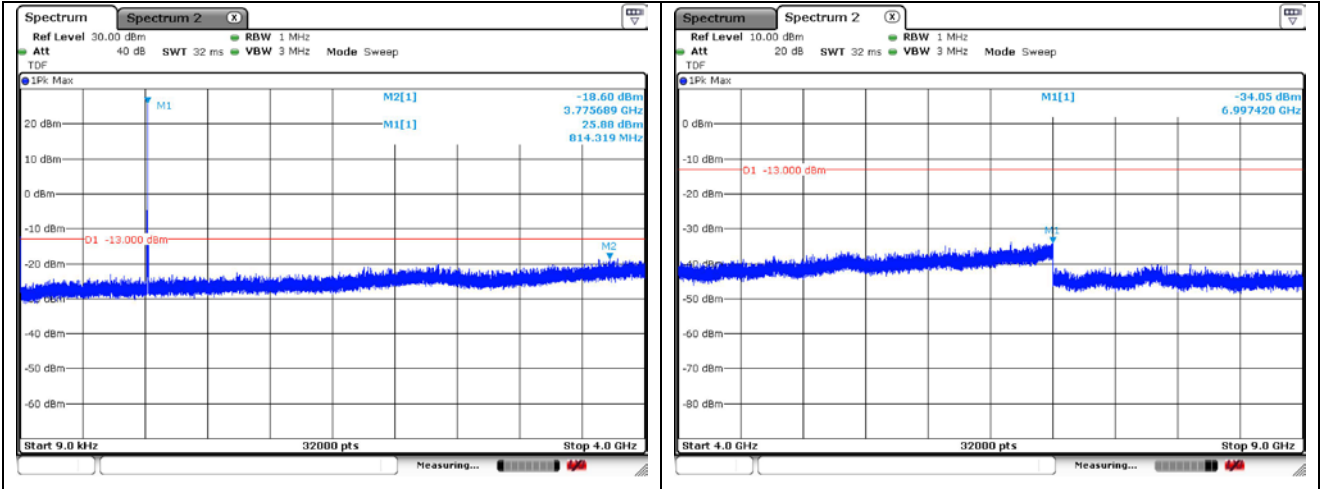

QPSK Low Channel - 1 RB

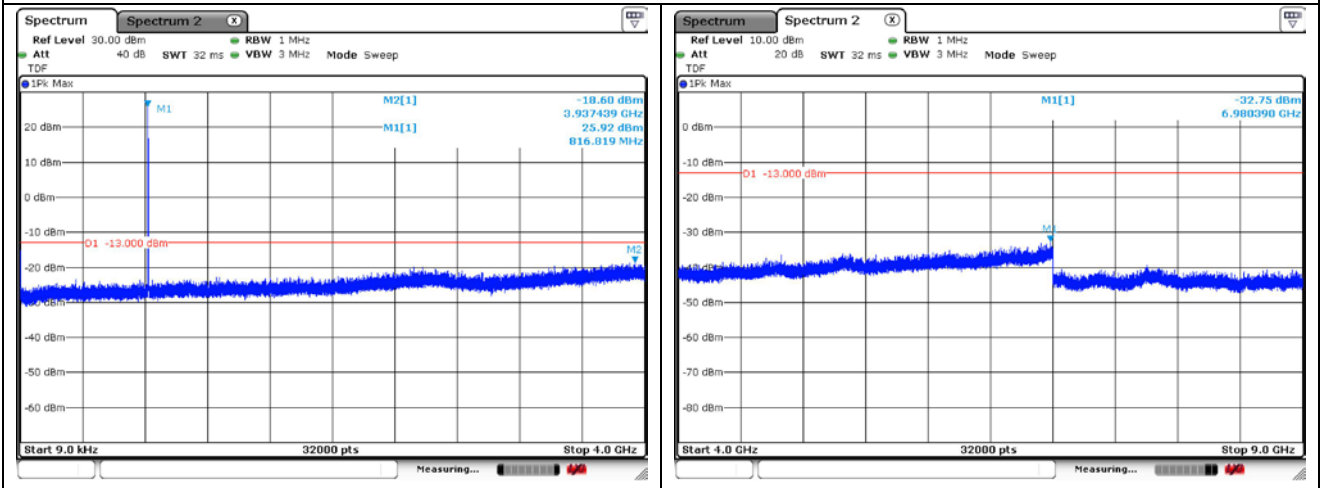

QPSK Middle Channel - 1 RB

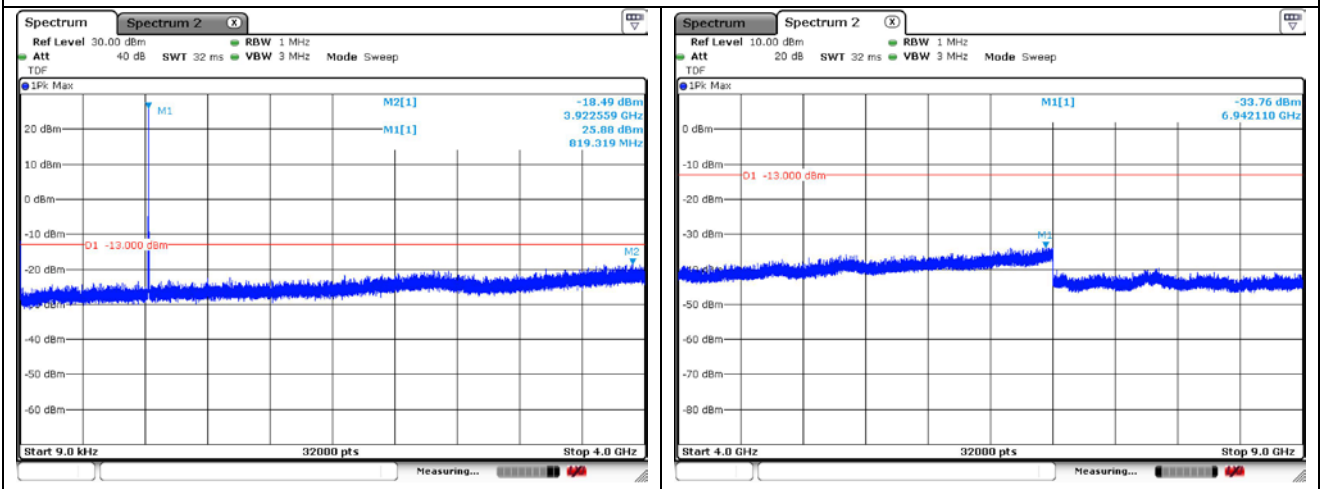

QPSK High Channel - 1 RB

LTE band 26 (10 MHz)

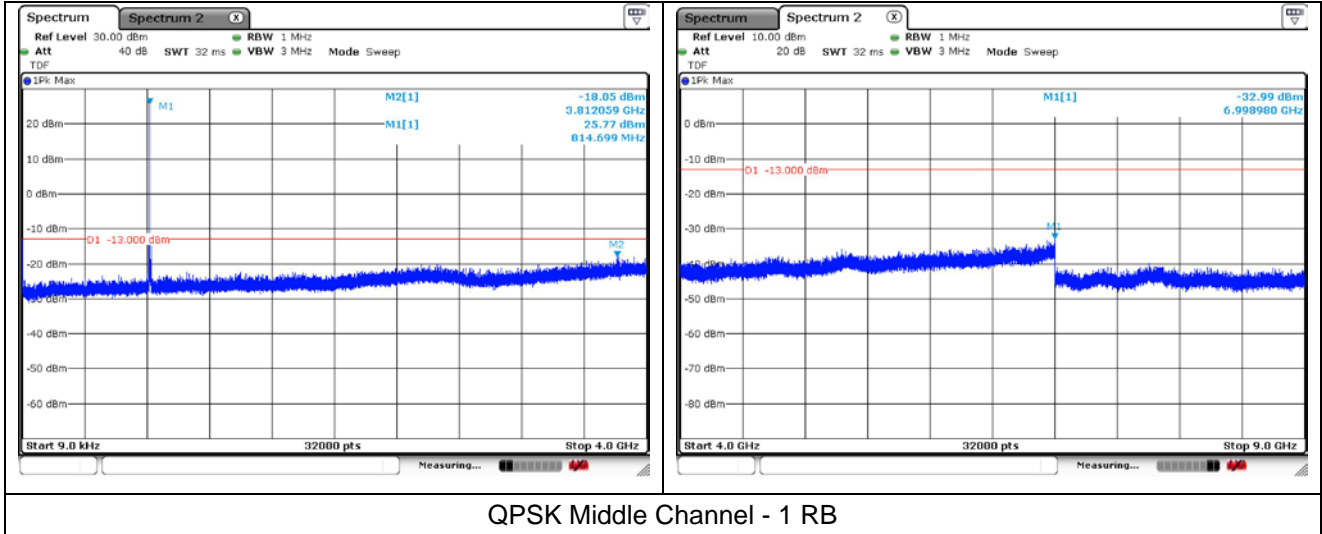

QPSK Middle Channel - 1 RB

LTE band 26/5 (15 MHz)

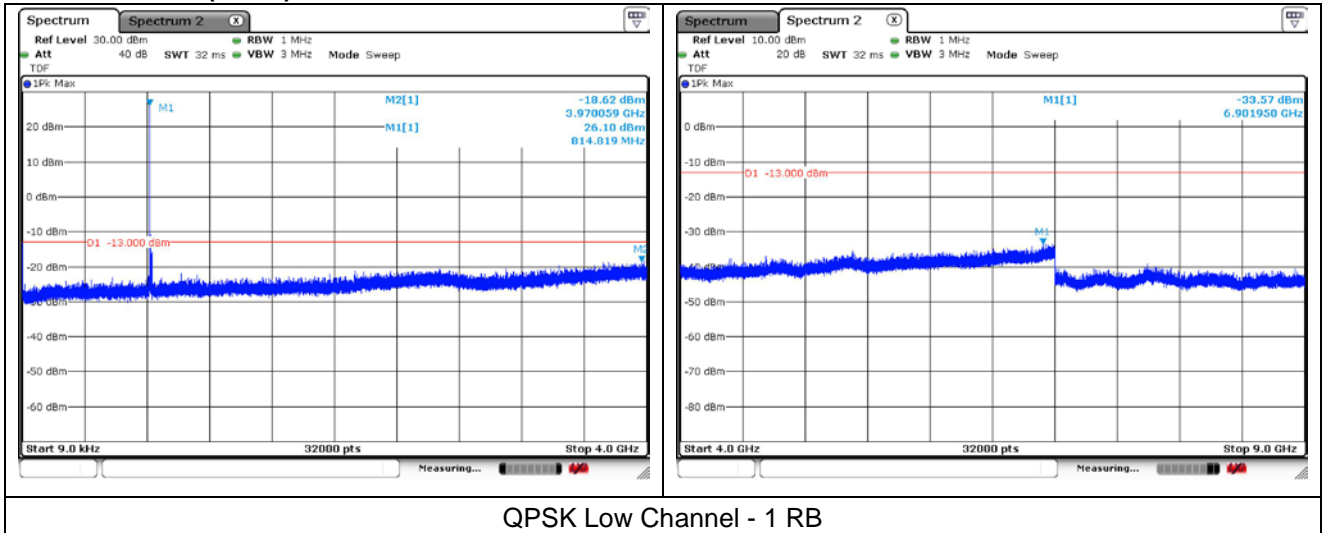

QPSK Low Channel - 1 RB

6. Band Edge

6.1. Limit

- §90.691(a), out-of-band emission requirement shall apply only to the “outer” channels included in an EA license and to spectrum adjacent to interior channels used by incumbent licensees. The emission limits are as follows:

(1) For any frequency removed from the EA licensee's frequency block by up to and including 37.5 kHz, the power of any emission shall be attenuated below the transmitter power (P) in watts by at least $116 \text{ Log}_{10} (f / 6.1)$ decibels or $50 + 10 \text{ Log}_{10} (P)$ decibels or 80 decibels, whichever is the lesser attenuation, where f is the frequency removed from the center of the outer channel in the block in kilohertz and where f is greater than 12.5 kHz.

(2) For any frequency removed from the EA licensee's frequency block greater than 37.5 kHz, the power of any emission shall be attenuated below the transmitter power (P) in watts by at least $43 + 10 \text{ Log}_{10} (P)$ decibels or 80 decibels, whichever is the lesser attenuation, where f is the frequency removed from the center of the outer channel in the block in kilohertz and where f is greater than 37.5 kHz.

6.2. Test Procedure

The test follows section 5.7 of ANSI C63.26-2015.

- a. Span was set large enough so as to capture all out of band emissions near the band edge.
- b. RBW $\geq 1\%$ of OBW
- c. VBW $\geq 3 \times$ RBW.
- d. Detector = RMS.
- e. Trace mode = Average.
- f. Sweep time = Auto.
- g. The trace was allowed to stabilize.
- h. All path loss of frequency range was investigated and compensated to spectrum analyzer as TDF function.

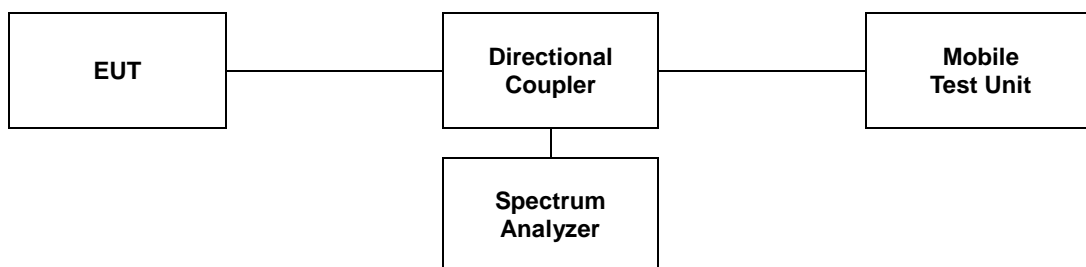

6.3. Test Results

Ambient temperature : (23 ± 1) °C
 Relative humidity : 47 % R.H.

- Test plots

LTE band 26 (1.4 MHz)

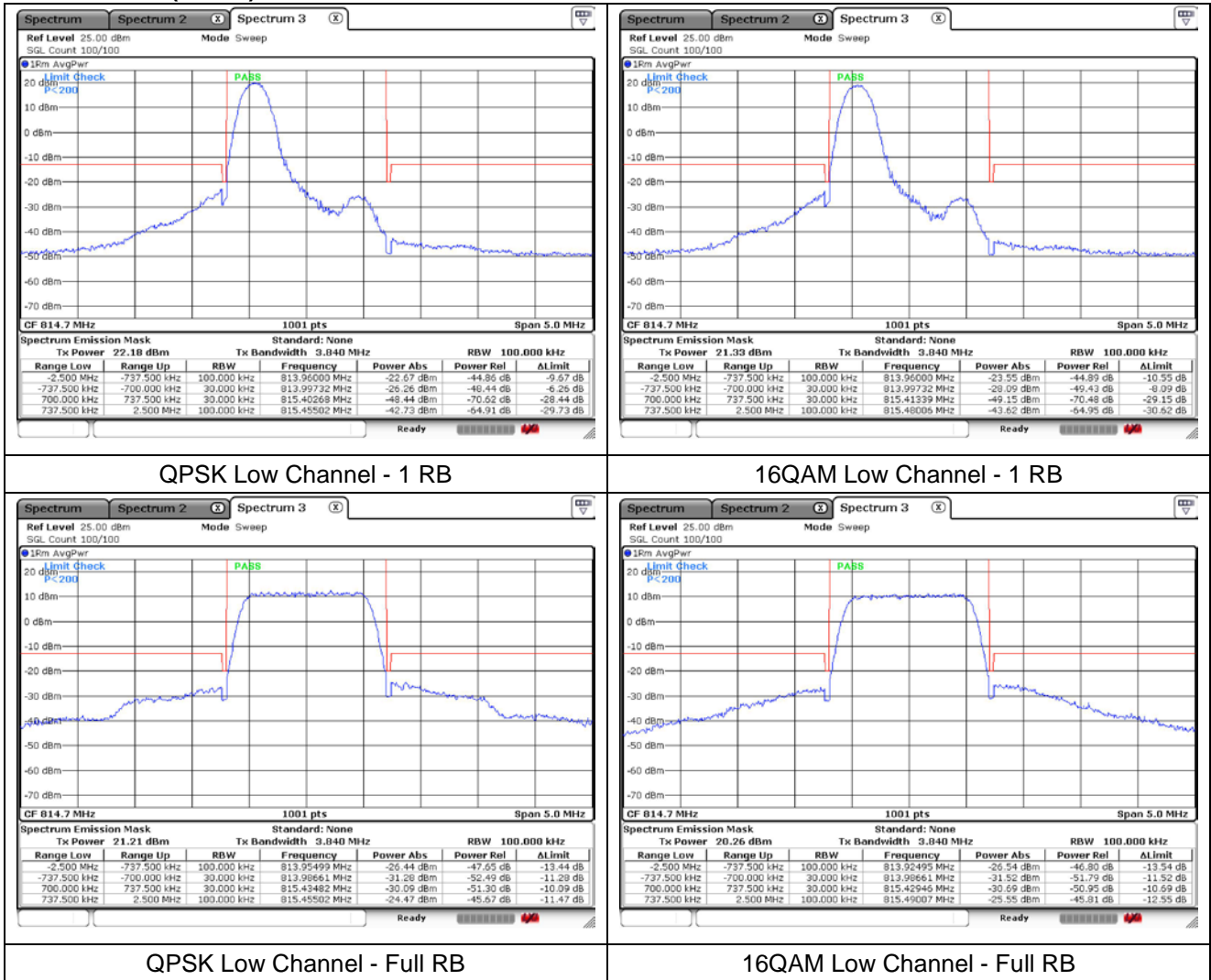

LTE band 26 (1.4 MHz)

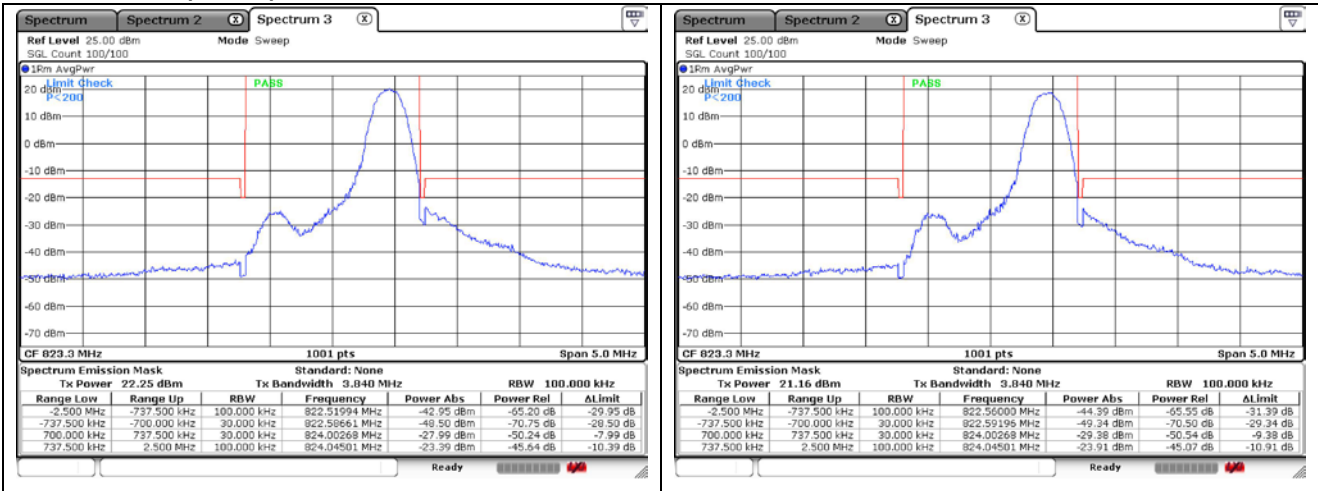

QPSK High Channel - 1 RB

16QAM High Channel - 1 RB

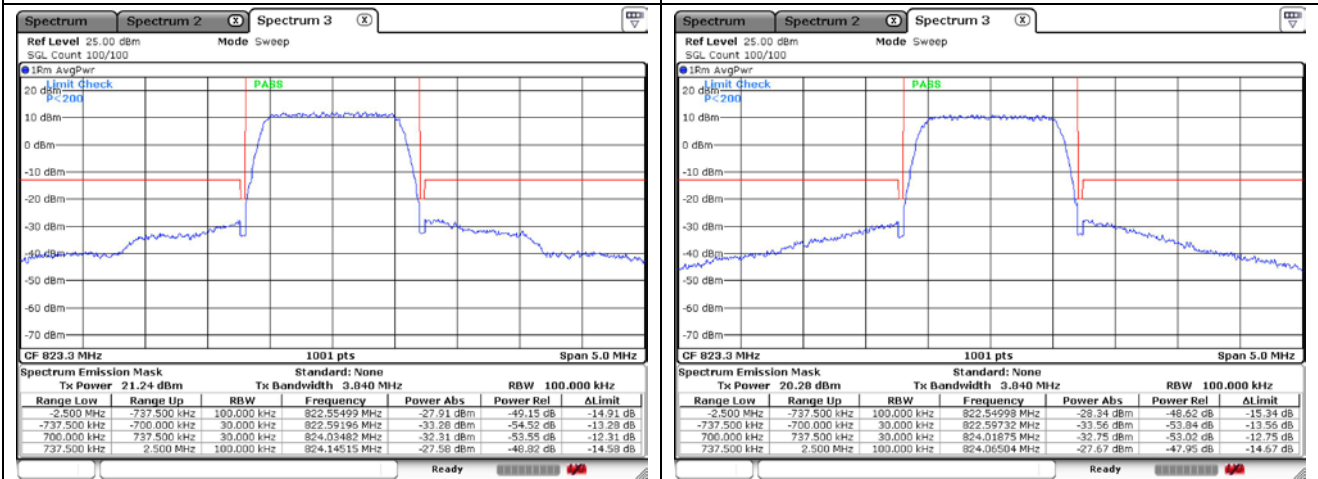

QPSK High Channel - Full RB

16QAM High Channel - Full RB

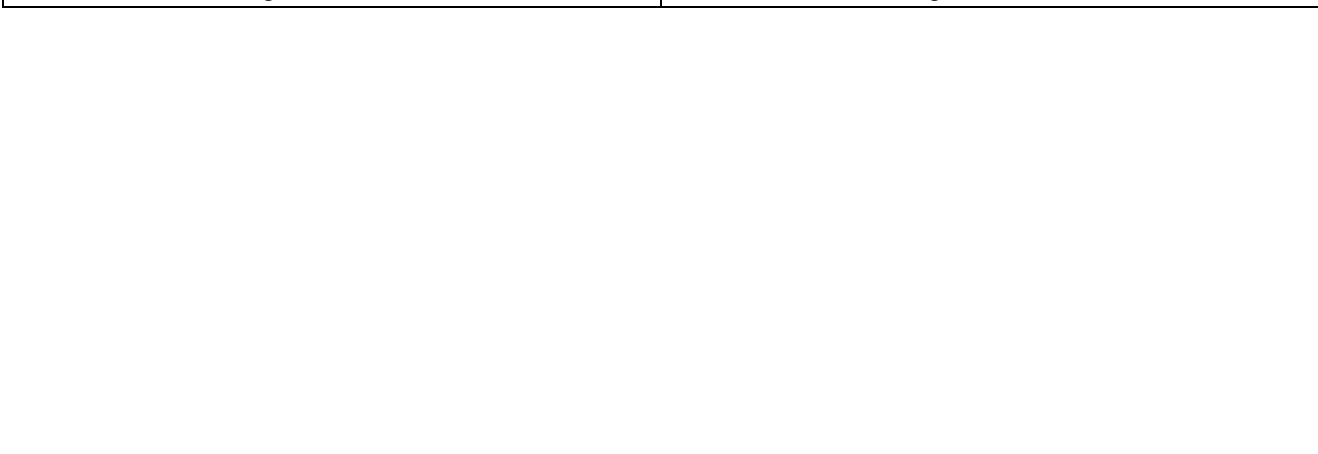

LTE band 26 (3 MHz)

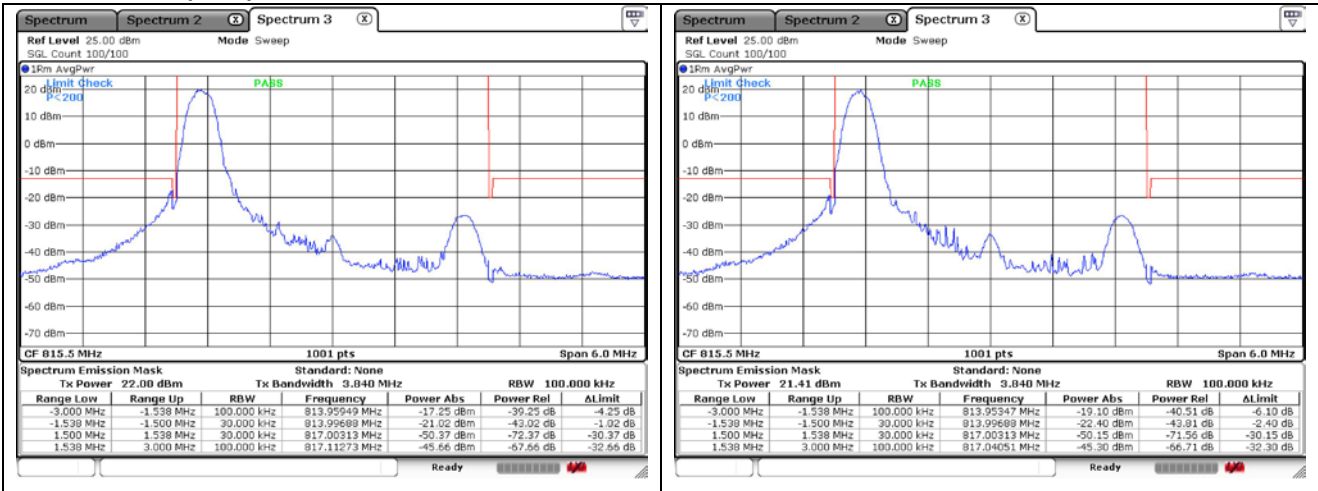

QPSK Low Channel - 1 RB

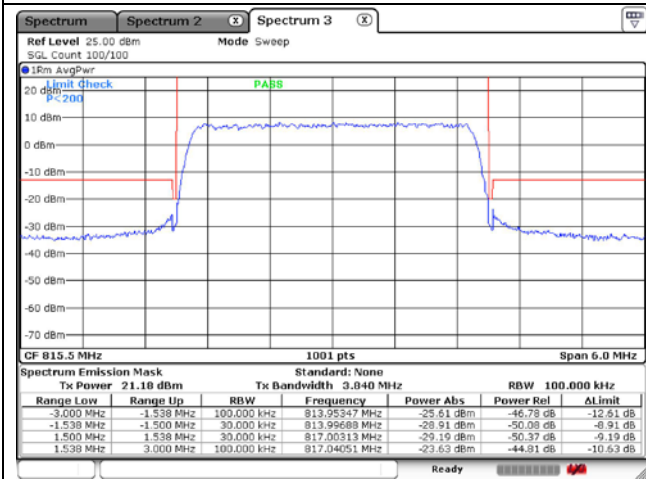

16QAM Low Channel - 1 RB

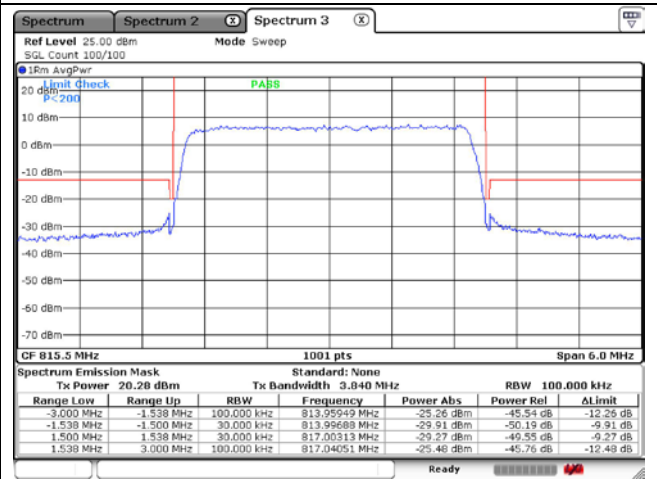

QPSK Low Channel - Full RB

16QAM Low Channel - Full RB

LTE band 26 (3 MHz)

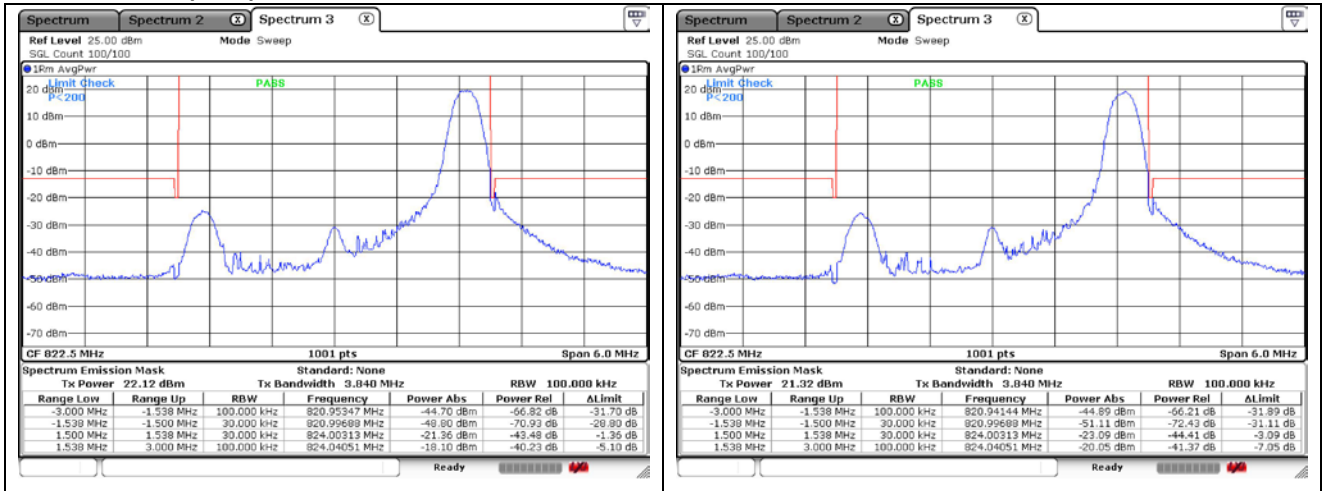

QPSK High Channel - 1 RB

16QAM High Channel - 1 RB

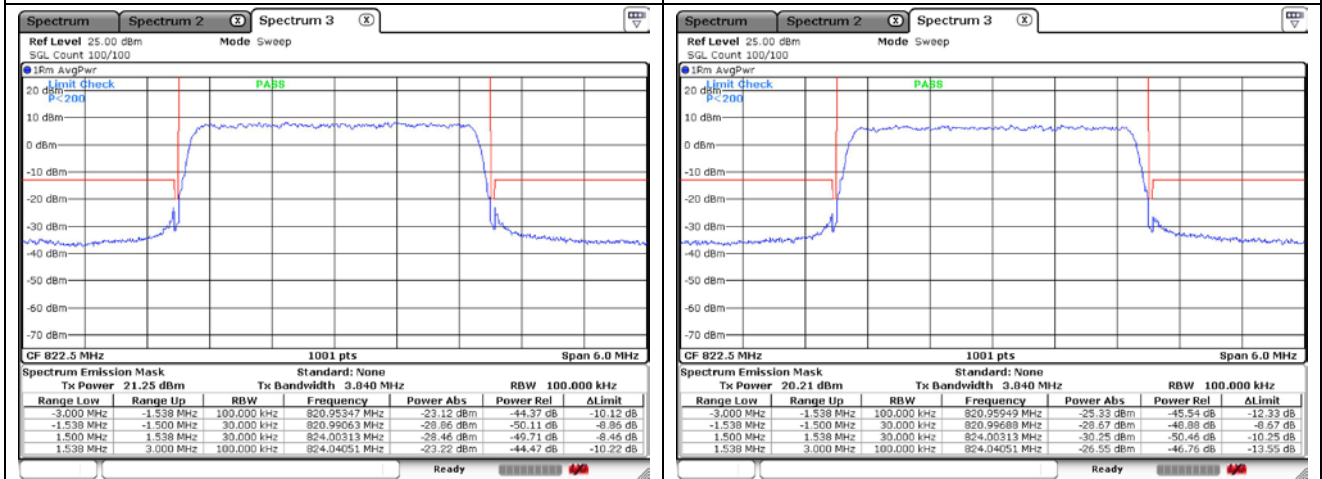

QPSK High Channel - Full RB

16QAM High Channel - Full RB

LTE band 26 (5 MHz)

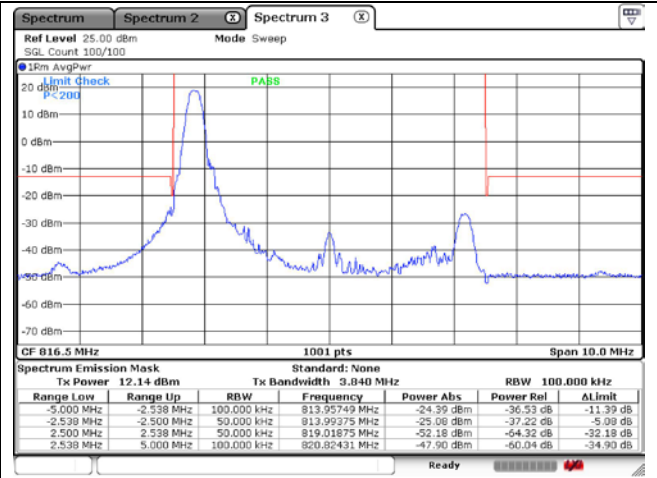
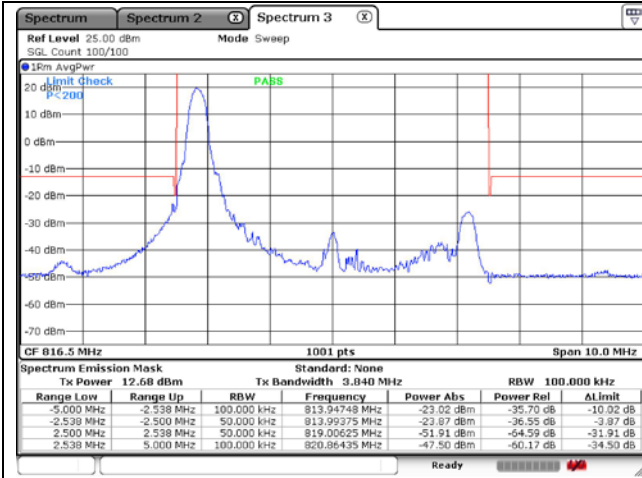

QPSK Low Channel - 1 RB

16QAM Low Channel - 1 RB

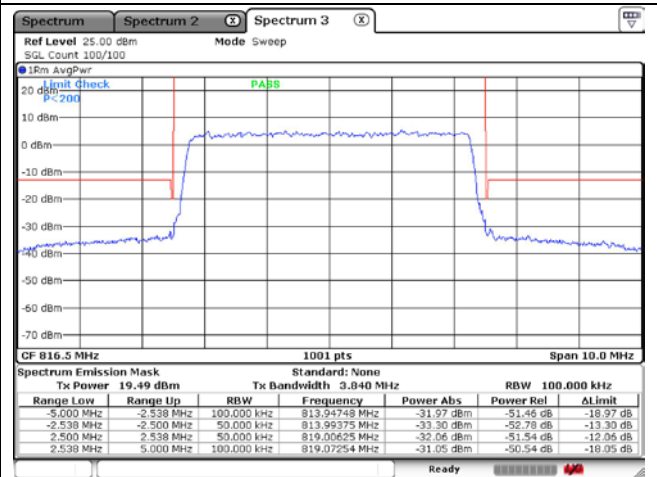
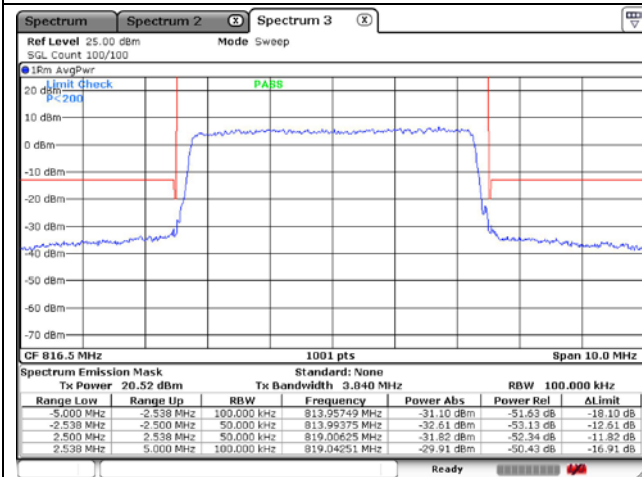

QPSK Low Channel - Full RB

16QAM Low Channel - Full RB

LTE band 26 (5 MHz)

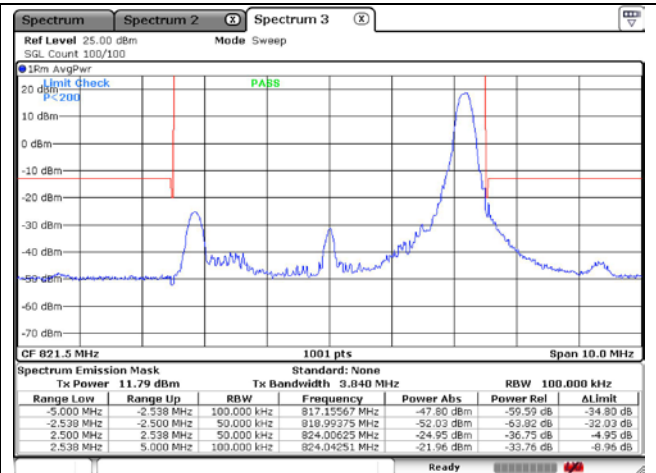
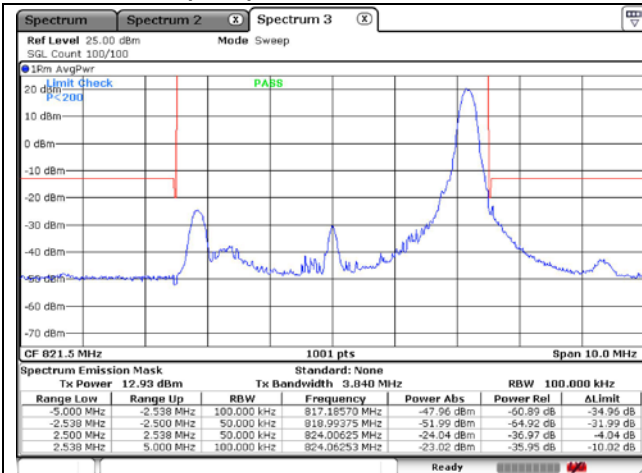

QPSK High Channel - 1 RB

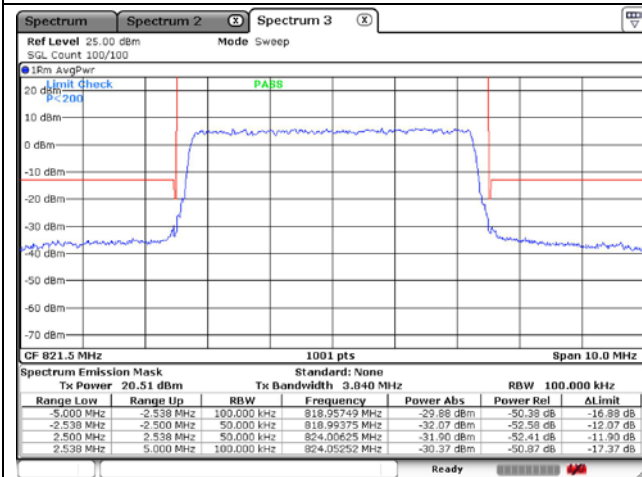

16QAM High Channel - 1 RB

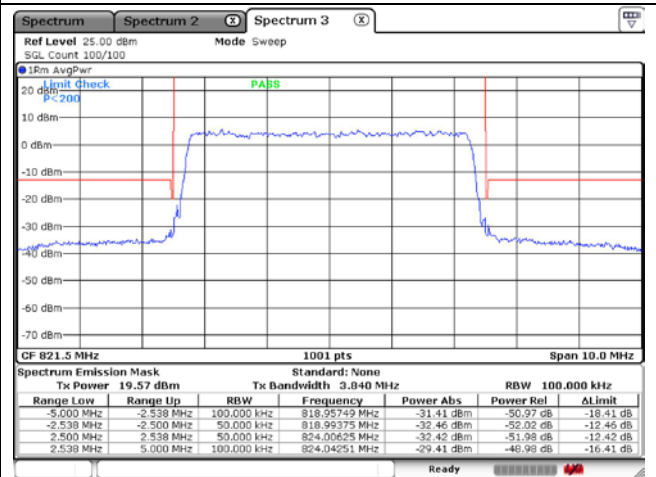

QPSK High Channel - Full RB

16QAM High Channel - Full RB

LTE band 26 (10 MHz)

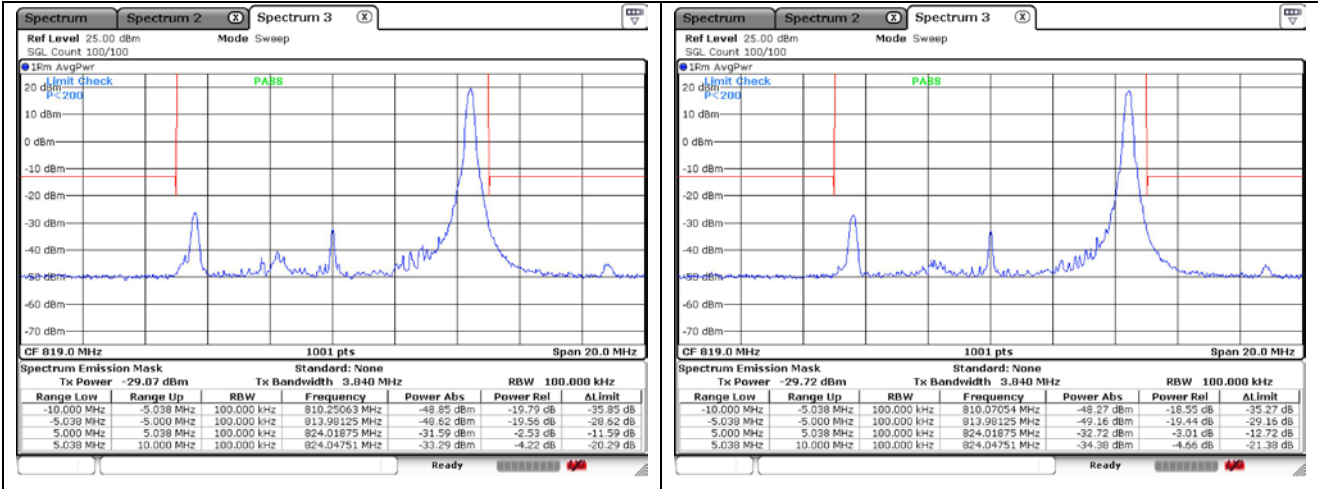

QPSK Middle Channel - 1 RB Low

16QAM Middle Channel - 1 RB Low

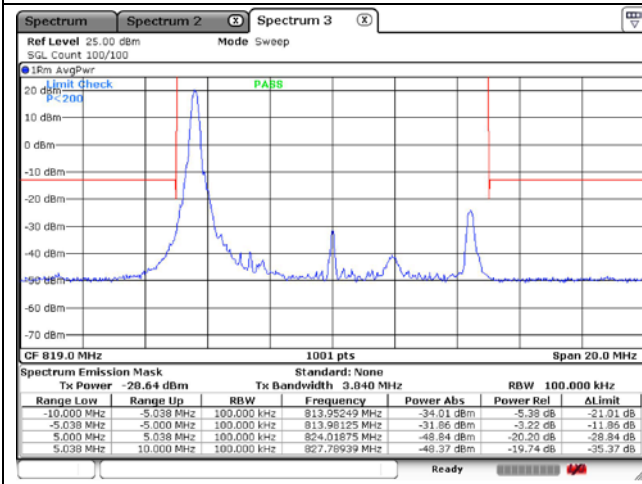

QPSK Middle Channel - 1 RB High

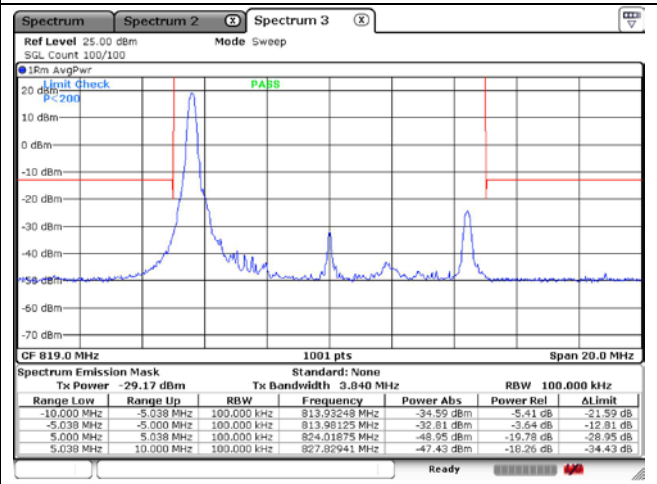

16QAM Middle Channel - 1 RB High

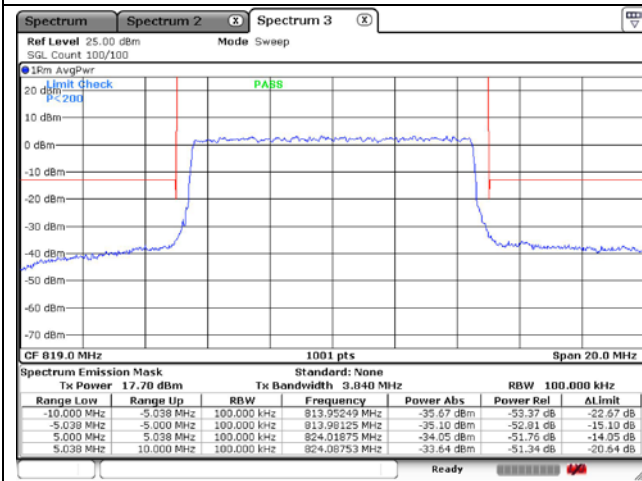

QPSK Middle Channel - Full RB

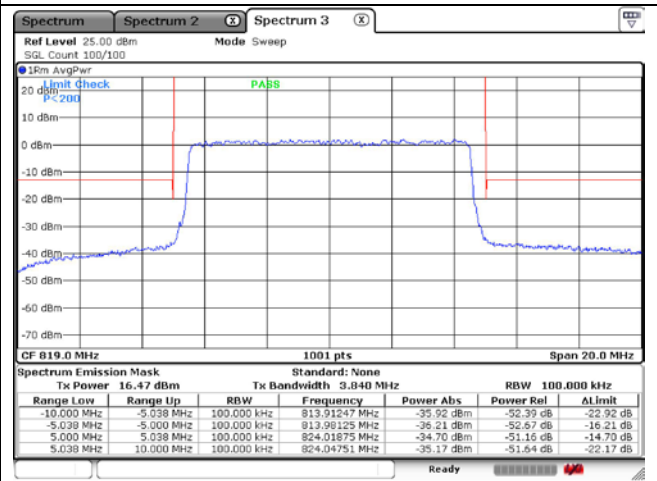

16QAM Middle Channel - Full RB

LTE band 26 (15 MHz)

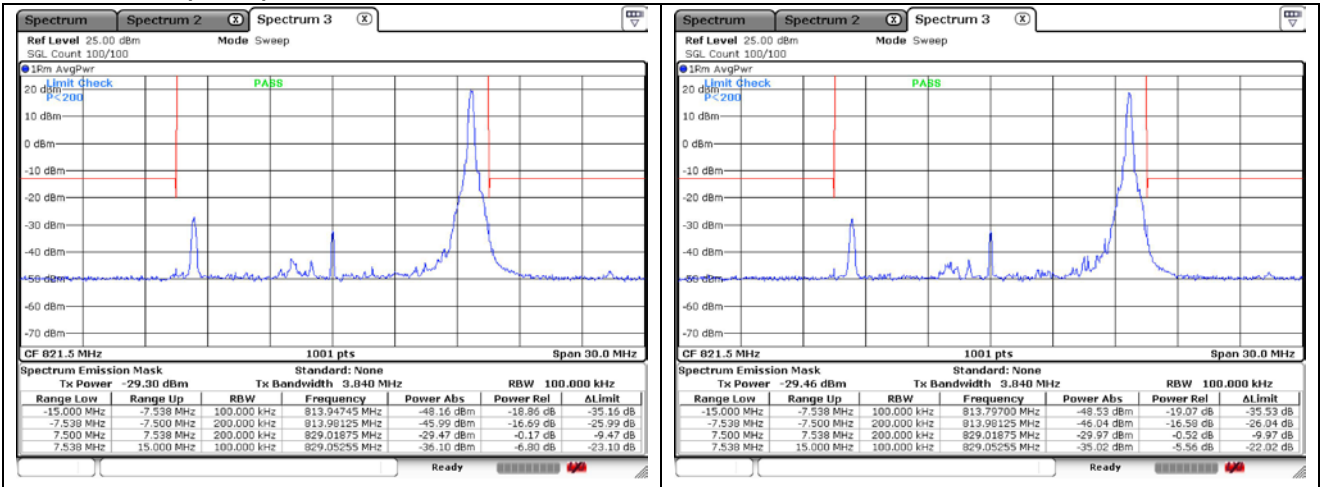

QPSK Low Channel - 1 RB Low

16QAM Low Channel - 1 RB Low

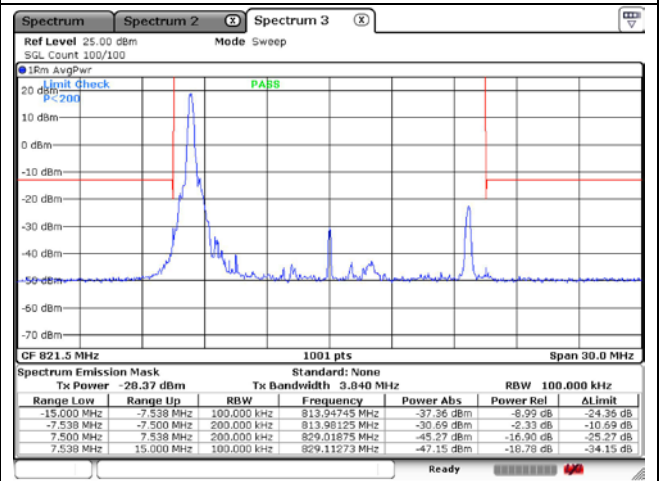
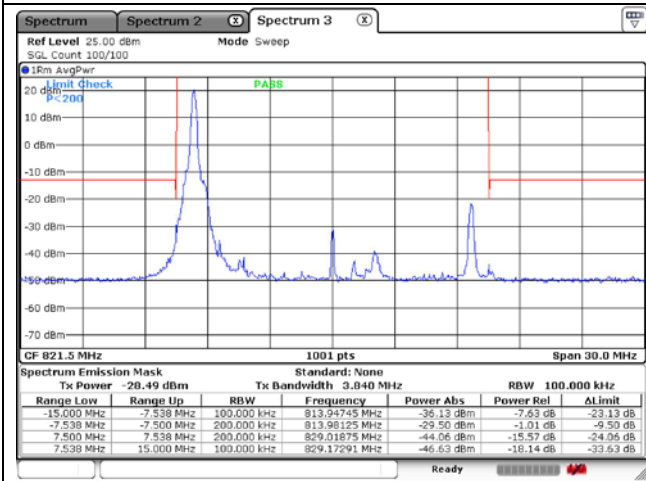

QPSK Low Channel - 1 RB High

16QAM Low Channel - 1 RB High

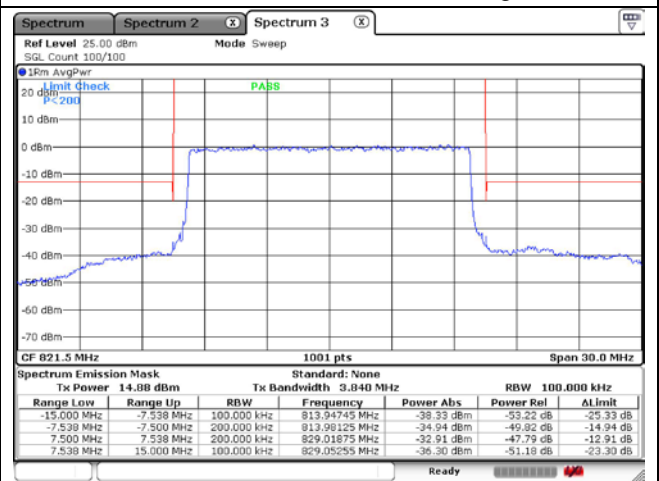
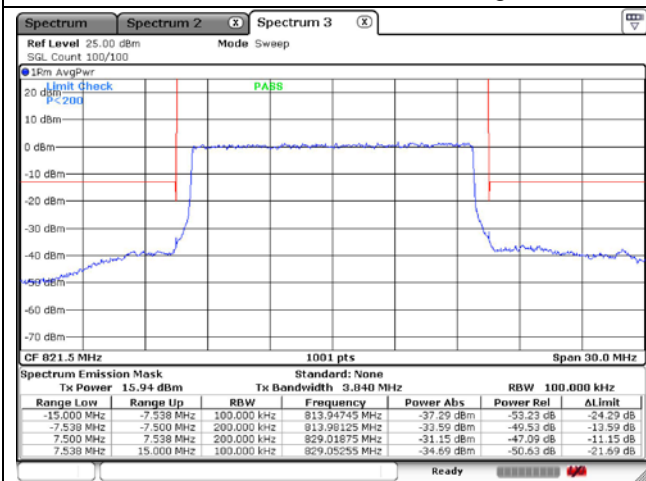

QPSK Low Channel - Full RB

16QAM Low Channel - Full RB

7. Frequency Stability

7.1. Limit

- § 2.1055(a), § 2.1055(d) & following:

- §90.213, transmitters used in the services governed by this part must have a minimum frequency stability as specified in the following table.

For Mobile devices operating in the 809 to 824 MHz band at a power level 2 Watts or less, the limit specified in Table is +/- 2.5 ppm.

7.2. Test Procedure

1. Frequency Stability vs. Temperature: The equipment under test was connected to an external DC power supply and the RF output was connected to a Mobile Test Unit via feed-through attenuators.
2. The EUT was placed inside the temperature chamber.
3. After the temperature stabilized for approximately 20 minutes, the frequency output was recorded from Mobile Test Unit.

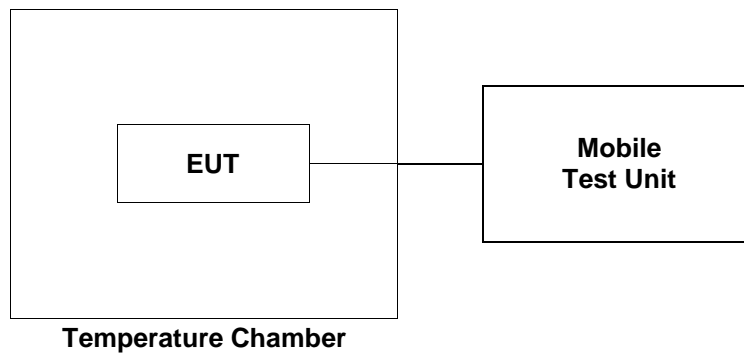

7.3. Test Results

Ambient temperature : (23 ± 1) °C
 Relative humidity : 47 % R.H.

Operating Frequency: 819.0 MHz			
Frequency Stability versus Temperature			
Environment Temperature (°C)	Power Supplied (V)	Frequency Measure with Time Elapse	
		Frequency Error (Hz)	ppm
50	12.0	-1.54	-0.001 04
40		-1.81	-0.001 37
30		-1.33	-0.000 78
20 (Ref.)		-0.69	-
10		1.42	0.002 58
0		1.54	0.002 72
-10		0.78	0.001 79
-20		1.65	0.002 86
-30		0.99	0.002 05
Frequency Stability versus Power Supply			
Environment Temperature (°C)	Power Supplied (V)	Frequency Measure with Time Elapse	
		Frequency Error (Hz)	ppm
20	13.8	-0.71	-0.000 02
	10.2	-1.24	-0.000 67

- End of the Test Report -