

TEST REPORT

of

FCC Part 2 Subpart J, Part 22 Subpart C/H and Part 24 Subpart E
IC RSS-Gen Issue 5, RSS-132 Issue 3 and RSS-133 Issue 6

FCC ID: BEJTM03LNNNAHD0
IC Certification: 2703H-TM03LNNNAHD0

Equipment Under Test : Telematics Module
Model Name : TM03LNNNAHD0
Variant Model Name(s) : -
Applicant : FCC: LG Electronics USA
: IC: LG ELECTRONICS INC.
Manufacturer : LG Electronics Inc.
Date of Receipt : 2021.06.03
Date of Test(s) : 2020.06.03 ~ 2021.06.29
Date of Issue : 2021.06.29

In the configuration tested, the EUT complied with the standards specified above. This test report does not assure KOLAS accreditation.

- 1) The results of this test report are effective only to the items tested.
- 2) The SGS Korea is not responsible for the sampling, the results of this test report apply to the sample as received.
- 3) This test report cannot be reproduced, except in full, without prior written permission of the Company.
- 4) The data marked ※ in this report was provided by the customer and may affect the validity of the test results.

We are responsible for all the information of this test report except for the data(※) provided by the customer.

Tested by:



Nancy Park

Technical
Manager:

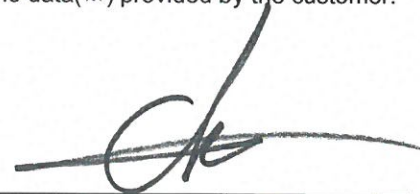

Jinhyoung Cho

SGS Korea Co., Ltd. Gunpo Laboratory



INDEX

<u>Table of Contents</u>	Page
1. General Information -----	3
2. RF Radiated Output Power & Spurious Radiated Emission -----	8
3. Conducted Output Power -----	15
4. Occupied Bandwidth -----	17
5. Peak-Average Ratio -----	22
6. Spurious Emissions at Antenna Terminal -----	27
7. Band Edge -----	31
8. Frequency Stability -----	35

1. General Information

1.1. Testing Laboratory

SGS Korea Co., Ltd. (Gunpo Laboratory)

- 10-2, LS-ro 182beon-gil, Gunpo-si, Gyeonggi-do, Korea, 15807
- 4, LS-ro 182beon-gil, Gunpo-si, Gyeonggi-do, Korea, 15807
- Designation number: KR0150

All SGS services are rendered in accordance with the applicable SGS conditions of service available on request and accessible at <http://www.sgs.com/en/Terms-and-Conditions.aspx>.

Phone No. : +82 31 688 0901

Fax No. : +82 31 688 0921

1.2. Details of Applicant

FCC Applicant : LG Electronics USA

FCC Address : 111 Sylvan Avenue, North Building, Englewood Cliffs, New Jersey, United States, 07632

IC Applicant : LG ELECTRONICS INC.

IC Address : 222, LG-ro, Jinwi-myeon, Pyeongtaek-si, Gyeonggi-do, Korea (Republic of), 451-713

Contact Person : Kim, Dae-woong

Phone No. : +1 201 266 2215

1.3. Details of Manufacturer

Company : LG Electronics Inc.

Address : 10, Magokjungang 10-ro, Gangseo-gu, Seoul, Korea, 07796

1.4. Description of EUT

Kind of Product	Telematics Module
Model Name	TM03LNNABD0
Serial Number	353342700000291, 353342700000309
Power Supply	DC 3.90 V
Rated Power	WCDMA II, V: 23 dB m
Frequency Range	WCDMA II: 1 850 MHz ~ 1 910 MHz WCDMA V: 824 MHz ~ 849 MHz
Modulation Technique	QPSK, 16QAM
Antenna Type	Planar Inverted F Antenna
Antenna Gain*	824 MHz ~ 849 MHz: 0.32 dB i 1 850 MHz ~ 1 910 MHz: 2.83 dB i
H/W Version	Rev.C1
S/W Version	TN23XA01

1.5. Test Equipment List

Equipment	Manufacturer	Model	S/N	Cal. Date	Cal. Interval	Cal. Due
Signal Generator	R&S	SMR40	100272	Jun. 16, 2021	Annual	Jun. 16, 2022
Signal Generator	R&S	SMVB100A	255834	May 31, 2021	Annual	May 31, 2022
Spectrum Analyzer	R&S	FSV30	103453	Nov. 04, 2020	Annual	Nov. 04, 2021
Spectrum Analyzer	Agilent	N9020A	MY53421758	Sep. 04, 2020	Annual	Sep. 04, 2021
Mobile Test Unit	R&S	CMW500	144034	Feb. 22, 2021	Annual	Feb. 22, 2022
Power Meter	Anritsu	ML2495A	1223004	Jun. 01, 2021	Annual	Jun. 01, 2022
Power Sensor	Anritsu	MA2411B	1207272	Jun. 01, 2021	Annual	Jun. 01, 2022
Temperature Chamber	ESPEC CORP.	PL-2J	15004184	Jun. 02, 2021	Annual	Jun. 02, 2022
Low Pass Filter	Mini-Circuits	NLP-1200+	V 8979400903-2	Feb. 08, 2021	Annual	Feb. 08, 2022
High Pass Filter	Wainwright Instrument GmbH	WHKX10-900-1000-18000-40SS	7	Mar. 08, 2021	Annual	Mar. 08, 2022
High Pass Filter	Wainwright Instrument GmbH	WHKX2.2/12.75G-10SS	8	Mar. 04, 2021	Annual	Mar. 04, 2022
High Pass Filter	Wainwright Instrument GmbH	WHK3.0/18G-10SS	21	Jun. 04, 2021	Annual	Jun. 04, 2022
High Pass Filter	Wainwright Instrument GmbH	WHK7.5/26.5G-6SS	11	May 17, 2021	Annual	May 17, 2022
Directional Coupler	KRYTAR	152613	122660	Jun. 15, 2021	Annual	Jun. 15, 2022
DC Power Supply	Agilent	U8002A	MY49030063	Feb. 02, 2021	Annual	Feb. 02, 2022
Preamplifier	H.P.	8447F	2944A03909	Aug. 06, 2020	Annual	Aug. 06, 2021
Preamplifier	R&S	SCU-18	10117	Jun. 09, 2021	Annual	Jun. 09, 2022
Preamplifier	TESTEK	TK-PA1840H	130016	Jan. 07, 2021	Annual	Jan. 07, 2022
Test Receiver	R&S	ESU26	100109	Feb. 19, 2021	Annual	Feb. 19, 2022
Loop Antenna	Schwarzbeck Mess-Elektronik	FMZB 1519	1519-039	Aug. 22, 2019	Biennial	Aug. 22, 2021
Bilog Antenna	Schwarzbeck Mess-Elektronik	VULB9163	01126	Dec. 12, 2020	Biennial	Dec. 12, 2022
Horn Antenna	R&S	HF906	100326	Feb. 04, 2021	Annual	Feb. 04, 2022
Horn Antenna	Schwarzbeck Mess-Elektronik	BBHA9170	9170-540	Nov. 26, 2020	Annual	Nov. 26, 2021
Antenna Master	Innco systems GmbH	MA4640-XP-ET	MA4640/536/383 30516/L	N.C.R.	N/A	N.C.R.
Turn Table	Innco systems GmbH	DS 1200S	N/A	N.C.R.	N/A	N.C.R.
Controller	Innco systems GmbH	CONTROLLER CO3000-4P	CO3000/963/383 30516/L	N.C.R.	N/A	N.C.R.
Anechoic Chamber	SY Corporation	L x W x H (9.6 m x 6.4 m x 6.6 m)	N/A	N.C.R.	N/A	N.C.R.
Coaxial Cable	RFONE	MWX221-NMSNMS (4 m)	J1023142	May 27, 2021	Semi-annual	Nov. 27, 2021
Coaxial Cable	RFONE	PL520-NMNM-10M (10 m)	20200324001	May 27, 2021	Semi-annual	Nov. 27, 2021
Coaxial Cable	RADIALL	TESTPRO 3	182287	Feb. 19, 2021	Semi-annual	Aug. 19, 2021
Coaxial Cable	RADIALL	TESTPRO 3	182288	Feb. 19, 2021	Semi-annual	Aug. 19, 2021
Coaxial Cable	RADIALL	TESTPRO 3	182291	Feb. 19, 2021	Semi-annual	Aug. 19, 2021

► Support Equipment

Description	Manufacturer	Model	Serial Number
N/A	-	-	-

1.6. Summary of Test Results

The EUT has been tested according to the following specifications:

APPLIED STANDARD: FCC Part 2, 22 and 24 / IC RSS-Gen Issue 5, RSS-132 Issue 3 and RSS-133 Issue 6			
Section(s) in FCC	Section(s) in IC	Test Item	Result
§2.1046 §22.913(a)(5) §24.232(c)	RSS-132 Issue 3 5.4 RSS-133 Issue 6 6.4	RF Radiated Output Power	Complied
§2.1053 §22.917(a) §24.238(a)	RSS-132 Issue 3 5.5 RSS-133 Issue 6 6.5	Spurious Radiated Emission	Complied
§2.1046	RSS-Gen Issue 5 6.12	Conducted Output Power	Complied
§2.1049	RSS-Gen Issue 5 6.7	Occupied Bandwidth	Complied
§22.913(d) §24.232(d)	RSS-132 Issue 3 5.4 RSS-133 Issue 6 6.4	Peak-Average Ratio	Complied
§2.1051 §22.917(a) §24.238(a)	RSS-132 Issue 3 5.5 RSS-133 Issue 6 6.5	Spurious Emission at Antenna Terminal	Complied
§22.917(a) §24.238(a)	RSS-132 Issue 3 5.5 RSS-133 Issue 6 6.5	Band Edge	Complied
§2.1055 §22.355 §24.235	RSS-Gen Issue 5 6.11 RSS-132 Issue 3 5.3 RSS-133 Issue 6 6.3	Frequency Stability	Complied

1.7. Sample Calculation for Offset

Where relevant, the following sample calculation is provided:

1.7.1. Conducted Test

Offset value (dB) = Directional Coupler (dB) + Cable loss (dB)

1.7.2. Radiation test

- E.I.R.P. (dB m) = Measured level (dB μ V) + Antenna factor (dB/m) + Cable loss (dB) + 20 Log D - 104.5;
 where D is the measurement distance in meters.
- E.R.P (dB m) = E.I.R.P. (dB m) - 2.15 (dB)

1.8. Test Report Revision

Revision	Report Number	Date of Issue	Description
0	F690501-RF-RTL002350	2021.06.29	Initial

1.9. Worst Case Configuration and Mode

Output power measurements were measured on RMC, HSDPA and HSUPA Modulation. All testing was performed using RMC, HSDPA modulations, except spurious radiated emission spurious and emission at antenna terminal were tested only RMC modulation as worst case. The worst-case is based on the average conducted output power measurement investigation results.

The radiation test of the EUT was investigated in three orthogonal orientations X, Y, and Z, and the worst case data is reported.

1.10. Emission Designator and Max Power

Band	Modulation	Low Freq. (MHz)	Upper Freq. (MHz)	Conducted Average (dB m)	Ant. Gain (dB i)	E.R.P. / E.I.R.P. Average (dB m)	E.R.P. / E.I.R.P. Average (W)	Emission Designator
WCDMA II	RMC	1 852.4	1 907.6	23.29	2.83	26.12	0.409	4M15F9W
	HSDPA			22.58		25.41	0.348	4M13F9W
WCDMA V	RMC	826.4	846.6	23.03	0.32	21.20	0.132	4M13F9W
	HSDPA			22.69		20.86	0.122	4M14F9W

1.11. Measurement Uncertainty

Where relevant, the following measurement uncertainty levels have been estimated for tests performed on the apparatus:

Parameter	Uncertainty	
RF Output Power	± 0.36 dB	
Occupied Bandwidth	± 13.12 kHz	
Conducted Spurious Emissions	± 0.63 dB	
Peak to Average Ratio	± 0.60 dB	
Frequency Stability	± 4.92 kHz	
Radiated Emission, 9 kHz to 30 MHz	H	± 3.66 dB
	V	± 3.66 dB
Radiated Emission, below 1 GHz	H	± 4.90 dB
	V	± 4.82 dB
Radiated Emission, above 1 GHz	H	± 3.62 dB
	V	± 3.64 dB

All measurement uncertainty values are shown with a coverage factor of $k=2$ to indicate a 95 % level of confidence.

1.12. Measurement Configuration

Test Items	Band	Test Channel			Modulation		
		L	M	H	RMC	HSUPA	HSDPA
RF Radiated Output Power	Band V	V	V	V	V	-	-
	Band II	V	V	V	V	-	-
Conducted Output Power	Band V	V	V	V	V	V	V
	Band II	V	V	V	V	V	V
Frequency Stability	Band V	-	V	-	V	-	-
	Band II	-	V	-	V	-	-
Occupied Bandwidth	Band V	V	V	V	V	-	V
	Band II	V	V	V	V	-	V
Peak to Average Ratio	Band V	V	V	V	V	-	V
	Band II	V	V	V	V	-	V
Band Edge	Band V	V	-	V	V	-	V
	Band II	V	-	V	V	-	V
Spurious Emission at Antenna Terminal	Band V	V	V	V	V	-	-
	Band II	V	V	V	V	-	-
Spurious Radiated Emission	Band V	V	V	V	V	-	-
	Band II	V	V	V	V	-	-

2. RF Radiated Output Power & Spurious Radiated Emission

2.1. Test setup

The diagram below shows the test setup that is utilized to make the measurements for emission from 9 kHz to 30 MHz.

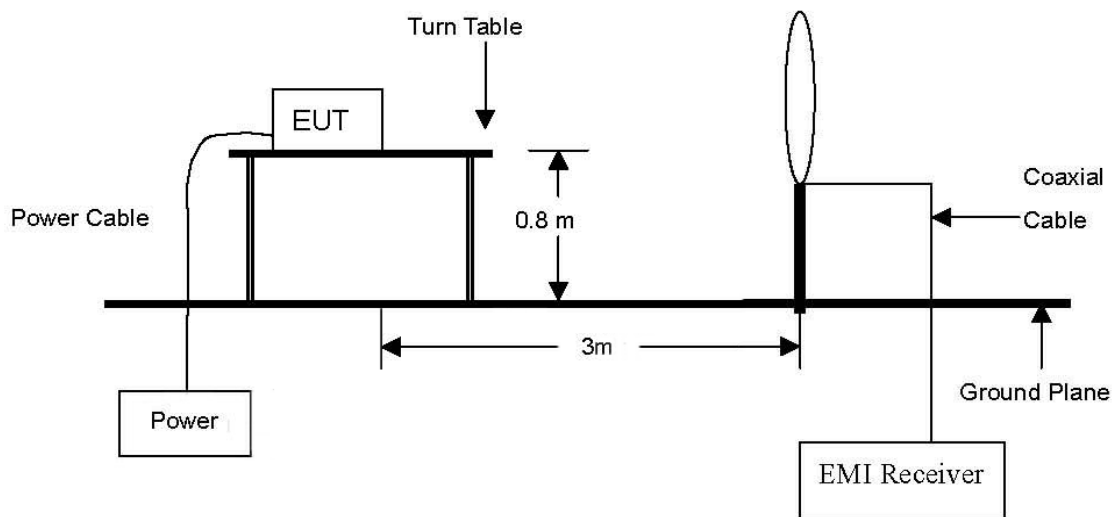

The diagram below shows the test setup that is utilized to make the measurements for emission from 30 MHz to 1 GHz Emissions.

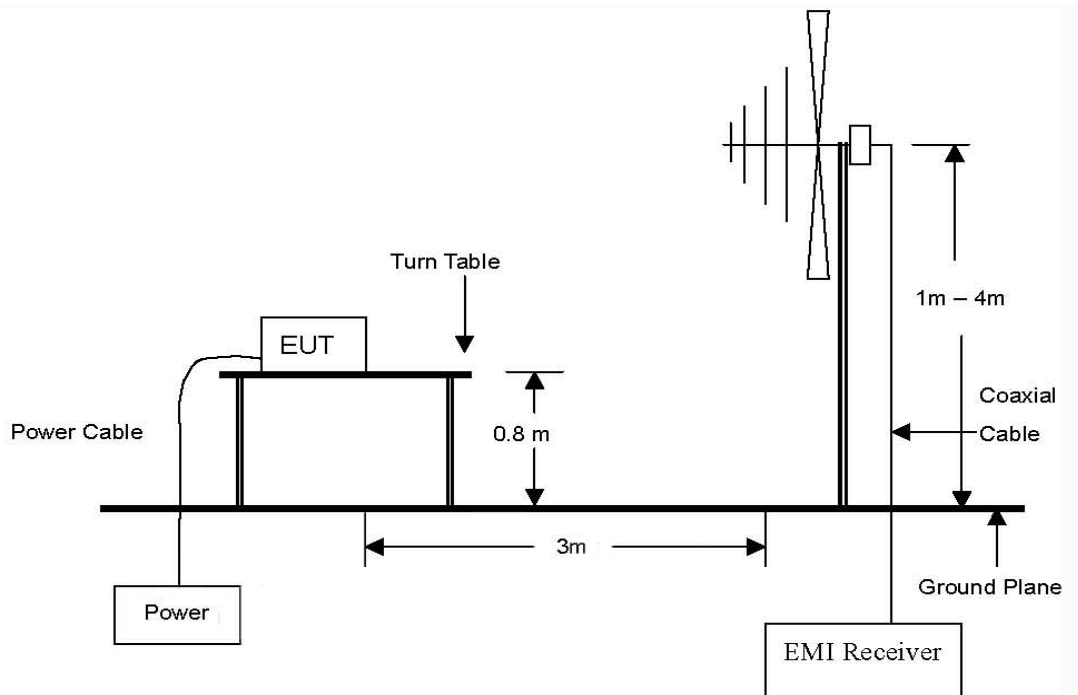

The diagram below shows the test setup that is utilized to make the measurements for emission from 1 GHz to 20 GHz Emissions.

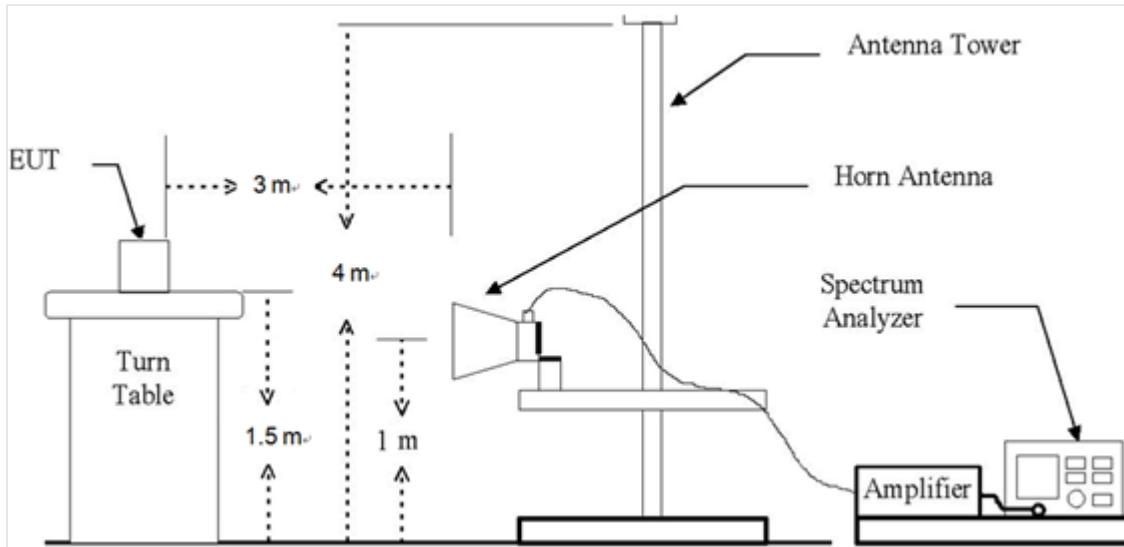

2.2. Limit

2.2.1. Limit of RF Radiated Output Power

FCC

- §22.913(a)(5), the ERP of mobile transmitters and auxiliary test transmitters must not exceed 7 watts.

- §24.232(c), mobile and portable stations are limited to 2 watts EIRP and the equipment must employ a means for limiting power to the minimum necessary for successful communications.

IC

- RSS-132 Issue 3

5.4, the transmitter output power shall be measured in terms of average power.

The equivalent isotropically radiated power (e.i.r.p.) for mobile equipment shall not exceed 11.5 watts. Refer to SRSP-503 for base station e.i.r.p. limits.

- RSS-133 Issue 6

6.4, the equivalent isotropically radiated power (e.i.r.p.) for transmitters shall not exceed the limits given in SRSP-510. Mobile stations and hand-held portables are limited to 2 watts maximum e.i.r.p. The equipment shall employ means to limit the power to the minimum necessary for successful communication.

2.2.2. Limit of Spurious Radiated Emission

FCC

- §22.917(a), the power of any emission outside of the authorized operating frequency ranges must be attenuated below the transmitting power (P) by a factor of at least $43 + 10\log(P)$ dB.

- §24.238(a), the power of any emission outside of the authorized operating frequency ranges must be attenuated below the transmitting power (P) by a factor of at least $43 + 10 \log(P)$ dB.

IC

- RSS-132 Issue 3

5.5, Mobile and base station equipment shall comply with the limits in (i) and (ii) below.

(i) In the first 1.0 MHz band immediately outside and adjacent to each of the sub-bands specified in Section 5.1, the power of emissions per any 1 % of the occupied bandwidth shall be attenuated (in dB) below the transmitter output power P (dB W) by at least $43 + 10 \log_{10} p$ (watts).

(ii) After the first 1.0 MHz immediately outside and adjacent to each of the sub-bands, the power of emissions in any 100 kHz bandwidth shall be attenuated (in dB) below the transmitter output power P (dB W) by at least $43 + 10 \log_{10} p$ (watts). If the measurement is performed using 1 % of the occupied bandwidth, power integration over 100 kHz is required.

- RSS-133 Issue 6

6.5, Equipment shall comply with the limits in (i) and (ii) below.

(i) In the 1.0 MHz bands immediately outside and adjacent to the equipment's operating frequency block, the emission power per any 1 % of the emission bandwidth shall be attenuated (in dB) below the transmitter output power P (dB W) by at least $43 + 10 \log_{10} p$ (watts).

(ii) After the first 1.0 MHz, the emission power in any 1 MHz bandwidth shall be attenuated (in dB) below the transmitter output power P (dB W) by at least $43 + 10 \log_{10} p$ (watts). If the measurement is performed using 1 % of the emission bandwidth, power integration over 1.0 MHz is required.

2.3. Test Procedure: Based on ANSI/TIA 603E: 2016 and ANSI C63.26-2015, KDB 971168 D01 Power Meas License Digital Systems v03r01.

1. On a test site, the EUT shall be placed at 0.8 m or 1.5 m height on a turn table, and in the position close to normal use as declared by the applicant.
2. The test antenna shall be oriented initially for vertical polarization located 3 m from EUT to correspond to the fundamental frequency of the transmitter.
3. The output of the test antenna shall be connected to the measuring receiver and the peak detector is used for the measurement.
4. The maximized power level is recorded using the spectrum analyzer "Channel Power" function with the integration band set to the emissions occupied bandwidth, $RBW = 1-5\%$ of the OBW (not to exceed 1 MHz), $VBW \geq 3 \times RBW$, Detector = power averaging (rms), sweep time = auto, trace average at least 100 traces in power averaging (rms) mode, per the guidelines of KDB 971168 D01 Power Meas License Digital Systems v03r01.
5. Radiated spurious emissions measurement method was set as follows:
RBW = 100 kHz for emissions below 1 GHz and 1 MHz for emissions above 1 GHz, $VBW \geq 3 \times RBW$,
Detector = RMS, trace mode = max hold, per the guidelines of KDB 971168 D01 Power Meas License Digital Systems v03r01.
6. The transmitter shall be switched on, the measuring receiver shall be tuned to the frequency of the transmitter under test.
7. The test antenna shall be raised and lowered through the specified range of height until the maximum signal level is detected by the measuring receiver.
8. The transmitter shall be rotated through 360° in the horizontal plane, until the maximum signal level is detected by the measuring receiver.
9. The test antenna shall be raised and lowered again through the specified range of height until the maximum signal level is detected by the measuring receiver.
10. The maximum signal level detected by the measuring receiver shall be noted.
11. In necessary, the input attenuator setting on the measuring receiver shall be adjusted in order to increase the sensitivity of the measuring receiver.
12. The test antenna shall be raised and lowered through the specified range of height to ensure that the maximum signal is received.
13. The measurement shall be repeated with the test antenna orientated for horizontal polarization.

2.4. Test results

Ambient temperature : (23 ± 1) °C
 Relative humidity : 47 % R.H.

2.4.1. RF Radiated Output Power

WCDMA II

Frequency (MHz)	Measured Level (dB μ V)	Ant. Pol.	AF (dB/m)	CL (dB)	E (dB μ V/m)	CF (dB)	E.I.R.P.	
							(dB m)	(W)
1 852.4	88.29	H	27.60	5.59	121.48	-95.26	26.22	0.419
1 852.4	89.51	V	27.60	5.59	122.70	-95.26	27.44	0.555
1 880.0	89.47	H	27.54	5.57	122.58	-95.26	27.32	0.540
1 880.0	88.25	V	27.54	5.57	121.36	-95.26	26.10	0.407
1 907.6	88.88	H	27.50	5.41	121.79	-95.26	26.53	0.450
1 907.6	87.74	V	27.50	5.41	120.65	-95.26	25.39	0.346

WCDMA V

Frequency (MHz)	Measured Level (dB μ V)	Ant. Pol.	AF (dB/m)	CL (dB)	E (dB μ V/m)	CF (dB)	E.R.P.	
							(dB m)	(W)
826.4	93.12	H	26.76	3.59	123.47	-97.41	26.06	0.404
826.4	88.47	V	26.76	3.59	118.82	-97.41	21.41	0.138
836.6	93.33	H	27.03	3.60	123.96	-97.41	26.55	0.452
836.6	88.92	V	27.03	3.60	119.55	-97.41	22.14	0.164
846.6	92.12	H	27.13	3.69	122.94	-97.41	25.53	0.357
846.6	87.70	V	27.13	3.69	118.52	-97.41	21.11	0.129

Remark;

1. AF = Antenna Factor, CL = Cable Loss, CF = Conversion Factor.
2. E (dB μ V/m) = Measured Level (dB μ V) + Antenna Factor (dB/m) + Cable Loss (dB).
3. E.I.R.P. (dB m) = E (dB μ V/m) + CF (dB).
4. E.R.P. (dB m) = E (dB μ V/m) + CF (dB) - 2.15 (dB); where E.R.P. and E.I.R.P. are expressed in consistent units.
5. CF (dB) = 20 log D - 104.8; where D is the measurement distance in meters, According to ANSI C63.26-2015 5.2.7 and KDB 971168 D01 v03r01 5.8.4

2.4.2. Spurious Radiated Emission

WCDMA II

Frequency (MHz)	Measured Level (dB μ V)	Ant. Pol.	AF (dB/m)	AMP+CL (dB)	E (dB μ V/m)	CF (dB)	E.I.R.P. (dB m)	Limit (dB m)	Margin (dB)
Low Channel (1 852.4 MHz)									
3 708.40	48.39	H	32.13	-36.01	44.51	-95.26	-50.75	-13	37.75
7 406.60	43.68	V	36.19	-31.38	48.49	-95.26	-46.77	-13	33.77
Middle Channel (1 880.0 MHz)									
3 762.60	48.69	H	32.27	-35.84	45.12	-95.26	-50.14	-13.00	37.14
5 642.42	42.90	V	34.00	-32.36	44.54	-95.26	-50.72	-13.00	37.72
High Channel (1 907.6 MHz)									
3 816.50	47.60	H	32.17	-35.28	44.49	-95.26	-50.77	-13	37.77
5 723.40	43.21	V	34.00	-32.12	45.09	-95.26	-50.17	-13	37.17

WCDMA V

Frequency (MHz)	Measured Level (dB μ V)	Ant. Pol.	AF (dB/m)	AMP+CL (dB)	E (dB μ V/m)	CF (dB)	E.R.P. (dB m)	Limit (dB m)	Margin (dB)
Low Channel (826.4 MHz)									
1 651.26	53.85	H	25.81	-40.27	39.39	-97.41	-58.02	-13	45.02
1 651.50	52.64	V	25.82	-40.27	38.19	-97.41	-59.22	-13	46.22
2 477.25	56.75	H	28.35	-38.68	46.42	-97.41	-50.99	-13	37.99
2 481.60	59.63	V	28.34	-38.67	49.30	-97.41	-48.11	-13	35.11
Middle Channel (836.6 MHz)									
1 673.60	53.10	H	26.04	-40.15	38.99	-97.41	-58.42	-13	45.42
1 673.90	52.05	V	26.04	-40.15	37.94	-97.41	-59.47	-13	46.47
2 509.80	57.10	H	28.32	-38.54	46.88	-97.41	-50.53	-13	37.53
2 510.24	60.20	V	28.32	-38.54	49.98	-97.41	-47.43	-13	34.43
High Channel (846.6 MHz)									
1 694.58	52.90	H	26.25	-39.92	39.23	-97.41	-58.18	-13	45.18
1 694.60	51.30	V	26.25	-39.92	37.63	-97.41	-59.78	-13	46.78
2 540.20	57.20	H	28.38	-38.45	47.13	-97.41	-50.28	-13	37.28
2 540.60	60.42	V	28.38	-38.45	50.35	-97.41	-47.06	-13	34.06

Remark;

1. AF = Antenna Factor, CL = Cable Loss, CF = Conversion Factor.
2. $E \text{ (dB}\mu\text{V/m)} = \text{Measured Level (dB}\mu\text{V)} + \text{Antenna Factor (dB/m)} + \text{Cable Loss (dB)}$.
3. $\text{E.I.R.P. (dB m)} = E \text{ (dB}\mu\text{V/m)} + \text{CF (dB)}$.
4. $\text{E.R.P. (dB m)} = E \text{ (dB}\mu\text{V/m)} + \text{CF (dB)} - 2.15 \text{ (dB)}$; where E.R.P. and E.I.R.P. are expressed in consistent units.
5. $\text{CF (dB)} = 20 \log D - 104.8$; where D is the measurement distance in meters, According to ANSI C63.26-2015 5.2.7 and KDB 971168 D01 v03r01 5.8.4
6. The frequency spectrum is examined from 9 kHz to the 10th harmonic of the fundamental frequency of the transmitter. No other spurious and harmonic emissions were reported greater than listed emissions above table.

3. Conducted Output Power

3.1. Limit

CFR 47, Section FCC §2.1046 and IC RSS-Gen Issue 5 6.12.

3.2. Test Procedure

Output power shall be measured at the RF output terminals for all configurations.

1. The RF output of the transmitter was connected to the input of the mobile test unit in order to establish communication with the EUT.
2. The EUT was set up for the max. output power with pseudo random data modulation by using mobile test unit parameters.
3. The measurement performed using a wideband RF power meter.
4. This EUT was tested under all configurations and the highest power was investigated and reported.

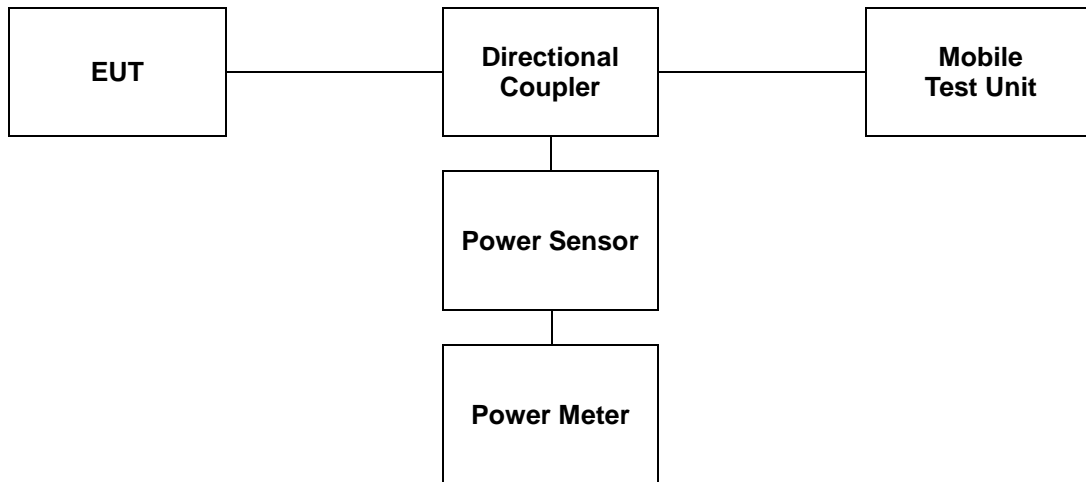

3.3. Test Result

Ambient temperature : (23 ± 1) °C
 Relative humidity : 47 % R.H.

WCDMA II							
Mode	3GPP 34.121 Subtest	Conducted Output Power					
		9262 (1 852.4 MHz)		9400 (1 880.0 MHz)		9538 (1 907.6 MHz)	
		(dB m)	(W)	(dB m)	(W)	(dB m)	(W)
Release 99	12.2 Kbps RMC	<u>23.29</u>	<u>0.213</u>	23.17	0.207	23.15	0.207
HSDPA	Subtest 1	22.23	0.167	<u>22.58</u>	<u>0.181</u>	22.42	0.175
	Subtest 2	22.29	0.169	22.29	0.169	22.57	0.181
	Subtest 3	21.81	0.152	21.83	0.152	22.00	0.158
	Subtest 4	21.81	0.152	21.83	0.152	22.01	0.159
HSUPA	Subtest 1	22.11	0.163	22.30	0.170	22.13	0.163
	Subtest 2	21.27	0.134	20.75	0.119	20.67	0.117
	Subtest 3	22.32	0.171	22.01	0.159	22.31	0.170
	Subtest 4	21.88	0.154	21.33	0.136	21.68	0.147
	Subtest 5	22.12	0.163	22.17	0.165	22.31	0.170

WCDMA V							
Mode	3GPP 34.121 Subtest	Conducted Output Power					
		4132 (826.4 MHz)		4183 (836.6 MHz)		4233 (846.6 MHz)	
		(dB m)	(W)	(dB m)	(W)	(dB m)	(W)
Release 99	12.2 Kbps RMC	<u>23.03</u>	<u>0.201</u>	22.98	0.199	23.02	0.200
HSDPA	Subtest 1	22.44	0.175	<u>22.69</u>	<u>0.186</u>	22.63	0.183
	Subtest 2	22.46	0.176	22.68	0.185	22.65	0.184
	Subtest 3	21.95	0.157	22.19	0.166	22.17	0.165
	Subtest 4	21.95	0.157	22.19	0.166	22.16	0.164
HSUPA	Subtest 1	22.39	0.173	22.29	0.169	22.23	0.167
	Subtest 2	20.56	0.114	20.83	0.121	20.94	0.124
	Subtest 3	21.39	0.138	22.08	0.161	22.02	0.159
	Subtest 4	21.14	0.130	21.28	0.134	21.48	0.141
	Subtest 5	22.28	0.169	22.11	0.163	22.14	0.164

4. Occupied Bandwidth

4.1. Limit

CFR 47, Section FCC §2.1049 and IC RSS-Gen Issue 5 6.7.

4.2. Test Procedure

FCC

The test follows section 5.4.4 of ANSI C63.26-2015.

- a. The spectrum analyzer center frequency is set to the nominal EUT channel center frequency. The frequency span for the spectrum analyzer shall be set wide enough to capture all modulation products including the emission skirts (typically a span of $1.5 \times \text{OBW}$ is sufficient).
- b. The nominal IF filter 3 dB bandwidth (RBW) shall be in the range of 1 % to 5 % of the anticipated OBW, and the VBW shall be set $\geq 3 \times \text{RBW}$.
- c. Set the reference level of the instrument as required to prevent the signal amplitude from exceeding the maximum spectrum analyzer input mixer level for linear operation. See guidance provided in 4.2.3.
- d. Set the detection mode to peak, and the trace mode to max-hold.
- e. If the instrument does not have a 99 % OBW function, recover the trace data points and sum directly in linear power terms. Place the recovered amplitude data points, beginning at the lowest frequency, in a running sum until 0.5 % of the total is reached. Record that frequency as the lower OBW frequency. Repeat the process until 99.5 % of the total is reached and record that frequency as the upper OBW frequency. The 99 % power OBW can be determined by computing the difference these two frequencies.
- f. The OBW shall be reported and plot(s) of the measuring instrument display shall be provided with the test report. The frequency and amplitude axis and scale shall be clearly labeled. Tabular data can be reported in addition to the plot(s).

IC

The following conditions shall be observed for measuring the occupied bandwidth and x dB bandwidth:

- The transmitter shall be operated at its maximum carrier power measured under normal test conditions.
- The span of the spectrum analyzer shall be set large enough to capture all products of the modulation process, including the emission skirts, around the carrier frequency, but small enough to avoid having other emissions (e.g. on adjacent channels) within the span.
- The detector of the spectrum analyzer shall be set to "Sample". However, a peak, or peak hold, may be used in place of the sampling detector since this usually produces a wider bandwidth than the actual bandwidth (worst-case measurement). Use of a peak hold (or "Max Hold") may be necessary to determine the occupied / x dB bandwidth if the device is not transmitting continuously.
- The resolution bandwidth (RBW) shall be in the range of 1 % to 5 % of the actual occupied / x dB bandwidth and the video bandwidth (VBW) shall not be smaller than three times the RBW value. Video averaging is not permitted.

Note: It may be necessary to repeat the measurement a few times until the RBW and VBW are in compliance with the above requirement.

For the 99 % emission bandwidth, the trace data points are recovered and directly summed in linear power level terms. The recovered amplitude data points, beginning at the lowest frequency, are placed in a running sum until 0.5 % of the total is reached, and that frequency recorded. The process is repeated for the highest frequency data points (starting at the highest frequency, at the right side of the span, and going down in frequency). This frequency is then recorded. The difference between the two recorded frequencies is the occupied bandwidth (or the 99 % emission bandwidth).

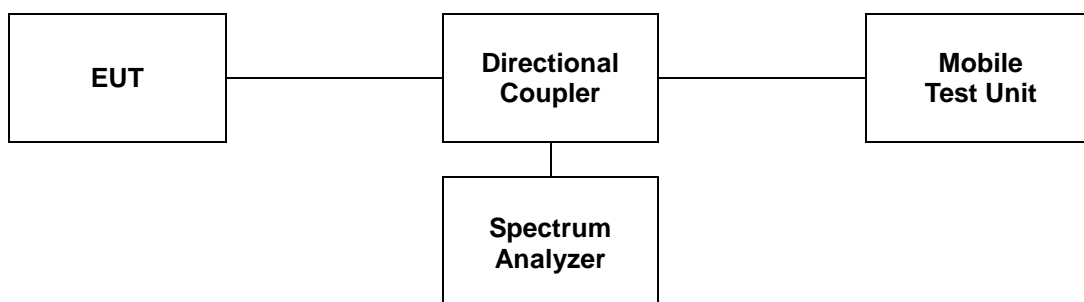

4.3 Test Results

Ambient temperature : (23 ± 1) °C
 Relative humidity : 47 % R.H.

Band	Mode	Frequency (MHz)	Occupied Bandwidth (MHz)
II	RMC	1 852.4	4.146
		1 880.0	4.126
		1 907.6	4.106
	HSDPA	1 852.4	4.126
		1 880.0	4.116
		1 907.6	4.116
V	RMC	826.4	4.126
		836.6	4.126
		846.6	4.126
	HSDPA	826.4	4.126
		836.6	4.116
		846.6	4.136

- Test plots

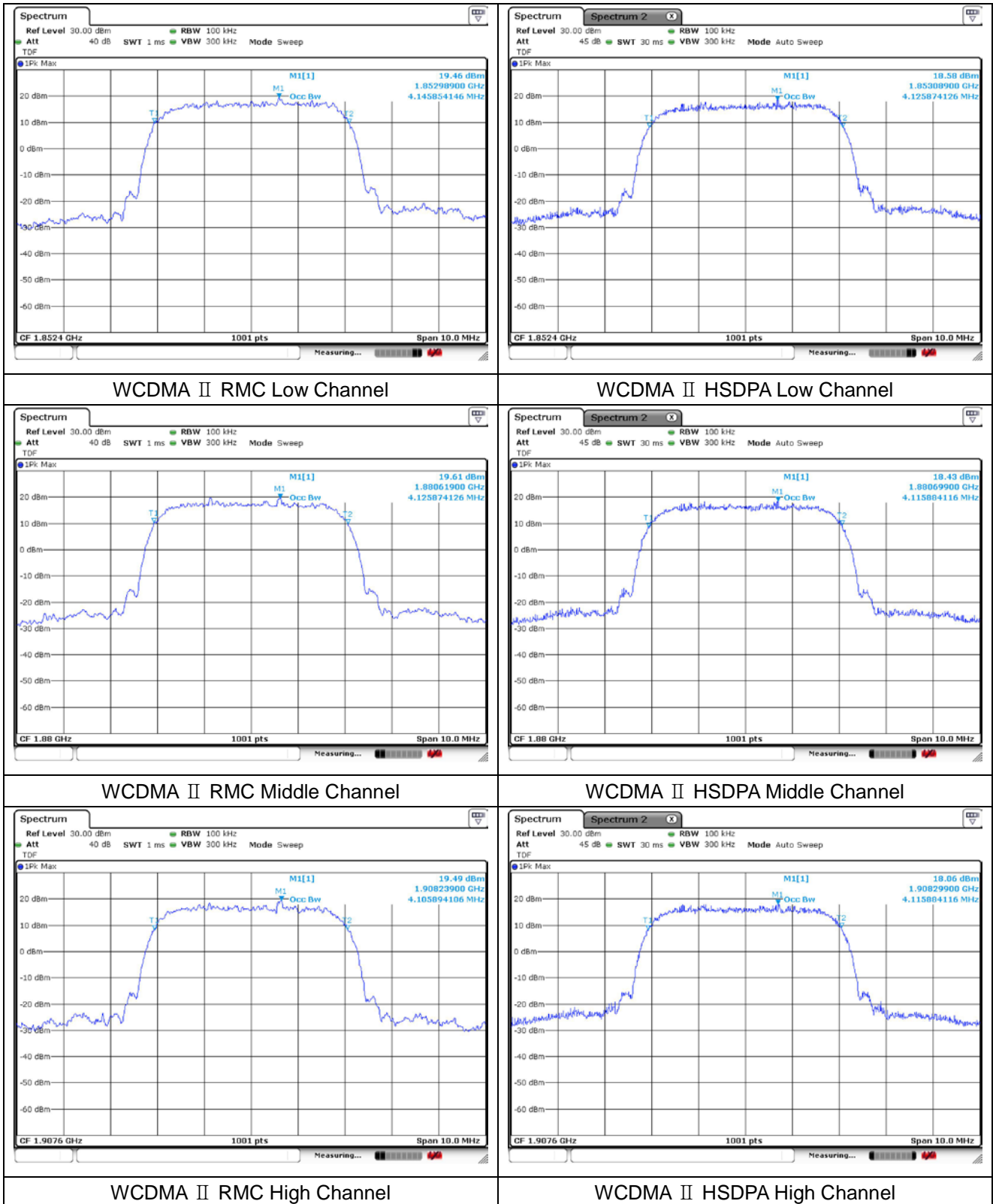

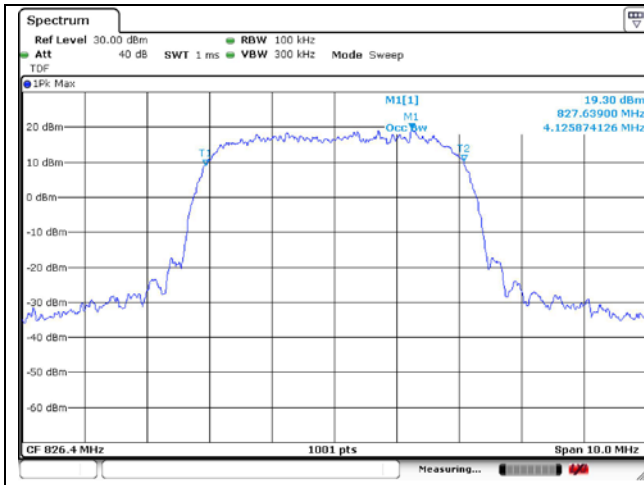

WCDMA ▾ RMC Low Channel

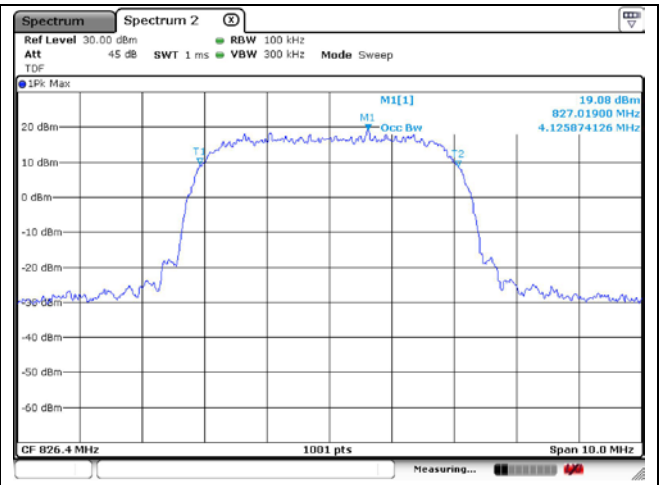

WCDMA ▾ HSDPA Low Channel

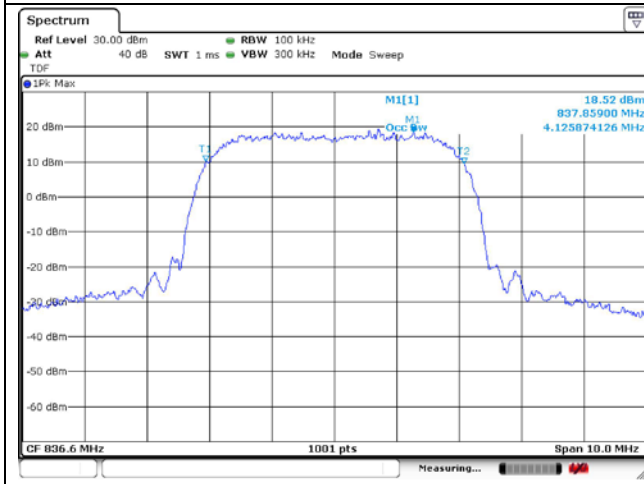

WCDMA ▾ RMC Middle Channel

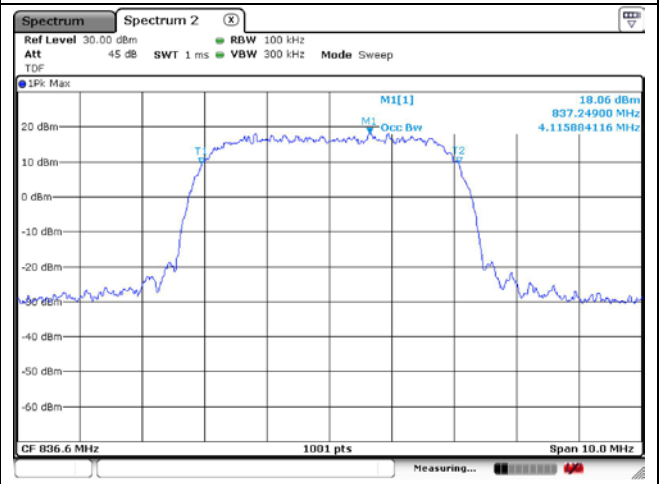

WCDMA ▾ HSDPA Middle Channel

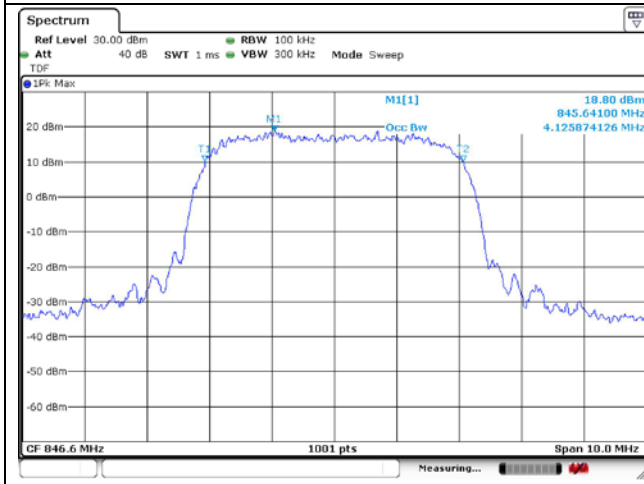

WCDMA ▾ RMC High Channel

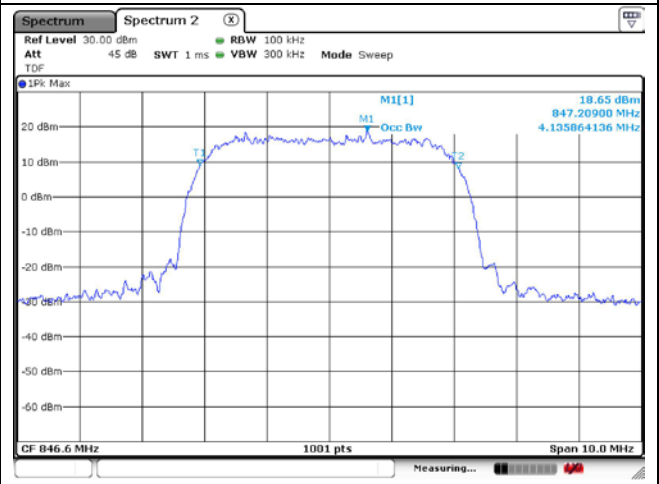

WCDMA ▾ HSDPA High Channel

5. Peak-Average Ratio

5.1. Limit

FCC

- §22.913(d) Measurement of the ERP of Cellular base transmitters and repeaters must be made using an average power measurement technique. The peak-to-average ratio (PAR) of the transmission must not exceed 13 dB.

- §24.232(d), power measurements for transmissions by stations authorized under this section may be made either in accordance with a Commission-approved average power technique or in compliance with paragraph (e) of this section. In both instances, equipment employed must be authorized in accordance with the provisions of §24.51. In measuring transmissions in this band using an average power technique, the peak-to-average ratio (PAR) of the transmission may not exceed 13 dB.

IC

- RSS-132 Issue 3

5.4, the peak-to-average power ratio (PAPR) of the transmitter shall not exceed 13 dB for more than 0.1 % of the time using a signal corresponding to the highest PAPR during periods of continuous transmission.

- RSS-133 Issue 6

6.4, the transmitter's peak-to-average power ratio (PAPR) shall not exceed 13 dB for more than 0.1 % of the time using a signal corresponding to the highest PAPR during periods of continuous transmission.

5.2. Test Procedure

The test follows section 5.2.3.4 of ANSI C63.26-2015.

See instrumentation-specific application literature for further guidance regarding use of the CCDF capability. The following guidelines are offered for performing a CCDF measurement.

- a. Set resolution/measurement bandwidth \geq OBW or specified reference bandwidth.
- b. Set the number of counts to a value that stabilizes the measured CCDF curve.
- c. Set the measurement interval as follows:
 - 1) For continuous transmissions, set to greater of $[10 \times (\text{number of points in sweep}) \times (\text{transmission symbol period})]$ or 1 ms.
 - 2) For burst transmissions, employ an external trigger that is synchronized with the EUT burst timing sequence, or use the internal burst trigger with a trigger level that allows the burst to stabilize. Set the measurement interval to a time that is less than or equal to the burst duration.
 - 3) If there are several carriers in a single antenna port, the peak power shall be determined for each individual carrier (by disabling the other carriers while measuring the required carrier) and the total peak power calculated from the sum of the individual carrier peak powers.
- d. Record the maximum PAPR level associated with a probability of 0.1 %.
- e. The peak power level is calculated from the sum of the PAPR value from step d) to the measured average power.

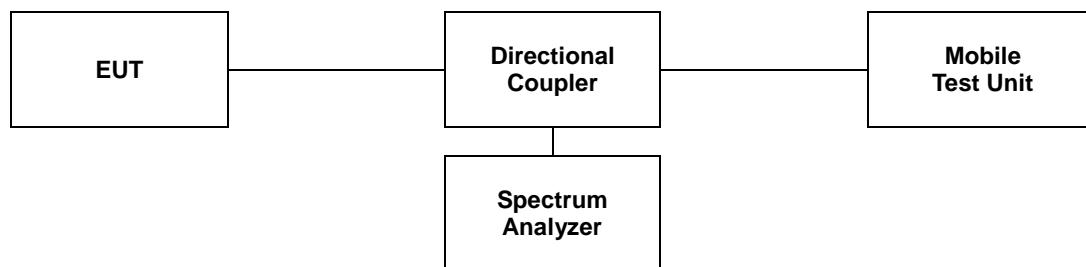

5.3 Test Results

Ambient temperature : (23 ± 1) °C
 Relative humidity : 47 % R.H.

Band	Mode	Frequency (MHz)	PAR (dB)
II	RMC	1 852.4	3.22
		1 880.0	3.22
		1 907.6	3.07
	HSDPA	1 852.4	3.39
		1 880.0	3.39
		1 907.6	3.42
V	RMC	826.4	3.13
		836.6	3.07
		846.6	3.25
	HSDPA	826.4	3.30
		836.6	3.22
		846.6	3.30

- Test plots

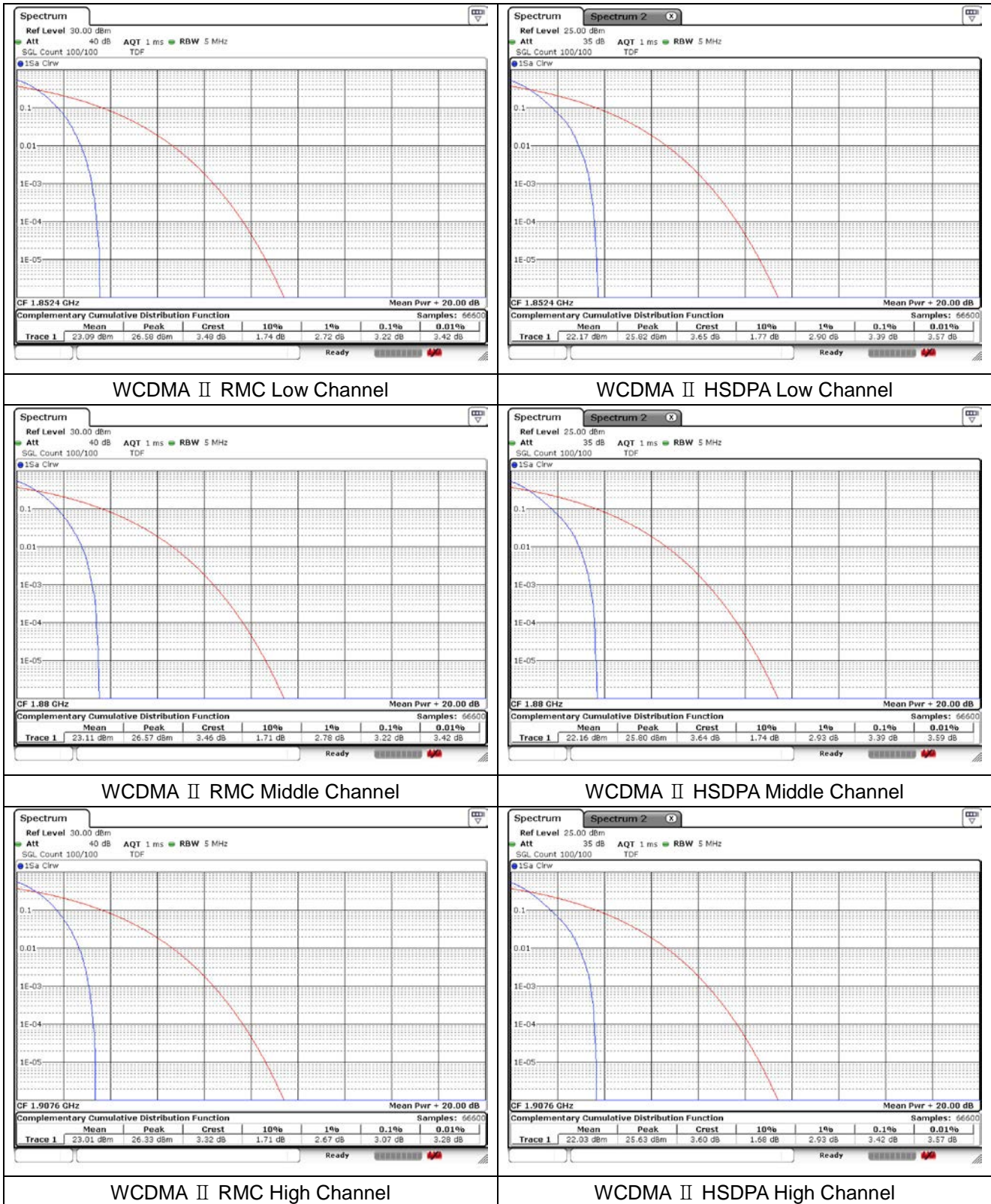

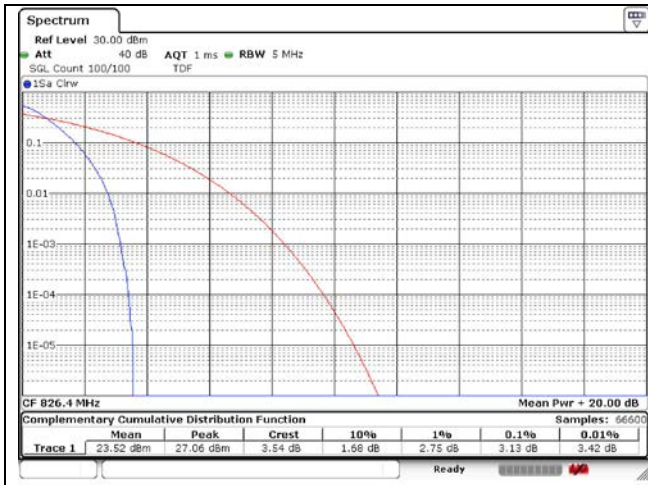

WCDMA ▾ RMC Low Channel

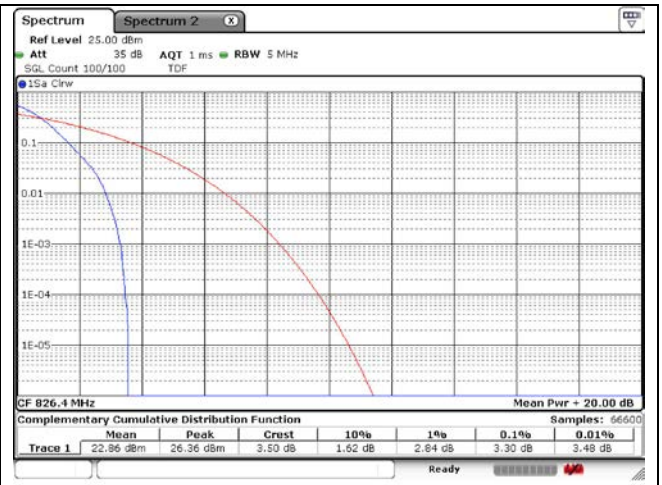

WCDMA ▾ HSDPA Low Channel



WCDMA ▾ RMC Middle Channel

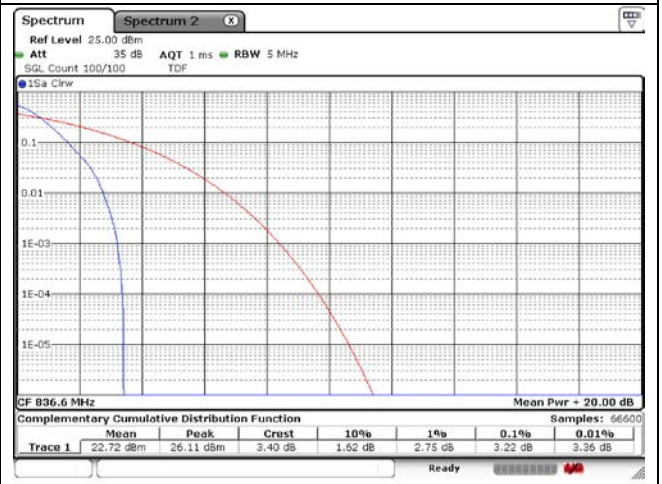

WCDMA ▾ HSDPA Middle Channel

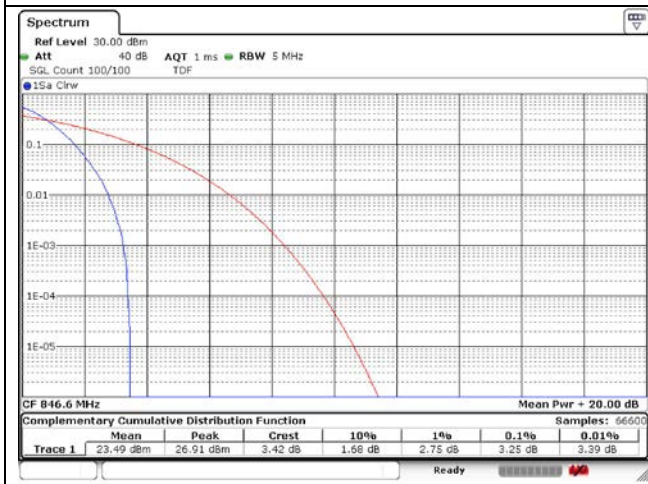

WCDMA ▾ RMC High Channel

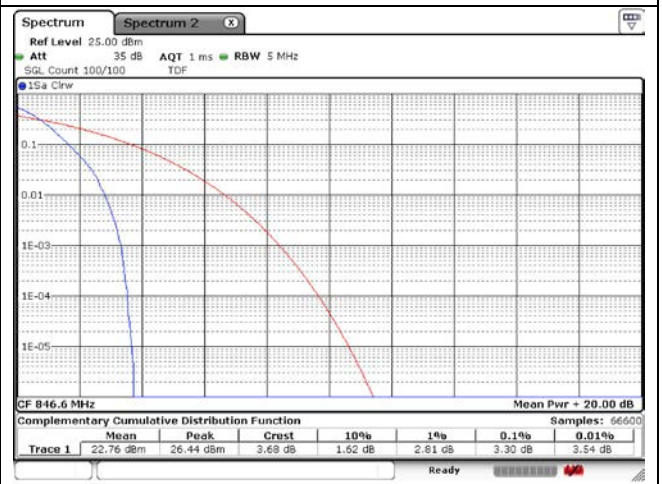

WCDMA ▾ HSDPA High Channel

6. Spurious Emissions at Antenna Terminal

6.1. Limit

FCC

- §22.917(a), the power of any emission outside of the authorized operating frequency ranges must be attenuated below the transmitting power (P) by a factor of at least $43 + 10\log(P)$ dB.

- §24.238(a), the power of any emission outside of the authorized operating frequency ranges must be attenuated below the transmitting power (P) by a factor of at least $43 + 10 \log(P)$ dB.

IC

- RSS-132 Issue 3

5.5, Mobile and base station equipment shall comply with the limits in (i) and (ii) below.

(i) In the first 1.0 MHz band immediately outside and adjacent to each of the sub-bands specified in Section 5.1, the power of emissions per any 1 % of the occupied bandwidth shall be attenuated (in dB) below the transmitter output power P (dB W) by at least $43 + 10 \log_{10} p$ (watts).

(ii) After the first 1.0 MHz immediately outside and adjacent to each of the sub-bands, the power of emissions in any 100 kHz bandwidth shall be attenuated (in dB) below the transmitter output power P (dB W) by at least $43 + 10 \log_{10} p$ (watts). If the measurement is performed using 1 % of the occupied bandwidth, power integration over 100 kHz is required.

- RSS-133 Issue 6

6.5, Equipment shall comply with the limits in (i) and (ii) below.

(i) In the 1.0 MHz bands immediately outside and adjacent to the equipment's operating frequency block, the emission power per any 1 % of the emission bandwidth shall be attenuated (in dB) below the transmitter output power P (dB W) by at least $43 + 10 \log_{10} p$ (watts).

(ii) After the first 1.0 MHz, the emission power in any 1 MHz bandwidth shall be attenuated (in dB) below the transmitter output power P (dB W) by at least $43 + 10 \log_{10} p$ (watts). If the measurement is performed using 1 % of the emission bandwidth, power integration over 1.0 MHz is required.

6.2. Test Procedure

The test follows section 5.7 of ANSI C63.26-2015.

1. Start frequency was set to 9 kHz and stop frequency was set to at least 10* the fundamental frequency.
2. Detector = Peak.
3. Trace mode = Max hold.
4. Sweep time = Auto couple.
5. The trace was allowed to stabilize.
6. Please see notes below for RBW and VBW settings.
7. For plots showing conducted spurious emissions from 9 kHz to 20 GHz, all path loss of wide frequency range was investigated and compensated to spectrum analyzer as TDF function.

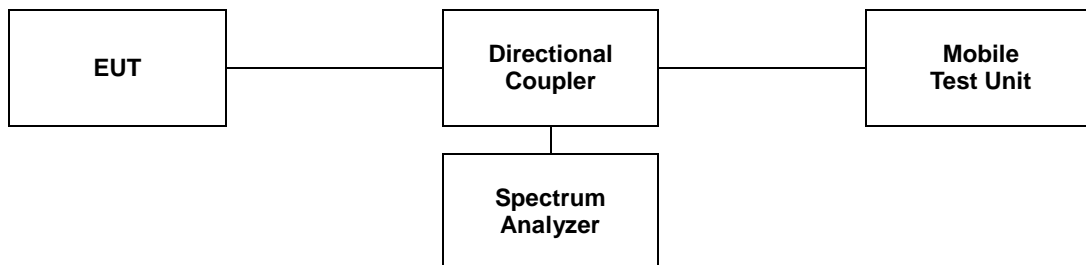

Note;

Compliance with the applicable limits is based on the use of measurement instrumentation employing a resolution bandwidth of 100 kHz or greater for frequencies less than 1 GHz and frequencies greater than 1 GHz. However, in the 1 MHz bands immediately outside and adjacent to the frequency block a resolution bandwidth of at least one percent of the emission bandwidth of the fundamental emission of the transmitter may be employed. The emission bandwidth is defined as the width of the signal between two point, one below the carrier center frequency and one above the carrier center frequency, outside of which all emission are attenuated at least 26 dB below the transmitter power.

6.3. Test Results

Ambient temperature : (23 ± 1) °C
 Relative humidity : 47 % R.H.

- Test plots

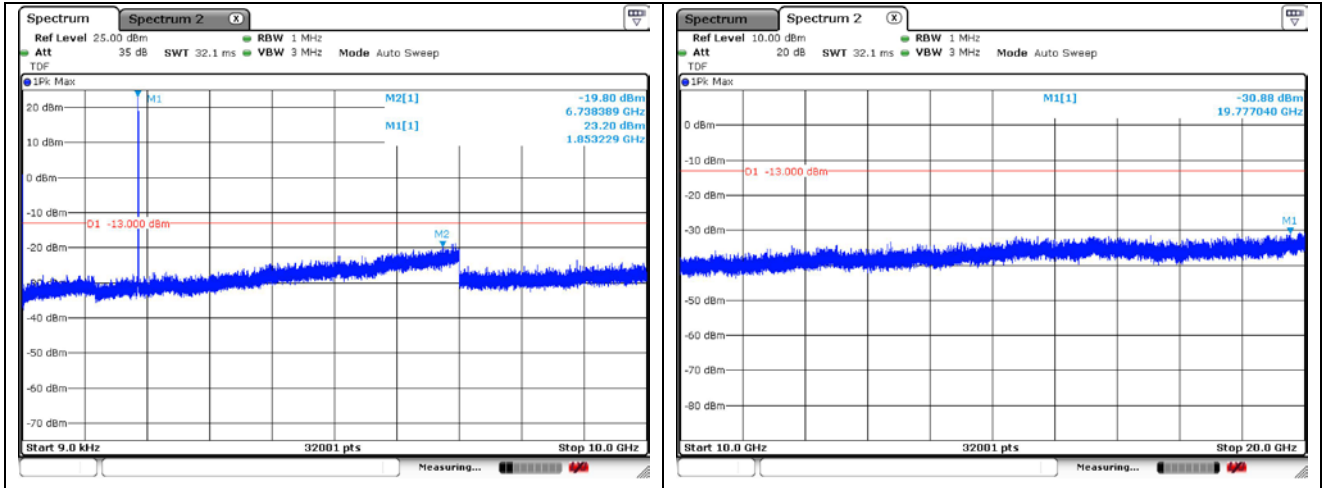

WCDMA II RMC Low Channel

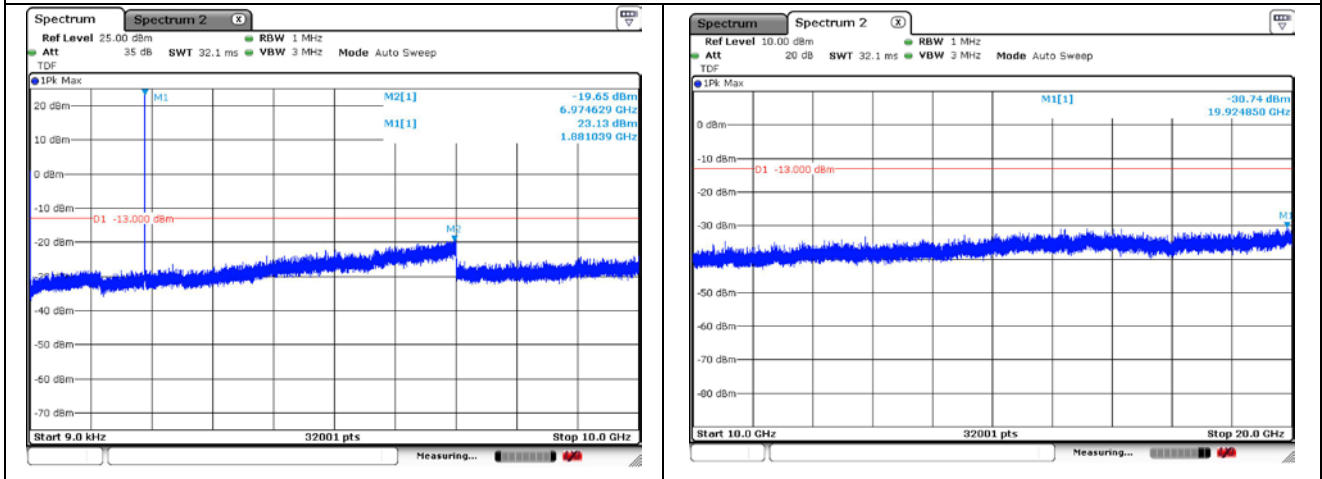

WCDMA II RMC Middle Channel

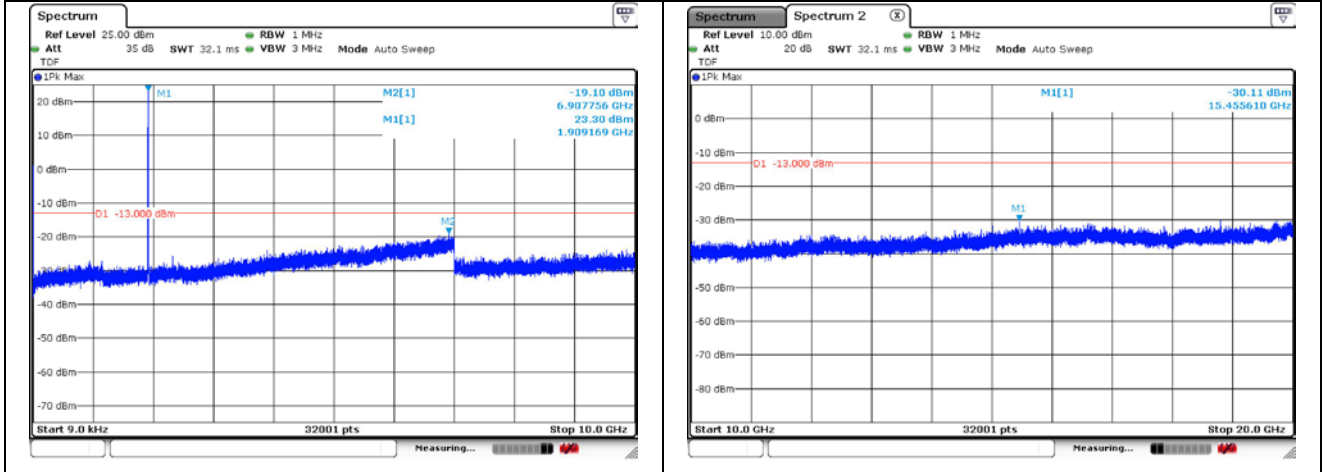

WCDMA II RMC High Channel

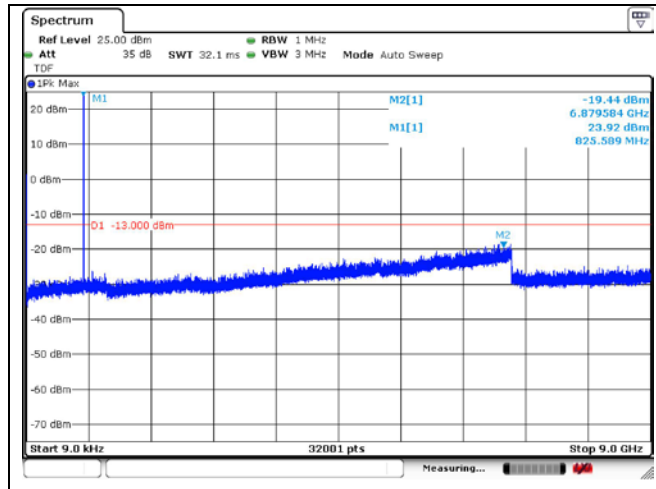

WCDMA ▾ RMC Low channel

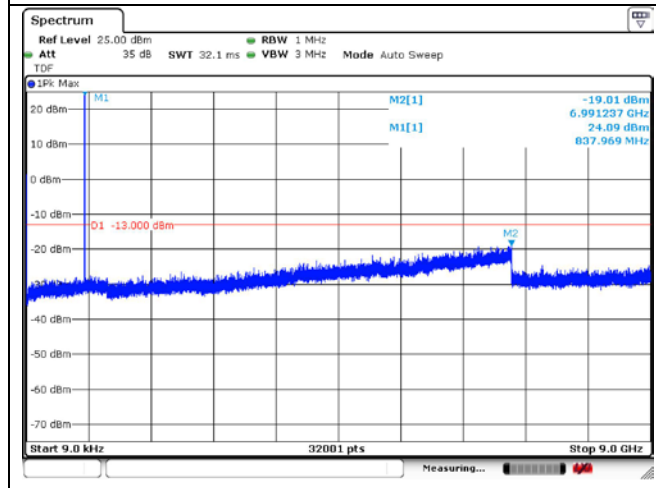

WCDMA ▾ RMC Middle channel

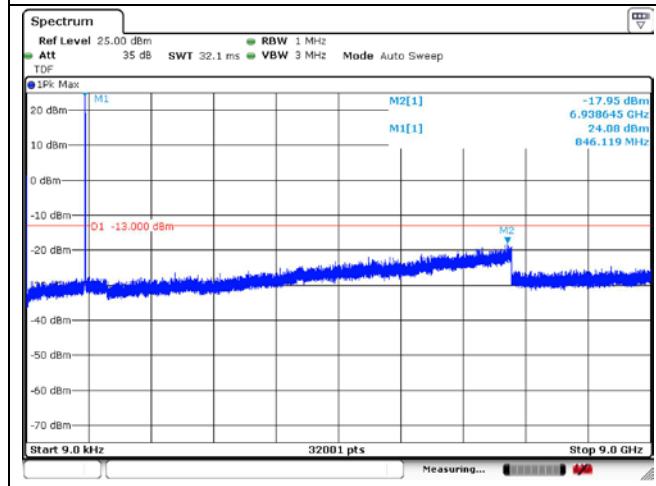

WCDMA ▾ RMC High channel

7. Band Edge

7.1. Limit

FCC

- §22.917(a), the power of any emission outside of the authorized operating frequency ranges must be attenuated below the transmitting power (P) by a factor of at least $43 + 10\log(P)$ dB.

- §24.238(a), the power of any emission outside of the authorized operating frequency ranges must be attenuated below the transmitting power (P) by a factor of at least $43 + 10 \log(P)$ dB.

IC

- RSS-132 Issue 3

5.5, Mobile and base station equipment shall comply with the limits in (i) and (ii) below.

(i) In the first 1.0 MHz band immediately outside and adjacent to each of the sub-bands specified in Section 5.1, the power of emissions per any 1 % of the occupied bandwidth shall be attenuated (in dB) below the transmitter output power P (dB W) by at least $43 + 10 \log_{10} p$ (watts).

(ii) After the first 1.0 MHz immediately outside and adjacent to each of the sub-bands, the power of emissions in any 100 kHz bandwidth shall be attenuated (in dB) below the transmitter output power P (dB W) by at least $43 + 10 \log_{10} p$ (watts). If the measurement is performed using 1 % of the occupied bandwidth, power integration over 100 kHz is required.

- RSS-133 Issue 6

6.5, Equipment shall comply with the limits in (i) and (ii) below.

(i) In the 1.0 MHz bands immediately outside and adjacent to the equipment's operating frequency block, the emission power per any 1 % of the emission bandwidth shall be attenuated (in dB) below the transmitter output power P (dB W) by at least $43 + 10 \log_{10} p$ (watts).

(ii) After the first 1.0 MHz, the emission power in any 1 MHz bandwidth shall be attenuated (in dB) below the transmitter output power P (dB W) by at least $43 + 10 \log_{10} p$ (watts). If the measurement is performed using 1 % of the emission bandwidth, power integration over 1.0 MHz is required.

7.2. Test Procedure

The test follows section 5.7 of ANSI C63.26-2015.

- a. Span was set large enough so as to capture all out of band emissions near the band edge.
- b. RBW \geq 1 % of OBW
- c. VBW \geq 3 x RBW.
- d. Detector = RMS.
- e. Trace mode = Average.
- f. Sweep time = Auto.
- g. The trace was allowed to stabilize.
- h. All path loss of frequency range was investigated and compensated to spectrum analyzer as TDF function.

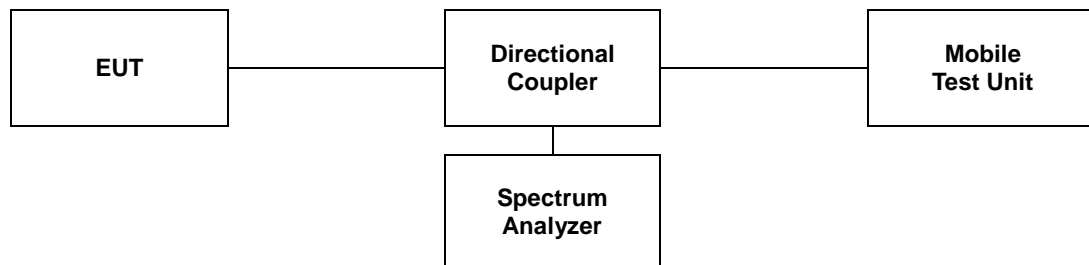

7.3. Test Results

Ambient temperature : (23 ± 1) °C
 Relative humidity : 47 % R.H.

- Test plots

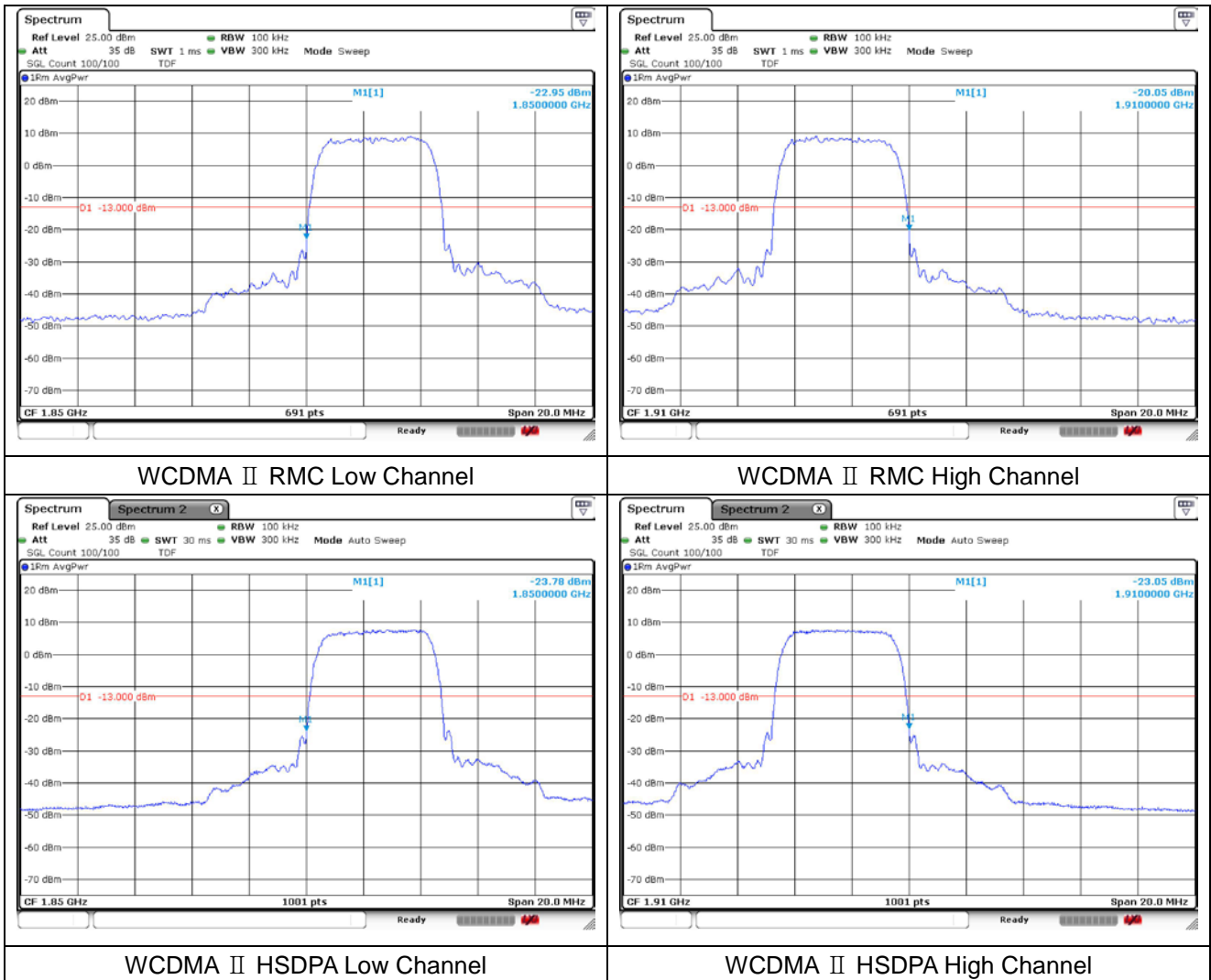

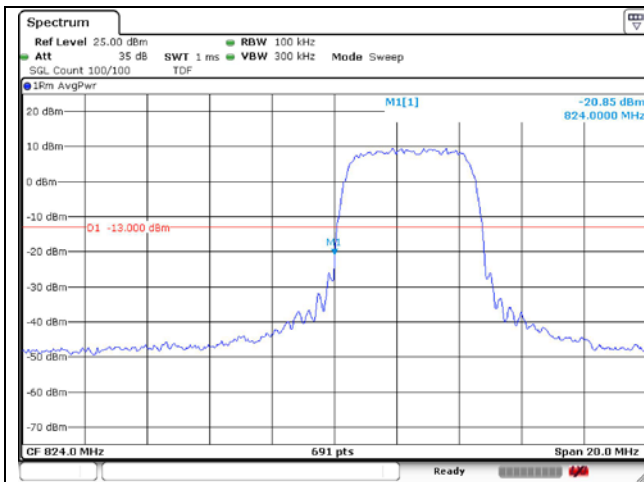

WCDMA V RMC Low Channel

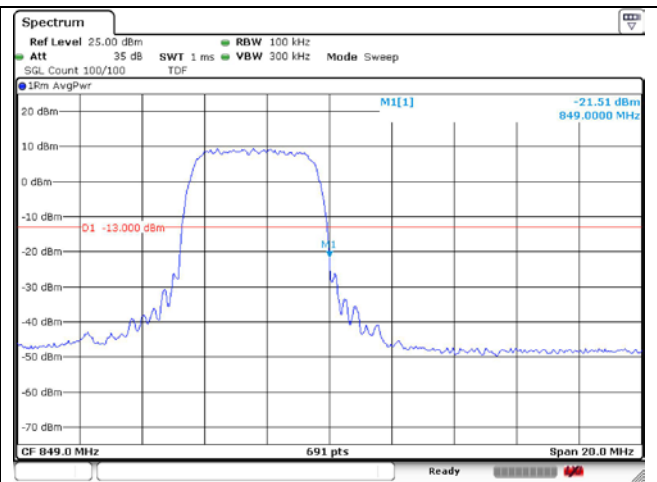

WCDMA V RMC High Channel

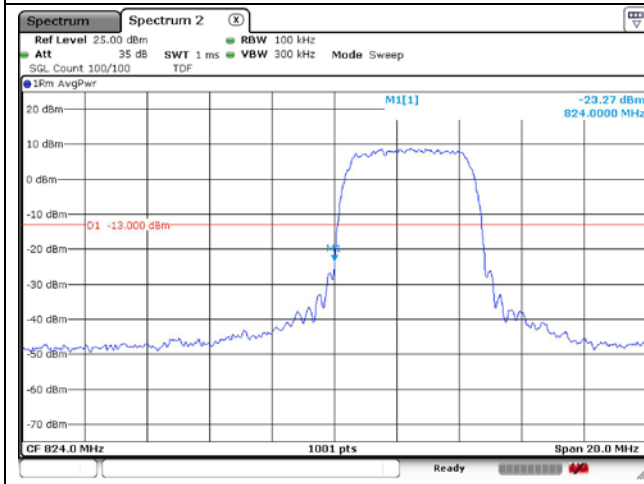

WCDMA V HSDPA Low Channel

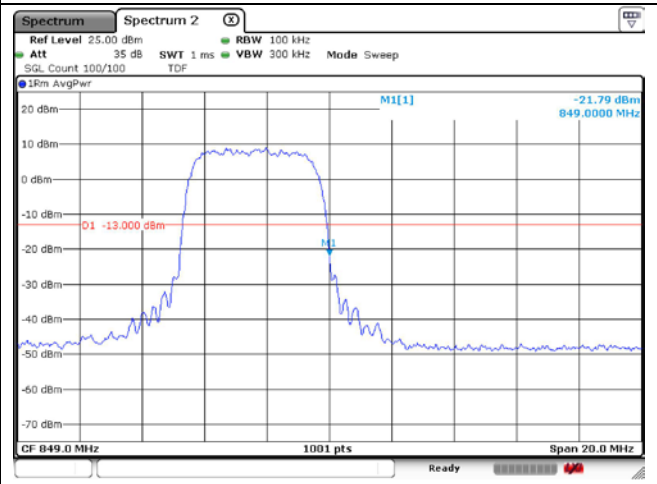

WCDMA V HSDPA High Channel

8. Frequency Stability

8.1. Limit

FCC

- § 2.1055 (a), § 2.1055 (d) & following:

- §22.355, the carrier frequency of each transmitter in the Public Mobile Services must be maintained within the tolerances given in Table of this section.

For Mobile devices operating in the 824 to 849 MHz band at a power level less than or equal to 3 Watts, the limit specified in Table C-1 is +/- 2.5 ppm.

- §24.235, the frequency stability shall be sufficient to ensure that the fundamental emission stays within the authorized frequency block.

IC

- RSS-Gen Issue 5

6.11, for licensed devices, the following measurement conditions apply:

a. at the temperatures of -30°C (-22°F), +20°C (+68°F) and +50°C (+122°F), and at the manufacturer's rated supply voltage

- RSS-132 Issue 3

5.3, The carrier frequency shall not depart from the reference frequency in excess of ±2.5 ppm for mobile stations and ±1.5 ppm for base stations.

- RSS-133 Issue 6

6.3, the carrier frequency shall not depart from the reference frequency, in excess of ±2.5 ppm for mobile stations and ±1.0 ppm for base stations.

8.2. Test Procedure

1. Frequency Stability vs. Temperature: The equipment under test was connected to an external DC power supply and the RF output was connected to a Mobile Test Unit via feed-through attenuators.
2. The EUT was placed inside the temperature chamber.
3. After the temperature stabilized for approximately 20 minutes, the frequency output was recorded from Mobile Test Unit.

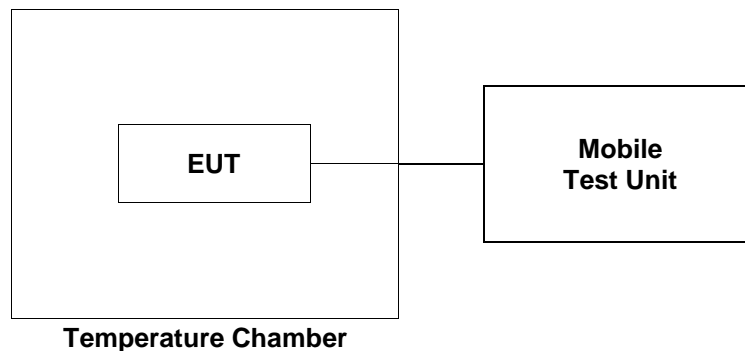

8.3. Test Results

Ambient temperature : (23 ± 1) °C
 Relative humidity : 47 % R.H.

WCDMA II mode at middle channel

Reference Frequency: 1 880.0 MHz			
Frequency Stability versus Temperature			
Environment Temperature (°C)	Power Supplied (V)	Frequency Measure with Time Elapse	
		Frequency Error (Hz)	ppm
50	3.90	-6	-0.003 2
40		8	0.004 3
30		-2	-0.001 1
20(Ref.)		5	-
10		-8	-0.004 3
0		1	0.000 5
-10		-2	-0.001 1
-20		5	0.002 7
-30		7	0.003 7
Frequency Stability versus Power Supply			
Environment Temperature (°C)	Power Supplied (V)	Frequency Measure with Time Elapse	
		Frequency Error (Hz)	ppm
20	4.49 (115 %)	-1	-0.000 5
	3.32 (85 %)	3	0.001 6

WCDMA V mode at middle channel

Reference Frequency: 836.6 MHz			
Frequency Stability versus Temperature			
Environment Temperature (°C)	Power Supplied (V)	Frequency Measure with Time Elapse	
		Frequency Error (Hz)	ppm
50	3.90	3	0.003 6
40		-5	-0.006 0
30		-2	-0.002 4
20(Ref.)		4	-
10		-6	-0.007 2
0		2	0.002 4
-10		-2	-0.002 4
-20		5	0.006 0
-30		7	0.008 4
Frequency Stability versus Power Supply			
Environment Temperature (°C)	Power Supplied (V)	Frequency Measure with Time Elapse	
		Frequency Error (Hz)	ppm
20	4.49 (115 %)	2	0.002 4
	3.32 (85 %)	3	0.003 6

- End of the Test Report -