

TEST REPORT



Dt&C Co., Ltd.

42, Yurim-ro, 154Beon-gil, Cheoin-gu, Yongin-si, Gyeonggi-do, Korea, 17042
Tel : 031-321-2664, Fax : 031-321-1664

1. Report No : DRTFCC2303-0024

2. Customer

• Name (FCC) : LG Electronics USA, Inc.

• Address (FCC) : 111 Sylvan Avenue North Building Englewood Cliffs New Jersey United States 07632

3. Use of Report : FCC Original Grant

4. Product Name / Model Name : Telematics / TLVUW3IU-W

FCC ID : BEJTLVUW3IU-W

5. FCC Regulation(s): Part 22, 27

Test Method Used : KDB971168 D01v03, ANSI/TIA-603-E-2016, ANSI C63.26-2015

6. Date of Test : 2023.01.27 ~ 2023.02.16

7. Location of Test : Permanent Testing Lab On Site Testing

8. Testing Environment : See appended test report.

9. Test Result : Refer to the attached test result.

The results shown in this test report refer only to the sample(s) tested unless otherwise stated.

This test report is not related to KOLAS accreditation.

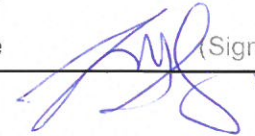
Affirmation	Tested by	Technical Manager
	Name : SeungMin Gil  (Signature)	Name : JaeJin Lee  (Signature)

2023 . 03 . 08 .

Dt&C Co., Ltd.

If this report is required to confirmation of authenticity, please contact to report@dtnc.net

Test Report Version

Test Report No.	Date	Description	Revised by	Reviewed by
DRTFCC2303-0024	Mar. 08, 2023	Initial issue	SeungMin Gil	JaeJin Lee

Table of Contents

1. GENERAL INFORMATION	5
2. INTRODUCTION	6
2.1. EUT DESCRIPTION	6
2.2. TESTING ENVIRONMENT	6
2.3. MEASURING INSTRUMENT CALIBRATION.....	6
2.4. MEASUREMENT UNCERTAINTY	6
2.5. TEST FACILITY.....	6
3. DESCRIPTION OF TESTS.....	7
3.1. ERP & EIRP (Effective Radiated Power & Equivalent Isotropic Radiated Power)	7
3.2. PEAK TO AVERAGE RATIO	9
3.3. OCCUPIED BANDWIDTH.....	10
3.4. BAND EDGE EMISSIONS AT ANTENNA TERMINAL	11
3.5. SPURIOUS AND HARMONIC EMISSIONS AT ANTENNA TERMINAL	11
3.6. UNDESIRABLE EMISSIONS	13
3.7. FREQUENCY STABILITY	14
4. LIST OF TEST EQUIPMENT	15
5. SUMMARY OF TEST RESULTS.....	16
6. SAMPLE CALCULATION	17
7. TEST DATA.....	18
7.1. CONDUCTED OUTPUT POWER	18
7.1.1. LTE Band 5.....	18
7.1.2. LTE Band 7.....	19
7.2. OCCUPIED BANDWIDTH.....	20
7.3. PEAK TO AVERAGE RATIO	20
7.4. BAND EDEG EMISSIONS (Conducted).....	20
7.5. SPURIOUS AND HARMONICS EMISSIONS (Conducted)	20
7.6. ERP & EIRP	21
7.6.1. LTE Band 5.....	21
7.6.2. LTE Band 7.....	22
7.7. UNDESIRABLE EMISSIONS (Radiated).....	23
7.7.1. LTE Band 5.....	23
7.7.2. LTE Band 7.....	24
7.8. FREQUENCY STABILITY	25
7.8.1. LTE Band 5.....	25
7.8.2. LTE Band 7.....	26
8. TEST PLOTS	27
8.1. OCCUPIED BANDWIDTH.....	27
8.1.1. LTE Band 5.....	27
8.1.2. LTE Band 7.....	31
8.2. PEAK TO AVERAGE RATIO	35

8.2.1. LTE Band 5.....	35
8.2.2. LTE Band 7.....	39
8.3. BAND EDGE EMISSIONS(Conducted).....	43
8.3.1. LTE Band 5.....	43
8.3.2. LTE Band 7.....	51
8.4. SPURIOUS AND HARMONICS EMISSIONS(Conducted)	57
8.4.1. LTE Band 5.....	57
8.4.2. LTE Band 7.....	63

1. GENERAL INFORMATION

Equipment Class	PCS Licensed Transmitter (PCB)
Product Name	Telematics
Model Name	TLVUW3IU-W
Add Model Name	-
FVIN(Firmware Version Identification Number)	X500
EUT Serial Number	212VICL329171
Supplying power	DC 12 V
Antenna Information	Antenna Type: Shark pin Antenna (Model : 5WA.035.507 B 041)

	Antenna gain(dBi)	Cable loss(dB)	Antenna gain including connected cable loss between transmitter and antenna (dBi)
LTE Band 5	1.94	4.35	-2.41
LTE Band 7	1.77	9.04	-7.27

Mode	TX Frequency (MHz)	Emission Designator	Modulation	Conducted output power		ERP	
				Max power (dBm)	Max power (W)	Max power (dBm)	Max power (W)
LTE Band 5	829 ~ 844	8M93G7D	QPSK	21.89	0.155	16.28	0.042
LTE Band 5	829 ~ 844	8M93W7D	16QAM	21.13	0.130	15.44	0.035
LTE Band 5	826.5 ~ 846.5	4M48G7D	QPSK	21.98	0.158	16.13	0.041
LTE Band 5	826.5 ~ 846.5	4M48W7D	16QAM	21.17	0.131	15.51	0.036
LTE Band 5	825.5 ~ 847.5	2M69G7D	QPSK	21.86	0.153	16.03	0.040
LTE Band 5	825.5 ~ 847.5	2M69W7D	16QAM	21.12	0.129	15.24	0.033
LTE Band 5	824.7 ~ 848.3	1M08G7D	QPSK	22.15	0.164	15.58	0.036
LTE Band 5	824.7 ~ 848.3	1M08W7D	16QAM	21.58	0.144	14.77	0.030

Mode	TX Frequency (MHz)	Emission Designator	Modulation	Conducted output power		EIRP	
				Max power (dBm)	Max power (W)	Max power (dBm)	Max power (W)
LTE Band 7	2 510 ~ 2 560	17M9G7D	QPSK	22.52	0.179	14.60	0.029
LTE Band 7	2 510 ~ 2 560	17M9W7D	16QAM	21.89	0.155	13.75	0.024
LTE Band 7	2 507.5 ~ 2 562.5	13M4G7D	QPSK	22.40	0.174	14.77	0.030
LTE Band 7	2 507.5 ~ 2 562.5	13M4W7D	16QAM	21.57	0.144	13.90	0.025
LTE Band 7	2 505 ~ 2 565	8M94G7D	QPSK	22.63	0.183	15.38	0.035
LTE Band 7	2 505 ~ 2 565	8M93W7D	16QAM	21.82	0.152	14.45	0.028
LTE Band 7	2 502.5 ~ 2 567.5	4M48G7D	QPSK	22.26	0.168	14.74	0.030
LTE Band 7	2 502.5 ~ 2 567.5	4M48W7D	16QAM	21.47	0.140	13.86	0.024

2. INTRODUCTION

2.1. EUT DESCRIPTION

The Equipment Under Test (EUT) supports 850 WCDMA and multi band LTE.

2.2. TESTING ENVIRONMENT

Ambient Condition	
▪ Temperature	+20 °C ~ +21 °C
▪ Relative Humidity	38 % ~ 39 %

2.3. MEASURING INSTRUMENT CALIBRATION

The measuring equipment, which was utilized in performing the tests documented herein, has been calibrated in accordance with the manufacturer's recommendations for utilizing calibration equipment, which is traceable to recognized national standards.

2.4. MEASUREMENT UNCERTAINTY

The measurement uncertainties shown below were calculated in accordance with requirements of ANSI C 63.4-2014. All measurement uncertainty values are shown with a coverage factor of $k = 2$ to indicate a 95 % level of confidence.

Parameter	Measurement uncertainty
Radiated Disturbance (Below 1 GHz)	4.8 dB (The confidence level is about 95 %, $k = 2$)
Radiated Disturbance (1 GHz ~ 18 GHz)	5.0 dB (The confidence level is about 95 %, $k = 2$)
Radiated Disturbance (Above 18 GHz)	5.2 dB (The confidence level is about 95 %, $k = 2$)

2.5. TEST FACILITY

Dt&C Co., Ltd.	
The 3 m test site and conducted measurement facility used to collect the radiated data are located at the 42, Yurim-ro, 154beon-gil, Cheoin-gu, Yongin-si, Gyeonggi-do, Korea 17042.	
The test site complies with the requirements of Part 2.948 according to ANSI C63.4-2014.	
- FCC & IC MRA Designation No. : KR0034	
- ISED#: 5740A	
www.dtnc.net	
Telephone	: + 82-31-321-2664
FAX	: + 82-31-321-1664

3. DESCRIPTION OF TESTS

3.1. ERP & EIRP (Effective Radiated Power & Equivalent Isotropic Radiated Power)

Test Set-up

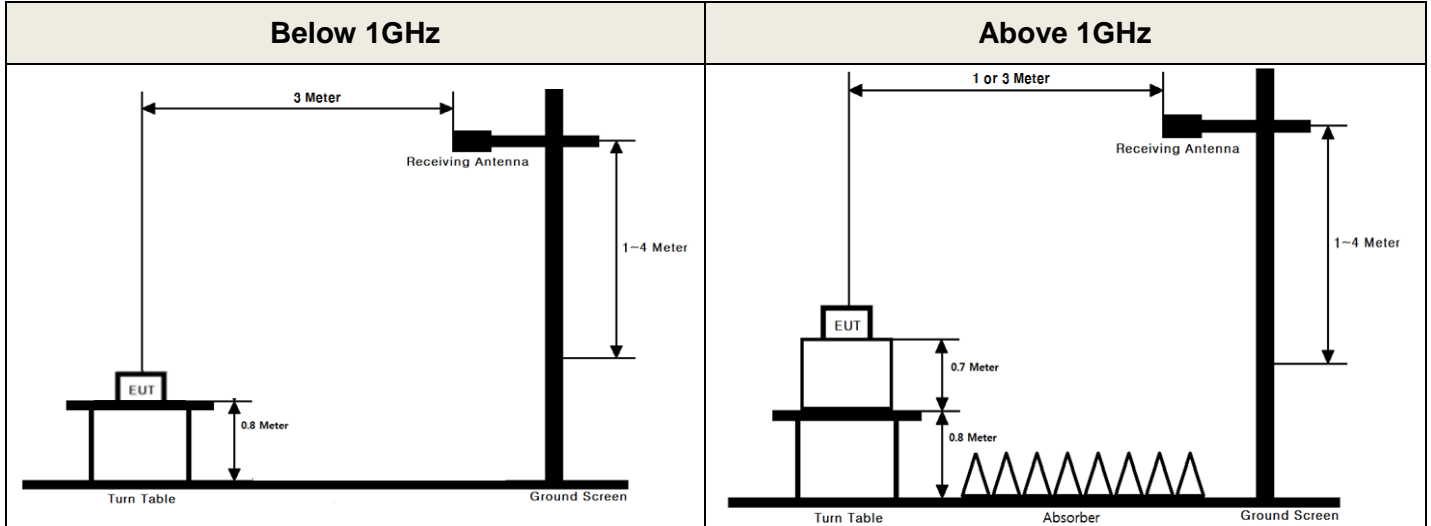

These measurements were performed at 3 m test site. The equipment under test is placed on a non-conductive table 0.8 or 1.5-meters above a turntable which is flush with the ground plane and 3 meters from the receive antenna. For measurements above 1GHz absorbers are placed on the floor between the turn table and the antenna mast in such a way so as to maximize the reduction of reflections. For measurements below 1 GHz, the absorbers are removed.

Test Procedure

- ANSI/TIA-603-E-2016 - Section 2.2.17
- KDB971168 D01v03 - Section 5.2.2
- ANSI C63.26-2015 – Section 5.2.4.4.1

Test setting

1. Set span to 2 x to 3 x the OBW.
2. Set RBW = 1 % to 5 % of the OBW.
3. Set VBW \geq 3 x RBW.
4. Set number of points in sweep \geq 2 x span / RBW.
5. Sweep time:
 - 1) Set = auto-couple, or
 - 2) Set \geq [10 x (number of points in sweep) x (transmission period)] for single sweep (automation-compatible) measurement. Transmission period is the on and off time of the transmitter.
6. Detector = power averaging (rms).
7. If the EUT can be configured to transmit continuously, then set the trigger to free run.
8. If the EUT cannot be configured to transmit continuously, then use a sweep trigger with the level set to enable triggering only on full power bursts and configure the EUT to transmit at full power for the entire duration of each sweep. Verify that the sweep time is less than or equal to the transmission burst duration. Time gating can also be used under similar constraints (i.e., configured such that measurement data is collected only during active full-power transmissions).
9. Trace average at least 100 traces in power averaging (rms) mode if sweep is set to auto-couple. To accurately determine the average power over multiple symbols, it can be necessary to increase the number of traces to be averaged above 100 or, if using a manually configured sweep time, increase the sweep time.

10. Compute the power by integrating the spectrum across the OBW of the signal using the instrument's band or channel power measurement function, with the band/channel limits set equal to the OBW band edges. If the instrument does not have a band or channel power function, then sum the spectrum levels (in linear power units) at intervals equal to the RBW extending across the entire OBW of the spectrum.

The receiver antenna height and turntable rotations were adjusted for the highest reading on the receive spectrum analyzer.

A half-wave dipole was substituted in place of the EUT. This dipole antenna was driven by a signal generator and the level of the signal generator was adjusted to obtain the same receive spectrum analyzer reading. The conducted power at the terminal of the substitute antenna is measured.

The ERP/EIRP is calculated using the following formula:

ERP/EIRP = The conducted power at the substitute antenna's terminal [dBm] + Substitute Antenna gain [dBd for ERP , dBi for EIRP]

For readings above 1 GHz, the above procedure is repeated using horn antennas and the difference between the gain of the horn antenna and an isotropic antenna are taken into consideration.

3.2. PEAK TO AVERAGE RATIO

Test set-up

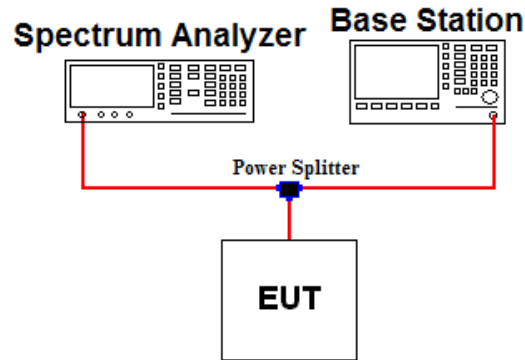

Test Procedure

- KDB971168 D01v03 - Section 5.7.2
- ANSI C63.26-2015 – Section 5.2.3.4

A peak to average ratio measurement is performed at the conducted port of the EUT.

The spectrum analyzers Complementary Cumulative Distribution Function (CCDF) measurement profile is used to determine the largest deviation between the average and the peak power of the EUT in a given bandwidth. The CCDF curve shows how much time the peak waveform spends at or above a given average power level. The present of time the signal spends at or above the level defines the probability for that particular power level.

Test setting

The spectrum Analyzer`s CCDF measurement function is enabled.

1. Set resolution/measurement bandwidth \geq OBW or specified reference bandwidth.
2. Set the number of counts to a value that stabilizes the measured CCDF curve.
3. Set the measurement interval as follows:
 - 1) For continuous transmissions, set to the greater of $[10 \times (\text{number of points in sweep}) \times (\text{transmission symbol period})]$ or 1 ms.
 - 2) For burst transmissions, employ an external trigger that is synchronized with the EUT burst timing sequence, or use the internal burst trigger with a trigger level that allows the burst to stabilize. Set the measurement interval to a time that is less than or equal to the burst duration.
 - 3) If there are several carriers in a single antenna port, the peak power shall be determined for each individual carrier (by disabling the other carriers while measuring the required carrier) and the total peak power calculated from the sum of the individual carrier peak powers.
4. Record the maximum PAPR level associated with a probability of 0.1 %.
5. The peak power level is calculated form the sum of the PAPR value from step d) to the measured average power.

3.3. OCCUPIED BANDWIDTH

Test set-up

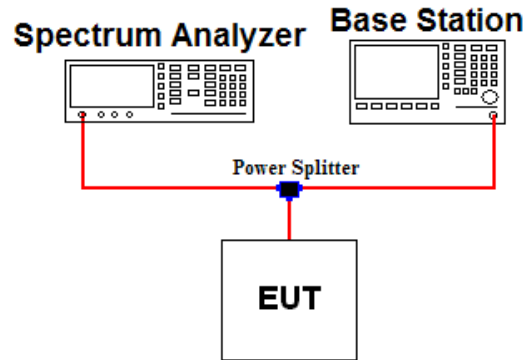

Test Procedure

- KDB971168 D01v03 - Section 4.3
- ANSI C63.26-2015 – Section 5.4.4

The occupied bandwidth, that is the frequency bandwidth such that, below its lower and above its upper frequency limits, the mean powers radiated are each equal to 0.5 percent of the total mean power of a given emission.

Test setting

1. The signal analyzer's automatic bandwidth measurement capability was used to perform the 99 % occupied bandwidth and the 26 dB bandwidth. The bandwidth measurement was not influenced by any intermediate power nulls in the fundamental emission.
2. $RBW = 1\% \sim 5\%$ of the expected OBW & $VBW \geq 3 \times RBW$
3. Detector = Peak
4. Trance mode = Max hold
5. Sweep = Auto couple
6. The trace was allowed to stabilize
7. If necessary, step 2 ~ 6 were repeated after changing the RBW such that it would be within 1 % ~ 5 % of the 99 % occupied bandwidth observed in step 6.

3.4. BAND EDGE EMISSIONS AT ANTENNA TERMINAL

Test set-up

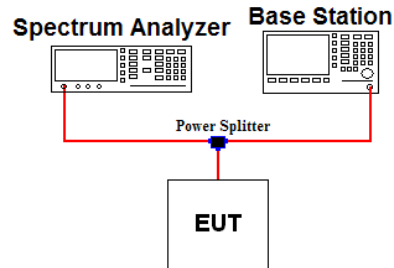

Test Procedure

- KDB971168 D01v03 - Section 6
- ANSI C63.26-2015 – Section 5.7

All out of band emissions are measured by means of a calibrated spectrum analyzer. The EUT was setup to maximum output power at its lowest and highest channel with all bandwidths, modulations and RB configurations.

The power of any spurious emission shall be attenuated below the transmitter power (P) by at least $43 + 10 \log(P)$ dB.

Test setting

1. Start and stop frequency were set such that the band edge would be placed in the center of the plot
2. Span was set large enough so as to capture all out of band emissions near the band edge
3. RBW $\geq 1\%$ of the emission bandwidth
4. VBW $\geq 3 \times$ RBW
5. Detector = RMS & Trace mode = Max hold
6. Sweep time = Auto couple or 1 s for band edge
7. Number of sweep point $\geq 2 \times$ span / RBW
8. The trace was allowed to stabilize

Note 1: Per Part 22.917(b)(1) in the 1 MHz bands immediately outside and adjacent to the frequency block a resolution bandwidth of at least one percent of the emission bandwidth of the fundamental emission of the transmitter may be employed to demonstrate compliance with the out-of-band emissions limit.

The emission bandwidth is defined as the width of the signal between two points, one below the carrier center frequency and one above the carrier center frequency, outside of which all emission are attenuated at least 26 dB below the transmitter power.

Note 2: For part 27.53(m)(4) the attenuation factor shall be not less than $40 + 10 \log(P)$ dB on all frequencies between the channel edge and 5 megahertz from the channel edge, $43 + 10 \log(P)$ dB on all frequencies between 5 megahertz and X megahertz from the channel edge, and $55 + 10 \log(P)$ dB on all frequencies more than X megahertz from the channel edge, where X is the greater of 6 megahertz or the actual emission bandwidth as defined in paragraph (m)(6) of this section. In addition, the attenuation factor shall not be less than $43 + 10 \log(P)$ dB on all frequencies between 2 490.5 MHz and 2 496 MHz and $55 + 10 \log(P)$ dB at or below 2 490.5 MHz.

Note 3: Per part 27.53(m)(6) in the 1 MHz bands immediately outside and adjacent to the frequency block a resolution bandwidth of at least two percent may be employed, except when the 1 MHz band is 2 495 MHz - 2 496 MHz, in which case a resolution bandwidth of at least one percent may be employed.

3.5. SPURIOUS AND HARMONIC EMISSIONS AT ANTENNA TERMINAL

Test set-up

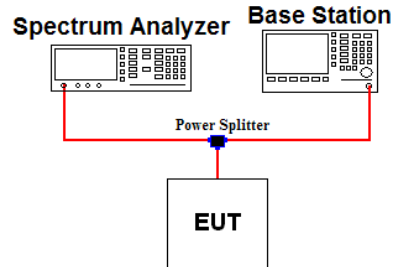

Test Procedure

- KDB971168 D01v03 - Section 6
- ANSI C63.26-2015 – Section 5.7

The level of the carrier and the various conducted spurious and harmonic frequencies is measured by means of a calibrated spectrum analyzer. The EUT was setup to maximum output power at its low, middle, high channel with all bandwidths, modulations and RB configurations. The spectrum is scanned from 9 kHz up to a frequency including its 10th harmonic.

The power of any spurious emission shall be attenuated below the transmitter power (P) by at least $43 + 10 \log(P)$ dB.

Test setting

1. RBW = 100 kHz(Below 1 GHz) or 1 MHz(Above 1 GHz) & VBW $\geq 3 \times$ RBW (Refer to Note 1)
2. Detector = RMS & Trace mode = Max hold
3. Sweep time = Auto couple
4. Number of sweep point $\geq 2 \times$ span / RBW
5. The trace was allowed to stabilize

Note 1: Compliance with these provisions is based on the use of measurement instrumentation employing a resolution bandwidth of 100 kHz or greater for frequencies less than 1 GHz and 1 MHz or greater for frequencies greater than 1GHz.

3.6. UNDESIRABLE EMISSIONS

Test Set-up

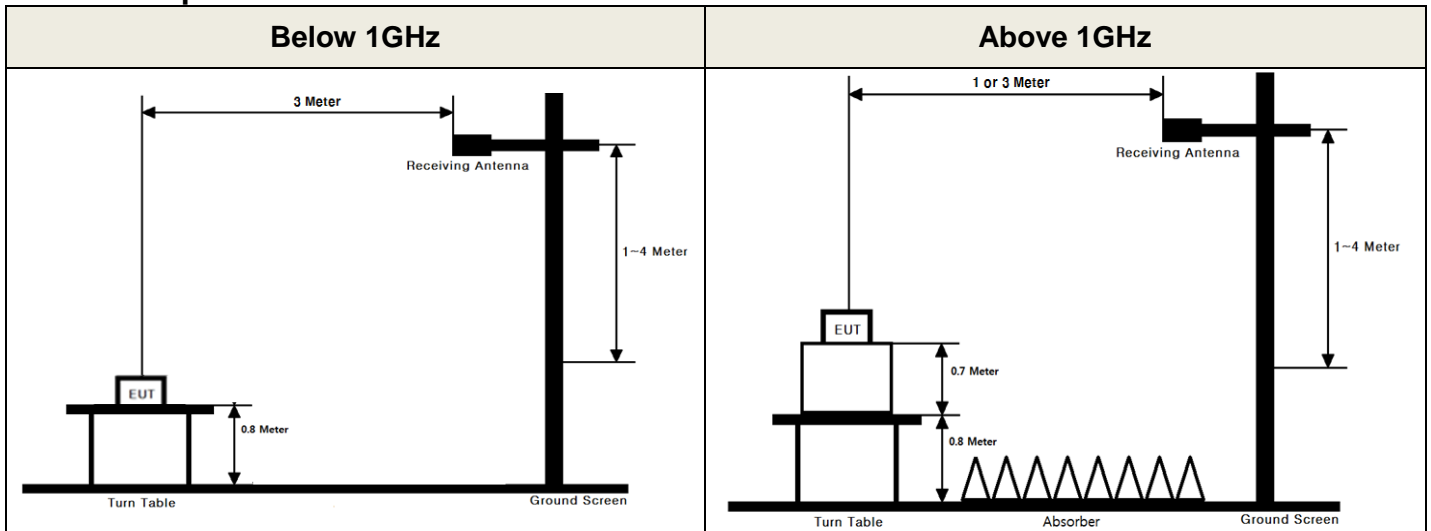

These measurements were performed at 3 test site. The equipment under test is placed on a non-conductive table 0.8 or 1.5 meters above a turntable which is flush with the ground plane and 3 meters from the receive antenna. For measurements above 1 GHz absorbers are placed on the floor between the turn table and the antenna mast in such a way so as to maximize the reduction of reflections. For measurements below 1 GHz, the absorbers are removed.

Test Procedure

- ANSI/TIA-603-E-2016 - Section 2.2.12
- KDB971168 D01v03 - Section 5.8
- ANSI C63.26-2015 – Section 5.5

Test setting

1. RBW = 100 kHz for below 1 GHz and 1 MHz for above 1 GHz / VBW $\geq 3 \times$ RBW
2. Detector = RMS & Trace mode = Max hold
3. Sweep time = Auto couple
4. Number of sweep point $\geq 2 \times$ span / RBW
5. The trace was allowed to stabilize

The receive antenna height and turntable rotations were adjusted for the highest reading on the receive spectrum analyzer. For radiated power measurements below 1 GHz, a half-wave dipole was substituted in place of the EUT. This dipole antenna was driven by a signal generator and the level of the signal generator was adjusted to obtain the same spectrum analyzer reading.

For radiated power measurements above 1 GHz, a Horn antenna was substituted in place of the EUT. This Horn antenna was driven by a signal generator and the level of the signal generator was adjusted to obtain the same spectrum analyzer reading. The difference between the gain of the horn and an isotropic antenna are taken into consideration. This measurement was performed with the EUT oriented in 3 orthogonal axis.

3.7. FREQUENCY STABILITY

Test Set-up

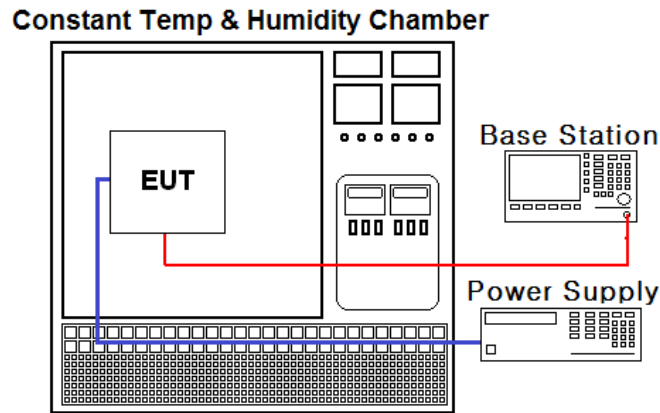

Test Procedure

- ANSI/TIA-603-E-2016
- KDB971168 D01v03 - Section 9

The frequency stability of the transmitter is measured by:

a.) **Temperature:**

The temperature is varied from -30 °C to +50 °C using an environmental chamber.

b.) **Primary Supply Voltage:**

The primary supply voltage is varied from 85 % to 115 % of the nominal value for non hand-carried battery and AC powered equipment. For hand-carried, battery-powered equipment, primary supply voltage is reduced to the battery operating end point which shall be specified by the manufacturer.

Specification:

The frequency stability shall be sufficient to ensure that the fundamental emission stays within the authorized frequency block for Part 27. The frequency stability of the transmitter shall be maintained within $\pm 0.00025\%$ (± 2.5 ppm) of the center frequency for Part 22

Time Period and Procedure:

1. The carrier frequency of the transmitter is measured at room temperature. (20 °C to provide a reference)
2. The equipment is turned on in a "standby" condition for one minute before applying power to the transmitter. Measurement of the carrier frequency of the transmitter is made within one minute after applying power to the transmitter.
3. Frequency measurements are made at 10 °C intervals ranging from -30 °C to +50 °C. A period of at least one half-hour is provided to allow stabilization of the equipment at each temperature level.

4. LIST OF TEST EQUIPMENT

Type	Manufacturer	Model	Cal.Date (yy/mm/dd)	Next.Cal. Date (yy/mm/dd)	S/N
Spectrum Analyzer	Agilent Technologies	N9020A	22/06/24	23/06/24	US47360812
Spectrum Analyzer	Agilent Technologies	N9020A	22/12/16	23/12/16	MY48010133
DC power supply	Agilent Technologies	66332A	22/06/24	23/06/24	US37473422
Multimeter	FLUKE	17B+	22/12/16	23/12/16	36390701WS
Power Splitter	Anritsu	K241B	22/12/16	23/12/16	1301184
Temp & Humi	SJ Science	SJ-TH-S50	22/03/08	23/03/08	U5542113
Radio Communication Analyzer	Anritsu	MT8820C	22/06/24	23/06/24	6200978101
Thermohygrometer	BODYCOM	BJ5478	22/12/16	23/12/16	120612-1
Thermohygrometer	BODYCOM	BJ5478	22/12/16	23/12/16	120612-2
Signal Generator	Rohde Schwarz	SMBV100A	22/12/16	23/12/16	255571
Signal Generator	ANRITSU	MG3695C	22/12/16	23/12/16	173501
Loop Antenna	ETS-Lindgren	6502	22/12/16	24/12/16	00226186
BILOG ANTENNA	Schwarzbeck	VULB 9160	22/12/16	23/12/16	3362
HORN ANT	ETS	3117	22/12/16	23/12/16	00140394
HORN ANT	A.H.Systems	SAS-574	22/06/24	23/06/24	155
PreAmplifier	H.P	8447D	22/12/16	23/12/16	2944A07774
PreAmplifier	Agilent	8449B	22/06/24	23/06/24	3008A02108
High Pass Filter	Wainwright Instruments	WHKX12-935-1000-15000-40SS	22/06/24	23/06/24	7
High Pass Filter	Wainwright Instruments	WHKX10-2838-3300-18000-60SS	22/06/24	23/06/24	2
High Pass Filter	Wainwright Instruments	WHKX6-6320-8000-26500-40CC	22/06/24	23/06/24	2
Cable	HUBER+SUHNER	SUCOFLEX100	23/01/04	24/01/04	M-01
Cable	HUBER+SUHNER	SUCOFLEX100	23/01/04	24/01/04	M-02
Cable	JUNKOSHA	MWX241/B	23/01/04	24/01/04	M-03
Cable	JUNKOSHA	MWX221	23/01/04	24/01/04	M-04
Cable	JUNKOSHA	MWX221	23/01/04	24/01/04	M-05
Cable	DTNC	Cable	23/01/04	24/01/04	M-06
Cable	JUNFLON	J12J101757-00	23/01/04	24/01/04	M-07
Cable	HUBER+SUHNER	SUCOFLEX104	23/01/04	24/01/04	M-08
Cable	HUBER+SUHNER	SUCOFLEX106	23/01/04	24/01/04	M-09

Note1: The measurement antennas were calibrated in accordance to the requirements of ANSI C63.5-2017.

Note2: The cable is not a regular calibration item, so it has been calibrated by Dt&C itself.

5. SUMMARY OF TEST RESULTS

FCC Part Section(s)	Test Description	Test Limit	Test Condition	Status Note 1
2.1046	Conducted Output Power	N/A	Conducted	C
2.1049	Occupied Bandwidth	N/A		C
27.50(d.5)	Peak to Average Ratio	N/A		C
2.1051 22.917(a)	Band Edge / Conducted Spurious Emissions	> 43 + 10log ₁₀ (P) dB at Band edge and for all out-of-band emissions		C
27.53(m)	Band Edge / Conducted Spurious Emissions	> 40 + 10log ₁₀ (P) dB at channel edge and 5 MHz from the channel edge > 43 + 10log ₁₀ (P) dB at 5 MHz and X MHz from the channel edge > 55 + 10log ₁₀ (P) dB at all frequencies more than X MHz from the channel edge		C
2.1055 27.54	Frequency Stability	Fundamental emissions must stay within Authorized frequency block (Part 27)		C
22.913(a.5)	Radiated Output Power (B5)	< 7 Watts max. ERP (FCC)	Radiated	C Note 2
27.50(h.2)	Radiated Output Power(B7)	< 2 Watts max. EIRP		C Note 2
2.1053 22.917(a)	Undesirable Emissions(B5)	> 43 + 10log ₁₀ (P) dB for all out-of-band emissions		C Note 2
27.53(m)	Undesirable Emissions(B7)	> 55 + 10log ₁₀ (P) dB for all out-of-band emissions		C Note 2

Note 1: **C**=Comply **NC**=Not Comply **NT**=Not Tested **NA**=Not Applicable

Note 2: This test item was performed in three orthogonal EUT positions and the worst case data was reported.

6. SAMPLE CALCULATION

A. Emission Designator

LTE Band 5(QPSK)

Emission Designator = **8M93G7D**
LTE OBW = 8.934 MHz
G = Phase Modulation
7 = Quantized/Digital Info
D = Data Transmission

LTE Band 5(16QAM)

Emission Designator = **8M94W7D**
LTE OBW = 8.935 MHz
W = Amplitude/Angle Modulated
7 = Quantized/Digital Info
D = Data Transmission

B. For substitution method

- 1) The EUT was placed on a turntable with 0.8 meter height for frequency below 1GHz and 1.5 meter height for frequency above 1 GHz respectively above ground.
- 2) The EUT was set 3 meters from the receiving antenna mounted on the antenna tower.
- 3) During the test, the turn table is rotated until the maximum signal is found.
- 4) Record the field strength meter's level. (ex. Spectrum reading level is -8.5 dBm)
- 5) Replace the EUT with dipole/Horn antenna that is connected to a calibrated signal generator.
- 6) Increase the signal generator output till the field strength meter's level is equal to the item (4).
(ex. Signal generator level is -18.04 dBm)
- 7) The gain of the cable and amplifier between the signal generator and terminals of substituted antenna is 46.92 dB at test frequency.
- 8) Record the level at substituted antenna terminal. (ex. 28.88dBm)
- 9) The result is calculated as below;

$$\text{EIRP(dBm)} = \text{LEVLE@ANTENNA TERMINAL} + \text{TX Antenna Gain (dBi)}$$

$$\text{ERP(dBm)} = \text{LEVLE@ANTENNA TERMINAL} + \text{TX Antenna Gain (dBd)}$$

$$\text{Where, TX Antenna Gain (dBd)} = \text{TX Antenna Gain (dBi)} - 2.15 \text{ dB}$$

7. TEST DATA

7.1. CONDUCTED OUTPUT POWER

A base station simulator was used to establish communication with the EUT. The base station simulator parameters were set to produce the maximum power from the EUT. This device was tested under all configurations and the highest power is reported. Conducted Output Powers of EUT are reported below.

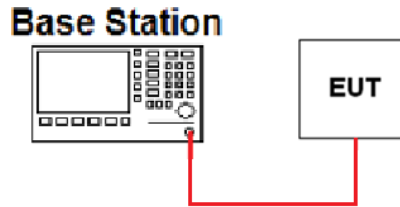

Note 1: The conducted output power was measured using the Anritsu MT8820C.

7.1.1. LTE Band 5

Channel Bandwidth (MHz)	Test Frequency (MHz)	Test Mode	Conducted Output power (dBm)	Conducted Output power (W)
10	829	QPSK	21.89	0.155
		16QAM	21.07	0.128
	836.5	QPSK	21.85	0.153
		16QAM	21.07	0.128
	844	QPSK	21.87	0.154
		16QAM	21.13	0.130
5	826.5	QPSK	21.98	0.158
		16QAM	21.17	0.131
	836.5	QPSK	21.93	0.156
		16QAM	21.15	0.130
	846.5	QPSK	21.90	0.155
		16QAM	21.12	0.129
3	825.5	QPSK	21.85	0.153
		16QAM	21.11	0.129
	836.5	QPSK	21.86	0.153
		16QAM	21.12	0.129
	847.5	QPSK	21.81	0.152
		16QAM	21.08	0.128
1.4	824.7	QPSK	22.15	0.164
		16QAM	21.57	0.144
	836.5	QPSK	21.95	0.157
		16QAM	21.58	0.144
	848.3	QPSK	21.90	0.155
		16QAM	21.44	0.139

7.1.2. LTE Band 7

Channel Bandwidth (MHz)	Test Frequency (MHz)	Test Mode	Conducted Output power (dBm)	Conducted Output power (W)
20	2 510.0	QPSK	22.38	0.173
		16QAM	21.78	0.151
	2 535.0	QPSK	22.28	0.169
		16QAM	21.62	0.145
	2 560.0	QPSK	22.52	0.179
		16QAM	21.89	0.155
15	2 507.5	QPSK	22.40	0.174
		16QAM	21.54	0.143
	2 535.0	QPSK	22.20	0.166
		16QAM	21.57	0.144
	2 562.5	QPSK	22.26	0.168
		16QAM	21.56	0.143
10	2 505.0	QPSK	22.57	0.181
		16QAM	21.76	0.150
	2 535.0	QPSK	22.52	0.179
		16QAM	21.81	0.152
	2 565.0	QPSK	22.63	0.183
		16QAM	21.82	0.152
5	2 502.5	QPSK	22.21	0.166
		16QAM	21.46	0.140
	2 535.0	QPSK	22.24	0.167
		16QAM	21.47	0.140
	2 567.5	QPSK	22.26	0.168
		16QAM	21.44	0.139

7.2. OCCUPIED BANDWIDTH

- Plots of the EUT's Occupied Bandwidth are shown in Clause 8.1

7.3. PEAK TO AVERAGE RATIO

- Plots of the EUT's Peak- to- Average Ratio are shown in Clause 8.2

7.4. BAND EDGE EMISSIONS (Conducted)

- Plots of the EUT's Band Edge Emissions are shown in Clause 8.3

7.5. SPURIOUS AND HARMONICS EMISSIONS (Conducted)

- Plots of the EUT's Spurious Emissions are shown in Clause 8.4

7.6. ERP & EIRP

- Test Notes

- 1) This device was tested under all bandwidths, modulations and RB configurations and the worst case data are reported in the below table.

7.6.1. LTE Band 5

Channel Bandwidth (MHz)	Test Frequency (MHz)	Test Mode	RB Size/ Offset	Ant Pol (H/V)	Level(dBm) @ Ant Terminal	TX Ant Gain (dBd)	ERP (dBm)	ERP (W)
10	829	QPSK	1/25	H	16.90	-0.62	16.28	0.042
		16QAM	1/25	H	16.06	-0.62	15.44	0.035
	836.5	QPSK	1/0	H	16.87	-0.65	16.22	0.042
		16QAM	1/0	H	15.94	-0.65	15.29	0.034
	844	QPSK	1/0	H	15.55	-0.68	14.87	0.031
		16QAM	1/0	H	14.76	-0.68	14.08	0.026
5	826.5	QPSK	1/24	H	16.71	-0.61	16.10	0.041
		16QAM	1/24	H	16.12	-0.61	15.51	0.036
	836.5	QPSK	1/0	H	16.78	-0.65	16.13	0.041
		16QAM	1/0	H	15.73	-0.65	15.08	0.032
	846.5	QPSK	1/12	H	15.28	-0.69	14.59	0.029
		16QAM	1/12	H	14.55	-0.69	13.86	0.024
3	825.5	QPSK	1/14	H	16.63	-0.60	16.03	0.040
		16QAM	1/14	H	15.84	-0.60	15.24	0.033
	836.5	QPSK	1/0	H	16.37	-0.65	15.72	0.037
		16QAM	1/0	H	15.54	-0.65	14.89	0.031
	847.5	QPSK	1/0	H	15.18	-0.69	14.49	0.028
		16QAM	1/0	H	14.47	-0.69	13.78	0.024
1.4	824.7	QPSK	1/2	H	16.05	-0.60	15.45	0.035
		16QAM	1/2	H	15.29	-0.60	14.69	0.029
	836.5	QPSK	1/0	H	16.23	-0.65	15.58	0.036
		16QAM	1/0	H	15.42	-0.65	14.77	0.030
	848.3	QPSK	1/2	H	14.79	-0.70	14.09	0.026
		16QAM	1/2	H	14.18	-0.70	13.48	0.022

7.6.2. LTE Band 7

Channel Bandwidth (MHz)	Tx Freq. (MHz)	Test Mode	RB Size/ Offset	Ant Pol (H/V)	Level at Antenna Terminal(dBm)	Substitute Antenna Gain(dBi)	EIRP (dBm)	EIRP (W)
20	2 510	QPSK	1/0	V	8.13	5.73	13.86	0.024
		16QAM	1/0	V	7.45	5.73	13.18	0.021
	2 535	QPSK	1/0	V	8.68	5.92	14.60	0.029
		16QAM	1/0	V	7.83	5.92	13.75	0.024
	2 560	QPSK	1/0	V	8.17	6.07	14.24	0.027
		16QAM	1/0	V	7.49	6.07	13.56	0.023
15	2 507.5	QPSK	1/0	V	8.11	5.71	13.82	0.024
		16QAM	1/0	V	7.71	5.71	13.42	0.022
	2 535	QPSK	1/0	V	8.85	5.92	14.77	0.030
		16QAM	1/0	V	7.98	5.92	13.90	0.025
	2 562.5	QPSK	1/0	V	7.36	6.07	13.43	0.022
		16QAM	1/0	V	6.88	6.07	12.95	0.020
10	2 505	QPSK	1/0	V	8.83	5.69	14.52	0.028
		16QAM	1/0	V	7.98	5.69	13.67	0.023
	2 535	QPSK	1/0	V	9.46	5.92	15.38	0.035
		16QAM	1/0	V	8.53	5.92	14.45	0.028
	2 565	QPSK	1/49	V	8.41	6.08	14.49	0.028
		16QAM	1/49	V	7.40	6.08	13.48	0.022
5	2 502.5	QPSK	1/0	V	8.23	5.67	13.90	0.025
		16QAM	1/0	V	7.56	5.67	13.23	0.021
	2 535	QPSK	1/24	V	8.82	5.92	14.74	0.030
		16QAM	1/24	V	7.94	5.92	13.86	0.024
	2 567.5	QPSK	1/24	V	7.98	6.09	14.07	0.026
		16QAM	1/24	V	7.21	6.09	13.30	0.021

7.7. UNDESIRABLE EMISSIONS (Radiated)

- Test Notes

- 1) This device was tested under all bandwidths, modulations and RB configurations and the worst case data are reported.
- 2) The frequency spectrum is examined from 9 kHz to the 10th harmonic of the fundamental frequency of the transmitter.
No other spurious and harmonic emissions were reported greater than listed emissions.
- 3) Limit for Band 5 = -13dBm
Limit for Band 7 = -25dBm

7.7.1. LTE Band 5

Channel Bandwidth (MHz)	Test Freq. (MHz)	RB Size/ Offset	Test Mode	Freq.(MHz)	Ant Pol (H/V)	Level at Antenna Terminal(dBm)	Substitute Antenna Gain(dBd)	Result (dBm)	Limit (dBm)	Margin (dB)
10	829	1/25	QPSK	1 658.13	V	-51.24	4.02	-47.22	-13.00	34.22
				2 487.30	V	-42.03	3.59	-38.44	-13.00	25.44
			16QAM	1 658.27	V	-50.73	4.02	-46.71	-13.00	33.71
				2 487.35	V	-41.52	3.59	-37.93	-13.00	24.93
	836.5	1/0	QPSK	1 664.08	V	-51.13	4.00	-47.13	-13.00	34.13
				2 496.33	V	-40.81	3.53	-37.28	-13.00	24.28
			16QAM	1 664.22	V	-50.78	4.00	-46.78	-13.00	33.78
				2 496.32	V	-40.32	3.53	-36.79	-13.00	23.79
	844	1/0	QPSK	1 679.19	V	-45.93	3.96	-41.97	-13.00	28.97
				2 518.76	V	-43.15	3.65	-39.50	-13.00	26.50
			16QAM	1 679.22	V	-45.52	3.96	-41.56	-13.00	28.56
				2 518.79	V	-42.06	3.65	-38.41	-13.00	25.41
5	836.5	1/0	QPSK	1 668.83	V	-50.55	4.54	-46.01	-13.00	33.01
				2 502.89	V	-43.11	4.13	-38.98	-13.00	25.98
			16QAM	1 668.68	V	-49.63	4.54	-45.09	-13.00	32.09
				2 502.95	V	-42.69	4.13	-38.56	-13.00	25.56

7.7.2. LTE Band 7

Channel Bandwidth (MHz)	Test Freq. (MHz)	RB Size/ Offset	Test Mode	Freq.(MHz)	Ant Pol (H/V)	Level at Antenna Terminal(dBm)	Substitute Antenna Gain(dBi)	Result (dBm)	Limit (dBm)	Margin (dB)
20	2 510	1/0	QPSK	5 002.28	V	-52.91	9.87	-43.04	-25.00	18.04
			16QAM	5 002.20	V	-53.51	9.87	-43.64	-25.00	18.64
	2 535	1/0	QPSK	5 052.25	V	-53.46	9.87	-43.59	-25.00	18.59
			16QAM	5 052.00	V	-53.97	9.87	-44.10	-25.00	19.10
	2 560	1/0	QPSK	5 101.96	V	-54.45	9.86	-44.59	-25.00	19.59
			16QAM	5 102.52	V	-53.57	9.86	-43.71	-25.00	18.71
10	2 535	1/0	QPSK	5 061.52	V	-55.07	9.87	-45.20	-25.00	20.20
			16QAM	5 061.06	V	-55.24	9.87	-45.37	-25.00	20.37

7.8. FREQUENCY STABILITY

- Test Notes

Based on the results of the frequency stability test at the center channel the frequency deviation results measured are very small. As such it is determined that the channels at the band edge would remain in-band when the maximum measured frequency deviation noted during the frequency stability tests is applied. Therefore the device is determined to remain operating in band over the temperature and voltage range as tested.

7.8.1. LTE Band 5

OPERATING FREQUENCY : 836.5 MHz
 REFERENCE VOLTAGE : 12 V DC
 LIMIT(FCC) : $\pm 0.00025\%$ or 2.5 ppm

VOLTAGE (%)	POWER (V DC)	TEMP (°C)	FREQ (Hz)	Deviation	
				(%)	(ppm)
100 %	12	+20(Ref)	836,500,005	+0.000 000 598	+0.006 0
100 %		-30	836,499,991	-0.000 001 076	-0.010 8
100 %		-20	836,499,989	-0.000 001 315	-0.013 2
100 %		-10	836,499,999	-0.000 000 120	-0.001 2
100 %		0	836,500,004	+0.000 000 478	+0.004 8
100 %		+10	836,500,007	+0.000 000 837	+0.008 4
100 %		+20	836,500,005	+0.000 000 598	+0.006 0
100 %		+30	836,500,009	+0.000 001 076	+0.010 8
100 %		+40	836,500,004	+0.000 000 478	+0.004 8
100 %		+50	836,500,006	+0.000 000 717	+0.007 2
115 %		13.80	+20	836,500,012	+0.000 001 435
85 %	10.20	+20	836,500,010	+0.000 001 195	+0.012 0

7.8.2. LTE Band 7

OPERATING FREQUENCY : 2 535 MHz
 REFERENCE VOLTAGE : 12 V DC
 LIMIT(FCC) : The frequency stability shall be sufficient to ensure that the fundamental emission stays within the authorized frequency block.

VOLTAGE (%)	POWER (V DC)	TEMP (°C)	FREQ (Hz)	Deviation	
				(%)	(ppm)
100 %	12	+20(Ref)	2,535,000,010	+0.000 000 394	+0.003 9
100 %		-30	2,535,000,015	+0.000 000 592	+0.005 9
100 %		-20	2,534,999,998	-0.000 000 079	-0.000 8
100 %		-10	2,534,999,993	-0.000 000 276	-0.002 8
100 %		0	2,535,000,006	+0.000 000 237	+0.002 4
100 %		+10	2,535,000,008	+0.000 000 316	+0.003 2
100 %		+20	2,535,000,010	+0.000 000 394	+0.003 9
100 %		+30	2,534,999,989	-0.000 000 434	-0.004 3
100 %		+40	2,535,000,012	+0.000 000 473	+0.004 7
100 %		+50	2,535,000,015	+0.000 000 592	+0.005 9
115 %	13.80	+20	2,535,000,014	+0.000 000 552	+0.005 5
85 %	10.20	+20	2,535,000,003	+0.000 000 118	+0.001 2

8. TEST PLOTS

- Test Notes:

All bandwidths, RB configurations, and modulations were investigated.
The worst case test results are reported.

8.1. OCCUPIED BANDWIDTH

8.1.1. LTE Band 5

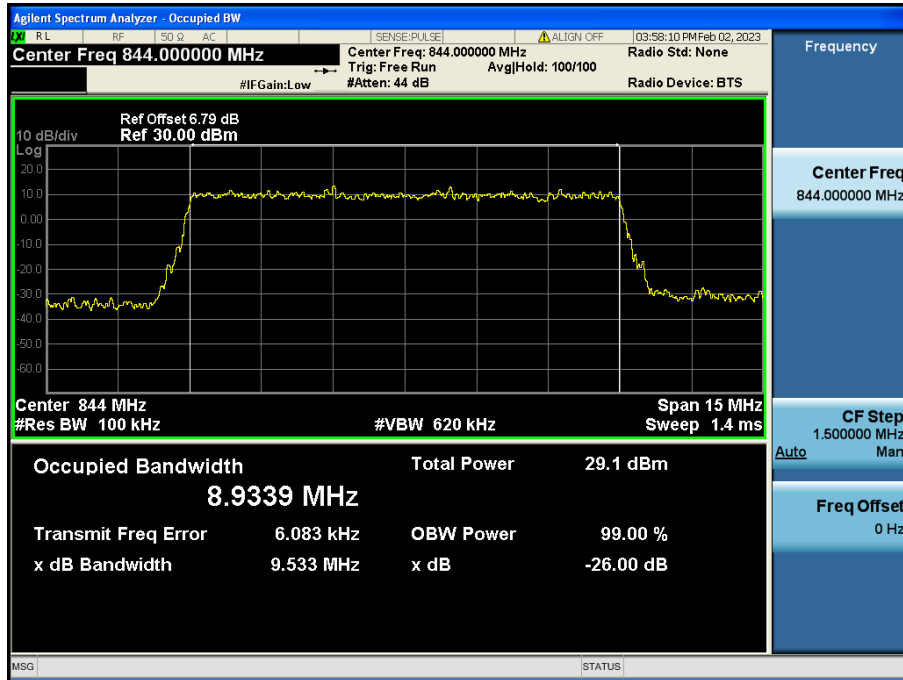

LTE Band 5 / 10 MHz / QPSK - RB Size 50

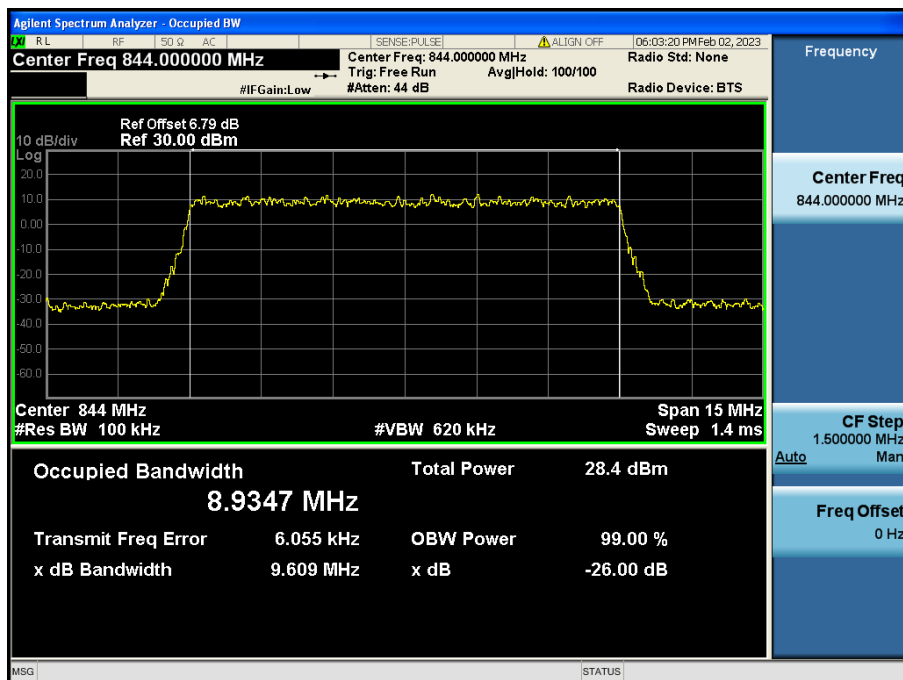

LTE Band 5 / 10 MHz / 16QAM - RB Size 50

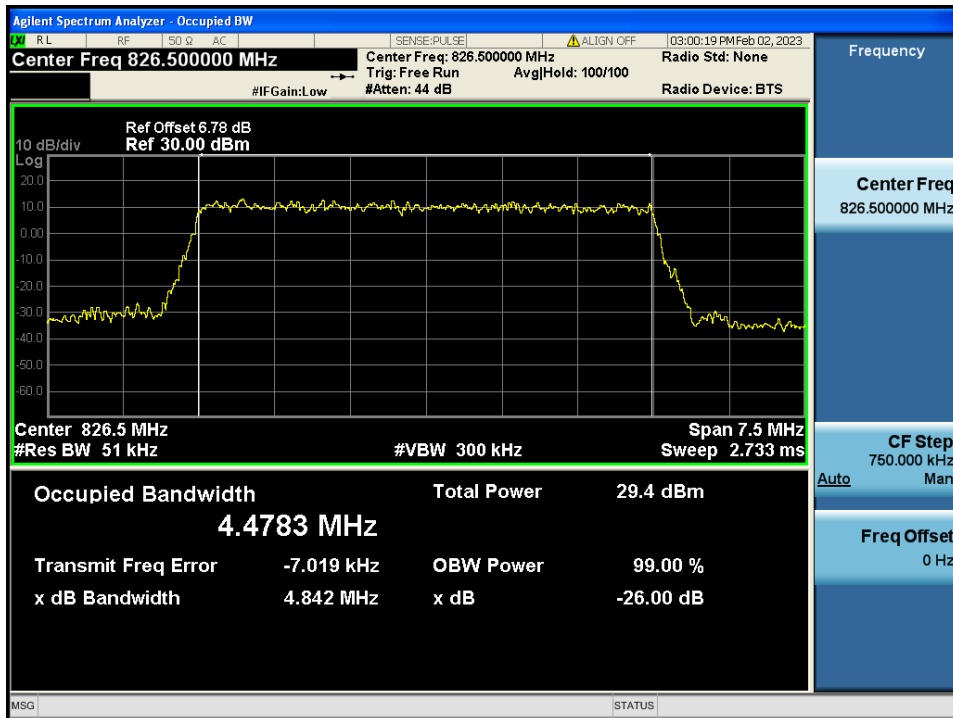

LTE Band 5 / 5 MHz / QPSK - RB Size 25

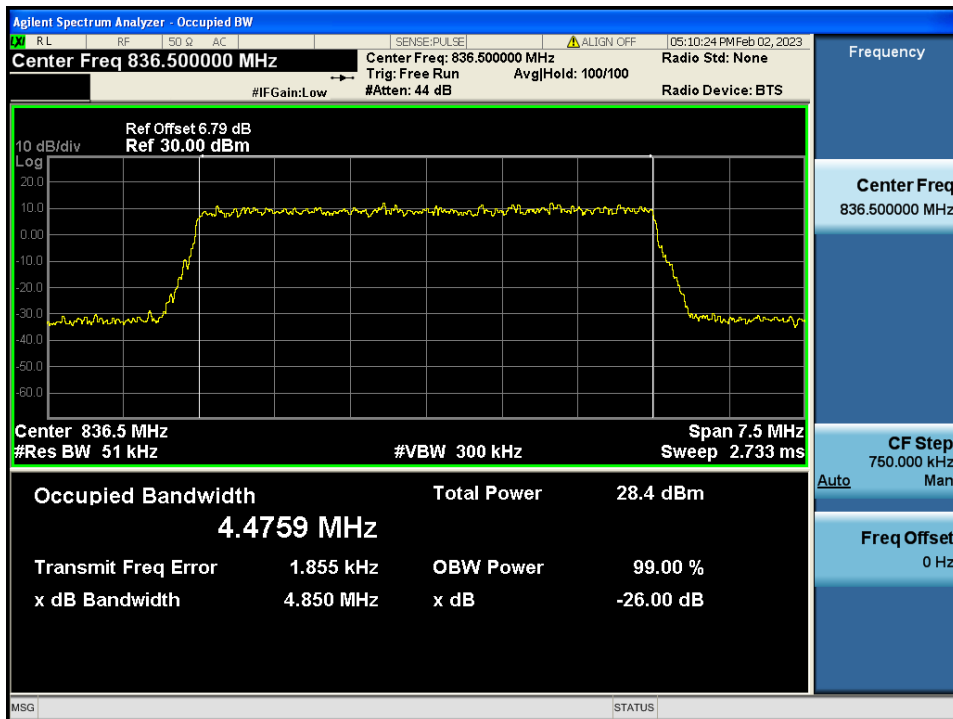

LTE Band 5 / 5 MHz / 16QAM - RB Size 25

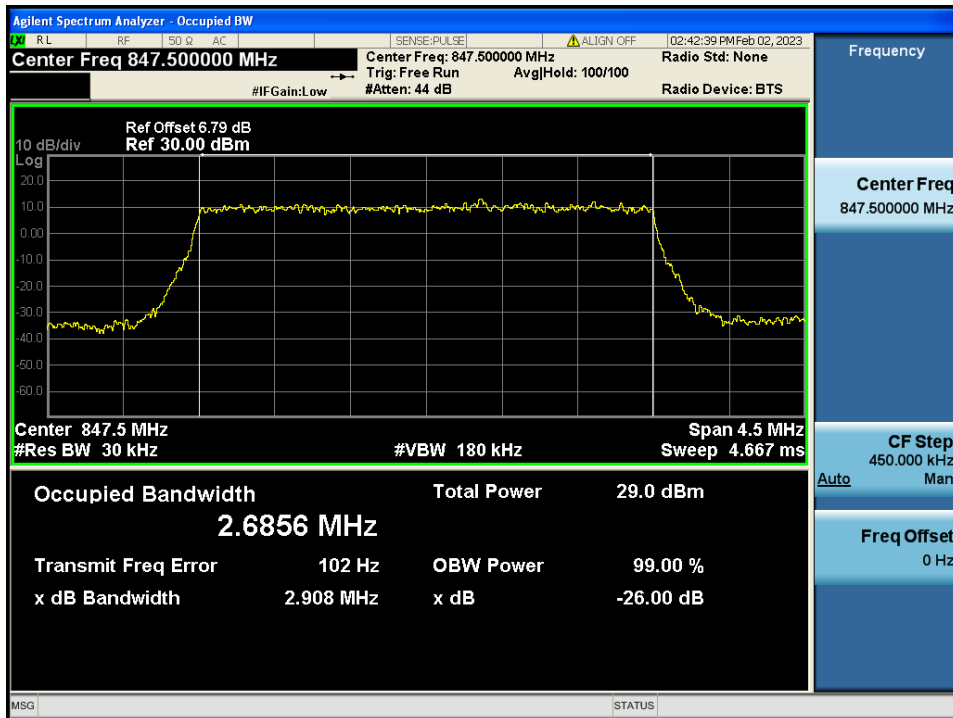

LTE Band 5 / 3 MHz / QPSK - RB Size 15

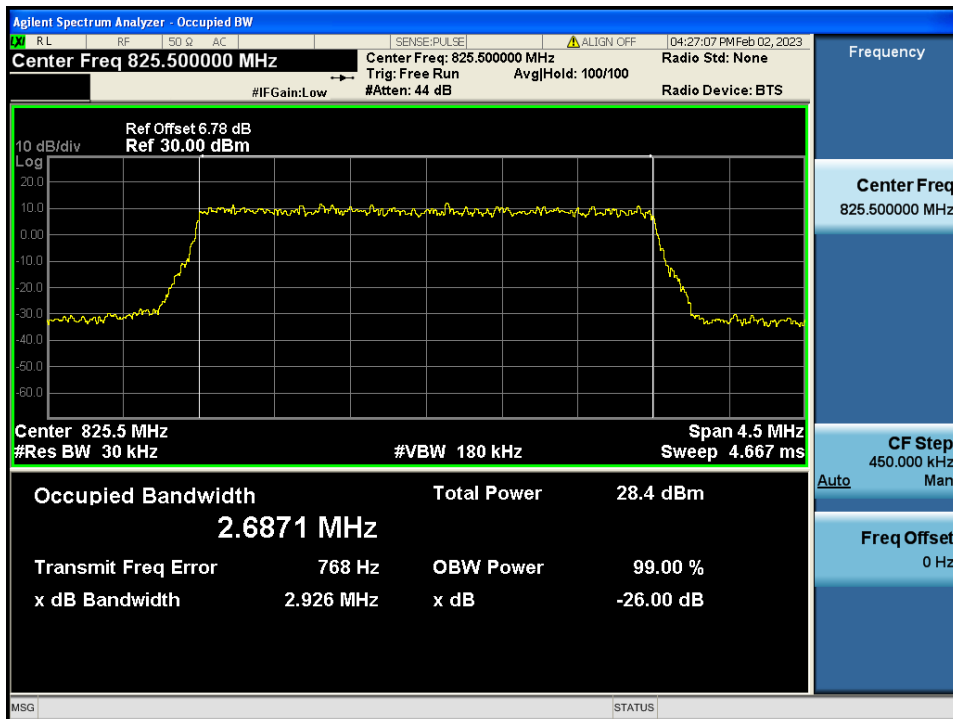

LTE Band 5 / 3 MHz / 16QAM - RB Size 15

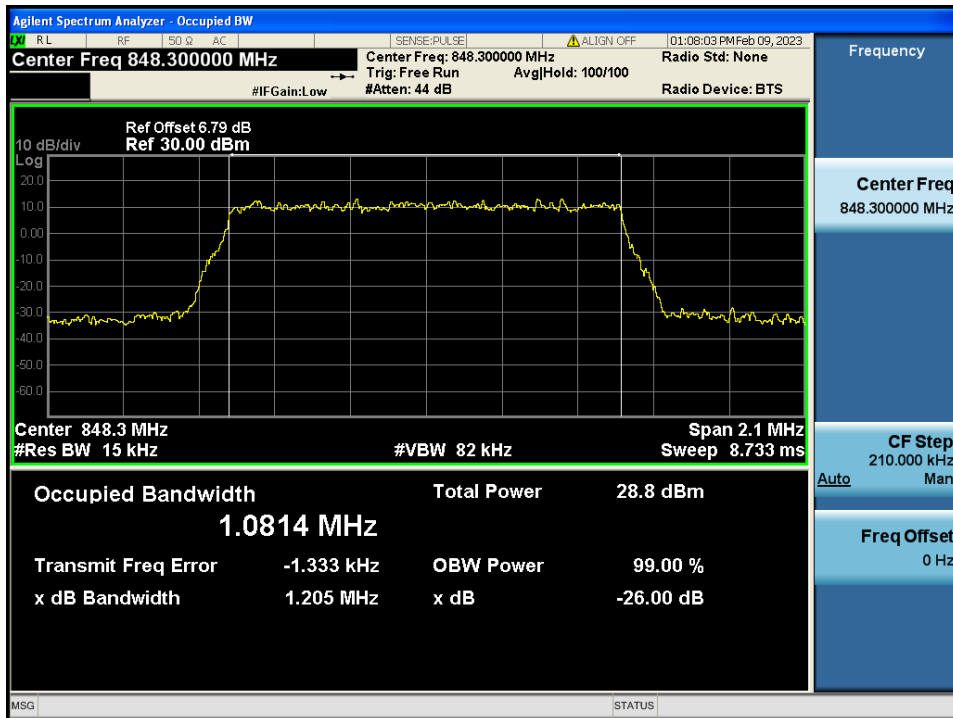

LTE Band 5 / 1.4 MHz / QPSK - RB Size 6

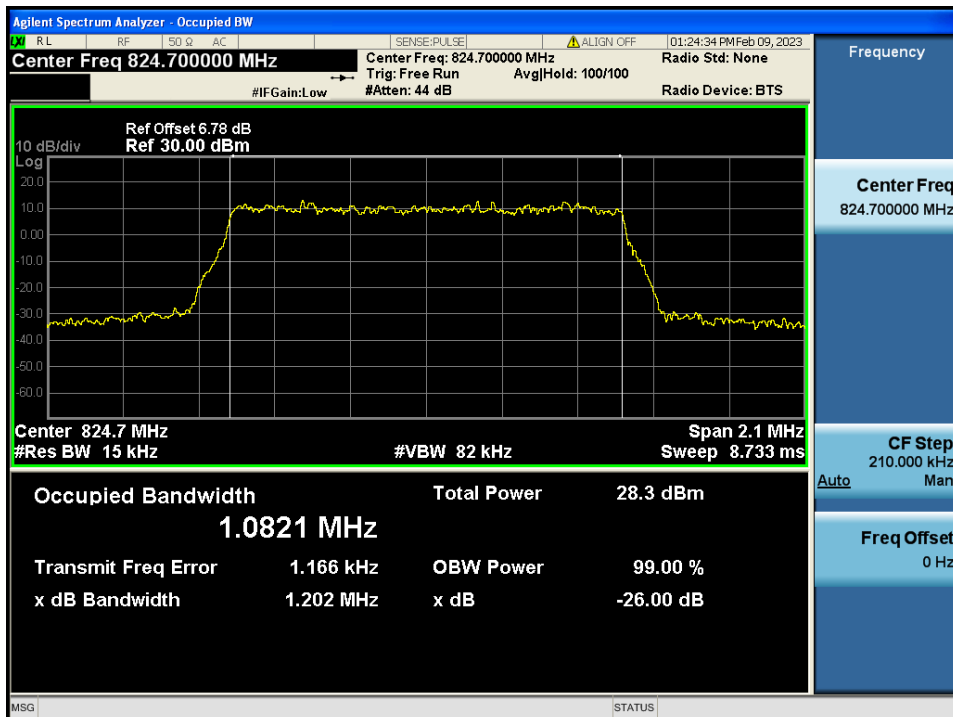

LTE Band 5 / 1.4 MHz / 16QAM - RB Size 6

8.1.2. LTE Band 7

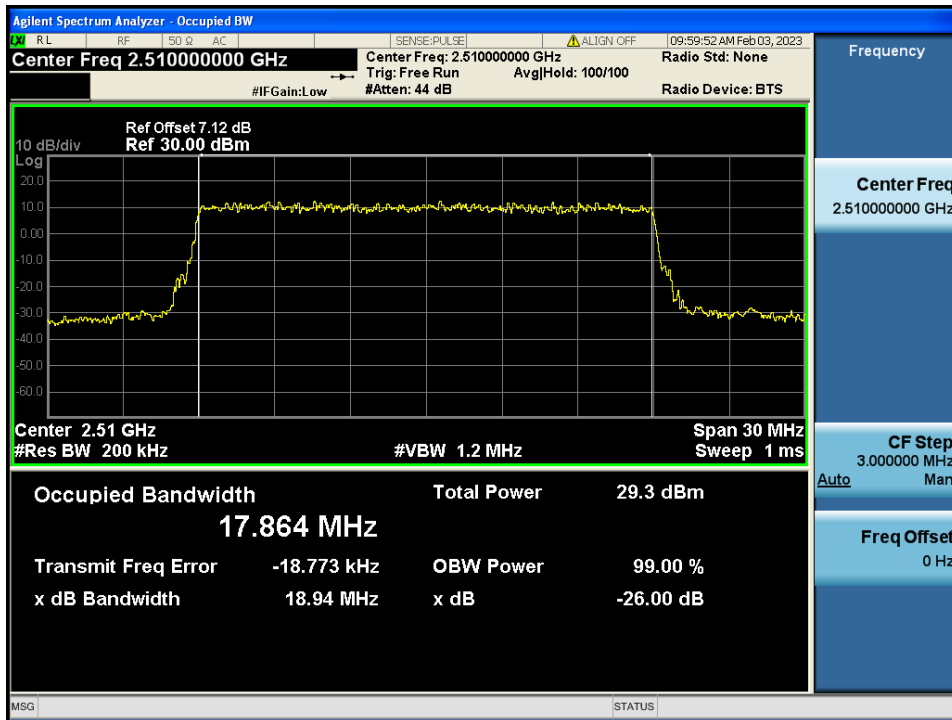

LTE Band 7 / 20 MHz / QPSK - RB Size 100

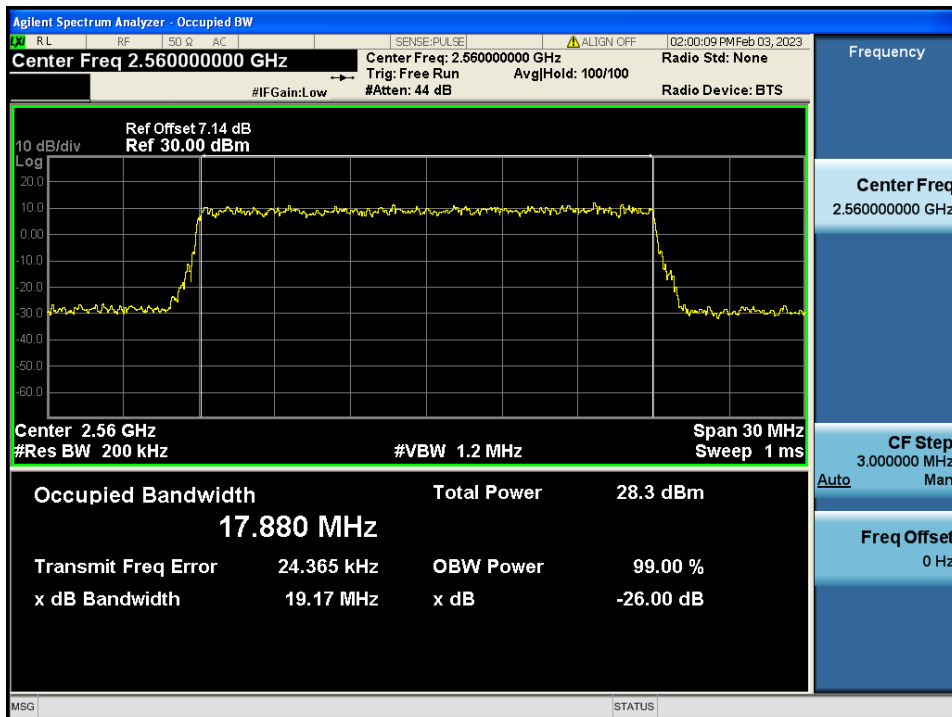

LTE Band 7 / 20 MHz / 16QAM - RB Size 100

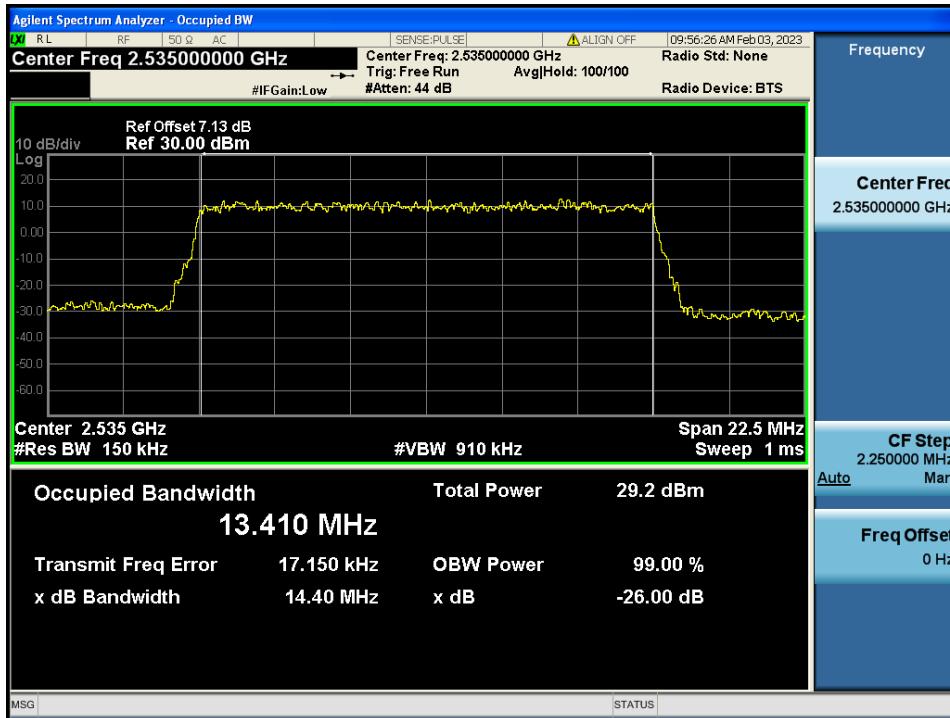

LTE Band 7 / 15 MHz / QPSK - RB Size 75

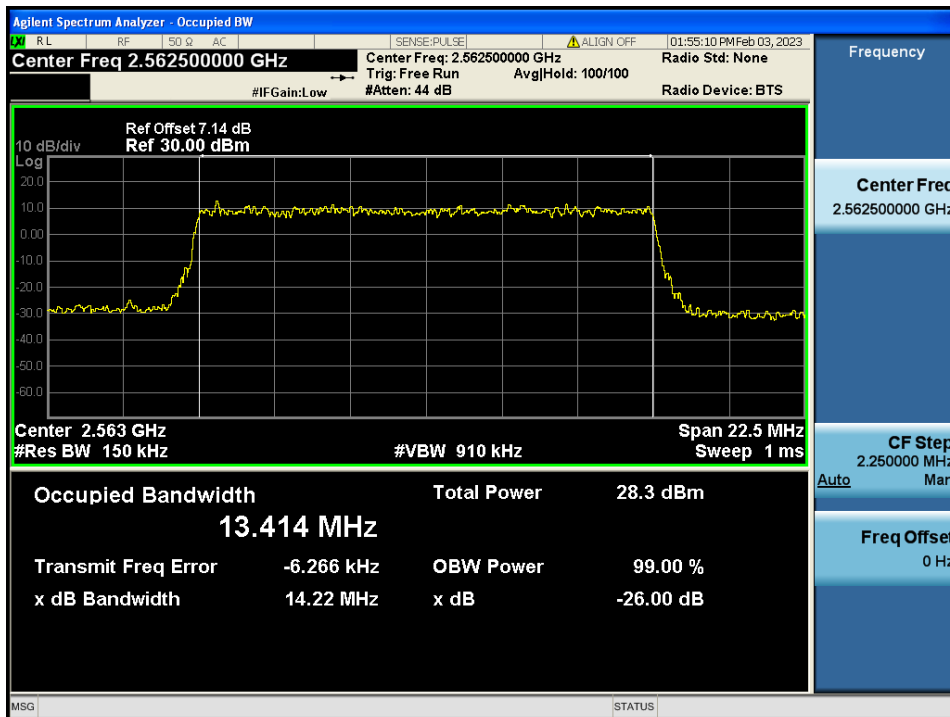

LTE Band 7 / 15 MHz / 16QAM - RB Size 75

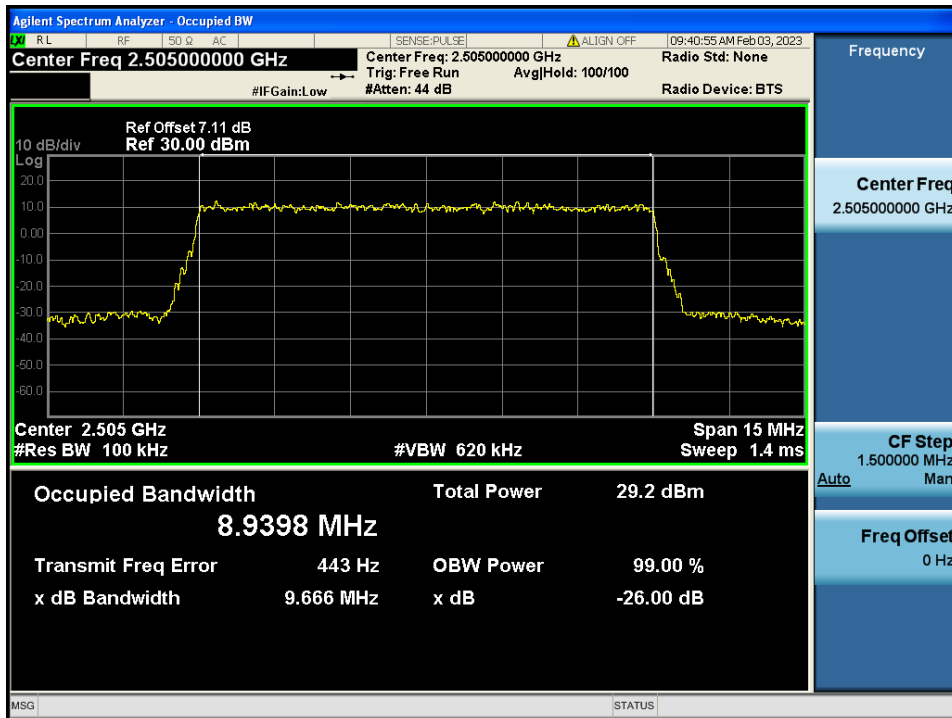

LTE Band 7 / 10 MHz / QPSK - RB Size 50

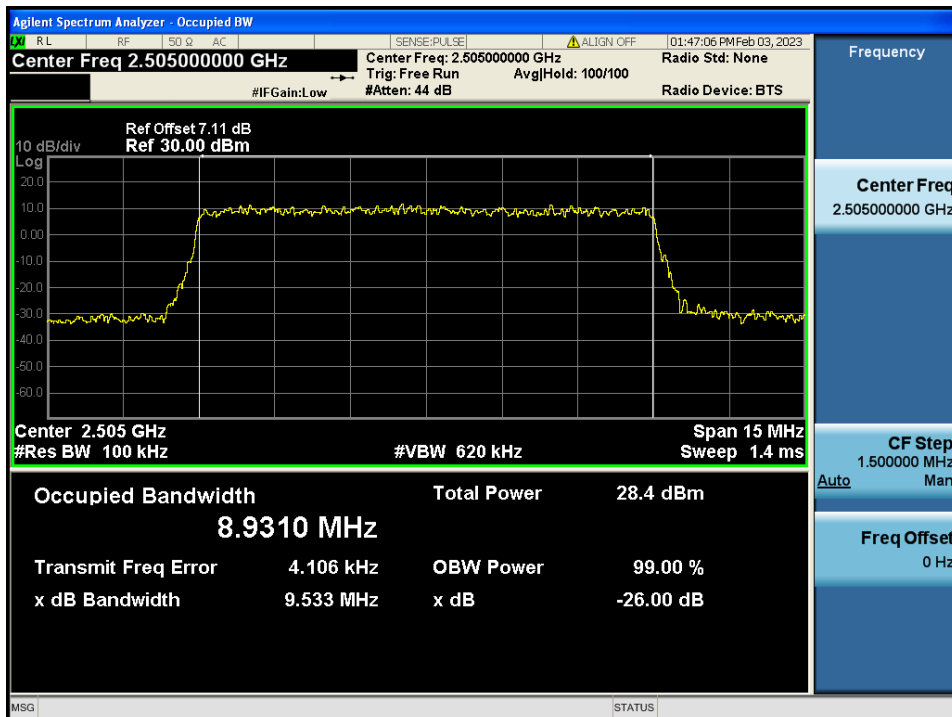

LTE Band 7 / 10 MHz / 16QAM - RB Size 50

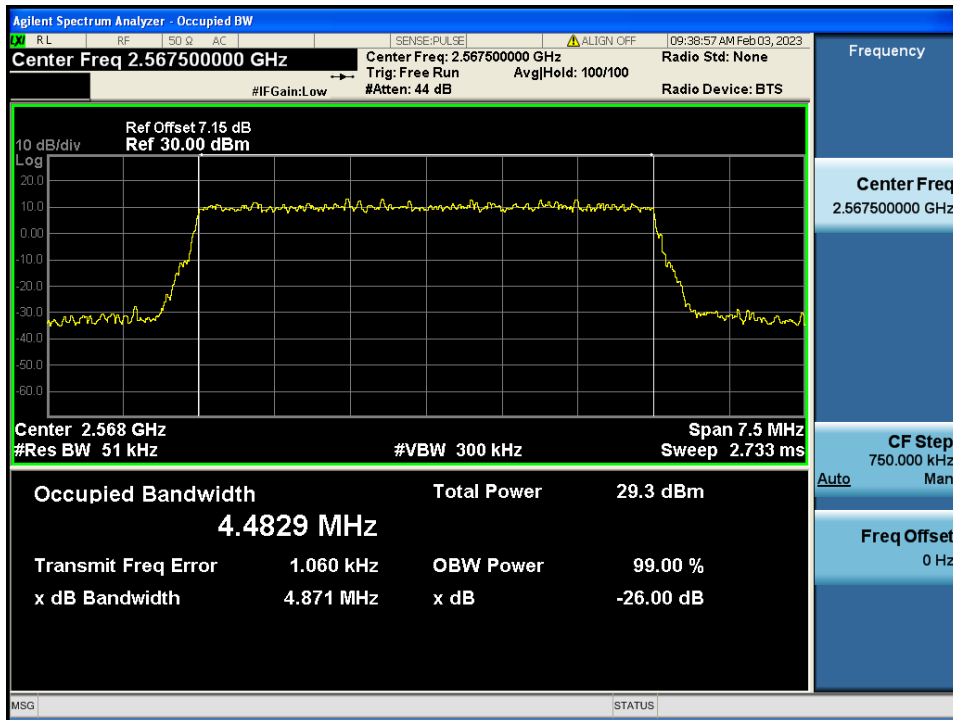

LTE Band 7 / 5 MHz / QPSK - RB Size 25

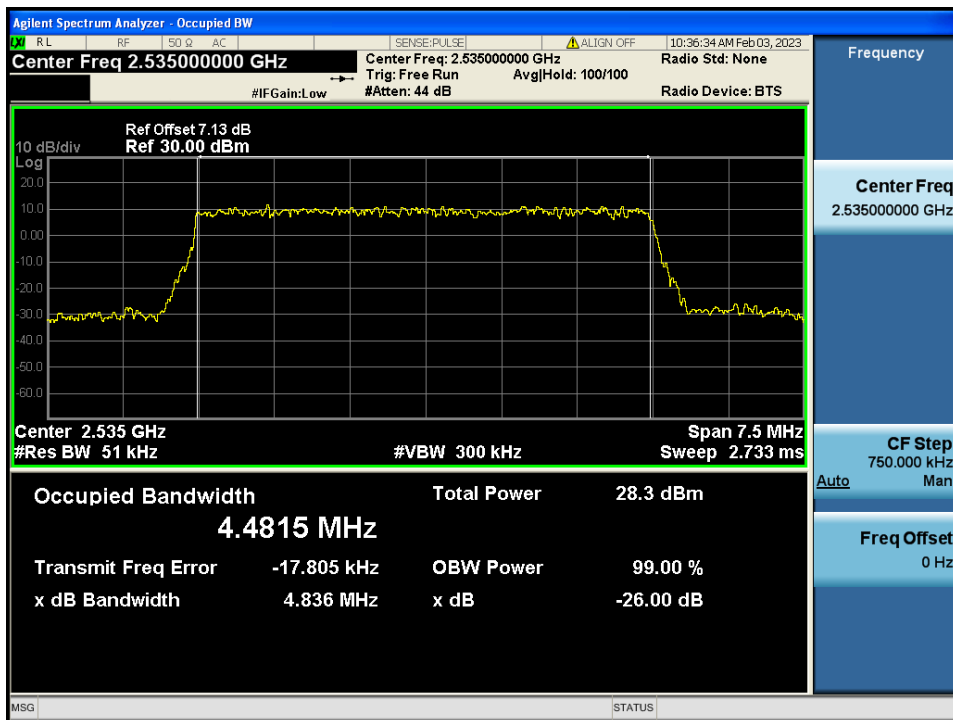

LTE Band 7 / 5 MHz / 16QAM - RB Size 25

8.2. PEAK TO AVERAGE RATIO

8.2.1. LTE Band 5

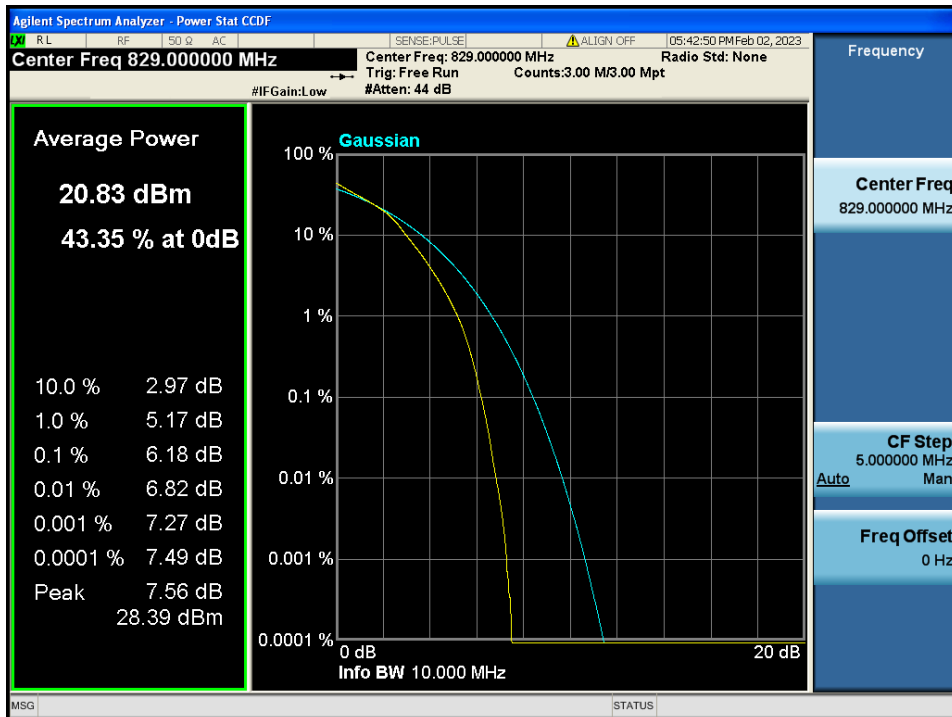
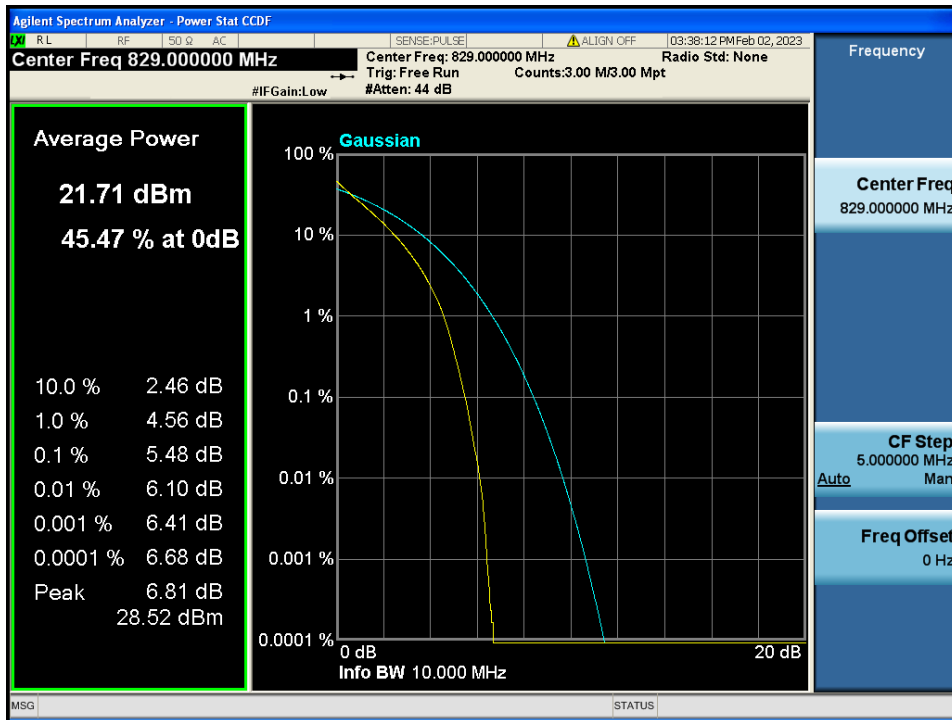

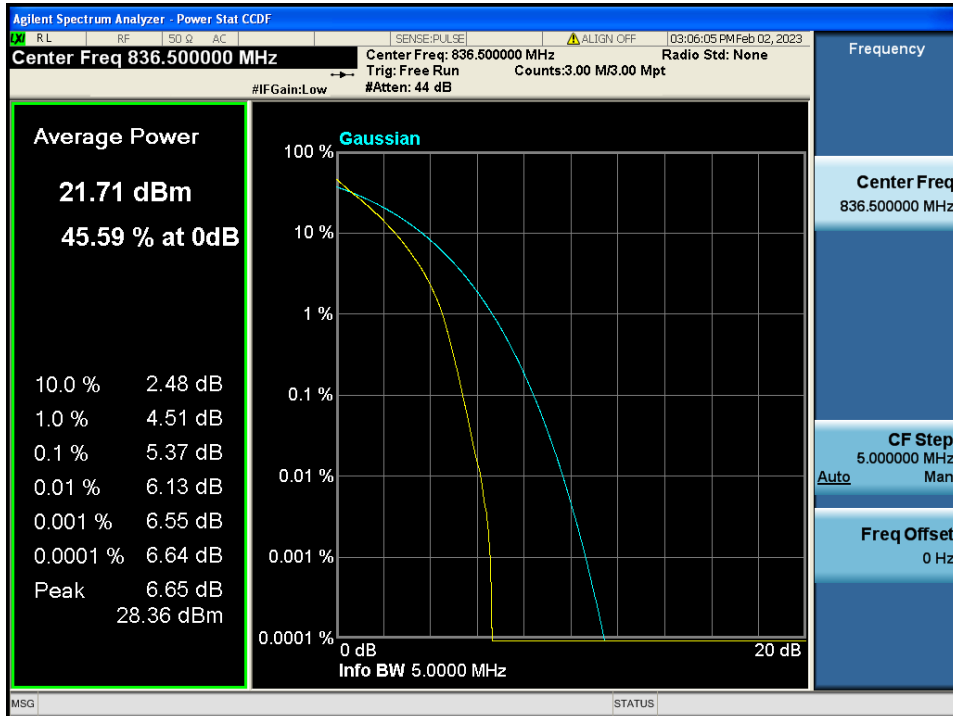

LTE Band 5 / 5 MHz / QPSK - RB Size 25

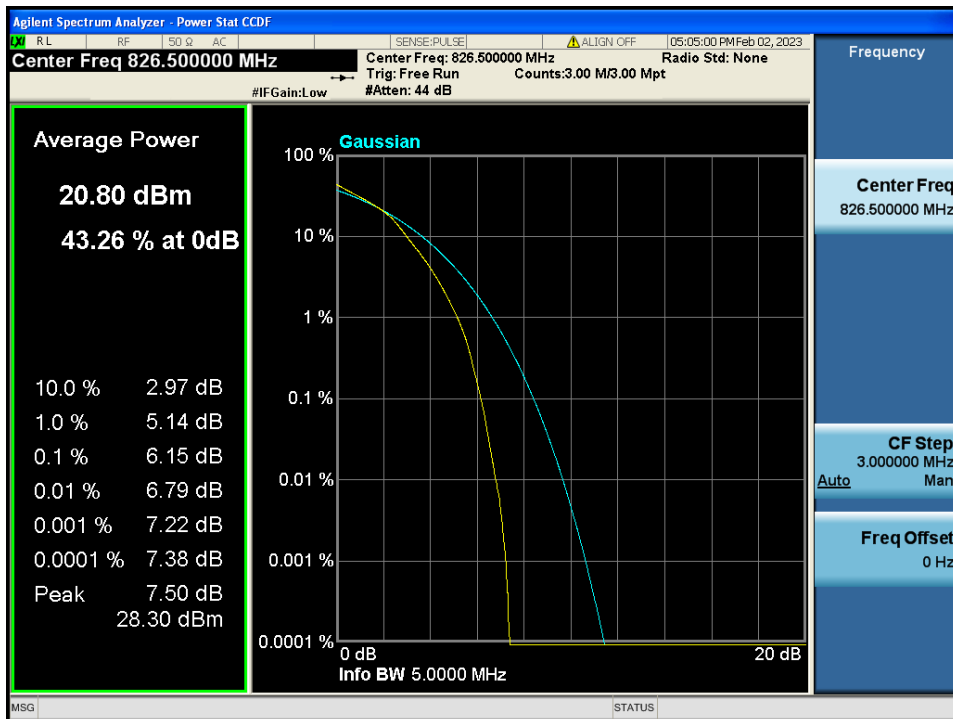

LTE Band 5 / 5 MHz / 16QAM - RB Size 25

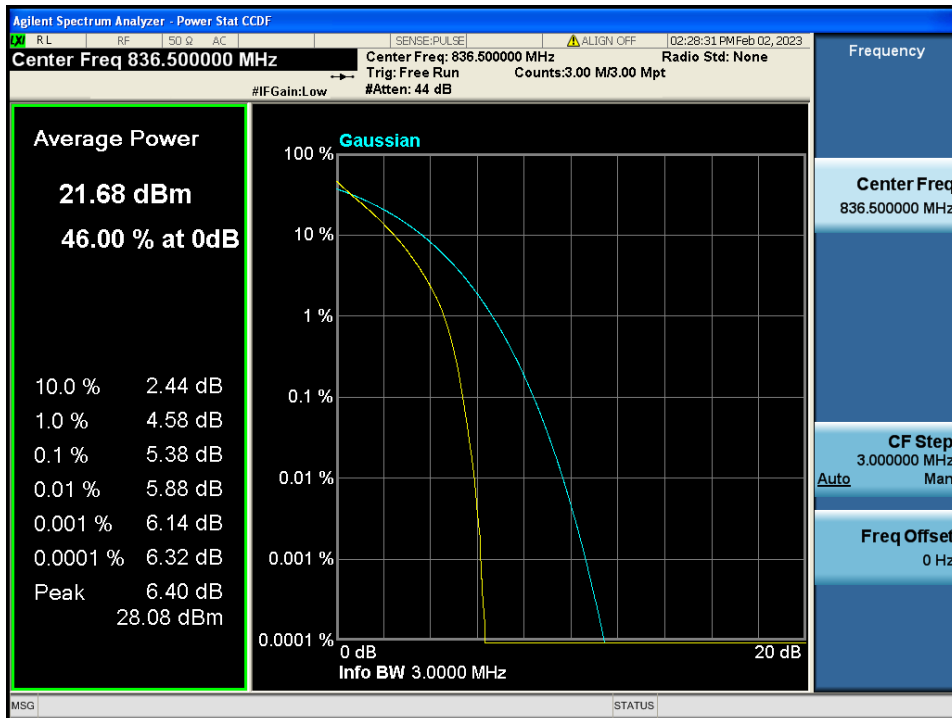

LTE Band 5 / 3 MHz / QPSK - RB Size 15

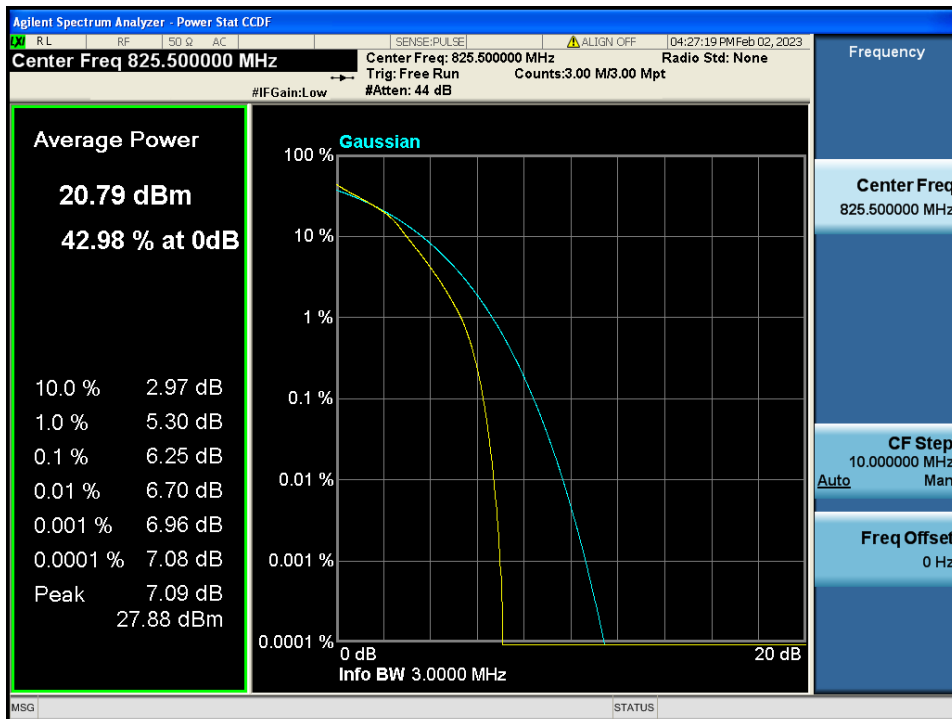

LTE Band 5 / 3 MHz / 16QAM - RB Size 15

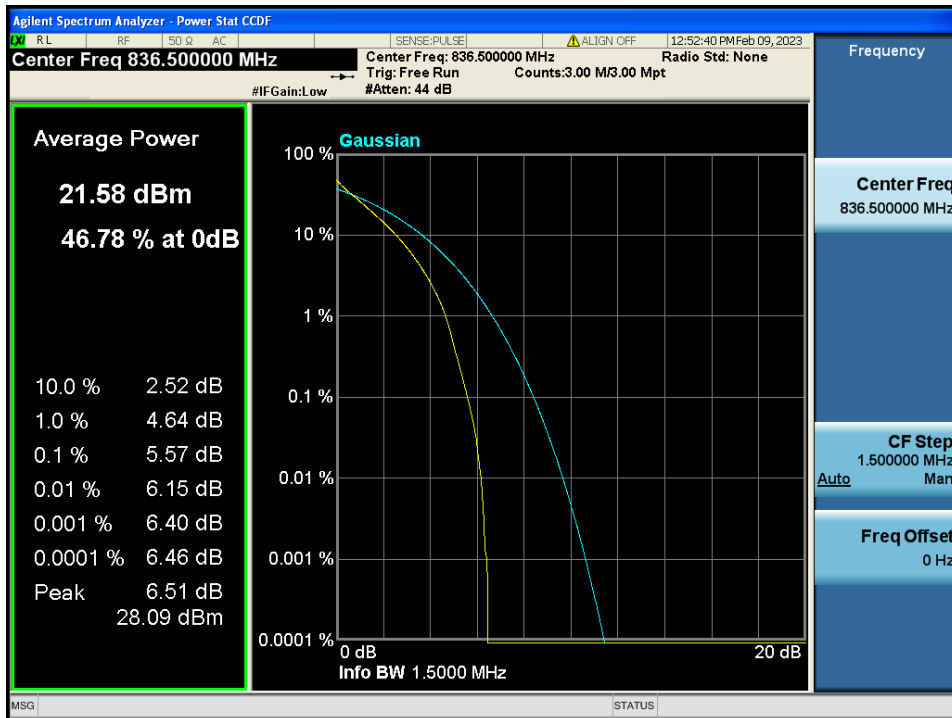

LTE Band 5 / 1.4 MHz / QPSK - RB Size 6

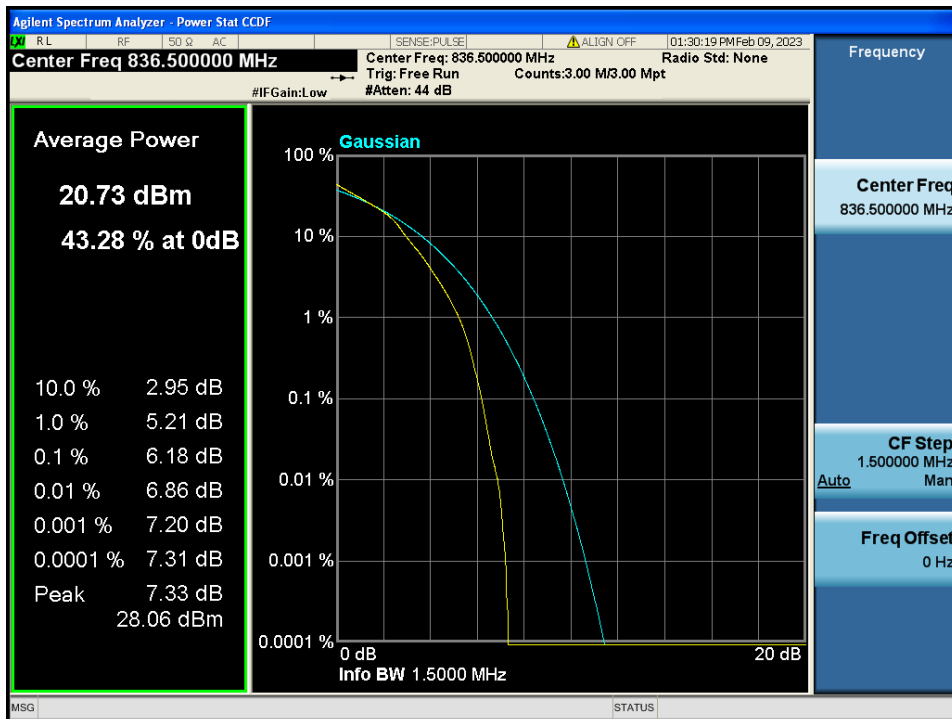

LTE Band 5 / 1.4 MHz / 16QAM - RB Size 6

8.2.2. LTE Band 7

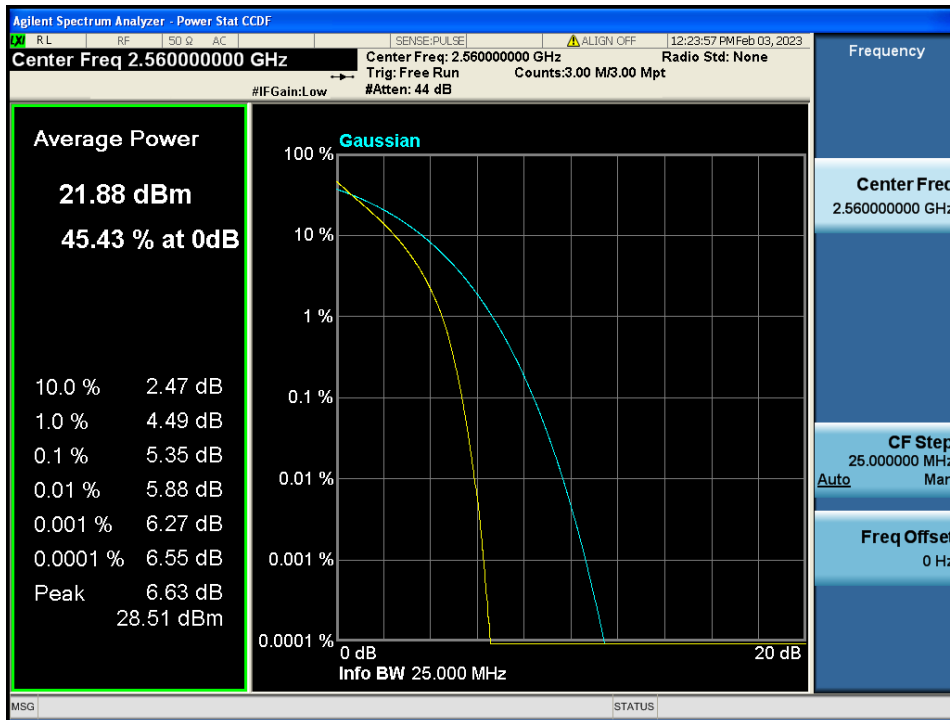

LTE Band 7 / 20 MHz / QPSK - RB Size 100

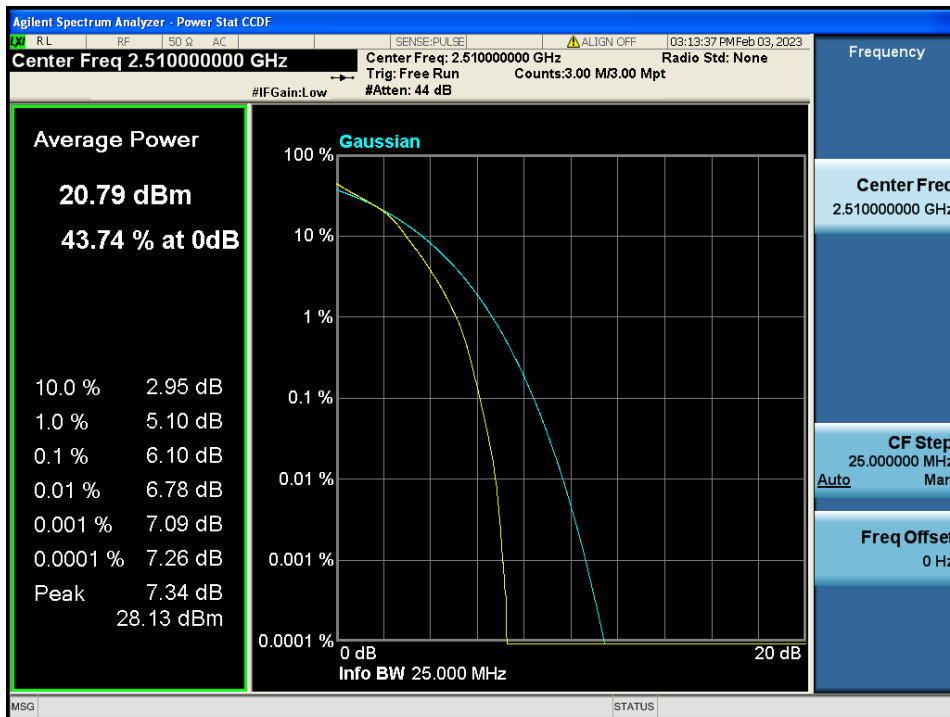

LTE Band 7 / 20 MHz / 16QAM - RB Size 100

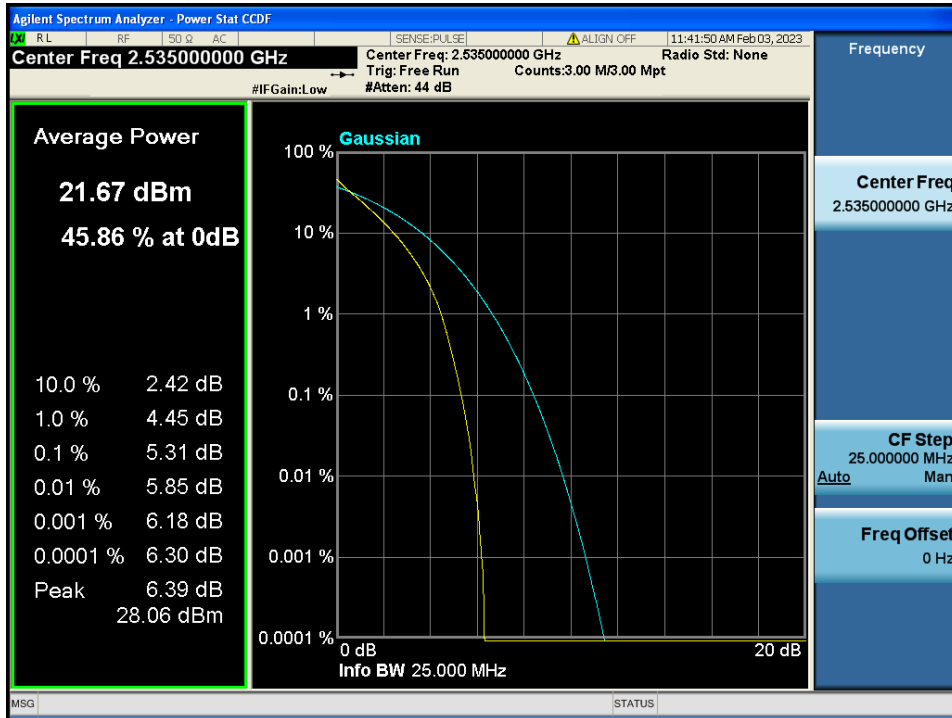

LTE Band 7 / 15 MHz / QPSK - RB Size 75

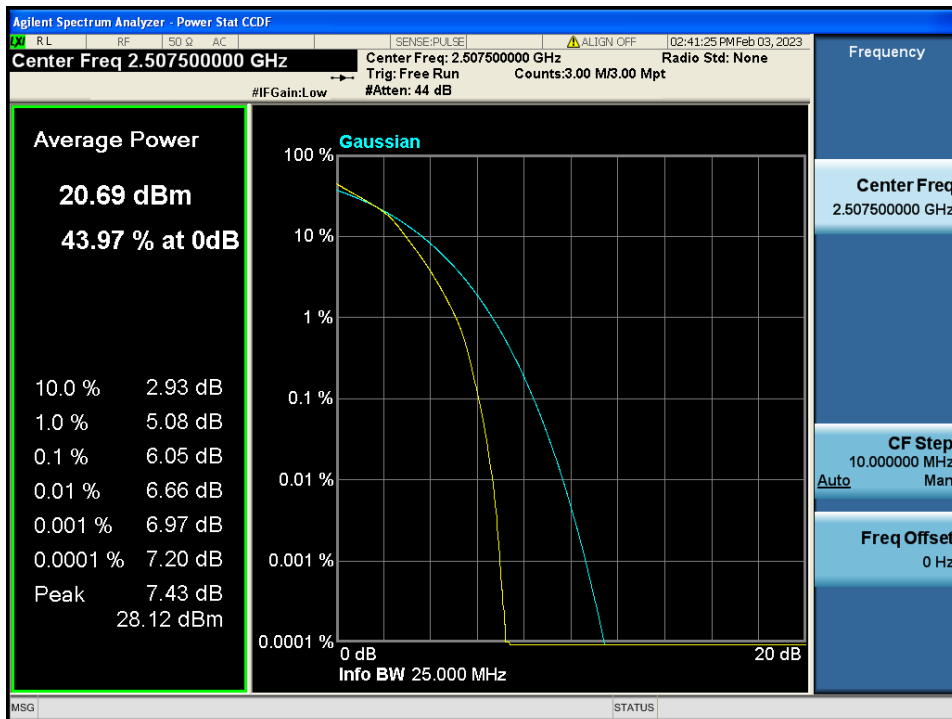

LTE Band 7 / 15 MHz / 16QAM - RB Size 75

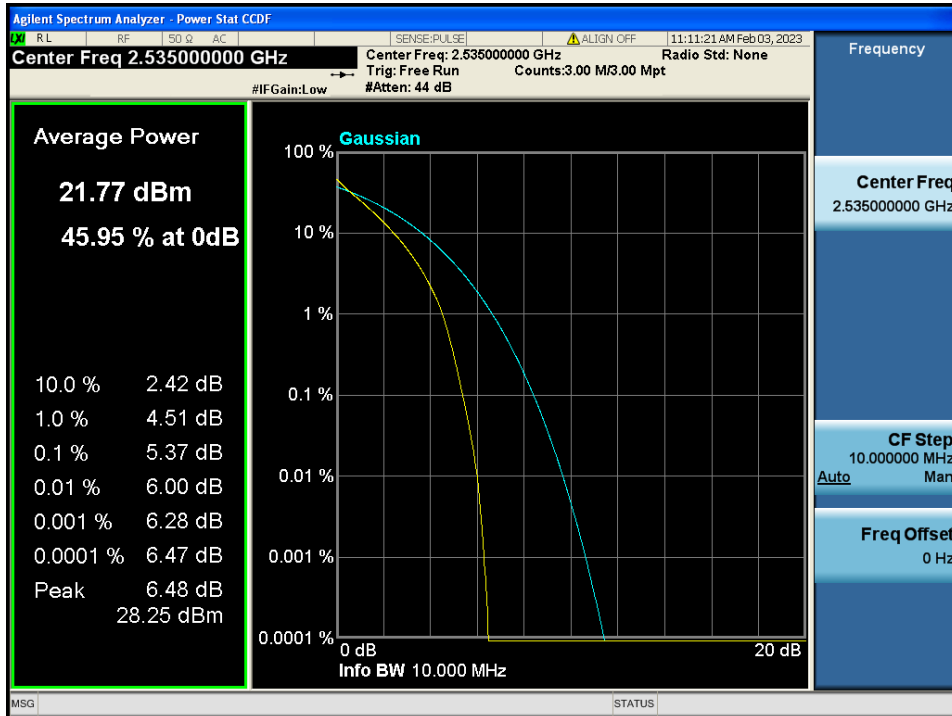

LTE Band 7 / 10 MHz / QPSK - RB Size 50



LTE Band 7 / 10 MHz / 16QAM - RB Size 50

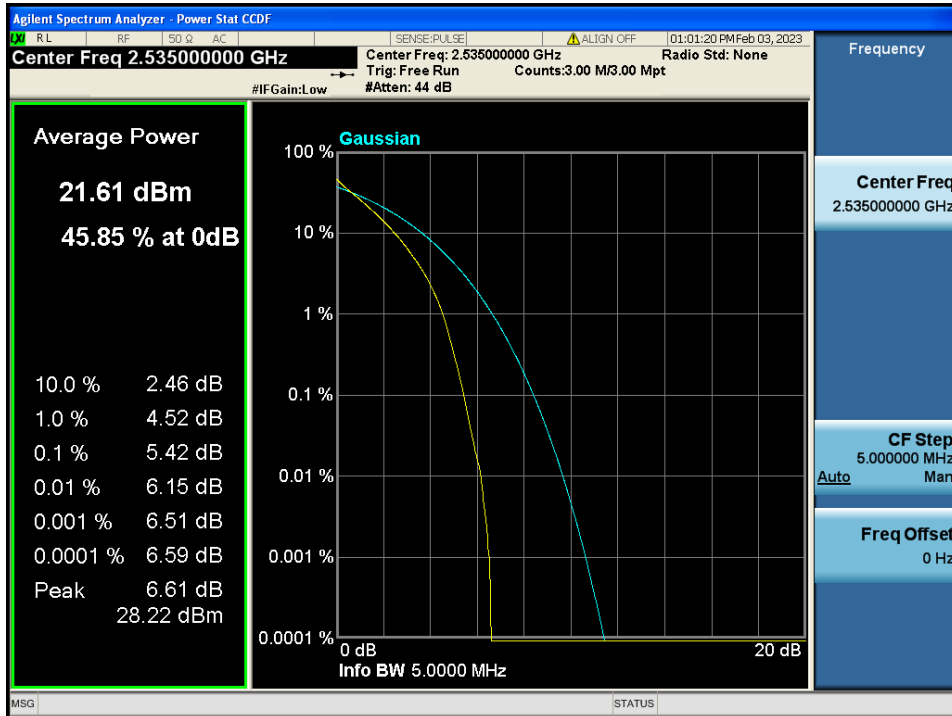

LTE Band 7 / 5 MHz / QPSK - RB Size 25

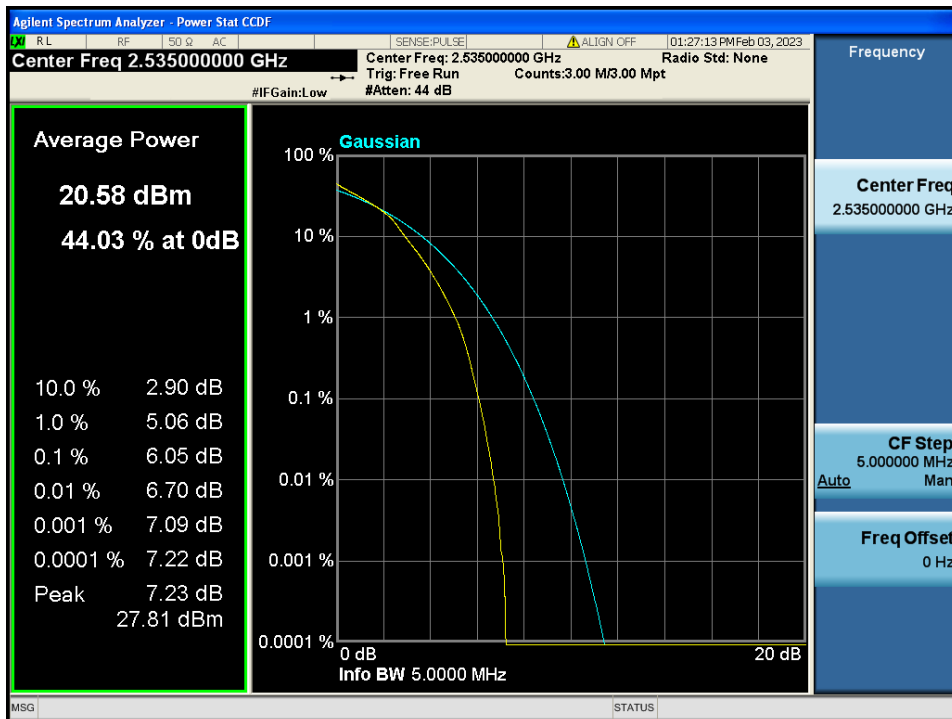

LTE Band 7 / 5 MHz / 16QAM - RB Size 25

8.3. BAND EDGE EMISSIONS(Conducted)

8.3.1. LTE Band 5

- Lower Band Edge

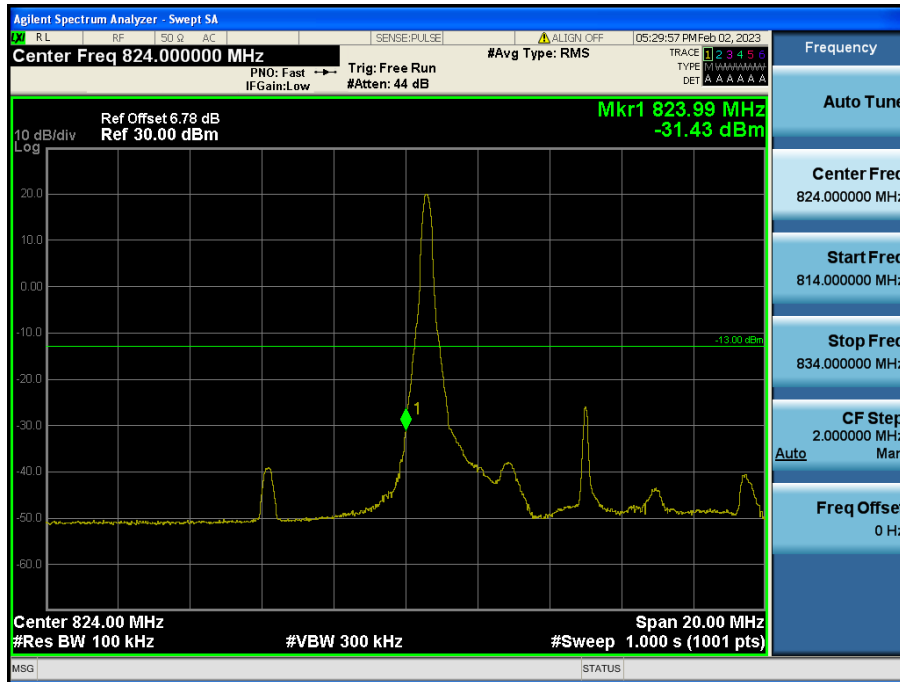

LTE Band 5 / 10 MHz / 16QAM - RB Size/Offset (1/0)

- Lower Extended Band Edge



LTE Band 5 / 10 MHz / 16QAM - RB Size/Offset (25/0)

- Upper Band Edge

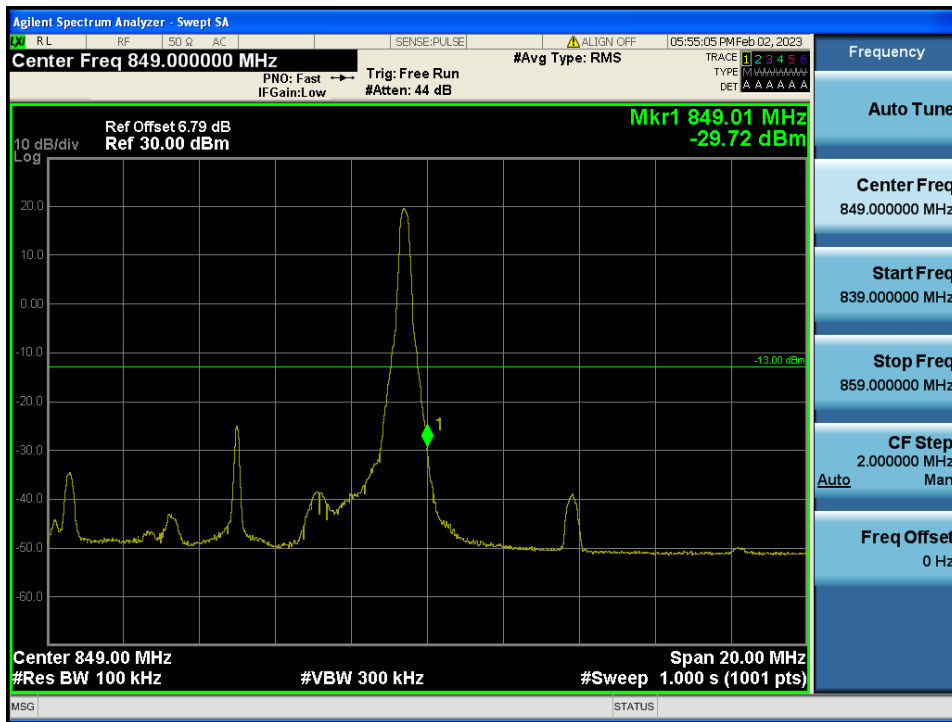

LTE Band 5 / 10 MHz / 16QAM - RB Size/Offset (1/49)

- Upper Extended Band Edge



LTE Band 5 / 10 MHz / QPSK - RB Size/Offset (25/25)

- Lower Band Edge

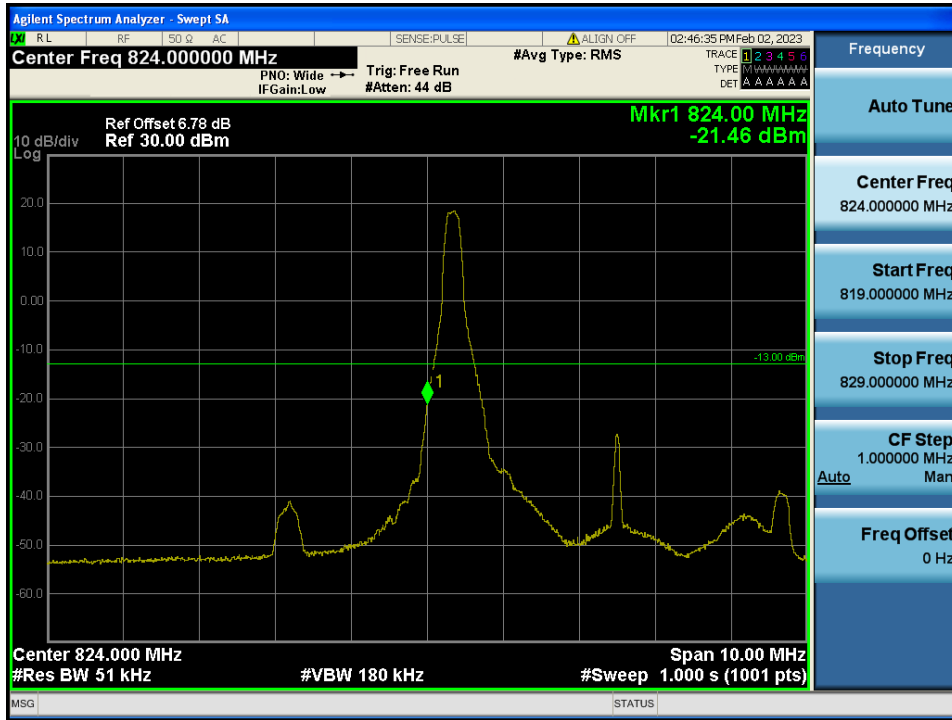

LTE Band 5 / 5 MHz / QPSK - RB Size/Offset (1/0)

- Lower Extended Band Edge



LTE Band 5 / 5 MHz / 16QAM - RB Size/Offset (12/0)

- Upper Band Edge

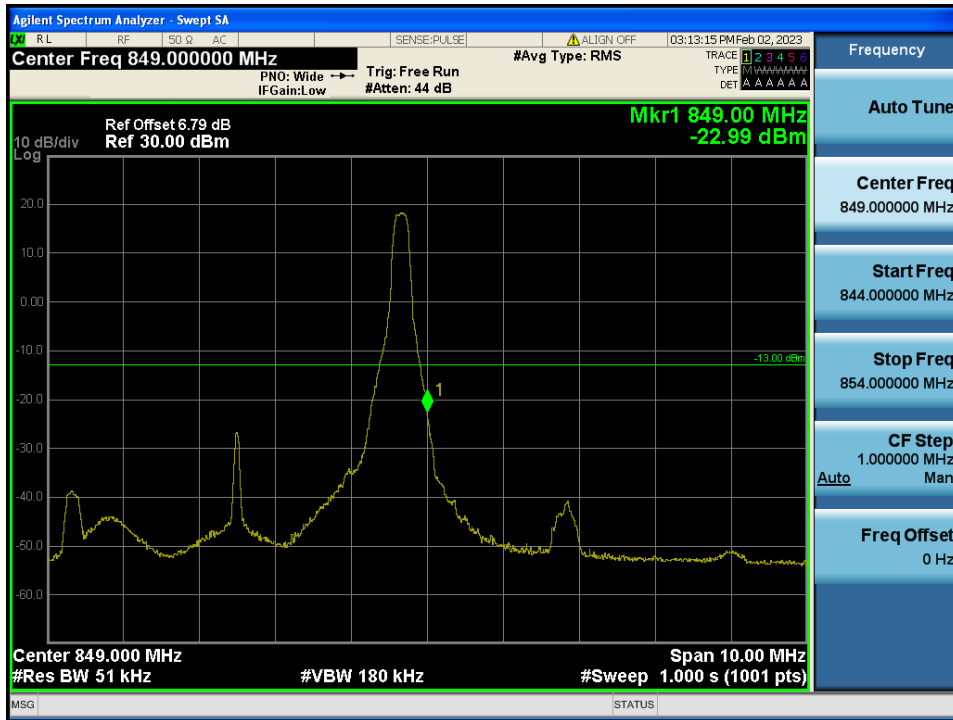

LTE Band 5 / 5 MHz / QPSK - RB Size/Offset (1/24)

- Upper Extended Band Edge



LTE Band 5 / 5 MHz / QPSK - RB Size/Offset (12/13)

- Lower Band Edge

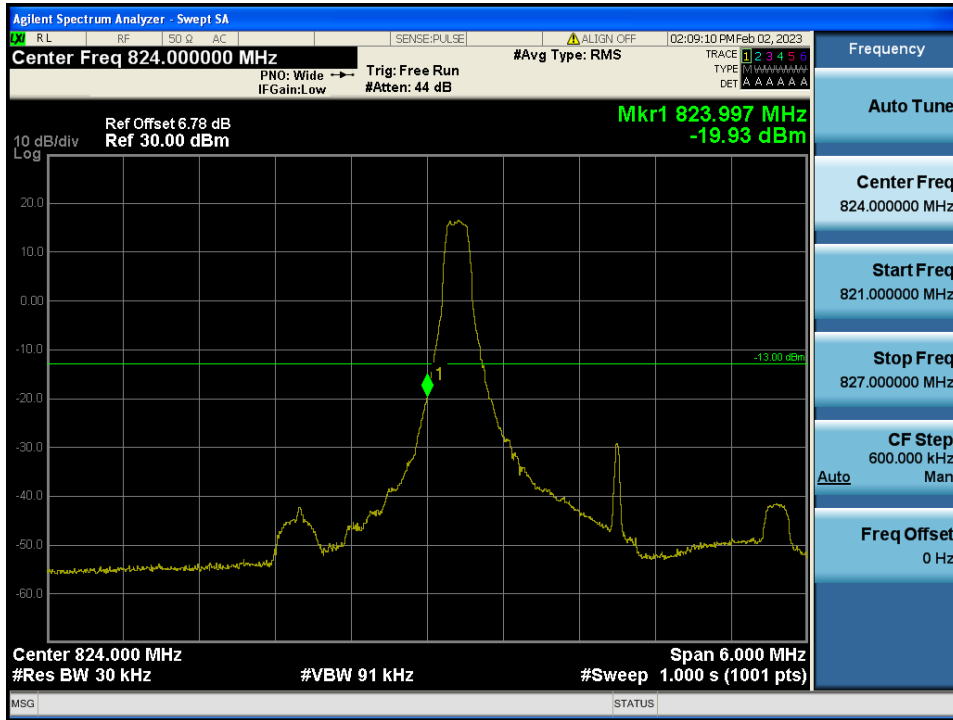

LTE Band 5 / 3 MHz / QPSK - RB Size/Offset (1/0)

- Lower Extended Band Edge



LTE Band 5 / 3 MHz / QPSK - RB Size/Offset (8/0)

- Upper Band Edge

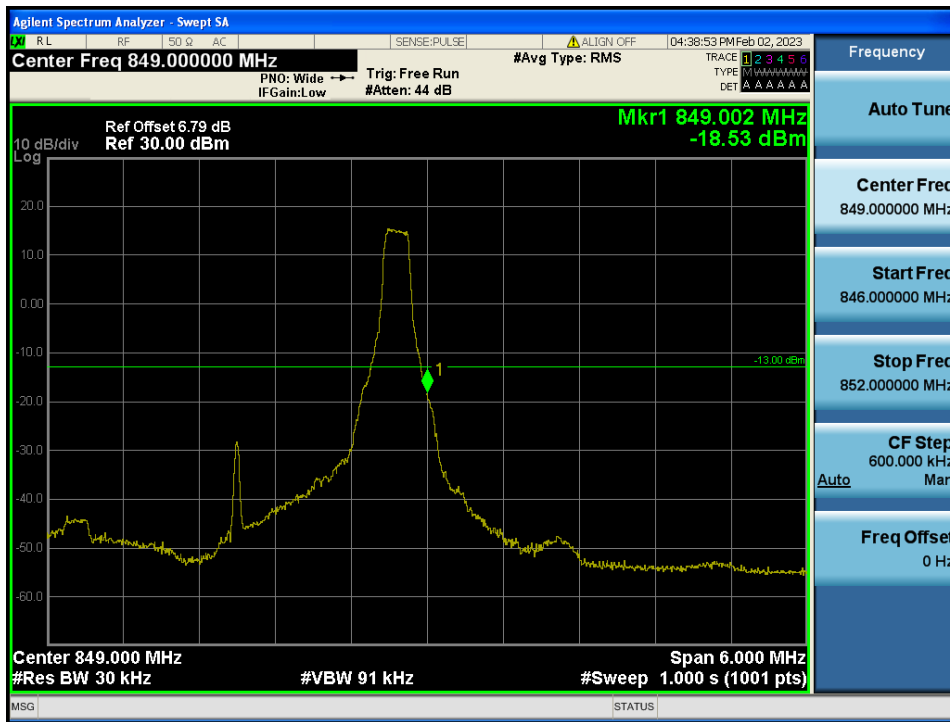

LTE Band 5 / 3 MHz / 16QAM - RB Size/Offset (1/14)

- Upper Extended Band Edge



LTE Band 5 / 3 MHz / QPSK - RB Size/Offset (8/7)

- Lower Band Edge

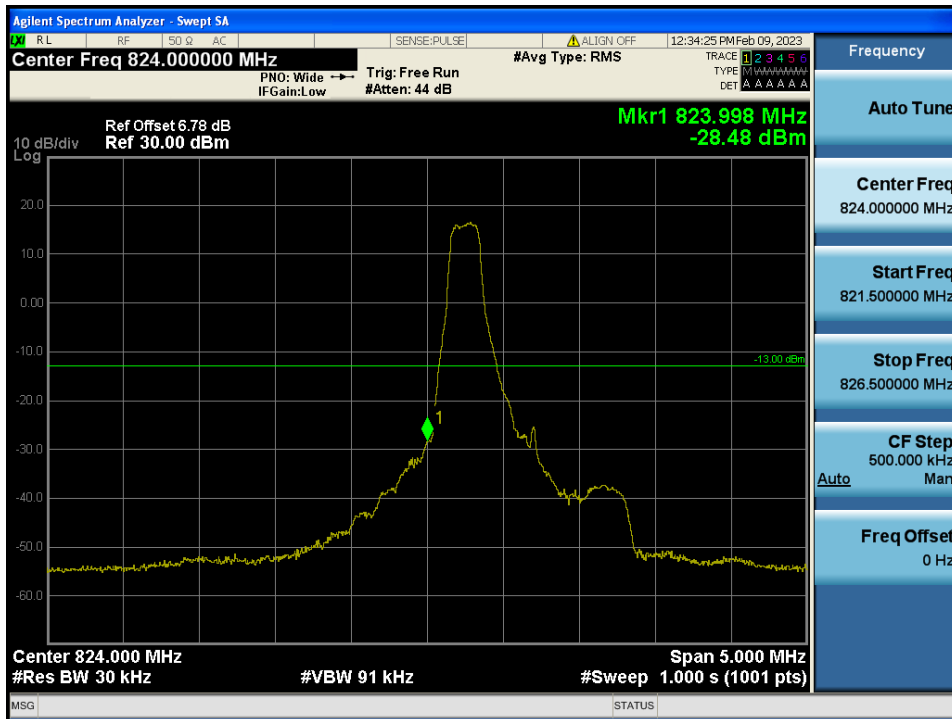

LTE Band 5 / 1.4 MHz / QPSK - RB Size/Offset (1/0)

- Lower Extended Band Edge



LTE Band 5 / 1.4 MHz / QPSK - RB Size/Offset (6/0)

- Upper Band Edge



LTE Band 26(5) / 1.4 MHz / QPSK - RB Size/Offset (3/3)

- Upper Extended Band Edge



LTE Band 26(5) / 1.4 MHz / 16QAM - RB Size/Offset (6/0)

8.3.2. LTE Band 7

- Band Edge (Low CH)

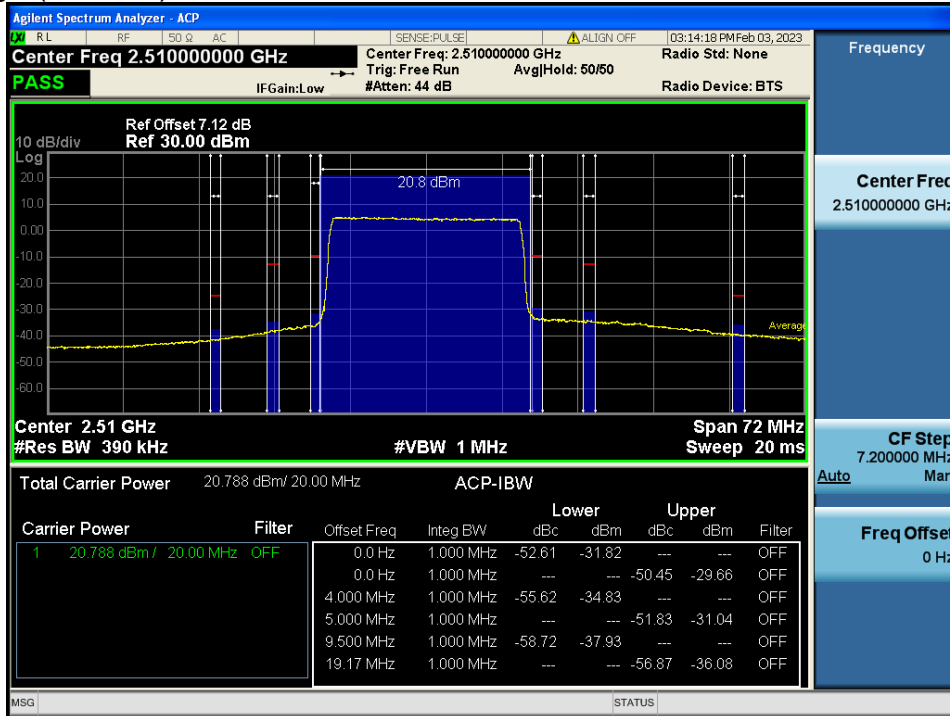

LTE Band 7 / 20 MHz / 16QAM - RB Size/Offset (100/0)

- Band Edge (MID CH)

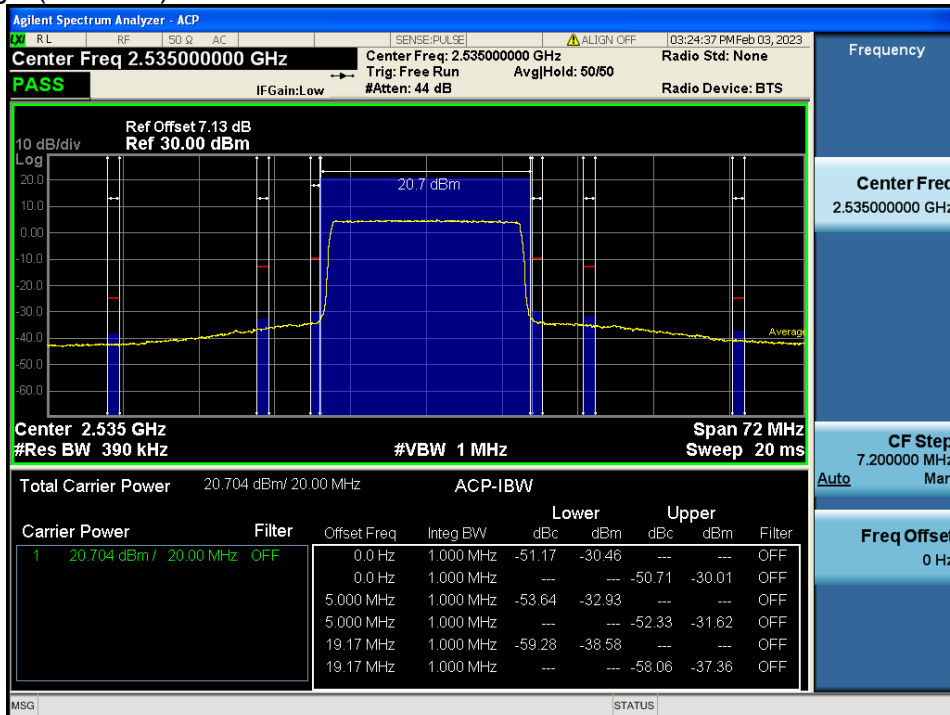

LTE Band 7 / 20 MHz / 16QAM - RB Size/Offset (100/0)

- Band Edge (High CH)

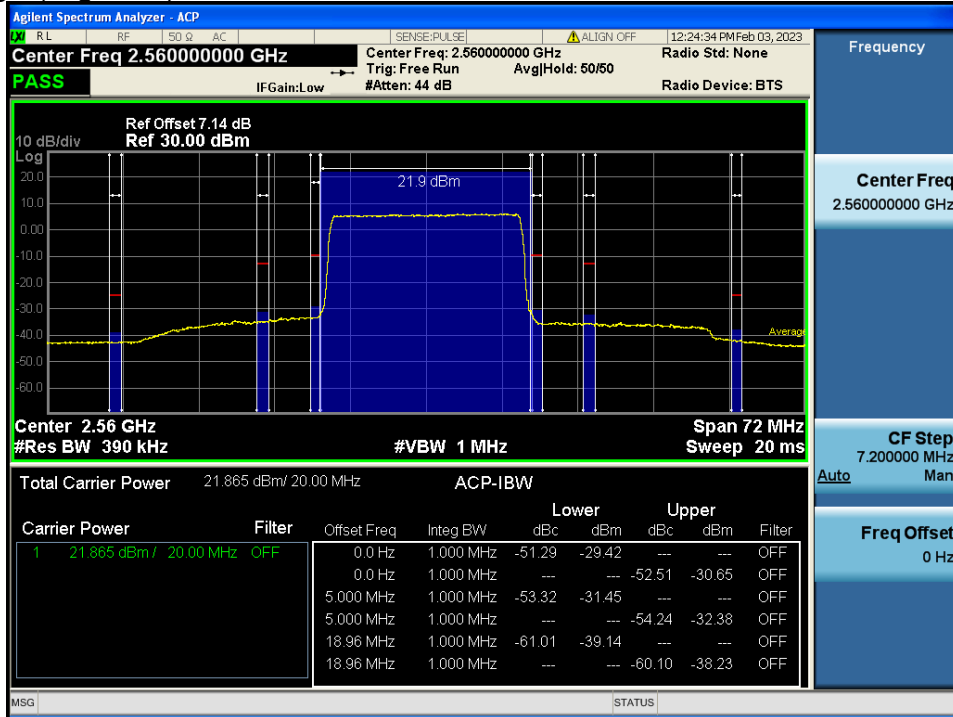

LTE Band 7 / 20 MHz / QPSK - RB Size/Offset (100/0)

- Band Edge (Low CH)



LTE Band 7 / 15 MHz / 16QAM - RB Size/Offset (75/0)

- Band Edge (MID CH)

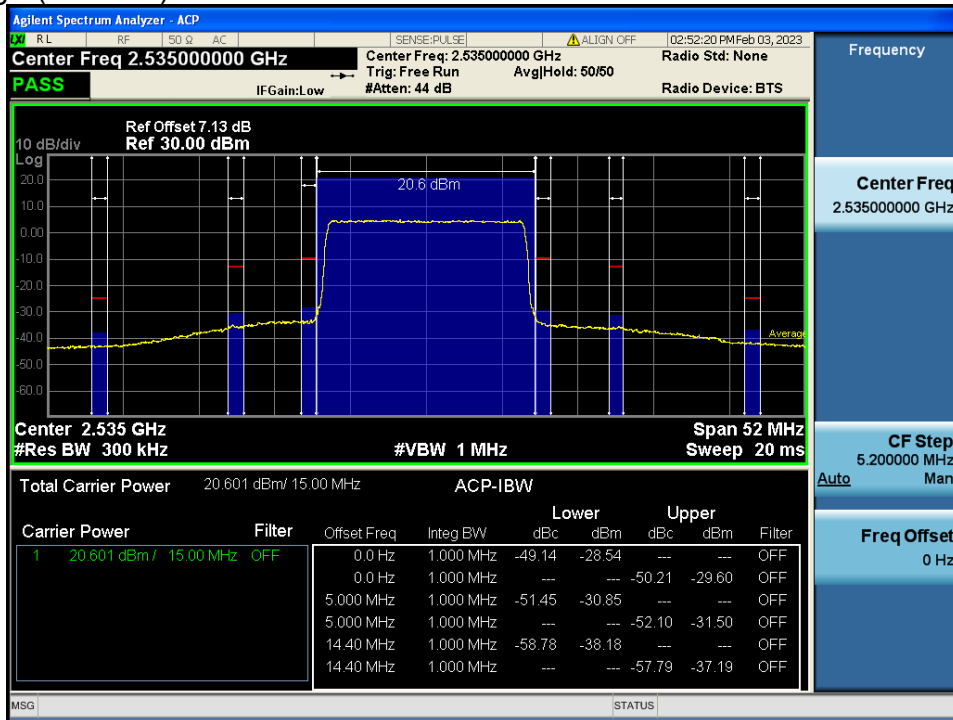

LTE Band 7 / 15 MHz / 16QAM - RB Size/Offset (75/0)

- Band Edge (High CH)

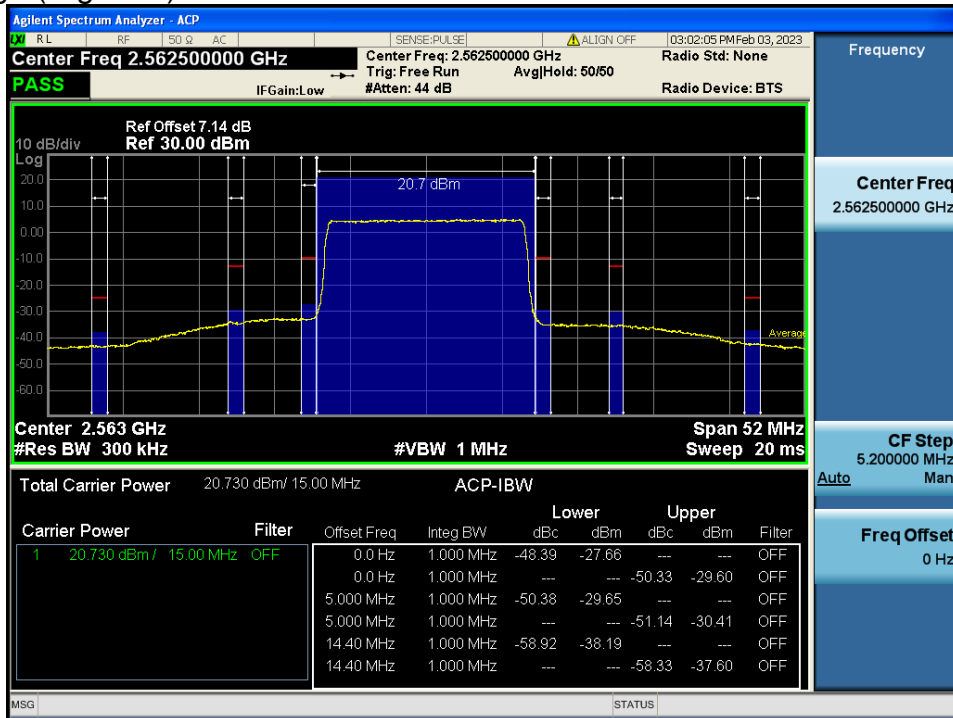

LTE Band 7 / 15 MHz / 16QAM - RB Size/Offset (75/0)

- Band Edge (Low CH)

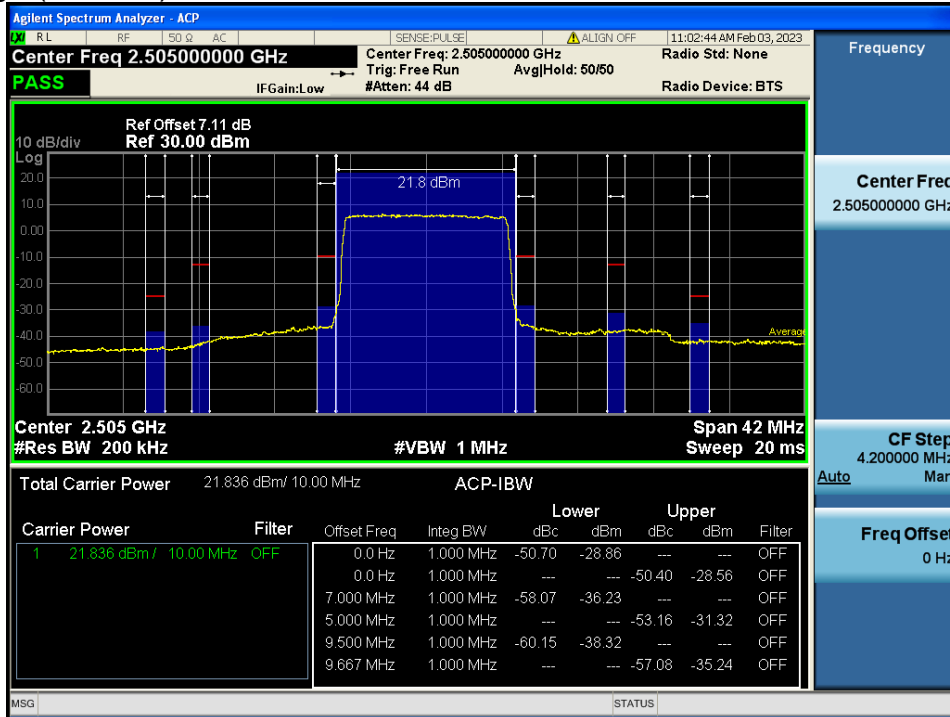

LTE Band 7 / 10 MHz / QPSK - RB Size/Offset (50/0)

- Band Edge (MID CH)

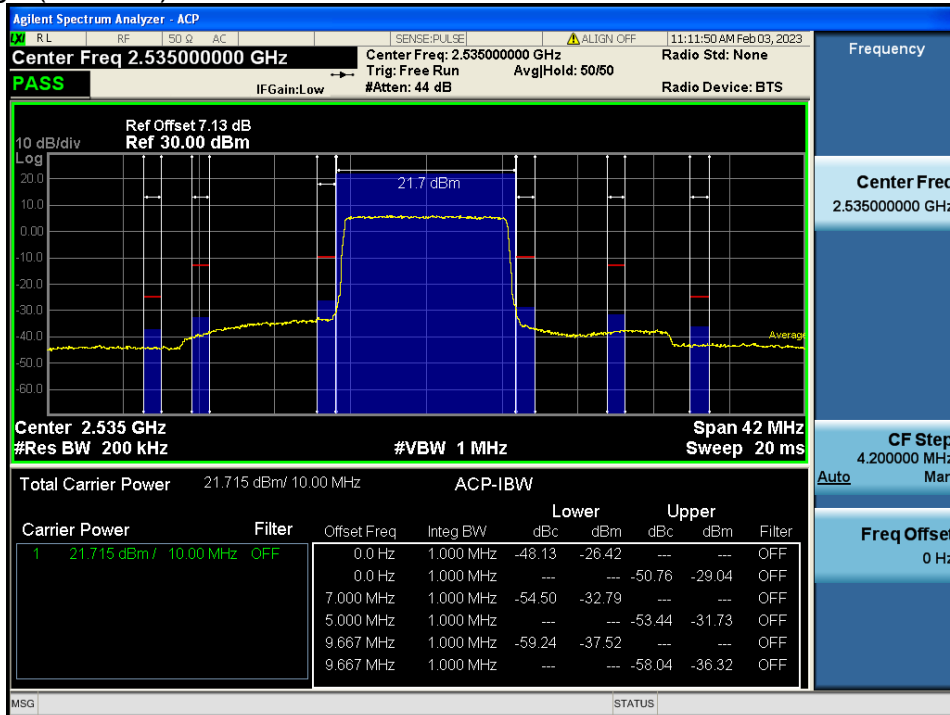

LTE Band 7 / 10 MHz / QPSK - RB Size/Offset (50/0)

- Band Edge (High CH)

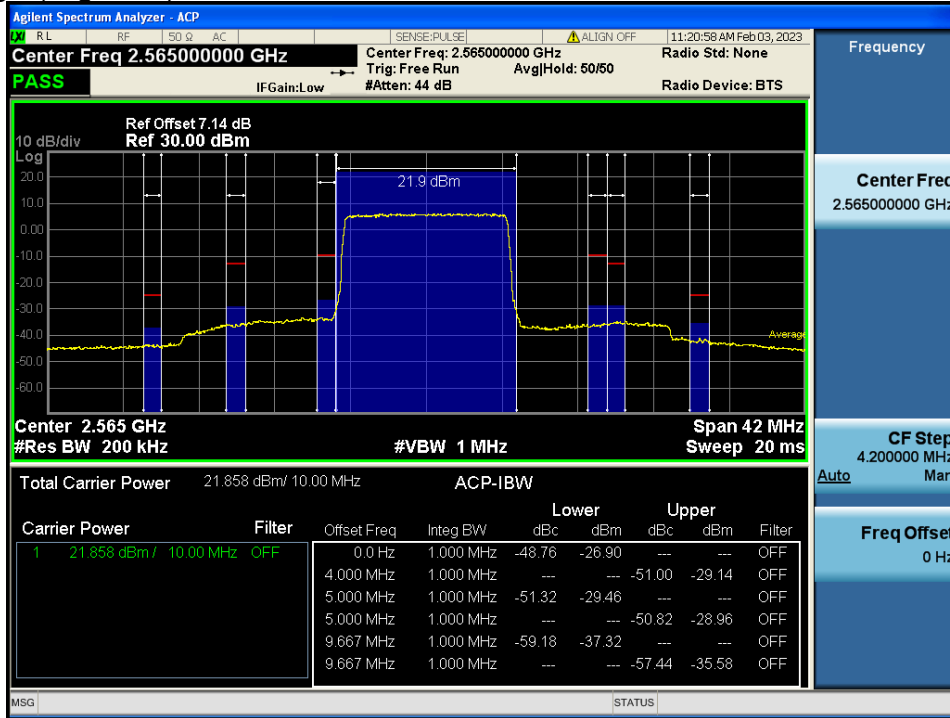

LTE Band 7 / 10 MHz / QPSK - RB Size/Offset (50/0)

- Band Edge (Low CH)



LTE Band 7 / 5 MHz / QPSK - RB Size/Offset (25/0)

- Band Edge (MID CH)

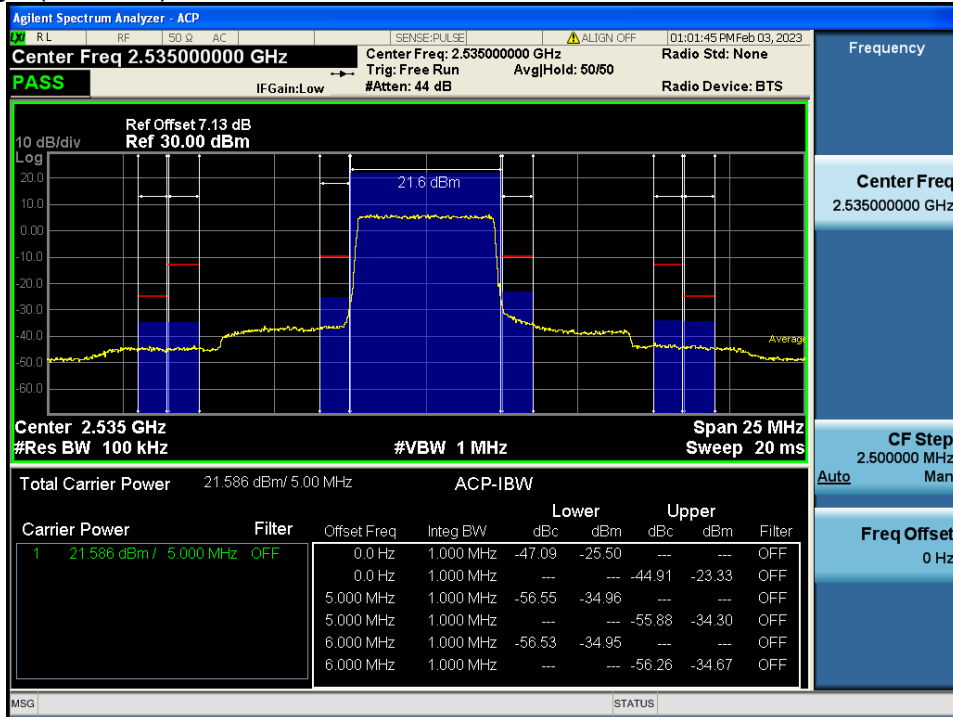

LTE Band 7 / 5 MHz / QPSK - RB Size/Offset (25/0)

- Band Edge (High CH)

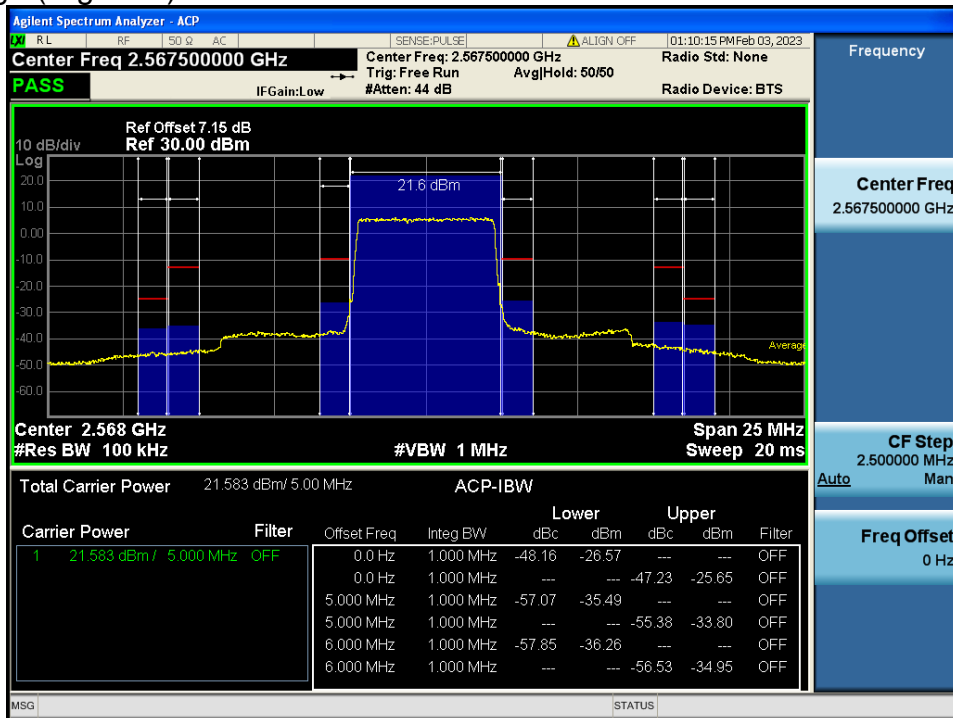

LTE Band 7 / 5 MHz / QPSK - RB Size/Offset (25/0)

8.4. SPURIOUS AND HARMONICS EMISSIONS(Conducted)

8.4.1. LTE Band 5

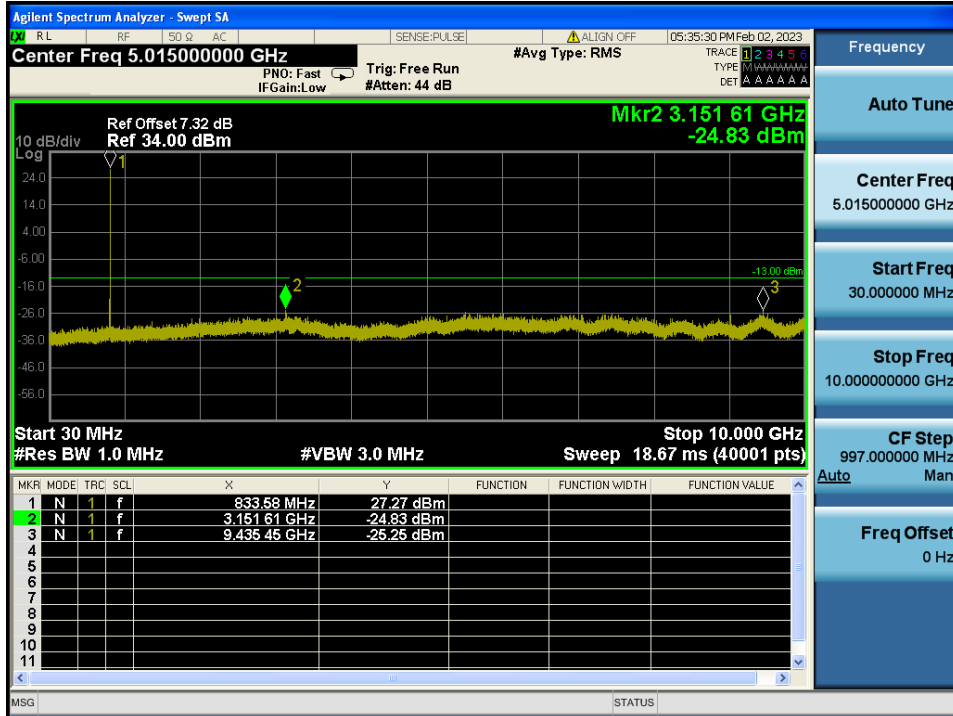

LTE Band 5 / 10 MHz / 16QAM - RB Size/Offset (1/49) – Low Channel

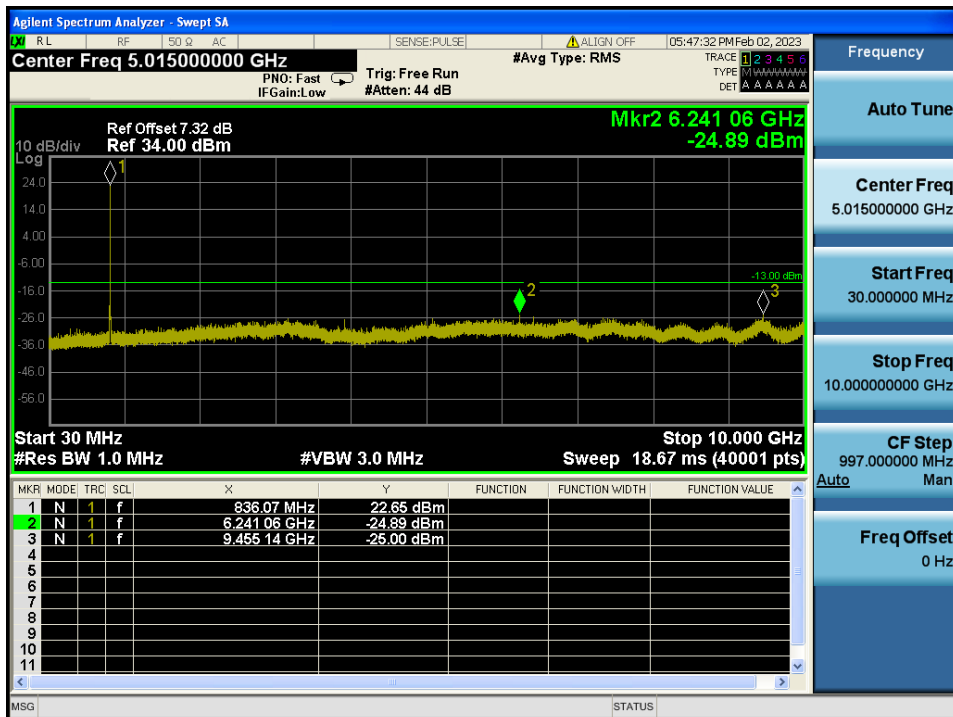

LTE Band 5 / 10 MHz / 16QAM - RB Size/Offset (25/0) – Mid Channel

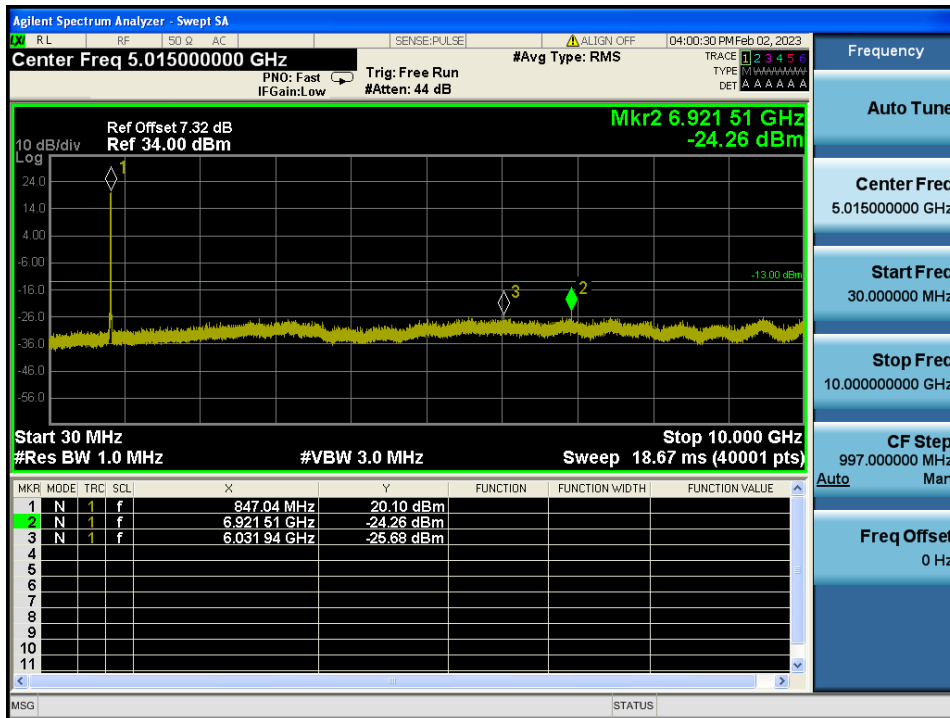

LTE Band 5 / 10 MHz / QPSK - RB Size/Offset (50/0) – High Channel

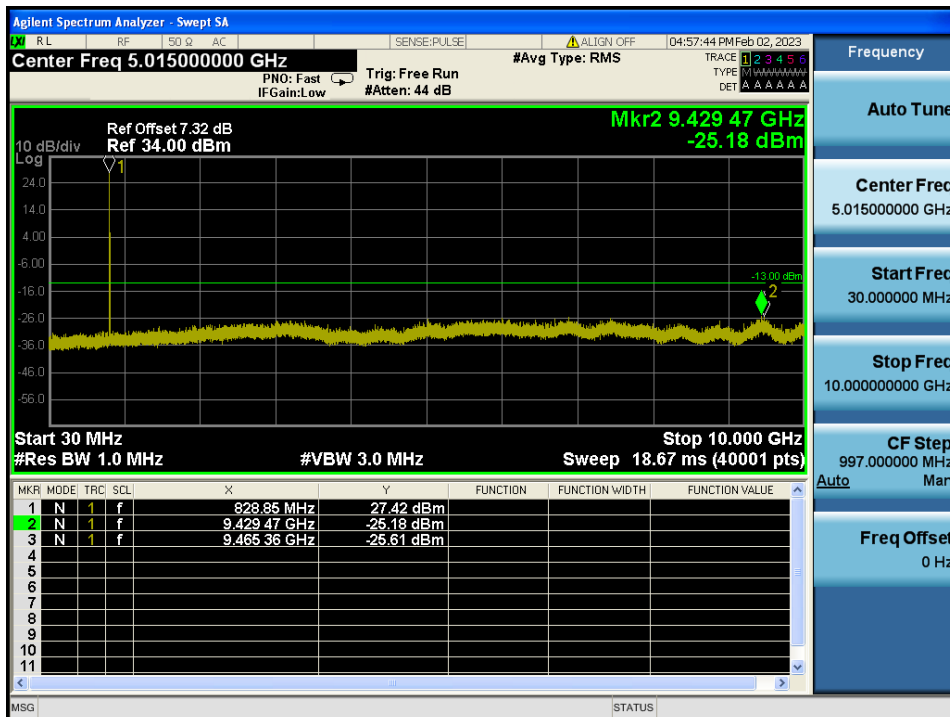

LTE Band 5 / 5 MHz / 16QAM - RB Size/Offset (1/24) – Low Channel

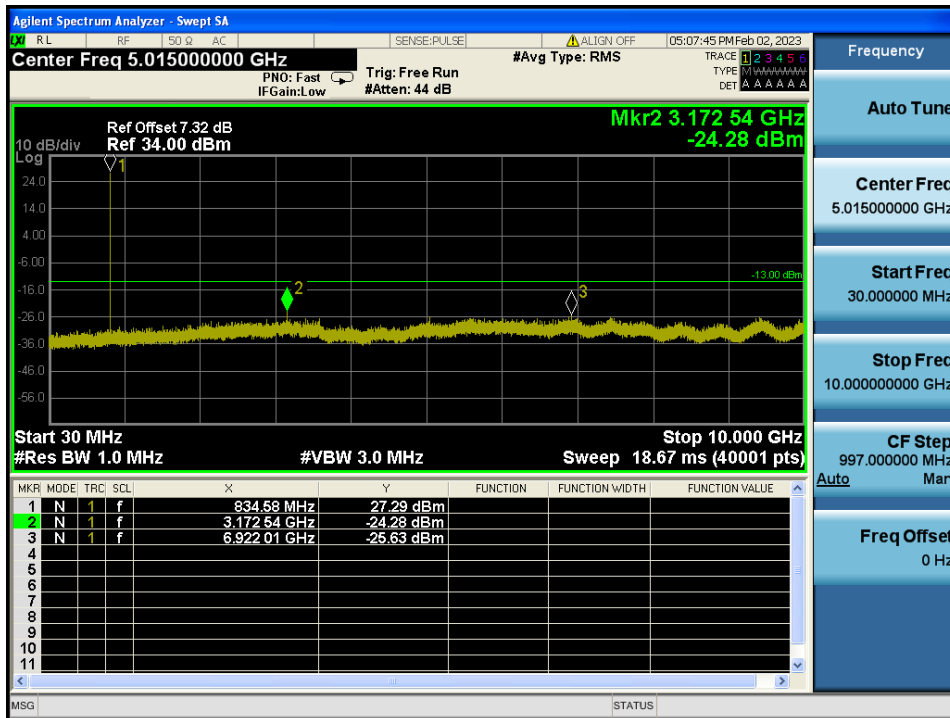

LTE Band 5 / 5 MHz / 16QAM - RB Size/Offset (1/0) – Mid Channel

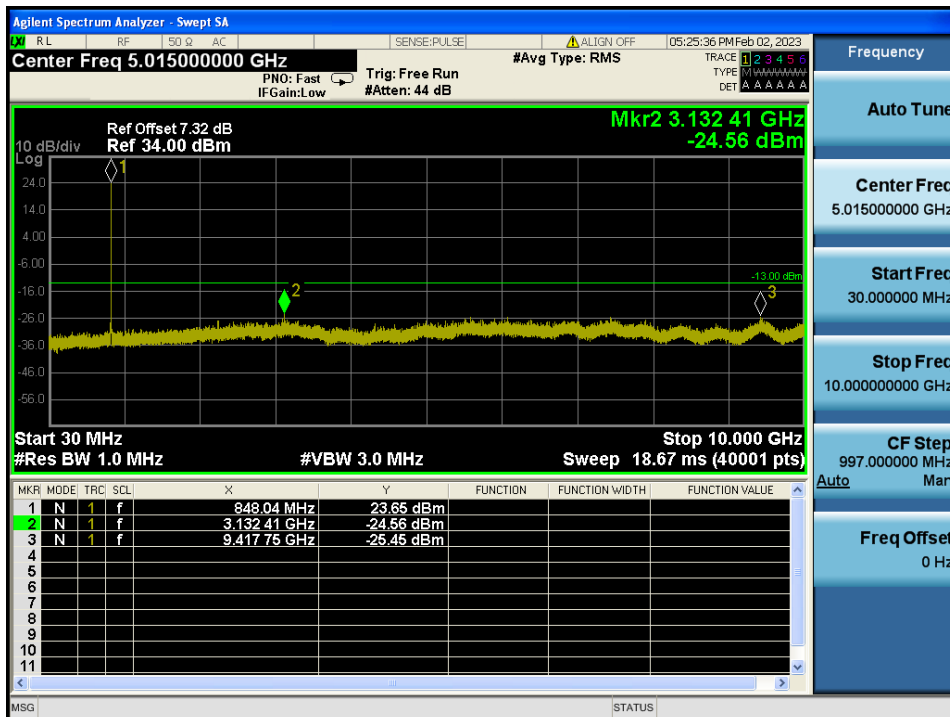

LTE Band 5 / 5 MHz / 16QAM - RB Size/Offset (12/13) – High Channel

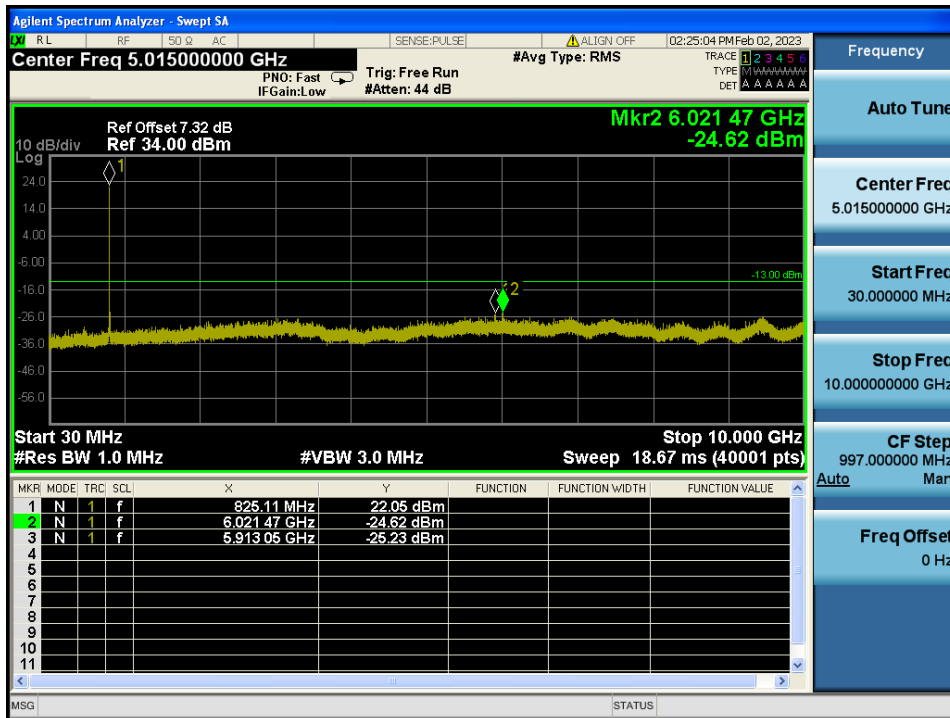

LTE Band 5 / 3 MHz / QPSK - RB Size/Offset (15/0) – Low Channel

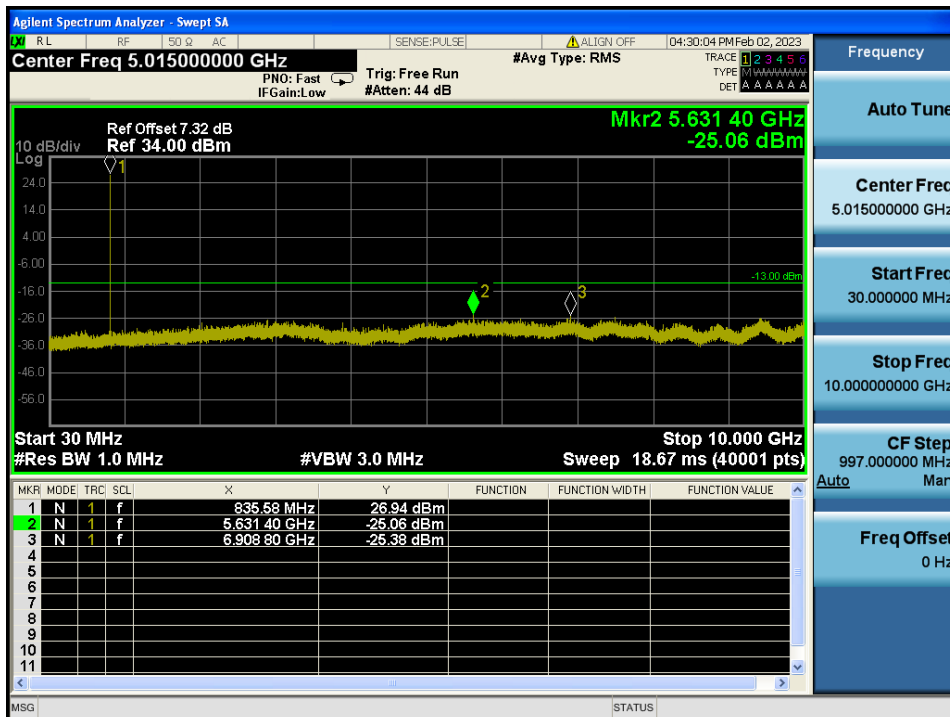

LTE Band 5 / 3 MHz / 16QAM - RB Size/Offset (1/0) – Mid Channel

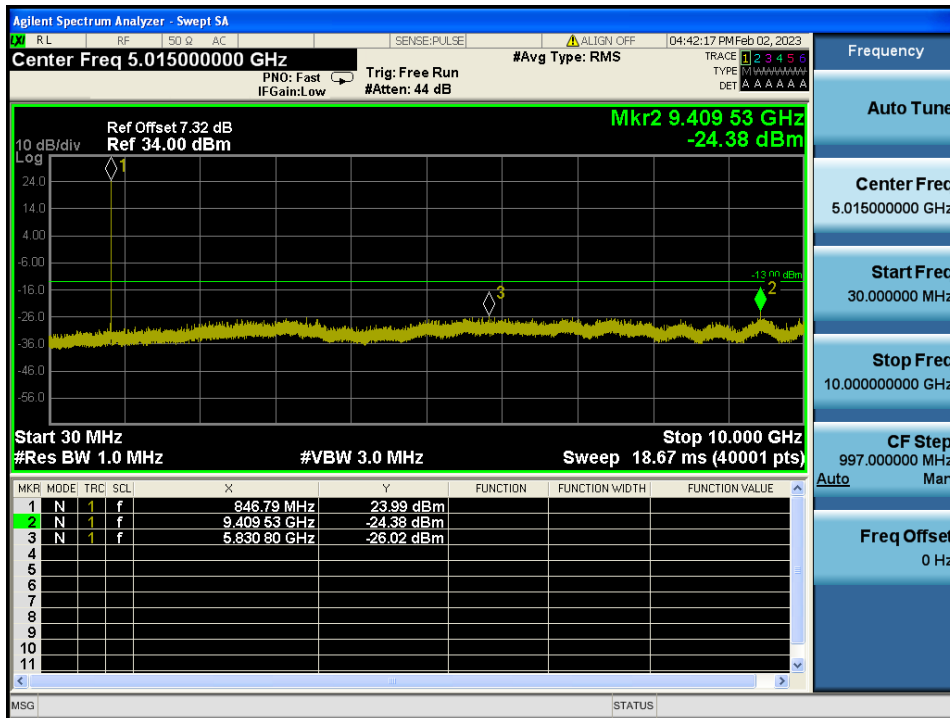

LTE Band 5 / 3 MHz / 16QAM - RB Size/Offset (8/0) – High Channel

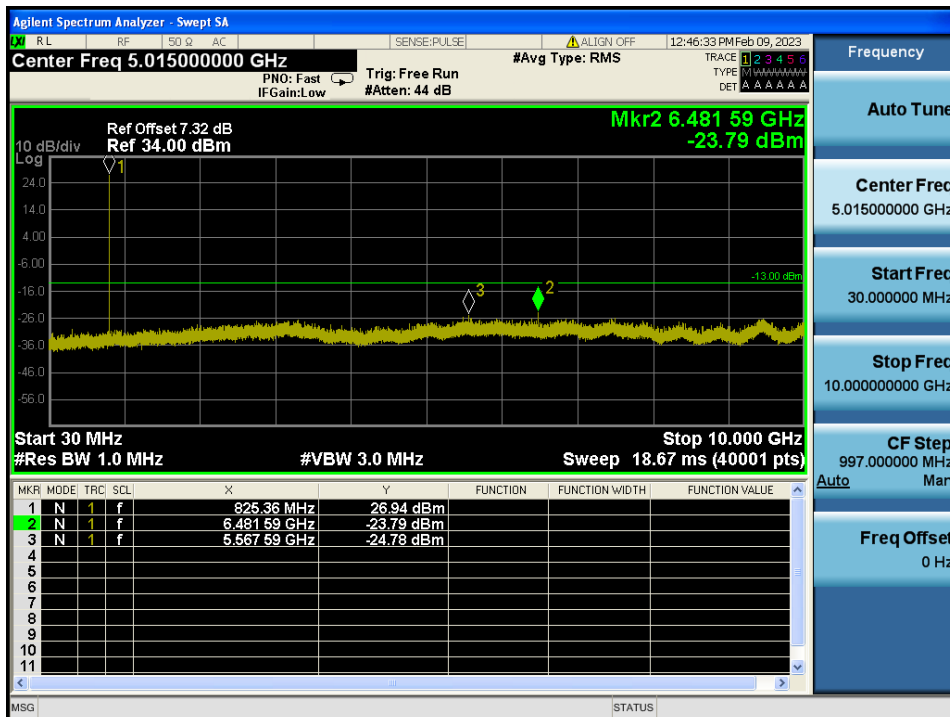

LTE Band 5 / 1.4 MHz / QPSK - RB Size/Offset (3/3) – Low Channel

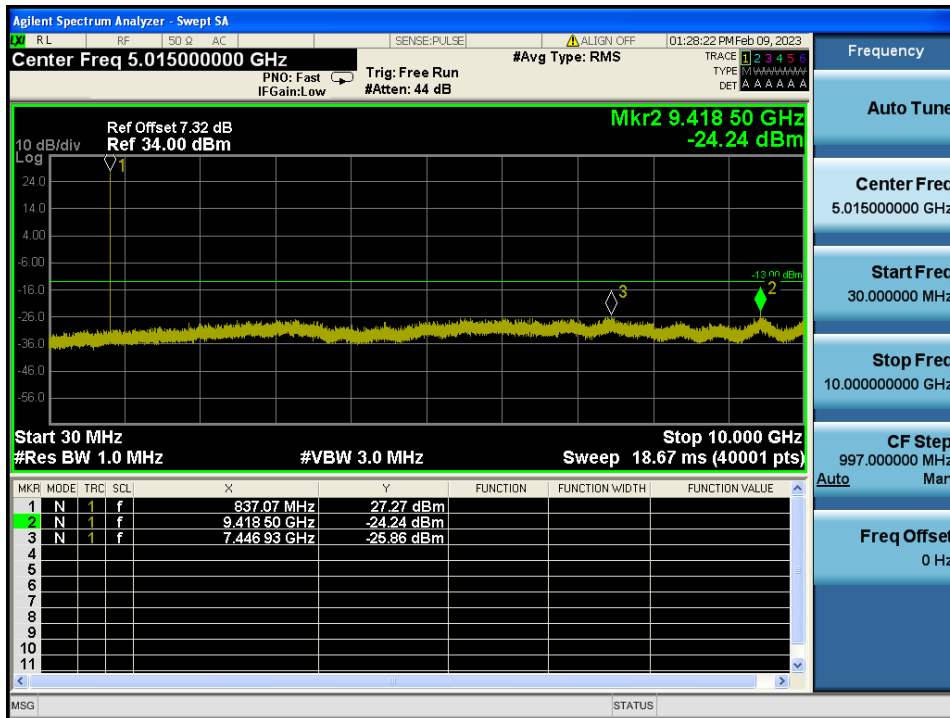

LTE Band 5 / 1.4 MHz / 16QAM - RB Size/Offset (1/5) – Mid Channel

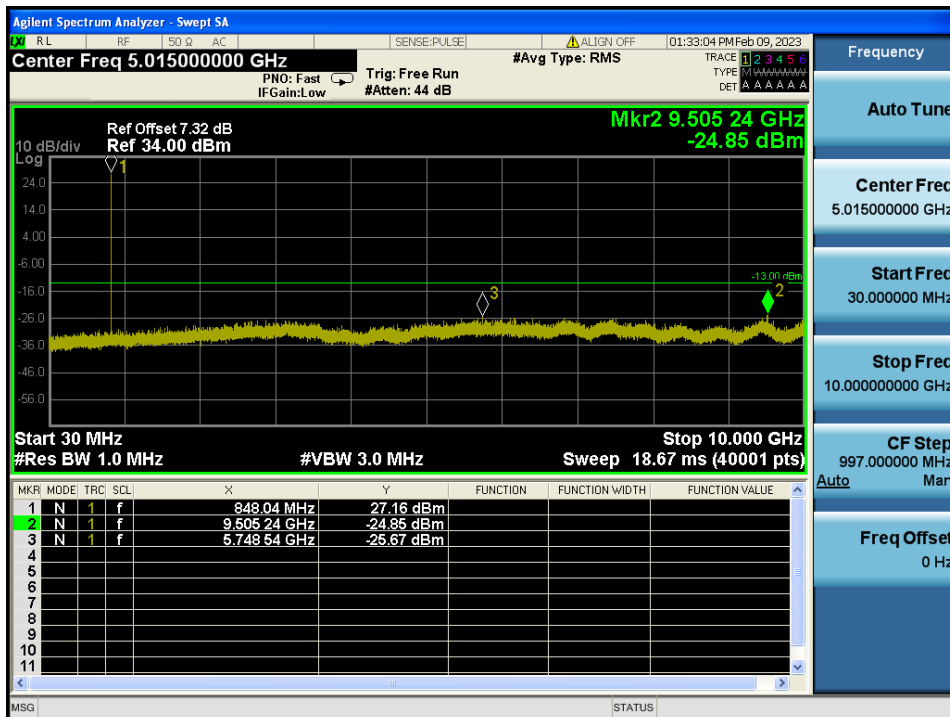

LTE Band 5 / 1.4 MHz / 16QAM- RB Size/Offset (1/0) – High Channel

8.4.2. LTE Band 7

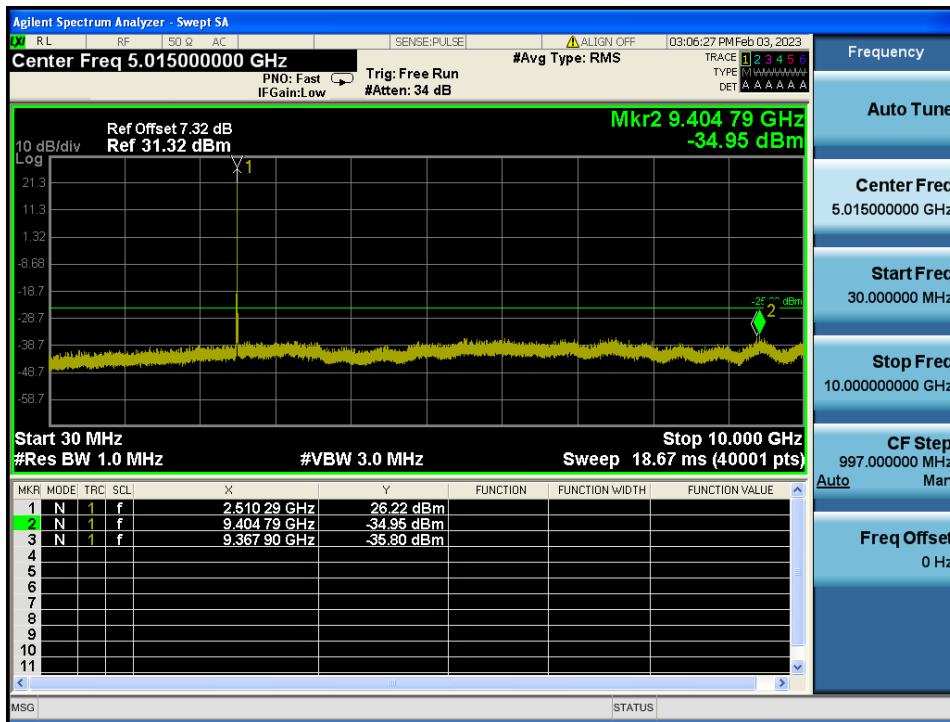

LTE Band 7 / 20 MHz / 16QAM - RB Size/Offset (1/50) – Low Channel

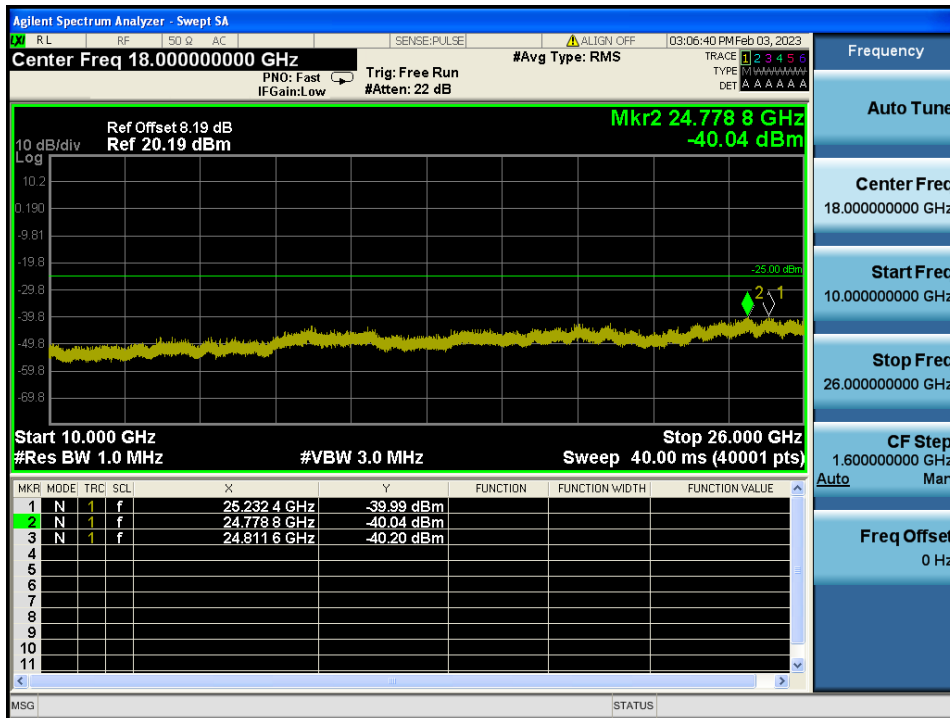

LTE Band 7 / 20 MHz / 16QAM - RB Size/Offset (1/50) – Low Channel

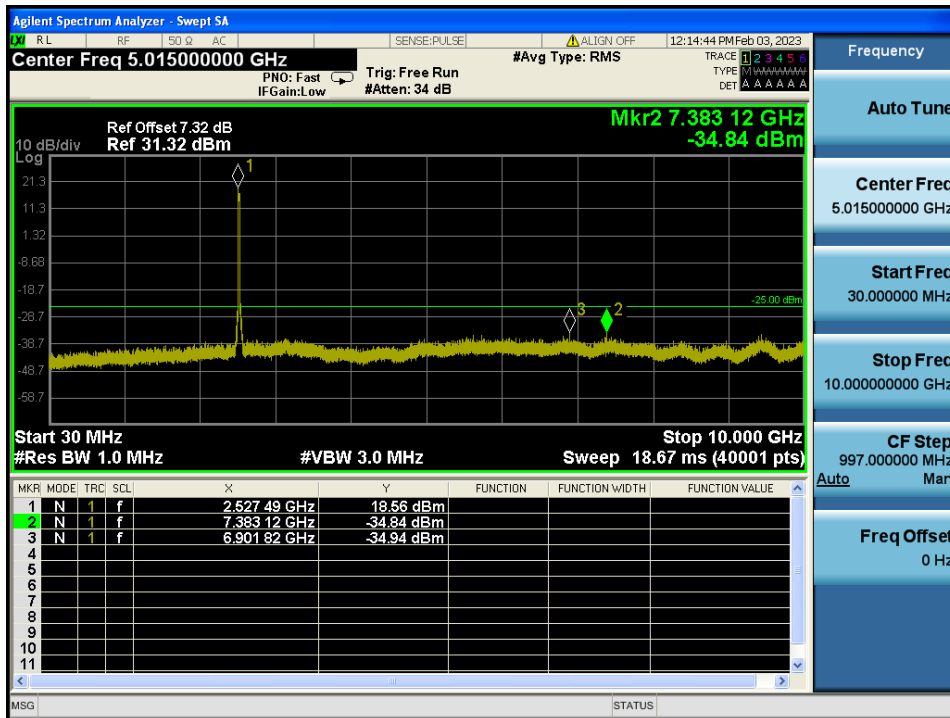

LTE Band 7 / 20 MHz / QPSK - RB Size/Offset (100/0) – Mid Channel

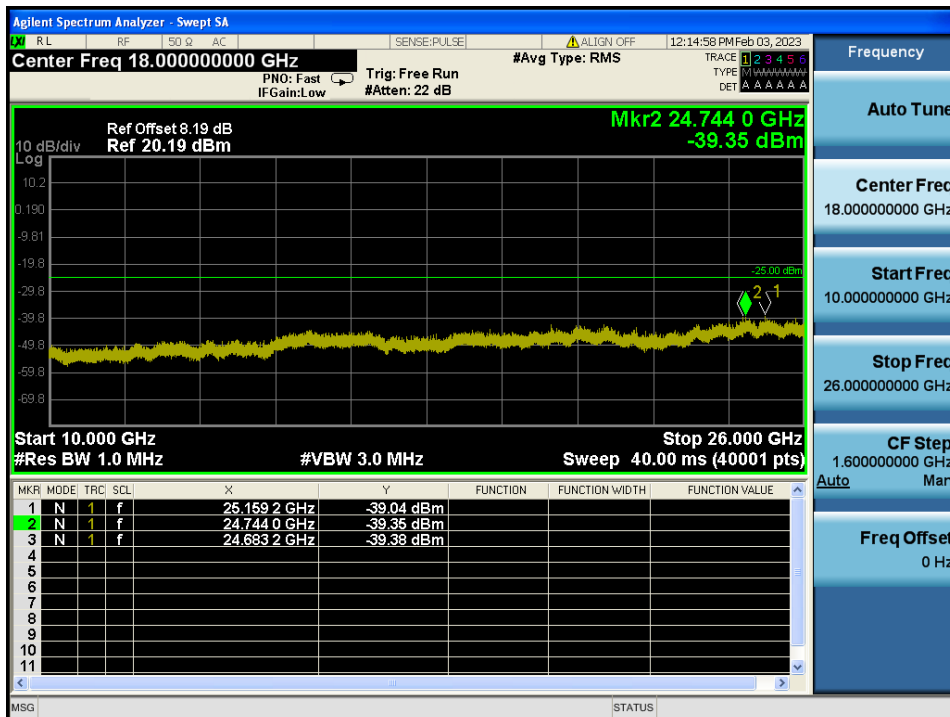

LTE Band 7 / 20 MHz / QPSK - RB Size/Offset (100/0) – Mid Channel

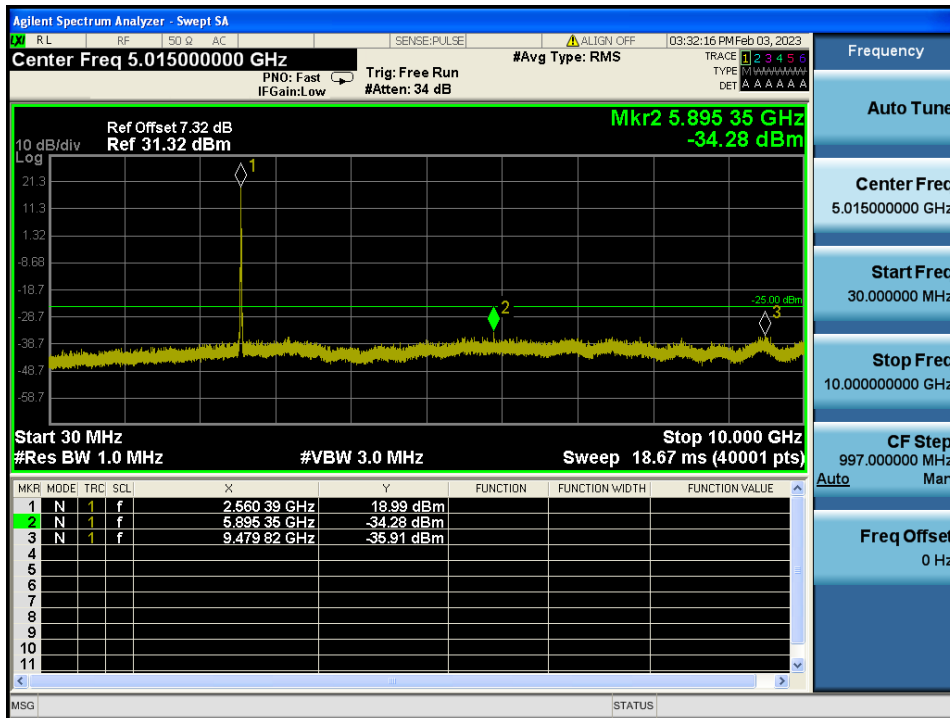

LTE Band 7 / 20 MHz / 16QAM - RB Size/Offset (50/25) – High Channel

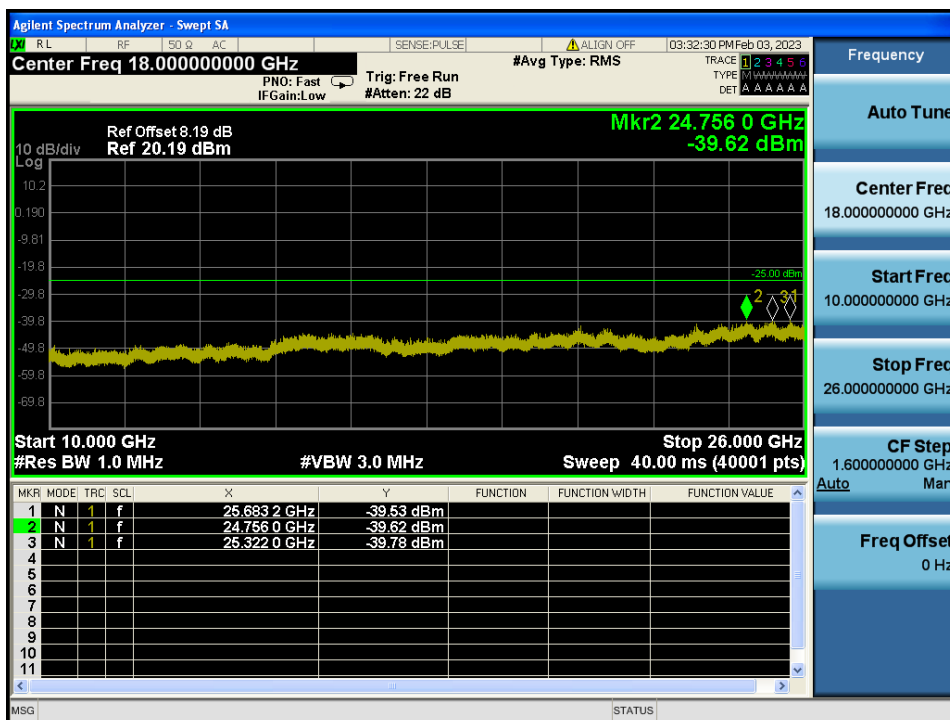

LTE Band 7 / 20 MHz / 16QAM - RB Size/Offset (50/25) – High Channel

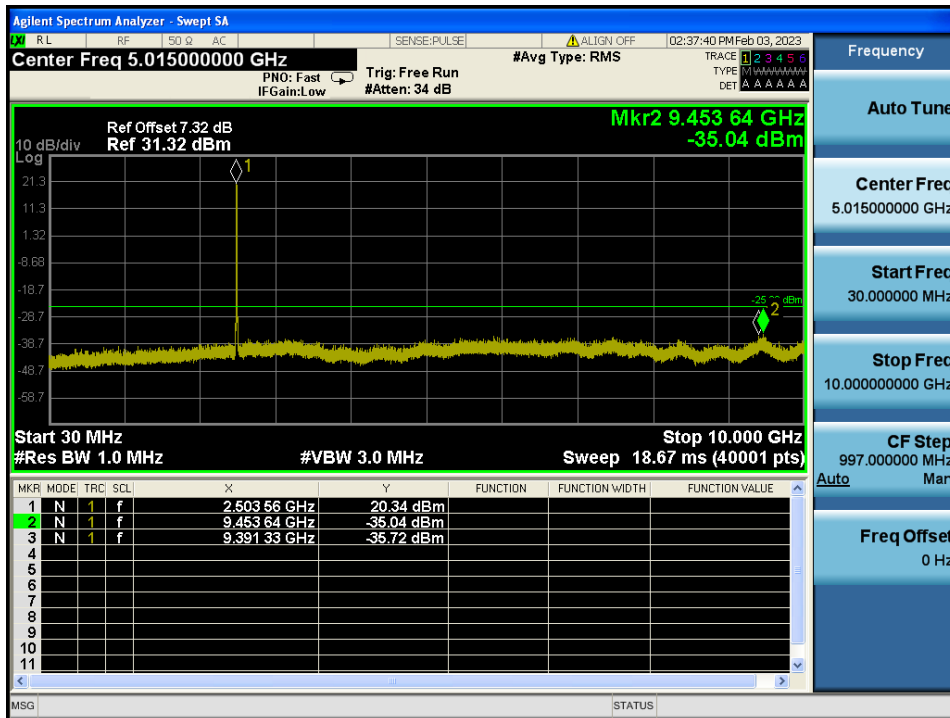

LTE Band 7 / 15 MHz / 16QAM - RB Size/Offset (36/0) – Low Channel

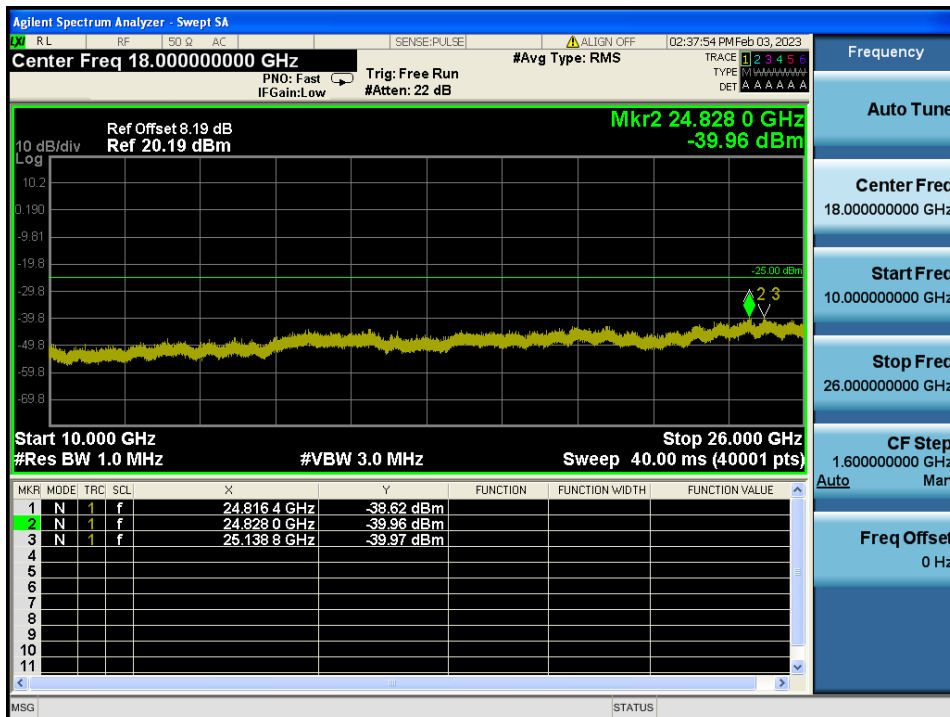

LTE Band 7 / 15 MHz / 16QAM - RB Size/Offset (36/0) – Low Channel

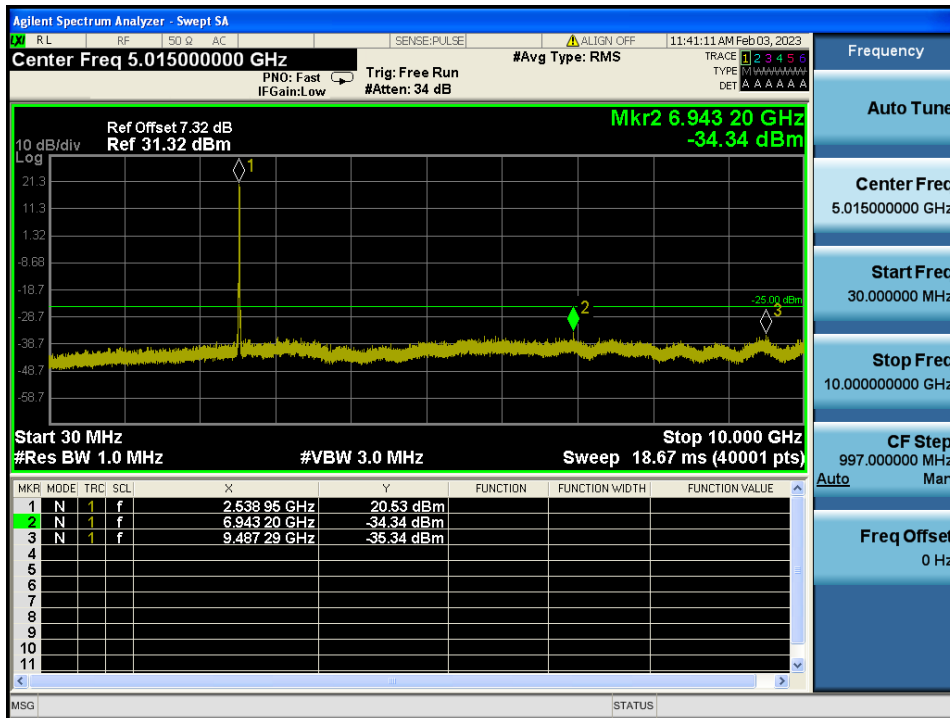

LTE Band 7 / 15 MHz / QPSK - RB Size/Offset (36/39) – Mid Channel

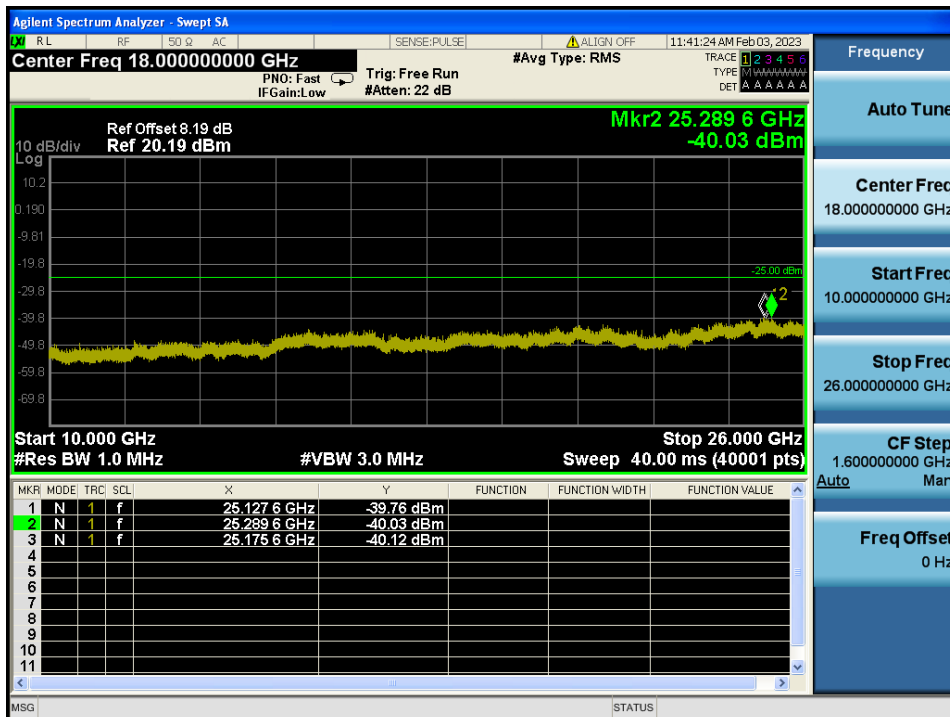

LTE Band 7 / 15 MHz / QPSK - RB Size/Offset (36/39) – Mid Channel

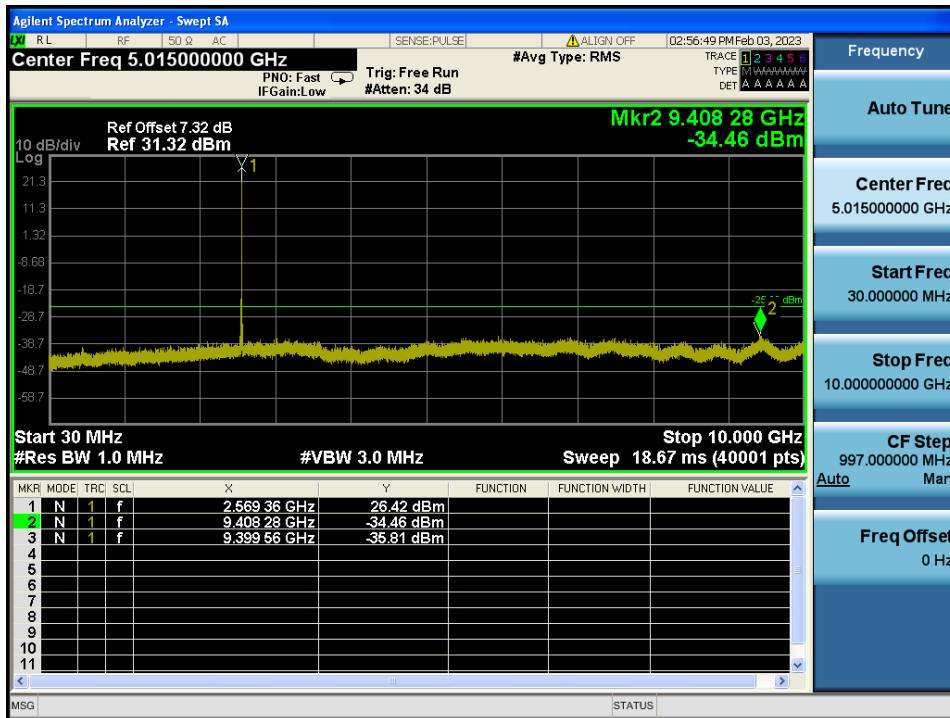

LTE Band 7 / 15 MHz / 16QAM - RB Size/Offset (1/74) – High Channel

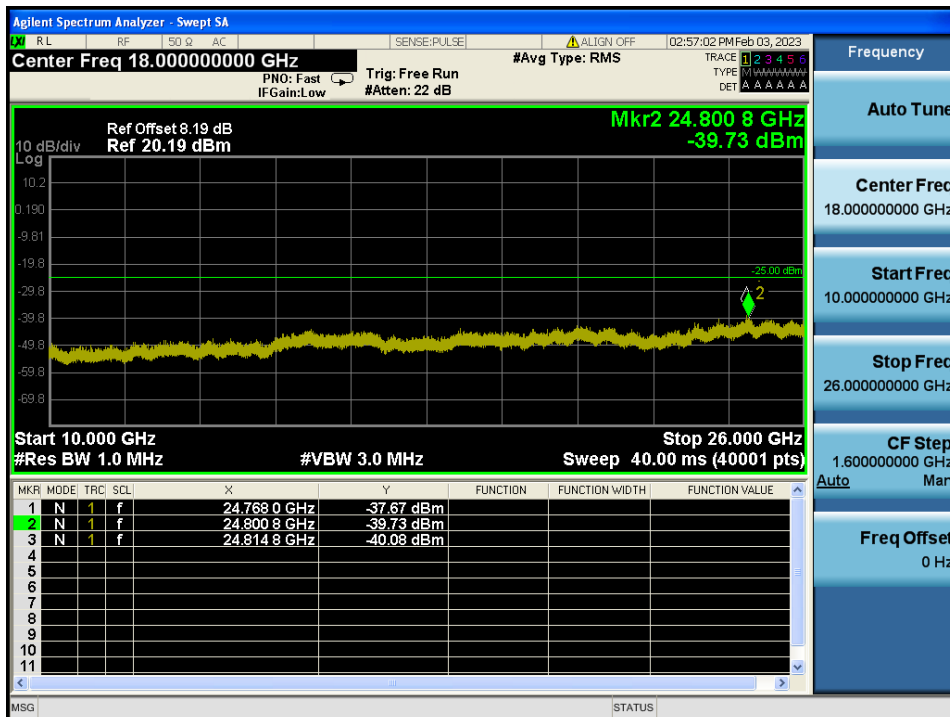

LTE Band 7 / 15 MHz / 16QAM - RB Size/Offset (1/74) – High Channel

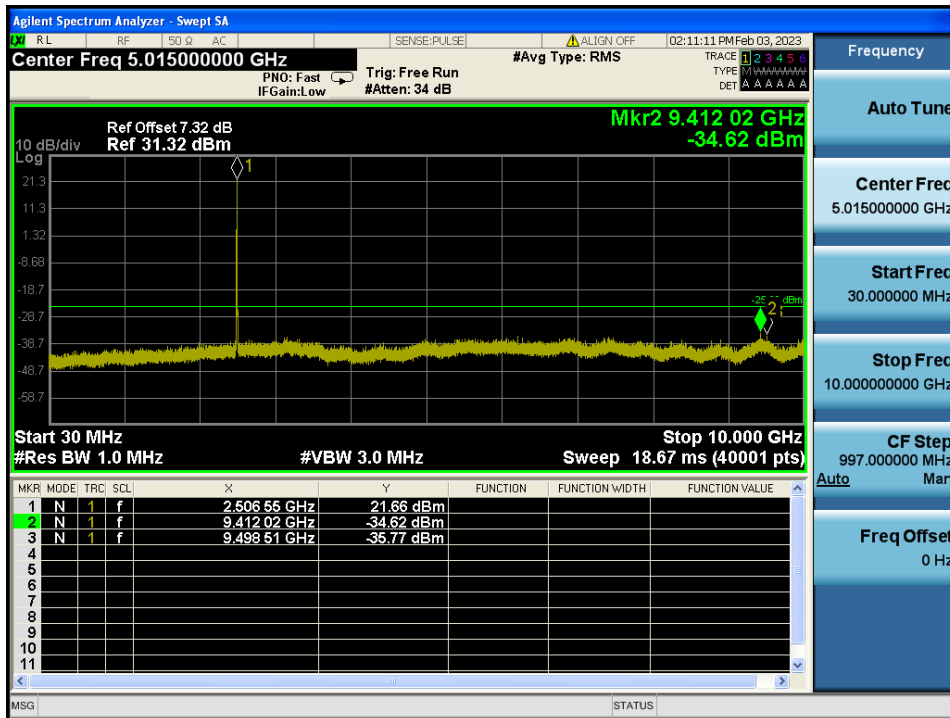

LTE Band 7 / 10 MHz / 16QAM - RB Size/Offset (25/25) – Low Channel

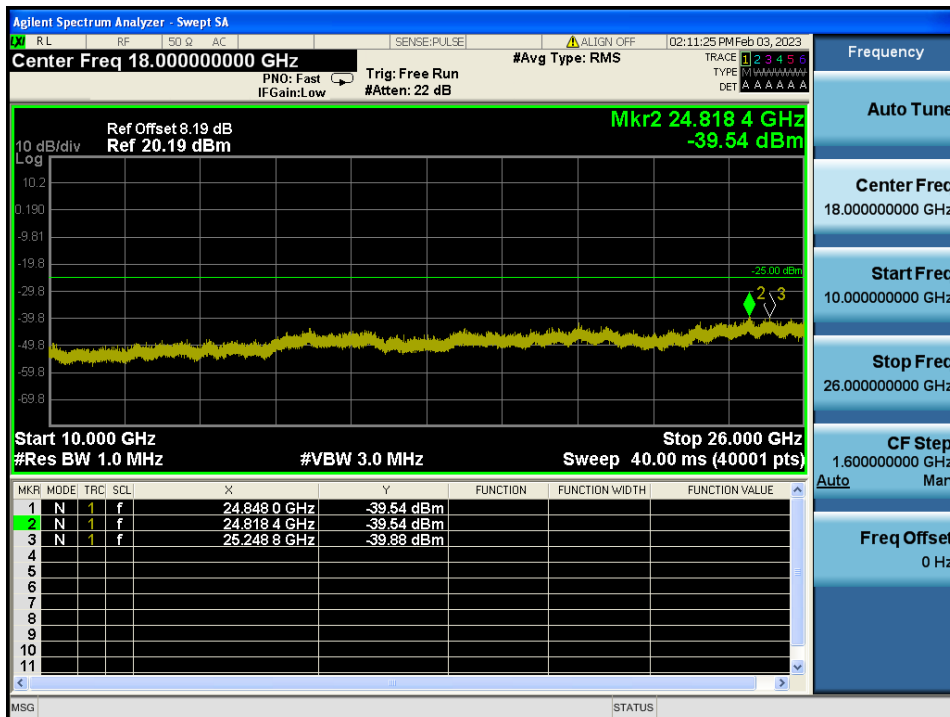

LTE Band 7 / 10 MHz / 16QAM - RB Size/Offset (25/25) – Low Channel

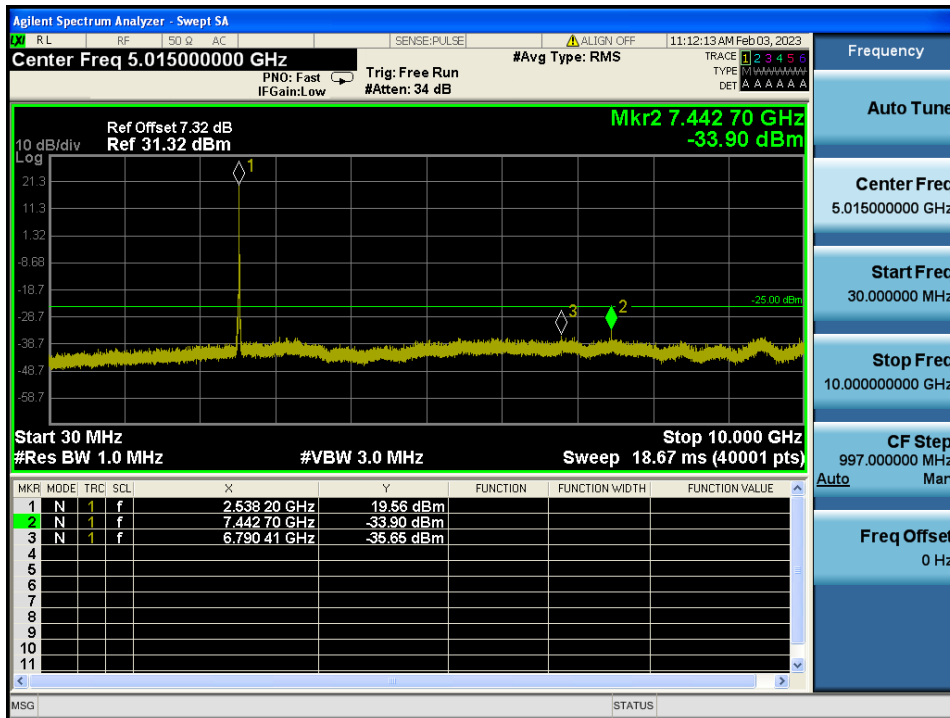

LTE Band 7 / 10 MHz / QPSK - RB Size/Offset (50/0) – Mid Channel

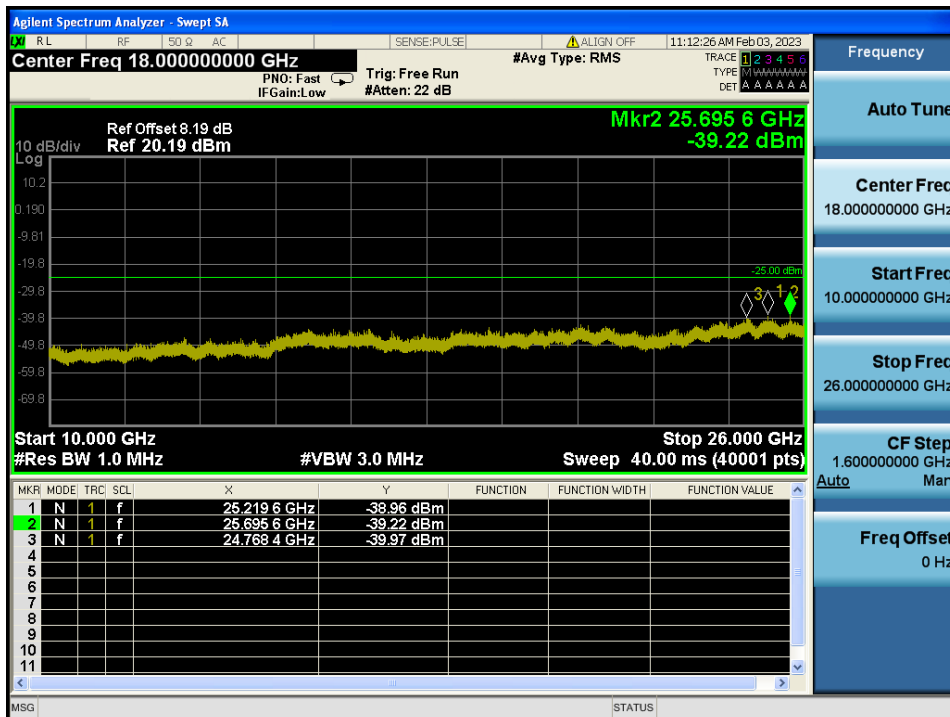

LTE Band 7 / 10 MHz / QPSK - RB Size/Offset (50/0) – Mid Channel

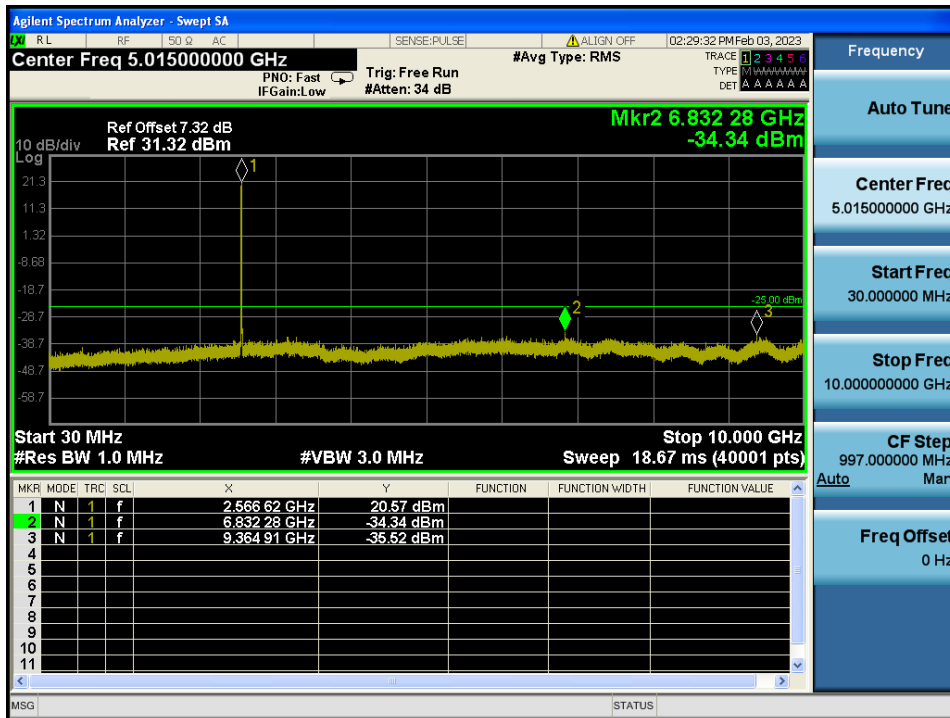

LTE Band 7 / 10 MHz / 16QAM - RB Size/Offset (25/25) – High Channel

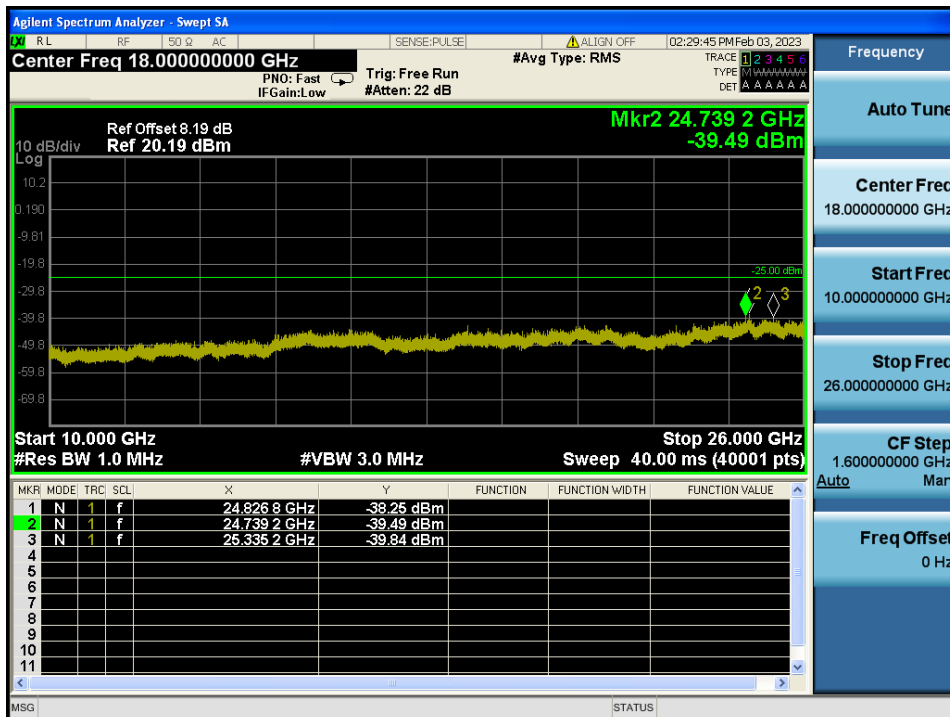

LTE Band 7 / 10 MHz / 16QAM - RB Size/Offset (25/25) – High Channel

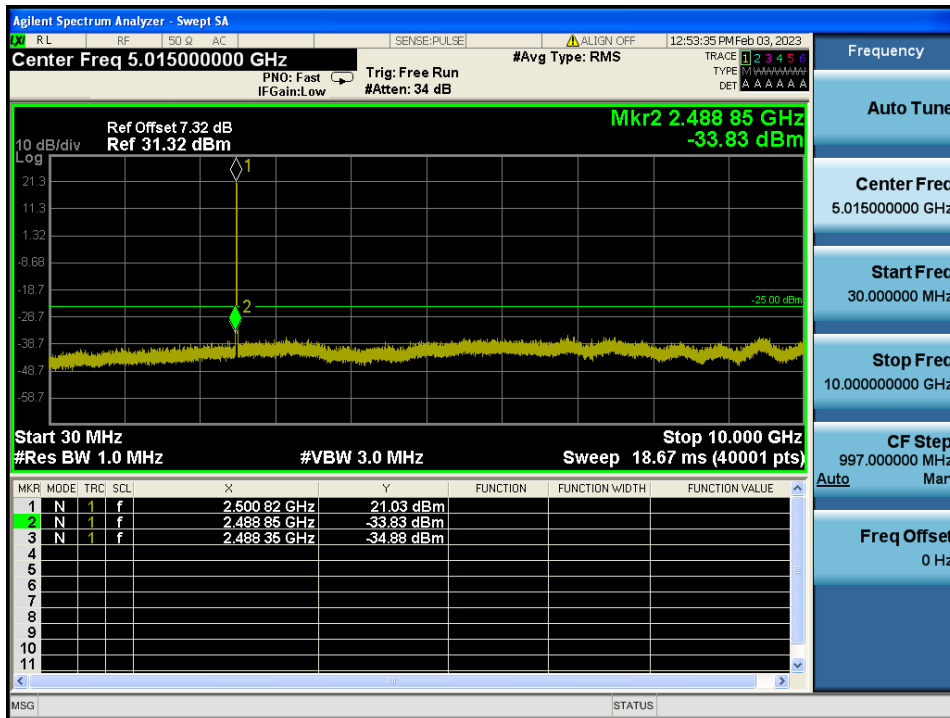

LTE Band 7 / 5 MHz / QPSK - RB Size/Offset (25/0) – Low Channel

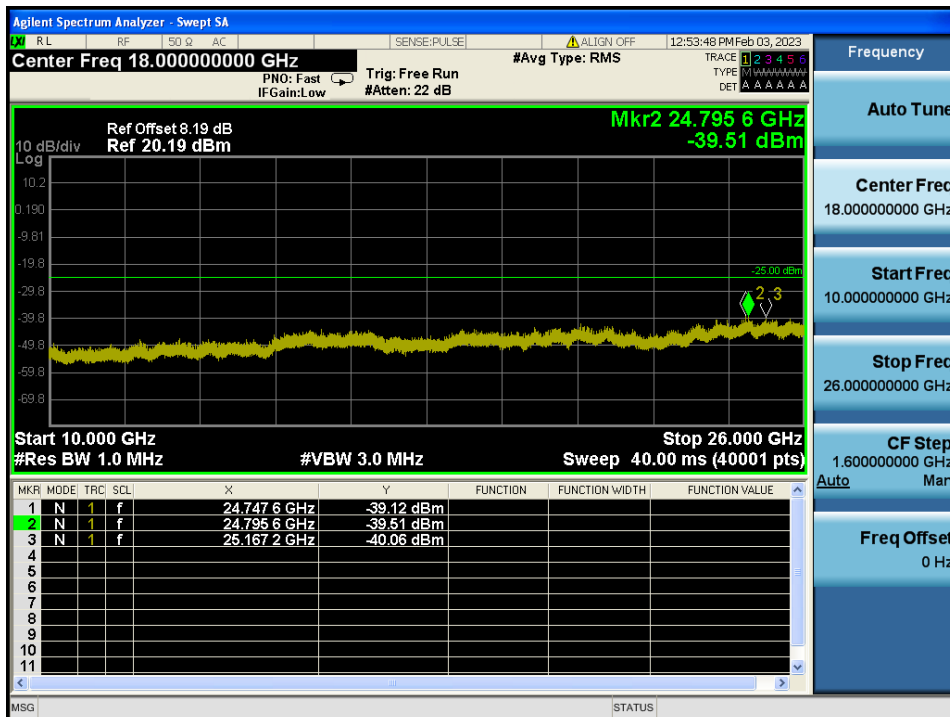

LTE Band 7 / 5 MHz / QPSK - RB Size/Offset (25/0) – Low Channel

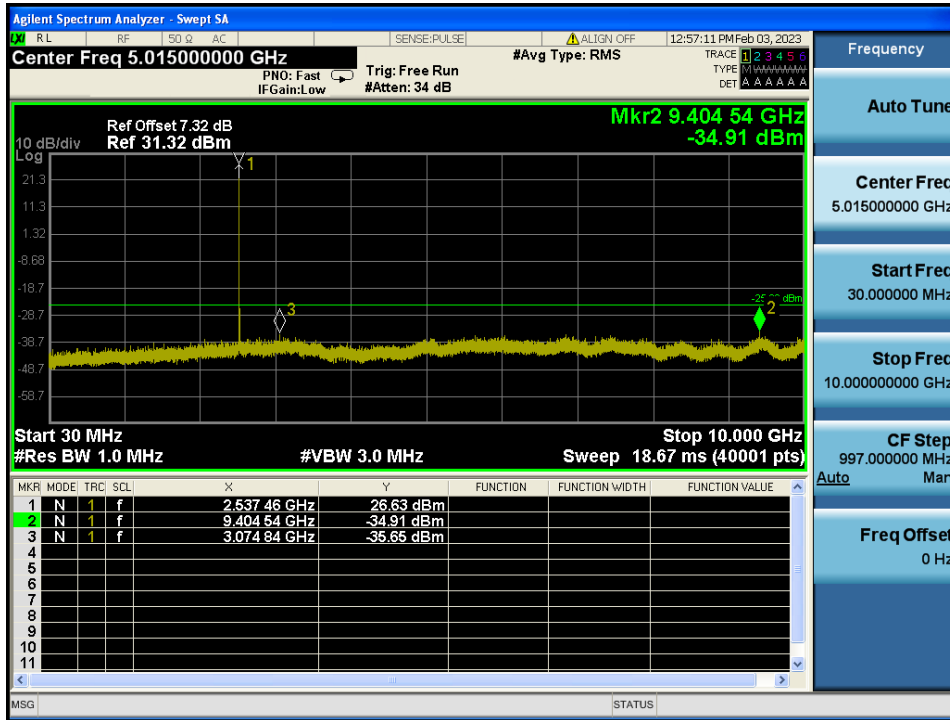

LTE Band 7 / 5 MHz / QPSK - RB Size/Offset (1/24) – Mid Channel

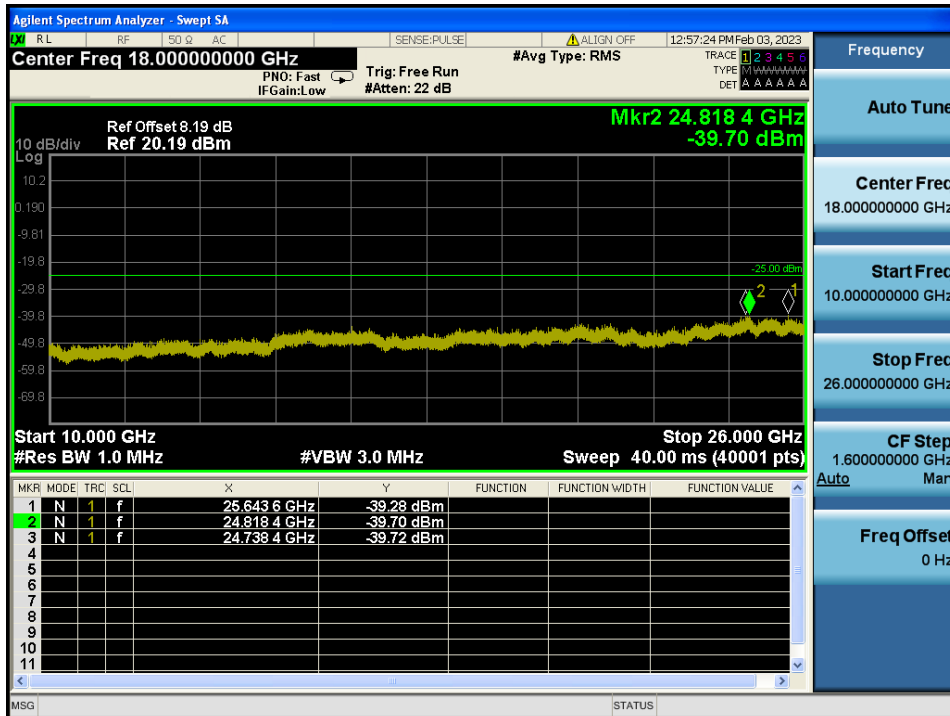

LTE Band 7 / 5 MHz / QPSK - RB Size/Offset (1/24) – Mid Channel

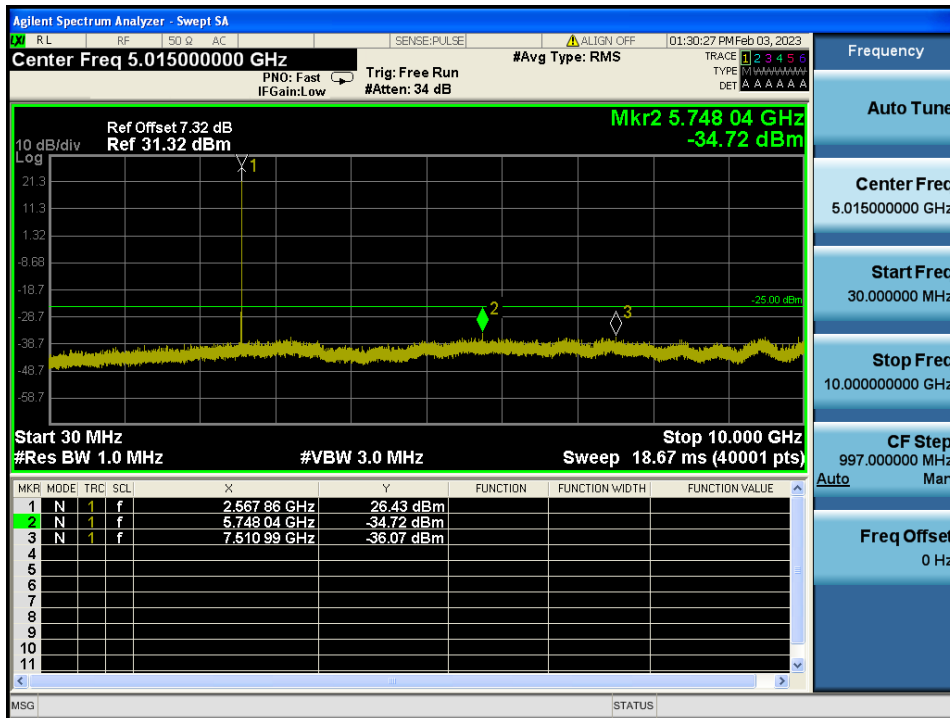

LTE Band 7 / 5 MHz / 16QAM - RB Size/Offset (1/12) – High Channel

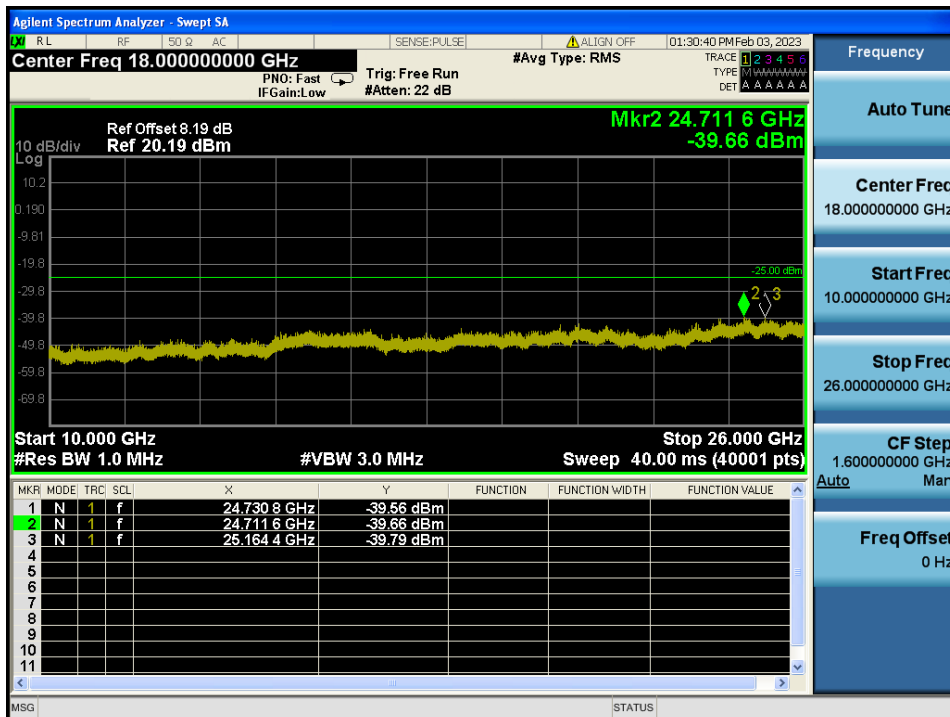

LTE Band 7 / 5 MHz / 16QAM - RB Size/Offset (1/12) – High Channel