

HCT CO., LTD.



SAN 136-1, AMI-RI , BUBAL-EUP, ICHEON-SI, KYOUNGKI-DO, 467-701, KOREA

TEL: +82 31 639 8565 FAX : +82 31 639 8525 www.hct.co.kr

CERTIFICATE OF COMPLIANCE

FCC Part 22 Certification

LG Electronics, Inc.

60-39, Kasan-Dong, Kumchon-Gu, Seoul 153-801, Korea

Date of Issue: December 26, 2007

Test Report No.: HCT-SAR07-1210

Test Site: HCT CO., LTD.

FCC ID :

BEJRD6100

APPLICANT :

LG Electronics, Inc.

EUT Type: Single -Band CDMA Phone (CDMA835)
Tx Frequency: 824.70 — 848.31 MHz (CDMA)
Rx Frequency: 869.70 — 893.31 MHz (CDMA)
Max. RF Output Power: 0.176 W CDMA (22.47 dBm)
Trade Name/Model(s): LG Electronics, Inc. / RD6100,
Additional model(s): MC6100, UD6100, ID6100, HD6100, SD6100, YD6100, XD6100, SN6100,
ND6100, GD6100, KD6100
FCC Classification: Licensed Non-Broadcast Station Transmitter held to ear (TNE)
Application Type: Certification
FCC Rule Part(s): §22(H)
Emission Designator(s): 1M28F9W

This equipment has been shown to be capable of compliance with the applicable technical standards as indicated in the measurement report and was tested in accordance with the measurement procedures specified in § 2.947.

I attest to the accuracy of data. All measurements reported herein were performed by me or were made under my supervision and are correct to the best of my knowledge and belief. I assume full responsibility for the completeness of these measurements and vouch for the qualifications of all persons taking them.

HCT CO., LTD. Certifies that no party to this application has been denied FCC benefits pursuant to section 5301 of the Anti- Drug Abuse Act of 1998, 21 U.S. C. 853(a)

Report prepared by

: Young-Kwan Kim

Test Engineer of RF Part

Approved by

: Sang- Jun Lee

Manager of RF Part

This report only responds to the tested sample and may not be reproduced, except in full, without written approval of the HCT Co., Ltd.

Table of Contents

1. SCOPE -----	3
2. INTRODUCTION -----	4
3. INSERTS-----	5
4. DESCRIPTION OF TESTS-----	6
5. EFFECTIVE RADIATED POWER OUTPUT -----	14
6. RADIATED MEASUREMENTS-----	15
7. FREQUENCY STABILITY -----	18
8. LIST OF TEST EQUIPMENT -----	19
9. SAMPLE CALCULATIONS -----	20
10. CONCLUSION -----	21
11. TEST PLOTS -----	22

MEASUREMENT REPORT

1. SCOPE

Measurement and determination of electromagnetic emissions (EME) of radio frequency devices including intentional and/or unintentional radiators for compliance with the technical rules and regulations of the Federal Communications Commission.

General Information

Applicant:	LG Electronics, Inc.
Address:	60-39, Kasan-Dong, Kumchon-Gu, Seoul 153-801, Korea
Responsible Test Engineer:	Eui –Soon Park
Tel. / Fax :	+82-2-2033-1113 / +82-2-2033-1222

- FCC ID: BEJRD6100
- Quantity: Quantity production is planned
- EUT Type: Single -Band CDMA Phone (CDMA835)
- Trade Name: LG Electronics, Inc.
- Model(s): RD6100
- Serial Number(s): #1
- Emission Designator(s): 1M28F9W
- Tx Frequency: 824.70 – 848.31 MHz (CDMA)
- Rx Frequency: 869.70 – 893.31 MHz (CDMA)
- Application Type: Certification
- FCC Classification: Licensed Non-Broadcast Station Transmitter held to ear (TNE)
- FCC Rule Part(s): §22(H)
- Modulation(s): CDMA
- Antenna Type: Intenna
- Antenna Specifications: Manufacturer: ACE ANTENNA
Part NO.: SNMF0037401, GAIN: -7.7 dBi (Length=39.50 mm)
- Max RF. Output Power: 0.176 W CDMA (22.47 dBm)
- Date(s) of Tests: December 23, 2007 ~ December 24, 2007
- Place of Tests: HCT CO., LTD.
Icheon, Kyounki-Do, KOREA
- Report Serial No.: HCT-SAR07-1210

2. INTRODUCTION

EUT DESCRIPTION

The LG Electronics, Inc. Single -Band GSM Phone. Its basic purpose is used for communications. It transmits from CDMA (824.70 ~ 848.31) MHz and receives from CDMA (869.70 ~ 893.31) MHz. The RF power is rated at CDMA(0.176 W).

MEASURING INSTRUMENT CALIBRATION

The measuring equipment, which was utilized in performing the tests documented herein, has been calibrated in accordance with the manufacturer's recommendations for utilizing calibration equipment, which is traceable to recognized national standards.

Test Facility

The open area test site and conducted measurement facility used to collect the radiated data are located at the 254-1, Maekok-Ri, Hobup-Myun, Ichon-Si, Kyoungki-Do, 467-701, KOREA. The site is constructed in conformance with the requirements of ANSI C63.4 and CISPR Publication 22. Detailed description of test facility was submitted to the Commission and accepted dated July 6, 2006(Registration Number: 90661)

3. INSERTS

Function of Active Devices (Confidential)

The Function of active devices are shown in Attachment K.

Block/Circuit Diagrams & Description (Confidential)

The circuit diagrams & description are shown in Attachment J, and the block diagrams are shown in Attachment I.

Operating Instructions

The instruction manual is shown in Attachment M.

Parts List & Tune-Up Procedure (Confidential)

The parts list & tune-up procedure are shown in Attachment L.

Description of Freq. Stabilization Circuit (Confidential)

The description of frequency stabilization circuit is shown in Attachment K.

Description for Suppression of Spurious Radiation, for Limiting Modulation, and Harmonic Suppresion Circuits (Confidential)

The description of suppression stabilization circuits are shown in Attachment K

4. DESCRIPTION OF TESTS

Out power Variation

Test condition to measure the Output power

This device was tested under all R.C.s and worst case is reported with RC3/SO55, with "All Up" power control bits.

The following procedures were followed according to FCC "SAR Measurement Procedures for 3G Devices", May 2006

1. If the mobile station supports Reverse TCH RC 1 and Forward TCH RC 1, set up a call using Fundamental Channel Test Mode 1 (RC = 1/1) with 9 600 bps data rate only.
2. Under RC1, C.S0011 Table 4.4.5.2-1 (Table 1) parameters were applied.
3. If the MS supports the RC 3 Reverse FCH, RC3 Reverse SCH0 and demodulation of RC 3, 4, or 5, set up a call using Supplemental Channel Test Mode 3 (RC 3/3) with 9 600 bps Fundamental Channel and 9 600 bps SCH0 data rate Channel and 9 600 bps SCH0 data rate.
4. Under RC3, C.S0011 Table 4.4.5.2-2(Table 2) was applied.
5. FCHs were configured at full rate for maximum SAR with "All Up" power control bits.

Parameters for Max. Power for RC1

Parameter	Units	Value
\dot{I}_{or}	dBm/1.23 MHz	-104
$\frac{Pilot E_c}{I_{or}}$	dB	-7
$\frac{Traffic E_c}{I_{or}}$	dB	-7.4

Table. 1

Parameters for Max. Power for RC3

Parameter	Units	Value
\dot{I}_{or}	dBm/1.23 MHz	-86
$\frac{Pilot E_c}{I_{or}}$	dB	-7
$\frac{Traffic E_c}{I_{or}}$	dB	-7.4

Table. 2

Maximum Power Output table for FCC ID: BEJRD6100

Band	Channel	SO2	SO2	SO55	SO55	TDSO	1xEvDO	1xEvDO
		RC1/1	RC3/3	RC1/1	RC3/3	RC3/3	(FTAP)	(RTAP)
CDMA	1013	24.39	24.42	24.40	24.42	24.53	-	-
	384	24.44	24.42	24.44	24.48	24.52	-	-
	777	24.52	24.55	24.55	24.57	24.61	-	-

4.1 Conducted RF Power Test

Test Set-up

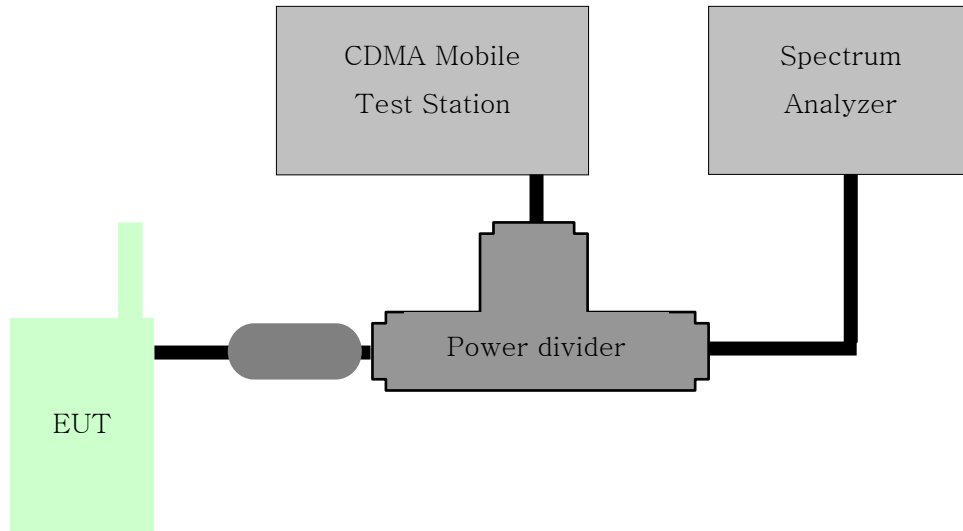

Test Procedure

According to FCC §2.1046 (A), for transmitters other than single sideband, independent sideband and controlled carrier radiotelephone, power output shall be measured at the RF output terminals when the transmitter is adjusted in accordance with the tune-up procedure to give the values of current and voltage on the circuit elements specified in § 2.1033(c)(8). The electrical characteristics of the radio frequency load attached to the output terminals when this test is made shall be stated.

- 1) The EUT was coupled to the spectrum analyzer and the base station simulator through a power divider. The radio frequency load attached to the EUT antenna terminal was 50 Ω . The loss of the cables the test system is calibrated to correct the reading.
- 2) The spectrum analyzer was set to Maxpeak Detector function and Maximum hold mode.
- 3) The resolution bandwidth of the spectrum analyzer was comparable to the emission bandwidth. For GSM signal, VBW = RBW = 1 MHz; for CDMA signal, VBW = RBW = 3 MHz.

4.2 Effective Radiated Power.

Test Set-up

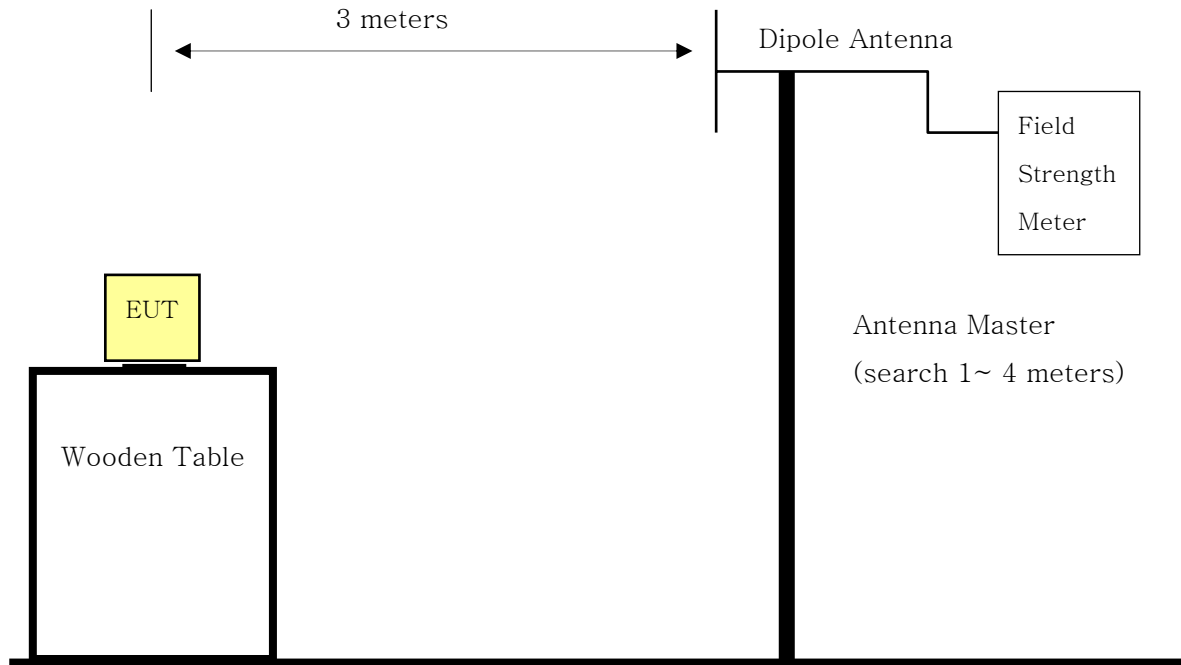

[Open Field Test Site]

Test Procedure

The measurement facilities used for this test have been documented in previous filings with the commission pursuant to section 2.948.

The open field test site is situated in open field with ground screen whose site attenuation characteristics meet ANSI C63.4 –2003. A mast capable of lifting the receiving antenna from a height of one to four meters is used together with a turn-able wooden platform mounted at three from the antenna mast.

- 1) The EUT mounted on a wooden tripod is 0.8 meter above test site ground level.
- 2) During the test, the turn table is rotated and the antenna height is also varied from 1 to 4 meters until the maximum signal is found.
- 3) Record the field strength meter's level.
- 4) Replace the EUT with $\lambda/2$ dipole antenna that is connected to a calibrated signal generator.
- 5) Increase the signal generator output till the field strength meter's level is equal to the item (4).
- 6) The signal generator output level is the rating of effective radiated power (ERP).
- 7) The instrument settings used (RBW/ VBW) during ERP/ EIRP output power measurement are as Below;
 - . Below 1 GHz : RBW 3 MHz, VBW 3 MHz
 - . Above 1 GHz : RBW 3 MHz, VBW 3 MHz

4.3 Occupied bandwidth.

Test Set-up

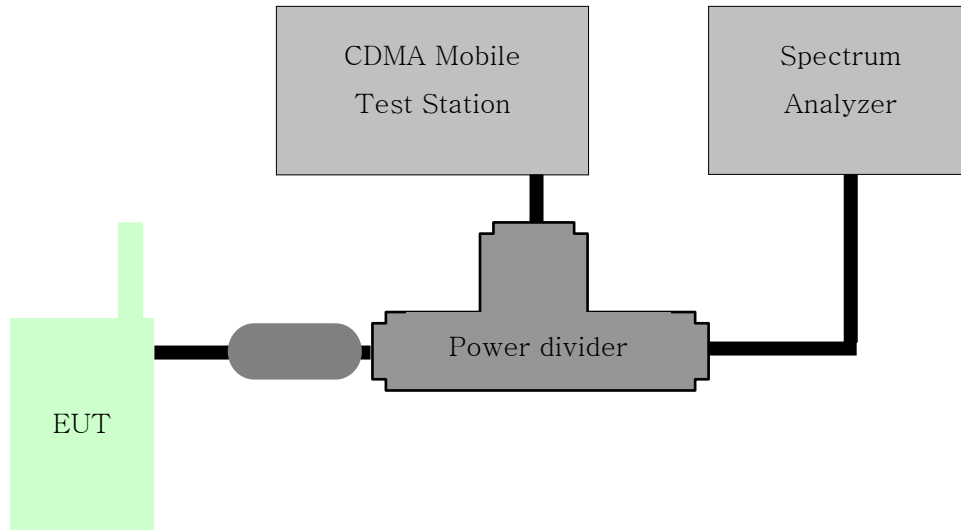

Test Procedure

The EUT was setup to maximum output power at its lowest channel. The occupied bandwidth was measured using a spectrum analyzer. The measurements are repeated for the highest and a middle channel. The EUT's occupied bandwidth is measured as the width of the signal between two points, one below the carrier center frequency and one above the carrier frequency, outside of which all emissions are attenuated at least 26 dB below the transmitter power. Plots of the EUT's occupied bandwidth are shown herein.

4.4 Spurious and Harmonic Emissions at Antenna Terminal.

Test Set-up

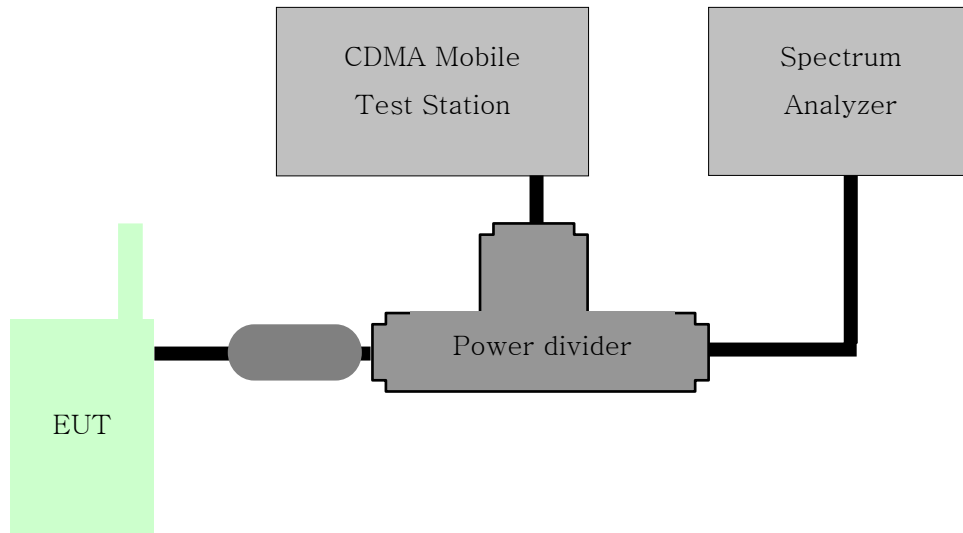

Test Procedure

The EUT was setup to maximum output power at its lowest channel. The Resolution BW of the analyzer is set to 1 % of the emission bandwidth to show compliance with the - 13 dBm limit, in the 1 MHz bands immediately outside and adjacent to the edge of the frequency block. The 1 MHz RBW was used to scan from 10 MHz to 10 GHz. (PCS Mode : 10 MHz to 20 GHz). A display line was placed at - 13 dBm to show compliance. The high, lowest and a middle channel were tested for out of band measurements.

4.5 Field strength of spurious radiation .

Test Set-up

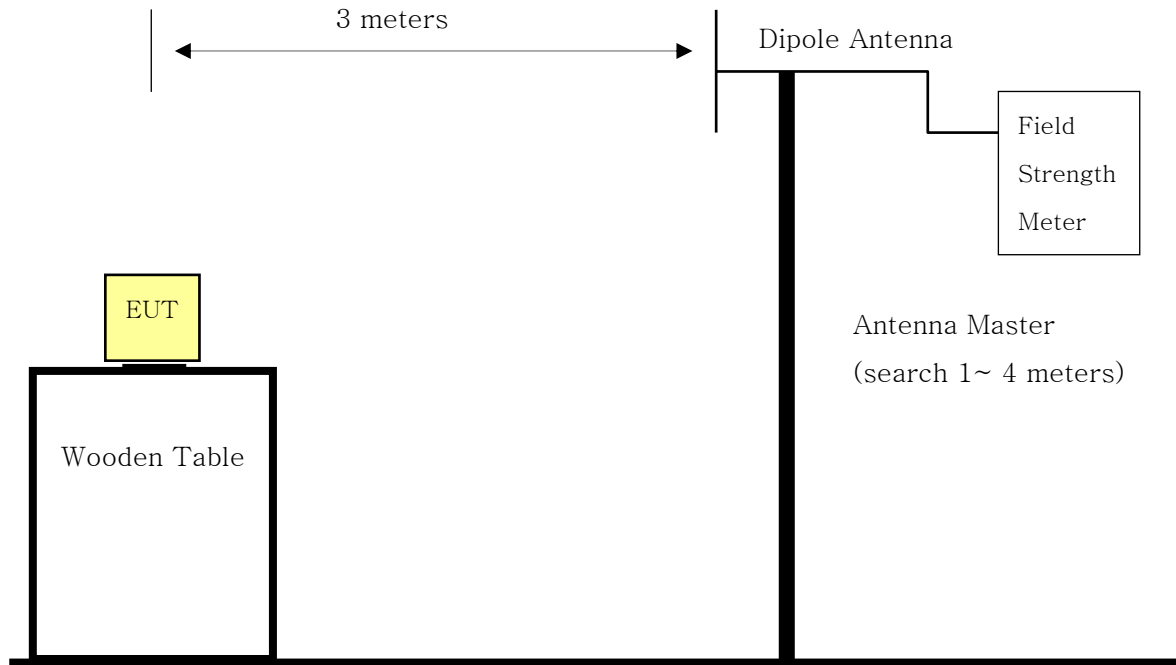

[Open Field Test Site]

Test Procedure

The measurement facilities used for this test have been documented in previous filings with the commission pursuant to section 2.948.

The open field test site is situated in open field with ground screen whose site attenuation characteristics meet ANSI C63.4 –2003. A mast capable of lifting the receiving antenna from a height of one to four meters is used together with a turn-able wooden platform mounted at three from the antenna mast.

- 1) The unit mounted on a wooden table 1.5 m × 1.0 m × 0.80 m is 0.8 meter above test site ground level.
- 2) During the emission test, the turn table is rotated and the EUT is manipulated to find the configuration resulting in maximum emission under normal condition of installation and operation.
- 3) The antenna height and polarization are also varied from 1 to 4 meters until the maximum signal is found.
- 4) The spectrum shall be scanned up to the 10th harmonic of the fundamental frequency.
- 5) The instrument settings used (RBW/ VBW) during ERP/ EIRP output power measurement are as below ;
 - . Below 1 GHz : RBW 3 MHz, VBW 3 MHz
 - . Above 1 GHz : RBW 3 MHz, VBW 3 MHz

4.6 Frequency stability .

4.6.1 Frequency stability with variation of ambient temperature.

Test Set-up

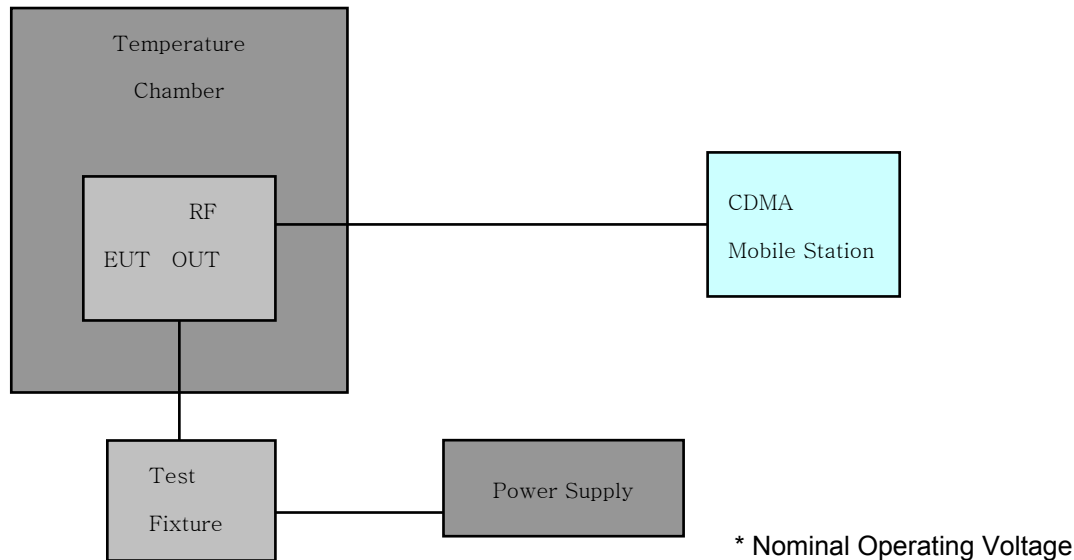

Test Procedure

The frequency stability of the transmitter is measured by:

- a.) **Temperature:** The temperature is varied from - 30 °C to + 50 °C using an environmental chamber.
- b.) **Primary Supply Voltage:** The primary supply voltage is varied from battery end point to 115 % of the voltage normally at the input to the device or at the power supply terminals if cables are not normally supplied.

Specification — The frequency stability shall be sufficient to ensure that the fundamental emission stays within the authorized frequency block. The frequency stability of the transmitter shall be maintained within $\pm 0.00025\%$ (± 2.5 ppm) of the center frequency.

Time Period and Procedure:

1. The carrier frequency of the transmitter and the individual oscillators is measured at room temperature (25 °C to 27 °C to provide a reference).
2. The equipment is subjected to an overnight “soak” at - 30 °C without any power applied.
3. After the overnight “soak” at 30 °C (usually 14-16 hours), the equipment is turned on in a “standby” condition for one minute before applying power to the transmitter. Measurement of the carrier frequency of the transmitter and the individual oscillators is made within a three minute interval after applying power to the transmitter.
4. Frequency measurements are made at 10 °C interval up to room temperature. At least a period of one and one half-hour is provided to allow stabilization of the equipment at each temperature level.
5. Again the transmitter carrier frequency and the individual oscillators is measured at room temperature to begin measurement of the upper temperature levels.
6. Frequency were made at 10 °C intervals starting at - 30 °C up to + 50 °C allowing at least two hours at each temperature for stabilization. In all measurements the frequency is measured within three minutes after applying power to the transmitter.
7. The artificial load is mounted external to the temperature chamber.

NOTE: The EUT is tested down to the battery endpoint.

4.6.2 Frequency stability with variation of primary supply voltage.

Test Set-up

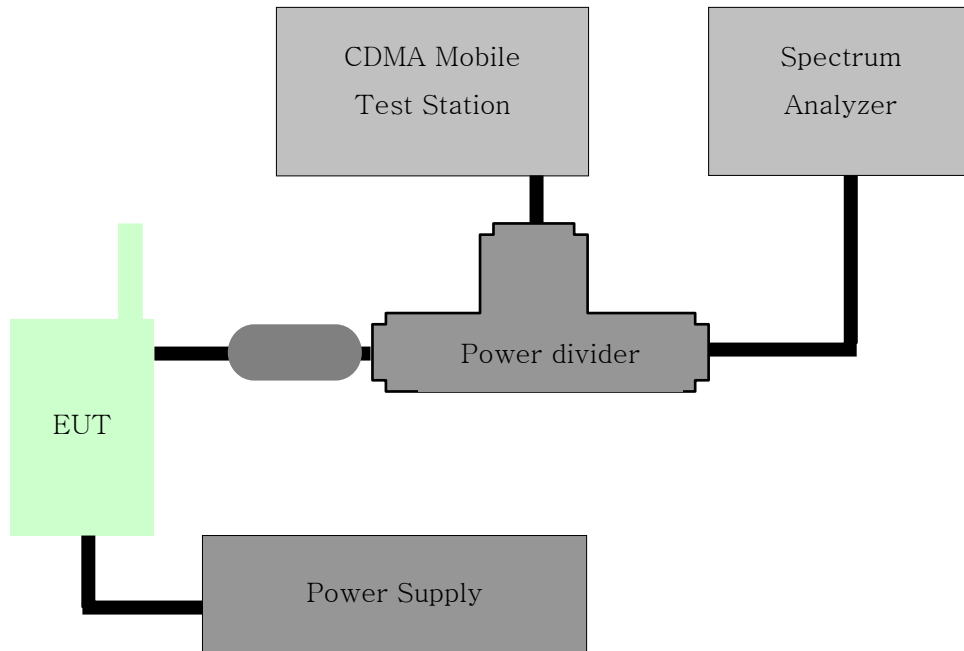

Test Procedure

- 1) The primary supply is varied in steps of from battery end point to 115 % of the nominal supply voltage, or reduce primary supply voltage to the battery operating end point.
- 2) The frequency is recorded each 10 °C step.

5. Test Data

5.1 Effective Radiated Power Output (CDMA)

Radiated measurements at 3 m

Modulation: CDMA

Freq. Tuned (MHz)	REF. LEVEL (dBm)	POL (H/V)	ERP (W)	ERP (dBm)	BATTERY
824.70	- 24.68	V	0.176	22.47	Standard
835.89	- 24.93	V	0.167	22.22	Standard
848.31	- 25.09	V	0.161	22.06	Standard

NOTES:

Effective Radiated Power Output Measurements by Substitution Method
according to ANSI/TIA/EIA-603-C-2004, Aug. 17, 2004:

The EUT was placed on a wooden turn table 3-meters from the receive antenna. The receive antenna height and turntable rotation was adjusted for the highest reading on the receive spectrum analyzer. For CDMA signals, a peak detector is used, with RBW = VBW = 3 MHz. For AMPS, GSM, and NADC TDMA signals, a peak detector is used, with RBW = VBW = 1 MHz. A half-wave dipole was substituted in place of the EUT. This dipole antenna was driven by a signal generator and the level of the signal generator was adjusted to obtain the same receive spectrum analyzer reading. The conducted power at the terminals of the dipole is measured. The ERP is recorded.

6. Test Data (Continued)

6.1 CELLULAR CDMA Radiated Measurements

Field Strength of SPURIOUS Radiation

■ OPERATING FREQUENCY:	824.70 MHz
■ CHANNEL:	1013 (Low)
■ MEASURED OUTPUT POWER:	22.47 dBm = 0.176 W
■ MODULATION SIGNAL:	CDMA (Internal)
■ DISTANCE:	3 m
■ LIMIT: - (43 + 10 log ₁₀ (W)) =	- 35.45 dBc

Freq. (MHz)	LEVEL @ ANTENNA TERMINALS (dBm)	SUBSTITUTE ANTENNA GAIN (dBd)	CORRECT GENERATOR LEVEL (dBm)	POL (H/V)	(dBc)
1 649.40	- 51.61	7.3	- 44.31	V	- 61.5
2 474.10	- 64.74	8.3	- 56.44	V	- 73.1
3 298.80	- 64.21	9.7	- 54.51	V	- 70.3

NOTES:

Radiated Spurious Emission Measurements by Substitution Method
according to ANSI/TIA/EIA-603-C-2004, Aug. 17, 2004:

The EUT was placed on a wooden turn table 3-meters from the receive antenna. The receive antenna height and turntable rotation was adjusted for the highest reading on the receive spectrum analyzer. For CDMA signals, a peak detector is used, with RBW = VBW = 3 MHz. For AMPS, GSM, and NADC TDMA signals, a peak detector is used, with RBW = VBW = 1 MHz. A half-wave dipole was substituted in place of the EUT. This dipole antenna was driven by a signal generator and the level of the signal generator was adjusted to obtain the same receive spectrum analyzer reading. This spurious level is recorded. For readings above 1 GHz, the above procedure is repeated using horn antennas and the difference between the gain of the horn and an isotropic or dipole antenna are taken into consideration.

6. Test Data (Continued)

6.2 CELLULAR CDMA Radiated Measurements

Field Strength of SPURIOUS Radiation

■ OPERATING FREQUENCY:	836.52 MHz
■ CHANNEL:	384 (Middle)
■ MEASURED OUTPUT POWER:	22.47 dBm = 0.176 W
■ MODULATION SIGNAL:	CDMA (Internal)
■ DISTANCE:	3 m
■ LIMIT: - (43 + 10 log ₁₀ (W)) =	- 35.45 dBc

Freq. (MHz)	LEVEL @ ANTENNA TERMINALS (dBm)	SUBSTITUTE ANTENNA GAIN (dBd)	CORRECT GENERATOR LEVEL (dBm)	POL (H/V)	(dBc)
1 671.78	- 62.42	7.3	- 55.12	V	- 72.3
2 507.67	- 67.51	8.3	- 59.21	V	- 75.9
3 343.56	- 71.12	9.7	- 61.42	V	- 77.2

NOTES:

Radiated Spurious Emission Measurements by Substitution Method
according to ANSI/TIA/EIA-603-C-2004, Aug. 17, 2004:

The EUT was placed on a wooden turn table 3-meters from the receive antenna. The receive antenna height and turntable rotation was adjusted for the highest reading on the receive spectrum analyzer. For CDMA signals, a peak detector is used, with RBW = VBW = 3 MHz. For AMPS, GSM, and NADC TDMA signals, a peak detector is used, with RBW = VBW = 1 MHz. A half-wave dipole was substituted in place of the EUT. This dipole antenna was driven by a signal generator and the level of the signal generator was adjusted to obtain the same receive spectrum analyzer reading. This spurious level is recorded. For readings above 1 GHz, the above procedure is repeated using horn antennas and the difference between the gain of the horn and an isotropic or dipole antenna are taken into consideration.

6. Test Data (Continued)

6.3 CELLULAR CDMA Radiated Measurements

Field Strength of SPURIOUS Radiation

■ OPERATING FREQUENCY:	848.31 MHz
■ CHANNEL:	777 (High)
■ MEASURED OUTPUT POWER:	22.47 dBm = 0.176 W
■ MODULATION SIGNAL:	CDMA (Internal)
■ DISTANCE:	3 m
■ LIMIT: - (43 + 10 log ₁₀ (W)) =	- 35.45 dBc

Freq. (MHz)	LEVEL @ ANTENNA TERMINALS (dBm)	SUBSTITUTE ANTENNA GAIN (dBd)	CORRECT GENERATOR LEVEL (dBm)	POL (H/V)	(dBc)
1 696.62	- 65.91	7.3	- 58.61	V	- 75.8
2 544.93	- 69.32	8.3	- 61.02	V	- 77.7
3 393.24	- 67.84	9.7	- 58.14	V	- 73.9

NOTES:

Radiated Spurious Emission Measurements by Substitution Method
according to ANSI/TIA/EIA-603-C-2004, Aug. 17, 2004:

The EUT was placed on a wooden turn table 3-meters from the receive antenna. The receive antenna height and turntable rotation was adjusted for the highest reading on the receive spectrum analyzer. For CDMA signals, a peak detector is used, with RBW = VBW = 3 MHz. For AMPS, GSM, and NADC TDMA signals, a peak detector is used, with RBW = VBW = 1 MHz. A half-wave dipole was substituted in place of the EUT. This dipole antenna was driven by a signal generator and the level of the signal generator was adjusted to obtain the same receive spectrum analyzer reading. This spurious level is recorded. For readings above 1 GHz, the above procedure is repeated using horn antennas and the difference between the gain of the horn and an isotropic or dipole antenna are taken into consideration.

7. Test Data

7.1 FREQUENCY STABILITY (CDMA)

OPERATING FREQUENCY: 836,520,000 Hz
 CHANNEL: 384
 DEVIATION LIMIT: ± 0.000 25 % or 2.5 ppm

Voltage (%)	Power (VDC)	Temp. (°C)	Frequency (Hz)	Frequency Error (Hz)	Deviation (%)	ppm
100%	3.70	+20(Ref)	836,519,980	-20	-0.000002	-0.011
100%		-30	836,520,018	18	0.000002	0.010
100%		-20	836,520,015	15	0.000002	0.008
100%		-10	836,519,979	-21	-0.000003	-0.011
100%		0	836,519,990	-10	-0.000001	-0.005
100%		+10	836,520,028	28	0.000003	0.015
100%		+20	836,519,980	-20	-0.000002	-0.011
100%		+30	836,519,988	-12	-0.000001	-0.006
100%		+40	836,520,100	100	0.000012	0.053
100%		+50	836,520,027	27	0.000003	0.014
115%	4.26	+20	836,520,026	26	0.000003	0.014
Batt. Endpoint	3.21	+20	836,519,973	-27	-0.000003	-0.014

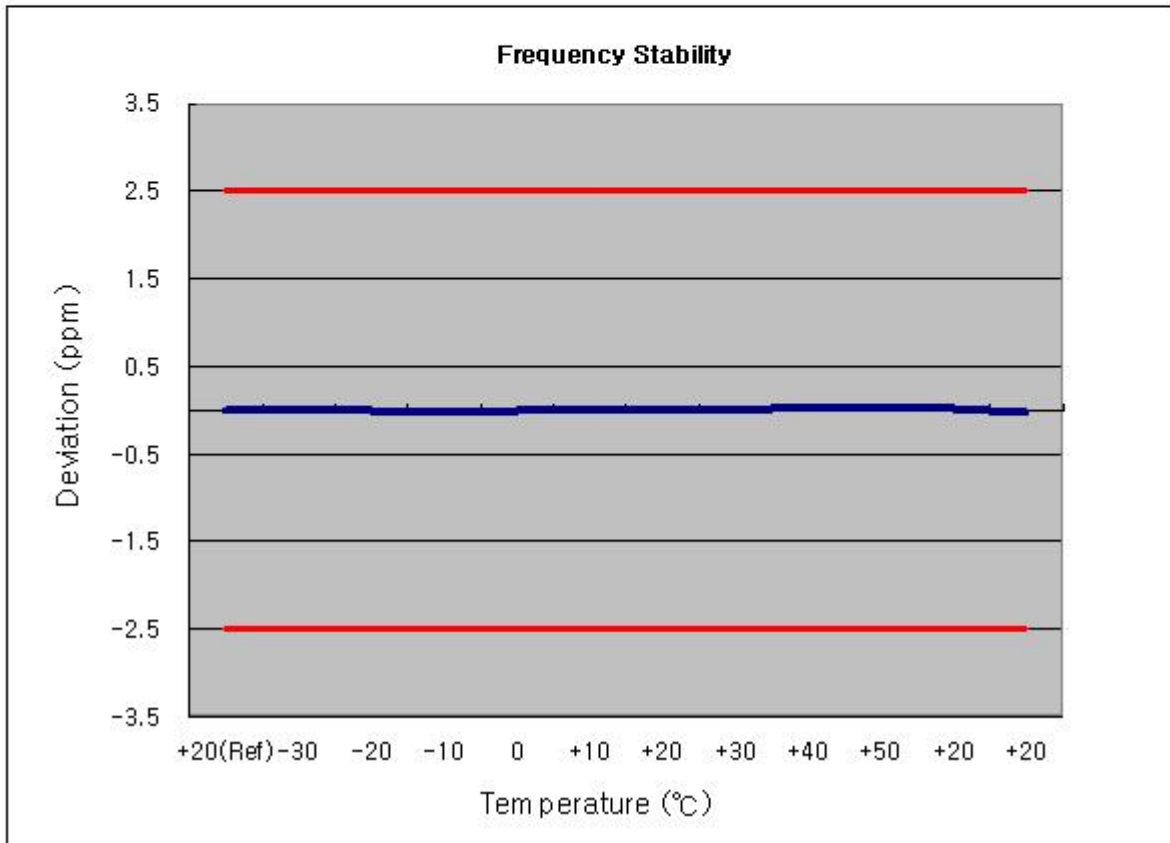

8. LIST OF TEST EQUIPMENT

Manufacture	Model/ Equipment	Serial Number	Calibration Date	Calibration Interval	Calibration Due
R&S	ES140/ Spectrum Analyzer	831564/003	11/06/2007	Annual	11/06/2008
Advantest	R3273/ Spectrum Analyzer	J04821	03/15/2007	Annual	03/15/2008
HP	8664A/ Signal Generator	3744A02069	04/10/2007	Annual	04/10/2008
Agilent	E4416A/ Power Meter	GB41291412	01/22/2007	Annual	01/22/2008
Agilent	E9327A/ Power Sensor	US40440910	01/24/2007	Annual	01/24/2008
Agilent	HP8901B/ Modulation Analyzer	3438A05231	08/04/2007	Annual	08/04/2008
Agilent	8903A/ Audio Analyzer	2433A04322	08/04/2007	Annual	08/04/2008
R&S	CMU200/ Base Station	839117/011	01/28/2007	Annual	01/28/2008
Agilent	8960 (E5515C)/ Base Station	GB44400269	02/11/2007	Annual	02/11/2008
Tescom	TC-3000/ Bluetooth Simulator	3000A4900112	01/22/2007	Annual	01/22/2008
MITEQ	AMF-6D-01180-35-20P/ AMP	990893	02/24/2007	Annual	02/24/2008
Wainwright	WHK1.2/15G-10EF/H.P.F	2	06/28/2007	Annual	06/28/2008
Wainwright	WHK3.3/18G-10EF/H.P.F	1	06/28/2007	Annual	06/28/2008
Agilent	778D/ Dual Directional Coupler	16072	11/09/2007	Annual	11/09/2008
Agilent	1506A/ Power Divider	99441	11/10/2007	Annual	11/10/2008
Digital	EP-3010/ Power Supply	3110117	12/29/2007	Annual	12/29/2008
Schwarzbeck	UHAP/ Dipole Antenna	630	11/13/2007	Annual	11/13/2008
Schwarzbeck	UHAP/ Dipole Antenna	605	11/13/2007	Annual	11/13/2008
R&S	HFH2-Z2/ Loop Antenna	881056/070	12/11/2007	Annual	12/11/2008
Schwarzbeck	VULB9160/ TRILOG Antenna	3150	03/19/2007	Annual	03/19/2008
Schwarzbeck	VULB9160/ TRILOG Antenna	4150	01/23/2007	Annual	01/23/2008
Korea Engineering	KR-1005L / Chamber	KRAB07063-2CH	01/08/2007	Annual	01/08/2008
Schwarzbeck	BBHA 9120D/ Horn Antenna	147	03/31/2007	Biennial	03/31/2008
Schwarzbeck	BBHA 9120D/ Horn Antenna	1201	05/02/2007	Biennial	05/02/2008

9. SAMPLE CALCULATIONS

A. ERP Sample Calculation

Freq. Tuned (MHz)	LEVEL(1) (dBm)	POL (H/V)	ERP (W)	ERP(2) (dBm)	BATTERY
824.70	- 24.68	V	0.176	22.47	Standard

- 1) The EUT mounted on a wooden tripod is 0.8 meter above test site ground level.
- 2) During the test , the turn table is rotated and the antenna height is also varied from 1 to 4 meters until the maximum signal is found.
- 3) Record the field strength meter's level.(**LEVEL**)
- 4) Replace the EUT with dipole antenna that is connected to a calibrated signal generator.
- 5) Increase the signal generator output till the field strength meter's level is equal to the item(3).
- 6) The signal generator output level with cable loss is the rating of effective radiated power(**ERP**).
(Cable loss means the factor between Signal Generator and Transmitting Antenna.)

For more details, please refer to the test set-up procedure.

B. Emission Designator

Emission Designator = 1M28F9W

CDMA BW = 1.28MHz

F = Frequency Modulation

9 = Composite Digital Info

W = Combination (Audio/Data)

(Measured at the 99.75 % power bandwidth)

10. CONCLUSION

The data collected shows that the Single -Band CDMA Phone (CDMA835) **FCC ID: BEJRD6100** complies with all the requirements of Parts 22 of the FCC rules.

11. TEST PLOTS

■ CDMA MODE (1013 CH.) Conducted Spurious

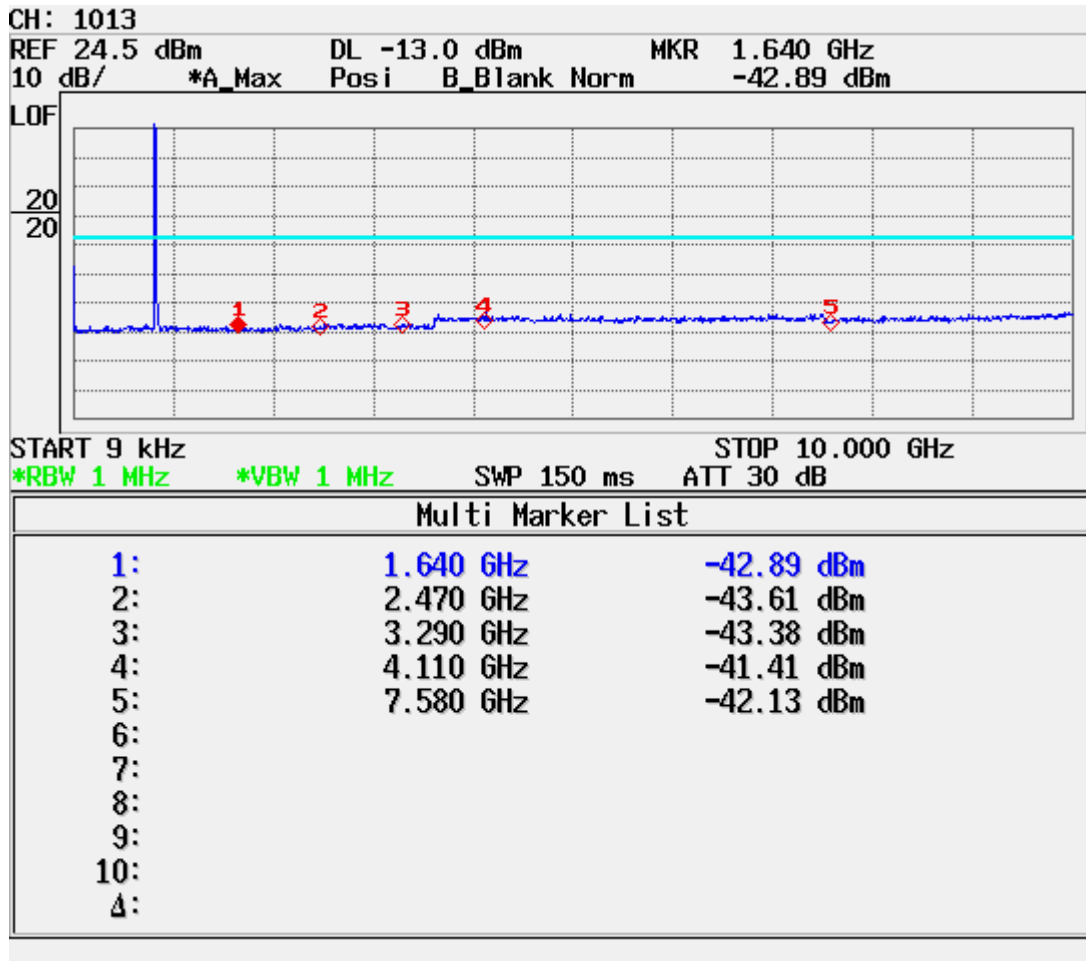

■ CDMA MODE (384 CH.) Conducted Spurious

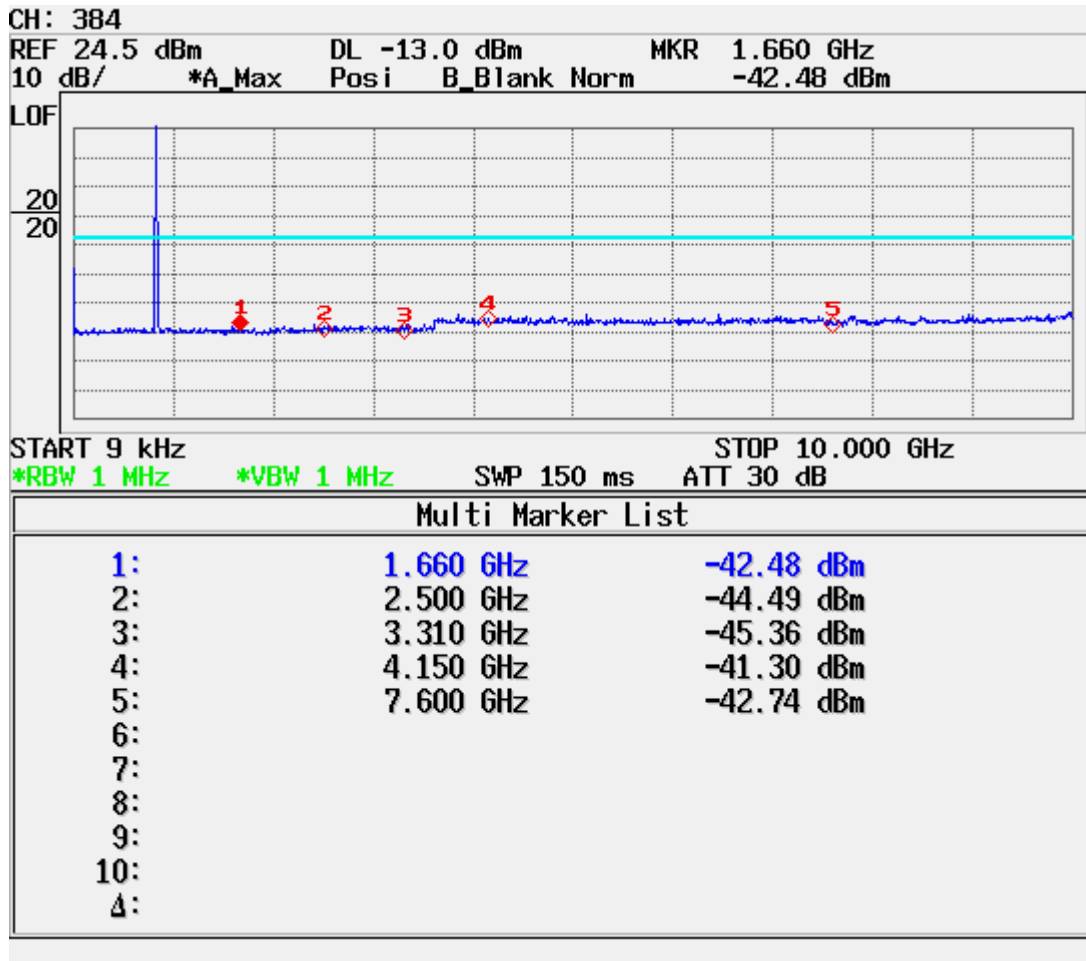

■ CDMA MODE (777 CH.) Conducted Spurious

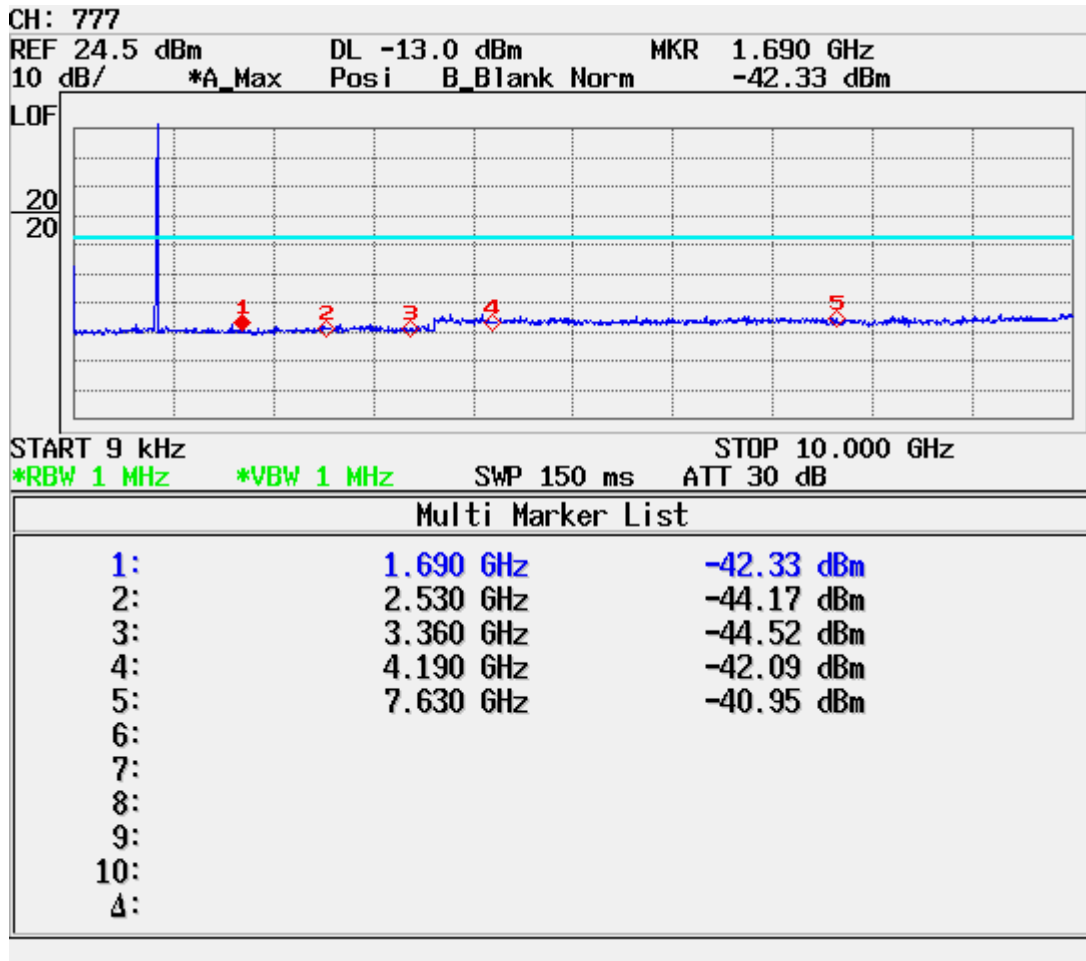

■ CDMA MODE (1013 CH.) : Channel Power

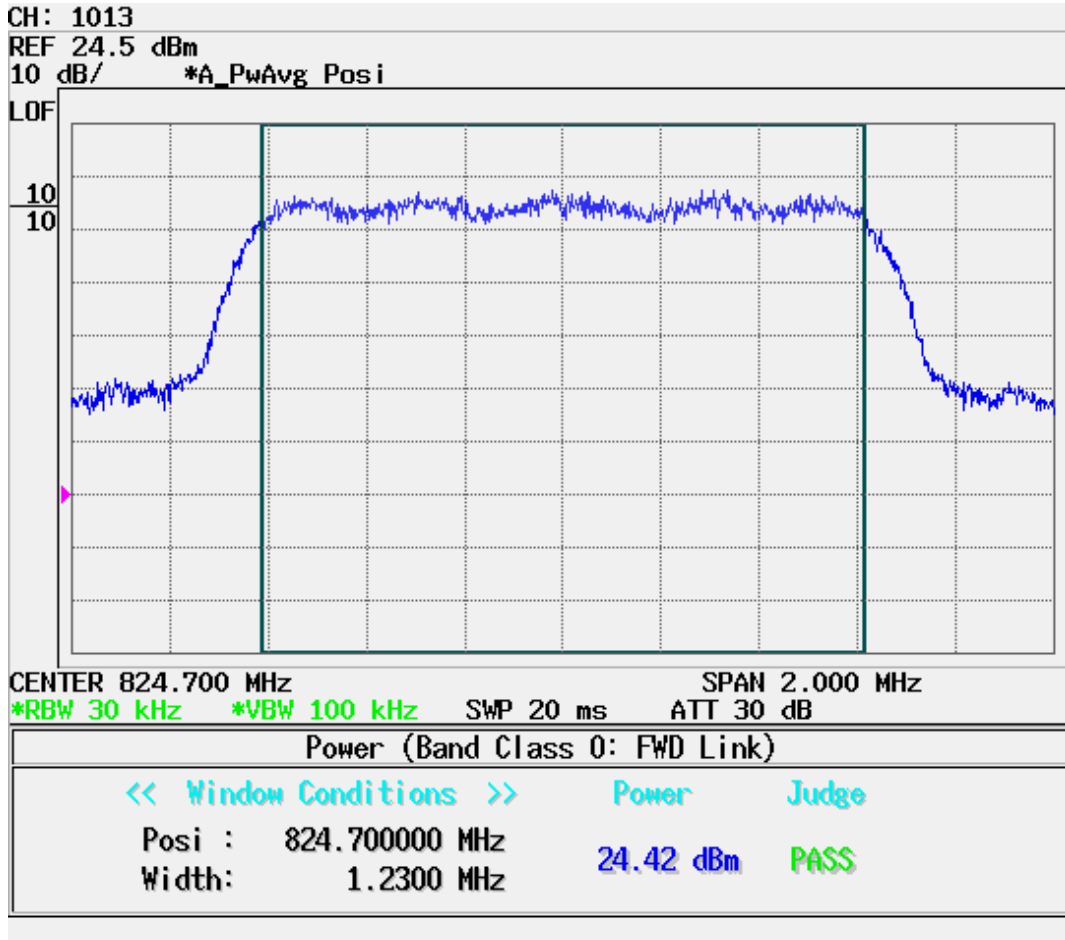

■ PCS CDMA MODE (384 CH.) : Channel Power

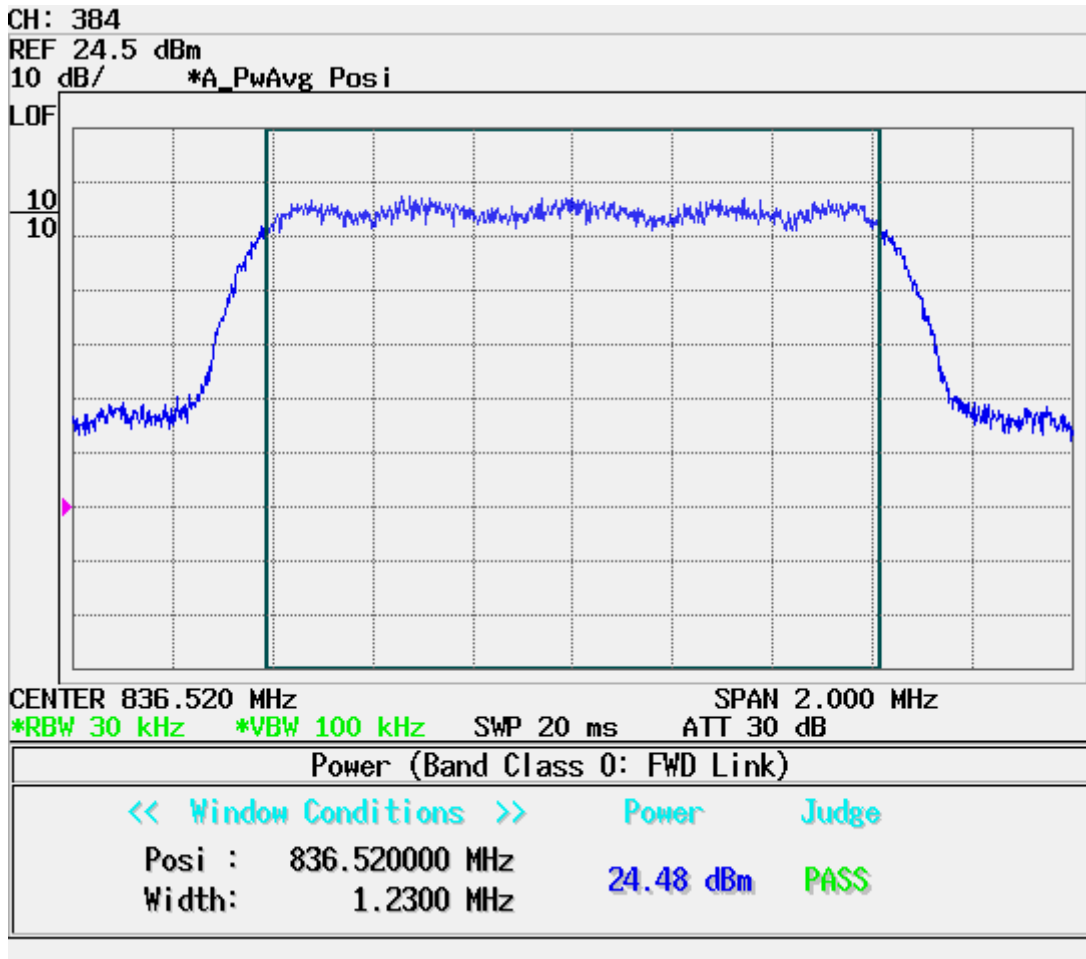

■ CDMA MODE (777 CH.) : Channel Power

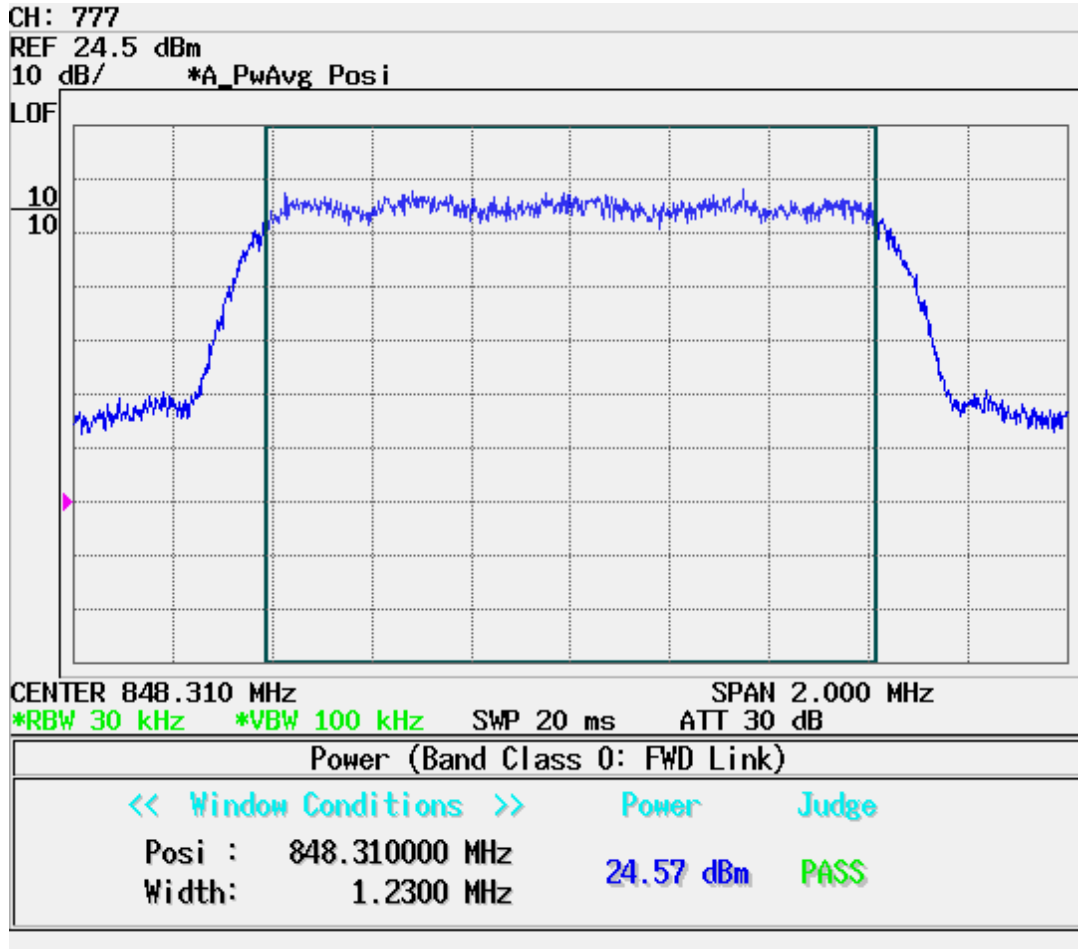

■ CDMA Mode (1013 CH.) : Occupied Bandwidth

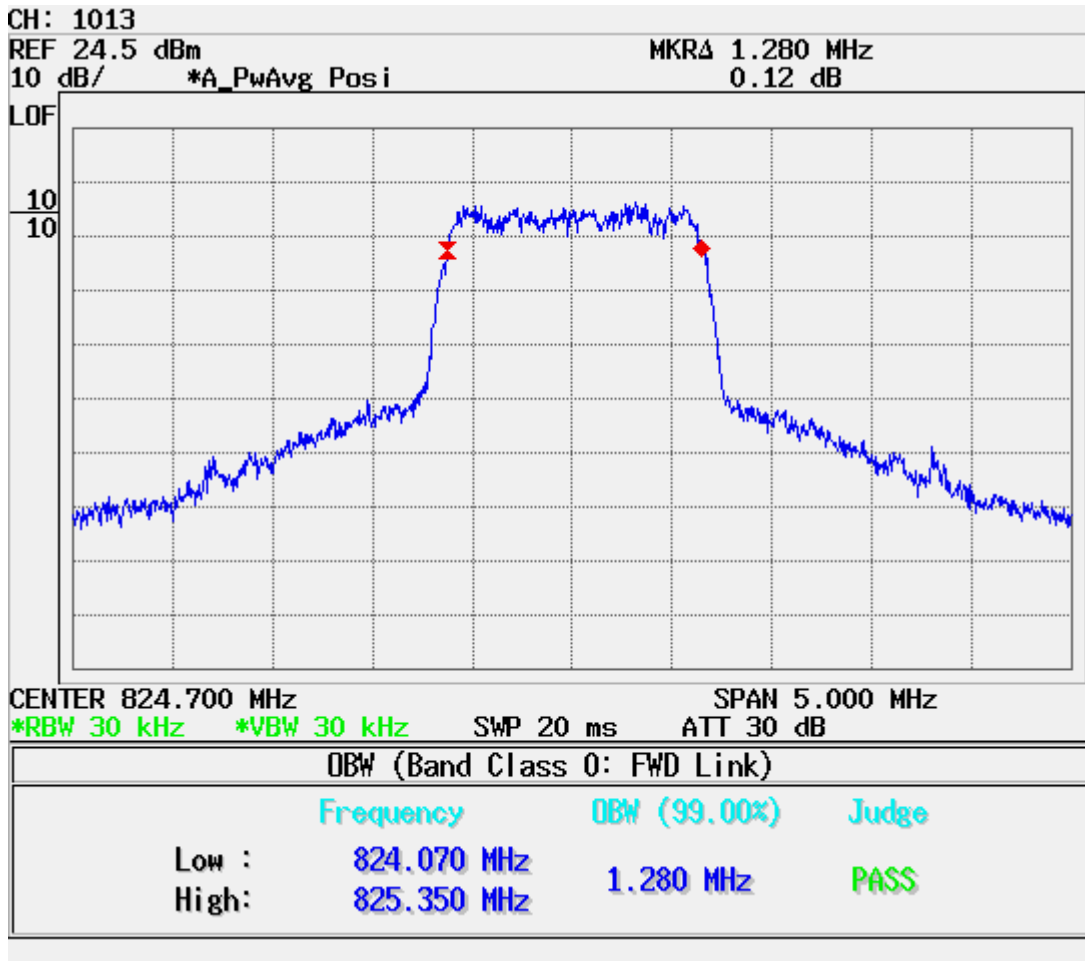

■ CDMA Mode (384 CH.) : Occupied Bandwidth

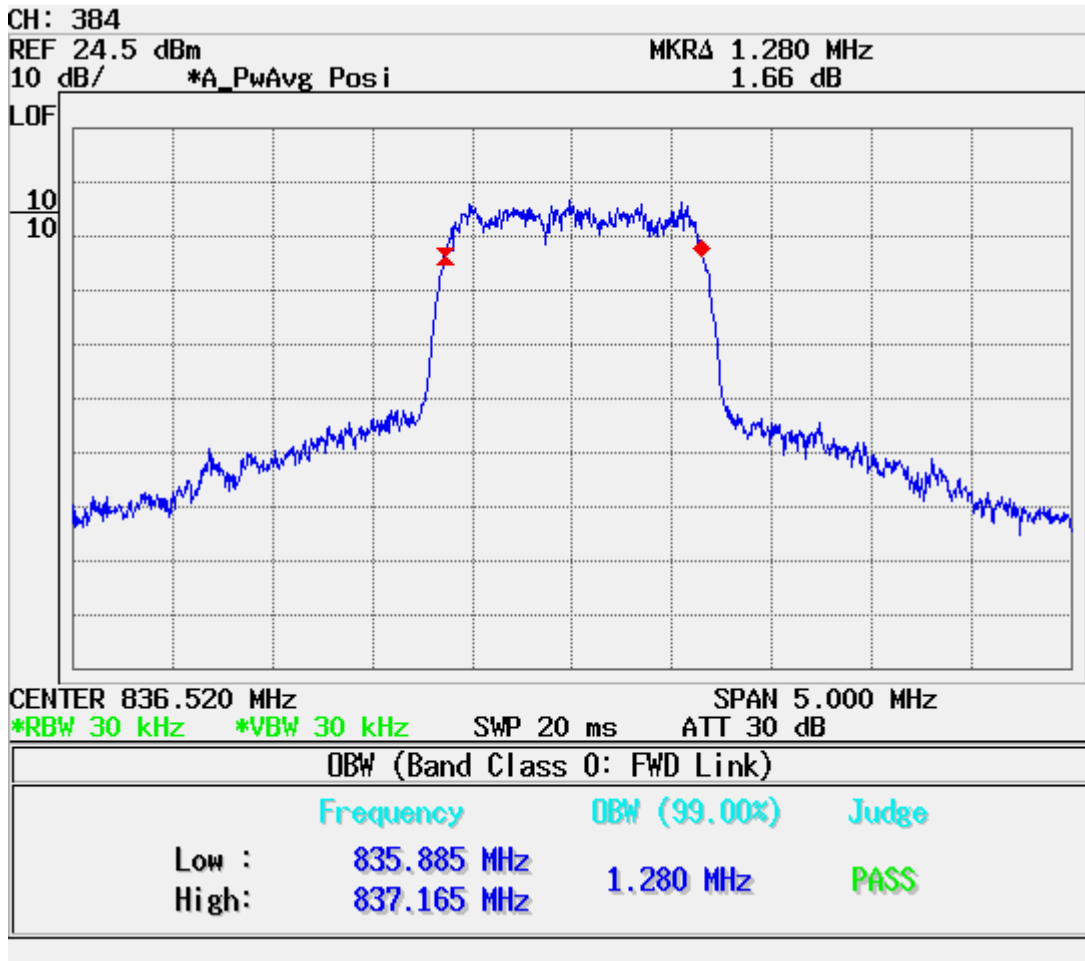

■ CDMA Mode (777.) : Occupied Bandwidth

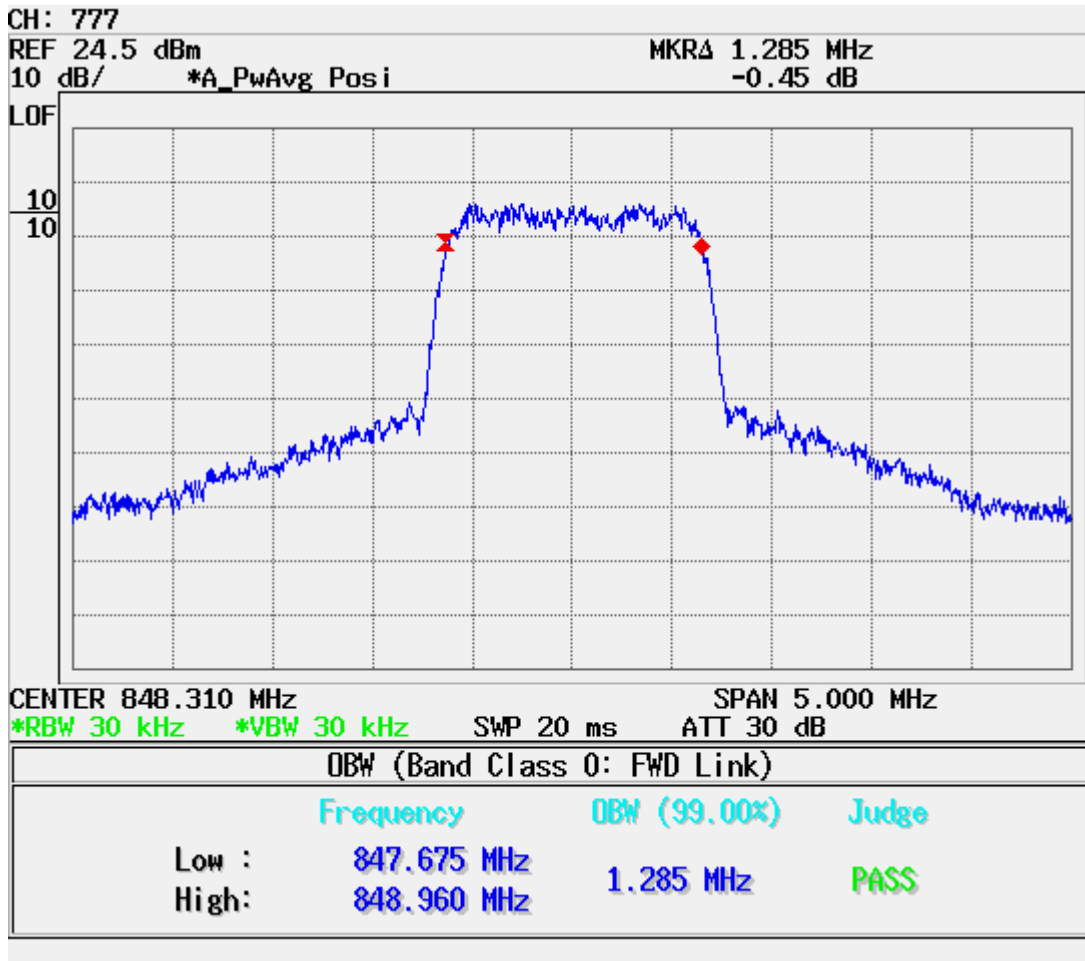

■ CDMA Cellular (1013) Band Edge

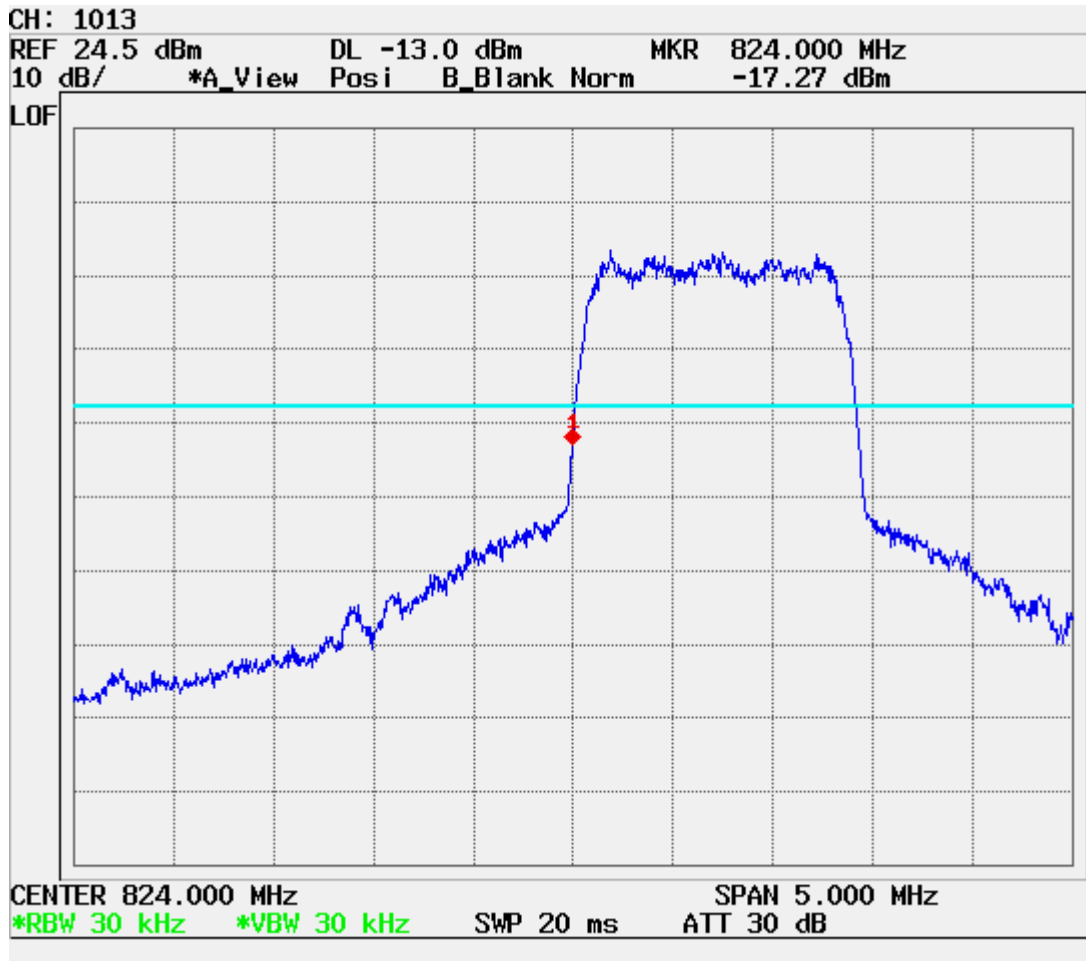

■ CDMA Cellular (777 CH.) Band Edge

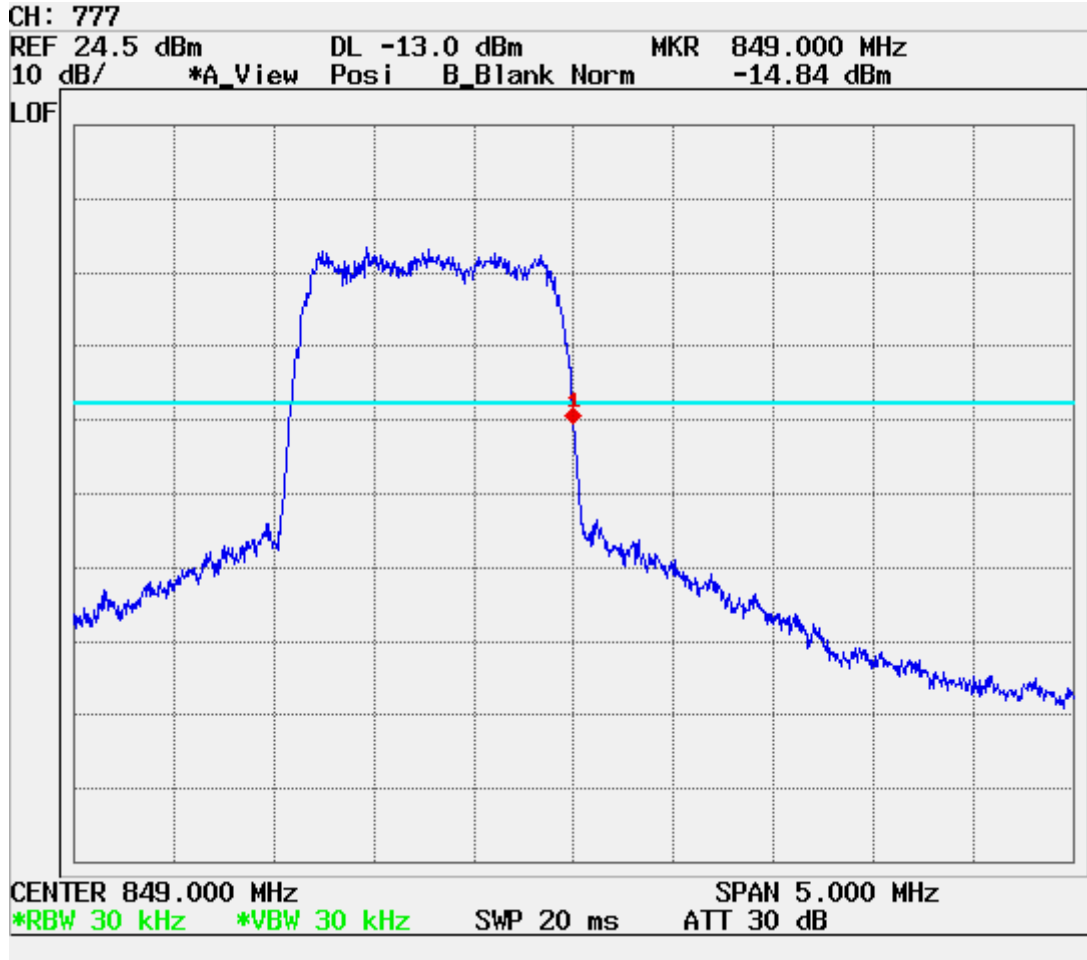

■ CDMA (1013 CH) : SPURIOUS EMISSION - RECEIVER OPERATING

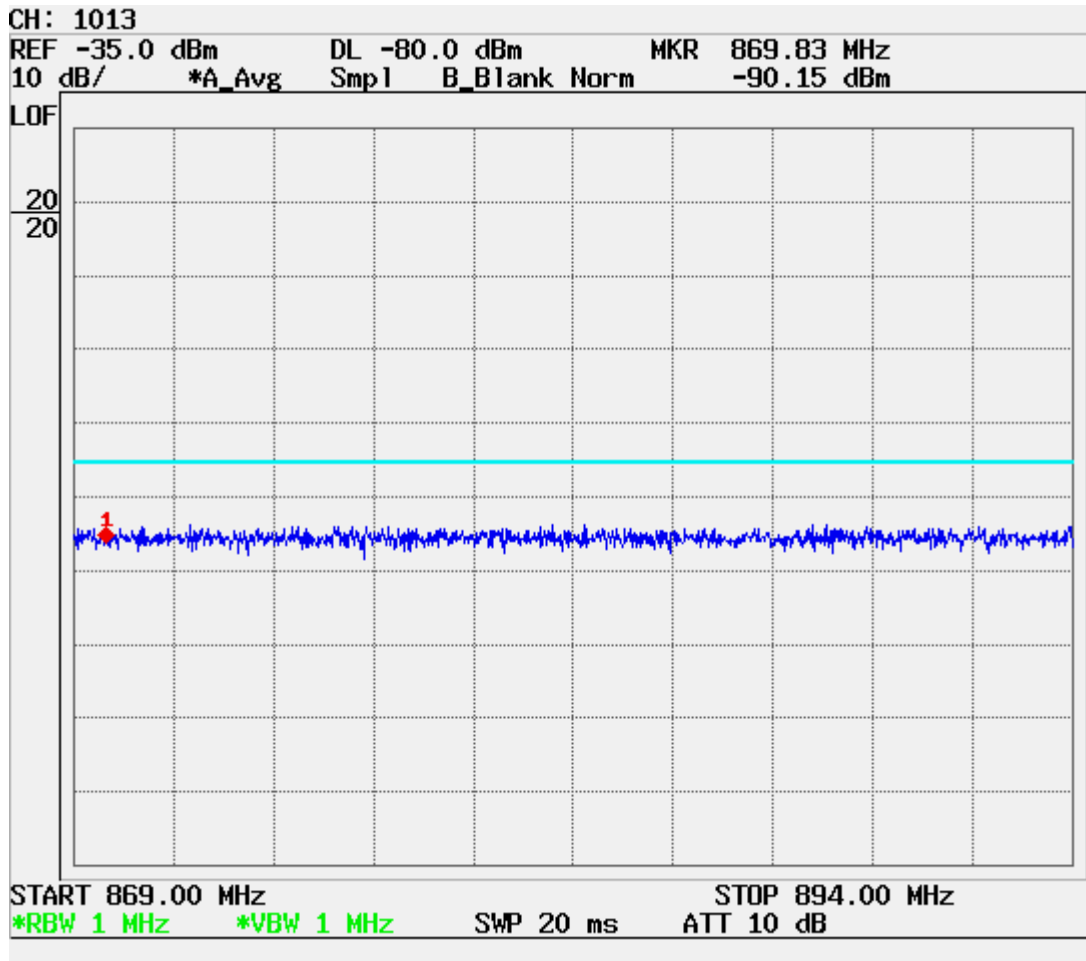

■ CDMA (384 CH) : SPURIOUS EMISSION - RECEIVER OPERATING

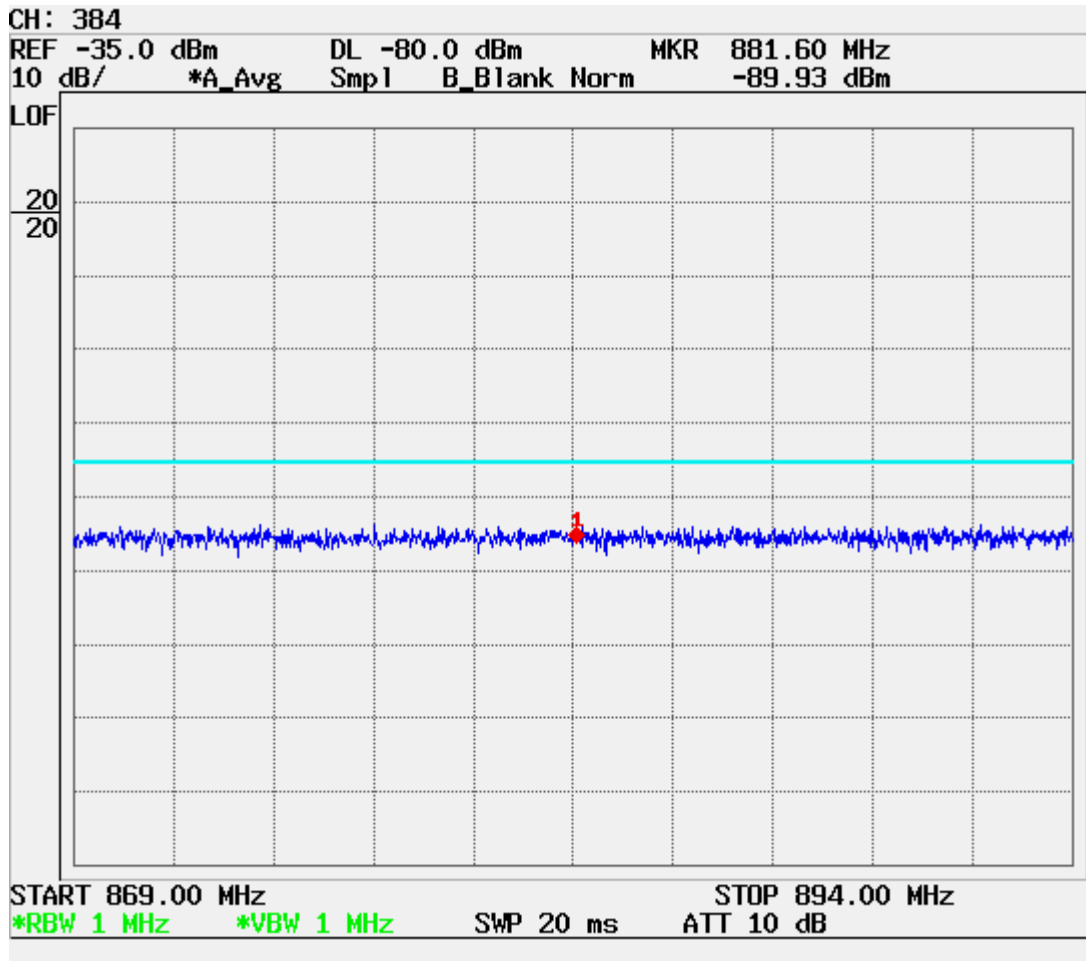

■ **CDMA (777 CH) : SPURIOUS EMISSION - RECEIVER OPERATING**

