

■ Dielectric Parameter (835 MHz Body)

Title LG-P500h
SubTitle GSM850(Body)
Test Date Aug.23, 2010

Frequency	e'	e''
800000000	57.0655	21.3476
805000000	57.0193	21.3257
810000000	56.9925	21.3030
815000000	57.0272	21.2470
820000000	56.9955	21.2364
825000000	56.9650	21.1840
830000000	56.9131	21.1485
835000000	56.9337	21.1594
840000000	56.8805	21.1252
845000000	56.7913	21.0487
850000000	56.7677	21.0305
855000000	56.6509	21.0118
860000000	56.5864	20.9329
865000000	56.5663	20.9764
870000000	56.4755	20.9096
875000000	56.3757	20.8712
880000000	56.2814	20.8394
885000000	56.2690	20.8177
890000000	56.2418	20.8136
895000000	56.1048	20.7916
900000000	56.1031	20.8036

■ Dielectric Parameter (1900 MHz Head)

Title LG-P500h
SubTitle WCDMA1900(Head)
Test Date Aug.24, 2010

Frequency	e'	e''
1800000000	41.1955	12.9723
1810000000	41.1733	13.0123
1820000000	41.1589	13.0624
1830000000	41.1394	13.1402
1840000000	41.1113	13.1834
1850000000	41.0542	13.1844
1860000000	40.9936	13.2063
1870000000	40.9510	13.2349
1880000000	40.8780	13.2292
1890000000	40.8221	13.2248
1900000000	40.7303	13.2326
1910000000	40.6910	13.2451
1920000000	40.6719	13.2593
1930000000	40.6538	13.3088
1940000000	40.6248	13.3446
1950000000	40.6305	13.3418
1960000000	40.6606	13.3908
1970000000	40.6422	13.4369
1980000000	40.6428	13.4697
1990000000	40.5766	13.5074
2000000000	40.5028	13.5238

■ Dielectric Parameter (1900 MHz Body)

Title LG-P500h
SubTitle WCDMA1900(Body)
Test Date Aug.24, 2010

Frequency	e'	e''
1850000000	53.7690	14.0616
1855000000	53.7719	14.0479
1860000000	53.8245	14.0752
1865000000	53.7647	14.1069
1870000000	53.7622	14.0937
1875000000	53.7066	14.1325
1880000000	53.6836	14.1595
1885000000	53.6576	14.1542
1890000000	53.6010	14.1882
1895000000	53.5784	14.1951
1900000000	53.5563	14.2019
1905000000	53.5275	14.2363
1910000000	53.4898	14.2431
1915000000	53.4643	14.2733
1920000000	53.4369	14.3153
1925000000	53.4259	14.3405
1930000000	53.4005	14.3426
1935000000	53.4112	14.3725
1940000000	53.4079	14.4038
1945000000	53.4012	14.4324
1950000000	53.4126	14.4240

■ Dielectric Parameter (2450 MHz Body)

Title LG-P500h
SubTitle 2450 MHz (Body)
Test Date Aug.24, 2010

Frequency	e'	e''
2400000000	52.0168	14.0744
2405000000	52.0147	14.0877
2410000000	51.9387	14.1225
2415000000	51.9064	14.0991
2420000000	51.8694	14.1493
2425000000	51.8449	14.1913
2430000000	51.8164	14.2238
2435000000	51.7976	14.2517
2440000000	51.7686	14.2890
2445000000	51.7315	14.3255
2450000000	51.7672	14.3599
2455000000	51.7318	14.3912
2460000000	51.7191	14.4310
2465000000	51.7048	14.4281
2470000000	51.6720	14.5132
2475000000	51.6572	14.5298
2480000000	51.6705	14.5561
2485000000	51.6442	14.5543
2490000000	51.6380	14.5795
2495000000	51.6245	14.5841
2500000000	51.6386	14.6097

Attachment 3. – Probe Calibration Data

Calibration Laboratory of
Schmid & Partner
Engineering AG
Zeughausstrasse 43, 8004 Zurich, Switzerland



S Schweizerischer Kalibrierdienst
C Service suisse d'étalonnage
S Servizio svizzero di taratura
S Swiss Calibration Service

Accredited by the Swiss Accreditation Service (SAS)
The Swiss Accreditation Service is one of the signatories to the EA
Multilateral Agreement for the recognition of calibration certificates

Accreditation No.: **SCS 108**

Client **HCT (Dymstec)**

Certificate No: **ES3-3161_Mar10**

CALIBRATION CERTIFICATE

Object **ES3DV3 - SN:3161**

Calibration procedure(s) **QA CAL-01.v6, QA CAL-12.v6, QA CAL-23.v3 and QA CAL-25.v2
Calibration procedure for dosimetric E-field probes**

Calibration date: **March 22, 2010**

This calibration certificate documents the traceability to national standards, which realize the physical units of measurements (SI).
The measurements and the uncertainties with confidence probability are given on the following pages and are part of the certificate.

All calibrations have been conducted in the closed laboratory facility: environment temperature (22 ± 3)°C and humidity < 70%.

Calibration Equipment used (M&TE critical for calibration)

Primary Standards	ID #	Cal Date (Certificate No.)	Scheduled Calibration
Power meter E4419B	GB41293874	1-Apr-09 (No. 217-01030)	Apr-10
Power sensor E4412A	MY41495277	1-Apr-09 (No. 217-01030)	Apr-10
Power sensor E4412A	MY41498087	1-Apr-09 (No. 217-01030)	Apr-10
Reference 3 dB Attenuator	SN: S5054 (3c)	31-Mar-09 (No. 217-01026)	Mar-10
Reference 20 dB Attenuator	SN: S5086 (20b)	31-Mar-09 (No. 217-01028)	Mar-10
Reference 30 dB Attenuator	SN: S5129 (30b)	31-Mar-09 (No. 217-01027)	Mar-10
Reference Probe ES3DV2	SN: 3013	30-Dec-09 (No. ES3-3013_Dec09)	Dec-10
DAE4	SN: 660	29-Sep-09 (No. DAE4-660_Sep09)	Sep-10

Secondary Standards	ID #	Check Date (in house)	Scheduled Check
RF generator HP 8648C	US3642U01700	4-Aug-99 (in house check Oct-09)	In house check: Oct-11
Network Analyzer HP 8753E	US37390585	18-Oct-01 (in house check Oct-09)	In house check: Oct10

	Name	Function	Signature
Calibrated by:	Jeton Kastrati	Laboratory Technician	
Approved by:	Katja Pokovic	Technical Manager	

Issued: March 25, 2010

This calibration certificate shall not be reproduced except in full without written approval of the laboratory.

**Calibration Laboratory of
Schmid & Partner
Engineering AG**
Zeughausstrasse 43, 8004 Zurich, Switzerland



S Schweizerischer Kalibrierdienst
C Service suisse d'étalonnage
S Servizio svizzero di taratura
S Swiss Calibration Service

Accredited by the Swiss Accreditation Service (SAS)
The Swiss Accreditation Service is one of the signatories to the EA
Multilateral Agreement for the recognition of calibration certificates

Accreditation No.: SCS 108

Glossary:

TSL	tissue simulating liquid
NORM _{x,y,z}	sensitivity in free space
ConvF	sensitivity in TSL / NORM _{x,y,z}
DCP	diode compression point
CF	crest factor (1/duty_cycle) of the RF signal
A, B, C	modulation dependent linearization parameters
Polarization ϕ	ϕ rotation around probe axis
Polarization ϑ	ϑ rotation around an axis that is in the plane normal to probe axis (at measurement center), i.e., $\vartheta = 0$ is normal to probe axis

Calibration is Performed According to the Following Standards:

- a) IEEE Std 1528-2003, "IEEE Recommended Practice for Determining the Peak Spatial-Averaged Specific Absorption Rate (SAR) in the Human Head from Wireless Communications Devices: Measurement Techniques", December 2003
- b) IEC 62209-1, "Procedure to measure the Specific Absorption Rate (SAR) for hand-held devices used in close proximity to the ear (frequency range of 300 MHz to 3 GHz)", February 2005

Methods Applied and Interpretation of Parameters:

- *NORM_{x,y,z}*: Assessed for E-field polarization $\vartheta = 0$ ($f \leq 900$ MHz in TEM-cell; $f > 1800$ MHz: R22 waveguide). *NORM_{x,y,z}* are only intermediate values, i.e., the uncertainties of *NORM_{x,y,z}* does not effect the E^2 -field uncertainty inside TSL (see below *ConvF*).
- *NORM(f)_{x,y,z}* = *NORM_{x,y,z}* * *frequency_response* (see Frequency Response Chart). This linearization is implemented in DASY4 software versions later than 4.2. The uncertainty of the frequency response is included in the stated uncertainty of *ConvF*.
- *DCP_{x,y,z}*: DCP are numerical linearization parameters assessed based on the data of power sweep with CW signal (no uncertainty required). DCP does not depend on frequency nor media.
- *A_{x,y,z}*; *B_{x,y,z}*; *C_{x,y,z}*; *VR_{x,y,z}*: *A*, *B*, *C* are numerical linearization parameters assessed based on the data of power sweep for specific modulation signal. The parameters do not depend on frequency nor media. *VR* is the maximum calibration range expressed in RMS voltage across the diode.
- *ConvF* and *Boundary Effect Parameters*: Assessed in flat phantom using E-field (or Temperature Transfer Standard for $f \leq 800$ MHz) and inside waveguide using analytical field distributions based on power measurements for $f > 800$ MHz. The same setups are used for assessment of the parameters applied for boundary compensation (alpha, depth) of which typical uncertainty values are given. These parameters are used in DASY4 software to improve probe accuracy close to the boundary. The sensitivity in TSL corresponds to *NORM_{x,y,z}* * *ConvF* whereby the uncertainty corresponds to that given for *ConvF*. A frequency dependent *ConvF* is used in DASY version 4.4 and higher which allows extending the validity from ± 50 MHz to ± 100 MHz.
- *Spherical isotropy (3D deviation from isotropy)*: in a field of low gradients realized using a flat phantom exposed by a patch antenna.
- *Sensor Offset*: The sensor offset corresponds to the offset of virtual measurement center from the probe tip (on probe axis). No tolerance required.

ES3DV3 SN:3161

March 22, 2010

Probe ES3DV3

SN:3161

Manufactured:	October 8, 2007
Last calibrated:	July 22, 2009
Recalibrated:	March 22, 2010

Calibrated for DASYS Systems

(Note: non-compatible with DASYS2 system!)

ES3DV3 SN:3161

March 22, 2010

DASY - Parameters of Probe: ES3DV3 SN:3161
Basic Calibration Parameters

	Sensor X	Sensor Y	Sensor Z	Unc (k=2)
Norm ($\mu\text{V}/(\text{V}/\text{m})^2$) ^A	1.11	1.27	1.21	$\pm 10.1\%$
DCP (mV) ^B	89.6	92.5	91.0	

Modulation Calibration Parameters

UID	Communication System Name	PAR		A dB	B dBuV	C	VR mV	Unc ^E (k=2)
10000	CW	0.00	X	0.00	0.00	1.00	300.0	$\pm 1.5\%$
			Y	0.00	0.00	1.00	300.0	
			Z	0.00	0.00	1.00	300.0	

The reported uncertainty of measurement is stated as the standard uncertainty of measurement multiplied by the coverage factor k=2, which for a normal distribution corresponds to a coverage probability of approximately 95%.

^A The uncertainties of NormX,Y,Z do not affect the E²-field uncertainty inside TSL (see Pages 5 and 6).

^B Numerical linearization parameter: uncertainty not required.

^E Uncertainty is determined using the maximum deviation from linear response applying rectangular distribution and is expressed for the square of the field value.

ES3DV3 SN:3161

March 22, 2010

DASY - Parameters of Probe: ES3DV3 SN:3161

Calibration Parameter Determined in Head Tissue Simulating Media

f [MHz]	Validity [MHz] ^c	Permittivity	Conductivity	ConvF X	ConvF Y	ConvF Z	Alpha	Depth Unc (k=2)
450	± 50 / ± 100	43.5 ± 5%	0.87 ± 5%	6.23	6.23	6.23	0.24	1.47 ± 13.3%
835	± 50 / ± 100	41.5 ± 5%	0.90 ± 5%	5.96	5.96	5.96	0.82	1.12 ± 11.0%
900	± 50 / ± 100	41.5 ± 5%	0.97 ± 5%	5.82	5.82	5.82	0.74	1.17 ± 11.0%
1750	± 50 / ± 100	40.1 ± 5%	1.37 ± 5%	4.97	4.97	4.97	0.40	1.69 ± 11.0%
1900	± 50 / ± 100	40.0 ± 5%	1.40 ± 5%	4.79	4.79	4.79	0.42	1.63 ± 11.0%
1950	± 50 / ± 100	40.0 ± 5%	1.40 ± 5%	4.67	4.67	4.67	0.37	1.79 ± 11.0%
2300	± 50 / ± 100	39.5 ± 5%	1.67 ± 5%	4.54	4.54	4.54	0.34	2.02 ± 11.0%
2450	± 50 / ± 100	39.2 ± 5%	1.80 ± 5%	4.26	4.26	4.26	0.39	1.91 ± 11.0%
2600	± 50 / ± 100	39.0 ± 5%	1.96 ± 5%	4.22	4.22	4.22	0.53	1.57 ± 11.0%

^c The validity of ± 100 MHz only applies for DASY v4.4 and higher (see Page 2). The uncertainty is the RSS of the ConvF uncertainty at calibration frequency and the uncertainty for the indicated frequency band.

ES3DV3 SN:3161

March 22, 2010

DASY - Parameters of Probe: ES3DV3 SN:3161

Calibration Parameter Determined in Body Tissue Simulating Media

f [MHz]	Validity [MHz] ^c	Permittivity	Conductivity	ConvF X	ConvF Y	ConvF Z	Alpha	Depth Unc (k=2)
450	± 50 / ± 100	56.7 ± 5%	0.94 ± 5%	6.69	6.69	6.69	0.15	1.27 ± 13.3%
835	± 50 / ± 100	55.2 ± 5%	0.97 ± 5%	5.84	5.84	5.84	0.70	1.23 ± 11.0%
1750	± 50 / ± 100	53.4 ± 5%	1.49 ± 5%	4.74	4.74	4.74	0.34	2.11 ± 11.0%
1900	± 50 / ± 100	53.3 ± 5%	1.52 ± 5%	4.52	4.52	4.52	0.31	2.37 ± 11.0%
1950	± 50 / ± 100	53.3 ± 5%	1.52 ± 5%	4.64	4.64	4.64	0.35	2.18 ± 11.0%
2300	± 50 / ± 100	52.8 ± 5%	1.85 ± 5%	4.35	4.35	4.35	0.41	1.83 ± 11.0%
2450	± 50 / ± 100	52.7 ± 5%	1.95 ± 5%	4.17	4.17	4.17	0.77	1.17 ± 11.0%
2600	± 50 / ± 100	52.5 ± 5%	2.16 ± 5%	4.07	4.07	4.07	0.82	1.20 ± 11.0%

^c The validity of ± 100 MHz only applies for DASY v4.4 and higher (see Page 2). The uncertainty is the RSS of the ConvF uncertainty at calibration frequency and the uncertainty for the indicated frequency band.

ES3DV3 SN:3161

March 22, 2010

Frequency Response of E-Field

(TEM-Cell:ifi110 EXX, Waveguide: R22)

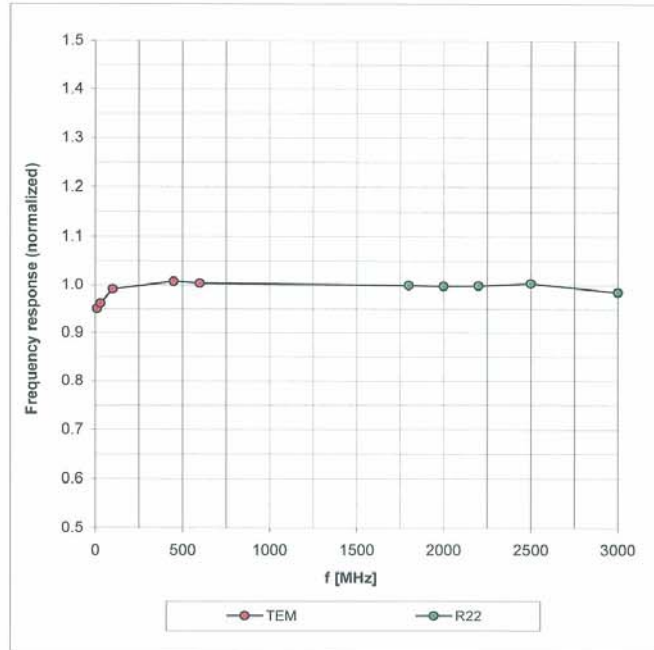

Uncertainty of Frequency Response of E-field: $\pm 6.3\%$ (k=2)

ES3DV3 SN:3161

March 22, 2010

Receiving Pattern (ϕ), $\vartheta = 0^\circ$

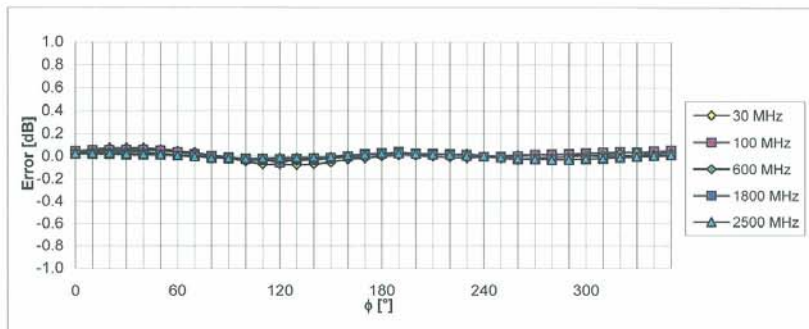
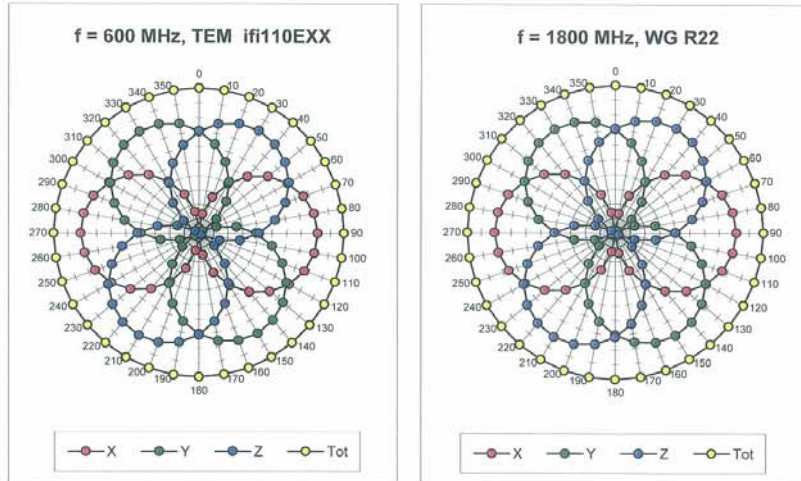

Uncertainty of Axial Isotropy Assessment: $\pm 0.5\%$ (k=2)

ES3DV3 SN:3161

March 22, 2010

Dynamic Range f(SAR_{head})
(Waveguide R22, f = 1800 MHz)

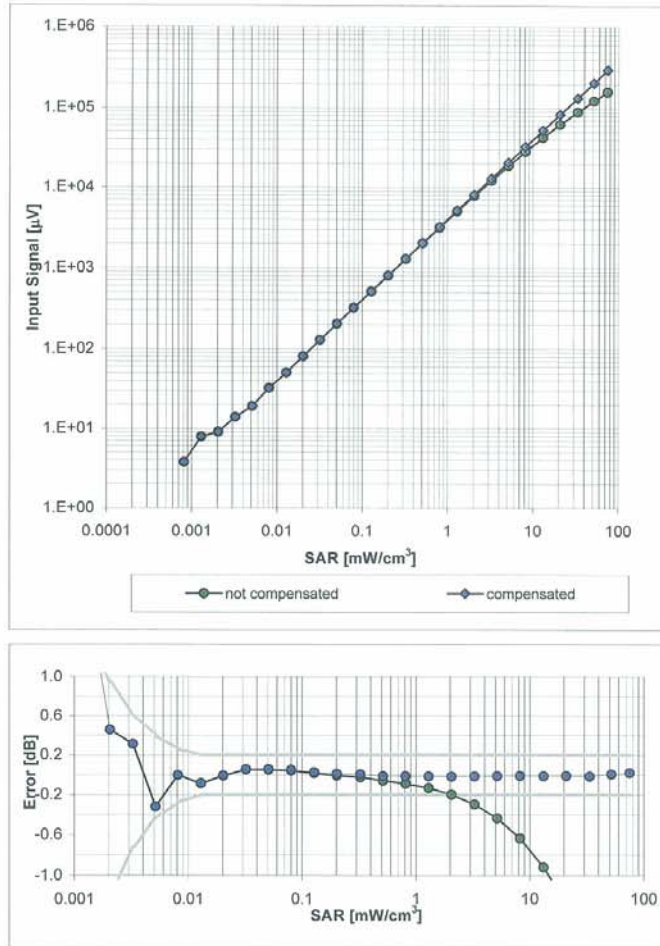

Uncertainty of Linearity Assessment: ± 0.6% (k=2)

ES3DV3 SN:3161

March 22, 2010

Conversion Factor Assessment

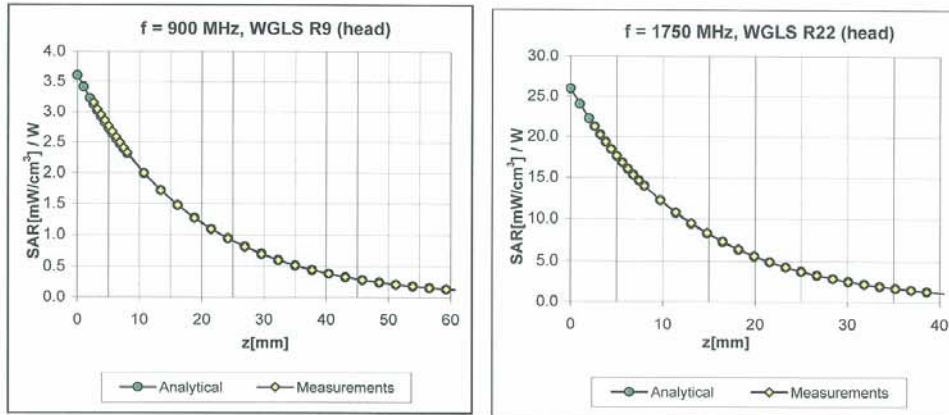

Deviation from Isotropy in HSL

Error (ϕ, θ), f = 900 MHz

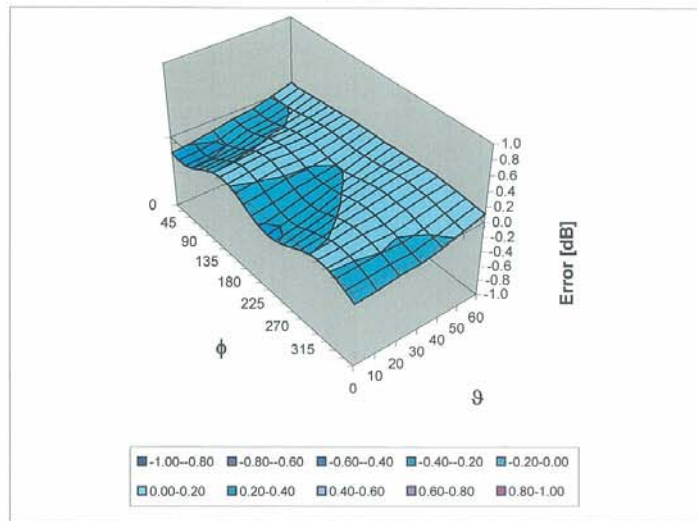

Uncertainty of Spherical Isotropy Assessment: $\pm 2.6\%$ (k=2)

ES3DV3 SN:3161

March 22, 2010

Other Probe Parameters

Sensor Arrangement	Triangular
Connector Angle (°)	Not applicable
Mechanical Surface Detection Mode	enabled
Optical Surface Detection Mode	disabled
Probe Overall Length	337 mm
Probe Body Diameter	10 mm
Tip Length	10 mm
Tip Diameter	4.0 mm
Probe Tip to Sensor X Calibration Point	2 mm
Probe Tip to Sensor Y Calibration Point	2 mm
Probe Tip to Sensor Z Calibration Point	2 mm
Recommended Measurement Distance from Surface	3 mm

Schmid & Partner Engineering AG

s p e a g

Zeughausstrasse 43, 8004 Zurich, Switzerland
Phone +41 44 245 9700, Fax +41 44 245 9779
info@speag.com, <http://www.speag.com>

Dosimetric E-Field Probe ES3DV3 - SN:3161

Conversion factor (\pm standard deviation)

1500 \pm 50 MHz *ConvF* 5.20 \pm 7%

$\epsilon_r = 40.4 \pm 5\%$
 $\sigma = 1.23 \pm 5\%$ mho/m
(head tissue)

Important Note:

For numerically assessed probe conversion factors, parameters Alpha and Delta in the DASY software must have the following entries: Alpha = 0 and Delta = 1.

Please see also DASY Manual.

Schmid & Partner Engineering AG

s p e a gZeughausstrasse 43, 8004 Zurich, Switzerland
Phone +41 44 245 9700, Fax +41 44 245 9779
info@speag.com, http://www.speag.com**Additional Conversion Factors**
for Dosimetric E-Field Probe

Type:

ES3DV3

Serial Number:

3161

Place of Assessment:

Zurich

Date of Assessment:

May 3, 2010

Probe Calibration Date:

March 22, 2010

Schmid & Partner Engineering AG hereby certifies that conversion factor(s) of this probe have been evaluated on the date indicated above. The assessment was performed using the FDTD numerical code SEMCAD of Schmid & Partner Engineering AG. Since the evaluation is coupled with measured conversion factors, it has to be recalculated yearly, i.e., following the recalibration schedule of the probe. The uncertainty of the numerical assessment is based on the extrapolation from measured value at 900 MHz or at 1750 MHz.

Assessed by:



ES3DV3-SN:3161

Page 1 of 2

May 3, 2010

Attachment 4. – Dipole Calibration Data

**Calibration Laboratory of
Schmid & Partner
Engineering AG**
Zeughausstrasse 43, 8004 Zurich, Switzerland



S Schweizerischer Kalibrierdienst
C Service suisse d'étalonnage
S Servizio svizzero di taratura
S Swiss Calibration Service

Accredited by the Swiss Accreditation Service (SAS)
The Swiss Accreditation Service is one of the signatories to the EA
Multilateral Agreement for the recognition of calibration certificates

Accreditation No.: **SCS 108**

Client **HCT (Dymstec)**

Certificate No: **D835V2-441_May10**

CALIBRATION CERTIFICATE

Object **D835V2 - SN: 441**

Calibration procedure(s) **QA CAL-05.v7
Calibration procedure for dipole validation kits**

Calibration date: **May 21, 2010**

This calibration certificate documents the traceability to national standards, which realize the physical units of measurements (SI).
The measurements and the uncertainties with confidence probability are given on the following pages and are part of the certificate.

All calibrations have been conducted in the closed laboratory facility: environment temperature (22 ± 3)°C and humidity < 70%.

Calibration Equipment used (M&TE critical for calibration)

Primary Standards	ID #	Cal Date (Certificate No.)	Scheduled Calibration
Power meter EPM-442A	GB37480704	06-Oct-09 (No. 217-01086)	Oct-10
Power sensor HP 8481A	US37292783	06-Oct-09 (No. 217-01086)	Oct-10
Reference 20 dB Attenuator	SN: 5086 (20g)	30-Mar-10 (No. 217-01158)	Mar-11
Type-N mismatch combination	SN: 5047.2 / 06327	30-Mar-10 (No. 217-01162)	Mar-11
Reference Probe ES3DV3	SN: 3205	30-Apr-10 (No. ES3-3205_Apr10)	Apr-11
DAE4	SN: 601	02-Mar-10 (No. DAE4-601_Mar10)	Mar-11
Secondary Standards	ID #	Check Date (in house)	Scheduled Check
Power sensor HP 8481A	MY41092317	18-Oct-02 (in house check Oct-09)	In house check: Oct-11
RF generator R&S SMT-06	100005	4-Aug-99 (in house check Oct-09)	In house check: Oct-11
Network Analyzer HP 8753E	US37390585 S4206	18-Oct-01 (in house check Oct-09)	In house check: Oct-10

	Name	Function	Signature
Calibrated by:	Jeton Kastrati	Laboratory Technician	
Approved by:	Katja Pokovic	Technical Manager	

Issued: May 21, 2010

This calibration certificate shall not be reproduced except in full without written approval of the laboratory.

Calibration Laboratory of
Schmid & Partner
Engineering AG
Zeughausstrasse 43, 8004 Zurich, Switzerland



S Schweizerischer Kalibrierdienst
C Service suisse d'étalonnage
S Servizio svizzero di taratura
S Swiss Calibration Service

Accredited by the Swiss Accreditation Service (SAS)
The Swiss Accreditation Service is one of the signatories to the EA
Multilateral Agreement for the recognition of calibration certificates

Accreditation No.: **SCS 108**

Glossary:

TSL	tissue simulating liquid
ConvF	sensitivity in TSL / NORM x,y,z
N/A	not applicable or not measured

Calibration is Performed According to the Following Standards:

- IEEE Std 1528-2003, "IEEE Recommended Practice for Determining the Peak Spatial-Averaged Specific Absorption Rate (SAR) in the Human Head from Wireless Communications Devices: Measurement Techniques", December 2003
- IEC 62209-1, "Procedure to measure the Specific Absorption Rate (SAR) for hand-held devices used in close proximity to the ear (frequency range of 300 MHz to 3 GHz)", February 2005
- Federal Communications Commission Office of Engineering & Technology (FCC OET), "Evaluating Compliance with FCC Guidelines for Human Exposure to Radiofrequency Electromagnetic Fields; Additional Information for Evaluating Compliance of Mobile and Portable Devices with FCC Limits for Human Exposure to Radiofrequency Emissions", Supplement C (Edition 01-01) to Bulletin 65

Additional Documentation:

- DASY4/5 System Handbook

Methods Applied and Interpretation of Parameters:

- Measurement Conditions:* Further details are available from the Validation Report at the end of the certificate. All figures stated in the certificate are valid at the frequency indicated.
- Antenna Parameters with TSL:* The dipole is mounted with the spacer to position its feed point exactly below the center marking of the flat phantom section, with the arms oriented parallel to the body axis.
- Feed Point Impedance and Return Loss:* These parameters are measured with the dipole positioned under the liquid filled phantom. The impedance stated is transformed from the measurement at the SMA connector to the feed point. The Return Loss ensures low reflected power. No uncertainty required.
- Electrical Delay:* One-way delay between the SMA connector and the antenna feed point. No uncertainty required.
- SAR measured:* SAR measured at the stated antenna input power.
- SAR normalized:* SAR as measured, normalized to an input power of 1 W at the antenna connector.
- SAR for nominal TSL parameters:* The measured TSL parameters are used to calculate the nominal SAR result.

Measurement Conditions

DASY system configuration, as far as not given on page 1.

DASY Version	DASY5	V5.2
Extrapolation	Advanced Extrapolation	
Phantom	Modular Flat Phantom V4.9	
Distance Dipole Center - TSL	15 mm	with Spacer
Zoom Scan Resolution	dx, dy, dz = 5 mm	
Frequency	835 MHz ± 1 MHz	

Head TSL parameters

The following parameters and calculations were applied.

	Temperature	Permittivity	Conductivity
Nominal Head TSL parameters	22.0 °C	41.5	0.90 mho/m
Measured Head TSL parameters	(22.0 ± 0.2) °C	41.7 ± 6 %	0.91 mho/m ± 6 %
Head TSL temperature during test	(22.5 ± 0.2) °C	----	----

SAR result with Head TSL

SAR averaged over 1 cm ³ (1 g) of Head TSL	Condition	
SAR measured	250 mW input power	2.43 mW / g
SAR normalized	normalized to 1W	9.72 mW / g
SAR for nominal Head TSL parameters	normalized to 1W	9.66 mW /g ± 17.0 % (k=2)

SAR averaged over 10 cm ³ (10 g) of Head TSL	condition	
SAR measured	250 mW input power	1.58 mW / g
SAR normalized	normalized to 1W	6.32 mW / g
SAR for nominal Head TSL parameters	normalized to 1W	6.29 mW /g ± 16.5 % (k=2)

Body TSL parameters

The following parameters and calculations were applied.

	Temperature	Permittivity	Conductivity
Nominal Body TSL parameters	22.0 °C	55.2	0.97 mho/m
Measured Body TSL parameters	(22.0 ± 0.2) °C	54.2 ± 6 %	0.98 mho/m ± 6 %
Body TSL temperature during test	(22.0 ± 0.2) °C	---	---

SAR result with Body TSL

SAR averaged over 1 cm ³ (1 g) of Body TSL	Condition	
SAR measured	250 mW input power	2.51 mW / g
SAR normalized	normalized to 1W	10.0 mW / g
SAR for nominal Body TSL parameters	normalized to 1W	9.92 mW / g ± 17.0 % (k=2)

SAR averaged over 10 cm ³ (10 g) of Body TSL	condition	
SAR measured	250 mW input power	1.64 mW / g
SAR normalized	normalized to 1W	6.56 mW / g
SAR for nominal Body TSL parameters	normalized to 1W	6.51 mW / g ± 16.5 % (k=2)

Appendix**Antenna Parameters with Head TSL**

Impedance, transformed to feed point	55.2 Ω - 8.2 j Ω
Return Loss	- 20.8 dB

Antenna Parameters with Body TSL

Impedance, transformed to feed point	45.3 Ω - 9.4 j Ω
Return Loss	- 19.2 dB

General Antenna Parameters and Design

Electrical Delay (one direction)	1.375 ns
----------------------------------	----------

After long term use with 100W radiated power, only a slight warming of the dipole near the feedpoint can be measured.

The dipole is made of standard semirigid coaxial cable. The center conductor of the feeding line is directly connected to the second arm of the dipole. The antenna is therefore short-circuited for DC-signals.

No excessive force must be applied to the dipole arms, because they might bend or the soldered connections near the feedpoint may be damaged.

Additional EUT Data

Manufactured by	SPEAG
Manufactured on	March 09, 2001

DASY5 Validation Report for Head TSL

Date/Time: 21.05.2010 09:55:07

Test Laboratory: SPEAG, Zurich, Switzerland

DUT: Dipole 835 MHz; Type: D835V2; Serial: D835V2 - SN:441

Communication System: CW; Frequency: 835 MHz; Duty Cycle: 1:1

Medium: HSL900

Medium parameters used: $f = 835$ MHz; $\sigma = 0.91$ mho/m; $\epsilon_r = 41.9$; $\rho = 1000$ kg/m³

Phantom section: Flat Section

Measurement Standard: DASY5 (IEEE/IEC/ANSI C63.19-2007)

DASY5 Configuration:

- Probe: ES3DV3 - SN3205; ConvF(6.03, 6.03, 6.03); Calibrated: 30.04.2010
- Sensor-Surface: 3mm (Mechanical Surface Detection)
- Electronics: DAE4 Sn601; Calibrated: 02.03.2010
- Phantom: Flat Phantom 4.9L; Type: QD000P49AA; Serial: 1001
- Measurement SW: DASY5, V5.2 Build 162; SEMCAD X Version 14.0 Build 61

Pin=250 mW /d=15mm, dist=3.0mm (ES-Probe)/Zoom Scan (7x7x7)/Cube 0: Measurement
grid: dx=5mm, dy=5mm, dz=5mm

Reference Value = 57.3 V/m; Power Drift = -0.023 dB

Peak SAR (extrapolated) = 3.63 W/kg

SAR(1 g) = 2.43 mW/g; SAR(10 g) = 1.58 mW/g

Maximum value of SAR (measured) = 2.83 mW/g

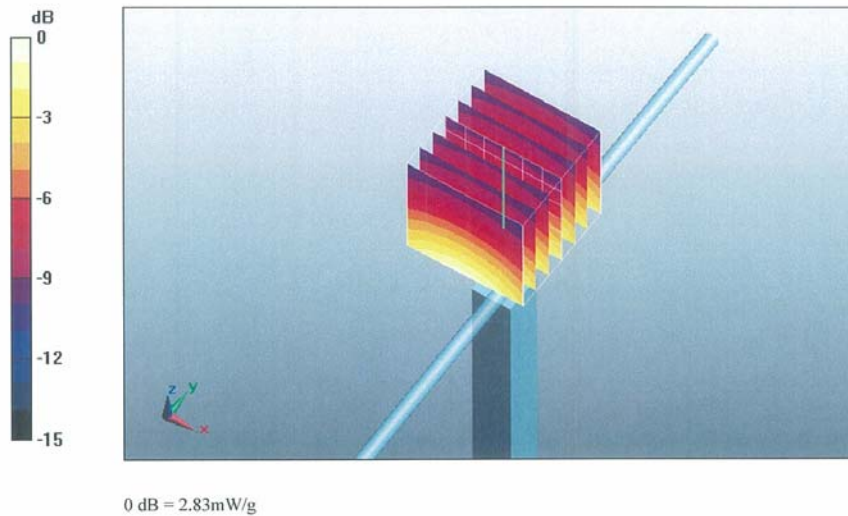

Impedance Measurement Plot for Head TSL

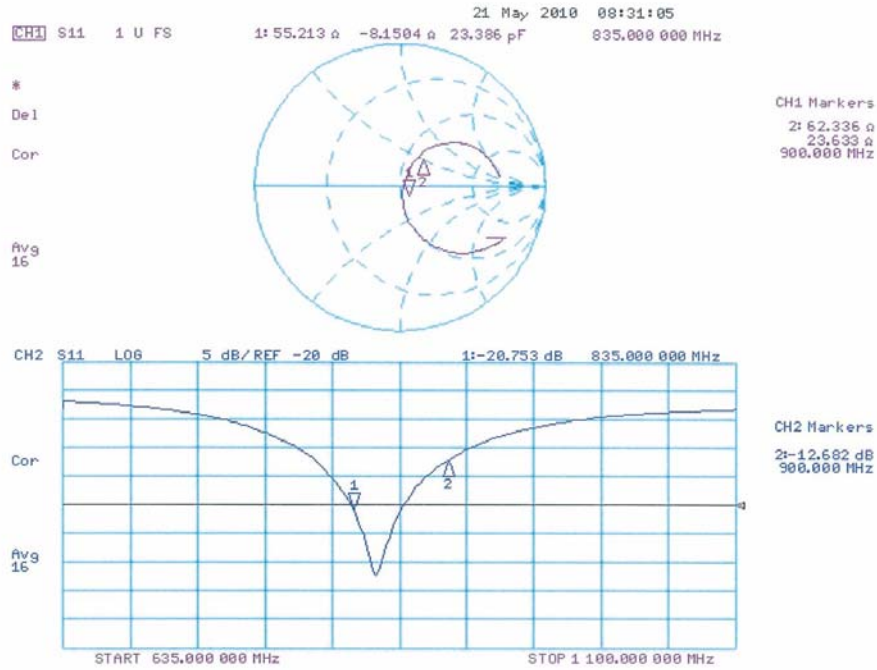

DASY5 Validation Report for Body

Date/Time: 20.05.2010 09:50:16

Test Laboratory: SPEAG, Zurich, Switzerland

DUT: Dipole 835 MHz; Type: D835V2; Serial: D835V2 - SN:441

Communication System: CW; Frequency: 835 MHz; Duty Cycle: 1:1

Medium: MSL900

Medium parameters used: $f = 835$ MHz; $\sigma = 0.98$ mho/m; $\epsilon_r = 54.2$; $\rho = 1000$ kg/m³

Phantom section: Flat Section

Measurement Standard: DASY5 (IEEE/IEC/ANSI C63.19-2007)

DASY5 Configuration:

- Probe: ES3DV3 - SN3205; ConvF(5.86, 5.86, 5.86); Calibrated: 30.04.2010
- Sensor-Surface: 3mm (Mechanical Surface Detection)
- Electronics: DAE4 Sn601; Calibrated: 02.03.2010
- Phantom: Flat Phantom 4.9L; Type: QD000P49AA; Serial: 1001
- Measurement SW: DASY5, V5.2 Build 162; SEMCAD X Version 14.0 Build 61

Pin250 mW /d=15mm, dist=3.0mm (ES-Probe)/Zoom Scan (7x7x7)/Cube 0: Measurement
grid: dx=5mm, dy=5mm, dz=5mm

Reference Value = 56.4 V/m; Power Drift = 0.000719 dB

Peak SAR (extrapolated) = 3.69 W/kg

SAR(1 g) = 2.51 mW/g; SAR(10 g) = 1.64 mW/g

Maximum value of SAR (measured) = 2.93 mW/g

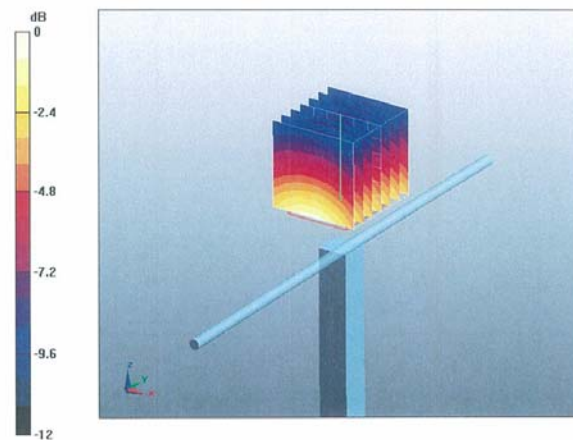

0 dB = 2.93mW/g

Impedance Measurement Plot for Body TSL

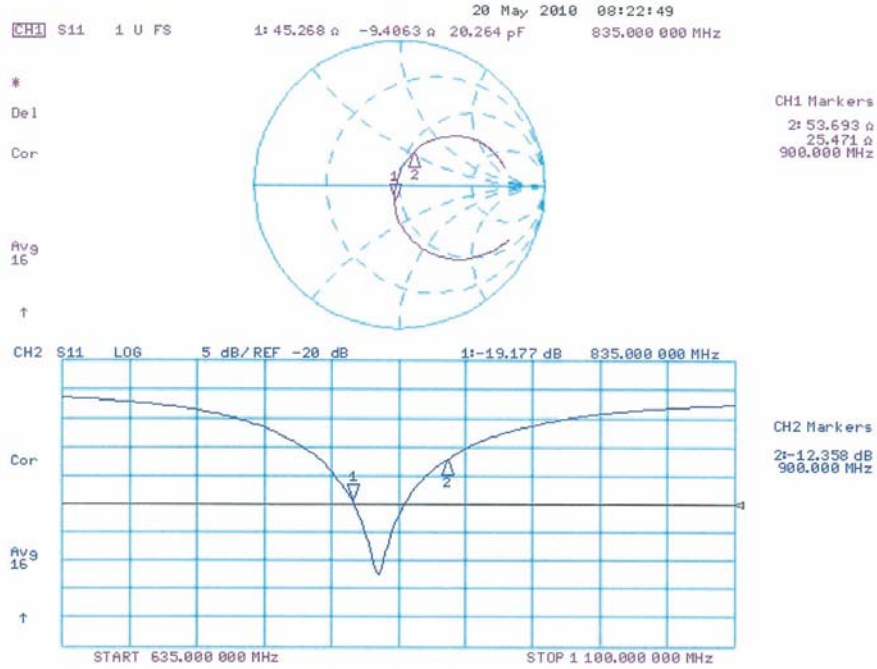

**Calibration Laboratory of
Schmid & Partner
Engineering AG**
Zeughausstrasse 43, 8004 Zurich, Switzerland



S Schweizerischer Kalibrierdienst
C Service suisse d'étalonnage
S Servizio svizzero di taratura
S Swiss Calibration Service

Accredited by the Swiss Accreditation Service (SAS)
The Swiss Accreditation Service is one of the signatories to the EA
Multilateral Agreement for the recognition of calibration certificates

Accreditation No.: **SCS 108**

Client **HCT (Dymstec)**

Certificate No: **D1900V2-5d032_Jul10**

CALIBRATION CERTIFICATE

Object **D1900V2 - SN: 5d032**

Calibration procedure(s) **QA CAL-05.v7
Calibration procedure for dipole validation kits**

Calibration date: **July 16, 2010**

This calibration certificate documents the traceability to national standards, which realize the physical units of measurements (SI).
The measurements and the uncertainties with confidence probability are given on the following pages and are part of the certificate.

All calibrations have been conducted in the closed laboratory facility: environment temperature (22 ± 3)°C and humidity < 70%.

Calibration Equipment used (M&TE critical for calibration)

Primary Standards	ID #	Cal Date (Certificate No.)	Scheduled Calibration
Power meter EPM-442A	GB37480704	06-Oct-09 (No. 217-01086)	Oct-10
Power sensor HP 8481A	US37292783	06-Oct-09 (No. 217-01086)	Oct-10
Reference 20 dB Attenuator	SN: 5086 (20g)	30-Mar-10 (No. 217-01158)	Mar-11
Type-N mismatch combination	SN: 5047.2 / 06327	30-Mar-10 (No. 217-01162)	Mar-11
Reference Probe ES3DV3	SN: 3205	30-Apr-10 (No. ES3-3205_Apr10)	Apr-11
DAE4	SN: 601	10-Jun-10 (No. DAE4-601_Jun10)	Jun-11
Secondary Standards	ID #	Check Date (in house)	Scheduled Check
Power sensor HP 8481A	MY41092317	18-Oct-02 (in house check Oct-09)	In house check: Oct-11
RF generator R&S SMT-06	100005	4-Aug-99 (in house check Oct-09)	In house check: Oct-11
Network Analyzer HP 8753E	US37390585 S4206	18-Oct-01 (in house check Oct-09)	In house check: Oct-10

Calibrated by:	Name Dimce Iliev	Function Laboratory Technician	Signature
Approved by:	Name Katja Pokovic	Function Technical Manager	Signature

Issued: July 19, 2010

This calibration certificate shall not be reproduced except in full without written approval of the laboratory.

Calibration Laboratory of
Schmid & Partner
Engineering AG
Zeughausstrasse 43, 8004 Zurich, Switzerland



S Schweizerischer Kalibrierdienst
C Service suisse d'étalonnage
S Servizio svizzero di taratura
S Swiss Calibration Service

Accredited by the Swiss Accreditation Service (SAS)
The Swiss Accreditation Service is one of the signatories to the EA
Multilateral Agreement for the recognition of calibration certificates

Accreditation No.: **SCS 108**

Glossary:

TSL tissue simulating liquid
ConvF sensitivity in TSL / NORM x,y,z
N/A not applicable or not measured

Calibration is Performed According to the Following Standards:

- a) IEEE Std 1528-2003, "IEEE Recommended Practice for Determining the Peak Spatial-Averaged Specific Absorption Rate (SAR) in the Human Head from Wireless Communications Devices: Measurement Techniques", December 2003
- b) IEC 62209-1, "Procedure to measure the Specific Absorption Rate (SAR) for hand-held devices used in close proximity to the ear (frequency range of 300 MHz to 3 GHz)", February 2005
- c) Federal Communications Commission Office of Engineering & Technology (FCC OET), "Evaluating Compliance with FCC Guidelines for Human Exposure to Radiofrequency Electromagnetic Fields; Additional Information for Evaluating Compliance of Mobile and Portable Devices with FCC Limits for Human Exposure to Radiofrequency Emissions", Supplement C (Edition 01-01) to Bulletin 65

Additional Documentation:

- d) DASY4/5 System Handbook

Methods Applied and Interpretation of Parameters:

- *Measurement Conditions:* Further details are available from the Validation Report at the end of the certificate. All figures stated in the certificate are valid at the frequency indicated.
- *Antenna Parameters with TSL:* The dipole is mounted with the spacer to position its feed point exactly below the center marking of the flat phantom section, with the arms oriented parallel to the body axis.
- *Feed Point Impedance and Return Loss:* These parameters are measured with the dipole positioned under the liquid filled phantom. The impedance stated is transformed from the measurement at the SMA connector to the feed point. The Return Loss ensures low reflected power. No uncertainty required.
- *Electrical Delay:* One-way delay between the SMA connector and the antenna feed point. No uncertainty required.
- *SAR measured:* SAR measured at the stated antenna input power.
- *SAR normalized:* SAR as measured, normalized to an input power of 1 W at the antenna connector.
- *SAR for nominal TSL parameters:* The measured TSL parameters are used to calculate the nominal SAR result.

Measurement Conditions

DASY system configuration, as far as not given on page 1.

DASY Version	DASY5	V52.2
Extrapolation	Advanced Extrapolation	
Phantom	Modular Flat Phantom V5.0	
Distance Dipole Center - TSL	10 mm	with Spacer
Zoom Scan Resolution	dx, dy, dz = 5 mm	
Frequency	1900 MHz \pm 1 MHz	

Head TSL parameters

The following parameters and calculations were applied.

	Temperature	Permittivity	Conductivity
Nominal Head TSL parameters	22.0 °C	40.0	1.40 mho/m
Measured Head TSL parameters	(22.0 \pm 0.2) °C	40.3 \pm 6 %	1.43 mho/m \pm 6 %
Head TSL temperature during test	(22.6 \pm 0.2) °C	----	----

SAR result with Head TSL

SAR averaged over 1 cm³ (1 g) of Head TSL	Condition	
SAR measured	250 mW input power	10.1 mW / g
SAR normalized	normalized to 1W	40.4 mW / g
SAR for nominal Head TSL parameters	normalized to 1W	39.9 mW / g \pm 17.0 % (k=2)

SAR averaged over 10 cm³ (10 g) of Head TSL	condition	
SAR measured	250 mW input power	5.26 mW / g
SAR normalized	normalized to 1W	21.0 mW / g
SAR for nominal Head TSL parameters	normalized to 1W	20.9 mW / g \pm 16.5 % (k=2)

Body TSL parameters

The following parameters and calculations were applied.

	Temperature	Permittivity	Conductivity
Nominal Body TSL parameters	22.0 °C	53.3	1.52 mho/m
Measured Body TSL parameters	(22.0 ± 0.2) °C	53.3 ± 6 %	1.55 mho/m ± 6 %
Body TSL temperature during test	(22.5 ± 0.2) °C	---	---

SAR result with Body TSL

SAR averaged over 1 cm ³ (1 g) of Body TSL	Condition	
SAR measured	250 mW input power	10.5 mW / g
SAR normalized	normalized to 1W	42.0 mW / g
SAR for nominal Body TSL parameters	normalized to 1W	41.5 mW / g ± 17.0 % (k=2)

SAR averaged over 10 cm ³ (10 g) of Body TSL	condition	
SAR measured	250 mW input power	5.63 mW / g
SAR normalized	normalized to 1W	22.5 mW / g
SAR for nominal Body TSL parameters	normalized to 1W	22.4 mW / g ± 16.5 % (k=2)

Appendix**Antenna Parameters with Head TSL**

Impedance, transformed to feed point	51.6 Ω + 6.2 j Ω
Return Loss	- 24.0 dB

Antenna Parameters with Body TSL

Impedance, transformed to feed point	50.3 Ω + 7.0 j Ω
Return Loss	- 23.1 dB

General Antenna Parameters and Design

Electrical Delay (one direction)	1.177 ns
----------------------------------	----------

After long term use with 100W radiated power, only a slight warming of the dipole near the feedpoint can be measured.

The dipole is made of standard semirigid coaxial cable. The center conductor of the feeding line is directly connected to the second arm of the dipole. The antenna is therefore short-circuited for DC-signals.

No excessive force must be applied to the dipole arms, because they might bend or the soldered connections near the feedpoint may be damaged.

Additional EUT Data

Manufactured by	SPEAG
Manufactured on	March 17, 2003

DASY5 Validation Report for Head TSL

Date/Time: 16.07.2010 12:15:48

Test Laboratory: SPEAG, Zurich, Switzerland

DUT: Dipole 1900 MHz; Type: D1900V2; Serial: D1900V2 - SN:5d032

Communication System: CW; Frequency: 1900 MHz; Duty Cycle: 1:1

Medium: HSL U12 BB

Medium parameters used: $f = 1900$ MHz; $\sigma = 1.43$ mho/m; $\epsilon_r = 40.2$; $\rho = 1000$ kg/m³

Phantom section: Flat Section

Measurement Standard: DASY5 (IEEE/IEC/ANSI C63.19-2007)

DASY5 Configuration:

- Probe: ES3DV3 - SN3205; ConvF(5.09, 5.09, 5.09); Calibrated: 30.04.2010
- Sensor-Surface: 3mm (Mechanical Surface Detection)
- Electronics: DAE4 Sn601; Calibrated: 10.06.2010
- Phantom: Flat Phantom 5.0 (front); Type: QD000P50AA; Serial: 1001
- Measurement SW: DASY52, V52.2 Build 0, Version 52.2.0 (163)
- Postprocessing SW: SEMCAD X, V14.2 Build 2, Version 14.2.2 (1685)

Pin=250 mW /d=10mm, dist=3.0mm (ES-Probe)/Zoom Scan (7x7x7) /Cube 0: Measurement

grid: dx=5mm, dy=5mm, dz=5mm

Reference Value = 96.4 V/m; Power Drift = 0.039 dB

Peak SAR (extrapolated) = 18.3 W/kg

SAR(1 g) = 10.1 mW/g; SAR(10 g) = 5.26 mW/g

Maximum value of SAR (measured) = 12.3 mW/g

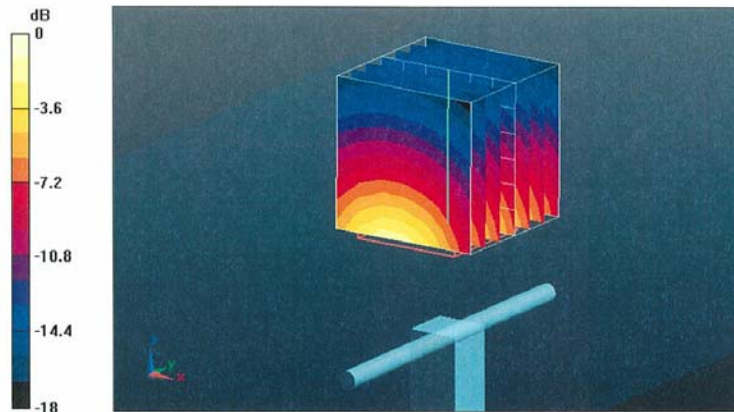

0 dB = 12.3mW/g

Impedance Measurement Plot for Head TSL

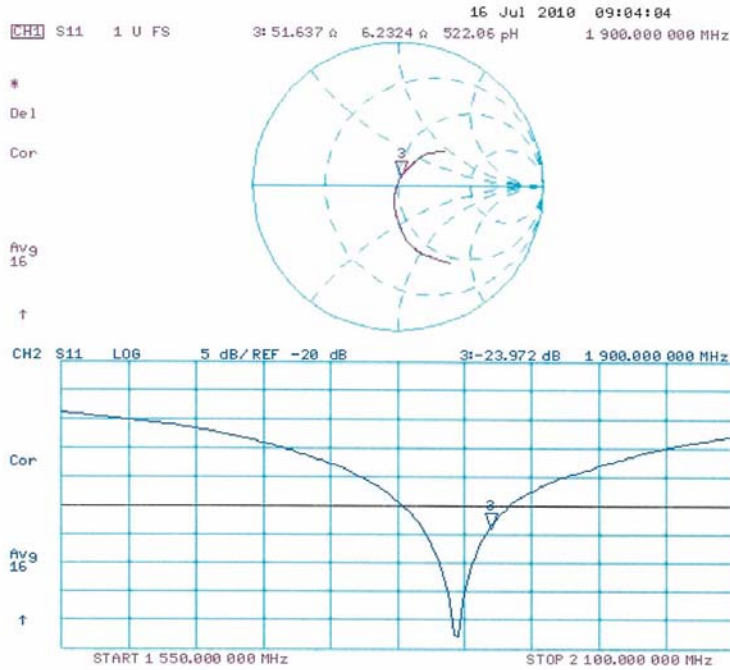

DASY5 Validation Report for Body

Date/Time: 13.07.2010 12:14:01

Test Laboratory: SPEAG, Zurich, Switzerland

DUT: Dipole 1900 MHz; Type: D1900V2; Serial: D1900V2 - SN:5d032

Communication System: CW; Frequency: 1900 MHz; Duty Cycle: 1:1

Medium: MSL U11 BB

Medium parameters used: $f = 1900$ MHz; $\sigma = 1.55$ mho/m; $\epsilon_r = 53.2$; $\rho = 1000$ kg/m³

Phantom section: Flat Section

Measurement Standard: DASY5 (IEEE/IEC/ANSI C63.19-2007)

DASY5 Configuration:

- Probe: ES3DV3 - SN3205; ConvF(4.59, 4.59, 4.59); Calibrated: 30.04.2010
- Sensor-Surface: 3mm (Mechanical Surface Detection)
- Electronics: DAE4 Sn601; Calibrated: 10.06.2010
- Phantom: Flat Phantom 5.0 (back); Type: QD000P50AA; Serial: 1002
- Measurement SW: DASY52, V52.2 Build 0, Version 52.2.0 (163)
- Postprocessing SW: SEMCAD X, V14.2 Build 2, Version 14.2.2 (1685)

Pin=250 mW /d=10mm, dist=3.0mm (ES-Probe)/Zoom Scan (7x7x7) /Cube 0: Measurement grid: dx=5mm, dy=5mm, dz=5mm

Reference Value = 97.1 V/m; Power Drift = 0.00127 dB

Peak SAR (extrapolated) = 17.6 W/kg

SAR(1 g) = 10.5 mW/g; SAR(10 g) = 5.63 mW/g

Maximum value of SAR (measured) = 13.2 mW/g

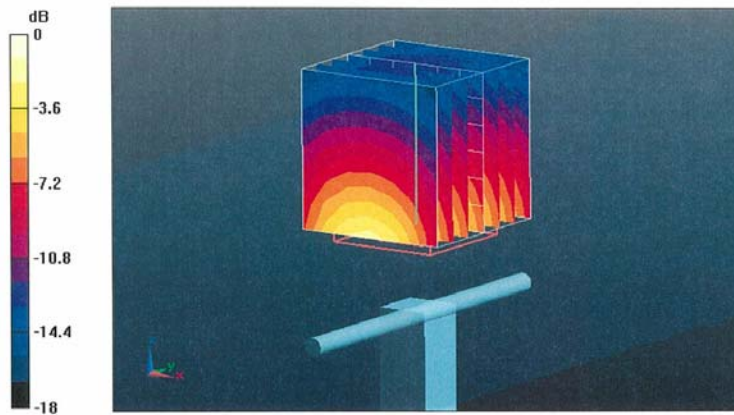

0 dB = 13.2mW/g

Impedance Measurement Plot for Body TSL

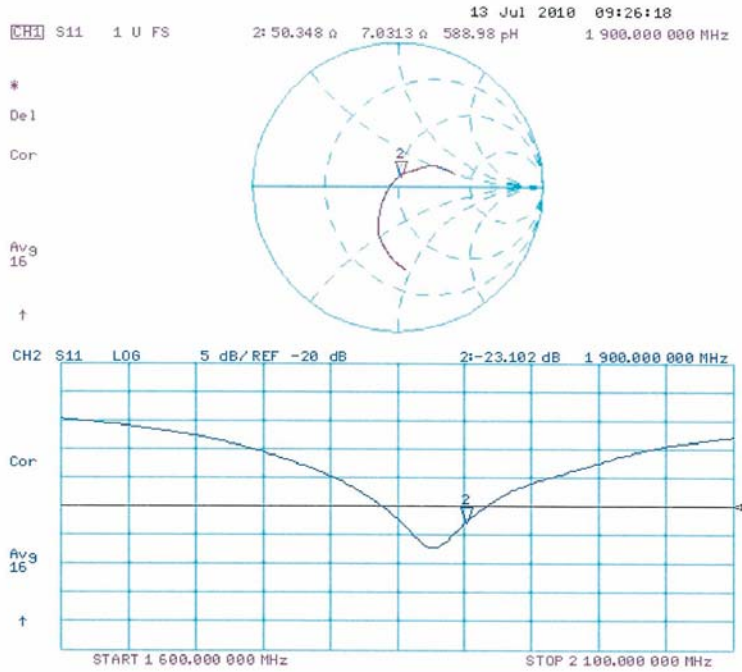

**Calibration Laboratory of
Schmid & Partner
Engineering AG**
Zeughausstrasse 43, 8004 Zurich, Switzerland



S Schweizerischer Kalibrierdienst
C Service suisse d'étalonnage
S Servizio svizzero di taratura
S Swiss Calibration Service

Accredited by the Swiss Accreditation Service (SAS)
The Swiss Accreditation Service is one of the signatories to the EA
Multilateral Agreement for the recognition of calibration certificates

Accreditation No.: **SCS 108**

Client **LG (Dymstec)**

Certificate No: **D2450V2-768_Apr10**

CALIBRATION CERTIFICATE

Object **D2450V2 - SN: 768**

Calibration procedure(s) **QA CAL-05.v7
Calibration procedure for dipole validation kits**

Calibration date: **April 19, 2010**

This calibration certificate documents the traceability to national standards, which realize the physical units of measurements (SI).
The measurements and the uncertainties with confidence probability are given on the following pages and are part of the certificate.

All calibrations have been conducted in the closed laboratory facility; environment temperature (22 ± 3)°C and humidity < 70%.

Calibration Equipment used (M&TE critical for calibration)

Primary Standards	ID #	Cal Date (Certificate No.)	Scheduled Calibration
Power meter EPM-442A	GB37480704	06-Oct-09 (No. 217-01086)	Oct-10
Power sensor HP 8481A	US37292783	06-Oct-09 (No. 217-01086)	Oct-10
Reference 20 dB Attenuator	SN: 5086 (20g)	30-Mar-10 (No. 217-01158)	Mar-11
Type-N mismatch combination	SN: 5047.2 / 06327	30-Mar-10 (No. 217-01162)	Mar-11
Reference Probe ES3DV3	SN: 3205	26-Jun-09 (No. ES3-3205_Jun09)	Jun-10
DAE4	SN: 601	02-Mar-10 (No. DAE4-601_Mar10)	Mar-11
Secondary Standards	ID #	Check Date (in house)	Scheduled Check
Power sensor HP 8481A	MY41092317	18-Oct-02 (in house check Oct-09)	in house check: Oct-11
RF generator R&S SMT-06	100005	4-Aug-99 (in house check Oct-09)	in house check: Oct-11
Network Analyzer HP 8753E	US37390585 S4206	18-Oct-01 (in house check Oct-09)	in house check: Oct-10

	Name	Function	Signature
Calibrated by:	Dimca Iliev	Laboratory Technician	
Approved by:	Katja Pokovic	Technical Manager	

Issued: April 20, 2010

This calibration certificate shall not be reproduced except in full without written approval of the laboratory.

**Calibration Laboratory of
Schmid & Partner
Engineering AG**
Zeughausstrasse 43, 8004 Zurich, Switzerland



S Schweizerischer Kalibrierdienst
C Service suisse d'étalonnage
S Servizio svizzero di taratura
S Swiss Calibration Service

Accredited by the Swiss Accreditation Service (SAS)
The Swiss Accreditation Service is one of the signatories to the EA
Multilateral Agreement for the recognition of calibration certificates

Accreditation No.: **SCS 108**

Glossary:

TSL	tissue simulating liquid
ConvF	sensitivity in TSL / NORM x,y,z
N/A	not applicable or not measured

Calibration is Performed According to the Following Standards:

- a) IEEE Std 1528-2003, "IEEE Recommended Practice for Determining the Peak Spatial-Averaged Specific Absorption Rate (SAR) in the Human Head from Wireless Communications Devices: Measurement Techniques", December 2003
- b) IEC 62209-1, "Procedure to measure the Specific Absorption Rate (SAR) for hand-held devices used in close proximity to the ear (frequency range of 300 MHz to 3 GHz)", February 2005
- c) Federal Communications Commission Office of Engineering & Technology (FCC OET), "Evaluating Compliance with FCC Guidelines for Human Exposure to Radiofrequency Electromagnetic Fields; Additional Information for Evaluating Compliance of Mobile and Portable Devices with FCC Limits for Human Exposure to Radiofrequency Emissions", Supplement C (Edition 01-01) to Bulletin 65

Additional Documentation:

- d) DASY4/5 System Handbook

Methods Applied and Interpretation of Parameters:

- *Measurement Conditions:* Further details are available from the Validation Report at the end of the certificate. All figures stated in the certificate are valid at the frequency indicated.
- *Antenna Parameters with TSL:* The dipole is mounted with the spacer to position its feed point exactly below the center marking of the flat phantom section, with the arms oriented parallel to the body axis.
- *Feed Point Impedance and Return Loss:* These parameters are measured with the dipole positioned under the liquid filled phantom. The impedance stated is transformed from the measurement at the SMA connector to the feed point. The Return Loss ensures low reflected power. No uncertainty required.
- *Electrical Delay:* One-way delay between the SMA connector and the antenna feed point. No uncertainty required.
- *SAR measured:* SAR measured at the stated antenna input power.
- *SAR normalized:* SAR as measured, normalized to an input power of 1 W at the antenna connector.
- *SAR for nominal TSL parameters:* The measured TSL parameters are used to calculate the nominal SAR result.

Body TSL parameters

The following parameters and calculations were applied.

	Temperature	Permittivity	Conductivity
Nominal Body TSL parameters	22.0 °C	52.7	.1.95 mho/m
Measured Body TSL parameters	(22.0 ± 0.2) °C	54.2 ± 6 %	2.01 mho/m ± 6 %
Body TSL temperature during test	(21.5 ± 0.2) °C	----	----

SAR result with Body TSL

SAR averaged over 1 cm ³ (1 g) of Body TSL	Condition	
SAR measured	250 mW input power	13.3 mW / g
SAR normalized	normalized to 1W	53.2 mW / g
SAR for nominal Body TSL parameters	normalized to 1W	52.7 mW / g ± 17.0 % (k=2)

SAR averaged over 10 cm ³ (10 g) of Body TSL	condition	
SAR measured	250 mW input power	6.20 mW / g
SAR normalized	normalized to 1W	24.8 mW / g
SAR for nominal Body TSL parameters	normalized to 1W	24.8 mW / g ± 16.5 % (k=2)

Appendix**Antenna Parameters with Body TSL**

Impedance, transformed to feed point	50.0 Ω + 4.9 j Ω
Return Loss	- 26.2 dB

General Antenna Parameters and Design

Electrical Delay (one direction)	1.151 ns
----------------------------------	----------

After long term use with 100W radiated power, only a slight warming of the dipole near the feedpoint can be measured.

The dipole is made of standard semirigid coaxial cable. The center conductor of the feeding line is directly connected to the second arm of the dipole. The antenna is therefore short-circuited for DC-signals.

No excessive force must be applied to the dipole arms, because they might bend or the soldered connections near the feedpoint may be damaged.

Additional EUT Data

Manufactured by	SPEAG
Manufactured on	August 10, 2004

DASY5 Validation Report for Body

Date/Time: 19.04.2010 13:41:45

Test Laboratory: SPEAG, Zurich, Switzerland

DUT: Dipole 2450 MHz; Type: D2450V2; Serial: D2450V2 - SN:768

Communication System: CW; Frequency: 2450 MHz; Duty Cycle: 1:1

Medium: MSL U11 BB

Medium parameters used: $f = 2450$ MHz; $\sigma = 2.02$ mho/m; $\epsilon_r = 54.3$; $\rho = 1000$ kg/m³

Phantom section: Flat Section

Measurement Standard: DASY5 (IEEE/IEC/ANSI C63.19-2007)

DASY5 Configuration:

- Probe: ES3DV3 - SN3205; ConvF(4.31, 4.31, 4.31); Calibrated: 26.06.2009
- Sensor-Surface: 3mm (Mechanical Surface Detection)
- Electronics: DAE4 Sn601; Calibrated: 02.03.2010
- Phantom: Flat Phantom 5.0 (back); Type: QD000P50AA; Serial: 1002
- Measurement SW: DASY5, V5.2 Build 157; SEMCAD X Version 14.0 Build 57

Pin250 mW /d=10mm, dist=3.0mm (ES-Probe)/Zoom Scan (7x7x7) /Cube 0: Measurement grid: dx=5mm, dy=5mm, dz=5mm

Reference Value = 95.5 V/m; Power Drift = -0.0089 dB

Peak SAR (extrapolated) = 27.5 W/kg

SAR(1 g) = 13.3 mW/g; SAR(10 g) = 6.2 mW/g

Maximum value of SAR (measured) = 17.5 mW/g

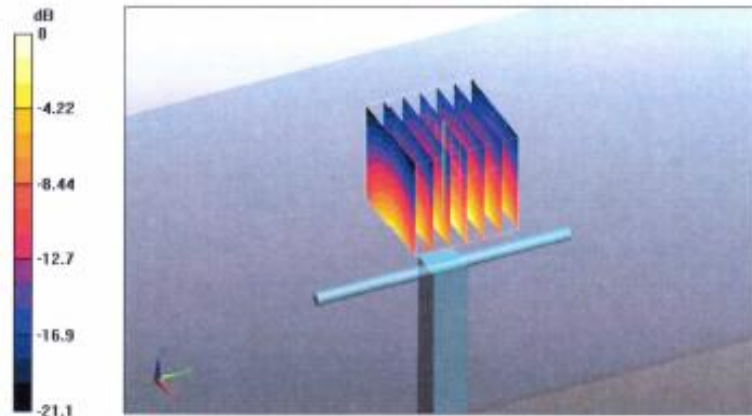

Impedance Measurement Plot for Body TSL

