

**FCC 15.247 & RSS-247
(Permissive Change)
2.4GHz Test Report**

for

LG Electronics Inc.

**222, LG-ro, Jinwi-myeon Pyeongtaek-Si, Gyeonggi-Do,
17709 Republic of Korea**

Product Name : Notebook Computer
**Model Name : (1)17Z90R (2)17ZD90R
(3)17Z90S (4)17ZD90S**
Brand : LG
FCC ID : BEJNT-17Z90R
IC : 2703H-17Z90R

**Prepared by: : AUDIX Technology Corporation,
EMC Department**



The test report is based on a single evaluation of one sample of the above-mentioned products. It does not imply an assessment of the whole production and does not permit the use of the test lab logo.

TABLE OF CONTENTS

Description	Page
TEST REPORT	4
1. REVISION RECORD OF TEST REPORT	4
2. SUMMARY OF TEST RESULTS	5
3. GENERAL INFORMATION	6
3.1. Description of Application	6
3.2. Description of EUT	7
3.3. Reference Test Guidance.....	8
3.4. Information for Permissive Change.....	8
3.5. Antenna Information	8
3.6. EUT Specifications Assessed in Current Report	10
3.7. Description of Key Components	11
3.8. Test Configuration.....	14
3.9. Output Power Setting	14
3.10. Tested Supporting System List.....	15
3.11. Setup Configuration.....	15
3.12. Operating Condition of EUT	16
3.13. Description of Test Facility	16
3.14. Measurement Uncertainty	17
4. MEASUREMENT EQUIPMENTLIST.....	18
4.1. Conducted Emission Measurement	18
4.2. Radiated Emission Measurement	19
4.3. RF Conducted Measurement	19
5. CONDUCTED EMISSION.....	20
5.1. Block Diagram of Test Setup	20
5.2. Conducted Emission Limit	20
5.3. Test Procedure	20
5.4. Test Results	20
6. RADIATED EMISSION	21
6.1. Block Diagram of Test Setup	21
6.2. Radiated Emission Limits.....	22
6.3. Test Procedure	23
6.4. Measurement Result Explanation.....	24
6.5. Test Results	24
7. MAXIMUM PEAK OUTPUT POWER	25
7.1. Block Diagram of Test Setup	25
7.2. Specification Limits.....	25
7.3. Test Procedure	25
7.4. Test Results	25
8. DEVIATION TO TEST SPECIFICATIONS	26
APPENDIX A TEST DATA AND PLOTS	
APPENDIX B TEST PHOTOGRAPHS	



Audix Technology Corp.
No. 491, Zhongfu Rd., Linkou Dist.,
New Taipei City 244, Taiwan

Tel: +886 2 26099301
Fax: +886 2 26099303

TEST REPORT (Permissive Change)

Applicant : LG Electronics Inc.
Manufacturer : LG Electronics Inc.
Factory : LG Electronics Nanjing New Technology Co., Ltd.
EUT Description
(1) Product : Notebook Computer
(2) Model : (1)17Z90R (2)17ZD90R (3)17Z90S (4)17ZD90S
(3) Brand : LG
(4) Power Supply: DC 20V, 3.25A

Applicable Standards:

Title 47 CFR FCC Part 15 Subpart C
RSS-Gen (Issue 5), Amendment 2, February 2021
RSS-247 (Issue 2), February 2017

Audix Technology Corp. tested the equipment mentioned in accordance with the requirements set forth in the above standards. Test results indicate that the equipment tested is capable of demonstrating compliance with the requirements as documented within this report.

Audix Technology Corp. does not assume responsibility for any conclusions and generalizations drawn from the test results with regard to other specimens and samples.

Date of Report: 2023. 10. 17

Reviewed by: Sabrina Wang (Sabrina Wang/Administrator)

Approved by: Johnny Hsueh (Johnny Hsueh/Section Manager)



Audix Technology Corp.
No. 491, Zhongfu Rd., Linkou Dist.,
New Taipei City 244, Taiwan

Tel: +886 2 26099301
Fax: +886 2 26099303

1. REVISION RECORD OF TEST REPORT

Edition No	Issued Date	Revision Summary	Report Number
0	2023. 10. 17	Original Report	EM-F230499

2. SUMMARY OF TEST RESULTS

Rule		Description	Results
FCC	IC		
15.207	RSS-Gen §8.8	Conducted Emission	PASS
15.247(d)/15.205	RSS-Gen §8.9 RSS-247 §5.5	Radiated Band Edge and Radiated Spurious Emission	PASS
15.247(a)(1)	RSS-247 §5.1(2)	20dB/Occupied Bandwidth	N/A ^{Note3}
15.247(a)(1)	RSS-247 §5.1(2)	Carrier Frequency Separation	N/A ^{Note3}
15.247(a)(1)(iii)	RSS-247 §5.1(4)	Time of Occupancy	N/A ^{Note3}
15.247(a)(1)(iii)	RSS-247 §5.1(4)	Number of Hopping Channels	N/A ^{Note3}
15.247(b)(1)	RSS-247 §5.1(2)	Maximum Peak Output Power	PASS
15.247(d)	RSS-247 §5.5	Conducted Band Edges and Conducted Spurious Emission	N/A ^{Note3}
15.203	---	Antenna Requirement	Compliance

Note: 1. Decision rule according to the limit of the test standard chapter, the test value is lower than the limit specified in the test chapter, and it is judged as Pass.
2. The uncertainties value is not used in determining the result.
3. Due to the difference mentioned by cover letter don't influence on RF characteristics, so it is unnecessary to re-test.

3. GENERAL INFORMATION

3.1. Description of Application

Applicant	LG Electronics Inc. 222, LG-ro, Jinwi-myeon Pyeongtaek-Si, Gyeonggi-Do, 17709 Republic of Korea
Manufacturer	LG Electronics Inc. 222, LG-ro, Jinwi-myeon Pyeongtaek-Si, Gyeonggi-Do, 17709 Republic of Korea
Factory	LG Electronics Nanjing New Technology Co., Ltd. No.346, Yaoxin Road, Economic & Technical Development Zone, Nanjing, China.
Product	Notebook Computer
Model	(1)17Z90R (2)17ZD90R (3)17Z90S (4)17ZD90S The difference between all models is different in the sales customers, color difference and component. Note: Model 17Z90R and 17Z90S is for ISED application.
Configuration (HVIN)	17Z90R-K, 17Z90R-N, 17Z90R-A, 17Z90R-R, 17Z90R-Q, 17Z90R-H, 17Z90R-T, 17Z90S-G, 17Z90S-V, 17Z90S-M, 17Z90S-C, 17Z90S-H
Brand	LG

The model 17Z90R and 17Z90S series has following different configuration and components, and the details are as follows:

Difference		Main Board	GPU	Battery	CPU	TPM (Trusted Platform Module)	Panel Touch Function	Antenna		
Original	17Z90R-K	ROYAL MAIN B/D	Intel Iris Xe Graphics	LBV7227E (80 Wh)	Intel, i7-1360P Intel, i5-1340P	Not Support	Without	#1 WA-P-LELE-04-011 #2 L1LRF009-CS-H		
	17Z90R-N					Support				
	17Z90R-A	ROYAL NVIDIA MAIN B/D	NVIDIA GeForce RTX 3050	LBY122CM (90 Wh)	Not Support					
	17Z90R-R				Support					
	17Z90R-Q	ROYAL MAIN B/D	Intel Iris Xe Graphics	LBV7227E (80 Wh)	Intel, i7-1370P Intel, i5-1350P	Support				
	17Z90R-H	ROYAL MAIN B/D	Intel Iris Xe Graphics	LBV7227E (80 Wh)	Intel, i7-1360P Intel, i5-1340P	Not Support			With	#3 WA-P-LBLB-04-108
	17Z90R-T					Support				
This Time	17Z90S-G	MTL MAIN B/D	Intel Arc Graphics	LB3122MM (77 Wh)	Intel, Ultra 7 155H Intel, Ultra 5 125H	Not Support	Without	#1 WA-P-LELE-04-011 #2 L1LRF009-CS-H		
	17Z90S-V					Support				
	17Z90S-M					Not Support				
	17Z90S-C					Not Support				
	17Z90S-H					Not Support			With	#3 WA-P-LBLB-04-108

3.2. Description of EUT

Test Model	17Z90S		
Serial Number	N/A		
Power Rating	DC 20V, 3.25A		
Software Version	XY (X, Y can be 0 to 9 for different SW version not influence RF parameter)		
RF Features	WLAN: 802.11 a/b/g/n/ac/ax Bluetooth: BT and BLE (BT 5.1)		
Transmit Type	2.4 GHz		
	802.11b		1T1R
	802.11g		1T1R
	802.11n-HT20		2T2R
	802.11n-HT40		2T2R
	802.11ax-HE20		2T2R
	802.11ax-HE40		2T2R
	BT/BLE		1T1R
	U-NII Bands		
	802.11a		1T1R
	802.11n-HT20/802.11ac-VHT20/802.11ax-HE20		2T2R
	802.11n-HT40/802.11ac-VHT40/802.11ax-HE40		2T2R
	802.11ac-VHT80/802.11ax-HE80		2T2R
	802.11ac-VHT160/802.11ax-HE160		2T2R
	The MIMO is uncorrelated and supported SDM(Spatial Division Multiplexing) mode only. This radio device doesn't support beamforming and Cyclic Delay Diversity (CDD).		
Sample Status	Trial sample		
Test Sample	Sample No.	Test Item	Firmware
	01	AC Conduction, RSE, Output Power	N/A
	02	AC Conduction, RSE, Output Power	N/A
Date of Receipt	2023. 09. 05		
Date of Test	2023. 09. 26 ~ 10. 06		
Interface Ports of EUT	<ul style="list-style-type: none"> • One HDMI Port • Two USB Type C Ports • One Earphone Port • One Micro SD Card Slot • Two USB 3.0 Ports 		
Accessories Supplied	<ul style="list-style-type: none"> • AC Adapter • Type C cable *2 • LAN Gender 		

Note: Pursuant ISO 17025:2017 section 7.8.2, Audix Technology Corp. does not assume responsibility for all EUT's information including RF features, transmit type, antenna information...etc are provided by customer.

3.3. Reference Test Guidance

ANSI C63.10:2013

3.4. Information for Permissive Change

- The EUT is an addition version with original FCC ID: BEJNT-17Z90R and IC: 2703H-17Z90R are as following.
 - (a) To add new models 17Z90S and 17ZD90S for FCC ID application.
 - (b) To add new model 17Z90S for ISED application.
 - (c) To add new Configuration (HVIN) 17Z90S-G, 17Z90S-V, 17Z90S-M, 17Z90S-C and 17Z90S-H.
 - (d) Based on original ROYAL MAIN B/D main board, the difference between ROYAL MAIN B/D main board and MTL MAIN B/D main board is refer to Cover Letter-Permissive Change. The MTL MAIN B/D main board is for new Configuration (HVIN) 17Z90S-G, 17Z90S-V, 17Z90S-M, 17Z90S-C and 17Z90S-H.
 - (e) To add new CPUs for MTL MAIN B/D main board.
 - (f) To add new Battery Pack for MTL MAIN B/D main board.
 - (g) To add new Type C cable (3A).
- The differences between this application and original's ID as clarify in following list.

Difference		Main Board	GPU	Battery	CPU	TPM (Trusted Platform Module)	Panel Touch Function	Antenna
Original	17Z90R-K	ROYAL MAIN B/D	Intel Iris Xe Graphics	LBV7227E (80 Wh)	Intel, i7-1360P	Not Support	Without	#1 WA-P-LELE-04-011 #2 L1LRF009-CS-H
	17Z90R-N				Intel, i5-1340P	Support		
	17Z90R-Q				Intel, i7-1370P	Support		
	17Z90R-H				Intel, i7-1360P	Not Support		
	17Z90R-T				Intel, i5-1340P	Support		
Permissive Change	17Z90S-G	MTL MAIN B/D	Intel Arc Graphics	LB3122MM (77 Wh)	Intel, Ultra 7 155H	Not Support	Without	#1 WA-P-LELE-04-011 #2 L1LRF009-CS-H
	17Z90S-V				Intel, Ultra 5 125H	Support		
	17Z90S-M					Not Support		
	17Z90S-C					Not Support		
	17Z90S-H					Not Support		
						With	#3 WA-P-LBLB-04-108	

- Due to above different item, there have some test item should be re-tested (see section 2), the test data are recorded in this report.

3.5. Antenna Information

No.	Antenna Part Number	Manufacturer	Antenna Type	Frequency (MHz)	Max Gain(dBi)		Directional Gain
					Aux	Main	
1.	WA-P-LELE-04-011	INPAQ	Mono-Pole	2400	1.10	2.20	1.68
				2450	1.60	3.00	2.36
				2500	1.50	2.70	2.14
				5150	3.80	4.10	3.95
				5400	3.70	4.00	3.85
				5850	3.30	3.70	3.50
				5925	3.20	3.50	3.35
				6525	2.50	2.70	2.60
				7125	2.10	2.50	2.30
According to KDB 662911 D01 d) ii), transmit signals are completely uncorrelated, then Directional gain = $10 \log[(10^{G1/10} + 10^{G2/10} + \dots + 10^{GN/10})/N_{ANT}]$ dBi We chose the antenna gain corresponding to the frequency listed on the table which is closer to center frequency of WLAN.							
No.	Antenna Part Number	Manufacturer	Antenna Type	Frequency (MHz)	Max Gain(dBi)		Directional Gain
					Aux	Main	
2.	L1LRF009-CS-H	LUXSHARE-ICT	Mono-Pole	2400	2.89	-1.45	1.24
				2450	-0.07	0.26	0.10
				2500	-6.91	2.15	-0.35
				5150	3.64	5.24	4.51
				5400	1.11	0.55	0.84
				5850	2.88	4.96	4.04
				5925	2.48	5.85	4.49
				6525	1.38	1.19	1.29
				7125	1.89	3.99	3.07
According to KDB 662911 D01 d) ii), transmit signals are completely uncorrelated, then Directional gain = $10 \log[(10^{G1/10} + 10^{G2/10} + \dots + 10^{GN/10})/N_{ANT}]$ dBi We chose the antenna gain corresponding to the frequency listed on the table which is closer to center frequency of WLAN.							
No.	Antenna Part Number	Manufacturer	Antenna Type	Frequency (MHz)	Max Gain(dBi)		Directional Gain
					Aux	Main	
3.	WA-P-LBLB-04-108	INPAQ	Mono-Pole	2400-2500	2.90	3.10	3.00
				5150-5350	2.80	-2.10	1.01
				5470-5725	5.70	2.50	4.39
				5725-5850	5.30	5.20	5.25
				5925-6425	3.70	4.80	4.28
				6425-6525	-1.00	1.00	0.11
				6525-6875	2.80	1.60	2.24
				6875-7125	-1.40	2.90	1.26
According to KDB 662911 D01 d) ii), transmit signals are completely uncorrelated, then Directional gain = $10 \log[(10^{G1/10} + 10^{G2/10} + \dots + 10^{GN/10})/N_{ANT}]$ dBi							

3.6. EUT Specifications Assessed in Current Report

Mode	Fundamental Range (MHz)	Channel Number	Modulation	Data Rate (Mbps)
Bluetooth	2402-2480	79	FHSS (GFSK, $\pi/4$ DQPSK, 8-DPSK)	1/2/3

Channel List							
Channel Number	Frequency (MHz)	Channel Number	Frequency (MHz)	Channel Number	Frequency (MHz)	Channel Number	Frequency (MHz)
00	2402	20	2422	40	2442	60	2462
01	2403	21	2423	41	2443	61	2463
02	2404	22	2424	42	2444	62	2464
03	2405	23	2425	43	2445	63	2465
04	2406	24	2426	44	2446	64	2466
05	2407	25	2427	45	2447	65	2467
06	2408	26	2428	46	2448	66	2468
07	2409	27	2429	47	2449	67	2469
08	2410	28	2430	48	2450	68	2470
09	2411	29	2431	49	2451	69	2471
10	2412	30	2432	50	2452	70	2472
11	2413	31	2433	51	2453	71	2473
12	2414	32	2434	52	2454	72	2474
13	2415	33	2435	53	2455	73	2475
14	2416	34	2436	54	2456	74	2476
15	2417	35	2437	55	2457	75	2477
16	2418	36	2438	56	2458	76	2478
17	2419	37	2439	57	2459	77	2479
18	2420	38	2440	58	2460	78	2480
19	2421	39	2441	59	2461		

3.7. Description of Key Components

3.7.1. For the All Component Lists

Item	Supplier	Model / Type	Character
System	Microsoft	Win 10	---
		Win 10 Pro	---
		Win11 Home	---
Main Board	LG	ROYAL NVIDIA MAIN B/D PCB	Main Board (PM) Manufacturer: #1 Hannstar Board Tech (Jiang Yin) Corp.,Ltd. #2 Elec&Eltek Company (MCO) Limited. CPU (Socket: BGA1744)
		ROYAL MAIN B/D PCB	Main Board (GM) Manufacturer: #1 Hannstar Board Tech (Jiang Yin) Corp.,Ltd. #2 Elec&Eltek Company (MCO) Limited. CPU (Socket: BGA1744)
		MTL MAIN B/D	Main Board (MTL) Manufacturer: #1 Hannstar Board Tech (Jiang Yin) Corp.,Ltd. #2 Elec&Eltek Company (MCO) Limited. CPU (Socket: BGA2049)
WLAN SUB Board	LG	17Z90R SUB B/D	Manufacturer: #1 Hannstar Board Tech (Jiang Yin)Corp.,Ltd. #2 JiangSuHuaShen Electronic co.,Ltd (HXF) #3 Elec&Eltek Company (MCO) Limited.
CPU (Socket: BGA1744)	Intel	i7-1360P	2.2GHz
	Intel	i5-1340P	1.9GHz
	Intel	i7-1370P	1.9GHz
	Intel	i5-1350P	1.9GHz
CPU (Socket: BGA2049)	Intel	Ultra 7 155H*	3.8GHz
	Intel	Ultra 5 125H*	3.6GHz
17" LCD Panel	LG Display	LP170WQ1-SPF2	Resolution: 2560 x 1600, 60Hz WQXGA IPS #1 Without Touch #2 With Touch
		LP170WQ2-SPB1	Resolution: 2560 x 1600, 144Hz WQXGA IPS
Storage (SSD)	SK hynix	---	2TB/1TB/512GB/256GB
	Samsung	---	2TB/1TB/512GB/256GB
Memory (RAM)	Samsung	---	32GB/16GB/8GB LPDDR5x(On Board)
	SK Hynix	---	32GB/16GB/8GB LPDDR5x(On Board)
Battery Pack	LG	LBY122CM	90Wh with PM M/B, DC 7.76V, 90Wh
	LG	LBV7227E	80Wh with GM M/B DC 7.74V, 80Wh
	LG	LB3122MM*	77Wh with MTL M/B DC 15.52V, 77Wh

Item	Supplier	Model / Type	Character
WLAN Combo Card	Intel	AX211D2W	WLAN and BT, 2x2 PCIe M.2 1216 SD adapter card FCC ID: PD9AX211D2 IC: 1000M-AX211D2
WLAN Combo Antenna	LG (INPAQ)	WA-P-LELE-04-011	PCB, Mono-pole Type Main: Black, Aux: Gray
	LG (INPAQ)	WA-P-LBLB-04-108	PCB, Mono-pole Type Main: Black, Aux: Gray
	LG (LUXSHARE-ICT)	L1LRF009-CS-H	PCB, Mono-pole Type Main: Black, Aux: Gray
Touch Pad	LITE-ON	SP8001(SG-A0630-00A)	---
	ELAN	SD081A-36H0	---
Keyboard	TIC	KT0120B9	---
	LITE ON	SN8B02	---
Web Camera	Chicony	CKFLF26	---
	Luxvisions	1BF225N3	---
LAN Gender (Type C to LAN)	SUZHOU MEC ELECTRONICS	80-5946-111	(White) 10/100Megabit Ethernet
		80-5946-101	(Black) 10/100 Megabit Ethernet
	ARIN TECH CO. LTD	GD-08MF-36-WH-LP10	(White) 10/100Megabit Ethernet
		GD-08MF-36-BK-LP11	(Black) 10/100 Megabit Ethernet
	HUIZHOU DEHONG TECHNOLOGY CO.,LTD.	370-50713	(White) 10/100Megabit Ethernet
		370-50714	(Black) 10/100 Megabit Ethernet
Type C to LAN: Shielded, Undetached, 0.12m			
AC Adapter	LG (PI ELECTRONICS)	LP65WFC20P-NJ W	(White) I/P: AC 100-240V, 1.6A, 50-60Hz O/P:DC5V,3A(15W) or DC9V, 3A(27W)or 15V,3A (15W) or 20V,3.25A (65W) Wall-Mounted: (2C)
	LG (PI ELECTRONICS)	LP65WFC20P-NJ B	(Black) I/P: AC 100-240V, 1.6A, 50-60Hz O/P:DC5V,3A(15W) or DC9V, 3A(27W)or 15V,3A (15W) or 20V,3.25A (65W) Wall-Mounted: (2C)
Type C Cable	#1 Shielded, Detached, 2.0m (5A)		
	#2 Shielded, Detached, 1.8m (3A)*		
Note: "*" Standing for adding new configuration.			

Remark: For more detailed features description, please refer to the manufacturer's specifications or the user manual.

3.7.2. The EUT collocates with following worst components, which are used to establish a basic configuration of system during test:

SKU (Mode)		1	2	3	
Main Board	LG, MTL MAIN B/D	V	V	V	
WLAN SUB Board	LG, 17Z90R SUB B/D	V	V	V	
CPU	Intel, Ultra 7 155H	V		V	
	Intel, Ultra 5 125H		V		
17" LCD Panel	LG Display, LP170WQ1-SPF2 without Touch	V	V		
	LG Display, LP170WQ1-SPF2 with Touch			V	
Storage (SSD)	Samsung, 2TB	V	V	V	
	Samsung, 256GB	V	V	V	
Memory (RAM)	Samsung, 32GB	V	V	V	
Battery Pack	LG, 77Wh	V	V	V	
Touch Pad	LITE-ON	V	V	V	
Keyboard	TIC	V	V	V	
Web Camera	Chicony	V	V	V	
WLAN Combo Card	Intel, AX211D2W	V	V	V	
WLAN Combo Antenna	LG (INPAQ), WA-P-LELE-04-011	V			
	LG (LUXSHARE-ICT), L1LRF009-CS-H		V		
	LG (INPAQ), WA-P-LBLB-04-108			V	
Type C #1	AC Adapter	LG (PI ELECTRONICS), LP65WFC20P-NJ W	V	V	V
Type C #2	Link to LAN Gender	MEC (White)	V	V	V

3.8. Test Configuration

Mode	Duty Cycle (x)	T (ms)	Duty Cycle Correction Factor (dB)
BT	N/A	2.900	N/A

AC Conduction	
SKU #1	Normal operation
SKU #2	Normal operation
SKU #3	Normal operation

Item	Mode	Data Rate	Test Channel		
Radiated Test Case	SKU #1	Radiated Spurious Emission (30MHz~1GHz)	GFSK	1Mbps	78
	SKU #2		GFSK	1Mbps	78
	SKU #3		GFSK	1Mbps	78

Item	Modulation	Data Rate	Test Channel		
Radiated Test Case	SKU #1	Radiated Band Edge ^{Note 1 & 2}	8-DPSK	3Mbps	78
	SKU #2		8-DPSK	3Mbps	78
	SKU #3		8-DPSK	3Mbps	78
	SKU #1	Radiated Spurious Emission ^{Note1}	GFSK	1Mbps	39
	SKU #2		GFSK	1Mbps	78
	SKU #3		GFSK	1Mbps	39
Conducted Test Case	SKU #1	Maximum Peak Output Power (SPOT Check)	GFSK	1Mbps	00/39/78
	SKU #2		8-DPSK	3Mbps	00/39/78
	SKU #3		GFSK	1Mbps	00/39/78
			8-DPSK	3Mbps	00/39/78

Note 1: Mobile Device Portable Device,
 and 3 axis were assessed. The worst scenario for Radiated Spurious Emission as follow: Lie Side Stand
 Note 2: We performed testing of the highest and lowest data rate.

3.9. Output Power Setting

Centre Frequency (MHz)	Power Setting	
	GFSK	8-DPSK
2402	12	7
2441	12	7
2480	12	7

3.10. Tested Supporting System List

3.10.1. Support Peripheral Unit

No.	Product	Brand	Model No.	Serial No.	Approval
1.	LCD Monitor	DELL	U2718Qb	CN-0M5R5F-QDC 00-99P-04CL	N/A
2.	USB Mouse	Lenovo	SM-8823	8SSM50L24506AV LC99H049R	N/A
3.	Earphone	APPLE	N/A	N/A	N/A
4.	SD Card	ADATA	MicroSDHC Card	N/A	N/A
Partner System					
5	AP Server	ASUS	RT-AX88U	N/A	FCC ID: MSQ-RTAXHP00 IC: 3568A-RTAXHP00

3.10.2. Cable Lists

No.	Cable Description Of The Above Support Units
1.	HDMI Cable: Shielded, Detachable, 1.8 AC Power Cord: Unshielded, Detachable, 1.8m
2.	USB Cable: Unshielded, Undetachable, 1.8
3.	Earphone Cable: Unshielded, Undetachable, 1.2m
4.	N/A
5.	AC adapter: M/N:WA-30B12, Cable: Unshielded, Detachable, 1.2m LAN cable: Unshielded, Detachable, 3.0m
6.	LAN cable: Unshielded, Detachable, 1.8m

3.11. Setup Configuration

3.11.1. EUT Configuration for Power Line & Radiated Emission

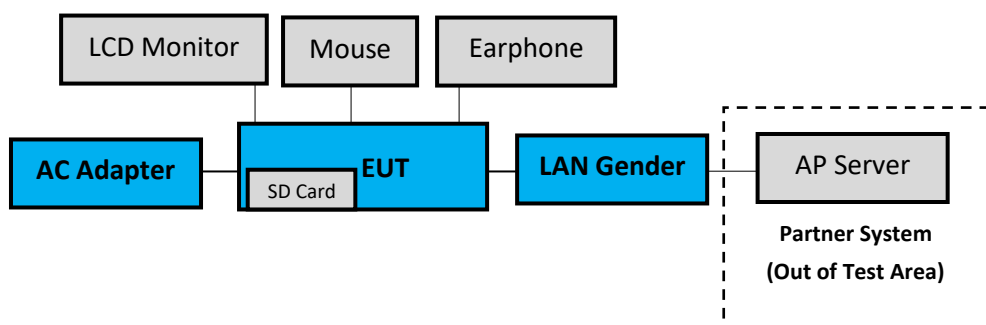

3.11.2. EUT Configuration for RF Conducted Test Items



3.12. Operating Condition of EUT

Test program “DRTU” is used for enabling EUT BT function under continues transmitting and choosing data rate/ channel.

3.13. Description of Test Facility

Name of Test Firm	Audix Technology Corporation / EMC Department No. 491, Zhongfu Rd., Linkou Dist., New Taipei City 244, Taiwan Tel: +886-2-26092133 Fax: +886-2-26099303 Website : www.audixtech.com Contact e-mail: attemc_report@audixtech.com
Accreditations	The laboratory is accredited by following organizations under ISO/IEC 17025:2017 (1) NVLAP(USA) NVLAP Lab Code 200077-0 (2) TAF(Taiwan) No. 1724
Test Facilities	FCC OET Designation Number under APEC MRA by NCC is : TW1724 ISED CAB Identifier Number under APEC TEL MRA by NCC is TW1724 (1) No.8 Shielded Room (2) No.1 3m Semi Anechoic Chamber

3.14.Measurement Uncertainty

The measurement uncertainty levels have been estimated as specified in ETSI TR 100 028-2001

Test Items/Facilities		Frequency Range	Uncertainty	
Conduction Test	<input type="checkbox"/>	No. 7 Shielded Room	9kHz-150kHz	±3.7dB
			150kHz-30MHz	±3.4dB
	<input checked="" type="checkbox"/>	No. 8 Shielded Room	9kHz-150kHz	±3.7dB
			150kHz-30MHz	±3.5dB
Radiation Test	<input checked="" type="checkbox"/>	No.1 3m Semi Anechoic Chamber	30MHz-200MHz, 3m, Horizontal	±3.6dB
			200MHz-1000MHz, 3m, Horizontal	±4.3dB
			30MHz-200MHz, 3m, Vertical	±4.4dB
			200MHz-1000MHz, 3m, Vertical	±4.8dB
			1GHz-6GHz, 3m	±4.8dB
			6GHz-18GHz, 3m	±4.5dB
	<input type="checkbox"/>	No.3 3m Semi Anechoic Chamber	30MHz-200MHz, 3m, Horizontal	±4.0dB
			200MHz-1000MHz, 3m, Horizontal	±4.4dB
			30MHz-200MHz, 3m, Vertical	±4.7dB
			200MHz-1000MHz, 3m, Vertical	±4.5dB
			1GHz-6GHz, 3m	±4.8dB
			6GHz-18GHz, 3m	±4.5dB
	<input type="checkbox"/>	No.4 3m Semi Anechoic Chamber	30MHz-200MHz, 3m, Horizontal	±4.3dB
			200MHz-1000MHz, 3m, Horizontal	±4.2dB
			30MHz-200MHz, 3m, Vertical	±4.8dB
			200MHz-1000MHz, 3m, Vertical	±4.7dB
			1GHz-6GHz, 3m	±4.6dB
			6GHz-18GHz, 3m	±4.4dB
	<input type="checkbox"/>	No.5 3m Semi Anechoic Chamber	30MHz-200MHz, 3m, Horizontal	±4.6dB
			200MHz-1000MHz, 3m, Horizontal	±4.4dB
			30MHz-200MHz, 3m, Vertical	±4.5dB
			200MHz-1000MHz, 3m, Vertical	±4.9dB
			1GHz-6GHz, 3m	±4.9dB
			6GHz-18GHz, 3m	±4.6dB
	Radiated emissions (18GHz-40GHz)		18GHz-40GHz, 3m	±3.4dB

Remark : Uncertainty = $ku_c(y)$

Test Item	Uncertainty
Maximum peak Output power	± 0.52dB

4. MEASUREMENT EQUIPMENT LIST

4.1. Conducted Emission Measurement

Item	Type	Manufacturer	Model No.	Serial No.	Cal. Date	Cal. Interval
1.	Test Receiver	R&S	ESR3	101774	2023.01.11	1 Year
2.	A.M.N.	R&S	ENV432	101567	2023.06.02	1 Year
3.	L.I.S.N.	Kyoritsu	KNW-407	8-855-9	2022.12.19	1 Year
4.	Pulse Limiter	R&S	ESH3-Z2	100354	2022.12.14	1 Year
5.	Digital Thermo-Hygro Meter	iMax	HTC-1	No.8 S/R	2023.04.13	1 Year
6.	Coaxial Cable	Yeida	RG/58AU	CE-08	2023.09.06	1 Year
7.	Test Software	Audix	e3	V9 18621a	N.C.R.	N.C.R.

4.2. Radiated Emission Measurement

Item	Type	Manufacturer	Model No.	Serial No.	Cal. Date	Cal. Interval
1.	Spectrum Analyzer	Agilent	N9010A-526	MY53400071	2023.08.16	1 Year
2.	Test Receiver	R&S	ESCS30	100338	2023.06.20	1 Year
3.	Amplifier	HP	8447D	2944A06305	2022.12.29	1 Year
4.	Microwave Amplifier	Keysight	83051A	MY56480113	2023.09.11	1 Year
5.	Microwave Amplifier	Agilent	8449B	3008A02678	2023.02.17	1 Year
6.	Loop Antenna	TESEQ	HLA 6121	60478	2023.02.21	1 Year
7.	Bilog Antenna	TESEQ	CBL6112D	33821	2023.06.30	1 Year
8.	Horn Antenna	EMCO	3115	9609-4927	2023.07.21	1 Year
9.	Horn Antenna	COM-POWER	AH-840	101092	2022.12.30	1 Year
10.	2.4GHz Notch Filter	K&L Microwave	7NSL10-2441.5/E 130.5-O/O	2	2023.07.22	1 Year
11.	3GHz Notch Filter	Microwave	H3G018G1	484796	2023.07.22	1 Year
12.	Coaxial Cable	MIYAZAKI	5D2W	RE-11	2023.01.07	1 Year
13.	Coaxial Cable	HUBER+SUHNER	RG223/U	RE-33	2023.03.02	1 Year
14.	Coaxial Cable	HUBER+SUHNER	SUCOFLEX 106	RE-14	2023.01.07	1 Year
15.	Coaxial Cable	HUBER+SUHNER	SUCOFLEX 102	RE-30	2023.08.21	1 Year
16.	Digital Thermo-Hygro Meter	iMax	HTC-1	No.1 3m A/C	2023.04.13	1 Year
17.	Test Software	Audix	e3	V9 18621a	N.C.R.	N.C.R.

4.3. RF Conducted Measurement

Item	Type	Manufacturer	Model No.	Serial No.	Cal. Date	Cal. Interval
1.	Power Meter	Anritsu	ML2495A	2127005	2022. 12. 01	1 Year
2.	Power Sensor	Anritsu	MA2411B	1911360	2022. 12. 07	1 Year
3.	Digital Thermo-Hygro Meter	iMax	HTC-1	RF-03	2023. 04. 13	1 Year

5. CONDUCTED EMISSION

5.1. Block Diagram of Test Setup

5.1.1. Block Diagram of EUT

Indicated as section 3.11

5.1.2. Shielded Room Setup Diagram

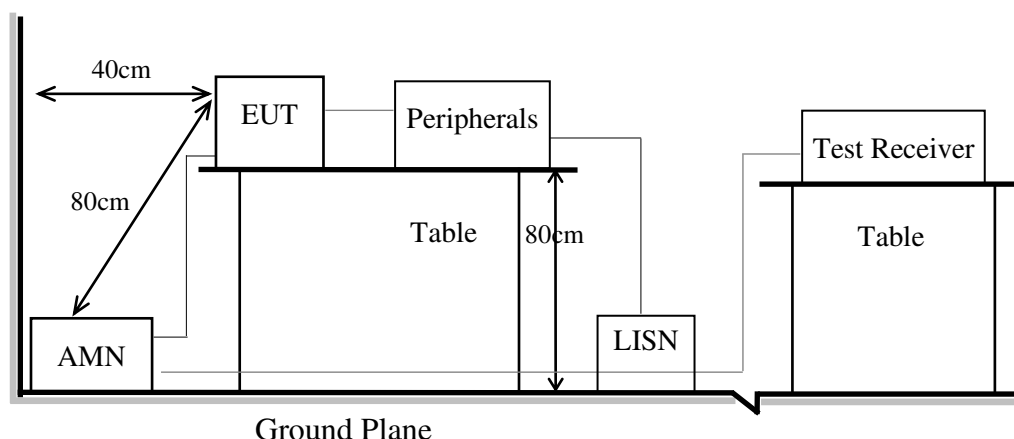

5.2. Conducted Emission Limit

Frequency	Conducted Limit	
	Quasi-Peak Level	Average Level
150kHz ~ 500kHz	66 ~ 56 dB μ V	56 ~ 46 dB μ V
500kHz ~ 5MHz	56 dB μ V	46 dB μ V
5MHz ~ 30MHz	60 dB μ V	50 dB μ V

Remark1.: If the average limit is met when using a Quasi-Peak detector, the measurement using the average detector is not required.

2.: The lower limit applies to the band edges.

5.3. Test Procedure

- 5.3.1. To set up the EUT as indicated in ANSI C63.10. The EUT was placed on the table which has 80 cm height to the ground and 40 cm distance to the conducting wall.
- 5.3.2. Power supplier of the EUT was connected to the AC mains through an Artificial Mains Network (A.M.N.).
- 5.3.3. The AC power supplies to all peripheral devices must be provided through line impedance stabilization network (L.I.S.N.)
- 5.3.4. Checking frequency range from 150kHz to 30 MHz and record the emission which does not have 20 dB below limit.

5.4. Test Results

Please refer to Appendix A.

6. RADIATED EMISSION

6.1. Block Diagram of Test Setup

6.1.1. Block Diagram of EUT

Indicated as section 3.11

6.1.2. Setup Diagram for 9kHz-30MHz

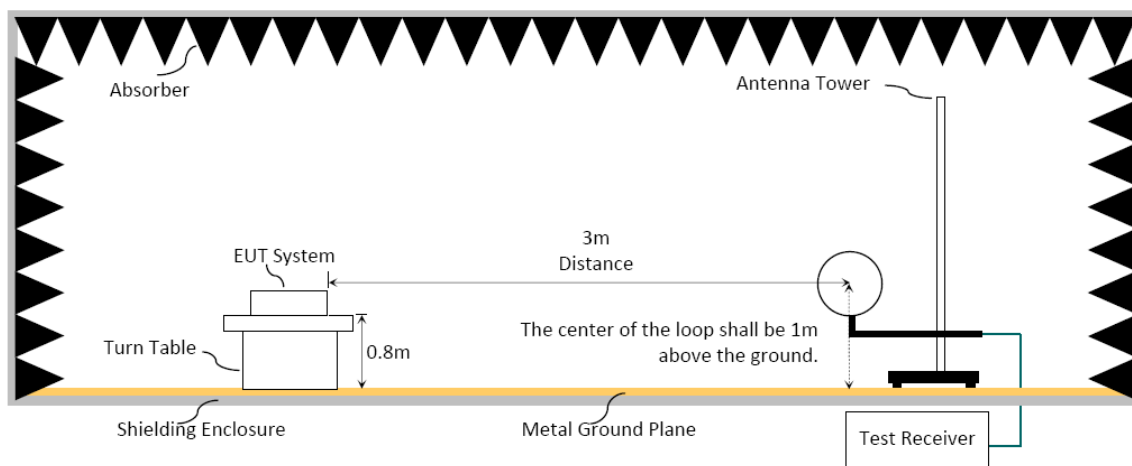

6.1.3. Setup Diagram for 30-1000MHz

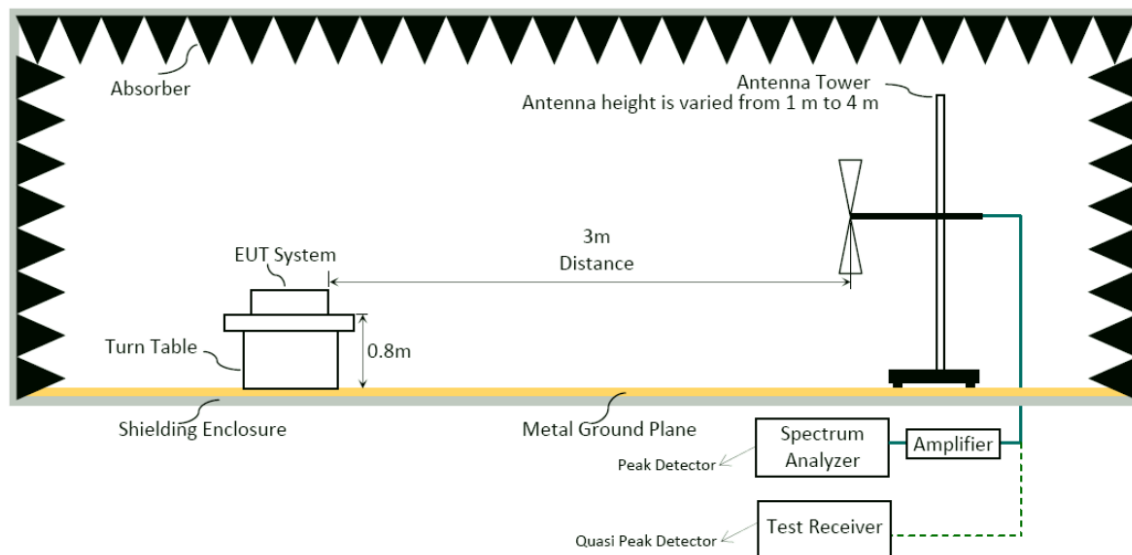

6.1.4. Setup Diagram for above 1GHz

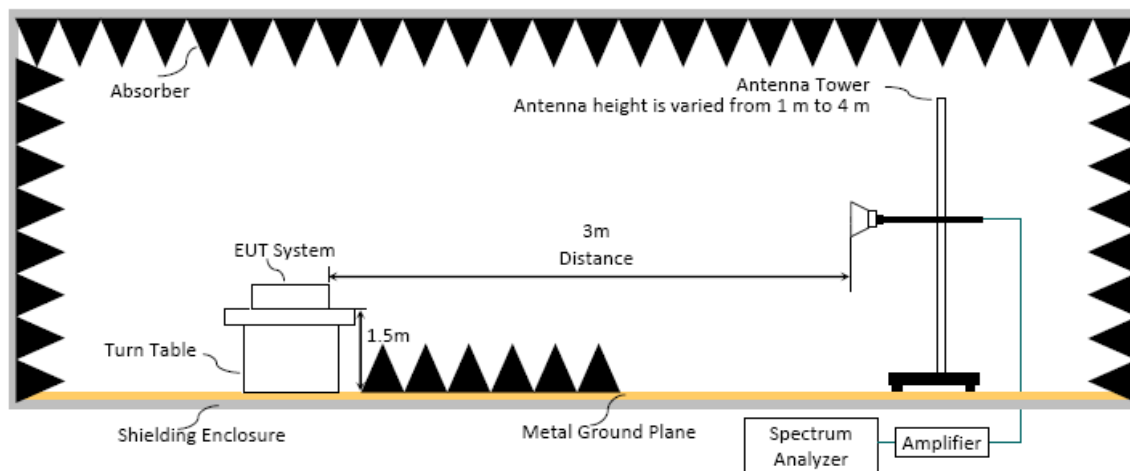

6.2. Radiated Emission Limits

In any 100kHz bandwidth outside the frequency band, the radio frequency power produced by the intentional radiator shall be at least 20dB below that in the 100kHz bandwidth within the band that contains the highest level. In addition, radiated emissions which fall in restricted bands, as defined in Section 15.205/RSS-Gen Section 8.10 table 6, must also comply with the radiated emission limits specified as below.

Frequency (MHz)	Distance(m)	Limits	
		dB μ V/m	μ V/m
0.009 - 0.490	300	67.6-20 log f(kHz)	2400/f kHz
0.490 - 1.705	30	87.6-20 log f(kHz)	24000/f kHz
1.705 - 30	30	29.5	30
30 - 88	3	40.0	100
88- 216	3	43.5	150
216- 960	3	46.0	200
Above 960	3	54.0	500
Above 1000	3	74.0 dB μ V/m (Peak) 54.0 dB μ V/m (Average)	

Remark : (1) dB μ V/m = 20 log (μ V/m)

- (2) The tighter limit applies to the edge between two frequency bands.
- (3) Distance refers to the distance in meters between the measuring instrument antenna and the closed point of any part of the device or system.
- (4) Fundamental and emission fall within operation band are exempted from this section.
- (5) Pursuant to ANSI C63.10: 6.6.4.3, if the maximized peak measured value complies with the average limit, then it is unnecessary to perform an average measurement.

6.3. Test Procedure

Frequency Range 9kHz~30MHz:

The EUT setup on the turntable which has 0.8 m height to the ground. The turn table rotated 360 degrees and antenna fixed to 1 m to find the maximum emission level. In order to find the maximum emission, all of the interface cables were manipulated according to ANSI C63.10-2013 regulation.

- (1) RBW = 9kHz with peak and average detector.
- (2) Detector: average and peak (9kHz-490kHz)
Q.P. (490kHz-30MHz)

Frequency Range 30MHz ~ 25GHz:

The EUT setup on the turn table which has 80cm (for 30-1000MHz) and 1.5m (for above 1GHz) height to the ground. The turn table rotated 360 degrees and antenna varied from 1 m to 4 m to find the maximum emission level. Both horizontal and vertical polarization are required. In order to find the maximum emission, all of the interface cables were manipulated according to ANSI C63.10-2013 regulation.

Frequency below 1GHz:

Spectrum Analyzer is used for pre-testing with following setting:

- (1) RBW = 120KHz
- (2) VBW $\geq 3 \times$ RBW.
- (3) Detector = Peak.
- (4) Sweep time = auto.
- (5) Trace mode = max hold.
- (6) Allow sweeps to continue until the trace stabilizes.

Note 1: When peak-detected value is lower than limit that the measurement using the Q.P. detector is not required, otherwise using Q.P. for final measurement.

Note 2: When the radiated emissions limits are expressed in terms of the average value of the emissions, and pulsed operation is employed, the measurement field strength shall be determined by averaging over one complete pulse train, including blanking intervals, as long as the pulse train does not exceed 0.1 seconds.

Frequency above 1GHz to 10th harmonic(up to 25 GHz):

Peak Detector:

- (1) RBW = 1MHz
- (2) VBW $\geq 3 \times$ RBW.
- (3) Detector = Peak.
- (4) Sweep time = auto.
- (5) Trace mode = max hold.
- (6) Allow sweeps to continue until the trace stabilizes.

Note: When peak-detected value is lower than limit that the measurement using the average detector is not required, otherwise using average detector for final measurement.

Average Detector:

Option 1:

(1) RBW = 1MHz

(2) VBW \geq 1/ T

Mode	TX _{on} (ms)	1/ TX _{on} (kHz)	VBW(>1/ TX _{on}) (kHz)
BT	2.900	0.345	3

(3) Detector = Peak.

(4) Sweep time = auto.

(5) Trace mode = max hold.

(6) Allow sweeps to continue until the trace stabilizes.

Option 2:

Average Emission Level = Peak Emission Level + D.C.C.F.

6.4. Measurement Result Explanation

Peak Emission Level (dB μ V/m) = Antenna Factor (dB/m) + Cable Loss (dB) – Preamp Gain (dB) + Reading (dB μ V).

Average Emission Level (dB μ V/m) = Antenna Factor (dB/m) + Cable Loss (dB) – Preamp Gain (dB) + Reading (dB μ V).

Average Emission Level (dB μ V/m) = Peak Emission Level (dB μ V/m) + DCCF (dB) Duty Cycle Correction Factor (DCCF) (dB) = $20\log(\text{TX}_{\text{on}}/\text{TX}_{\text{on+off}})$ presented in section 3.8.

ERP (dBm) = Peak Emission Level (dB μ V/m) - 95.2dB - 2.14dB

6.5. Test Results

Please refer to Appendix A.

7. MAXIMUM PEAK OUTPUT POWER

7.1. Block Diagram of Test Setup

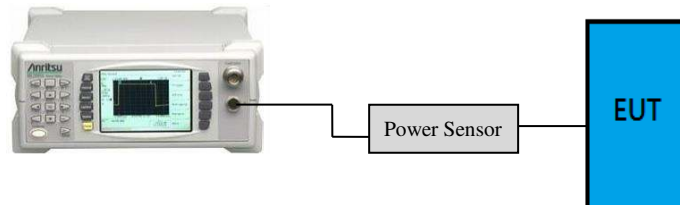

7.2. Specification Limits

The Limits of maximum Peak Output Power for frequency hopping systems in 2400-2483.5MHz is: 0.125Watt. (21dBm)

7.3. Test Procedure

EUT is connected to power sensor and record the maximum output power.

7.4. Test Results

Please refer to Appendix A



8. DEVIATION TO TEST SPECIFICATIONS

【NONE】



Audix Technology Corp.
No. 491, Zhongfu Rd., Linkou Dist.,
New Taipei City 244, Taiwan

APPENDIX A

Tel: +886 2 26099301
Fax: +886 2 26099303

APPENDIX A

TEST DATA AND PLOTS

(Model: 17Z90S)

TABLE OF CONTENTS

A.1 CONDUCTED EMISSION	2
A.2 RADIATED EMISSION	8
A.2.1 Emissions within Restricted Frequency Bands.....	8
A.2.2 Emissions outside the frequency band:.....	16
A.2.3 Emissions in Non-restricted Frequency Bands:.....	16
A.3 MAXIMUM PEAK OUTPUT POWER	17
A.3.1 Peak Output Power	17

A.1 CONDUCTED EMISSION

Test Date	2023/10/06	Temp./Hum.	24°C/55%
Test Voltage	AC 120V 60Hz (Via AC Adapter)	Tested By	Roy Hung
Test SKU	SKU #1 [with (INPAQ) WA-P-LELE-04-011 Antenna]		

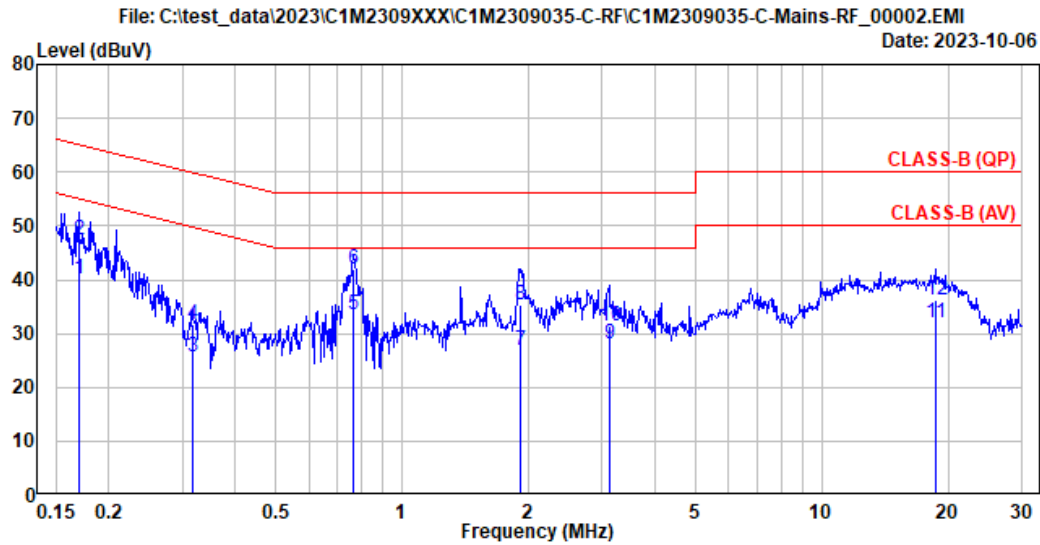

Site No.	: No.8 Shielded Room	Data No.	: 2
Instrument 1	: Receiver ESR(774)		
Instrument 2	: ENV432 (567)(A) CE-08 ESH3-Z2 (354)		
Limit	: CLASS-B (QP)	Phase	: Neutral
Environment	: 24°C/55%	Test Rating	: 120Vac/60Hz
EUT Model	: 17290S	Engineer	: Roy Hung
Test Mode	: Operating		
	Inpaq		

	Freq. (MHz)	AMN Factor (dB)	Cable Loss (dB)	Pulse Att. (dB)	Reading (dBµV)	Emission Level (dBµV)	Limits (dBµV)	Margin (dB)	Remark
1	0.170	10.30	0.03	9.85	20.04	40.22	54.97	14.75	Average
2	0.170	10.30	0.03	9.85	27.29	47.47	64.97	17.50	QP
3	0.317	10.28	0.03	9.85	5.60	25.76	49.79	24.03	Average
4	0.317	10.28	0.03	9.85	11.51	31.67	59.79	28.12	QP
5	0.765	10.29	0.04	9.85	13.36	33.54	46.00	12.46	Average
6	0.765	10.29	0.04	9.85	21.73	41.91	56.00	14.09	QP
7	1.915	10.32	0.06	9.86	6.78	27.02	46.00	18.98	Average
8	1.915	10.32	0.06	9.86	15.21	35.45	56.00	20.55	QP
9	3.122	10.35	0.07	9.86	7.91	28.19	46.00	17.81	Average
10	3.122	10.35	0.07	9.86	11.21	31.49	56.00	24.51	QP
11	18.684	10.94	0.19	9.93	10.79	31.85	50.00	18.15	Average
12	18.684	10.94	0.19	9.93	15.09	36.15	60.00	23.85	QP

Remarks: 1. Emission Level(dBµV)= AMN Factor(dB) + Cable Loss(dB) + Pulse Att.(dB) + Reading(dBµV).

Test Date	2023/10/06	Temp./Hum.	24°C/55%
Test Voltage	AC 120V 60Hz (Via AC Adapter)	Tested By	Roy Hung
Test SKU	SKU #1 [with (INPAQ) WA-P-LELE-04-011 Antenna]		

File: C:\test_data\2023\1M2309XXX\1M2309035-C-RF\1M2309035-C-Mains-RF_00001.EMI
 Date: 2023-10-06

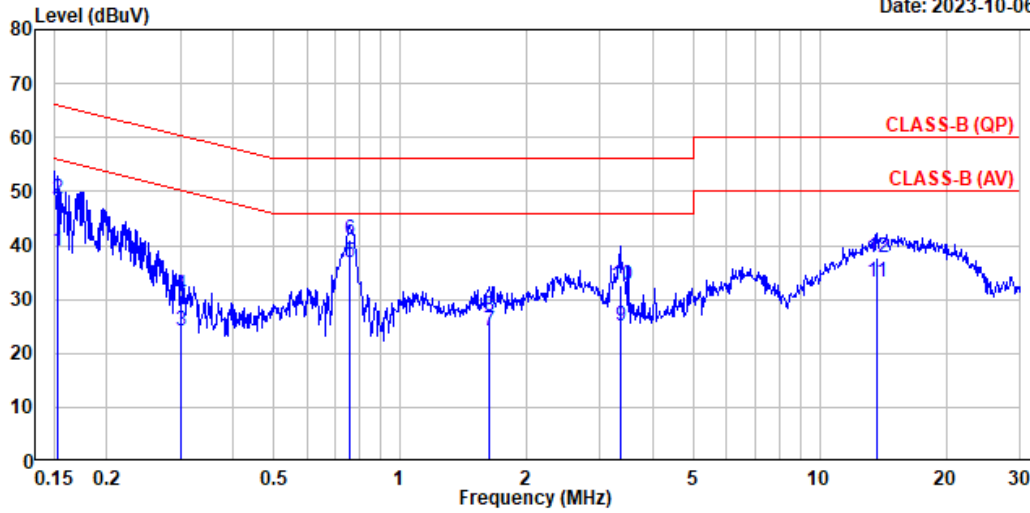

Site No.	: No.8 Shielded Room	Data No.	: 1
Instrument 1	: Receiver ESR(774)		
Instrument 2	: ENV432 (567)(A) CE-08 ESH3-Z2 (354)		
Limit	: CLASS-B (QP)	Phase	: Line
Environment	: 24°C/55%	Test Rating	: 120Vac/60Hz
EUT Model	: 17Z90S	Engineer	: Roy Hung
Test Mode	: Operating Inpaq		

	Freq. (MHz)	AMN Factor (dB)	Cable Loss (dB)	Pulse Att. (dB)	Reading (dBμV)	Emission Level (dBμV)	Limits (dBμV)	Margin (dB)	Remark
1	0.153	10.30	0.03	9.85	18.81	38.99	55.83	16.84	Average
2	0.153	10.30	0.03	9.85	28.43	48.61	65.83	17.22	QP
3	0.300	10.27	0.03	9.85	3.93	24.08	50.25	26.17	Average
4	0.300	10.27	0.03	9.85	10.65	30.80	60.25	29.45	QP
5	0.758	10.28	0.04	9.85	16.69	36.86	46.00	9.14	Average
6	0.758	10.28	0.04	9.85	20.82	40.99	56.00	15.01	QP
7	1.625	10.29	0.05	9.86	3.83	24.03	46.00	21.97	Average
8	1.625	10.29	0.05	9.86	6.72	26.92	56.00	29.08	QP
9	3.347	10.32	0.07	9.86	4.75	25.00	46.00	21.00	Average
10	3.347	10.32	0.07	9.86	12.20	32.45	56.00	23.55	QP
11	13.649	10.58	0.16	9.91	12.58	33.23	50.00	16.77	Average
12	13.649	10.58	0.16	9.91	17.08	37.73	60.00	22.27	QP

Remarks: 1. Emission Level(dBμV)= AMN Factor(dB) + Cable Loss(dB) + Pulse Att.(dB) + Reading(dBμV).

Test Date	2023/10/06	Temp./Hum.	24°C/55%
Test Voltage	AC 120V 60Hz (Via AC Adapter)	Tested By	Roy Hung
Test SKU	SKU #2 [with (LUXSHARE-ICT) L1LRF009-CS-H Antenna]		

File: C:\test_data\2023\1M2309XXX\1M2309035-C-RF\1M2309035-C-Mains-RF_00008.EMI
 Date: 2023-10-06

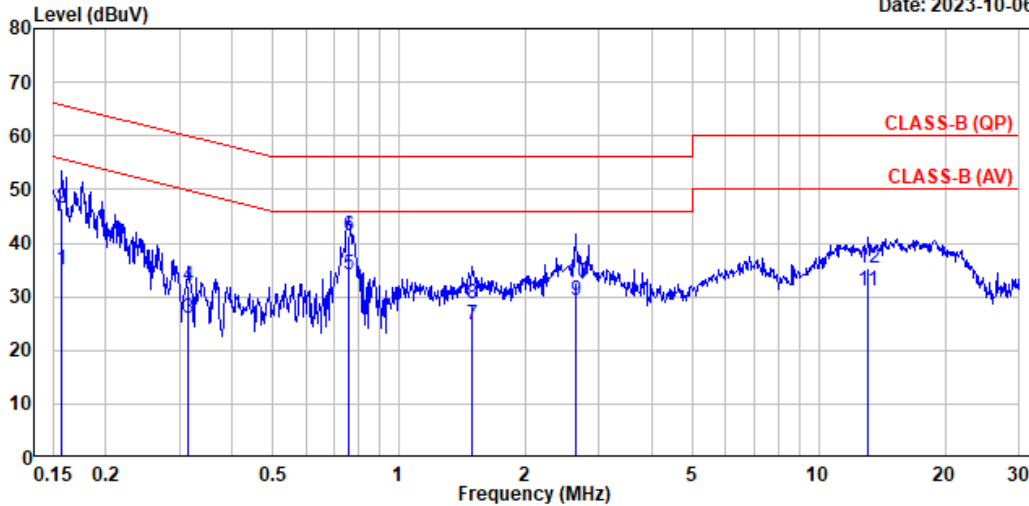

Site No.	: No.8 Shielded Room	Data No.	: 8
Instrument 1	: Receiver ESR(774)		
Instrument 2	: ENV432 (567)(A) CE-08 ESH3-Z2 (354)		
Limit	: CLASS-B (QP)	Phase	: Neutral
Environment	: 24°C/55%	Test Rating	: 120Vac/60Hz
EUT Model	: 17Z90S	Engineer	: Roy Hung
Test Mode	: Operating Luxshare		

	Freq. (MHz)	AMN Factor (dB)	Cable Loss (dB)	Pulse Att. (dB)	Reading (dBµV)	Emission Level (dBµV)	Limits (dBµV)	Margin (dB)	Remark
1	0.157	10.30	0.03	9.85	14.90	35.08	55.63	20.55	Average
2	0.157	10.30	0.03	9.85	26.37	46.55	65.63	19.08	QP
3	0.315	10.28	0.03	9.85	5.85	26.01	49.83	23.82	Average
4	0.315	10.28	0.03	9.85	11.73	31.89	59.83	27.94	QP
5	0.762	10.29	0.04	9.85	14.02	34.20	46.00	11.80	Average
6	0.762	10.29	0.04	9.85	21.30	41.48	56.00	14.52	QP
7	1.493	10.31	0.05	9.86	4.61	24.83	46.00	21.17	Average
8	1.493	10.31	0.05	9.86	8.58	28.80	56.00	27.20	QP
9	2.635	10.34	0.07	9.86	8.95	29.22	46.00	16.78	Average
10	2.635	10.34	0.07	9.86	12.28	32.55	56.00	23.45	QP
11	13.116	10.73	0.16	9.90	10.39	31.18	50.00	18.82	Average
12	13.116	10.73	0.16	9.90	14.56	35.35	60.00	24.65	QP

Remarks: 1. Emission Level(dBµV)= AMN Factor(dB) + Cable Loss(dB) + Pulse Att.(dB) + Reading(dBµV).

Test Date	2023/10/06	Temp./Hum.	24°C/55%
Test Voltage	AC 120V 60Hz (Via AC Adapter)	Tested By	Roy Hung
Test SKU	SKU #2 [with (LUXSHARE-ICT) L1LRF009-CS-H Antenna]		

File: C:\test_data\2023\C1M2309XXX\C1M2309035-C-RF\C1M2309035-C-Mains-RF_00007.EMI Date: 2023-10-06

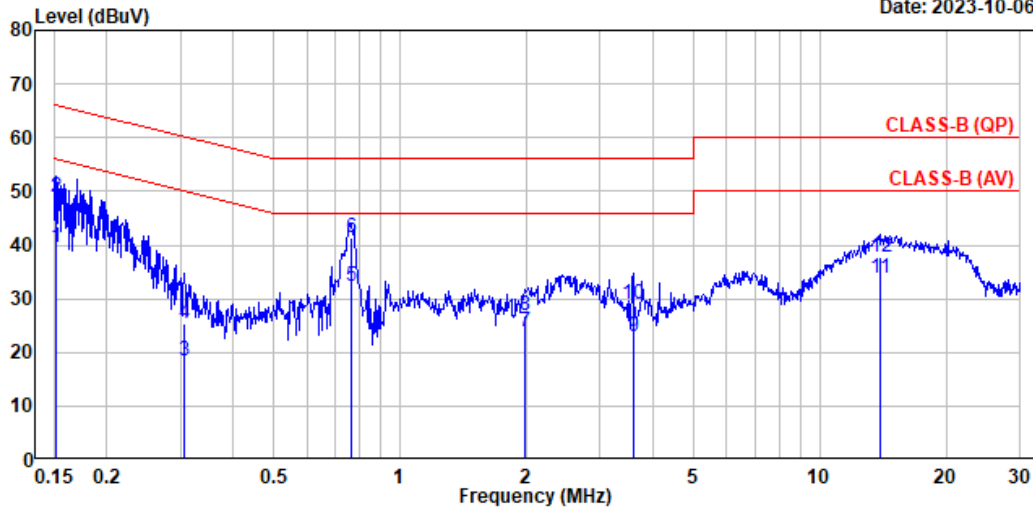

Site No.	: No.8 Shielded Room	Data No.	: 7
Instrument 1	: Receiver ESR(774)		
Instrument 2	: ENV432 (567)(A) CE-08 ESH3-Z2 (354)		
Limit	: CLASS-B (QP)	Phase	: Line
Environment	: 24°C/55%	Test Rating	: 120Vac/60Hz
EUT Model	: 17Z90S	Engineer	: Roy Hung
Test Mode	: Operating Luxshare		

	Freq. (MHz)	AMN Factor (dB)	Cable Loss (dB)	Pulse Att. (dB)	Reading (dBμV)	Emission Level (dBμV)	Limits (dBμV)	Margin (dB)	Remark
1	0.152	10.30	0.03	9.85	19.25	39.43	55.92	16.49	Average
2	0.152	10.30	0.03	9.85	28.78	48.96	65.92	16.96	QP
3	0.306	10.27	0.03	9.85	-1.68	18.47	50.08	31.61	Average
4	0.306	10.27	0.03	9.85	5.18	25.33	60.08	34.75	QP
5	0.765	10.28	0.04	9.85	12.25	32.42	46.00	13.58	Average
6	0.765	10.28	0.04	9.85	21.04	41.21	56.00	14.79	QP
7	1.983	10.30	0.06	9.86	3.71	23.93	46.00	22.07	Average
8	1.983	10.30	0.06	9.86	6.56	26.78	56.00	29.22	QP
9	3.589	10.33	0.08	9.86	2.53	22.80	46.00	23.20	Average
10	3.589	10.33	0.08	9.86	8.75	29.02	56.00	26.98	QP
11	13.924	10.58	0.16	9.91	13.02	33.67	50.00	16.33	Average
12	13.924	10.58	0.16	9.91	17.23	37.88	60.00	22.12	QP

Remarks: 1. Emission Level(dBμV)= AMN Factor(dB) + Cable Loss(dB) + Pulse Att.(dB) + Reading(dBμV).

Audix Technology Corp.
 No. 491, Zhongfu Rd., Linkou Dist.,
 New Taipei City 244, Taiwan

Tel: +886 2 26099301
 Fax: +886 2 26099303

Test Date	2023/10/06	Temp./Hum.	24°C/55%
Test Voltage	AC 120V 60Hz (Via AC Adapter)	Tested By	Roy Hung
Test SKU	SKU #3 [with (INPAQ) WA-P-LBLB-04-108 Antenna]		

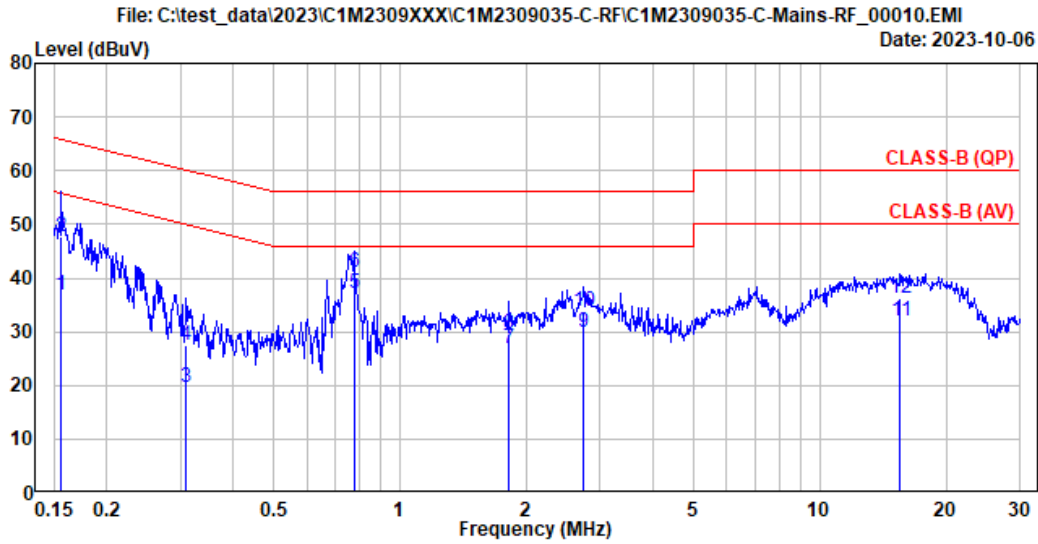

Site No.	: No.8 Shielded Room	Data No.	: 10
Instrument 1	: Receiver ESR(774)		
Instrument 2	: ENV432 (567)(A) CE-08 ESH3-Z2 (354)		
Limit	: CLASS-B (QP)	Phase	: Neutral
Environment	: 24°C/55%	Test Rating	: 120Vac/60Hz
EUT Model	: 17Z90S	Engineer	: Roy Hung
Test Mode	: Operating Touch		

	Freq. (MHz)	AMN Factor (dB)	Cable Loss (dB)	Pulse Att. (dB)	Reading (dBμV)	Emission Level (dBμV)	Limits (dBμV)	Margin (dB)	Remark
1	0.156	10.30	0.03	9.85	16.76	36.94	55.67	18.73	Average
2	0.156	10.30	0.03	9.85	27.64	47.82	65.67	17.85	QP
3	0.309	10.28	0.03	9.85	-0.54	19.62	50.00	30.38	Average
4	0.309	10.28	0.03	9.85	7.44	27.60	60.00	32.40	QP
5	0.777	10.29	0.04	9.85	16.82	37.00	46.00	9.00	Average
6	0.777	10.29	0.04	9.85	20.74	40.92	56.00	15.08	QP
7	1.822	10.32	0.06	9.86	6.49	26.73	46.00	19.27	Average
8	1.822	10.32	0.06	9.86	9.47	29.71	56.00	26.29	QP
9	2.742	10.34	0.07	9.86	9.62	29.89	46.00	16.11	Average
10	2.742	10.34	0.07	9.86	13.40	33.67	56.00	22.33	QP
11	15.538	10.83	0.17	9.91	11.24	32.15	50.00	17.85	Average
12	15.538	10.83	0.17	9.91	15.46	36.37	60.00	23.63	QP

Remarks: 1. Emission Level(dBμV)= AMN Factor(dB) + Cable Loss(dB) + Pulse Att.(dB) + Reading(dBμV).

Test Date	2023/10/06	Temp./Hum.	24°C/55%
Test Voltage	AC 120V 60Hz (Via AC Adapter)	Tested By	Roy Hung
Test SKU	SKU #3 [with (INPAQ) WA-P-LBLB-04-108 Antenna]		

File: C:\test_data\2023\C1M2309XXX\C1M2309035-C-RF\C1M2309035-C-Mains-RF_00009.EMI
 Date: 2023-10-06

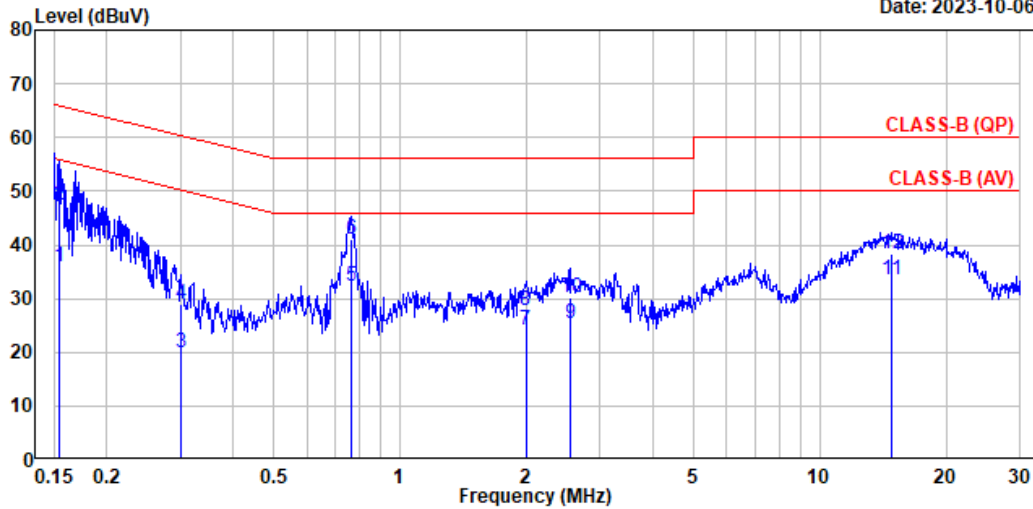

Site No.	: No.8 Shielded Room	Data No.	: 9
Instrument 1	: Receiver ESR(774)		
Instrument 2	: ENV432 (567)(A) CE-08 ESH3-Z2 (354)		
Limit	: CLASS-B (QP)	Phase	: Line
Environment	: 24°C/55%	Test Rating	: 120Vac/60Hz
EUT Model	: 17290S	Engineer	: Roy Hung
Test Mode	: Operating Touch		

	Freq. (MHz)	AMN Factor (dB)	Cable Loss (dB)	Pulse Att. (dB)	Reading (dBμV)	Emission Level (dBμV)	Limits (dBμV)	Margin (dB)	Remark
1	0.155	10.30	0.03	9.85	15.61	35.79	55.75	19.96	Average
2	0.155	10.30	0.03	9.85	27.09	47.27	65.75	18.48	QP
3	0.301	10.27	0.03	9.85	-0.17	19.98	50.20	30.22	Average
4	0.301	10.27	0.03	9.85	8.72	28.87	60.20	31.33	QP
5	0.765	10.28	0.04	9.85	12.27	32.44	46.00	13.56	Average
6	0.765	10.28	0.04	9.85	20.95	41.12	56.00	14.88	QP
7	1.993	10.30	0.06	9.86	3.94	24.16	46.00	21.84	Average
8	1.993	10.30	0.06	9.86	7.41	27.63	56.00	28.37	QP
9	2.545	10.31	0.07	9.86	5.02	25.26	46.00	20.74	Average
10	2.545	10.31	0.07	9.86	9.82	30.06	56.00	25.94	QP
11	14.782	10.61	0.17	9.91	12.83	33.52	50.00	16.48	Average
12	14.782	10.61	0.17	9.91	17.55	38.24	60.00	21.76	QP

Remarks: 1. Emission Level(dBμV)= AMN Factor(dB) + Cable Loss(dB) + Pulse Att.(dB) + Reading(dBμV).

A.2 RADIATED EMISSION

Test Date	2023/09/26~10/06	Temp./Hum.	23~25°C/55~63%
Test Voltage	AC 120V 60Hz (Via AC Adapter)	Tested By	(1)Martin Chen (2)Hua Wu

A.2.1 Emissions within Restricted Frequency Bands

A.2.1.1 Frequency 9kHz~30MHz

The emissions (9kHz~30MHz) not reported for there is no emission be found.

A.2.1.2 Frequency Below 1GHz

● **Test SKU: SKU #1 [with (INPAQ) WA-P-LELE-04-011 Antenna]**

Mode	GFSK	Frequency	TX 2480MHz
------	------	-----------	------------

Antenna at Horizontal Polarization

Emission Frequency (MHz)	Antenna Factor (dB/m)	Cable Loss (dB)	Preamplifier Gain (dB)	Read Level (dBμV)	Emission Level (dBμV/m)	Limits (dBμV/m)	Margin (dB)	Detector
35.658	21.78	1.31	26.51	36.87	33.44	40.00	6.56	Peak
148.017	16.69	2.85	26.03	32.80	26.32	43.50	17.18	Peak
212.683	16.07	3.53	25.79	36.14	29.95	43.50	13.55	Peak
378.392	21.05	5.29	26.35	36.57	36.56	46.00	9.44	Peak
485.900	22.93	6.29	27.08	32.19	34.33	46.00	11.67	Peak
567.542	23.97	6.65	27.33	32.48	35.76	46.00	10.24	Peak

Antenna at Vertical Polarization

Emission Frequency (MHz)	Antenna Factor (dB/m)	Cable Loss (dB)	Preamplifier Gain (dB)	Read Level (dBμV)	Emission Level (dBμV/m)	Limits (dBμV/m)	Margin (dB)	Detector
34.850	22.21	1.30	0.00	14.64	38.14	40.00	1.86	QP
147.208	16.74	2.84	26.03	41.66	35.20	43.50	8.30	Peak
199.750	15.29	3.40	25.81	37.18	30.06	43.50	13.44	Peak
324.233	19.61	4.67	25.89	31.83	30.22	46.00	15.78	Peak
378.392	21.05	5.29	26.35	36.56	36.55	46.00	9.45	Peak
431.742	22.09	5.81	26.73	32.37	33.55	46.00	12.45	Peak

● Test SKU: SKU #2 [with (LUXSHARE-ICT) L1LRF009-CS-H Antenna]

Mode	GFSK				Frequency	TX 2480MHz		
Antenna at Horizontal Polarization								
Emission Frequency (MHz)	Antenna Factor (dB/m)	Cable Loss (dB)	Preamp Gain (dB)	Read Level (dBμV)	Emission Level (dBμV/m)	Limits (dBμV/m)	Margin (dB)	Detector
34.850	22.21	1.30	26.51	36.94	33.93	40.00	6.07	Peak
143.975	16.93	2.81	26.05	34.45	28.14	43.50	15.36	Peak
270.883	18.45	4.09	25.70	33.40	30.25	46.00	15.75	Peak
378.392	21.05	5.29	26.35	36.20	36.19	46.00	9.81	Peak
457.608	22.51	6.05	26.90	33.18	34.83	46.00	11.17	Peak
552.183	23.79	6.60	27.30	32.86	35.95	46.00	10.05	Peak
Antenna at Vertical Polarization								
Emission Frequency (MHz)	Antenna Factor (dB/m)	Cable Loss (dB)	Preamp Gain (dB)	Read Level (dBμV)	Emission Level (dBμV/m)	Limits (dBμV/m)	Margin (dB)	Detector
34.042	22.48	1.28	0.00	14.89	38.65	40.00	1.35	QP
146.400	16.79	2.83	26.04	41.66	35.24	43.50	8.26	Peak
204.600	15.58	3.45	25.80	34.74	27.96	43.50	15.54	Peak
283.008	18.65	4.20	25.68	31.35	28.52	46.00	17.48	Peak
378.392	21.05	5.29	26.35	35.51	35.50	46.00	10.50	Peak
485.092	22.92	6.28	27.07	31.90	34.03	46.00	11.97	Peak

● Test SKU: SKU #3 [with (INPAQ) WA-P-LBLB-04-108 Antenna]

Mode	GFSK				Frequency	TX 2480MHz		
Antenna at Horizontal Polarization								
Emission Frequency (MHz)	Antenna Factor (dB/m)	Cable Loss (dB)	Preamp Gain (dB)	Read Level (dBμV)	Emission Level (dBμV/m)	Limits (dBμV/m)	Margin (dB)	Detector
35.658	21.78	1.31	26.51	36.69	33.27	40.00	6.73	Peak
143.975	16.93	2.81	26.05	35.67	29.37	43.50	14.13	Peak
310.492	19.23	4.50	25.76	31.76	29.72	46.00	16.28	Peak
378.392	21.05	5.29	26.35	36.81	36.80	46.00	9.20	Peak
464.883	22.63	6.11	26.95	32.06	33.85	46.00	12.15	Peak
516.617	23.35	6.46	27.20	32.24	34.85	46.00	11.15	Peak
Antenna at Vertical Polarization								
Emission Frequency (MHz)	Antenna Factor (dB/m)	Cable Loss (dB)	Preamp Gain (dB)	Read Level (dBμV)	Emission Level (dBμV/m)	Limits (dBμV/m)	Margin (dB)	Detector
34.042	22.48	1.28	0.00	14.15	37.91	40.00	2.09	QP
145.592	16.83	2.82	26.04	41.59	35.21	43.50	8.29	Peak
324.233	19.61	4.67	25.89	32.89	31.28	46.00	14.72	Peak
378.392	21.05	5.29	26.35	37.57	37.56	46.00	8.44	Peak
485.092	22.92	6.28	27.07	32.95	35.07	46.00	10.93	Peak
594.217	24.27	6.74	27.40	32.01	35.63	46.00	10.37	Peak

A.2.1.3 Frequency Above 1 GHz to 10th harmonics

Band Edge:

- Test SKU: SKU #1 [with (INPAQ) WA-P-LELE-04-011 Antenna]

Mode	8-DPSK	Frequency	TX 2480MHz
------	--------	-----------	------------

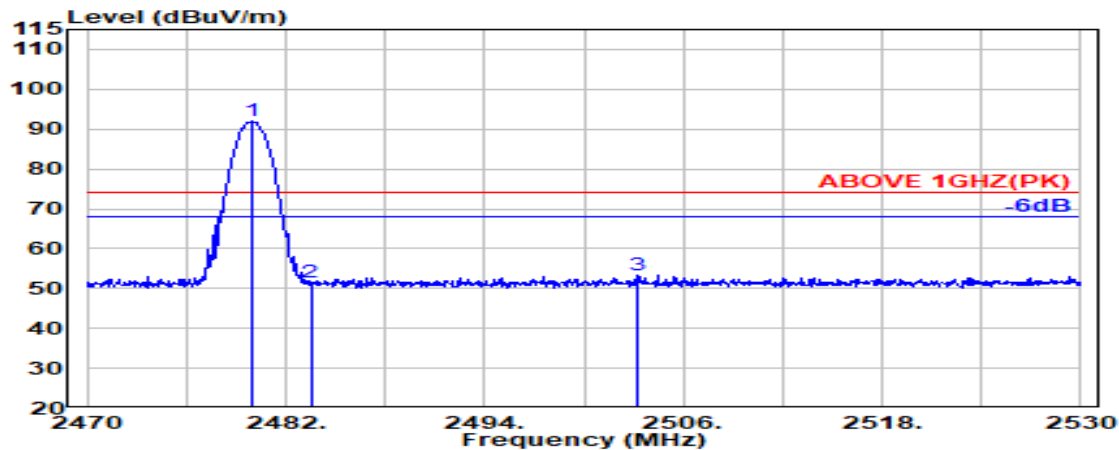

Antenna at Horizontal Polarization

Emission Frequency (MHz)	Antenna Factor (dB/m)	Cable Loss (dB)	Preamplifier Gain (dB)	Read Level (dBμV)	Emission Level (dBμV/m)	Limits (dBμV/m)	Margin (dB)	Detector
@ 2479.950	28.46	6.16	34.53	91.82	91.92	---	---	Peak
2483.500	28.47	6.17	34.53	51.56	51.67	74.00	22.33	Peak
2503.300	28.51	6.19	34.53	53.04	53.21	74.00	20.79	Peak

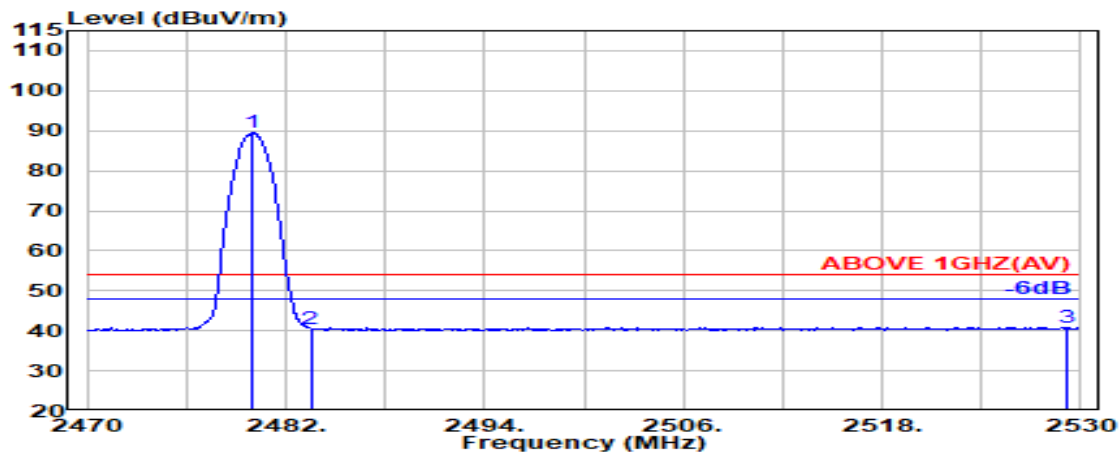

Antenna at Horizontal Polarization

Emission Frequency (MHz)	Antenna Factor (dB/m)	Cable Loss (dB)	Preamplifier Gain (dB)	Read Level (dBμV)	Emission Level (dBμV/m)	Limits (dBμV/m)	Margin (dB)	Detector
@ 2480.000	28.46	6.16	34.53	89.34	89.44	---	---	Average
2483.500	28.47	6.17	34.53	40.50	40.61	54.00	13.39	Average
2529.150	28.56	6.22	34.54	40.70	40.95	54.00	13.05	Average

Remark: The “@” means fundamental frequency, it is ignored in this section.

Mode	8-DPSK	Frequency	TX 2480MHz
------	--------	-----------	------------

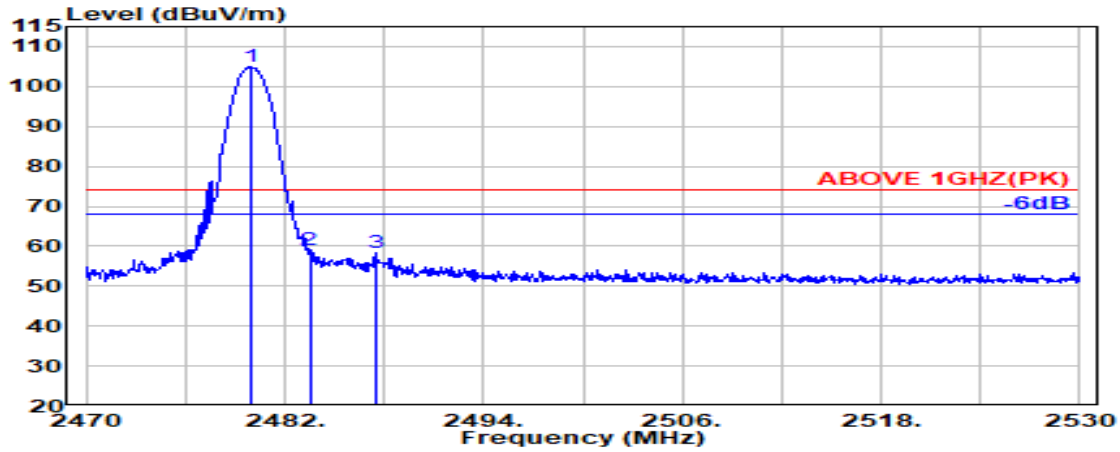

Antenna at Vertical Polarization

Emission Frequency (MHz)	Antenna Factor (dB/m)	Cable Loss (dB)	Preamplifier Gain (dB)	Read Level (dBμV)	Emission Level (dBμV/m)	Limits (dBμV/m)	Margin (dB)	Detector
@ 2479.950	28.46	6.16	34.53	104.75	104.85	---	---	Peak
2483.500	28.47	6.17	34.53	58.79	58.90	74.00	15.10	Peak
2487.500	28.48	6.17	34.53	58.17	58.29	74.00	15.71	Peak

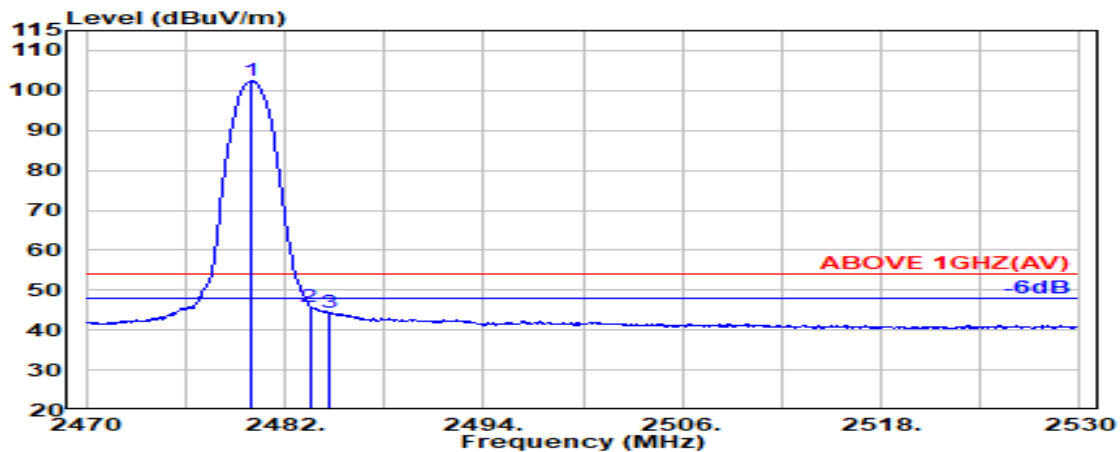

Antenna at Vertical Polarization

Emission Frequency (MHz)	Antenna Factor (dB/m)	Cable Loss (dB)	Preamplifier Gain (dB)	Read Level (dBμV)	Emission Level (dBμV/m)	Limits (dBμV/m)	Margin (dB)	Detector
@ 2480.000	28.46	6.16	34.53	102.29	102.38	---	---	Average
2483.500	28.47	6.17	34.53	45.71	45.82	54.00	8.18	Average
2484.750	28.47	6.17	34.53	44.43	44.54	54.00	9.46	Average

Remark: The “@” means fundamental frequency, it is ignored in this section.

● Test SKU: SKU #2 [with (LUXSHARE-ICT) L1LRF009-CS-H Antenna]

Mode	8-DPSK	Frequency	TX 2480MHz
------	--------	-----------	------------

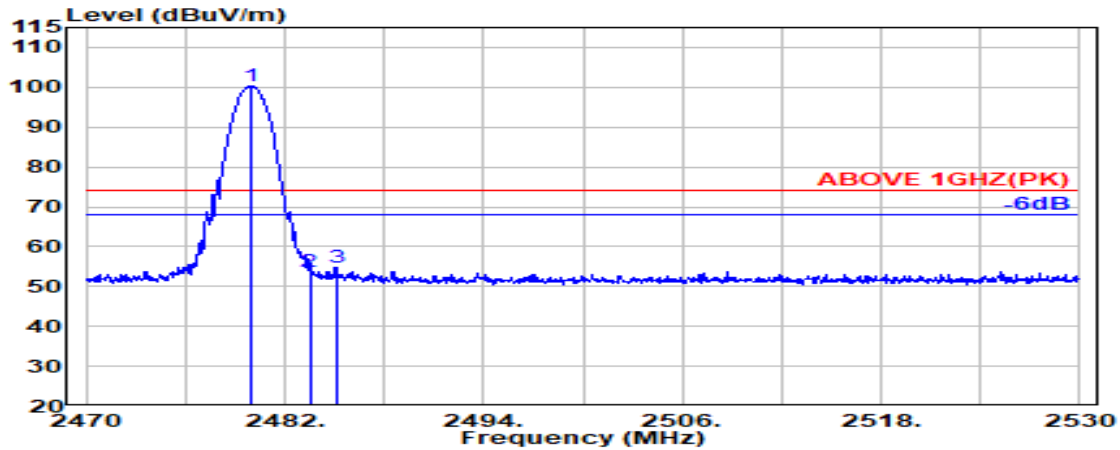

Antenna at Horizontal Polarization

Emission Frequency (MHz)	Antenna Factor (dB/m)	Cable Loss (dB)	Preamp Gain (dB)	Read Level (dBμV)	Emission Level (dBμV/m)	Limits (dBμV/m)	Margin (dB)	Detector
@ 2479.950	28.46	6.16	34.53	100.19	100.29	---	---	Peak
2483.500	28.47	6.17	34.53	53.68	53.79	74.00	20.21	Peak
2485.100	28.47	6.17	34.53	54.59	54.70	74.00	19.30	Peak

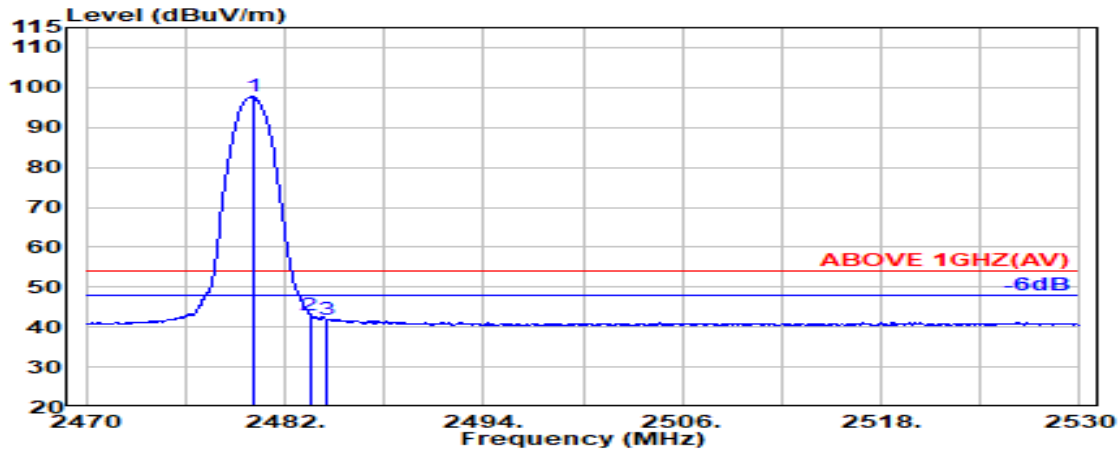

Antenna at Horizontal Polarization

Emission Frequency (MHz)	Antenna Factor (dB/m)	Cable Loss (dB)	Preamp Gain (dB)	Read Level (dBμV)	Emission Level (dBμV/m)	Limits (dBμV/m)	Margin (dB)	Detector
@ 2480.050	28.46	6.16	34.53	97.62	97.72	---	---	Average
2483.500	28.47	6.17	34.53	42.88	42.99	54.00	11.01	Average
2484.500	28.47	6.17	34.53	41.87	41.98	54.00	12.02	Average

Remark: The “@” means fundamental frequency, it is ignored in this section.

Mode	8-DPSK	Frequency	TX 2480MHz
------	--------	-----------	------------

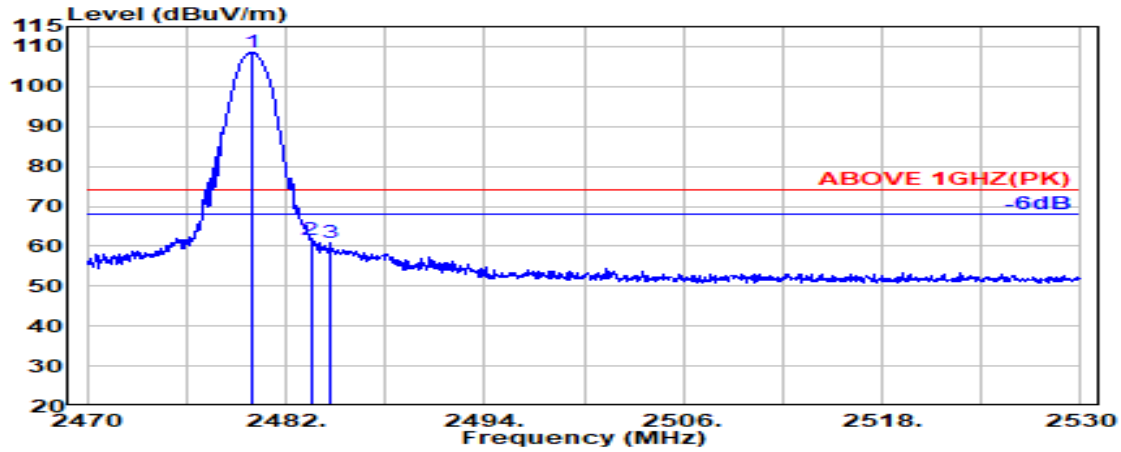

Antenna at Vertical Polarization

Emission Frequency (MHz)	Antenna Factor (dB/m)	Cable Loss (dB)	Preamplifier Gain (dB)	Read Level (dBμV)	Emission Level (dBμV/m)	Limits (dBμV/m)	Margin (dB)	Detector
@ 2479.950	28.46	6.16	34.53	108.40	108.49	---	---	Peak
2483.500	28.47	6.17	34.53	61.61	61.72	74.00	12.28	Peak
2484.750	28.47	6.17	34.53	60.76	60.87	74.00	13.13	Peak

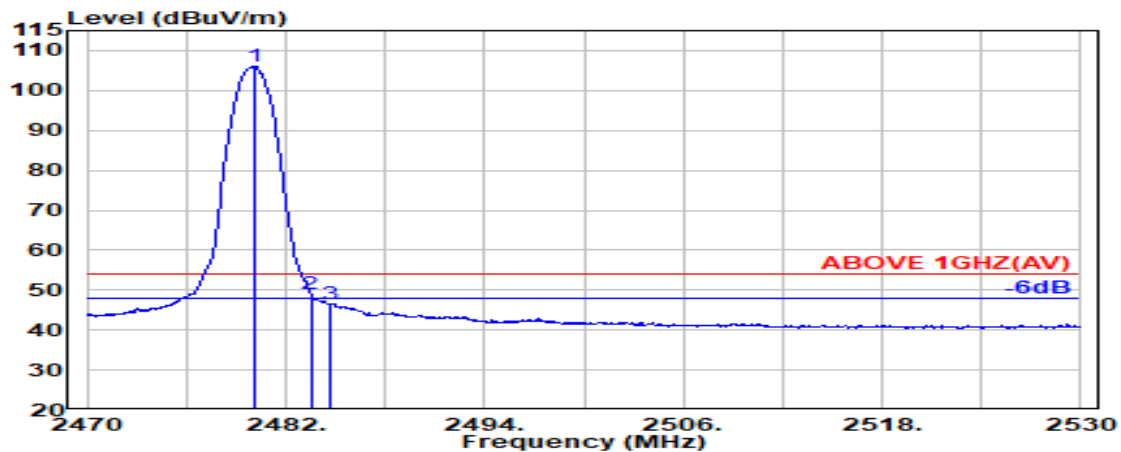

Antenna at Vertical Polarization

Emission Frequency (MHz)	Antenna Factor (dB/m)	Cable Loss (dB)	Preamplifier Gain (dB)	Read Level (dBμV)	Emission Level (dBμV/m)	Limits (dBμV/m)	Margin (dB)	Detector
@ 2480.100	28.46	6.16	34.53	105.87	105.96	---	---	Average
2483.500	28.47	6.17	34.53	48.76	48.86	54.00	5.14	Average
2484.650	28.47	6.17	34.53	46.56	46.67	54.00	7.33	Average

Remark: The “@” means fundamental frequency, it is ignored in this section.

● Test SKU: SKU #3 [with (INPAQ) WA-P-LBLB-04-108 Antenna]

Mode	8-DPSK	Frequency	TX 2480MHz
------	--------	-----------	------------

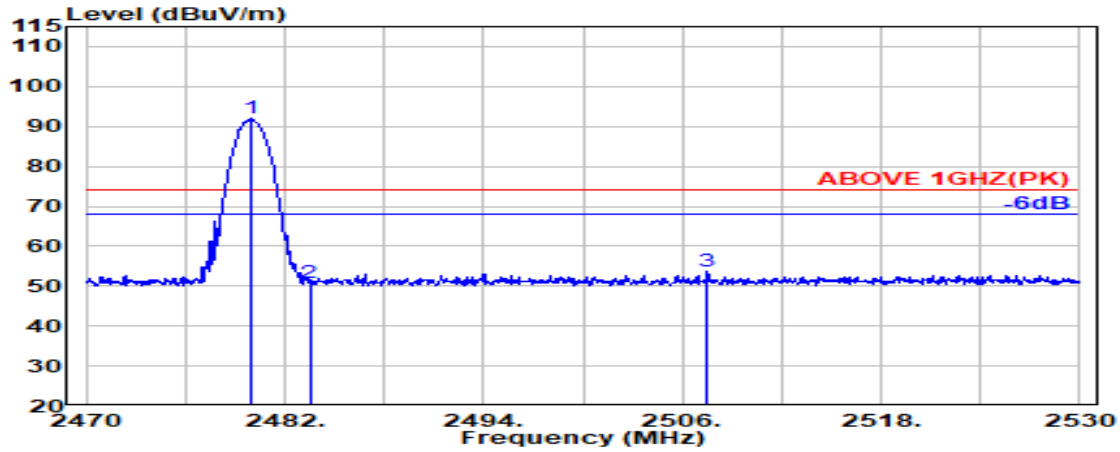

Antenna at Horizontal Polarization

Emission Frequency (MHz)	Antenna Factor (dB/m)	Cable Loss (dB)	Preamp Gain (dB)	Read Level (dBμV)	Emission Level (dBμV/m)	Limits (dBμV/m)	Margin (dB)	Detector
@ 2479.950	28.46	6.16	34.53	91.89	91.99	---	---	Peak
2483.500	28.47	6.17	34.53	50.80	50.91	74.00	23.09	Peak
2507.500	28.50	6.20	34.53	53.51	53.67	74.00	20.33	Peak

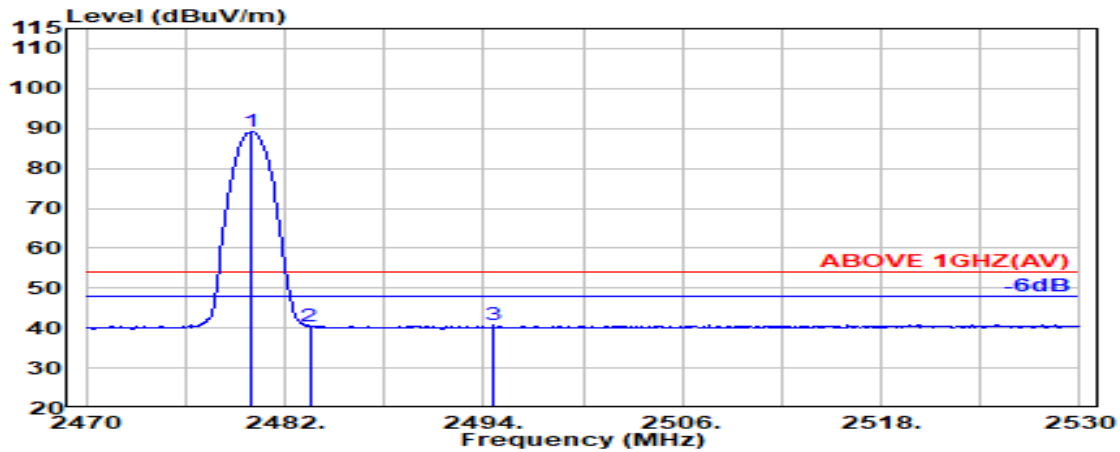

Antenna at Horizontal Polarization

Emission Frequency (MHz)	Antenna Factor (dB/m)	Cable Loss (dB)	Preamp Gain (dB)	Read Level (dBμV)	Emission Level (dBμV/m)	Limits (dBμV/m)	Margin (dB)	Detector
@ 2480.000	28.46	6.16	34.53	89.15	89.24	---	---	Average
2483.500	28.47	6.17	34.53	40.30	40.41	54.00	13.59	Average
2494.550	28.49	6.18	34.53	40.61	40.75	54.00	13.25	Average

Remark: The “@” means fundamental frequency, it is ignored in this section.

Mode	8-DPSK	Frequency	TX 2480MHz
------	--------	-----------	------------

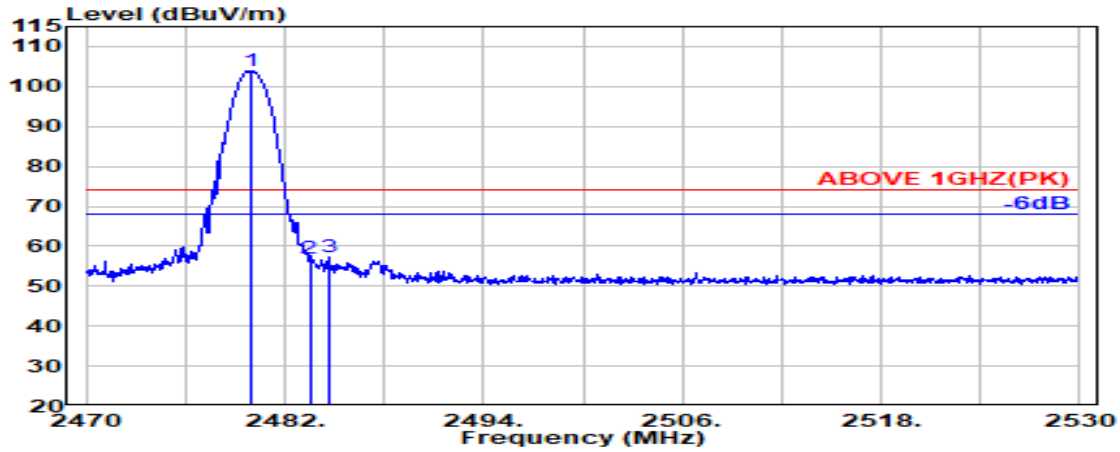

Antenna at Vertical Polarization

Emission Frequency (MHz)	Antenna Factor (dB/m)	Cable Loss (dB)	Preamp Gain (dB)	Read Level (dBμV)	Emission Level (dBμV/m)	Limits (dBμV/m)	Margin (dB)	Detector
@ 2479.950	28.46	6.16	34.53	103.94	104.04	---	---	Peak
2483.500	28.47	6.17	34.53	56.85	56.95	74.00	17.05	Peak
2484.650	28.47	6.17	34.53	57.12	57.23	74.00	16.77	Peak

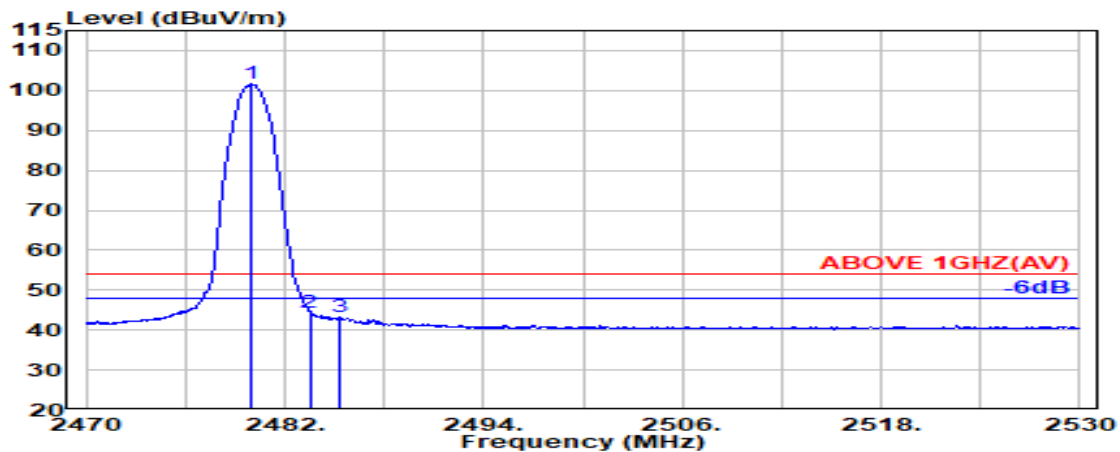

Antenna at Vertical Polarization

Emission Frequency (MHz)	Antenna Factor (dB/m)	Cable Loss (dB)	Preamp Gain (dB)	Read Level (dBμV)	Emission Level (dBμV/m)	Limits (dBμV/m)	Margin (dB)	Detector
@ 2480.000	28.46	6.16	34.53	101.50	101.59	---	---	Average
2483.500	28.47	6.17	34.53	44.36	44.47	54.00	9.53	Average
2485.250	28.47	6.17	34.53	43.20	43.31	54.00	10.69	Average

Remark: The “@” means fundamental frequency, it is ignored in this section.

A.2.2 Emissions outside the frequency band:

The emissions (up to 25GHz) not reported for there is no emission be found.

● **Test SKU: SKU #1 [with (INPAQ) WA-P-LELE-04-011 Antenna]**

Mode	GFSK				Frequency	TX 2441MHz		
------	------	--	--	--	-----------	------------	--	--

Antenna at Horizontal Polarization

Emission Frequency (MHz)	Antenna Factor (dB/m)	Cable Loss (dB)	Preamplifier Gain (dB)	Read Level (dBμV)	Emission Level (dBμV/m)	Limits (dBμV/m)	Margin (dB)	Detector
4882.000	33.43	8.38	34.42	37.19	44.57	54.00	9.43	Peak

Antenna at Vertical Polarization

Emission Frequency (MHz)	Antenna Factor (dB/m)	Cable Loss (dB)	Preamplifier Gain (dB)	Read Level (dBμV)	Emission Level (dBμV/m)	Limits (dBμV/m)	Margin (dB)	Detector
4882.000	33.43	8.38	34.42	38.67	46.05	54.00	7.95	Peak

● **Test SKU: SKU #2 [with (LUXSHARE-ICT) L1LRF009-CS-H Antenna]**

Mode	GFSK				Frequency	TX 2402MHz		
------	------	--	--	--	-----------	------------	--	--

Antenna at Horizontal Polarization

Emission Frequency (MHz)	Antenna Factor (dB/m)	Cable Loss (dB)	Preamplifier Gain (dB)	Read Level (dBμV)	Emission Level (dBμV/m)	Limits (dBμV/m)	Margin (dB)	Detector
4804.000	32.92	8.32	34.43	38.17	44.98	54.00	9.02	Peak

Antenna at Vertical Polarization

Emission Frequency (MHz)	Antenna Factor (dB/m)	Cable Loss (dB)	Preamplifier Gain (dB)	Read Level (dBμV)	Emission Level (dBμV/m)	Limits (dBμV/m)	Margin (dB)	Detector
4804.000	32.92	8.32	34.43	37.30	44.11	54.00	9.89	Peak

● **Test SKU: SKU #3 [with (INPAQ) WA-P-LBLB-04-108 Antenna]**

Mode	GFSK				Frequency	TX 2441MHz		
------	------	--	--	--	-----------	------------	--	--

Antenna at Horizontal Polarization

Emission Frequency (MHz)	Antenna Factor (dB/m)	Cable Loss (dB)	Preamplifier Gain (dB)	Read Level (dBμV)	Emission Level (dBμV/m)	Limits (dBμV/m)	Margin (dB)	Detector
4882.000	33.16	8.38	34.42	36.78	43.90	54.00	10.10	Peak

Antenna at Vertical Polarization

Emission Frequency (MHz)	Antenna Factor (dB/m)	Cable Loss (dB)	Preamplifier Gain (dB)	Read Level (dBμV)	Emission Level (dBμV/m)	Limits (dBμV/m)	Margin (dB)	Detector
4882.000	33.16	8.38	34.42	36.80	43.92	54.00	10.08	Peak

A.2.3 Emissions in Non-restricted Frequency Bands:

Pursuant to ANSI C63.10:2013 that emission levels below the FCC 15.209(a)/RSS-Gen Section 8.9 table 4 general radiated emissions limits is not required.

A.3 MAXIMUM PEAK OUTPUT POWER

Test Date	2023/10/05	Temp./Hum.	23°C/53%
Cable Loss	1.00dB	Tested By	Hua Wu
Test Voltage	AC 120V, 60Hz (via AC Adapter)		

A.3.1 Peak Output Power

● SPOT CHECK Power

Test SKU: SKU #1 [with (INPAQ) WA-P-LELE-04-011 Antenna] &

SKU #2 [with (LUXSHARE-ICT) L1LRF009-CS-H Antenna]

Mode	Centre Frequency (MHz)	Max. Peak Output Power (dBm)
GFSK	2402	8.91
	2441	9.20
	2480	9.50
8-DPSK	2402	7.15
	2441	7.30
	2480	7.53

Test SKU: SKU #3 [with (INPAQ) WA-P-LBLB-04-108 Antenna]

Mode	Centre Frequency (MHz)	Max. Peak Output Power (dBm)
GFSK	2402	8.93
	2441	9.08
	2480	9.47
8-DPSK	2402	7.01
	2441	7.15
	2480	7.45

Note: 1. The results have been included cable loss.

2. We did spot check for output power and all output power values keep identical thus other conducted items is exempt.

● Original FCC ID: BEJNT-17Z90R & IC: 2703H-17Z90R Power

Mode	Centre Frequency (MHz)	Max. Peak Output Power (dBm)	Limit
GFSK	2402	8.99	21dBm (0.125W)
	2441	9.25	
	2480	9.54	
8-DPSK	2402	7.17	
	2441	7.33	
	2480	7.55	