

**FCC 15.407 NII
(Permissive Change)
5GHz Test Report**

for

LG Electronics Inc.

**222, LG-ro, Jinwi-myeon Pyeongtaek-Si, Gyeonggi-Do,
17709 Republic of Korea**

Product Name : Notebook Computer
**Model Name : (1)17Z90Q (2)17ZB90Q
(3)17ZD90Q (4)17ZG90Q**
Brand : LG
FCC ID : BEJNT-17Z90Q

**Prepared by: : AUDIX Technology Corporation,
EMC Department**



The test report is based on a single evaluation of one sample of the above-mentioned products. It does not imply an assessment of the whole production and does not permit the use of the test lab logo.

TABLE OF CONTENTS

Description	Page
TEST REPORT.....	4
1. REVISION RECORD OF TEST REPORT	4
2. SUMMARY OF TEST RESULTS	5
3. GENERAL INFORMATION	6
3.1. Description of Application	6
3.2. Description of EUT	7
3.3. Reference Test Guidance.....	8
3.4. Information for Permissive Change.....	8
3.5. Antenna Information	9
3.6. EUT Specifications Assessed in Current Report	10
3.7. Description of Key Components	13
3.8. Test Configuration.....	15
3.9. Output Power Setting	22
3.10. Tested Supporting System List.....	25
3.11. Setup Configuration.....	25
3.12. Operating Condition of EUT	26
3.13. Description of Test Facility	26
3.14. Measurement Uncertainty	27
4. MEASUREMENT EQUIPMENTLIST.....	28
4.1. Conducted Emission Measurement	28
4.2. Radiated Emission Measurement	29
4.3. RF Conducted Measurement	29
5. CONDUCTED EMISSION.....	30
5.1. Block Diagram of Test Setup	30
5.2. Conducted Emission Limit	30
5.3. Test Procedure	30
5.4. Test Results	31
6. RADIATED EMISSION	32
6.1. Block Diagram of Test Setup	32
6.2. Radiated Emission Limits.....	34
6.3. Test Procedure	36
6.4. Measurement Result Explanation.....	37
6.5. Test Results	37
7. DEVIATION TO TEST SPECIFICATIONS	38

APPENDIX A TEST DATA AND PLOTS

APPENDIX B TESTPHOTOGRAPHS

TEST REPORT

Applicant : LG Electronics Inc.
Manufacturer : LG Electronics Inc.
Factory : LG Electronics Nanjing New Technology Co., Ltd.
EUT Description
(1) Product : Notebook Computer
(2) Model : (1)17Z90Q (2)17ZB90Q (3)17ZD90Q (4)17ZG90Q
(3) Brand : LG
(4) Power Supply: DC 20V, 3.25A

Applicable Standards:

Title 47 FCC CFR Part 15 Subpart E

Audix Technology Corp. tested the equipment mentioned in accordance with the requirements set forth in the above standards. Test results indicate that the equipment tested is capable of demonstrating compliance with the requirements as documented within this report.

Audix Technology Corp. does not assume responsibility for any conclusions and generalizations drawn from the test results with regard to other specimens and samples.

Date of Report: 2022. 06. 10

Reviewed by:

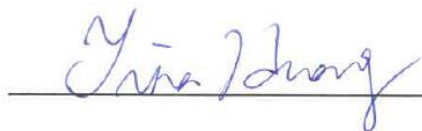

(Tina Huang/Section Manager)

Approved by:

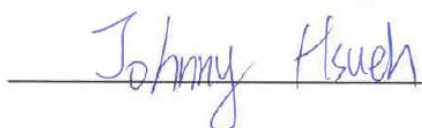

(Johnny Hsueh/Section Manager)

1. REVISION RECORD OF TEST REPORT

Edition No	Issued Date	Revision Summary	Report Number
0	2022. 06. 10	Original Report	EM-F220383

2. SUMMARY OF TEST RESULTS

Rule	Description	Results
15.207	Conducted Emission	PASS
15.205/15.209	Radiated Band Edge and Radiated Spurious Emission	N/A, Note 2 & 3
15.407(a)(5)/15.407(e)	Emission/Occupied Bandwidth	N/A, Note 2
15.407(a)	Maximum Output Power	PASS
15.407(b)	Conducted Band Edges	N/A
15.407(a)	Power Spectral Density	N/A, Note 2
15.407	Frequency Stability	N/A, Note 2
15.407(h)(2)	Dynamic Frequency Selection(DFS)	N/A, Note 2
15.203	Antenna Requirement	Compliance

Note: 1. The uncertainties value is not used in determining the result.
2. To add new Configuration with new components is not influence on this item
3. Due to the above difference, it is unnecessary to test Radiated Band Edge.

3. GENERAL INFORMATION

3.1. Description of Application

Applicant	LG Electronics Inc. 222, LG-ro, Jinwi-myeon Pyeongtaek-Si, Gyeonggi-Do, 17709 Republic of Korea
Manufacturer	LG Electronics Inc. 222, LG-ro, Jinwi-myeon Pyeongtaek-Si, Gyeonggi-Do, 17709 Republic of Korea
Factory	LG Electronics Nanjing New Technology Co., Ltd. No.346,Yaoxin Road, Economic & Technical Development Zone, Nanjing, China.
Product	Notebook Computer
Model	(1)17Z90Q (2)17ZB90Q (3)17ZD90Q (4)17ZG90Q The difference between all models is different in the sales customers.
Configuration	17Z90Q-K, 17Z90Q-N, 17Z90Q-A, 17Z90Q-R
Brand	LG

The difference list for Configuration:

Difference Configuration	Main Board	GPU	TPM (Trusted Platform Module)
17Z90Q-K	Queen MAIN B/D PCB	Intel Iris Xe UHD Graphics	Not Support
17Z90Q-N	Queen MAIN B/D PCB	Intel Iris Xe UHD Graphics	Support
17Z90Q-A	QUEEN NVIDIA MAIN B/D PCB	NVIDIA RTX2050	Not Support
17Z90Q-R	QUEEN NVIDIA MAIN B/D PCB	NVIDIA RTX2050	Support

3.2. Description of EUT

Test Model	17Z90Q	
Serial Number	N/A	
Power Rating	DC 20V, 3.52A	
Software Version	XY (X, Y can be 0 to 9 for different SW version not influence RF parameter)	
RF Features	WLAN:802.11 a/b/g/n/ac/ax Bluetooth: BT and BLE (BT 5.1)	
Transmit Type	2.4 GHz	
	802.11b	1T1R
	802.11g	1T1R
	802.11n-HT20	2T2R
	802.11n-HT40	2T2R
	802.11ax-HE20	2T2R
	802.11ax-HE40	2T2R
	BT/BLE	1T1R
	U-NII Bands	
	802.11a	1T1R
	802.11n-HT20/802.11ac-VHT20/802.11ax-HE20	2T2R
	802.11n-HT40/802.11ac-VHT40/802.11ax-HE40	2T2R
	802.11ac-VHT80/802.11ax-HE80	2T2R
	802.11ac-VHT160/802.11ax-HE160	2T2R
	The MIMO is uncorrelated and supported SDM mode only.	
Device Category	<input type="checkbox"/> Outdoor Access Point <input type="checkbox"/> Fixed point-to-point Access Point <input type="checkbox"/> Indoor Access Point <input checked="" type="checkbox"/> Mobile and Portable client device	
Test Sample	Sample No.	Test Item
	03	AC Conduction, RSE, Output Power
	04	AC Conduction, RSE
	Firmware	N/A
Sample Status	Trial sample	
Date of Receipt	2022. 03. 24	
Date of Test	2022. 05. 21 ~ 06. 09	

Interface Ports of EUT	<ul style="list-style-type: none"> • One Micro SD Card Slot • Two USB 3.0 Ports • One HDMI Port • Two USB Type C Port • One Earphone Port
Accessories Supplied	<ul style="list-style-type: none"> • AC Adapter • LAN Gender

3.3. Reference Test Guidance

KDB 789033 D02 General UNII Test Procedures New Rules v02r01
ANSI C63.10:2013

3.4. Information for Permissive Change

- The EUT is an addition version with original FCC ID: BEJNT-17Z90Q is to add new Configuration and components, and the detail for component list please refer to section 3.7.1
- The differences between this application and original's ID as clarify in following list.

Difference		Main Board	GPU	TPM (Trusted Platform Module)
Original	17Z90Q	Queen MAIN B/D PCB	Intel Iris Xe UHD Graphics	Not Support
		Queen MAIN B/D PCB	Intel Iris Xe UHD Graphics	Support
Permissive Change	17Z90Q-K	Queen MAIN B/D PCB	Intel Iris Xe UHD Graphics	Not Support
	17Z90Q-N	Queen MAIN B/D PCB	Intel Iris Xe UHD Graphics	Support
	17Z90Q-A	QUEEN NVIDIA MAIN B/D PCB	NVIDIA RTX2050	Not Support
	17Z90Q-R	QUEEN NVIDIA MAIN B/D PCB	NVIDIA RTX2050	Support

Note: 1. The Configuration 17Z90Q-K and 17Z90Q-N with original components were measured in the original application.
2 The Configuration 17Z90Q-A and 17Z90Q-R with new components were measured in this Permissive Change application.

- Due to above different item, there have some test item should be re-tested (see section 2), the test data are recorded in this report.

3.5. Antenna Information

No.	Antenna Part Number	Manufacture	Antenna Type	Frequency (MHz)	Max Gain(dBi)	
					Main	AUX
1.	WA-P-LELE-04-011	INPAQ	Mono-Pole	2400	2.2	1.1
				2450	3.0	1.6
				2500	2.7	1.5
				5150	4.1	3.8
				5400	4.0	3.7
				5850	3.7	3.3
				5925	3.5	3.2
				6525	2.7	2.5
				7125	2.5	2.1
Note 1. 2.4G: Directional gain = $10 \log[(10^{3.0/10} + 10^{1.6/10})/2] = 2.36\text{dBi}$ Note 2. UNII Band (WLAN 5G): Directional gain = $10 \log[(10^{4.1/10} + 10^{3.8/10})/2] = 3.95\text{dBi}$ Note 3. UNII Band (WLAN 6G): Directional gain = $10 \log[(10^{3.5/10} + 10^{3.2/10})/2] = 3.35\text{dBi}$						
2.	L1LRF009-CS-H	LUXSHARE-ICT	Mono-Pole	2400	-1.45	2.89
				2450	0.26	-0.07
				2500	2.15	-6.91
				5150	5.24	3.64
				5400	0.55	1.11
				5850	4.96	2.88
				5925	5.85	2.48
				6525	1.19	1.38
				7125	3.99	1.89
Note 1. 2.4G: Directional gain = $10 \log[(10^{2.15/10} + 10^{2.89/10})/2] = 2.54\text{dBi}$ Note 2. UNII Band (WLAN 5G): Directional gain = $10 \log[(10^{5.24/10} + 10^{3.64/10})/2] = 4.51\text{dBi}$ Note 3. UNII Band (WLAN 6G): Directional gain = $10 \log[(10^{5.85/10} + 10^{2.48/10})/2] = 4.48\text{dBi}$						

3.6. EUT Specifications Assessed in Current Report

Mode	U-NII Band	Fundamental Range (MHz)	Channel Number
802.11a	I	5180-5240	4
	2A	5260-5320	4
	2C	5500-5720	12
	III	5745-5825	5
802.11n-HT20/ 802.11ac-VHT20 802.11ax-HE20	I	5180-5240	4
	2A	5260-5320	4
	2C	5500-5720	12
	III	5745-5825	5
802.11n-HT40/ 802.11ac-VHT40 802.11ax-HE40	I	5190-5230	2
	2A	5270-5310	2
	2C	5510-5710	6
	III	5755-5795	2
802.11ac-VHT80 802.11ax-HE80	I	5210	1
	2A	5290	1
	2C	5530-5690	3
	III	5775	1
802.11ac-VHT160 802.11ax-HE160	I	5250	1
	2A		
	2C	5570	1
Remark: U-NII Band 2A and 2C (DFS Function, Slave/no In service monitor, no Ad-Hoc mode)			

Mode	Modulation	Data Rate (Mbps)
802.11a	OFDM (BPSK/QPSK/16QAM/64QAM)	Up to 54
802.11n-HT20	OFDM (BPSK/QPSK/16QAM/64QAM)	Up to 144.4
802.11n-HT40		Up to 300
802.11ac-VHT20	OFDM (BPSK/QPSK/16QAM/64QAM/256QAM)	Up to 173.3
802.11ac-VHT40		Up to 400
802.11ac-VHT80		Up to 866.7
802.11ac-VHT160		Up to 1733.3
802.11ax-HE20	OFDMA (BPSK/ QPSK/ 16QAM/ 64QAM/ 256QAM/1024QAM)	Up to 287
802.11ax-HE40		Up to 574
802.11ax-HE80		Up to 1201
802.11ax-HE160		Up to 2402

Channel List						
802.11a/802.11n-HT20/802.11ac-VHT20/802.11ax-HE20						
U-NII Band	Channel Number	Frequency (MHz)	U-NII Band	Channel Number	Frequency (MHz)	
I	36	5180	2C	120	5600	
	40	5200		124	5620	
	44	5220		128	5640	
	48	5240		132	5660	
2A	52	5260		136	5680	
	56	5280		140	5700	
	60	5300		144	5720	
	64	5320		149	5745	
2C	100	5500		III	153	5765
	104	5520			157	5785
	108	5540	161		5805	
	112	5560	165		5825	
	116	5580				

Channel List					
802.11n-HT40/802.11ac-VHT40/802.11ax-HE40					
U-NII Band	Channel Number	Frequency (MHz)	U-NII Band	Channel Number	Frequency (MHz)
I	38	5190	2C	118	5590
	46	5230		126	5630
2A	54	5270		134	5670
	62	5310		142	5710
2C	102	5510	III	151	5755
	110	5550		159	5795

Channel List					
802.11ac-VHT80/802.11ax-HE80					
U-NII Band	Channel Number	Frequency (MHz)	U-NII Band	Channel Number	Frequency (MHz)
I	42	5210	2C	138	5690
2A	58	5290	III	155	5775
2C	106	5530			
	122	5610			

Channel List					
802.11ac-VHT160/802.11ax-HE160					
U-NII Band	Channel Number	Frequency (MHz)	U-NII Band	Channel Number	Frequency (MHz)
I	50	5250	2C	114	5570
2A					

Note: Test modes are presented at section 3.7.

3.7. Description of Key Components

3.7.1. For the All Component Lists

Item	Supplier	Model / Type	Character
System	Microsoft	Win11 Home	---
Main Board	LG	Queen MAIN B/D PCB	Main Board (GM) Manufacturer: #1 Hannstar Board Tech(Jiang Yin) Corp.,Ltd. #2 Elec & Eltek Company (MCO) Limited.
		QUEEN NVIDIA MAIN B/D PCB	Main Board (PM)* Manufacturer: #1 Hannstar Board Tech(Jiang Yin) Corp.,Ltd. #2 Elec & Eltek Company (MCO) Limited.
WLAN SUB Board	LG	17Z90Q Sub B/D	Manufacturer: #1 Hannstar Board Tech(Jiang Yin) Corp.,Ltd. #2 Elec & Eltek Company (MCO) Limited. #3 JiangSu HuaShen Electronic co.,ltd (HXF)
CPU (Socket: BGA1744)	Intel	i7-1260P	2.5GHz
	Intel	i5-1240P	2.1GHz
17" LCD Panel	LG Display	LP170WQ1(SP)(F2)	Resolution: 2560 x 1600, 60Hz WQXGAIPS (Non Touch)
Storage (SSD)	SK hynix	HFM001TD3JX013N	1TB
		HFM512GD3JX013N	512GB
		HFM256GD3JX013N	256GB
	Samsung	MZ-VL21T00	1TB
		MZ-VL25120	512GB
		MZ-VL22560	256GB
		MZ-VL22T00	2TB*
Memory (RAM)	Samsung	---	16GB LPDDR5x(On Board)
		---	8GB LPDDR5x(On Board)
		---	32GB LPDDR5x(On Board)*
	SK Hynix	---	16GB LPDDR5x(On Board)
		---	8GB LPDDR5x(On Board)
		---	32GB LPDDR5x(On Board)*
Battery Pack	LG	LBV7227E	80Wh, DC 7.74V, 80Wh Typ 10336mAh
	LG	LBY122CM	90Wh, DC 7.76V, 90Wh Typ 11600mAh
WLAN Combo Card	Intel	AX211D2W	WLAN and BT, 2x2 PCIe M.2 1216 SD adapter card FCC ID: PD9AX211D2 IC: 1000M-AX211D2
WLAN Combo Antenna	LG (INPAQ)	WA-P-LELE-04-011	PCB, Mono-pole Type Main: Black, Aux: Gray
	LG (LUXSHARE-ICT)	L1LRF009-CS-H	PCB, Mono-pole Type Main: Black, Aux: Gray

Item	Supplier	Model / Type	Character
Keyboard	TIC	KT0120B8E	---
	LITE ON	SN8101	---
Web Camera	Chicony	CKFLF26	---
	Luxvisions	1BF225N3	---
LAN Gender (Type C to LAN)	SUZHOU MEC ELECTRONICS	80-5946-111	(White) 10/100 Megabit Ethernet
		80-5946-101	(Black) 10/100 Megabit Ethernet
		80-5946-230	(White) 10/100/1000 Megabit Ethernet
		80-5946-240	(Black) 10/100/1000 Megabit Ethernet
	Type C to LAN: Shielded, Undetached, 0.12m		
	ARIN TECH CO. LTD	GD-08MF-36-WH-LP10	(White) 10/100 Megabit Ethernet
		GD-08MF-36-BK-LP11	(Black) 10/100 Megabit Ethernet
		GD-08MF-50-WH-LP12	(White) 10/100/1000 Megabit Ethernet
		GD-08MF-50-BK-LP13	(Black) 10/100/1000 Megabit Ethernet
	Type C to LAN: Shielded, Undetached, 0.12m		
AC Adapter (65W)	LG (HONOR)	ADT-65DSU-D03-2	I/P: AC 100-240V, 1.6A, 50-60Hz O/P: DC 20V, 3.25A
	DC Power Cord: Non-Shielded, Undetached, 1.5m		
	AC Power Cord: Non-Shielded, Detached, 1.0m (2C) (For Other Countries)		
	AC Power Cord: Non-Shielded, Detached, 1.55m (2C) (For US, Canada, Mexico)		

Remark: For more detailed features description, please refer to the manufacturer's specifications or the user manual.

3.7.2. The EUT collocates with the original worst mode and new components, which are used to establish a basic configuration of system during test:

SKU (Mode)		1	2	
Main Board	LG, QUEEN NVIDIA MAIN B/D PCB (with TPM)	V		
	LG, QUEEN NVIDIA MAIN B/D PCB (w/o TPM)		V	
SUB Board	LG, 17Z90Q Sub B/D (Type A)	V	V	
CPU	Intel, i7-1260P	V	V	
17" LCD Panel	LG Display, LP170WQ1(SP)(F2)	V	V	
Storage (SSD)	Samsung, 2TB	V	V	
	SK hynix, 1TB	V	V	
Memory (RAM)	32GB	V	V	
Battery Pack	LG, 90Wh	V	V	
Keyboard	TIC, KT0120B8E	V	V	
Web Camera	Chicony, CKFLF26	V	V	
WLAN Combo Card	Intel, AX211D2W	V	V	
WLAN Combo Antenna	LG (INPAQ), WA-P-LELE-04-011	V		
	LG (LUXSHARE-ICT), L1LRF009-CS-H		V	
Type C #1	AC Adapter	LG (HONOR), ADT-65DSU-D03-2	V	V
Type C #2	Link to LAN Gender	MEC	V	V

3.8. Test Configuration

Mode	TX _{on} (ms)	1/ TX _{on} (kHz)	TX _{on+off} (ms)	Duty Cycle (x)	Duty Cycle Factor [10log(1/x)] (dB)
802.11a	2.090	0.478	2.130	0.981	N/A
802.11n-HT20	7.920	0.126	7.960	0.995	N/A
802.11n-HT40	7.920	0.126	7.960	0.995	N/A
802.11ac-VHT80	7.880	0.127	7.920	0.995	N/A
802.11ac-VHT160	5.520	0.181	5.560	0.993	N/A
802.11ax-HE20	2.580	0.388	2.620	0.985	N/A
802.11ax-HE40	2.580	0.388	2.620	0.985	N/A
802.11ax-HE80	2.590	0.386	2.630	0.985	N/A
802.11ax-HE160	2.300	0.435	2.340	0.983	N/A
802.11ax-HE20 (RU Config 26)	5.480	0.182	5.660	0.968	0.141
802.11ax-HE20 (RU Config 52)	3.970	0.252	4.010	0.990	N/A
802.11ax-HE20 (RU Config 106)	3.980	0.251	4.020	0.990	N/A
802.11ax-HE40 (RU Config 242)	5.480	0.182	5.660	0.968	0.141
802.11ax-HE80 (RU Config 484)	5.460	0.183	5.640	0.968	0.141
802.11ax-HE160 (RU Config 996)	5.480	0.182	5.660	0.968	0.141

Note: When duty cycle is less than 98% (0.98) that duty cycle factor 10log(1/x) is needed to add in conducted test items measured in average detector.

Mode	TX _{on} (ms)	T _{on} +T _{off} (ms)
802.11a	<p>Center: 5.18000000 GHz Res BW: 1.0 MHz Scale/Div: 10 dB Ref Lvl Offset: 1.00 dB Ref Level: 31.00 dBm ΔMkr1: 2.090 ms 15.05 dB</p>	<p>Center: 5.18000000 GHz Res BW: 1.0 MHz Scale/Div: 10 dB Ref Lvl Offset: 1.00 dB Ref Level: 31.00 dBm ΔMkr1: 2.130 ms -41.13 dB</p>
802.11n-HT20	<p>Center: 5.18000000 GHz Res BW: 1.0 MHz Scale/Div: 10 dB Ref Lvl Offset: 1.00 dB Ref Level: 31.00 dBm ΔMkr1: 7.920 ms 1.74 dB</p>	<p>Center: 5.18000000 GHz Res BW: 1.0 MHz Scale/Div: 10 dB Ref Lvl Offset: 1.00 dB Ref Level: 31.00 dBm ΔMkr1: 7.960 ms -49.02 dB</p>
802.11n-HT40	<p>Center: 5.19000000 GHz Res BW: 1.0 MHz Scale/Div: 10 dB Ref Lvl Offset: 1.00 dB Ref Level: 31.00 dBm ΔMkr1: 7.920 ms 7.70 dB</p>	<p>Center: 5.19000000 GHz Res BW: 1.0 MHz Scale/Div: 10 dB Ref Lvl Offset: 1.00 dB Ref Level: 31.00 dBm ΔMkr1: 7.960 ms -0.07 dB</p>
802.11ac-VHT80	<p>Center: 5.21000000 GHz Res BW: 1.0 MHz Scale/Div: 10 dB Ref Lvl Offset: 1.00 dB Ref Level: 31.00 dBm ΔMkr1: 7.880 ms 7.40 dB</p>	<p>Center: 5.21000000 GHz Res BW: 1.0 MHz Scale/Div: 10 dB Ref Lvl Offset: 1.00 dB Ref Level: 31.00 dBm ΔMkr1: 7.920 ms 0.45 dB</p>
802.11ac-VHT160	<p>Center: 5.25000000 GHz Res BW: 1.0 MHz Scale/Div: 10 dB Ref Lvl Offset: 1.00 dB Ref Level: 31.00 dBm ΔMkr1: 5.520 ms -4.92 dB</p>	<p>Center: 5.25000000 GHz Res BW: 1.0 MHz Scale/Div: 10 dB Ref Lvl Offset: 1.00 dB Ref Level: 31.00 dBm ΔMkr1: 5.560 ms -24.50 dB</p>

Mode	TX _{on} (ms)	T _{on} +T _{off} (ms)
802.11ax-HE20	<p>Center: 5.180000000 GHz Res BW: 1.0 MHz AMK1: 2.580 MHz 12.25 dBm</p>	<p>Center: 5.180000000 GHz Res BW: 1.0 MHz AMK1: 2.620 MHz -40.63 dBm</p>
802.11ax-HE40	<p>Center: 5.190000000 GHz Res BW: 1.0 MHz AMK1: 2.580 MHz 9.41 dBm</p>	<p>Center: 5.190000000 GHz Res BW: 1.0 MHz AMK1: 2.620 MHz -33.38 dBm</p>
802.11ax-HE80	<p>Center: 5.210000000 GHz Res BW: 1.0 MHz AMK1: 2.580 MHz 11.12 dBm</p>	<p>Center: 5.210000000 GHz Res BW: 1.0 MHz AMK1: 2.630 MHz -30.77 dBm</p>
802.11ax-HE160	<p>Center: 5.200000000 GHz Res BW: 1.0 MHz AMK1: 2.300 MHz -3.12 dBm</p>	<p>Center: 5.200000000 GHz Res BW: 1.0 MHz AMK1: 2.340 MHz -29.97 dBm</p>

Mode	TX _{on} (ms)	T _{on} +T _{off} (ms)
802.11ax-HE20 (RU Config 26)		
802.11ax-HE20 (RU Config 52)		
802.11ax-HE20 (RU Config 106)		
802.11ax-HE40 (RU Config 242)		

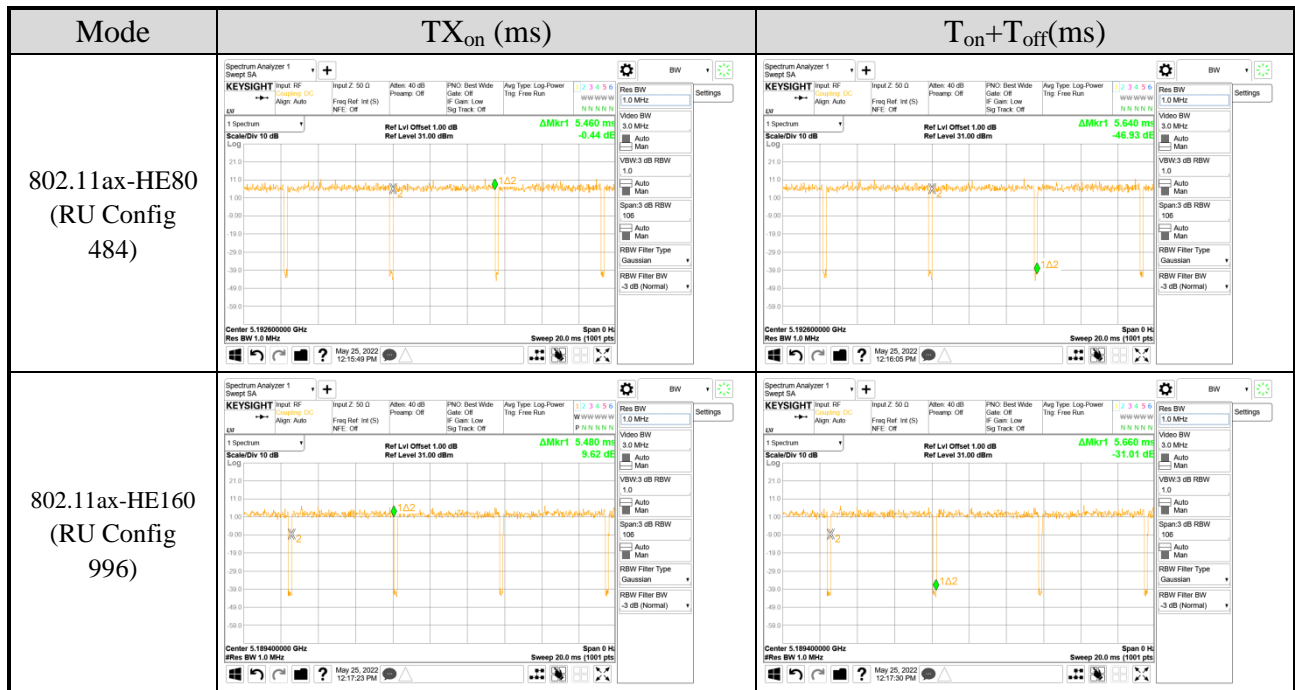

AC Conduction	
SKU #1	Normal operation (with INPAQ Antenna)
SKU #2	Normal operation (with LUXSHARE-ICT Antenna)

Item		Mode	Data Rate	Test Channel	
Radiated Test Case	SKU#1 SKU#2	Radiated Spurious Emission <small>Note 1 & 2</small> (30MHz-1GHz)	802.11n-HT40	MCS8	142
	SKU#2	Radiated Spurious Emission <small>Note 1 & 2 & 3</small> (Above 1GHz)	802.11n-HT40	MCS8	142

Item		Mode	Data Rate	Test Channel
Conducted Test Case	Maximum output power	802.11a	6 Mbps	36/40/48/52/60/64/100/116/140/144/149/157/165
		802.11n-HT20	MCS8	36/40/48/52/60/64/100/116/140/144/149/157/165
		802.11n-HT40	MCS8	38/46/54/62/102/110/134/142/151/159
		802.11ac-VHT80	MCS0	42/58/106/122/138/155
		802.11ac-VHT160	MCS0	50/114
		802.11ax-HE20	HE0	36/40/48/52/60/64/100/116/140/144/149/157/165
		802.11ax-HE40	HE0	38/46/54/62/102/110/134/142/151/159
		802.11ax-HE80	HE0	42/58/106/122/138/155
		802.11ax-HE160	HE0	50/114

Item		Mode	Data Rate	RU Configuration	Test Channel
Conducted Test Case	Maximum output power	802.11ax-HE20	HE0	26/0	36/100/149
				52/37	
				106/53	
		802.11ax-HE40	HE0	26/8	64/140/165
				52/40	
				106/5	
		802.11ax-HE40	HE0	242/61	38/102/151
				242/62	62/134/159
		802.11ax-HE80	HE0	484/65	42/106/155
				484/66	58/122/155
802.11ax-HE160	HE0	996/67	50/114		
		996/S67	50/114		

Note 1: Mobile Device

Portable Device, and 3 axis were assessed. The worst scenario for Radiated Spurious Emission as follow: Lie Side Stand

Note 2: Low, mid, and high channels were measured, only the worst channel of each modulation was presented in this report.

Note 3: Both of the antennas are the same type. The max-gain condition with MIMO is SKU #2 for U-NII Band 1/2A/III and SKU #1 for U-NII Band 2C. We present worst case with maximum power. The MIMO is uncorrelated and supported SDM mode only.

Note 4: The modulation and bandwidth are similar for 802.11n mode for HT20/HT40 and 802.11ac mode for VHT20/VHT40, therefore investigated worst case to representative mode in the test report.

Note 5: The data rates were selected based on preliminary testing that identified rate as the worst case for output power.

3.9. Output Power Setting

Mode	U-NII Band	Centre Frequency (MHz)	Power Setting	
			Chain 0 (AUX)	Chain 1 (Main)
802.11a	I	5180	17.000	17.000
		5200	17.000	17.000
		5240	17.000	17.000
	2A	5260	17.000	17.000
		5300	17.000	17.000
		5320	17.000	17.000
	2C	5500	17.000	17.000
		5580	17.000	17.000
		5700	17.000	17.000
		5720	17.000	17.000
	III	5745	17.000	17.000
		5785	17.000	17.000
5825		17.000	17.000	

Mode	U-NII Band	Centre Frequency (MHz)	Power Setting	Mode	U-NII Band	Centre Frequency (MHz)	Power Setting
802.11n- HT20	I	5180	17.000	802.11ax- HE20	I	5180	17.000
		5200	17.000			5200	17.000
		5240	17.000			5240	17.000
	2A	5260	17.000		2A	5260	17.000
		5300	17.000			5300	17.000
		5320	17.000			5320	17.000
	2C	5500	17.000		2C	5500	17.000
		5580	17.000			5580	17.000
		5700	12.500			5700	15.500
		5720	17.000			5720	17.000
	III	5745	17.000		III	5745	17.000
		5785	17.000			5785	17.000
5825		17.000	5825	17.000			

Mode	U-NII Band	Centre Frequency (MHz)	Power Setting	Mode	U-NII Band	Centre Frequency (MHz)	Power Setting
802.11n- HT40	I	5190	15.000	802.11ax- HE40	I	5190	15.000
		5230	17.000			5230	17.000
	2A	5270	17.000		2A	5270	17.000
		5310	15.250			5310	15.250
	2C	5510	14.875		2C	5510	14.750
		5550	17.000			5550	17.000
		5670	17.000			5670	17.000
		5710	17.000			5710	17.000
	III	5755	17.000		III	5755	17.000
		5795	17.000			5795	17.000

Mode	U-NII Band	Centre Frequency (MHz)	Power Setting	Mode	U-NII Band	Centre Frequency (MHz)	Power Setting
802.11 ac-VT80	I	5210	14.000	802.11ax- HE80	I	5210	14.000
	2A	5290	15.250		2A	5290	15.250
	2C	5530	13.875		2C	5530	15.000
		5610	17.000			5610	17.000
		5690	17.000			5690	17.000
	III	5775	17.000		III	5775	17.000

Mode	U-NII Band	Centre Frequency (MHz)	Power Setting	Mode	U-NII Band	Centre Frequency (MHz)	Power Setting
802.11 ac- VT160	I/2A	5250	11.000	802.11ax- HE160	I/2A	5250	11.000
	2C	5570	13.750		2C	5570	14.000

Mode	U-NII Band	Centre Frequency (MHz)	RU Configuration	Power Setting
802.11ax-HE20	I	5180	26/0	10.000
			52/37	13.000
			106/53	16.000
	2A	5320	26/8	10.000
			52/40	13.000
			106/54	15.750
	2C	5500	26/0	10.000
			52/37	13.000
			106/53	15.250
		5700	26/8	10.000
			52/40	13.000
			106/54	16.000
III	5745	26/0	16.000	
		52/37	13.000	
		106/53	17.500	
	5825	26/8	16.000	
		52/40	13.000	
		106/54	17.000	
802.11ax-HE40	I	5190	242/61	17.000
	2A	5310	242/62	16.250
	2C	5510	242/61	17.000
		5670	242/62	17.000
	III	5755	242/61	17.000
		5795	242/62	17.000
802.11ax-HE80	I	5210	484/65	15.000
	2A	5290	484/66	12.000
	2C	5530	484/65	14.125
		5610	484/66	17.000
	III	5775	484/65	17.000
			484/66	17.000
802.11ax-HE160	I/ 2A	5250	996/67	14.250
			996/S67	12.500
	2C	5570	996/67	14.000
			996/S67	17.000

3.10. Tested Supporting System List

3.10.1. Support Peripheral Unit

No.	Product	Brand	Model No.	Serial No.	Approval
1.	TV	LG	22LK330-DB	N/A	N/A
2.	USB Mouse	DENGEKI	P012 (MS-P12)	N/A	N/A
3.	Earphone	APPLE	N/A	N/A	N/A
4.	SD Card	ADATA	MicroSDHC Card	N/A	N/A
Partner System					
5.	AP Server	ASUS	RT-AX88U	N/A	FCC ID: MSQ-RTAXHP00 IC: 3568A-RTAXHP00

3.10.2. Cable Lists

No.	Cable Description Of The Above Support Units
1.	HDMI Cable: Shielded, Detachable, 1.2m AC Power Cord: Unshielded, Detachable, 1.8m
2.	USB Cable: Unshielded, Undetachable, 1.5m
3.	Earphone Cable: Unshielded, Undetachable, 1.2m
4.	N/A
5.	AC adapter: M/N:WA-30B12, Cable: Unshielded, Detachable, 1.2m LAN cable: Unshielded, Detachable, 3.0m
6.	LAN cable: Unshielded, Detachable, 1.8m

3.11. Setup Configuration

3.11.1. EUT Configuration for Power Line & Radiated Emission

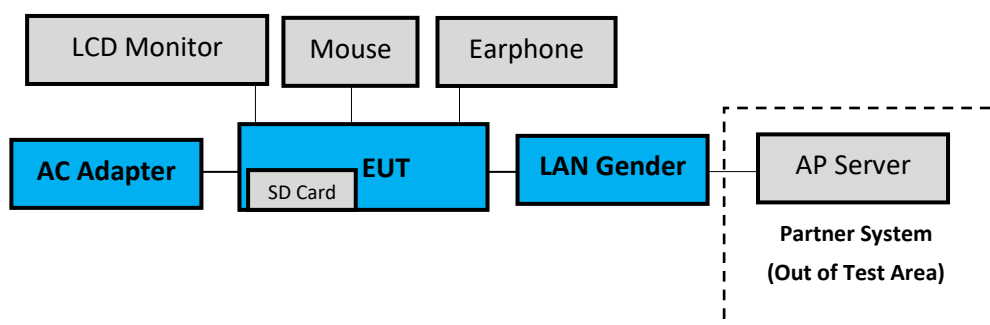

3.11.2. EUT Configuration for RF Conducted Test Items

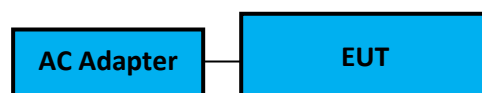

3.12. Operating Condition of EUT

Test program “DRTU” is used for enabling EUT WLAN function under continues transmitting and choosing data rate/ channel.

[Chain 0 is aux port (A Button in DRTU) Chain 1 is main port (B Button in DRTU)].

3.13. Description of Test Facility

Name of Test Firm	Audix Technology Corporation / EMC Department No. 491, Zhongfu Rd., Linkou Dist., New Taipei City 244, Taiwan Tel: +886-2-26092133 Fax: +886-2-26099303 Website : www.audixtech.com Contact e-mail: attemc_report@audixtech.com
Accreditations	The laboratory is accredited by following organizations under ISO/IEC 17025:2017 (1) NVLAP(USA) NVLAP Lab Code 200077-0 (2) TAF(Taiwan) No. 1724
Test Facilities	FCC OET Designation Number under APEC MRA by NCC is : TW1724 ISED CAB Identifier Number under APEC TEL MRA by NCC is TW1724 (1) No.8 Shielded Room (2) No.1 3m Semi Anechoic Chamber

3.14. Measurement Uncertainty

Test Items/Facilities		Frequency Range	Uncertainty	
Conduction Test		9kHz-150kHz	±3.7dB	
		150kHz-30MHz	±3.4dB	
Radiation Test	<input checked="" type="checkbox"/>	No.1 3m Semi Anechoic Chamber	30MHz-200MHz, 3m, Horizontal	±3.8dB
			200MHz-1000MHz, 3m, Horizontal	±4.1dB
			30MHz-200MHz, 3m, Vertical	±4.5dB
			200MHz-1000MHz, 3m, Vertical	±4.5dB
			1GHz-6GHz, 3m	±4.7dB
			6GHz-18GHz, 3m	±4.1dB
			18GHz-40GHz, 3m	±3.52dB
	<input type="checkbox"/>	No.3 3m Semi Anechoic Chamber	30MHz-200MHz, 3m, Horizontal	±3.9dB
			200MHz-1000MHz, 3m, Horizontal	±4.2dB
			30MHz-200MHz, 3m, Vertical	±4.3dB
			200MHz-1000MHz, 3m, Vertical	±4.5dB
	<input type="checkbox"/>	No.4 3m Semi Anechoic Chamber	30MHz-200MHz, 3m, Horizontal	±4.1dB
			200MHz-1000MHz, 3m, Horizontal	±4.5dB
			30MHz-200MHz, 3m, Vertical	±4.4dB
			200MHz-1000MHz, 3m, Vertical	±4.8dB
			1GHz-6GHz, 3m	±5.0dB
			6GHz-18GHz, 3m	±4.7dB
	<input type="checkbox"/>	No.5 3m Semi Anechoic Chamber	30MHz-200MHz, 3m, Horizontal	±4.2dB
			200MHz-1000MHz, 3m, Horizontal	±4.3dB
			30MHz-200MHz, 3m, Vertical	±4.3dB
			200MHz-1000MHz, 3m, Vertical	±4.7dB
			1GHz-6GHz, 3m	±4.8dB
			6GHz-18GHz, 3m	±4.5dB

Remark : Uncertainty = $ku_c(y)$

Test Items	Uncertainty
Emission Bandwidth	± 0.2kHz
Maximum output power	± 0.33dB
Power spectral density	± 0.13dB

4. MEASUREMENT EQUIPMENT LIST

4.1. Conducted Emission Measurement

Item	Type	Manufacturer	Model No.	Serial No.	Cal. Date	Cal. Interval
1.	Test Receiver	R&S	ESR3	101774	2022. 01. 11	1 Year
2.	A.M.N.	R&S	ENV4200	100169	2021. 11. 04	1 Year
3.	L.I.S.N.	Kyoritsu	KNW-407	8-855-9	2021. 12. 19	1 Year
4.	Pulse Limiter	R&S	ESH3-Z2	100354	2021. 12. 13	1 Year
5.	Digital Thermo-Hygro Meter	iMax	HTC-1	No.8 S/R	2022. 04. 14	1 Year
6.	Coaxial Cable	Yeida	RG/58AU	CE-08	2021. 09. 13	1 Year
7.	Test Software	Audix	e3	V6.120619c	N.C.R.	N.C.R.

4.2. Radiated Emission Measurement

Item	Type	Manufacturer	Model No.	Serial No.	Cal. Date	Cal. Interval
1.	Spectrum Analyzer	Agilent	N9010A-526	MY53400071	2021. 09. 09	1 Year
2.	Spectrum Analyzer	Keysight	N9010B-544	MY55460198	2022. 04. 08	1 Year
3.	Test Receiver	R&S	ESCS30	100039	2022. 04. 08	1 Year
4.	Amplifier	HP	8447D	2944A06305	2022. 01. 05	1 Year
5.	Microwave Amplifier	Keysight	83051A	MY53010042	2021. 07. 30	1 Year
6.	Microwave Amplifier	Keysight	83017A	MY53270365	2021. 05. 27	1 Year
7.	Loop Antenna	ETS· LINDGREN	6512	00035867	2021. 09. 29	1 Year
8.	Bilog Antenna	TESEQ	CBL6112D	33821	2021. 07. 16	1 Year
9.	Double-Ridged Waveguide Horn	EMCO	3115	9609-4927	2021. 07. 02	1 Year
10.	Horn Antenna	COM-POWE R	AH-840	101092	2022. 01. 06	1 Year
11.	5G Notch Filter	Microwave Circuits	N0452502	459775	2022. 05. 04	1 Year
12.	5G Notch Filter	Microwave Circuits	N0555983	504921	2021. 08. 04	1 Year
13.	5G Notch Filter	Microwave Circuits	N0257881	459776	2021. 08. 16	1 Year
14.	Coaxial Cable	MIYAZAKI	5D2W	RE-11	2022. 01. 20	1 Year
15.	Coaxial Cable	HUBER+SU HNER	SUCOFLEX 106	RE-14	2021. 01. 29	1 Year
16.	Coaxial Cable	HUBER+SU HNER	SUCOFLEX 102	RE-30	2021. 08. 25	1 Year
17.	Digital Thermo-Hygro Meter	iMax	HTC-1	No.3 3m A/C	2022. 04. 14	1 Year
18.	Test Software	Audix	e3	V6.120619c	N.C.R.	N.C.R.

4.3. RF Conducted Measurement

Item	Type	Manufacturer	Model No.	Serial No.	Cal. Date	Cal. Interval
1.	Spectrum Analyzer	Keysight	N9030B	MY61330403	2021. 12. 21	1 Year
2.	Power Meter	Anritsu	ML2495A	1145008	2021. 06. 30	1 Year
3.	Power Sensor	Anritsu	MA2411B	1126096	2021. 06. 30	1 Year
4.	Digital Thermo-Hygro Meter	iMax	HTC-1	RF-03	2022. 04. 14	1 Year

5. CONDUCTED EMISSION

5.1. Block Diagram of Test Setup

5.1.1. Block Diagram of EUT

Indicated as section 3.11

5.1.2. Shielded Room Setup Diagram

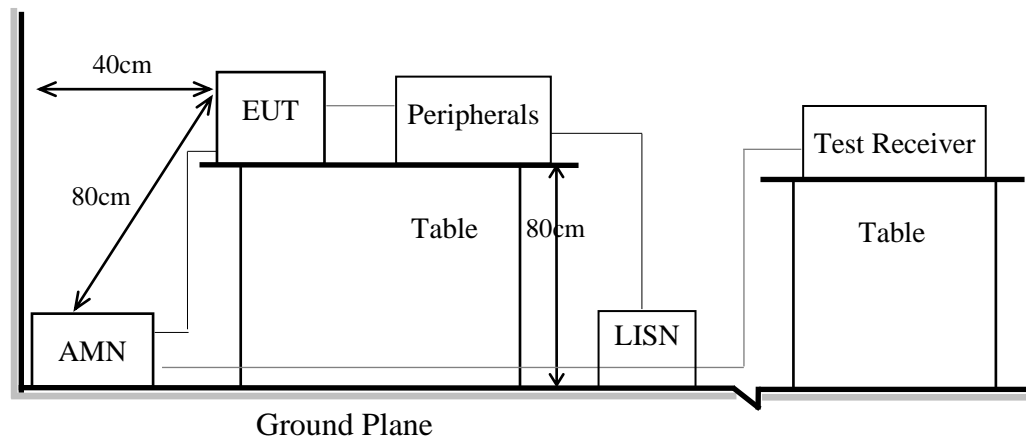

5.2. Conducted Emission Limit

Frequency	Conducted Limit	
	Quasi-Peak Level	Average Level
150kHz ~ 500kHz	66 ~ 56 dB μ V	56 ~ 46 dB μ V
500kHz ~ 5MHz	56 dB μ V	46 dB μ V
5MHz ~ 30MHz	60 dB μ V	50 dB μ V

Remark1.: If the average limit is met when using a Quasi-Peak detector, the measurement using the average detector is not required.

2.: The lower limit applies to the band edges.

5.3. Test Procedure

- 5.3.1. To set up the EUT as indicated in ANSI C63.10. The EUT was placed on the table which has 80 cm height to the ground and 40 cm distance to the conducting wall.
- 5.3.2. Power supplier of the EUT was connected to the AC mains through an Artificial Mains Network (A.M.N.).
- 5.3.3. The AC power supplies to all peripheral devices must be provided through line impedance stabilization network (L.I.S.N.)
- 5.3.4. Checking frequency range from 150kHz to 30 MHz and record the emission which does not have 20 dB below limit.



Audix Technology Corp.
No. 491, Zhongfu Rd., Linkou Dist.,
New Taipei City 244, Taiwan

Tel: +886 2 26099301
Fax: +886 2 26099303

5.4. Test Results

Please refer to Appendix A.

6. RADIATED EMISSION

6.1. Block Diagram of Test Setup

6.1.1. Block Diagram of EUT

Indicated as section 3.11

6.1.2. Setup Diagram for 9kHz-30MHz

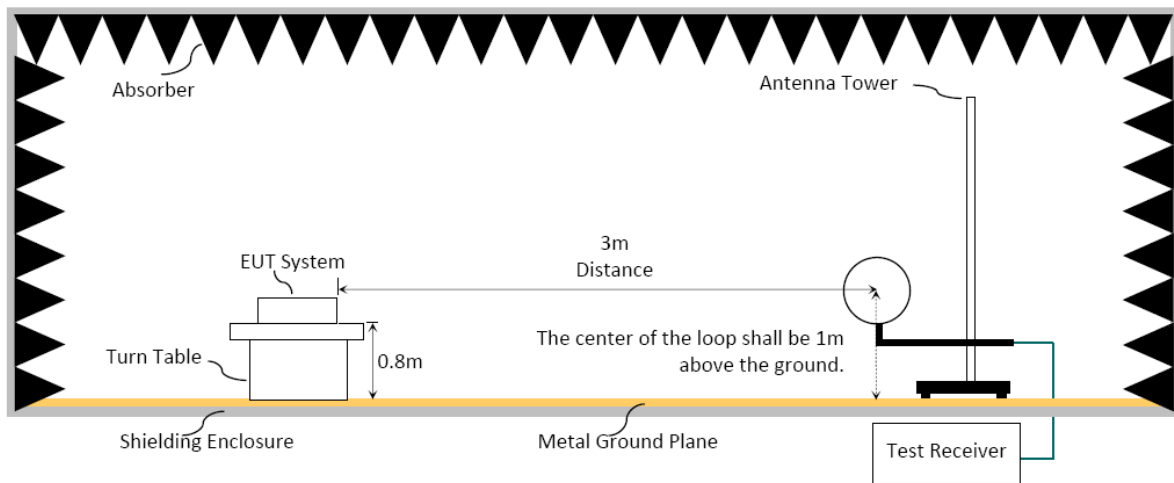

6.1.3. Setup Diagram for 30-1000MHz

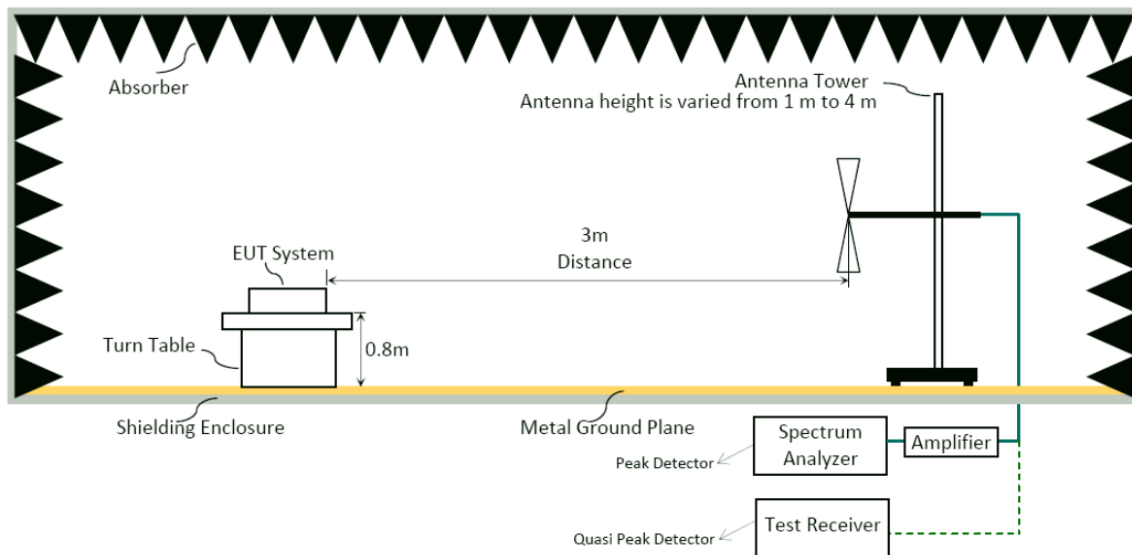

6.1.4. Setup Diagram for above 1GHz

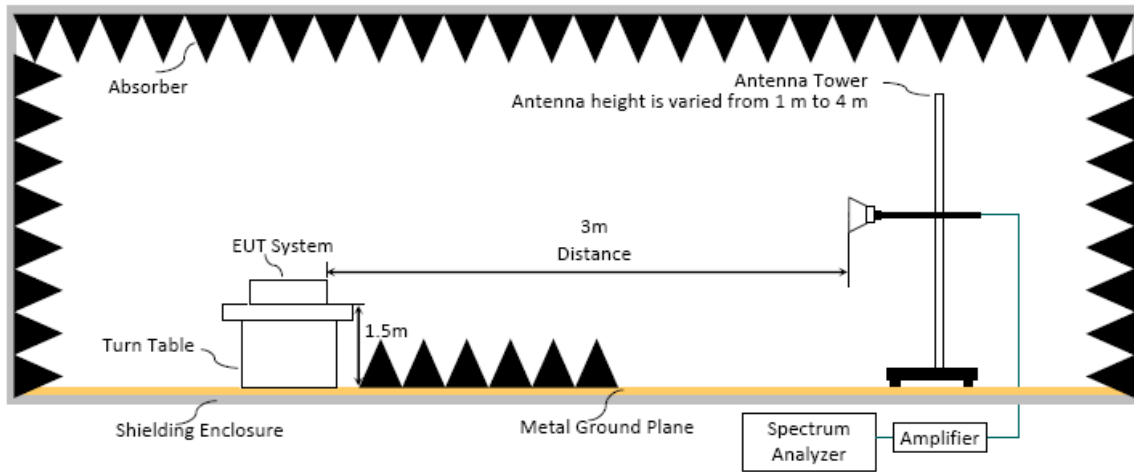

6.2. Radiated Emission Limits

Radiated emissions fall in restricted bands, as defined in Section 15.205 must be in compliance with the radiated emission limits specified in 15.209 as below.

6.2.1. General Limit

Frequency (MHz)	Distance(m)	Limits	
		dB μ V/m	μ V/m
0.009 - 0.490	300	67.6-20 log f(kHz)	2400/f kHz
0.490 - 1.705	30	87.6-20 log f(kHz)	24000/f kHz
1.705 - 30	30	29.5	30
30 - 88	3	40.0	100
88- 216	3	43.5	150
216- 960	3	46.0	200
Above 960	3	54.0	500
Above 1000	3	74.0 dB μ V/m (Peak) 54.0 dB μ V/m (Average)	

Remark : (1) dB μ V/m = 20 log (μ V/m)

- (2) The tighter limit applies to the edge between two frequency bands.
- (3) Distance refers to the distance in meters between the measuring instrument antenna and the closed point of any part of the device or system.
- (4) Fundamental and emission fall within operation band are exempted from this section.
- (5) Pursuant to ANSI C63.10: 6.6.4.3, if the maximized peak measured value complies with the average limit, then it is unnecessary to perform an average measurement.

6.2.2. Limit for non-restricted frequency above 1 GHz

Frequency Band (MHz)	E.I.R.P. Limit	Field Strength Limit at 3 m
5150 to 5250	-27 dBm	68.2
5250 to 5350		68.2
5470 to 5725		68.2

Note: Field Strength at 3 m= E.I.R.P. + 95.2 dB

Frequency Band (MHz)	Field Strength Limit at 3 m	
5725 to 5850	<input checked="" type="checkbox"/>	15.407(b)(4)(i) All emissions shall be limited to a level of 68.2 dB μ V/mat 75 MHz or more above or below the band edge increasing linearly to 105.2dB μ V/m at 25 MHz above or below the band edge, and from 25 MHz above or below the band edge increasing linearly to a level of 110.8 dB μ V/m at 5 MHz above or below the band edge increasing linearly to a level of 68.2 dB μ V/m at the band edge.
	<input type="checkbox"/>	15.407(b)(4)(ii) ,compliance with the emission limits in § 15.247(d) Shall be at least 30dB below that in the 100 kHz bandwidth within the band that contains the highest level of the desired power,. Attenuation below the general limits specified in §15.209(a) is not required. In addition,radiated emissions which fall in the restricted bands, as defined in §15.205(a), must also comply with the radiated emission limits specified in §15.209(a) (see §15.205(c))

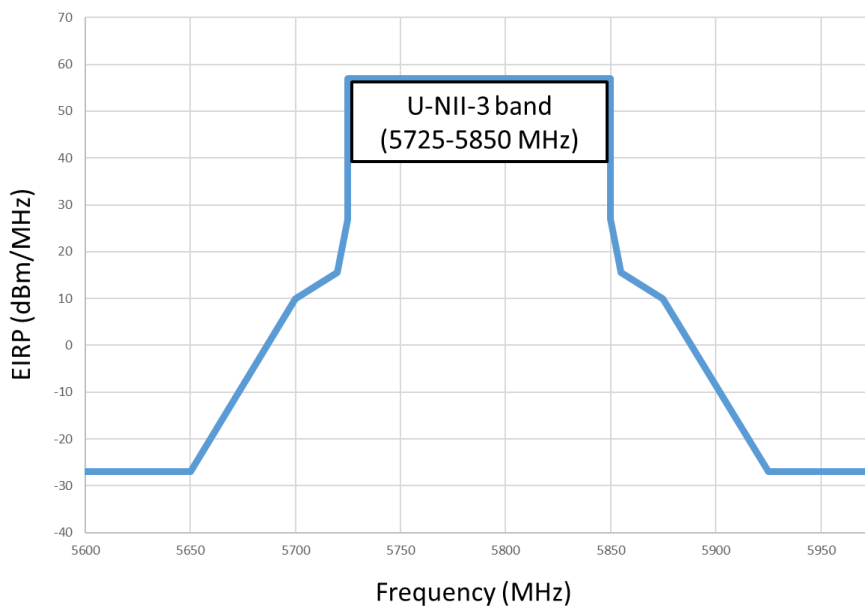

6.3. Test Procedure

Frequency Range 9kHz~30MHz:

The EUT setup on the turntable which has 0.8 m height to the ground. The turn table rotated 360 degrees and antenna fixed to 1 m to find the maximum emission level. In order to find the maximum emission, all of the interface cables were manipulated according to ANSI C63.10-2013 regulation.

- (1) RBW = 9kHz with peak and average detector.
- (2) Detector: average and peak (9kHz-490kHz)
Q.P. (490kHz-30MHz)

Frequency Range 30MHz ~ 40GHz:

The EUT setup on the turn table which has 80cm (for 30-1000MHz) and 1.5m (for above 1GHz) height to the ground. The turn table rotated 360 degrees and antenna varied from 1 m to 4 m to find the maximum emission level. Both horizontal and vertical polarization are required. In order to find the maximum emission, all of the interface cables were manipulated according to ANSI C63.10-2013 regulation.

Frequency below 1GHz:

Spectrum Analyzer is used for pre-testing with following setting:

- (1)RBW = 120kHz
- (2)VBW $\geq 3 \times$ RBW.
- (3)Detector = Peak.
- (4)Sweep time = auto.
- (5)Trace mode = max hold.
- (6)Allow sweeps to continue until the trace stabilizes.

Note 1: When peak-detected value is lower than limit that the measurement using the Q.P. detector is not required, otherwise using Q.P. for final measurement.

Note 2: When the radiated emissions limits are expressed in terms of the average value of the emissions, and pulsed operation is employed, the measurement field strength shall be determined by averaging over one complete pulse train, including blanking intervals, as long as the pulse train does not exceed 0.1 seconds.

Frequency above 1GHz to 10th harmonic(up to 40 GHz):

Peak Detector:

- (1)RBW = 1MHz
- (2)VBW $\geq 3 \times$ RBW.
- (3)Detector = Peak.
- (4)Sweep time = auto.
- (5)Trace mode = max hold.
- (6)Allow sweeps to continue until the trace stabilizes.

Note: When peak-detected value is lower than limit that the measurement using the average detector is not required, otherwise using average detector for final measurement.

Average Detector: **Option 1:**

- (1) RBW = 1MHz
- (2) VBW $\geq 1/T$. (Duty Cycle < 98%, when duty cycle presented in section 3.8)
- (3) VBW = 10Hz (Duty Cycle $\geq 98\%$, when duty cycle presented in section 3.8)
- (4) Detector = Peak.
- (5) Sweep time = auto.
- (6) Trace mode = max hold.
- (7) Allow sweeps to continue until the trace stabilizes.

 Option 2:

Average Emission Level = Peak Emission Level + D.C.C.F.

6.4. Measurement Result Explanation

- Peak Emission Level = Antenna Factor + Cable Loss + Meter Reading (including Preamp factor if test used)
- Average Emission Level = Antenna Factor + Cable Loss + Meter Reading (including Preamp factor if test used)
- Average Emission Level = Peak Emission Level + DCCF
Duty Cycle Correction Factor (DCCF) = $20\log(TX_{on}/TX_{on+off})$ presented in section 3.8.
- ERP = Peak Emission Level - 95.2dB - 2.14dB

6.5. Test Results

Please refer to Appendix A.



Audix Technology Corp.
No. 491, Zhongfu Rd., Linkou Dist.,
New Taipei City 244, Taiwan

Tel: +886 2 26099301
Fax: +886 2 26099303

7. DEVIATION TO TEST SPECIFICATIONS

【NONE】



APPDNDIX A

TEST DATA AND PLOTS

(Model: 17Z90Q)

TABLE OF CONTENTS

A.1 CONDUCTED EMISSION	2
A.2 RADIATED EMISSION	6
A.2.1 Emissions within Restricted Frequency Bands.....	6
A.2.2 Emissions outside the frequency band.....	8
A.2.3 Emissions in Non-restricted Frequency Bands.....	8
A.3 MAXIMUM OUTPUT POWER	9
A.3.1 Average Output Power	9

A.1 CONDUCTED EMISSION

Test Date	2022/05/21	Temp./Hum.	24°C/73%
Test Voltage	AC 120V 60Hz (Via AC Adapter)	Tested By	Chucky Chiu
Test SKU	SKU #1 (with INPAQ Antenna)	Test Model	17Z90Q

Data: 2 File: D:\test data\REPORT\2022\C1M2201XXX\C1M2201241\20220521\C1M2201241-C-D

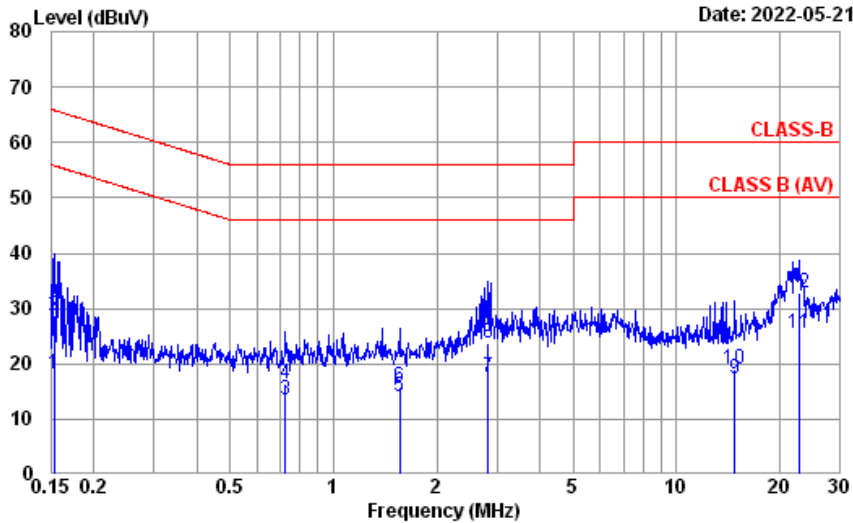

Site No.	: No.8 Shielded Room	Data No.	: 2
Instrument 1	: Receiver ESR3(774)		
Instrument 2	: EHV4200 (169)(A) CE-08 ESH3-Z2 (354)		
Limit	: CLASS-B	Phase	: NEUTRAL
Environment	: 24°C / 73%	Engineer	: Chucky Chiu
EUT Model	: 17Z90Q	Test Rating	: 120Vac/60Hz
Test Mode	: Operating		
	Inpaq		

	Freq. (MHz)	AMN Factor (dB)	Cable Loss (dB)	Pulse Att. (dB)	Reading (dBµV)	Emission Level (dBµV)	Limits (dBµV)	Margin (dB)	Remark
1	0.153	10.64	0.03	9.85	-2.36	18.16	55.82	37.66	Average
2	0.153	10.64	0.03	9.85	8.19	28.71	65.82	37.11	QP
3	0.724	10.43	0.04	9.85	-6.80	13.52	46.00	32.48	Average
4	0.724	10.43	0.04	9.85	-3.92	16.40	56.00	39.60	QP
5	1.560	10.45	0.05	9.86	-6.31	14.05	46.00	31.95	Average
6	1.560	10.45	0.05	9.86	-4.43	15.93	56.00	40.07	QP
7	2.824	10.53	0.08	9.86	-2.93	17.54	46.00	28.46	Average
8	2.824	10.53	0.08	9.86	3.28	23.75	56.00	32.25	QP
9	14.750	12.59	0.17	9.91	-5.47	17.20	50.00	32.80	Average
10	14.750	12.59	0.17	9.91	-3.51	19.16	60.00	40.84	QP
11	22.775	14.49	0.21	9.96	0.90	25.56	50.00	24.44	Average
12	22.775	14.49	0.21	9.96	8.16	32.82	60.00	27.18	QP

Remarks: 1. Emission Level= AMN Factor + Cable Loss + Pulse Att. + Reading.
 2. If the average limit is met when using a quasi-peak detector, the EUT shall be deemed to meet both limits and measurement with average detector is unnecessary.

Test Date	2022/05/21	Temp./Hum.	24°C/73%
Test Voltage	AC 120V 60Hz (Via AC Adapter)	Tested By	Chucky Chiu
Test SKU	SKU #1 (with INPAQ Antenna)	Test Model	17Z90Q

Data: 1 File: D:\test data\REPORT\2022\CIM2201XXX\CIM2201241\20220521\CIM2201241-C-D

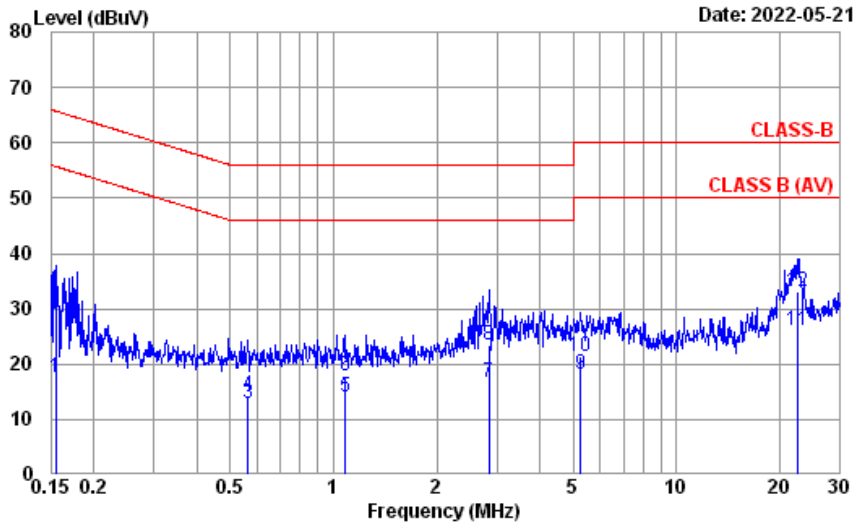

Site No. : No.8 Shielded Room Data No. : 1
 Instrument 1 : Receiver ESR3(774)
 Instrument 2 : EHV4200 (169)(A)|CE-08|ESH3-Z2 (354)
 Limit : CLASS-B Phase : LINE
 Environment : 24°C / 73% Engineer : Chucky Chiu
 EUT Model : 17Z90Q Test Rating : 120Vac/60Hz
 Test Mode : Operating
 Inpaq

	Freq. (MHz)	AMN Factor (dB)	Cable Loss (dB)	Pulse Att. (dB)	Reading (dBµV)	Emission Level (dBµV)	Limits (dBµV)	Margin (dB)	Remark
1	0.155	10.59	0.03	9.85	-2.99	17.48	55.74	38.26	Average
2	0.155	10.59	0.03	9.85	10.18	30.65	65.74	35.09	QP
3	0.564	10.41	0.03	9.85	-7.31	12.98	46.00	33.02	Average
4	0.564	10.41	0.03	9.85	-5.88	14.41	56.00	41.59	QP
5	1.082	10.40	0.04	9.85	-6.19	14.10	46.00	31.90	Average
6	1.082	10.40	0.04	9.85	-2.31	17.98	56.00	38.02	QP
7	2.839	10.48	0.08	9.86	-3.60	16.82	46.00	29.18	Average
8	2.839	10.48	0.08	9.86	2.90	23.32	56.00	32.68	QP
9	5.249	10.69	0.10	9.87	-2.59	18.07	50.00	31.93	Average
10	5.249	10.69	0.10	9.87	0.72	21.38	60.00	38.62	QP
11	22.416	13.66	0.20	9.95	2.19	26.00	50.00	24.00	Average
12	22.416	13.66	0.20	9.95	9.36	33.17	60.00	26.83	QP

Remarks: 1. Emission Level= AMN Factor + Cable Loss + Pulse Att. + Reading.
 2. If the average limit is met when using a quasi-peak detector,
 the EUT shall be deemed to meet both limits and measurement
 with average detector is unnecessary.

Test Date	2022/05/21	Temp./Hum.	24°C/73%
Test Voltage	AC 120V 60Hz (Via AC Adapter)	Tested By	Chucky Chiu
Test SKU	SKU #2 (with LUXSHARE-ICT Antenna)	Test Model	17Z90Q

Data: 3 File: D:\test data\REPORT\2022\C1M2201XXX\C1M2201241\20220521\C1M2201241-C-D Date: 2022-05-21

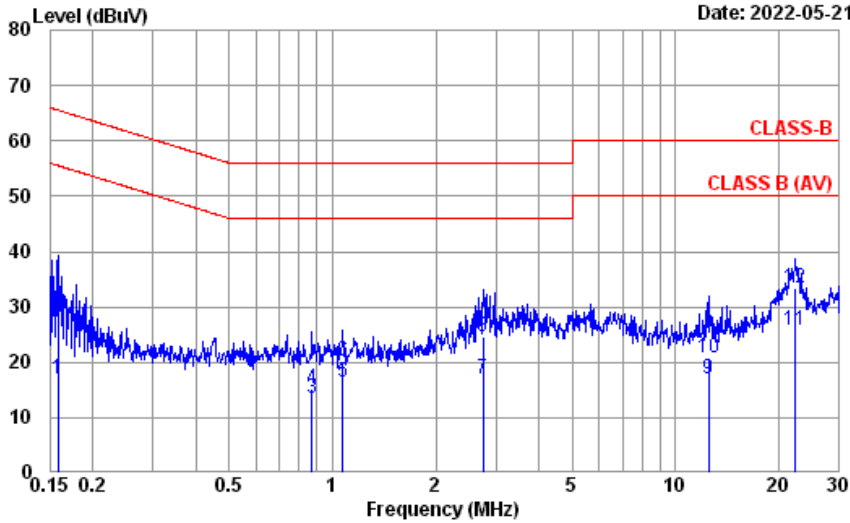

Site No. : No.8 Shielded Room Data No. : 3
 Instrument 1 : Receiver ESR3(774)
 Instrument 2 : EHV4200 (169)(A)|CE-08|ESH3-Z2 (354)
 Limit : CLASS-B Phase : NEUTRAL
 Environment : 24°C / 73% Engineer : Chucky Chiu
 EUT Model : 17Z90Q Test Rating : 120Vac/60Hz
 Test Mode : Operating Luxshare

	Freq. (MHz)	AMN Factor (dB)	Cable Loss (dB)	Pulse Att. (dB)	Reading (dBµV)	Emission Level (dBµV)	Limits (dBµV)	Margin (dB)	Remark
1	0.158	10.64	0.03	9.85	-3.55	16.97	55.56	38.59	Average
2	0.158	10.64	0.03	9.85	8.65	29.17	65.56	36.39	QP
3	0.871	10.42	0.04	9.85	-6.71	13.60	46.00	32.40	Average
4	0.871	10.42	0.04	9.85	-5.13	15.18	56.00	40.82	QP
5	1.071	10.42	0.04	9.85	-3.76	16.55	46.00	29.45	Average
6	1.071	10.42	0.04	9.85	-0.07	20.24	56.00	35.76	QP
7	2.750	10.53	0.07	9.86	-3.51	16.95	46.00	29.05	Average
8	2.750	10.53	0.07	9.86	4.14	24.60	56.00	31.40	QP
9	12.449	12.04	0.15	9.90	-5.09	17.00	50.00	33.00	Average
10	12.449	12.04	0.15	9.90	-1.32	20.77	60.00	39.23	QP
11	22.298	14.34	0.20	9.95	1.34	25.83	50.00	24.17	Average
12	22.298	14.34	0.20	9.95	8.81	33.30	60.00	26.70	QP

Remarks: 1. Emission Level= AMN Factor + Cable Loss + Pulse Att. + Reading.
 2. If the average limit is met when using a quasi-peak detector,
 the EUT shall be deemed to meet both limits and measurement
 with average detector is unnecessary.

Test Date	2022/05/21	Temp./Hum.	24°C/73%
Test Voltage	AC 120V 60Hz (Via AC Adapter)	Tested By	Chucky Chiu
Test SKU	SKU #2 (with LUXSHARE-ICT Antenna)	Test Model	17Z90Q

Data: 4 File: D:\test data\REPORT\2022\C1M2201XXX\C1M2201241\20220521\C1M2201241-C-D

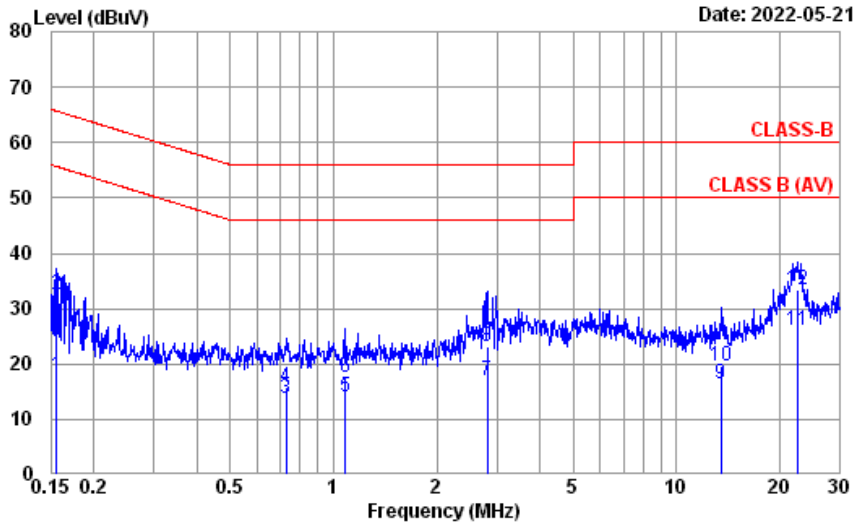

Site No.	: No.8 Shielded Room	Data No.	: 4
Instrument 1	: Receiver ESR3(774)		
Instrument 2	: EHV4200 (169)(A) CE-08 ESH3-Z2 (354)		
Limit	: CLASS-B	Phase	: LINE
Environment	: 24°C / 73%	Engineer	: Chucky Chiu
EUT Model	: 17Z90Q	Test Rating	: 120Vac/60Hz
Test Mode	: Operating Luxshare		

	Freq. (MHz)	AMN Factor (dB)	Cable Loss (dB)	Pulse Att. (dB)	Reading (dBµV)	Emission Level (dBµV)	Limits (dBµV)	Margin (dB)	Remark
1	0.156	10.59	0.03	9.85	-2.65	17.82	55.69	37.87	Average
2	0.156	10.59	0.03	9.85	11.92	32.39	65.69	33.30	QP
3	0.727	10.41	0.04	9.85	-6.57	13.73	46.00	32.27	Average
4	0.727	10.41	0.04	9.85	-4.54	15.76	56.00	40.24	QP
5	1.082	10.40	0.04	9.85	-6.26	14.03	46.00	31.97	Average
6	1.082	10.40	0.04	9.85	-2.83	17.46	56.00	38.54	QP
7	2.809	10.48	0.07	9.86	-3.53	16.88	46.00	29.12	Average
8	2.809	10.48	0.07	9.86	2.61	23.02	56.00	32.98	QP
9	13.479	11.86	0.16	9.90	-5.38	16.54	50.00	33.46	Average
10	13.479	11.86	0.16	9.90	-2.27	19.65	60.00	40.35	QP
11	22.416	13.66	0.20	9.95	2.13	25.94	50.00	24.06	Average
12	22.416	13.66	0.20	9.95	9.62	33.43	60.00	26.57	QP

Remarks: 1. Emission Level= AMN Factor + Cable Loss + Pulse Att. + Reading.
 2. If the average limit is met when using a quasi-peak detector, the EUT shall be deemed to meet both limits and measurement with average detector is unnecessary.

A.2 RADIATED EMISSION

Test Date	2022/05/26 ~ 06/09	Temp./Hum.	22 ~ 25°C/65 ~ 69%
Test Voltage	AC 120V 60Hz (Via AC Adapter)	Tested By	Brian Hsieh

A.2.1 Emissions within Restricted Frequency Bands

A.2.1.1 Frequency 9kHz~30MHz

The emissions (9kHz~30MHz) not reported for there is no emission be found.

A.2.1.2 Frequency Below 1GHz

● **Test SKU #1 (with INPAQ Antenna)**

Mode	802.11n-HT40	U-NII Band	2C
		Frequency	TX 5710MHz

Antenna at Horizontal Polarization

Emission Frequency (MHz)	Antenna Factor (dB/m)	Cable Loss (dB)	Preamplifier Gain (dB)	Read Level (dBμV)	Emission Level (dBμV/m)	Limits (dBμV/m)	Margin (dB)	Detector
32.910	22.52	1.48	26.48	27.83	25.35	40.00	14.65	Peak
138.640	17.03	3.08	26.05	38.11	32.17	43.50	11.33	Peak
167.740	15.40	3.39	25.91	43.70	36.58	43.50	6.92	Peak
277.350	18.69	4.50	25.64	37.37	34.92	46.00	11.08	Peak
346.220	20.24	5.31	26.01	36.09	35.63	46.00	10.37	Peak
483.960	22.87	6.64	27.04	33.43	35.90	46.00	10.10	Peak

Antenna at Vertical Polarization

Emission Frequency (MHz)	Antenna Factor (dB/m)	Cable Loss (dB)	Preamplifier Gain (dB)	Read Level (dBμV)	Emission Level (dBμV/m)	Limits (dBμV/m)	Margin (dB)	Detector
38.730	19.62	1.61	26.47	32.99	27.75	40.00	12.25	Peak
137.670	17.07	3.07	26.06	36.16	30.24	43.50	13.26	Peak
207.510	15.63	3.80	25.77	38.28	31.94	43.50	11.56	Peak
346.220	20.24	5.31	26.01	33.02	32.56	46.00	13.44	Peak
483.960	22.87	6.64	27.04	34.14	36.61	46.00	9.39	Peak
829.280	26.06	8.38	27.18	32.52	39.78	46.00	6.22	Peak

● **Test SKU #2 (with LUXSHARE-ICT Antenna)**

Mode	802.11n-HT40	U-NII Band	2C
		Frequency	TX 5710MHz

Antenna at Horizontal Polarization

Emission Frequency (MHz)	Antenna Factor (dB/m)	Cable Loss (dB)	Preamplifier Gain (dB)	Read Level (dBμV)	Emission Level (dBμV/m)	Limits (dBμV/m)	Margin (dB)	Detector
34.850	21.77	1.53	26.48	29.15	25.97	40.00	14.03	Peak
114.390	17.61	2.79	26.19	37.40	31.61	43.50	11.89	Peak
207.510	15.63	3.80	25.77	37.18	30.84	43.50	12.66	Peak
346.220	20.24	5.31	26.01	36.97	36.51	46.00	9.49	Peak
482.990	22.84	6.63	27.01	33.20	35.66	46.00	10.34	Peak
520.820	23.38	6.84	27.19	33.45	36.48	46.00	9.52	Peak

Antenna at Vertical Polarization

Emission Frequency (MHz)	Antenna Factor (dB/m)	Cable Loss (dB)	Preamplifier Gain (dB)	Read Level (dBμV)	Emission Level (dBμV/m)	Limits (dBμV/m)	Margin (dB)	Detector
62.010	12.19	2.03	26.41	39.70	27.51	40.00	12.49	Peak
138.640	17.03	3.08	26.05	39.06	33.12	43.50	10.38	Peak
156.100	15.94	3.26	25.97	38.94	32.17	43.50	11.33	Peak
207.510	15.63	3.80	25.77	40.76	34.42	43.50	9.08	Peak
277.350	18.69	4.50	25.64	32.48	30.03	46.00	15.97	Peak
346.220	20.24	5.31	26.01	30.79	30.33	46.00	15.67	Peak

A.2.2 Emissions outside the frequency band

The emissions (up to 40GHz) not reported for there is no emission be found.

● **Test SKU #2 (with LUXSHARE-ICT Antenna)**

Mode	802.11n-HT40	U-NII Band	2C
		Frequency	TX 5710MHz

Antenna at Horizontal Polarization

Emission Frequency (MHz)	Antenna Factor (dB/m)	Cable Loss (dB)	Preamplifier Gain (dB)	Read Level (dBμV)	Emission Level (dBμV/m)	Limits (dBμV/m)	Margin (dB)	Detector
11420.000	39.47	13.55	33.64	29.11	48.49	54.00	5.51	Peak

Antenna at Vertical Polarization

Emission Frequency (MHz)	Antenna Factor (dB/m)	Cable Loss (dB)	Preamplifier Gain (dB)	Read Level (dBμV)	Emission Level (dBμV/m)	Limits (dBμV/m)	Margin (dB)	Detector
11420.000	39.47	13.55	33.64	28.53	47.91	54.00	6.09	Peak

A.2.3 Emissions in Non-restricted Frequency Bands

Pursuant to KDB 789033 D02 General UNII Test Procedures New Rules v02r01 that emission levels below the 15.209 general radiated emissions limits is not required.

A.3 MAXIMUM OUTPUT POWER

Test Date	2022/05/30	Temp./Hum.	25°C/58%
Cable Loss	1.0dB	Tested By	Brina Hsieh
Test Voltage	AC 120V 60Hz (Via AC Adapter)		

A.3.1 Average Output Power

Mode	U-NII Band	Centre Frequency (MHz)	Average Output Power(dBm)		10log (1/X)	Max Average Output Power		Limit
			Chain 0 (AUX)	Chain 1 (Main)		(dBm)	(W)	
802.11a	I	5180	17.07	17.43	N/A	17.43	0.055	< 250 mW (24 dBm)
		5200	17.07	17.27		17.27	0.053	
		5240	17.36	17.04		17.36	0.054	
	2A	5260	17.13	17.19		17.19	0.052	
		5300	16.50	16.83		16.83	0.048	
		5320	17.02	16.71		17.02	0.050	
	2C	5500	16.06	17.02		17.02	0.050	
		5580	16.82	16.78		16.82	0.048	
		5700	16.45	17.12		17.12	0.052	
		5720	17.15	16.45		17.15	0.052	
	III	5745	16.94	17.24		17.24	0.053	< 1 W (30 dBm)
		5785	16.97	14.23		16.97	0.050	
		5825	16.93	17.23		17.23	0.053	

Note: 1. The results have been included cable loss.

Mode	U-NII Band	Centre Frequency (MHz)	Average Output Power(dBm)		10log (1/X)	Total Average Output Power		Limit
			Chain 0 (AUX)	Chain 1 (Main)		(dBm)	(W)	
802.11n-HT20	I	5180	16.61	16.63	N/A	19.63	0.092	< 250 mW (24 dBm)
		5200	16.36	16.81		19.60	0.091	
		5240	16.86	16.92		19.90	0.098	
	2A	5260	16.88	16.25		19.08	0.081	
		5300	16.58	16.40		19.50	0.089	
		5320	16.26	16.58		19.43	0.088	
	2C	5500	16.43	16.73		19.59	0.091	
		5580	16.72	16.56		19.65	0.092	
		5700	12.40	12.40		15.41	0.035	
		5720	16.77	16.85		19.82	0.096	
	III	5745	16.03	16.51		19.29	0.085	
		5785	16.41	16.44		19.44	0.088	
5825		16.43	16.46	19.46	0.088			
802.11n-HT40	I	5190	15.31	15.41	18.37	0.069	< 250 mW (24 dBm)	
		5230	16.79	17.24	20.03	0.101		
	2A	5270	16.96	16.40	19.70	0.093		
		5310	15.14	15.21	18.19	0.066		
	2C	5510	15.44	15.24	18.35	0.068		
		5550	16.81	17.00	19.92	0.098		
		5670	17.02	17.11	20.08	0.102		
		5710	17.09	17.45	20.28	0.107		
	III	5755	17.14	17.22	20.19	0.104		
		5795	16.80	17.26	20.05	0.101		
802.11ac-VHT80	I	5210	12.64	13.35	16.02	0.040	< 250 mW (24 dBm)	
	2A	5290	13.20	14.09	16.68	0.047		
	2C	5530	13.14	13.84	16.51	0.045		
		5610	15.46	15.54	18.51	0.071		
		5690	15.46	16.50	19.02	0.080		
	III	5775	16.40	16.40	19.41	0.087		
802.11ac-VHT160	I/ 2A	5250	10.77	10.66	13.73	0.024	< 250 mW (24 dBm)	
	2C	5570	12.78	12.96	15.88	0.039		

Note: The results have been included cable loss.

Mode	U-NII Band	Centre Frequency (MHz)	Average Output Power(dBm)		10log (1/X)	Total Average Output Power		Limit
			Chain 0 (AUX)	Chain 1 (Main)		(dBm)	(W)	
802.11ax-HE20	I	5180	16.43	16.96	N/A	19.71	0.094	< 250 mW (24 dBm)
		5200	16.76	16.74		19.76	0.095	
		5240	16.62	16.56		19.60	0.091	
	2A	5260	16.37	16.54		19.47	0.089	
		5300	16.84	17.21		20.04	0.101	
		5320	16.82	17.00		19.92	0.098	
	2C	5500	16.31	16.39		19.36	0.086	
		5580	16.84	16.84		19.85	0.097	
		5700	16.79	15.72		19.77	0.095	
		5720	16.30	16.68		19.50	0.089	
	III	5745	16.78	17.02		19.91	0.098	
		5785	16.92	16.89		19.92	0.098	
5825		16.71	16.44	19.59	0.091			
802.11ax-HE40	I	5190	15.19	15.01	N/A	18.11	0.065	< 250 mW (24 dBm)
		5230	16.71	16.51		19.62	0.092	
	2A	5270	16.90	16.62		19.77	0.095	
		5310	14.51	14.96		17.75	0.060	
	2C	5510	14.62	14.73		17.69	0.059	
		5550	16.22	16.63		19.44	0.088	
		5670	17.34	16.85		20.11	0.103	
	III	5710	16.59	17.03		19.83	0.096	
		5755	16.60	17.09		19.86	0.097	
	5795	16.29	16.91	19.62		0.092		
802.11ax-HE80	I	5210	12.57	13.37	N/A	16.00	0.040	< 250 mW (24 dBm)
	2A	5290	13.31	14.29		16.84	0.048	
		5530	13.98	14.20		17.10	0.051	
	2C	5610	15.84	15.53		18.70	0.074	
		5690	15.18	15.58		18.39	0.069	
	III	5775	15.30	15.45		18.39	0.069	
802.11ax-HE160	I/ 2A	5250	9.73	10.50	N/A	13.14	0.021	< 250 mW (24 dBm)
	2C	5570	12.76	13.19		15.99	0.040	

Note: The results have been included cable loss.

Mode	U-NII Band	Centre Frequency (MHz)	RU Configuration	Average Output Power(dBm)		10log (1/X)	Total Average Output Power		Limit
				Chain 0 (AUX)	Chain 1 (Main)		(dBm)	(W)	
802.11ax-HE20	I	5180	26/0	9.56	9.39	0.141	12.63	0.018	< 250 mW (24 dBm)
			52/37	12.11	12.96	N/A	15.57	0.036	
			106/53	15.58	15.44		18.52	0.071	
	2A	5320	26/8	9.86	9.42	0.141	12.80	0.019	
			52/40	13.29	13.25	N/A	16.28	0.042	
			106/54	14.96	15.79		18.41	0.069	
	2C	5500	26/0	9.78	9.78	0.141	12.93	0.020	
			52/37	13.44	12.84	N/A	16.16	0.041	
			106/53	15.19	14.74		17.98	0.063	
		5700	26/8	9.69	9.50	0.141	12.75	0.019	
			52/40	13.13	13.15	N/A	16.15	0.041	
			106/54	15.25	15.76		18.52	0.071	
	III	5745	26/0	15.09	15.73	0.141	18.57	0.072	
			52/37	11.97	12.86	N/A	15.45	0.035	
			106/53	16.47	13.62		18.29	0.067	
		5825	26/8	15.94	15.92	0.141	19.08	0.081	
			52/40	13.26	13.12	N/A	16.20	0.042	
			106/54	16.71	17.13		19.94	0.099	
802.11ax-HE40	I	5190	242/61	16.93	16.97	0.141	20.10	0.102	< 250 mW (24 dBm)
	2A	5310	242/62	15.11	15.75		18.59	0.072	
	2C	5510	242/61	16.44	16.37		18.94	0.078	
		5670	242/62	16.79	16.09		19.61	0.091	
	III	5755	242/61	16.62	16.56		19.74	0.094	< 1 W (30 dBm)
		5795	242/62	16.33	16.65		19.64	0.092	

Note: The results have been included cable loss.

Mode	U-NII Band	Centre Frequency (MHz)	RU Configuration	Average Output Power(dBm)		10log (1/X)	Total Average Output Power		Limit
				Chain 0 (AUX)	Chain 1 (Main)		(dBm)	(W)	
802.11ax-HE80	1	5210	484/65	14.66	15.32	0.141	18.15	0.065	< 250 mW (24 dBm)
	2A	5290	484/66	11.48	11.33		14.56	0.029	
	2C	5530	484/65	13.88	14.13		17.16	0.052	
		5610	484/66	16.21	16.91		19.73	0.094	
	3	5775	484/65	16.04	16.70		19.53	0.090	< 1 W (30 dBm)
			484/66	16.57	17.07		19.98	0.100	
802.11ax-HE160	1/ 2A	5250	996/67	13.48	13.33	0.141	16.56	0.045	< 250 mW (24 dBm)
			996/S67	11.34	12.24		14.96	0.031	
	2C	5570	996/67	12.93	13.14		16.19	0.042	
			996/S67	15.26	15.00		18.28	0.067	

Note: The results have been included cable loss.



Audix Technology Corp.
No. 491, Zhongfu Rd., Linkou Dist.,
New Taipei City 244, Taiwan

Tel: +886 2 26099301
Fax: +886 2 26099303

APPDNDIX B

TEST PHOTOGRAPHS

(Model: 17Z90Q)