

FCC 15.407 WLAN 6GHz Test Report

for

LG Electronics Inc.

**222, LG-ro, Jinwi-myeon Pyeongtaek-Si, Gyeonggi-Do,
17709 Republic of Korea**

Product Name : Notebook Computer
Model Name : (1)17Z90Q (2)17ZB90Q
(3)17ZD90Q (4)17ZG90Q
Brand : LG
FCC ID : BEJNT-17Z90Q

**Prepared by: : AUDIX Technology Corporation,
EMC Department**



The test report is based on a single evaluation of one sample of the above-mentioned products. It does not imply an assessment of the whole production and does not permit the use of the test lab logo.

TABLE OF CONTENTS

Description	Page
TEST REPORT.....	4
1. REVISION RECORD OF TEST REPORT	5
2. SUMMARY OF TEST RESULTS	6
3. GENERAL INFORMATION	7
3.1. Description of Application	7
3.2. Description of EUT	8
3.3. Reference Test Guidance.....	9
3.4. Antenna Information	10
3.5. EUT Specifications Assessed in Current Report	11
3.6. Description of Key Components	14
3.7. Test Configuration.....	16
3.8. Output Power Setting	21
3.9. Tested Supporting System List.....	22
3.10. Setup Configuration.....	22
3.11. Operating Condition of EUT	23
3.12. Description of Test Facility	23
3.13. Measurement Uncertainty	24
4. MEASUREMENT EQUIPMENTLIST.....	25
4.1. Conducted Emission Measurement	25
4.2. Radiated Emission Measurement	26
4.3. RF Conducted Measurement	27
4.4. Contention Based Protocol Measurement	27
5. CONDUCTED EMISSION.....	28
5.1. Block Diagram of Test Setup	28
5.2. Conducted Emission Limit	28
5.3. Test Procedure	28
5.4. Test Results	28
6. RADIATED EMISSION	29
6.1. Block Diagram of Test Setup	29
6.2. Radiated Emission Limits.....	31
6.3. Test Procedure	32
6.4. Measurement Result Explanation.....	34
6.5. Test Results	34
7. MAXIMUM POWER SPECTRAL DENSITY.....	35
7.1. Block Diagram of Test Setup	35
7.2. Specification Limits.....	35
7.3. Test Procedure	35
7.4. Test Results	35
8. MAXIMUM CONDUCTED OUTPUT POWER	36
8.1. Block Diagram of Test Setup	36
8.2. Specification Limits.....	36
8.3. Test Procedure	36
8.4. Test Results	36
9. EMISSION/OCCUPIED BANDWIDTH.....	37

9.1. Block Diagram of Test Setup	37
9.2. Specification Limits.....	37
9.3. Test Procedure	37
9.4. Test Results	37
10. UNDERSIRABLE EMISSIONS LIMITS:OUT OF BAND SPURIOUS EMISSION (CONDUCTED)	38
10.1. Block Diagram of Test Setup	38
10.2. Band Edge/Spurious Emission Specification Limits.....	38
10.3. Test Procedure	38
10.4. Test Results	38
11. IN-BAND EMISSION (CHANNEL MASK).....	39
11.1. Block Diagram of Test Setup	39
11.2. Specification Limits.....	39
11.3. Test Procedure	39
11.4. Test Results	40
12. CONTENTION BASED PROTOCOL	41
12.1. Block Diagram of Test Setup	41
12.2. Specification Limits.....	41
12.3. Test Procedure	43
12.4. Test Results	43
13. DEVIATION TO TEST SPECIFICATIONS	44

APPENDIX A TEST DATA AND PLOTS

APPENDIX B TESTPHOTOGRAPHS

TEST REPORT

Applicant : LG Electronics Inc.
Manufacturer : LG Electronics Inc.
Factory : LG Electronics Nanjing New Technology Co., Ltd.
EUT Description
(1) Product : Notebook Computer
(2) Model : (1)17Z90Q (2)17ZB90Q (3)17ZD90Q (4)17ZG90Q
(3) Brand : LG
(4) Power Supply: DC 20V

Applicable Standards:

Title 47 FCC CFR Part 15 Subpart E

Audix Technology Corp. tested the equipment mentioned in accordance with the requirements set forth in the above standards. Test results indicate that the equipment tested is capable of demonstrating compliance with the requirements as documented within this report.

Audix Technology Corp. does not assume responsibility for any conclusions and generalizations drawn from the test results with regard to other specimens and samples.

Date of Report: 2022. 03. 31

Reviewed by:

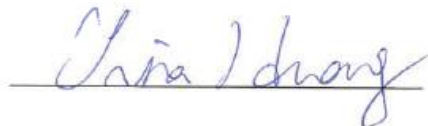

(Tina Huang/Section Manager)

Approved by:



(Johnny Hsueh/Section Manager)

1. REVISION RECORD OF TEST REPORT

Edition No	Issued Date	Revision Summary	Report Number
0	2022. 03. 31	Original Report	EM-F220101

2. SUMMARY OF TEST RESULTS

FCC Part Section(s)	Description	Results
15.207	Conducted Emission	PASS
15.205/15.209 15.407 (b)(6)	Radiated Band Edge and Radiated Spurious Emission	PASS
15.407(a)(8)	Maximum Power Spectral Density	PASS
15.407(a)(8)	Maximum Conducted Output Power	PASS
2.1049 15.407(a)(10)	Emission/Occupied Bandwidth	PASS
15.407(b)(6)	Undesirable emission limits: Spurious Emission (Conducted)	PASS
15.407(b)(7)	In-Band Emission (Channel Mask)	PASS
15.407(d)(6)	Contention Based Protocol	PASS
15.203	Antenna Requirement	PASS
Note: The uncertainties value is not used in determining the result.		

3. GENERAL INFORMATION

3.1. Description of Application

Applicant	LG Electronics Inc. 222, LG-ro, Jinwi-myeon Pyeongtaek-Si, Gyeonggi-Do, 17709 Republic of Korea
Manufacturer	LG Electronics Inc. 222, LG-ro, Jinwi-myeon Pyeongtaek-Si, Gyeonggi-Do, 17709 Republic of Korea
Factory	LG Electronics Nanjing New Technology Co., Ltd. No.346, Yaoxin Road, Economic & Technical Development Zone, Nanjing, China.
Product	Notebook Computer
Model	(1)17Z90Q (2)17ZB90Q (3)17ZD90Q (4)17ZG90Q The difference between all models is different in the sales customers.
Brand	LG

3.2. Description of EUT

Test Model	17Z90Q	
Serial Number	N/A	
Power Rating	DC 20V, 3.25A	
Software Version	XY (X, Y can be 0 to 9 for different SW version not influence RF parameter)	
RF Features	WLAN:802.11 a/b/g/n/ac/ax Bluetooth: BT and BLE (BT 5.1)	
Transmit Type	2.4 GHz	
	802.11b	1T1R
	802.11g	1T1R
	802.11n-HT20	2T2R
	802.11n-HT40	2T2R
	802.11ax-HE20	2T2R
	802.11ax-HE40	2T2R
	BT/BLE	1T1R
	U-NII Bands	
	802.11a	1T1R
	802.11n-HT20/802.11ac-VHT20/802.11ax-HE20	2T2R
	802.11n-HT40/802.11ac-VHT40/802.11ax-HE40	2T2R
	802.11ac-VHT80/802.11ax-HE80	2T2R
	802.11ac-VHT160/802.11ax-HE160	2T2R
	The MIMO is uncorrelated and supported SDM(Spatial Division Multiplexing) mode only. This radio device doesn't support beamforming and Cyclic Delay Diversity (CDD).	
Device Category	<input type="checkbox"/> Outdoor Access Point <input type="checkbox"/> Fixed point-to-point Access Point <input type="checkbox"/> Indoor Access Point <input checked="" type="checkbox"/> Mobile and Portable client device	
Test Sample	Sample No.	Test Item
	03	AC Conduction, Radiated, RF Conducted
	04	
	Firmware	N/A
Sample Status	Trial sample	
Date of Receipt	2022. 01. 14	
Date of Test	2022. 01. 21 ~ 03. 31	

Interface Ports of EUT	<ul style="list-style-type: none">• One Micro SD Card Slot• Two USB 3.0 Ports• One HDMI Port• Two USB Type C Port• One Earphone Port
Accessories Supplied	<ul style="list-style-type: none">• AC Adapter• LAN Gender

3.3. Reference Test Guidance

ANSI C63.10:2013

KDB 789033 D02 v02r01, KDB 662911 D01 v02r01, KDB 987594 D02 v01r01

3.4. Antenna Information

No.	Antenna Part Number	Manufacture	Antenna Type	Frequency (MHz)	Max Gain(dBi)	
					Main	AUX
1.	WA-P-LELE-04-011	INPAQ	Mono-Pole	2400	2.2	1.1
				2450	3.0	1.6
				2500	2.7	1.5
				5150	4.1	3.8
				5400	4.0	3.7
				5850	3.7	3.3
				5925	3.5	3.2
				6525	2.7	2.5
				7125	2.5	2.1
<p>According to KDB 662911 D01 d) ii), transmit signals are completely uncorrelated, then Directional gain = $10 \log[(10^{G1/10} + 10^{G2/10} + \dots + 10^{GN/10})/N_{ANT}]$ dBi Note 1. 2.4G: Directional gain = $10 \log[(10^{3.0/10} + 10^{1.6/10})/2] = 2.36$dBi Note 2. UNII Band (WLAN 5G): Directional gain = $10 \log[(10^{4.1/10} + 10^{3.8/10})/2] = 3.95$dBi Note 3. UNII Band (WLAN 6G): 5925MHz: Directional gain = $10 \log[(10^{3.5/10} + 10^{3.2/10})/2] = 3.35$dBi 6525MHz: Directional gain = $10 \log[(10^{2.7/10} + 10^{2.5/10})/2] = 2.60$dBi 7125MHz: Directional gain = $10 \log[(10^{2.5/10} + 10^{2.1/10})/2] = 2.30$dBi</p>						
2.	L1LRF009-CS-H	LUXSHARE-ICT	Mono-Pole	2400	-1.45	2.89
				2450	0.26	-0.07
				2500	2.15	-6.91
				5150	5.24	3.64
				5400	0.55	1.11
				5850	4.96	2.88
				5925	5.85	2.48
				6525	1.19	1.38
				7125	3.99	1.89
<p>According to KDB 662911 D01 d) ii), transmit signals are completely uncorrelated, then Directional gain = $10 \log[(10^{G1/10} + 10^{G2/10} + \dots + 10^{GN/10})/N_{ANT}]$ dBi Note 1. 2.4G: Directional gain = $10 \log[(10^{2.15/10} + 10^{2.89/10})/2] = 2.54$dBi Note 2. UNII Band (WLAN 5G): Directional gain = $10 \log[(10^{5.24/10} + 10^{3.64/10})/2] = 4.51$dBi Note 3. UNII Band (WLAN 6G): 5925MHz: Directional gain = $10 \log[(10^{5.85/10} + 10^{2.48/10})/2] = 4.48$dBi 6925MHz: Directional gain = $10 \log[(10^{1.19/10} + 10^{1.38/10})/2] = 1.29$dBi 7125MHz: Directional gain = $10 \log[(10^{3.99/10} + 10^{1.89/10})/2] = 3.07$dBi</p>						

3.5. EUT Specifications Assessed in Current Report

Mode	U-NII Band	Fundamental Range (MHz)	Channel Number
802.11ax-HE20	5	5955-6415	24
	6	6435-6515	5
	7	6535-6855	17
	8	6875-7115	13
802.11ax-HE40	5	5965-6405	12
	6	6445-6485	2
	7	6525-6845	9
	8	6885-7085	6
802.11ax-HE80	5	5985-6385	6
	6	6465-6545	2
	7	6625-6785	3
	8	6865-7025	3
802.11ax-HE160	5	6025-6345	3
	6	6505	1
	7	6665	1
	8	6825-6985	2

Mode	Modulation	Data Rate (Mbps)
802.11ax-HE20	OFDMA (BPSK/ QPSK/ 16QAM/ 64QAM/ 256QAM/1024QAM)	Up to 287
802.11ax-HE40		Up to 574
802.11ax-HE80		Up to 1201
802.11ax-HE160		Up to 2402

Channel List								
802.11ax-HE20								
U-NII Band	Channel Number	Freq. (MHz)	U-NII Band	Channel Number	Freq. (MHz)	U-NII Band	Channel Number	Freq. (MHz)
5	2	5955	5	81	6335	7	161	6755
	5	5975		85	6375		165	6775
	9	5995		89	6395		169	6795
	13	6015		93	6415		173	6815
	17	6035		97	6435		177	6835
	21	6055	6	101	6455	181	6855	
	25	6075		105	6475	185	6875	
	29	6095		109	6495	189	6895	
	33	6115		113	6515	193	6915	
	37	6135		117	6535	197	6935	
	41	6155	7	121	6555	201	6955	
	45	6175		125	6575	205	6975	
	49	6195		129	6595	209	6995	
	53	6215		133	6615	213	7015	
	57	6235		137	6635	217	7035	
	61	6255		141	6655	221	7055	
	65	6275		145	6675	225	7075	
	69	6295		149	6695	229	7095	
	73	6315		153	6715	233	7115	
	77	6335		157	6735			

Channel List								
802.11ax-HE40								
U-NII Band	Channel Number	Freq. (MHz)	U-NII Band	Channel Number	Freq. (MHz)	U-NII Band	Channel Number	Freq. (MHz)
5	3	5965	5	83	6365	7	163	6765
	11	6005		91	6405		171	6805
	19	6045		99	6445		179	6845
	27	6085	6	107	6485	8	187	6885
	35	6125		115	6525		195	6925
	43	6165	7	123	6565		203	6965
	51	6205		131	6505		211	7005
	59	6245		139	6645		219	7045
	67	6285		147	6685		227	7085
	75	6325		155	6725			

Channel List								
802.11ax-HE80								
U-NII Band	Channel Number	Freq. (MHz)	U-NII Band	Channel Number	Freq. (MHz)	U-NII Band	Channel Number	Freq. (MHz)
5	7	5985	5	87	6385	7	167	6785
	23	6065	6	103	6465	8	183	6865
	39	6145		119	6545		199	6945
	55	6225	7	135	6625		215	7025
	71	6305		151	6705			

Channel List					
802.11ax-HE160					
U-NII Band	Channel Number	Frequency (MHz)	U-NII Band	Channel Number	Frequency (MHz)
5	15	6025	7	143	6665
	47	6185	8	175	6825
	79	6345		207	6985
6	111	6505			

Note: Test modes are presented at section 3.6.

3.6. Description of Key Components

3.6.1. For the All Component Lists

Item	Supplier	Model / Type	Character
System	Microsoft	Win11 Home	---
Main Board	LG	Queen MAIN B/D PCB	Main Board (GM) Manufacturer: #1 Hannstar Board Tech(Jiang Yin) Corp.,Ltd. #2 Elec & Eltek Company (MCO) Limited.
WLAN SUB Board	LG	17Z90Q Sub B/D	Manufacturer: #1 Hannstar Board Tech(Jiang Yin) Corp.,Ltd. #2 Elec & Eltek Company (MCO) Limited. #3 JiangSu HuaShen Electronic co.,ltd (HXF)
CPU (Socket: BGA1744)	Intel	i7-1260P	2.5GHz
	Intel	i5-1240P	2.1GHz
17" LCD Panel	LG Display	LP170WQ1(SP)(F2)	Resolution: 2560 x 1600, 60Hz WQXGAIPS (Non Touch)
Storage (SSD)	SK hynix	HFM001TD3JX013N	1TB
		HFM512GD3JX013N	512GB
		HFM256GD3JX013N	256GB
	Samsung	MZ-VL21T00	1TB
		MZ-VL25120	512GB
		MZ-VL22560	256GB
Memory (RAM)	Samsung	---	16GB LPDDR5x(On Board)
		---	8GB LPDDR5x(On Board)
	SK Hynix	---	16GB LPDDR5x(On Board)
		---	8GB LPDDR5x(On Board)
Battery Pack	LG	LBV7227E	80Wh, DC 7.74V, 80Wh Typ 10336mAh
	LG	LBY122CM	90Wh, DC 7.76V, 90Wh Typ 11600mAh
WLAN Combo Card	Intel	AX211D2W	WLAN and BT, 2x2 PCIe M.2 1216 SD adapter card FCC ID: PD9AX211D2 IC: 1000M-AX211D2
WLAN Combo Antenna	LG (INPAQ)	WA-P-LELE-04-011	PCB, Mono-pole Type Main: Black, Aux: Gray
	LG (LUXSHARE-ICT)	L1LRF009-CS-H	PCB, Mono-pole Type Main: Black, Aux: Gray
Keyboard	TIC	KT0120B8E	---
	LITE ON	SN8101	---
Web Camera	Chicony	CKFLF26	---
	Luxvisions	1BF225N3	---

Item	Supplier	Model / Type	Character	
LAN Gender (Type C to LAN)	SUZHOU MEC ELECTRONICS	80-5946-111	(White) 10/100 Megabit Ethernet	
		80-5946-101	(Black) 10/100 Megabit Ethernet	
		80-5946-230	(White) 10/100/1000 Megabit Ethernet	
		80-5946-240	(Black) 10/100/1000 Megabit Ethernet	
	Type C to LAN: Shielded, Undetached, 0.12m			
	ARIN TECH CO. LTD	GD-08MF-36-WH-LP10	(White) 10/100 Megabit Ethernet	
		GD-08MF-36-BK-LP11	(Black) 10/100 Megabit Ethernet	
		GD-08MF-50-WH-LP12	(White) 10/100/1000 Megabit Ethernet	
		GD-08MF-50-BK-LP13	(Black) 10/100/1000 Megabit Ethernet	
	Type C to LAN: Shielded, Undetached, 0.12m			
AC Adapter (65W)	LG (HONOR)	ADT-65DSU-D03-2	I/P: AC 100-240V, 1.6A, 50-60Hz O/P: DC 20V, 3.25A	
	DC Power Cord: Non-Shielded, Undetached, 1.5m			
	AC Power Cord: Non-Shielded, Detached, 1.0m (2C) (For Other Countries) AC Power Cord: Non-Shielded, Detached, 1.55m (2C) (For US, Canada, Mexico)			

Remark: For more detailed features description, please refer to the manufacturer's specifications or the user manual.

3.6.2. The EUT collocates with following worst components, which are used to establish a basic configuration of system during test:

SKU (Mode)		1	2	
Main Board	LG, Blanc MAIN B/D PCB	V	V	
SUB Board	LG, 17Z90Q Sub B/D (Type A)	V	V	
CPU	Intel, i7-1260P	V	V	
17" LCD Panel	LG Display, LP170WQ1(SP)(F2)	V	V	
Storage (SSD)	Samsung, 1TB	V	V	
	SK hynix, 1TB	V	V	
Memory (RAM)	16GB	V	V	
Battery Pack	LG, 90Wh	V	V	
Keyboard	TIC, KT0120B8E	V	V	
Web Camera	Chicony, CKFLF26	V	V	
WLAN Combo Card	Intel, AX211D2W	V	V	
WLAN Combo Antenna	LG (INPAQ), WA-P-LELE-04-011	V		
	LG (LUXSHARE-ICT), L1LRF009-CS-H		V	
Type C #1	AC Adapter	LG (HONOR), ADT-65DSU-D03-2	V	V
Type C #2	Link to LAN Gender	MEC	V	V

3.7. Test Configuration

Mode	TX _{on} (ms)	1/ TX _{on} (kHz)	TX _{on+off} (ms)	Duty Cycle (x)	Duty Cycle Factor [10log(1/x)] (dB)
802.11ax-HE20	3.940	0.254	4.000	0.985	N/A
802.11ax-HE40	3.940	0.254	4.000	0.985	N/A
802.11ax-HE80	3.960	0.253	4.020	0.985	N/A
802.11ax-HE160	2.280	0.439	2.320	0.983	N/A

Note: When duty cycle is less than 98% (0.98) that duty cycle factor 10log(1/x) is needed to add in conducted test items measured in average detector.

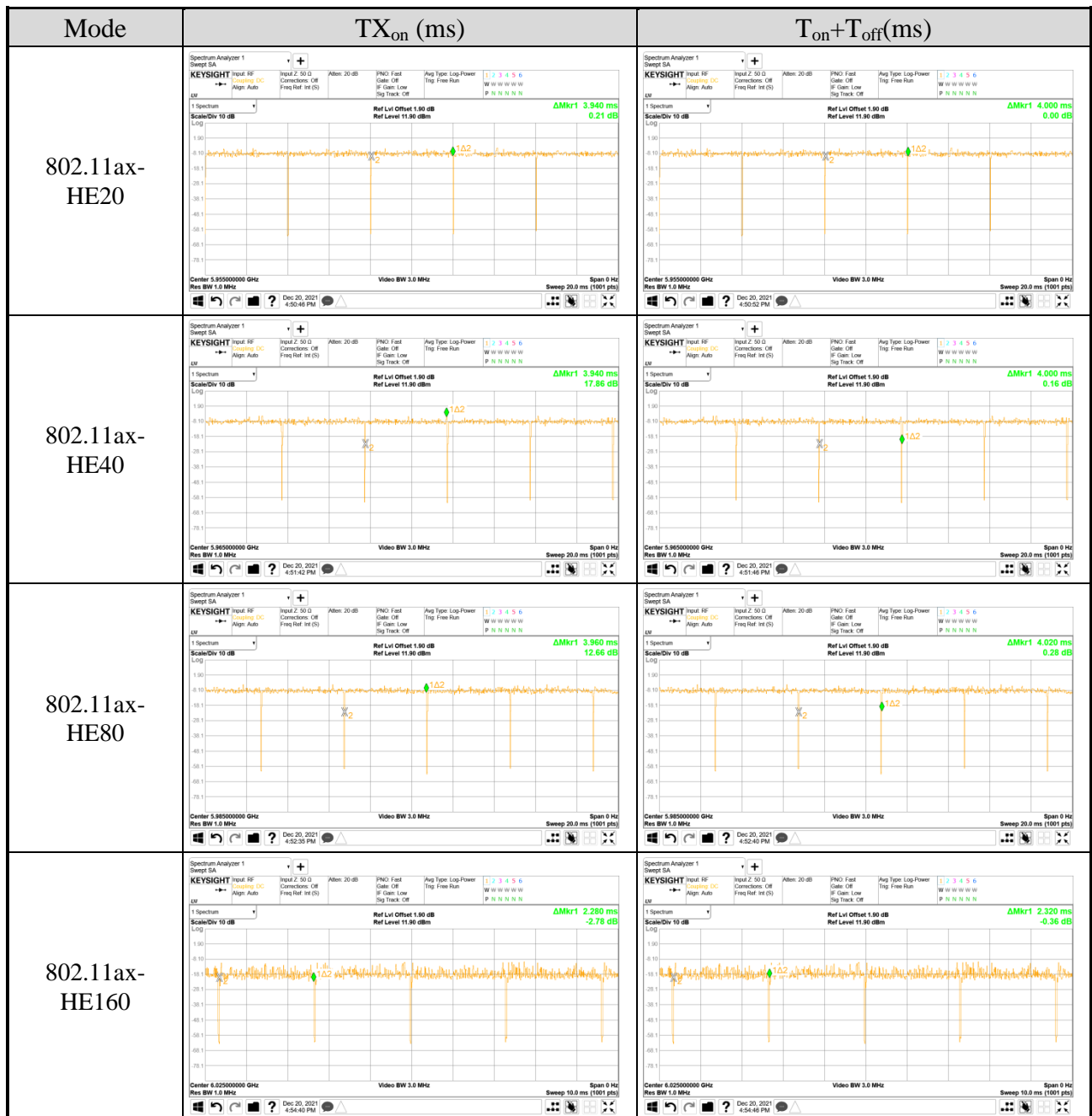

AC Conduction	
SKU #1	Normal operation (with INPAQ Antenna)
SKU #2	Normal operation (with LUXSHARE-ICT Antenna)

Item		Mode	Data Rate	Test Channel	
Radiated Test Case	SKU #1	Radiated Spurious Emission (30MHz~1GHz)	802.11ax-HE160	HE0	47
	SKU #2		802.11ax-HE160	HE0	47

● OFDM Modulation

Item		Mode	Data Rate	Test Channel	
Radiated Test Case	SKU #1/ SKU #2	Radiated Spurious Emission (Above 1GHz) ^{Note 3}	802.11ax-HE20	HE0	2/97/181/185
			802.11ax-HE40	HE0	3/99/179/227
			802.11ax-HE80	HE0	39/103/167/199
			802.11ax-HE160	HE0	47/111/175/207
	SKU #2	Band Edge	802.11ax-HE20	HE0	2
			802.11ax-HE40	HE0	3/227
			802.11ax-HE80	HE0	7/215
			802.11ax-HE160	HE0	15/207
	Band Edge-Marker Delta	802.11ax-HE20	HE0	233	

Item		Mode	Data Rate	Test Channel
Conducted Test Case	Maximum Power Spectral Density/ Maximum Conducted Output power/ Emission/Occupied Bandwidth	802.11ax-HE20	HE0	2/45/93/97/105/13/117/149/181/185/209/233
		802.11ax-HE40	HE0	3/43/91/99/107/15/147/179/187/211/227
		802.11ax-HE80	HE0	7/39/87/103/119/135/151/16/183/199/215
		802.11ax-HE160	HE0	15/47/79/111/143/175/207
	Band Edge	802.11ax-HE20	HE0	2/233
		802.11ax-HE40	HE0	3/227
		802.11ax-HE80	HE0	7/215
		802.11ax-HE160	HE0	15/207
	Spurious Emission	802.11ax-HE20	HE0	2/97/181/185
		802.11ax-HE40	HE0	3/99/179/227
		802.11ax-HE80	HE0	39/103/167/199
		802.11ax-HE160	HE0	47/111/175/207

Item		Mode	Data Rate	Test Channel
Conducted Test Case	In-Band Emission (Channel Mask)	802.11a	6Mbps	2/45/93/97/105/ 113/117/149/181 /185/209/233
		802.11n-HT20	MCS8	
		802.11ax-HH20	HE0	
		802.11n-HT40	MCS8	3/43/91/99/107/1 15/147/179/187/ 211/227
		802.11ax-HE40	HE0	
		802.11ac-VHT80	MCS0	7/39/87/103/119/ 135/151/16/183/ 199/215
		802.11ax-HE80	HE0	
		802.11ac-VHT160	MCS0	15/47/79/111/14 3/175/207
	Contention Based Protocol	802.11ax-HE20	HE0	45/105/149/209
		802.11ax-HE160	HE0	47/111/143/207

● OFDMA Modulation ^{Note 6}

Item		Tones	RU Index	Mode	Data Rate	Test Channel	
Radiated Test Case	SKU #2	Radiated Spurious Emission (Above 1GHz) ^{Note 3}	26T	4	802.11ax-HE20	HE0	2
			52T	44	802.11ax-HE80	HE0	7
			106T	53	802.11ax-HE20	HE0	2
			242T	62	802.11ax-HE160	HE0	47
			484T	S66	802.11ax-HE160	HE0	47
			996T	67	802.11ax-HE80	HE0	7
		Band Edge	26T	0	802.11ax-HE20	HE0	2
				37	802.11ax-HE40	HE0	3
			52T	44	802.11ax-HE40	HE0	227
				53	802.11ax-HE20	HE0	2
			106T	56	802.11ax-HE40	HE0	227
				61	802.11ax-HE160	HE0	15
			242T	62	802.11ax-HE40	HE0	227
				65	802.11ax-HE40	HE0	3
			484T	S66	802.11ax-HE160	HE0	207
				67	802.11ax-HE80	HE0	7
		996T	S67	802.11ax-HE160	HE0	207	
			Band Edge-Marker Delta	26T	8	802.11ax-HE20	HE0

Item		Tones	RU Index	Mode	Data Rate	Test Channel
Conducted Test Case	Maximum Power Spectral Density	26T	4	802.11ax-HE20	HE0	2
		52T	44	802.11ax-HE80	HE0	7
		106T	53	802.11ax-HE20	HE0	2
		242T	62	802.11ax-HE160	HE0	47
		484T	S66	802.11ax-HE160	HE0	47
		996T	67	802.11ax-HE80	HE0	7

Item		Tones	RU Index	Mode	Data Rate	Test Channel	
Conducted Test Case	Band Edge	26T	0	802.11ax-HE20	HE0	2	
			8			233	
		52T	37	802.11ax-HE40	HE0	3	
			14			227	
		106T	53	802.11ax-HE20	HE0	2	
			56	802.11ax-HE40	HE0	227	
		242T	61	802.11ax-HE160	HE0	15	
			62	802.11ax-HE40	HE0	227	
		484T	65	802.11ax-HE40	HE0	3	
			S66	802.11ax-HE160	HE0	207	
		996T	67	802.11ax-HE80	HE0	7	
			S67	802.11ax-HE160	HE0	207	
		Spurious Emission	26T	4	802.11ax-HE20	HE0	2
			52T	44	802.11ax-HE80	HE0	7
	106T		53	802.11ax-HE20	HE0	2	
	242T		62	802.11ax-HE160	HE0	47	
	484T		S66	802.11ax-HE160	HE0	47	
	996T		67	802.11ax-HE80	HE0	7	
	Maximum Conducted Output power	26T	0/4/8	802.11ax-HE20	HE0	2/45/93/97/105/ 113/117/149/ 181/185/209/ 233	
			52T				37/39/40
			106T				53/54
			242T				61
		52T	0/8/17	802.11ax-HE40	HE0	3/43/91/99/107/ 115/147/179/ 187/211/227	
			52T				37/40/44
			106T				53/54/56
			242T				61/62
		106T	0/18/36	802.11ax-HE80	HE0	7/39/87/103/119 /135/151/16/183 /199/215	
			52T				37/44/52
			106T				53/56/60
			242T				61/62/64
484T		0/18/36	802.11ax-HE160	HE0	15/47/79/111/ 143/175/207		
		S0/S18/S36					
		52T				37/44/52 S37/S44/S52	
		106T				53/56/60 S53/S56/S60	
		242T				61/62/64 S61/S62/S64	
		484T				65/66 S65/S66	
996T	65/S67						

Note 1: Mobile Device

Portable Device, and 3 axis were assessed. The worst scenario for Radiated Spurious Emission as follow: Lie Side Stand

Note 2: Low, mid, and high channels were measured, only the worst channel of each modulation was presented in this report.

Note 3: Both of the antennas are the same type, and we presented the worst case in the report. The max-gain condition MIMO is SKU #2 for U-NII Band 5 (5955~6175MHz)/UNII Band 7 (6845-6885MHz)/Band 8 and SKU #1 for U-NII Band 5 (6345~6415MHz)/Band 6/Band 7(6535-6695MHz). The MIMO is uncorrelated and supported SDM mode only.

Note 4: The modulation and bandwidth are similar for 802.11n mode for HT20/HT40 and 802.11ac mode for VHT20/VHT40, therefore investigated worst case to representative mode in the test report.

Note 5: The data rates were selected based on preliminary testing that identified rate as the worst case for output power.

Note 6: After preliminary test, we present worst case with maximum power of each RU type.

3.8. Output Power Setting

Mode	U-NII Band	Centre Frequency (MHz)	Power Setting		Mode	U-NII Band	Centre Frequency (MHz)	Power Setting	
			Chain A (AUX)	Chain B (Main)				Chain A (AUX)	Chain B (Main)
802.11ax-HE20	5	5955	1.500	1.500	802.11ax-HE20	7	6535	0.750	0.750
		6175	1.500	1.500			6695	0.750	0.750
		6415	1.500	1.500			6855	0.750	0.750
	6	6435	1.500	1.500		8	6875	0.750	0.750
		6475	1.500	1.500			6995	0.750	0.750
		6515	1.500	1.500			7115	-3.000	-3.000

Mode	U-NII Band	Centre Frequency (MHz)	Power Setting		Mode	U-NII Band	Centre Frequency (MHz)	Power Setting	
			Chain A (AUX)	Chain B (Main)				Chain A (AUX)	Chain B (Main)
802.11ax-HE40	5	5965	4.750	4.750	802.11ax-HE0	7	6525	4.750	4.750
		6165	4.750	4.750			6685	4.000	4.000
		6405	4.750	4.750			6845	4.000	4.000
	6	6445	4.750	4.750		8	6885	4.000	4.000
		6485	4.750	4.750			7005	4.000	4.000
							7085	4.500	4.500

Mode	U-NII Band	Centre Frequency (MHz)	Power Setting		Mode	U-NII Band	Centre Frequency (MHz)	Power Setting	
			Chain A (AUX)	Chain B (Main)				Chain A (AUX)	Chain B (Main)
802.11ax-HE80	5	5985	7.250	7.250	802.11ax-HE80	7	6625	6.500	6.500
		6145	7.250	7.250			6705	6.500	6.500
		6385	7.25	7.250			6785	6.500	6.500
	6	6465	7.250	7.250		8	6865	6.500	6.500
		6545	7.250	7.250			6945	6.500	6.500
							7025	6.500	6.500

Mode	U-NII Band	Centre Frequency (MHz)	Power Setting		Mode	U-NII Band	Centre Frequency (MHz)	Power Setting	
			Chain A (AUX)	Chain B (Main)				Chain A (AUX)	Chain B (Main)
802.11ax-HE160	5	6025	10.000	10.000	802.11ax-HE160	7	6665	9.250	9.250
		6185	10.000	10.000			6825	9.250	9.250
		6345	10.000	10.000			8	6985	9.250
	6505	10.000	10.000						

3.9. Tested Supporting System List

3.9.1. Support Peripheral Unit

No.	Product	Brand	Model No.	Serial No.	Approval
1.	TV	LG	22LK330-DB	N/A	N/A
2.	USB Mouse	DENGEKI	P012 (MS-P12)	N/A	N/A
3.	Earphone	APPLE	N/A	N/A	N/A
4.	SD Card	ADATA	MicroSDHC Card	N/A	N/A
Partner System					
5.	Tri-Band WiFi 6E Router	NETGEAR	RAXE500	N/A	FCC ID: PY320300508
For Contention Based Protocol Test only					
6.	Wireless-AXE11000 Tri-band Gigabit Router	ASUS	GT-AXE1100	N/A	FCC ID: MSR-RTAXJF0

3.9.2. Cable Lists

No.	Cable Description Of The Above Support Units
1.	HDMI Cable: Shielded, Detachable, 1.2m AC Power Cord: Unshielded, Detachable, 1.8m
2.	USB Cable: Unshielded, Undetachable, 1.5m
3.	Earphone Cable: Unshielded, Undetachable, 1.2m
4.	N/A
5.	AC adapter: METGEAR, Model: 2ABS060K, Power Cable: Unshielded, Undetachable, 1.8m LAN cable: Unshielded, Detachable, 3.0m
6.	Adapter: AcBel, ADD011, DC Power cable: Non-shielded, 11.5m, Power Cable: Non-Shielded, 0.9m

3.10. Setup Configuration

3.10.1. EUT Configuration for Power Line & Radiated Emission

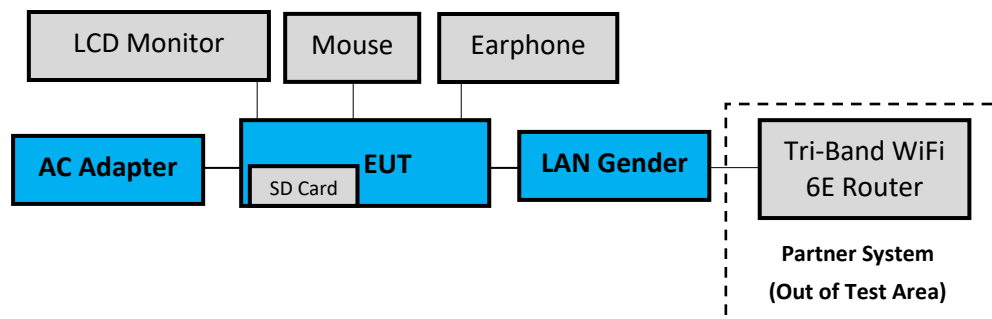

3.10.2. EUT Configuration for RF Conducted Test Items



3.11. Operating Condition of EUT

Test program “DRTU” is used for enabling EUT WLAN function under continues transmitting and choosing data rate/ channel.

[Chain 0 is aux port (A Button in DRTU) Chain 1 is main port (B Button in DRTU)].

3.12. Description of Test Facility

Name of Test Firm	Audix Technology Corporation / EMC Department No. 491, Zhongfu Rd., Linkou Dist., New Taipei City 244, Taiwan Tel: +886-2-26092133 Fax: +886-2-26099303 Website : www.audixtech.com Contact e-mail: attemc_report@audixtech.com
Accreditations	The laboratory is accredited by following organizations under ISO/IEC 17025:2017 (1) NVLAP(USA) NVLAP Lab Code 200077-0 (2) TAF(Taiwan) No. 1724
Test Facilities	FCC OET Designation Number under APEC MRA by NCC is : TW1724 ISED CAB Identifier Number under APEC TEL MRA by NCC is TW1724 (1) No.8 Shielded Room (2) No.1 3m Semi Anechoic Chamber

3.13.Measurement Uncertainty

Test Items/Facilities		Frequency Range	Uncertainty	
Conduction Test		9kHz-150kHz	±3.7dB	
		150kHz-30MHz	±3.4dB	
Radiation Test	<input checked="" type="checkbox"/>	No.1 3m Semi Anechoic Chamber	30MHz-200MHz, 3m, Horizontal	±3.8dB
			200MHz-1000MHz, 3m, Horizontal	±4.1dB
			30MHz-200MHz, 3m, Vertical	±4.5dB
			200MHz-1000MHz, 3m, Vertical	±4.5dB
			1GHz-6GHz, 3m	±4.7dB
			6GHz-18GHz, 3m	±4.1dB
			18GHz-40GHz, 3m	±3.52dB
	<input type="checkbox"/>	No.3 3m Semi Anechoic Chamber	30MHz-200MHz, 3m, Horizontal	±3.9dB
			200MHz-1000MHz, 3m, Horizontal	±4.2dB
			30MHz-200MHz, 3m, Vertical	±4.3dB
			200MHz-1000MHz, 3m, Vertical	±4.5dB
	<input type="checkbox"/>	No.4 3m Semi Anechoic Chamber	30MHz-200MHz, 3m, Horizontal	±4.1dB
			200MHz-1000MHz, 3m, Horizontal	±4.5dB
			30MHz-200MHz, 3m, Vertical	±4.4dB
			200MHz-1000MHz, 3m, Vertical	±4.8dB
			1GHz-6GHz, 3m	±5.0dB
			6GHz-18GHz, 3m	±4.7dB
	<input type="checkbox"/>	No.5 3m Semi Anechoic Chamber	30MHz-200MHz, 3m, Horizontal	±4.2dB
			200MHz-1000MHz, 3m, Horizontal	±4.3dB
			30MHz-200MHz, 3m, Vertical	±4.3dB
			200MHz-1000MHz, 3m, Vertical	±4.7dB
			1GHz-6GHz, 3m	±4.8dB
			6GHz-18GHz, 3m	±4.5dB

Remark : Uncertainty = $ku_c(y)$

Test Items	Uncertainty
Maximum Power Spectral Density	± 0.52dB
Maximum Conducted Output Power	± 0.72dB
Emission Bandwidth	± 0.38%
Contention Based Protocol	± 2%

4. MEASUREMENT EQUIPMENT LIST

4.1. Conducted Emission Measurement

Item	Type	Manufacturer	Model No.	Serial No.	Cal. Date	Cal. Interval
1.	Test Receiver	R&S	ESR3	101774	2022. 01. 11	1 Year
2.	A.M.N.	R&S	ENV432	101567	2021. 04. 21	1 Year
3.	L.I.S.N.	Kyoritsu	KNW-407	8-855-9	2021. 12. 19	1 Year
4.	Pulse Limiter	R&S	ESH3-Z2	100354	2021. 12. 13	1 Year
5.	Digital Thermo-Hygro Meter	iMax	HTC-1	No.8 S/R	2021. 04. 15	1 Year
6.	Coaxial Cable	Yeida	RG/58AU	CE-08	2021. 09. 13	1 Year
7.	Test Software	Audix	e3	V6.120619c	N.C.R.	N.C.R.

4.2. Radiated Emission Measurement

Item	Type	Manufacturer	Model No.	Serial No.	Cal. Date	Cal. Interval
1.	Spectrum Analyzer	Agilent	N9010A-526	MY53400071	2021. 09. 19	1 Year
2.	Spectrum Analyzer	Keysight	N9010B-544	MY55460198	2021. 04. 14	1 Year
3.	Test Receiver	R&S	ESCI7	100746	2021. 12. 28	1 Year
4.	Amplifier	Sonoma	310N	187161	2021. 05. 27	1 Year
5.	Microwave Preamplifier	Keysight	83017A	MY53270365	2021. 05. 27	1 Year
6.	Microwave Amplifier	Keysight	83051A	MY53010042	2021. 07. 30	1 Year
7.	Microwave Preamplifier	Agilent	8449B	3008A02678	2022. 02. 22	1 Year
8.	Loop Antenna	ETS-LINDGREN	6512	00035867	2021. 09. 29	2 Years
9.	Bilog Antenna	TESEQ	CBL6112D	33821	2021. 07. 16	1 Year
10.	Double-Ridged Waveguide Horn	ETS-Lindgren	3115	9609-4927	2021. 07. 02	1 Year
11.	Double-Ridged Waveguide Horn	ETS-Lindgren	3115	9112-3775	2021. 05. 12	1 Year
12.	Double-Ridged Waveguide Horn	ETS-Lindgren	3117	00135902	2021. 03. 19	1 Year
13.	Horn Antenna	COM-POWER	AH-840	101092	2022. 01. 06	1 Year
14.	Notch Filter	Warison	WFIL-N5925-6425F	WR61CFWC4 B1	2022. 01. 14	1 Year
15.	Notch Filter	Warison	WFIL-N6425-6525F	WR61CFWC6 B1	2022. 01. 14	1 Year
16.	Notch Filter	Warison	WFIL-N6525-6875F	WR61CFWC8 B1	2022. 01. 14	1 Year
17.	Notch Filter	Warison	WFIL-N6875-7125F	WR61CFWC2 B1	2022. 01. 14	1 Year
18.	Coaxial Cable	MIYAZAKI	5D2W	RE-11	2022. 01. 20	1 Year
19.	Coaxial Cable	HUBER+SUHNER	SUCOFLEX 106	RE-14	2022. 01. 20	1 Year
20.	Coaxial Cable	HUBER+SUHNER	SUCOFLEX 102	RE-30	2021. 08. 25	1 Year
21.	Digital Thermo-Hygro Meter	iMax	HTC-1	No.1 3m A/C	2021. 04. 15	1 Year
22.	Test Software	Audix	e3	V6.120619c	N.C.R.	N.C.R.

4.3. RF Conducted Measurement

Item	Type	Manufacturer	Model No.	Serial No.	Cal. Date	Cal. Interval
1.	Spectrum Analyzer	Keysight	N9030B	MY61330403	2021. 12. 21	1 Year
2.	Power Meter	Anritsu	ML2487A	6K00005406	2021. 04. 28	1 Year
3.	Power Sensor	Anritsu	MA2491A	030873	2021. 04. 28	1 Year
4.	MXG RF Vector Signal Generator	Agilent	N5182B	MY53050409	2021. 02. 20	1 Year
					2022. 02. 15	1 Year
5.	Digital Thermo-Hygro Meter	iMax	HTC-1	RF-03	2021. 04. 15	1 Year

4.4. Contention Based Protocol Measurement

Item	Type	Manufacturer	Model No.	Serial No.	Cal. Date	Cal. Interval
1.	Spectrum Analyzer	Keysight	N9030B	MY61330403	2021. 12. 21	1 Year
2.	MXG RF Vector Signal Generator	Agilent	N5182B	MY53050409	2021. 02. 20	1 Year
3.	Frequency Extender	KEYSIGHT	N5182BX07	MY59362533	2021. 11.07	1 Year
4.	CBP Test Unit	KEYSIGHT	N/A	N/A	N.C.R.	N.C.R.
5.	Digital Thermo-Hygro Meter	iMax	HTC-1	RF-03	2021. 04. 15	1 Year

5. CONDUCTED EMISSION

5.1. Block Diagram of Test Setup

5.1.1. Block Diagram of EUT

Indicated as section 3.9

5.1.2. Shielded Room Setup Diagram

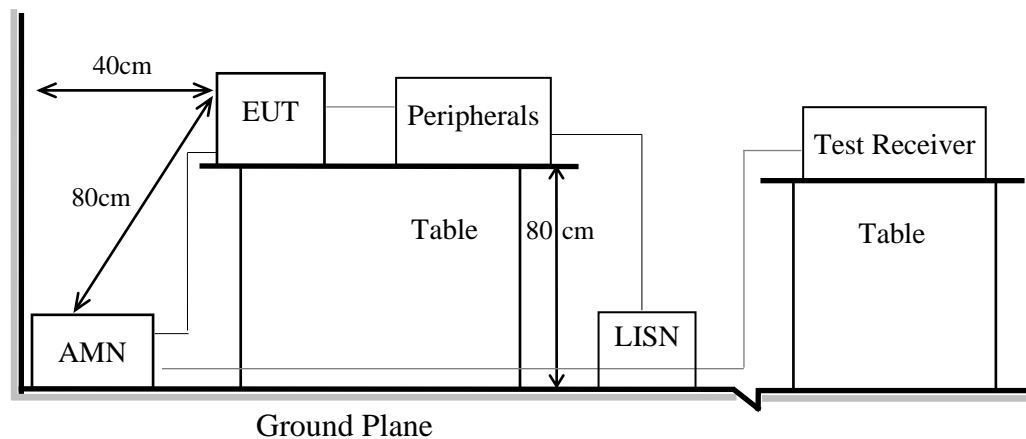

5.2. Conducted Emission Limit

Frequency	Conducted Limit	
	Quasi-Peak Level	Average Level
150kHz ~ 500kHz	66 ~ 56 dB μ V	56 ~ 46 dB μ V
500kHz ~ 5MHz	56 dB μ V	46 dB μ V
5MHz ~ 30MHz	60 dB μ V	50 dB μ V

Remark 1.: If the average limit is met when using a Quasi-Peak detector, the measurement using the average detector is not required.

2.: The lower limit applies to the band edges.

5.3. Test Procedure

- 5.3.1. To set up the EUT as indicated in ANSI C63.10. The EUT was placed on the table which has 80 cm height to the ground and 40 cm distance to the conducting wall.
- 5.3.2. Power supplier of the EUT was connected to the AC mains through an Artificial Mains Network (A.M.N.).
- 5.3.3. The AC power supplies to all peripheral devices must be provided through line impedance stabilization network (L.I.S.N.)
- 5.3.4. Checking frequency range from 150 kHz to 30 MHz and record the emission which does not have 20 dB below limit.

5.4. Test Results

Please refer to Appendix A.

6. RADIATED EMISSION

6.1. Block Diagram of Test Setup

6.1.1. Block Diagram of EUT

Indicated as section 3.9

6.1.2. Setup Diagram for 9kHz-30MHz

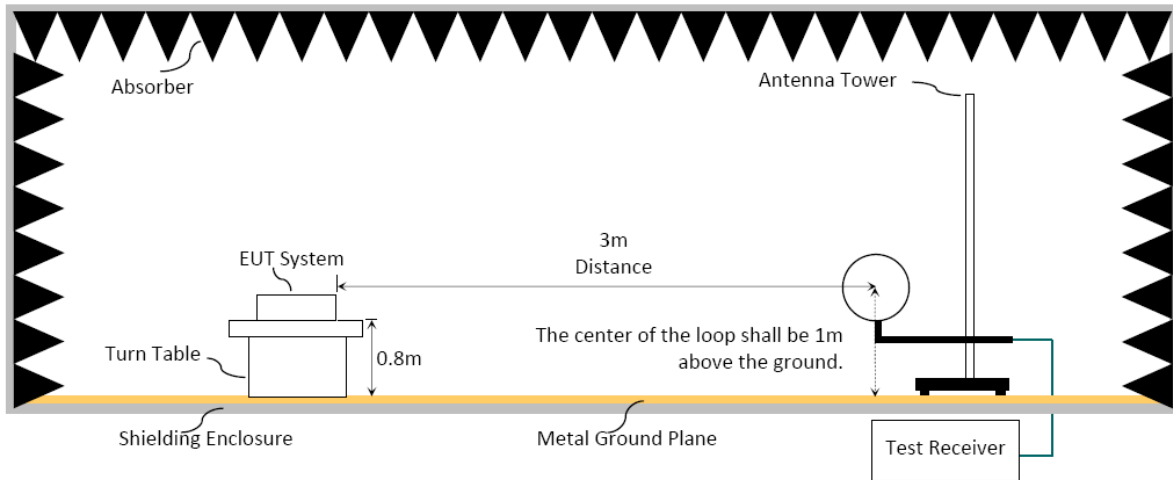

6.1.3. Setup Diagram for 30-1000MHz

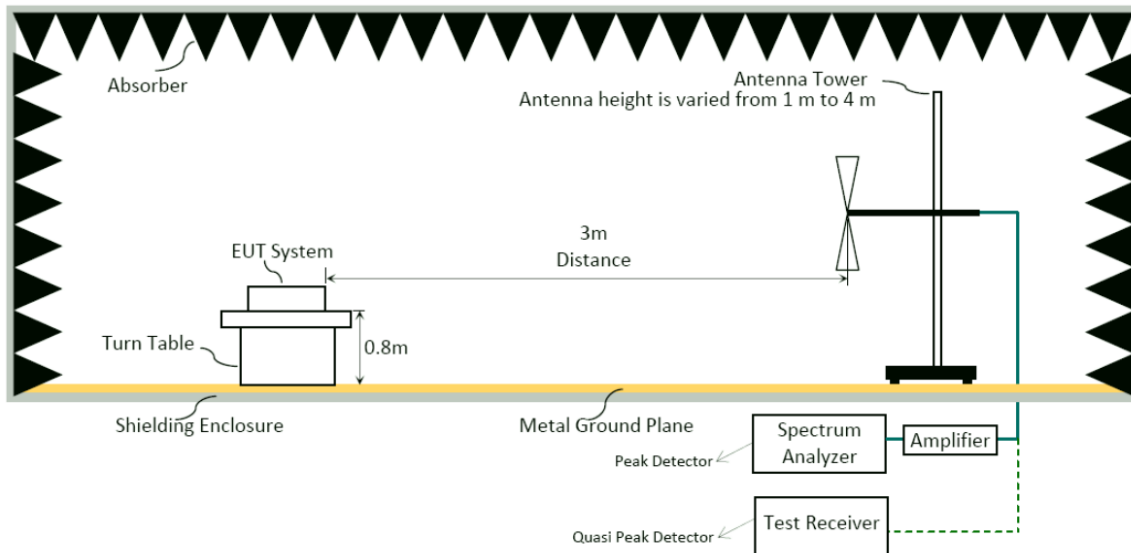

6.1.4. Setup Diagram for above 1GHz

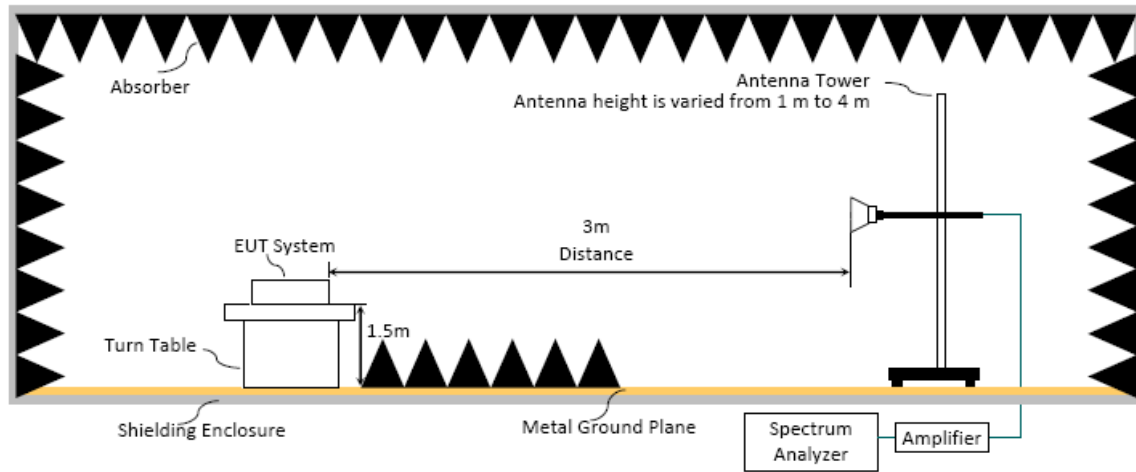

6.2. Radiated Emission Limits

Radiated emissions fall in restricted bands, as defined in FCC Section 15.205/RSS-Gen Section 8.10 table 7 must be in compliance with the radiated emission limits specified in FCC Section 15.209/RSS-Gen Section 8.9 table 6 as below.

6.2.1. General Limit

Frequency (MHz)	Distance(m)	Limits	
		dB μ V/m	μ V/m
0.009 - 0.490	300	67.6-20 log f(kHz)	2400/f kHz
0.490 - 1.705	30	87.6-20 log f(kHz)	24000/f kHz
1.705 - 30	30	29.5	30
30 - 88	3	40.0	100
88- 216	3	43.5	150
216- 960	3	46.0	200
Above 960	3	54.0	500
Above 1000	3	74.0 dB μ V/m (Peak) 54.0 dB μ V/m (Average)	

Remark : (1) dB μ V/m = 20 log (μ V/m)

- (2) The tighter limit applies to the edge between two frequency bands.
- (3) Distance refers to the distance in meters between the measuring instrument antenna and the closed point of any part of the device or system.
- (4) Fundamental and emission fall within operation band are exempted from this section.
- (5) Pursuant to ANSI C63.10: 6.6.4.3, if the maximized peak measured value complies with the average limit, then it is unnecessary to perform an average measurement.

6.2.2. Limit for non-restricted frequency above 1 GHz

Frequency Band (MHz)	E.I.R.P. Limit	Field Strength Limit at 3 m
Out of 5925 to 7125	-27 dBm/MHz	68.2 dB μ V/m

Note: Field Strength at 3 m= E.I.R.P. + 95.2 dB

6.3. Test Procedure

Frequency Range 9kHz~30MHz:

The EUT setup on the turntable which has 0.8 m height to the ground. The turn table rotated 360 degrees and antenna fixed to 1 m to find the maximum emission level. In order to find the maximum emission, all of the interface cables were manipulated according to ANSI C63.10-2013 regulation.

- (1) RBW = 9kHz with peak and average detector.
- (2) Detector: average and peak (9kHz-490kHz)
Q.P. (490kHz-30MHz)

Frequency Range 30MHz ~ 40GHz:

The EUT setup on the turn table which has 80cm (for 30-1000MHz) and 1.5m (for above 1GHz) height to the ground. The turn table rotated 360 degrees and antenna varied from 1 m to 4 m to find the maximum emission level. Both horizontal and vertical polarization are required. In order to find the maximum emission, all of the interface cables were manipulated according to ANSI C63.10-2013 regulation.

6.3.1. Radiated measurement Spectrum Analyzer Setting

6.3.1.1 Frequency below 1GHz:

Spectrum Analyzer is used for pre-testing with following setting:

- (1) RBW = 120kHz
- (2) VBW $\geq 3 \times$ RBW.
- (3) Detector = Peak.
- (4) Sweep time = auto.
- (5) Trace mode = max hold.
- (6) Allow sweeps to continue until the trace stabilizes.

Note 1: When peak-detected value is lower than limit that the measurement using the Q.P. detector is not required, otherwise using Q.P. for final measurement.

Note 2: When the radiated emissions limits are expressed in terms of the average value of the emissions, and pulsed operation is employed, the measurement field strength shall be determined by averaging over one complete pulse train, including blanking intervals, as long as the pulse train does not exceed 0.1 seconds.

6.3.1.2 Frequency above 1GHz to 10th harmonic (up to 40 GHz):

Peak Detector:

- (1) RBW = 1MHz
- (2) VBW $\geq 3 \times$ RBW.
- (3) Detector = Peak.
- (4) Sweep time = auto.
- (5) Trace mode = max hold.
- (6) Allow sweeps to continue until the trace stabilizes.

Note: When peak-detected value is lower than limit that the measurement using the average detector is not required, otherwise using average detector for final measurement.

Average Detector:

Option 1:

- (1) RBW = 1MHz
- (2) VBW \geq 1/ T.

Modulation Type	TX _{on} (ms)	1/ TX _{on} (kHz)	VBW Setting
802.11ax-HE20	3.940	0.254	10Hz
802.11ax-HE40	3.940	0.254	10Hz
802.11ax-HE80	3.960	0.253	10Hz
802.11ax-HE160	2.280	0.439	10Hz

N/A: 1/ TX_{on} is not implemented when duty cycle presented in section 3.6 is \geq 98%.

- (1) Detector = Peak.
- (2) Sweep time = auto.
- (3) Trace mode = max hold.
- (4) Allow sweeps to continue until the trace stabilizes.

Option 2:

Average Emission Level= Peak Emission Level+ D.C.C.F.

6.3.2. Radiated band edge measurement Spectrum Analyzer Setting

For without 99% OBW edge within 2 MHz of the authorized band edge:

The spectrum analyzer setting, please refer to section 6.3.1.2

For with 99% OBW edge within 2 MHz of the authorized band edge:

Per KDB 789033 Section G.3.d and ANSI C63.10 -2013 6.10.4, SA setting as below:

a. Fundamental field strength of SA setting:

The spectrum analyzer setting, please refer to section 6.3.1.2

b. Delta of SA setting:

- (1) RBW = 1% SPAN but no less than 30 KHz
 (In this case, RBW = 500 KHz)
- (2) VBW \geq 3 x RBW.
- (3) Detector = Peak.
- (4) Sweep time = auto.
- (5) Trace mode = max hold.
- (6) Allow sweeps to continue until the trace stabilizes.

Correction Factor(Via delta, dB)= Fundamental Emission Level(dB μ V/m)@RBW 500KHz- Band Edge Emission Level(dB μ V/m)@RBW 500kHz

Band Edge Emission Level (dB μ V/m) =
 Fundamental Emission Level (dB μ V/m)@RBW 1MHz – Marker Delta (dB)

6.4. Measurement Result Explanation

- Peak Emission Level (dB μ V/m) = Antenna Factor (dB/m) + Cable Loss (dB) + Meter Reading (dB μ V) (including Preamp factor if test used)
- Average Emission Level (dB μ V/m) = Antenna Factor (dB/m) + Cable Loss (dB) + Meter Reading (dB μ V) (including Preamp factor if test used)
- Average Emission Level (dB μ V/m) = Peak Emission Level (dB μ V/m) + DCCF (dB)
Duty Cycle Correction Factor (DCCF) = $20\log(TX_{on}/TX_{on+off})$ presented in section 3.6.
- ERP = Peak Emission Level (dB μ V/m) - 95.2dB - 2.14dB
- Band Edge Emission Level (dB μ V/m) = Fundamental Emission Level (dB μ V/m) - Maker-Delta (dB)

6.5. Test Results

Please refer to Appendix A.

7. MAXIMUM POWER SPECTRAL DENSITY

7.1. Block Diagram of Test Setup

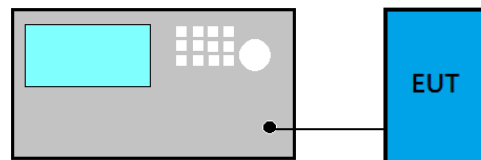

7.2. Specification Limits

For client devices operating under the control of an indoor access point in the 5.925-7.125 GHz bands, the maximum power spectral density must not exceed -1dBm e.i.r.p. in any 1-megahertz band

7.3. Test Procedure

Following measurement procedure is reference to KDB 789033 D02 General UNII Test Procedures New Rules v02r01:

■ Method AVGSA-2 (Spectrum channel power)

- (1) Set span to at least 1.5 times the OBW
- (2) Set RBW = 1 MHz
- (3) Set the video bandwidth (VBW) \geq 3 MHz.
- (4) Detector = RMS.
- (5) Trace mode = trace average at least 100 traces
- (6) Sweep = auto couple.
- (7) Use peak search function to find out the maximum power density.
- (8) Duty cycle factor is added when duty cycle presented in section 3.6 is $<$ 98%.

For power density emission measurements from multiple outputs of a transmitter or from multiple transmitters: Please refer to KDB 662911 E 2) c).

7.4. Test Results

Please refer to Appendix A

8. MAXIMUM CONDUCTED OUTPUT POWER

8.1. Block Diagram of Test Setup

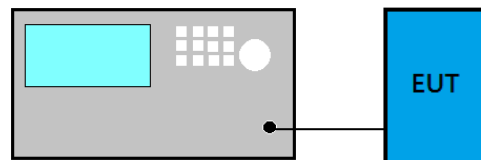

8.2. Specification Limits

For client devices operating under the control of an indoor access point in the 5.925-7.125 GHz bands, the maximum e.i.r.p. over the frequency band of operation must not exceed 24 dBm.

8.3. Test Procedure

Following measurement procedure is reference to KDB 789033 D02 General UNII Test Procedures New Rules v02r01:

■ **Method AVGPM (Measurement using an RF average power meter):**

EUT is connected to power sensor and record the maximum average output power and duty cycle factor is added when duty cycle presented in section 3.6 is < 98%.

■ **Method AVGSA-2 (Spectrum channel power) for 802.11ac-VHT80/160, 802.11ax-HE80/160 modes only**

- (1) Set span to at least 1.5 times the OBW
- (2) Set RBW = 1 MHz
- (3) Set the video bandwidth (VBW) \geq 3 MHz.
- (4) Detector = RMS.
- (5) Trace mode = trace average at least 100 traces
- (6) Sweep = auto couple.
- (7) Compute power by integrating the spectrum across the OBW of the signal using the instrument's band power measurement function with band limits set equal to the OBW band edges.
- (8) Duty cycle factor is added when duty cycle presented in section 3.7 is < 98%.

8.4. Test Results

Please refer to Appendix A

9. EMISSION/OCCUPIED BANDWIDTH

9.1. Block Diagram of Test Setup

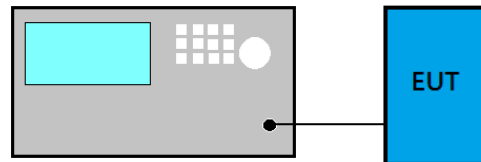

9.2. Specification Limits

The maximum transmitter channel bandwidth for U-NII devices in the 5.925-7.125 GHz band is 320 megahertz

9.3. Test Procedure

Following measurement procedure is reference to KDB 789033 D02 General UNII Test Procedures New Rules v02r01:

- (1) Set RBW = 1% of the emission bandwidth
- (2) Set VBW > RBW
- (3) Detector = Peak
- (4) Trace mode = max hold
- (5) Setting channel bandwidth function x dB to -26 dB to record the final bandwidth.

9.4. Test Results

Please refer to Appendix A

10. UNDERSIRABLE EMISSIONS LIMITS: SPURIOUS EMISSION (CONDUCTED)

10.1. Block Diagram of Test Setup

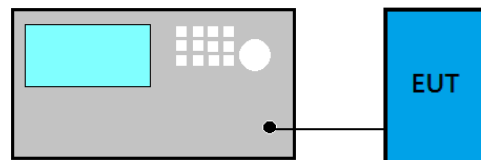

10.2. Spurious Emission Specification Limits

For transmitters operating within the 5.925-7.125 GHz band: Any emissions outside of the 5.925- 7.125 GHz band must not exceed an e.i.r.p. of -27 dBm/MHz.

Unless otherwise specified, on any frequency or frequencies above 1000 MHz, the radiated emission limits are based on the use of measurement instrumentation employing an average detector function. Unless otherwise specified, measurements above 1000 MHz shall be performed using a minimum resolution bandwidth of 1 MHz. When average radiated emission measurements are specified in this part, including average emission measurements below 1000 MHz, there also is a limit on the peak level of the radio frequency emissions. Unless otherwise specified, e.g., see FCC Part §§ 15.250, 15.252, 15.253(d), 15.255, 15.256, and 15.509 through 15.519, the limit on peak radio frequency emissions is 20 dB above the maximum permitted average emission limit applicable to the equipment under test. This peak limit applies to the total peak emission level radiated by the device, e.g., the total peak power level

10.3. Test Procedure

Please refer to KDB 789033 D02 v02r01 G5

For spurious emission measurements from multiple outputs of a transmitter or from multiple transmitters: Please refer to KDB 662911 E 3) a) (iii).

10.4. Test Results

Please refer to Appendix A

11. IN-BAND EMISSION (CHANNEL MASK)

11.1. Block Diagram of Test Setup

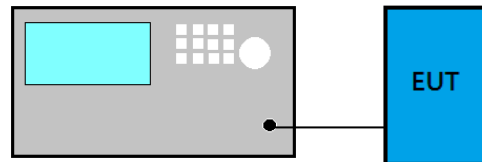

11.2. Specification Limits

For transmitters operating within the 5.925-7.125 GHz bands: Power spectral density must be suppressed by 20 dB at 1 MHz outside of channel edge, by 28 dB at one channel bandwidth from the channel center, and by 40 dB at one- and one-half times the channel bandwidth away from channel center. At frequencies between one megahertz outside an unlicensed device's channel edge and one channel bandwidth from the center of the channel, the limits must be linearly interpolated between 20 dB and 28 dB suppression, and at frequencies between one and one- and one-half times an unlicensed device's channel bandwidth, the limits must be linearly interpolated between 28 dB and 40 dB suppression. Emissions removed from the channel center by more than one- and one-half times the channel bandwidth must be suppressed by at least 40 dB.

11.3. Test Procedure

Following measurement procedure is reference to KDB 987594 D02 U-NII 6GHz EMC Measurement v01v01:

Measure the power spectral density (which will be used for emissions mask reference) using the following procedure:

- (a) Set the span to encompass the entire 26 dB EBW of the signal.
- (b) Set RBW = same RBW used for 26 dB EBW measurement.
- (c) Set VBW $\geq 3 \times$ RBW
- (d) Number of points in sweep $\geq (2 \times \text{span} / \text{RBW})$.
- (e) Sweep time = auto.
- (f) Detector = RMS (i.e., power averaging)
- (g) Trace average at least 100 traces in power averaging (rms) mode.
- (h) Use the peak search function on the instrument to find the peak of the spectrum.

- (1) Using the measuring equipment limit line function, develop the emissions mask based on the following requirements. The emissions power spectral density must be reduced below the peak power spectral density (in dB) as follows:
 - (a) Suppressed by 20 dB at 1 MHz outside of the channel edge.
 - (b) Suppressed by 28 dB at one channel bandwidth from the channel center.
 - (c) Suppressed by 40 dB at one- and one-half times the channel bandwidth from the channel center.
- (2) Adjust the span to encompass the entire mask as necessary.
- (3) Clear trace.
- (4) Trace average at least 100 traces in power averaging (rms) mode.
- (5) Adjust the reference level as necessary so that the crest of the channel touches the top of the emission mask.

11.4. Test Results

Please refer to Appendix A

12. CONTENTION BASED PROTOCOL

12.1. Block Diagram of Test Setup

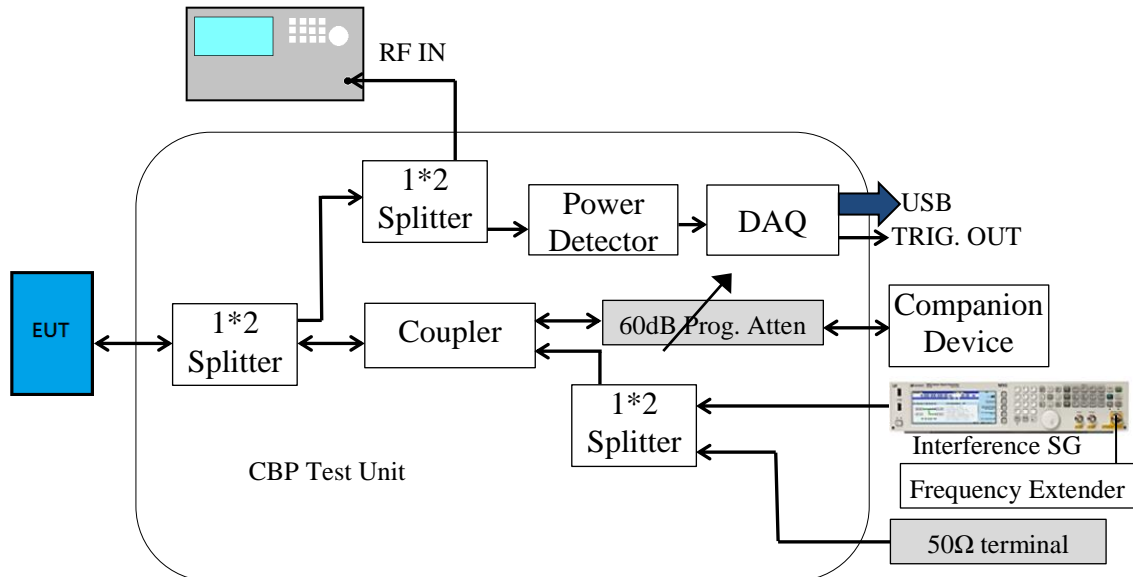

12.2. Specification Limits

Indoor access points, subordinate devices and client devices operating in the 5.925-7.125 GHz band must employ a contention-based protocol

FCC KDB 987594 D02 U-NII 6GHz EMC Measurement v01v01

Unlicensed low-power indoor devices must detect co-channel radio frequency power that is at least -62 dBm or lower. Upon detection of energy in the band, unlicensed low power indoor devices must vacate the channel (in which incumbent signal is transmitted) and stay off the incumbent channel as long as detected radio frequency power is equal to or greater than the threshold (-62 dBm). The -62 dBm (or lower) threshold is referenced to a 0 dBi antenna gain

To ensure incumbent operations are reliably detected in the band, low power indoor devices must detect RF energy throughout their intended operating channel. For example, an 802.11 device that plans to transmit a 40 MHz- wide signal (on a primary 20 MHz channel and a secondary 20 MHz channel) must detect energy throughout the entire 40 MHz channel. Additionally, low-power indoor devices must detect co-channel energy with 90% or greater certainty.

Table 1. Criteria to determine number of times detection threshold test may be performed

If	Number of Tests	Placement of Incumbent Transmission
$BW_{EUT} \leq BW_{Inc}$	One	Tune incumbent and EUT transmission ($f_{c1} = f_{c2}$)
$BW_{Inc} < BW_{EUT} \leq 2BW_{Inc}$	One	Incumbent transmission is contained within BW_{EUT}
$2BW_{Inc} < BW_{EUT} \leq 4BW_{Inc}$	Twice. Incumbent transmission is contained within BW_{EUT}	Incumbent transmission is located as closely as possible to the lower edge and upper edge, respectively, of the EUT channel
$BW_{EUT} > 4BW_{Inc}$	Three times	Incumbent transmission is located as closely as possible to the lower edge of the EUT channel, in the middle of EUT channel, and as closely as possible to the upper edge of the EUT channel

Where:

BW_{EUT} : Transmission bandwidth of EUT signal

BW_{Inc} : Transmission bandwidth of the simulated incumbent signal (10 MHz wide AWGN signal)

f_{c1} : Center frequency of EUT transmission

f_{c2} : Center frequency of simulated incumbent signal

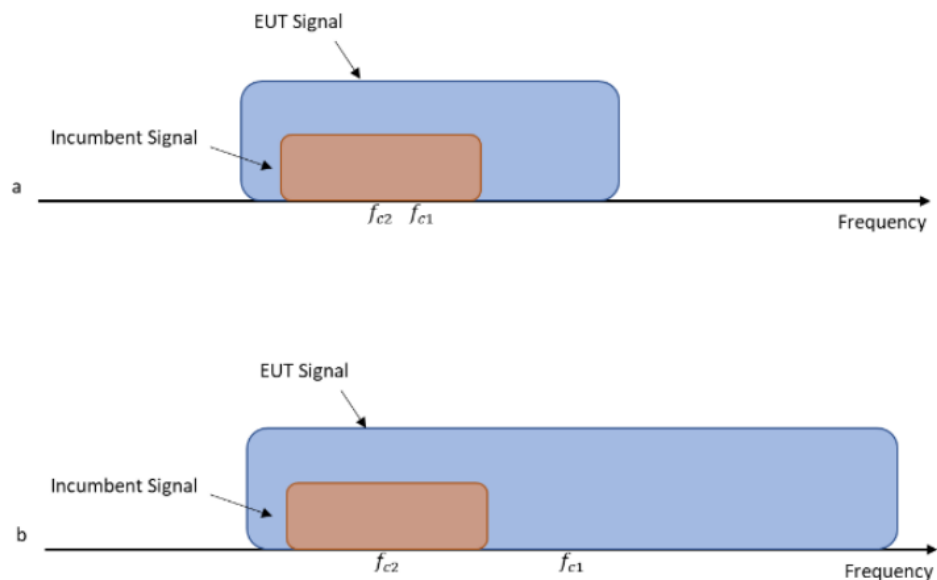

Figure 1. Two possible scenarios where a) center frequency of EUT transmission falls within incumbent's bandwidth, or b) outside of it

12.3. Test Procedure

Following measurement procedure is reference to KDB 987594 D02 U-NII 6GHz EMC Measurement v01v01:

- (1) To ensure EUT reliably detects an incumbent signal in both scenarios shown in Figure 1, the detection threshold test may be repeated more than once with the incumbent signal (having center frequency f_{c2}) tuned to different center frequencies within the UT transmission bandwidth. The criteria specified in Table 1 determines how many times the detection threshold test must be performed
- (2) Using an AWGN signal source, generate (but do not transmit, i.e., RF OFF) a 10 MHz-wide AWGN signal. Use Table 1 to determine the center frequency of the 10 MHz AWGN signal relative to the EUT's channel bandwidth and center frequency.
- (3) Monitor the signal analyzer to verify if the AWGN signal has been detected and the EUT has ceased transmission. If the EUT continues to transmit, then incrementally increase the AWGN signal power level until the EUT stops transmitting.
- (4) (Including all losses in the RF paths) Determine and record the AWGN signal power level (at the EUT's antenna port) at which the EUT ceased transmission. Repeat the procedure at least 10 times to verify the EUT can detect an AWGN signal with 90% (or better) level of certainty.
- (5) Refer to Table 1 to determine number of times the detection threshold testing needs to be repeated. If testing is required more than once, then go back to step 2, choose a different center frequency for the AWGN signal and repeat the process.
- (6) The test tool is "LAN test" to let the EUT to transmit with a constant duty cycle.

12.4. Test Results

Please refer to Appendix A



13. DEVIATION TO TEST SPECIFICATIONS

【NONE】



*Audix Technology Corp.
No. 491, Zhongfu Rd., Linkou Dist.,
New Taipei City 244, Taiwan*

*Tel: +886 2 26099301
Fax: +886 2 26099303*

APPDNDIX A

TEST DATA AND PLOTS

(Model: 17Z90Q)



Audix Technology Corp.
No. 491, Zhongfu Rd., Linkou Dist.,
New Taipei City 244, Taiwan

Tel: +886 2 26099301
Fax: +886 2 26099303

APPDNDIX B

TEST PHOTOGRAPHS

(Model: 17Z90Q)