

System Check_Head_2450MHz

DUT: D2450V2-736

Communication System: CW; Frequency: 2450 MHz; Duty Cycle: 1:1

Medium: HSL_2450_210117 Medium parameters used : $f = 2450$ MHz; $\sigma = 1.776$ S/m; $\epsilon_r = 38.544$; $\rho = 1000$ kg/m³

Ambient Temperature : 23.4 °C ; Liquid Temperature : 22.4 °C

DASY5 Configuration:

- Probe: EX3DV4 - SN7346; ConvF(7.66, 7.66, 7.66) @ 2450 MHz; Calibrated: 2020/5/20
- Sensor-Surface: 1.4mm (Mechanical Surface Detection)
- Electronics: DAE4 Sn853; Calibrated: 2020/7/23
- Phantom: ELI v4.0_Mid; Type: QDOVA001AA; Serial: TP:1131
- Measurement SW: DASY52, Version 52.10 (4); SEMCAD X Version 14.6.14 (7483)

Pin=250mW/Area Scan (71x71x1): Interpolated grid: dx=1.200 mm, dy=1.200 mm
Maximum value of SAR (interpolated) = 20.3 W/kg

Pin=250mW/Zoom Scan (7x7x7)/Cube 0: Measurement grid: dx=5mm, dy=5mm, dz=5mm
Reference Value = 110.6 V/m; Power Drift = -0.02 dB
Peak SAR (extrapolated) = 24.2 W/kg
SAR(1 g) = 12.2 W/kg; SAR(10 g) = 5.77 W/kg
Maximum value of SAR (measured) = 19.9 W/kg

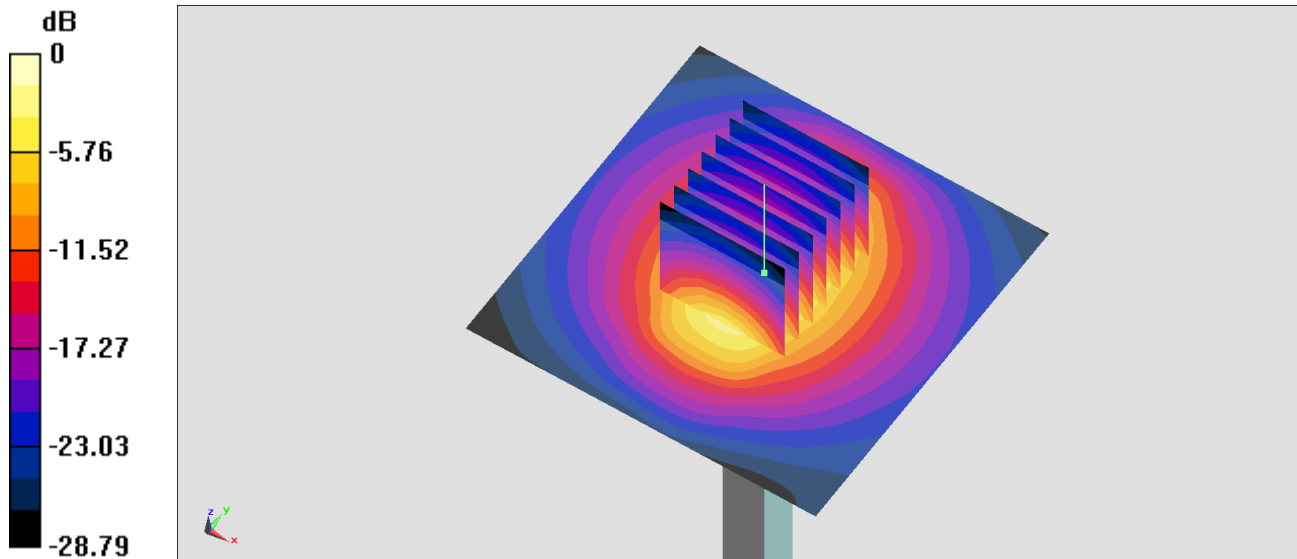

0 dB = 20.3 W/kg = 13.07 dBW/kg

System Check_Head_5250MHz

DUT: D5GHzV2-1006

Communication System: CW; Frequency: 5250 MHz; Duty Cycle: 1:1

Medium: HSL_5G_210117 Medium parameters used : $f = 5250$ MHz; $\sigma = 4.548$ S/m; $\epsilon_r = 37.217$; $\rho = 1000$ kg/m³

Ambient Temperature : 23.4 °C; Liquid Temperature : 22.4 °C

DASY5 Configuration:

- Probe: EX3DV4 - SN7346; ConvF(5.38, 5.38, 5.38) @ 5250 MHz; Calibrated: 2020/5/20
- Sensor-Surface: 1.4mm (Mechanical Surface Detection)
- Electronics: DAE4 Sn853; Calibrated: 2020/7/23
- Phantom: ELI v5.0_Left; Type: QDOVA002AA; Serial: TP:1238
- Measurement SW: DASY52, Version 52.10 (4); SEMCAD X Version 14.6.14 (7483)

Pin=100mW/Area Scan (71x71x1): Interpolated grid: dx=1.000 mm, dy=1.000 mm
Maximum value of SAR (interpolated) = 19.0 W/kg

Pin=100mW/Zoom Scan (7x7x7)/Cube 0: Measurement grid: dx=4mm, dy=4mm, dz=1.4mm
Reference Value = 70.60 V/m; Power Drift = 0.01 dB
Peak SAR (extrapolated) = 33.0 W/kg
SAR(1 g) = 7.78 W/kg; SAR(10 g) = 2.16 W/kg
Maximum value of SAR (measured) = 19.3 W/kg

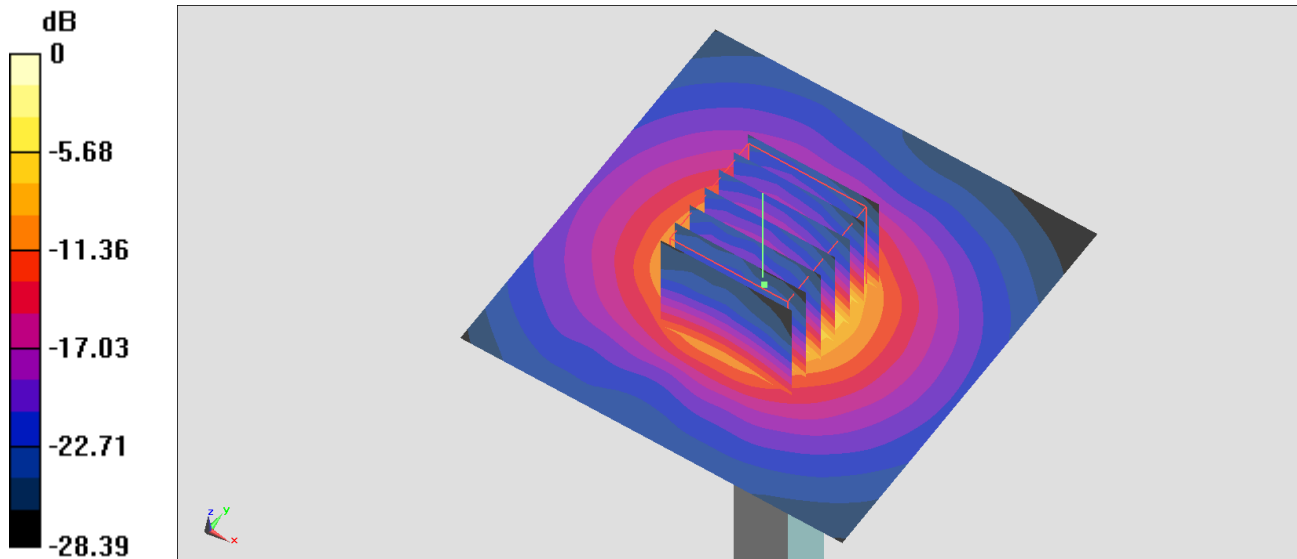

0 dB = 19.0 W/kg = 12.79 dBW/kg

System Check_Head_5600MHz

DUT: D5GHzV2-1006

Communication System: CW; Frequency: 5600 MHz; Duty Cycle: 1:1

Medium: HSL_5G_210117 Medium parameters used: $f = 5600$ MHz; $\sigma = 4.905$ S/m; $\epsilon_r = 36.808$; $\rho = 1000$ kg/m³

Ambient Temperature : 23.4 °C; Liquid Temperature : 22.4 °C

DASY5 Configuration:

- Probe: EX3DV4 - SN7346; ConvF(4.79, 4.79, 4.79) @ 5600 MHz; Calibrated: 2020/5/20
- Sensor-Surface: 1.4mm (Mechanical Surface Detection)
- Electronics: DAE4 Sn853; Calibrated: 2020/7/23
- Phantom: ELI v5.0_Left; Type: QDOVA002AA; Serial: TP:1238
- Measurement SW: DASY52, Version 52.10 (4); SEMCAD X Version 14.6.14 (7483)

Pin=100mW/Area Scan (71x71x1): Interpolated grid: dx=1.000 mm, dy=1.000 mm
Maximum value of SAR (interpolated) = 20.6 W/kg

Pin=100mW/Zoom Scan (7x7x7)/Cube 0: Measurement grid: dx=4mm, dy=4mm, dz=1.4mm
Reference Value = 72.20 V/m; Power Drift = 0.03 dB
Peak SAR (extrapolated) = 35.4 W/kg
SAR(1 g) = 8.21 W/kg; SAR(10 g) = 2.28 W/kg
Maximum value of SAR (measured) = 20.7 W/kg

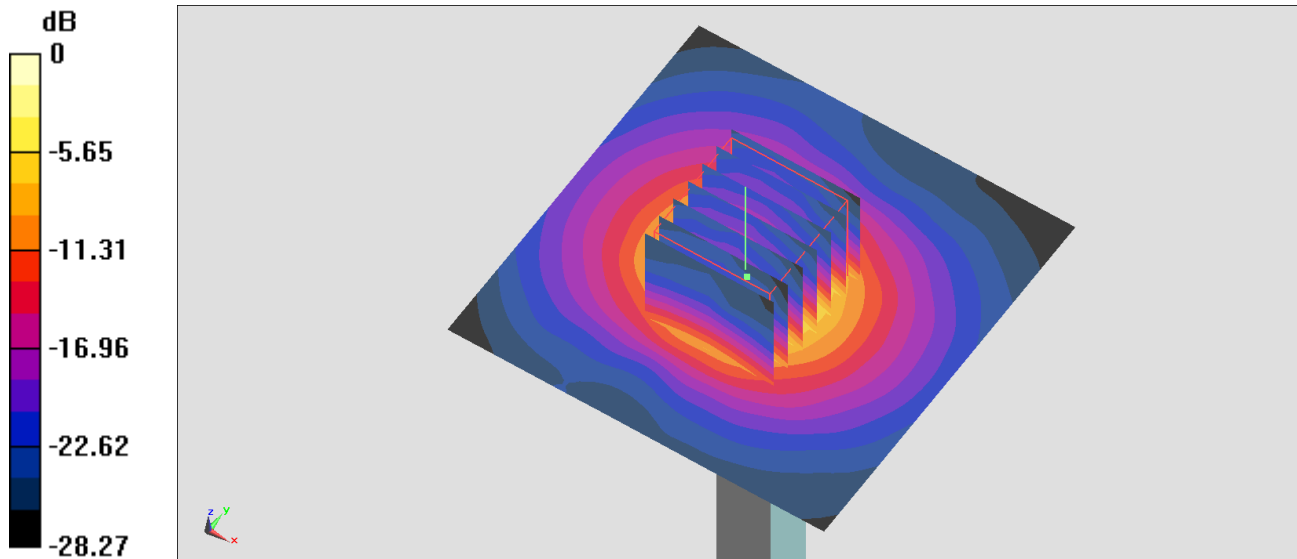

0 dB = 20.6 W/kg = 13.14 dBW/kg

System Check_Head_5750MHz

DUT: D5GHzV2-1006

Communication System: CW; Frequency: 5750 MHz; Duty Cycle: 1:1

Medium: HSL_5G_210117 Medium parameters used: $f = 5750$ MHz; $\sigma = 5.069$ S/m; $\epsilon_r = 36.641$; $\rho = 1000$ kg/m³

Ambient Temperature : 23.4 °C; Liquid Temperature : 22.4 °C

DASY5 Configuration:

- Probe: EX3DV4 - SN7346; ConvF(4.84, 4.84, 4.84) @ 5750 MHz; Calibrated: 2020/5/20
- Sensor-Surface: 1.4mm (Mechanical Surface Detection)
- Electronics: DAE4 Sn853; Calibrated: 2020/7/23
- Phantom: ELI v5.0_Left; Type: QDOVA002AA; Serial: TP:1238
- Measurement SW: DASY52, Version 52.10 (4); SEMCAD X Version 14.6.14 (7483)

Pin=100mW/Area Scan (71x71x1): Interpolated grid: dx=1.000 mm, dy=1.000 mm

Maximum value of SAR (interpolated) = 19.1 W/kg

Pin=100mW/Zoom Scan (7x7x7)/Cube 0: Measurement grid: dx=4mm, dy=4mm, dz=1.4mm

Reference Value = 70.19 V/m; Power Drift = -0.05 dB

Peak SAR (extrapolated) = 36.1 W/kg

SAR(1 g) = 7.71 W/kg; SAR(10 g) = 2.21 W/kg

Maximum value of SAR (measured) = 20.5 W/kg

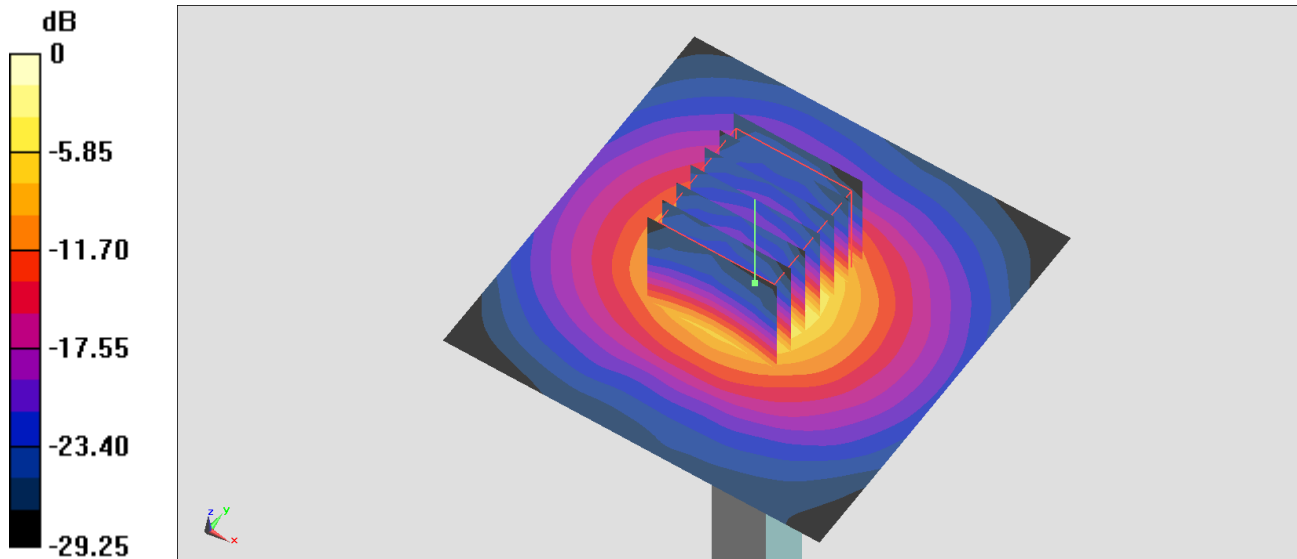

0 dB = 19.1 W/kg = 12.81 dBW/kg