

FCC 15.407 U-NII 5GHz Test Report

for

LG Electronics Inc.

**222, LG-ro, Jinwi-myeon Pyeongtaek-Si, Gyeonggi-Do,
17709 Republic of Korea**

Product Name : Notebook Computer
**Model Name : (1)16Z90SP (2)16ZB90SP
(3)16ZD90SP (4)16ZG90SP**
Brand : LG
FCC ID : BEJNT-16Z90SP

**Prepared by: : AUDIX Technology Corporation,
EMC Department**

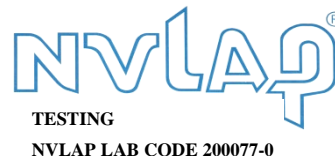

The test report is based on a single evaluation of one sample of the above-mentioned products. It does not imply an assessment of the whole production and does not permit the use of the test lab logo.

The report must not be used by the client to claim product certification, approval, or endorsement by NVLAP, NIST, or any agency of the U.S. Government.

TABLE OF CONTENTS

Description	Page
TEST REPORT.....	4
1. REVISION RECORD OF TEST REPORT	5
2. SUMMARY OF TEST RESULTS	6
3. GENERAL INFORMATION	7
3.1. Description of Application	7
3.2. Description of EUT	8
3.3. Reference Test Guidance.....	9
3.4. Antenna Information	9
3.5. EUT Specifications Assessed in Current Report	12
3.6. Description of Key Components	15
3.7. Test Configuration.....	18
3.8. Output Power Setting	28
3.9. Tested Supporting System List.....	31
3.10. Setup Configuration.....	31
3.11. Operating Condition of EUT	32
3.12. Description of Test Facility	32
3.13. Measurement Uncertainty	33
4. MEASUREMENT EQUIPMENTLIST.....	34
4.1. Conducted Emission Measurement	34
4.2. Radiated Emission Measurement	35
4.3. RF Conducted Measurement	35
5. CONDUCTED EMISSION.....	36
5.1. Block Diagram of Test Setup	36
5.2. Conducted Emission Limit	36
5.3. Test Procedure	36
5.4. Test Results	36
6. RADIATED EMISSION	37
6.1. Block Diagram of Test Setup	37
6.2. Radiated Emission Limits.....	38
6.3. Test Procedure	40
6.4. Measurement Result Explanation.....	41
6.5. Test Results	41
7. EMISSION/OCCUPIED BANDWIDTH.....	42
7.1. Block Diagram of Test Setup	42
7.2. Specification Limits.....	42
7.3. Test Procedure	42
7.4. Test Results	43
8. MAXIMUM OUTPUT POWER	44
8.1. Block Diagram of Test Setup	44
8.2. Specification Limits.....	44
8.3. Test Procedure	45
8.4. Test Results	45
9. POWER SPECTRAL DENSITY	46
9.1. Block Diagram of Test Setup	46



Audix Technology Corp.
No. 491, Zhongfu Rd., Linkou Dist.,
New Taipei City 244, Taiwan

Tel: +886 2 26099301
Fax: +886 2 26099303

9.2. Specification Limits.....	46
9.3. Test Procedure	46
9.4. Test Results	46
10. FREQUENCY STABILITY	47
10.1. Block Diagram of Test Setup	47
10.2. Specification Limits.....	47
10.3. Test Procedure	47
10.4. Test Results	47
11. DEVIATION TO TEST SPECIFICATIONS	48

APPENDIX A TEST DATA AND PLOTS
APPENDIX B TESTPHOTOGRAPHS

TEST REPORT

Applicant : LG Electronics Inc.
Manufacturer : LG Electronics Inc.
Factory : LG Electronics Nanjing New Technology Co., Ltd.
EUT Description
(1) Product : Notebook Computer
(2) Model : (1)16Z90SP (2)16ZB90SP (3)16ZD90SP (4)16ZG90SP
(3) Brand : LG
(4) Power Supply: (1)DC 20V, 4.5A
(2)DC 20V, 3.25A

Applicable Standards:

Title 47 FCC CFR Part 15 Subpart E

Audix Technology Corp. tested the equipment mentioned in accordance with the requirements set forth in the above standards. Test results indicate that the equipment tested is capable of demonstrating compliance with the requirements as documented within this report.

Audix Technology Corp. does not assume responsibility for any conclusions and generalizations drawn from the test results with regard to other specimens and samples.

Date of Report: 2023. 11. 24

Reviewed by: Annie Yu (Annie Yu/Administrator)

Approved by: Johnny Hsueh (Johnny Hsueh/Section Manager)

1. REVISION RECORD OF TEST REPORT

Edition No	Issued Date	Revision Summary	Report Number
0	2023. 11. 24	Original Report	EM-F230545

2. SUMMARY OF TEST RESULTS

Rule	Description	Results
15.207	Conducted Emission	PASS
15.205/15.209	Undesirable Emissions Limits: Radiated Band Edge and Radiated Spurious Emission	PASS
15.407(a)(5)/15.407(e)	Emission/Occupied Bandwidth	PASS
15.407(a)	Maximum Output Power	PASS
15.407(b)	Conducted Band Edges	N/A
15.407(a)	Power Spectral Density	PASS
15.407	Frequency Stability	PASS
15.407(h)(2)	Dynamic Frequency Selection(DFS)	PASS, Please refer to test report No. EM-F230546
15.203	Antenna Requirement	Compliance

Note: The uncertainties value is not used in determining the result.

3. GENERAL INFORMATION

3.1. Description of Application

Applicant	LG Electronics Inc. 222, LG-ro, Jinwi-myeon Pyeongtaek-Si, Gyeonggi-Do, 17709 Republic of Korea
Manufacturer	LG Electronics Inc. 222, LG-ro, Jinwi-myeon Pyeongtaek-Si, Gyeonggi-Do, 17709 Republic of Korea
Factory	LG Electronics Nanjing New Technology Co., Ltd. No.346, Yaoxin Road, Economic & Technical Development Zone, Nanjing, China.
Product	Notebook Computer
Model	(1)16Z90SP (2)16ZB90SP (3)16ZD90SP (4)16ZG90SP The difference between all models is different in the sales customers and color difference.
Brand	LG

3.2. Description of EUT

Test Model	16Z90SP		
Serial Number	N/A		
Power Rating	(1)DC 20V, 4.5A (2)DC 20V, 3.25A		
Software Version	XY (X, Y can be 0 to 9 for different SW version not influence RF parameter)		
RF Features	WLAN:802.11 a/b/g/n/ac/ax Bluetooth: BT and BLE (BT 5.3)		
Transmit Type	2.4 GHz		
	802.11b		1T1R
	802.11g		1T1R
	802.11n-HT20		2T2R
	802.11n-HT40		2T2R
	802.11ax-HE20		2T2R
	802.11ax-HE40		2T2R
	BT/BLE		1T1R
	U-NII Bands		
	802.11a		1T1R
	802.11n-HT20/802.11ac-VHT20/802.11ax-HE20		2T2R
	802.11n-HT40/802.11ac-VHT40/802.11ax-HE40		2T2R
	802.11ac-VHT80/802.11ax-HE80		2T2R
	802.11ac-VHT160/802.11ax-HE160		2T2R
	The MIMO is uncorrelated and supported SDM (Spatial Division Multiplexing) mode only. This radio device doesn't support beamforming and Cyclic Delay Diversity (CDD).		
Device Category	<input type="checkbox"/> Outdoor Access Point <input type="checkbox"/> Fixed point-to-point Access Point <input type="checkbox"/> Indoor Access Point <input checked="" type="checkbox"/> Mobile and Portable client device		
Test Sample	Sample No.	Test Item	Firmware
	01	AC Conduction, RSE, RF Conducted	N/A
	03	AC Conduction, RSE	N/A
Sample Status	Trial sample		
Date of Receipt	2023. 10. 13		
Date of Test	2023. 10. 17 ~ 11. 14		

Interface Ports of EUT	<ul style="list-style-type: none"> • One HDMI Port • Two USB Type C Ports • One Earphone Port • Two USB 3.0 Ports
Accessories Supplied	<ul style="list-style-type: none"> • AC Adapter • USB C Cable • LAN Gender

Note: Pursuant ISO 17025:2017 section 7.8.2, Audix Technology Corp. does not assume responsibility for all EUT's information including RF features, transmit type, antenna information...etc are provided by customer.

3.3. Reference Test Guidance

KDB 789033 D02 General UNII Test Procedures New Rules v02r01
 KDB 662911 D01 Multiple Transmitter Output v02r01
 ANSI C63.10:2013

3.4. Antenna Information

No.	Antenna Part Number	Manufacture	Antenna Type	Frequency (MHz)	Max Gain(dBi)	
					Main	AUX
1.	WA-P-LBLB-04-111	INPAQ	Mono-Pole	2400~2500	2.2	2.2
				5150~5350	1.8	1.8
				5470~5725	2.9	2.8
				5725~5850	2.3	3
				5925~6425	3.3	1.8
				6425~6525	2.7	2.5
				6525~6875	1.3	3.3
				6875~7125	1.4	2.9

According to KDB 662911 D01 d) ii), transmit signals are completely uncorrelated, then
 Directional gain = $10 \log[(10^{G1/10} + 10^{G2/10} + \dots + 10^{GN/10})/N_{ANT}]$ dBi

Note 1. 2.4G: Directional gain =

$$2400\sim 2500\text{MHz: Directional gain} = 10 \log[(10^{2.2/10} + 10^{2.2/10})/2] = 2.2\text{dBi}$$

Note 2. 5G: Directional gain =

$$5150 \sim 5350\text{MHz:} = 10 \log[(10^{1.8/10} + 10^{1.8/10})/2] = 1.8\text{dBi}$$

Note 3. UNII Band (WLAN 6G):

$$5925\sim 6425\text{MHz: Directional gain} = 10 \log[(10^{3.3/10} + 10^{1.8/10})/2] = 2.61\text{dBi}$$

$$6425\sim 6525\text{MHz: Directional gain} = 10 \log[(10^{2.7/10} + 10^{2.5/10})/2] = 2.60\text{dBi}$$

$$6525\sim 6875\text{MHz: Directional gain} = 10 \log[(10^{1.3/10} + 10^{3.3/10})/2] = 2.41\text{dBi}$$

$$6875\sim 7125\text{MHz: Directional gain} = 10 \log[(10^{1.4/10} + 10^{2.9/10})/2] = 2.21\text{dBi}$$

We chose the antenna gain corresponding to the frequency listed on the table which is closer to center frequency of WLAN.

No.	Antenna Part Number	Manufacture	Antenna Type	Frequency (MHz)	Max Gain(dBi)	
					Main	AUX
2.	L1LRF015-CS-H	LUXSHARE-ICT	Mono-Pole	2400	3.274	3.014
				2450	5.259	3.268
				2500	4.821	2.995
				5150	2.519	3.072
				5250	2.626	5.155
				5350	3.625	5.209
				5470	5.649	8.101
				5600	5.106	4.679
				5725	3.869	6.457
				5785	4.289	7.035
				5800	4.117	7.058
				5850	2.995	7.414
				5925	3.389	6.086
				6025	3.399	4.822
				6125	1.503	4.233
				6225	1.311	4.310
				6325	-0.913	3.824
				6425	-0.235	2.696
				6525	-0.526	0.877
				6625	-0.481	-0.490
6725	0.278	-1.049				
6825	0.716	-1.896				
6925	0.701	-2.361				
7025	0.087	-1.759				
7125	-1.074	-4.391				

According to KDB 662911 D01 d) ii), transmit signals are completely uncorrelated, then

$$\text{Directional gain} = 10 \log[(10^{G1/10} + 10^{G2/10} + \dots + 10^{GN/10})/N_{ANT}] \text{ dBi}$$

Note 1. 2.4G: Directional gain =

$$2400\text{MHz: Directional gain} = 10 \log[(10^{3.274/10} + 10^{3.014/10})/2] = 3.15\text{dBi}$$

$$2450\text{MHz: Directional gain} = 10 \log[(10^{5.259/10} + 10^{3.268/10})/2] = 4.38\text{dBi}$$

Note 2. 5G: Directional gain =

$$5150\text{MHz:} = 10 \log[(10^{2.159/10} + 10^{3.072/10})/2] = 2.80\text{dBi}$$

$$5250\text{MHz:} = 10 \log[(10^{2.626/10} + 10^{5.155/10})/2] = 4.07\text{dBi}$$

$$5350\text{MHz:} = 10 \log[(10^{3.625/10} + 10^{5.209/10})/2] = 4.49\text{dBi}$$

$$5470\text{MHz:} = 10 \log[(10^{8.101/10} + 10^{5.649/10})/2] = 7.05\text{dBi}$$

$$5600\text{MHz:} = 10 \log[(10^{4.679/10} + 10^{5.106/10})/2] = 4.90\text{dBi}$$

$$5725\text{MHz:} = 10 \log[(10^{6.457/10} + 10^{3.869/10})/2] = 5.35\text{dBi}$$

$$5785\text{MHz:} = 10 \log[(10^{7.035/10} + 10^{4.289/10})/2] = 5.88\text{dBi}$$

$$5800\text{MHz:} = 10 \log[(10^{7.058/10} + 10^{4.117/10})/2] = 5.83\text{dBi}$$

$$5825\text{MHz:} = 10 \log[(10^{7.414/10} + 10^{2.995/10})/2] = 5.74\text{dBi}$$

We chose the antenna gain corresponding to the frequency listed on the table which is closer to center frequency of WLAN.

According to KDB 662911 D01 d) ii), transmit signals are completely uncorrelated, then
Directional gain = $10 \log[(10^{G1/10} + 10^{G2/10} + \dots + 10^{GN/10})/N_{ANT}]$ dBi

Note 3. UNII Band (WLAN 6G):

5925MHz:	Directional gain = $10 \log[(10^{3.389/10} + 10^{6.086/10})/2]$	= 4.94dBi
6025MHz:	Directional gain = $10 \log[(10^{3.399/10} + 10^{4.882/10})/2]$	= 4.17dBi
6125MHz:	Directional gain = $10 \log[(10^{1.503/10} + 10^{4.233/10})/2]$	= 3.08dBi
6225MHz:	Directional gain = $10 \log[(10^{1.311/10} + 10^{4.310/10})/2]$	= 3.06dBi
6325MHz:	Directional gain = $10 \log[(10^{-0.913/10} + 10^{3.824/10})/2]$	= 2.07dBi
6425MHz:	Directional gain = $10 \log[(10^{-0.235/10} + 10^{2.696/10})/2]$	= 1.47dBi
6525MHz:	Directional gain = $10 \log[(10^{-0.526/10} + 10^{0.877/10})/2]$	= 0.23dBi
6625MHz:	Directional gain = $10 \log[(10^{-0.481/10} + 10^{-0.490/10})/2]$	= -0.49dBi
6725MHz:	Directional gain = $10 \log[(10^{0.278/10} + 10^{-1.049/10})/2]$	= -0.34dBi
6825MHz:	Directional gain = $10 \log[(10^{0.716/10} + 10^{-1.896/10})/2]$	= -0.40dBi
6925MHz:	Directional gain = $10 \log[(10^{0.701/10} + 10^{-2.361/10})/2]$	= -0.57dBi
7025MHz:	Directional gain = $10 \log[(10^{0.087/10} + 10^{-1.759/10})/2]$	= -0.74dBi
7125MHz:	Directional gain = $10 \log[(10^{-1.074/10} + 10^{-4.391/10})/2]$	= -2.42dBi

We chose the antenna gain corresponding to the frequency listed on the table which is closer to center frequency of WLAN.

3.5. EUT Specifications Assessed in Current Report

Mode	U-NII Band	Fundamental Range (MHz)	Channel Number
802.11a	1	5180-5240	4
	2A	5260-5320	4
	2C	5500-5720	12
	3	5745-5825	5
802.11n-HT20/ 802.11ac-VHT20 802.11ax-HE20	1	5180-5240	4
	2A	5260-5320	4
	2C	5500-5720	12
	3	5745-5825	5
802.11n-HT40/ 802.11ac-VHT40 802.11ax-HE40	1	5190-5230	2
	2A	5270-5310	2
	2C	5510-5710	6
	3	5755-5795	2
802.11ac-VHT80 802.11ax-HE80	1	5210	1
	2A	5290	1
	2C	5530-5690	3
	3	5775	1
802.11ac-VHT160 802.11ax-HE160	1	5250	1
	2A		
	2C	5570	1
Remark: U-NII Band 2A and 2C (DFS Function, Slave/no In service monitor, no Ad-Hoc mode)			

Mode	Modulation	Data Rate (Mbps)
802.11a	OFDM (BPSK/QPSK/16QAM/64QAM)	Up to 54
802.11n-HT20	OFDM (BPSK/QPSK/16QAM/64QAM)	Up to 144.4
802.11n-HT40		Up to 300
802.11ac-VHT20	OFDM (BPSK/QPSK/16QAM/64QAM/256QAM)	Up to 173.3
802.11ac-VHT40		Up to 400
802.11ac-VHT80		Up to 866.7
802.11ac-VHT160		Up to 1733.3
802.11ax-HE20	OFDMA (BPSK/ QPSK/ 16QAM/ 64QAM/ 256QAM/1024QAM)	Up to 287
802.11ax-HE40		Up to 574
802.11ax-HE80		Up to 1201
802.11ax-HE160		Up to 2402

Channel List					
802.11a/802.11n-HT20/802.11ac-VHT20/802.11ax-HE20					
U-NII Band	Channel Number	Frequency (MHz)	U-NII Band	Channel Number	Frequency (MHz)
1	36	5180	2C	120	5600
	40	5200		124	5620
	44	5220		128	5640
	48	5240		132	5660
2A	52	5260		136	5680
	56	5280		140	5700
	60	5300		144	5720
	64	5320		149	5745
2C	100	5500	3	153	5765
	104	5520		157	5785
	108	5540		161	5805
	112	5560		165	5825
	116	5580			

Channel List					
802.11n-HT40/802.11ac-VHT40/802.11ax-HE40					
U-NII Band	Channel Number	Frequency (MHz)	U-NII Band	Channel Number	Frequency (MHz)
1	38	5190	2C	118	5590
	46	5230		126	5630
2A	54	5270		134	5670
	62	5310		142	5710
2C	102	5510	3	151	5755
	110	5550		159	5795

Channel List					
802.11ac-VHT80/802.11ax-HE80					
U-NII Band	Channel Number	Frequency (MHz)	U-NII Band	Channel Number	Frequency (MHz)
1	42	5210	2C	138	5690
2A	58	5290	3	155	5775
2C	106	5530			
	122	5610			

Channel List					
802.11ac-VHT160/802.11ax-HE160					
U-NII Band	Channel Number	Frequency (MHz)	U-NII Band	Channel Number	Frequency (MHz)
1	50	5250	2C	114	5570
2A					

Note: Test modes are presented at section 3.7.

3.6. Description of Key Components

3.6.1. For the All Component Lists

Item	Supplier	Model / Type	Character
System	Microsoft	Win10 Home / Pro	---
		Win11 Home / Pro	
Main Board	LG	1XZ90SP MAIN B/D	PM (With GPU) Manufacturer: #1 Hannstar Board Tech (Jiang Yin) Corp.,Ltd. #2 Elec&Eltek Company (MCO) Limited.
			GM (Without GPU) Manufacturer: #1 Hannstar Board Tech (Jiang Yin) Corp.,Ltd. #2 Elec&Eltek Company (MCO) Limited.
SUB Board	LG	16Z90SP SUB B/D	Manufacturer: #1 HannstarBoardTech(Jiang Yin)Corp.,Ltd. #2 JiangSuHuaShen Electronic co.,ltd (HXF) #3 Elec&Eltek Company (MCO) Limited.
CPU (Socket: BGA2049)	Intel	Ultra 7 155H	3.8GHz
	Intel	Ultra 5 125H	3.6GHz
16" LCD Panel	SAMSUNG	ATNA60CL06-0	Resolution: 2560*1800@120Hz
	LG Display	LP160WQ2	Resolution: 2560 x 1600, 144Hz
Storage (SSD)	SK hynix	---	256GB
		---	512GB
		---	1TB
		---	2TB
	Samsung	---	256GB
		---	512GB
		---	1TB
		---	2TB
Memory (RAM)	Samsung	---	16GB LPDDR5x(On Board)
		---	8GB LPDDR5x(On Board)
		---	32GB LPDDR5x(On Board)
	SK Hynix	---	16GB LPDDR5x(On Board)
		---	8GB LPDDR5x(On Board)
		---	32GB LPDDR5x(On Board)
Battery Pack	LGES	LB3122MM	77Wh, DC 15.52V, 4963mAh For GM Main Board
	LGES	LBY122NM	90Wh, DC 15.52V, 5800mAh For PM Main Board
WLAN Combo Card	Intel	AX211D2W	WLAN and BT, 2x2 PCIe M.2 1216 SD adapter card FCC ID: PD9AX211D2 IC: 1000M-AX211D2
WLAN Combo Antenna	LG (INPAQ)	WA-P-LBLB-04-111	PCB, Mono-pole Type Main: Black, Aux: Gray
	LG (Luxshare)	L1LRF015-CS-H	PCB, Mono-pole Type Main: Black, Aux: Gray

Item	Supplier	Model / Type	Character	
Keyboard	TIC	22L2J/ 22B2L	---	
Touch Pad	LITE-ON	SP8B00B31(SG-A0660-00A)	---	
	ELAN	SD082A-34H0	---	
Web Camera	Luxvisions	ABG213N3	---	
LAN Gender (Type C to LAN)	SUZHOU MEC ELECTRONICS	80-5946-111	(White) 10/100 Megabit Ethernet	
		80-5946-101	(Black) 10/100 Megabit Ethernet	
	ARIN TECH CO. LTD	GD-08MF-36-WH-LP10	(White) 10/100 Megabit Ethernet	
		GD-08MF-36-BK-LP11	(Black) 10/100 Megabit Ethernet	
	HUIZHOU DEHONG TECHNOLOGY CO.,LTD.	370-50713	(White) 10/100 Megabit Ethernet	
		370-50714	(Black) 10/100 Megabit Ethernet	
	Type C to LAN: Shielded, Undetached			
	ARIN TECH CO. LTD	GD-08MF-50-WH-LP12	(White) 10/100/1000 Megabit Ethernet	
		GD-08MF-50-BK-LP13	(Black) 10/100/1000 Megabit Ethernet	
Type C to LAN: Shielded, Undetached				
AC Adapter	LG (HONOR)	LP90DGC20H-WW	I/P: AC 100-240V, 2.0A, 50-60Hz O/P: (PDO) DC 5.0V,3.0A(15W) or DC 9.0V, 3.0A(27W)or DC 15.0V,3.0A (45W) or DC 20.0V,4.5A (90W) (PPS) DC 5.0V~20.0V, 4.5A (Max 90W) (For PM Main Board)	
	#1 Type C Cable, Shielded, Undetached (5A) #2 Type C Cable, Shielded, Undetached (3A) AC Power Cord: Non-Shielded, Detached (3C)			
	LG (PI ELECTRONICS)	LP65WFC20P-NJ	I/P: AC 100-240V, 1.6A, 50-60Hz O/P:DC 5V,3A(15W) or DC 9V, 3A(27W)or DC 15V,3A (45W) or DC 20V,3.25A (65W) (For GM Main Board, US Type, Wall-mount)	
	#1 Type C Cable, Shielded, Undetached (5A) #2 Type C Cable, Shielded, Undetached,(3A)			

Remark: For more detailed features description, please refer to the manufacturer's specifications or the user manual.

3.6.2. The EUT collocates with following worst components, which are used to establish a basic configuration of system during test:

SKU (Mode)		1	2	
Main Board	LG, 1XZ90SP MAIN B/D [PM (With GPU)]	V		
	LG, 1XZ90SP MAIN B/D [GM (Without GPU)]		V	
SUB Board	LG, 16Z90SP SUB B/D	V	V	
CPU	Intel, Ultra 7 155H	V	V	
16" LCD Panel	SAMSUNG, ATNA60CL06-0	V	V	
Storage (SSD)	Samsung, 2TB	V	V	
Memory (RAM)	SK hynix, 32GB	V	V	
Battery Pack	LG, 90Wh	V	V	
Keyboard	TIC, 22L2J/ 22B2L	V	V	
Touch Pad	LITE-ON, SP8B00B31(SG-A0660-00A)	V	V	
Web Camera	Luxvisions, ABG213N3A	V	V	
WLAN Combo Card	Intel, AX211D2W	V	V	
WLAN Combo Antenna	LG (INPAQ), WA-P-LBLB-04-111	V	V	
	LG (Luxshare), L1LRF015-CS-H	V	V	
Type C #1	AC Adapter	LG (HONOR), LP90DGC20H-WW	V	V
Type C #2	Link to LAN Gender	MEC (White)	V	V

Evaluation method	INPAQ	LUXSHARE-ICT	INPAQ	LUXSHARE-ICT
	SKU #1	SKU #1	SKU #2	SKU #2
2.4G Band	Full test	Full test	Worst case depend on INPAQ test result	Worst case depend on LUXSHARE-ICT test result
5G Band	Full test	Full test	Worst case depend on INPAQ test result	Worst case depend on LUXSHARE-ICT test result

3.7. Test Configuration

Mode	TX _{on} (ms)	TX _{on+off} (ms)	Duty Cycle (x)	Duty Cycle Factor [10log(1/x)] (dB)
802.11a	2.090	2.110	0.991	N/A
802.11n-HT20	2.580	2.620	0.985	N/A
802.11n-HT40	2.590	2.630	0.985	N/A
802.11ac-VHT80	2.580	2.620	0.985	N/A
802.11ac-VHT160	2.570	2.610	0.985	N/A
802.11ax-HE20	5.360	5.420	0.989	N/A
802.11ax-HE40	4.560	4.600	0.991	N/A
802.11ax-HE80	2.580	2.620	0.985	N/A
802.11ax-HE160	2.430	2.470	0.984	N/A
802.11ax-HE20 (RU Config 26)	3.860	3.910	0.987	N/A
802.11ax-HE20 (RU Config 52)	3.870	3.910	0.990	N/A
802.11ax-HE20 (RU Config 106)	3.880	3.910	0.992	N/A
802.11ax-HE40 (RU Config 242)	3.860	3.910	0.987	N/A
802.11ax-HE80 (RU Config 484)	3.850	3.900	0.987	N/A
802.11ax-HE160 (RU Config 996)	3.860	3.910	0.987	N/A

Note: When duty cycle is less than 98% (0.98) that duty cycle factor $10\log(1/x)$ is needed to add in conducted test items measured in average detector.

Mode	TX _{on} (ms)	T _{on} +T _{off} (ms)
802.11a		
802.11n-HT20		
802.11n-HT40		
802.11ac-VHT80		
802.11ac-VHT160		

Mode	TX _{on} (ms)	T _{on} +T _{off} (ms)
802.11ax-HE20		
802.11ax-HE40		
802.11ax-HE80		
802.11ax-HE160		

Mode	TX _{on} (ms)	T _{on} +T _{off} (ms)
802.11ax-HE20 (RU Config 26)		
802.11ax-HE20 (RU Config 52)		
802.11ax-HE20 (RU Config 106)		
802.11ax-HE40 (RU Config 242)		

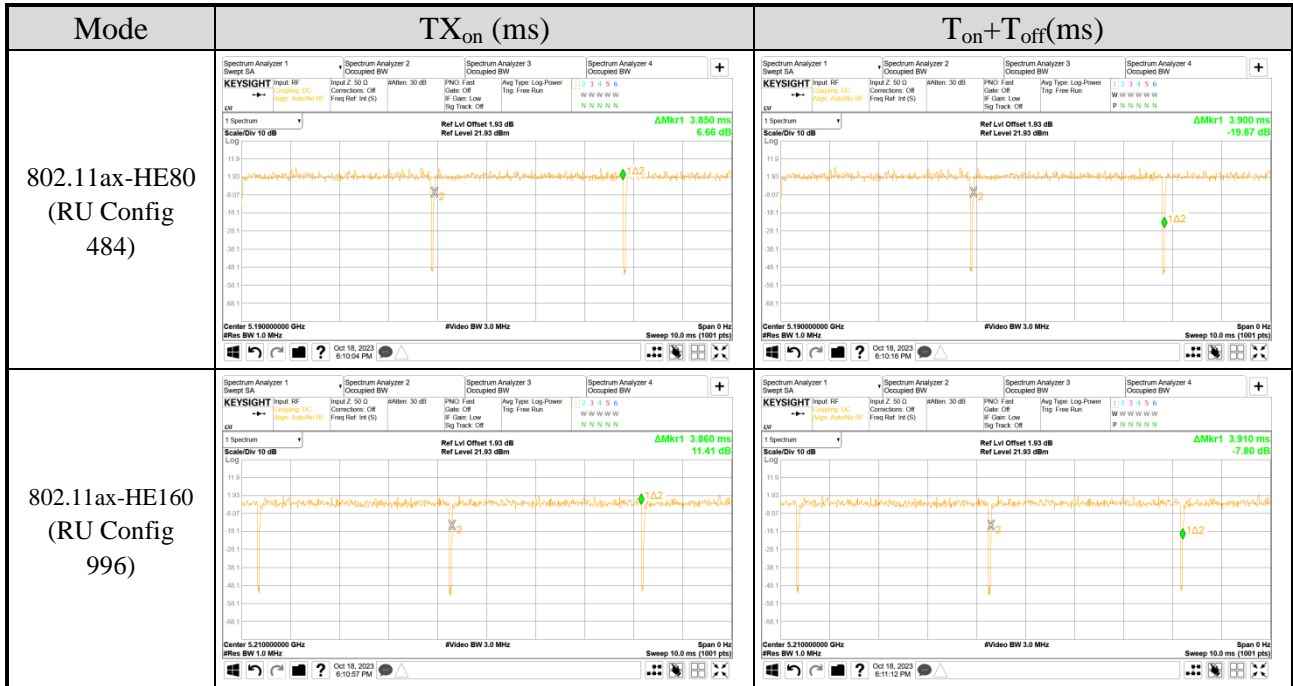

AC Conduction	
SKU #1(with INPOAQ ANT)	Normal operation
SKU #2(with LUXSHARE-ICT ANT)	Normal operation

Item	Mode	Data Rate	Test Channel
Radiated Test Case	SKU #1 (with INPAQ ANT)	Radiated Spurious Emission (30MHz~1GHz)	802.11n-HT40 MCS8 142
	SKU #1 (with LUXSHARE-ICT ANT)		802.11n-HT40 MCS8 142

Item	Mode	Data Rate	Test Channel		
Radiated Test Case	SKU #1 (with INPAQ ANT)	Radiated Band Edge Note1	802.11a	6 Mbps	36/64/100/140/144/149/165
			802.11n-HT20	MCS8	36/64/100/140/144/149/165
			802.11n-HT40	MCS8	38/62/102/134/142/151/159
			802.11ac-VHT80	MCS0	42/58/106/122/138/155
			802.11ac-VHT160	MCS0	50/114
			802.11ax-HE20	HE0	36/64/100/140/144/149/165
			802.11ax-HE40	HE0	38/62/102/134/142/151/159
			802.11ax-HE80	HE0	42/58/106/122/138/155
		802.11ax-HE160	HE0	50/114	
		Radiated Spurious Emission Note1 & 2	802.11a	6 Mbps	36/64/140/144/149
			802.11n-HT20	MCS8	40/52/100/144/149
			802.11n-HT40	MCS8	46/54/110/142/151
			802.11ac-VHT80	MCS0	42/58/122/138/155
			802.11ac-VHT160	MCS0	50/114
			802.11ax-HE20	HE0	36/52/100/144/149
			802.11ax-HE40	HE0	46/54/110/142/151
	802.11ax-HE80		HE0	42/58/122/138/155	
	802.11ax-HE160	HE0	50/114		
	SKU #1 (with LUXSHAR E-ICT ANT)	Radiated Band Edge Note1	802.11a	6 Mbps	36/64/100/140/144/149/165
			802.11n-HT20	MCS8	36/64/100/140/144/149/165
			802.11n-HT40	MCS8	38/62/102/134/142/151/159
			802.11ac-VHT80	MCS0	42/58/106/122/138/155
			802.11ac-VHT160	MCS0	50/114
			802.11ax-HE20	HE0	36/64/100/140/144/149/165
			802.11ax-HE40	HE0	38/62/102/134/142/151/159
			802.11ax-HE80	HE0	42/58/106/122/138/155
		802.11ax-HE160	HE0	50/114	
		Radiated Spurious Emission Note1 & 2	802.11a	6 Mbps	36/64/100/144/165
			802.11n-HT20	MCS8	48/52/140/144/149
			802.11n-HT40	MCS8	46/54/110/142/151
			802.11ac-VHT80	MCS0	42/58/122/138/155
			802.11ac-VHT160	MCS0	50/114
802.11ax-HE20			HE0	48/52/116/144/157	
802.11ax-HE40			HE0	46/54/110/142/151	
802.11ax-HE80	HE0		42/58/122/138/155		
802.11ax-HE160	HE0	50/114			

Item		Mode	Data Rate	RU Configuration	Test Channel		
Radiated Test Case	SKU #1 (with INPAQ ANT)	Radiated Band Edge Note1	802.11ax-HE20	HE0	26/0	36/100/149	
				HE0	52/37		
				HE0	106/53		
			802.11ax-HE40	HE0	26/8	64/140/165	
				HE0	52/40		
				HE0	106/54		
		802.11ax-HE80	HE0	242/61	38/102/151		
			HE0	242/62	62/134/159		
		802.11ax-HE160	HE0	484/65	42/106/155		
			HE0	484/66	58/122/155		
		SKU #1 (with LUXSHARE-ICT ANT)	Radiated Band Edge Note1	802.11ax-HE20	HE0	26/0	36/100/149
					HE0	52/37	
	HE0				106/53		
	802.11ax-HE40			HE0	26/8	64/140/165	
				HE0	52/40		
				HE0	106/54		
	802.11ax-HE80	HE0	242/61	38/102/151			
		HE0	242/62	62/134/159			
	802.11ax-HE160	HE0	484/65	42/106/155			
		HE0	484/66	58/122/155			
	SKU #1 (with LUXSHARE-ICT ANT)	Radiated Band Edge Note1	802.11ax-HE160	HE0	996/67	50/114	
				HE0	996/S67	50/114	
				HE0	996/S67	50/114	

Item		Mode	Data Rate	Test Channel	
Conducted Test Case	SKU #1 Note 6	Emission/ Occupied Bandwidth	802.11a	6 Mbps	36/40/48/52/60/64/100/116/140/144/149/157/165
			802.11n-HT20	MCS8	36/40/48/52/60/64/100/116/140/144/149/157/165
			802.11n-HT40	MCS8	38/46/54/62/102/110/134/142/151/159
			802.11ac-VHT80	MCS0	42/58/106/122/138/155
			802.11ac-VHT160	MCS0	50/114
			802.11ax-HE20	HE0	36/40/48/52/60/64/100/116/140/144/149/157/165
			802.11ax-HE40	HE0	38/46/54/62/102/110/134/142/151/159
			802.11ax-HE80	HE0	42/58/106/122/138/155
			802.11ax-HE160	HE0	50/114
		Maximum output power	802.11a	6 Mbps	36/40/48/52/60/64/100/116/140/144/149/157/165
			802.11n-HT20	MCS8	36/40/48/52/60/64/100/116/140/144/149/157/165
			802.11n-HT40	MCS8	38/46/54/62/102/110/134/142/151/159
			802.11ac-VHT80	MCS0	42/58/106/122/138/155
			802.11ac-VHT160	MCS0	50/114
			802.11ax-HE20	HE0	36/40/48/52/60/64/100/116/140/144/149/157/165
			802.11ax-HE40	HE0	38/46/54/62/102/110/134/142/151/159
			802.11ax-HE80	HE0	42/58/106/122/138/155
			802.11ax-HE160	HE0	50/114
		Power spectral density	802.11a	6 Mbps	36/40/48/52/60/64/100/116/140/144/149/157/165
			802.11n-HT20	MCS8	36/40/48/52/60/64/100/116/140/144/149/157/165
			802.11n-HT40	MCS8	38/46/54/62/102/110/134/142/151/159
			802.11ac-VHT80	MCS0	42/58/106/122/138/155
			802.11ac-VHT160	MCS0	50/114
			802.11ax-HE20	HE0	36/40/48/52/60/64/100/116/140/144/149/157/165
			802.11ax-HE40	HE0	38/46/54/62/102/110/134/142/151/159
			802.11ax-HE80	HE0	42/58/106/122/138/155
			802.11ax-HE160	HE0	50/114

Item		Mode	Data Rate	RU Configuration	Test Channel	
Conducted Test Case	SKU #1 Note 6	Emission/ Occupied Bandwidth	802.11ax-HE20	HE0	26/0	36/100/149
					52/37	
					106/53	
			802.11ax-HE40	HE0	26/8	64/140/165
					52/40	
					106/54	
		802.11ax-HE80	HE0	242/61	38/102/151	
				242/62	62/134/159	
				484/65	42/106/155	
		802.11ax-HE160	HE0	484/66	58/122/155	
				996/67	50/114	
				996/S67	50/114	
Conducted Test Case	SKU #1 Note 6	Maximum output power	802.11ax-HE20	HE0	26/0	36/100/149
					52/37	
					106/53	
			802.11ax-HE40	HE0	26/8	64/140/165
					52/40	
					106/5	
		802.11ax-HE80	HE0	242/61	38/102/151	
				242/62	62/134/159	
				484/65	42/106/155	
		802.11ax-HE160	HE0	484/66	58/122/155	
				996/67	50/114	
				996/S67	50/114	

Item		Mode	Data Rate	RU Configuration	Test Channel	
Conducted Test Case	SKU #1 Note 6	Power spectral density	802.11ax-HE20	HE0	26/0	36/100/149
					52/37	
					106/53	
			802.11ax-HE40	HE0	26/8	64/140/165
					52/40	
					106/54	
		802.11ax-HE80	HE0	242/61	38/102/151	
				242/62	62/134/159	
				484/65	42/106/155	
		802.11ax-HE160	HE0	484/66	58/122/155	
				996/67	50/114	
				996/S67	50/114	

Spot Check ^{Note 5}

Item		Mode	Data Rate	Test Channel	
Radiated Test Case	SKU #2 (with INPAQ ANT)	Radiated Spurious Emission (30MHz~1GHz)	802.11n-HT40	MCS8	142
	SKU #1 (with LUXSHARE-ICT ANT)		802.11n-HT40	MCS8	142

Item		Mode	Data Rate	Test Channel	
Radiated Test Case	SKU #2 (with INPAQ ANT)	Radiated Spurious Emission	802.11a	6 Mbps	144
	SKU #2 (with LUXSHARE-ICT ANT)	Radiated Spurious Emission	802.11a	6 Mbps	106

Item		Mode	Data Rate	Test Channel	
Radiated Test Case	SKU#2 (with INPAQ ANT)	Radiated Band Edge	802.11ax-HE40	HE0	38
	SKU #2 (with LUXSHARE-ICT ANT)	Radiated Band Edge	802.11ac-VHT160	MCS0	114

Note 1: Mobile Device Portable Device

and 3 axis were assessed. The worst scenario for Radiated Spurious Emission as follow:

Lie Side Stand

Note 2: Low, mid, and high channels were measured, only the worst channel of each modulation was presented in this report.

Note 3: The modulation and bandwidth are similar for 802.11n mode for HT20/HT40 and 802.11ac mode for VHT20/VHT40, therefore investigated worst case to representative mode in the test report.

Note 4: The data rates were selected based on preliminary testing that identified rate as the worst case for output power.

Note 5: The spot check worst case was depended on SKU # 1 (with INPAQ ANT and with LUXSHARE-ICT ANT).

Note 6: We used SKU #1 measured all conducted test

3.8. Output Power Setting

Mode	U-NII Band	Centre Frequency (MHz)	Power Setting	
			AUX	Main
802.11a	1	5180	16.500	16.500
		5200	16.500	16.500
		5240	16.500	16.500
	2A	5260	16.500	16.500
		5300	16.500	16.500
		5320	16.500	16.500
	2C	5500	16.500	16.500
		5580	16.500	16.500
		5700	16.500	16.500
		5720	16.500	16.500
	3	5745	16.500	16.500
		5785	16.500	16.500
5825		16.500	16.500	

Mode	U-NII Band	Centre Frequency (MHz)	Power		Mode	U-NII Band	Centre Frequency (MHz)	Power Setting	
			AUX	Main				AUX	Main
802.11n-HT20	1	5180	16.500	16.500	802.11ax-HE20	1	5180	16.500	16.500
		5200	16.500	16.500			5200	16.500	16.500
		5240	16.500	16.500			5240	16.500	16.500
	2A	5260	16.500	16.500		2A	5260	16.500	16.500
		5300	16.500	16.500			5300	16.500	16.500
		5320	16.500	16.500			5320	16.500	16.500
	2C	5500	16.500	16.500		2C	5500	16.500	16.500
		5580	16.500	16.500			5580	16.500	16.500
		5700	16.500	16.500			5700	16.500	16.500
		5720	16.500	16.500			5720	16.500	16.500
	3	5745	16.500	16.500		3	5745	16.500	16.500
		5785	16.500	16.500			5785	16.500	16.500
5825		16.500	16.500	5825	16.500		16.500		

Mode	U-NII Band	Centre Frequency (MHz)	Power Setting		Mode	U-NII Band	Centre Frequency (MHz)	Power Setting	
			AUX	Main				AUX	Main
802.11n-HT40	1	5190	15.000	15.000	802.11ax-HE40	1	5190	15.000	15.000
		5230	16.500	16.500			5230	16.500	16.500
	2A	5270	16.500	16.500		2A	5270	16.500	16.500
		5310	15.250	15.250			5310	15.250	15.250
	2C	5510	16.250	16.250		2C	5510	16.250	16.250
		5550	16.500	16.500			5550	16.500	16.500
		5670	16.500	16.500			5670	16.500	16.500
		5710	16.500	16.500			5710	16.500	16.500
	3	5755	16.500	16.500		3	5755	16.500	16.500
		5795	16.500	16.500			5795	16.500	16.500

Mode	U-NII Band	Centre Frequency (MHz)	Power Setting		Mode	U-NII Band	Centre Frequency (MHz)	Power Setting	
			AUX	Main				AUX	Main
802.11ac-VT80	1	5210	14.000	14.000	802.11ax-HE80	1	5210	14.000	14.000
	2A	5290	14.500	14.500		2A	5290	14.500	14.500
	2C	5530	15.000	15.000		2C	5530	15.000	15.000
		5610	16.500	16.500			5610	16.500	16.500
		5690	16.500	16.500			5690	16.500	16.500
	3	5775	16.500	16.500		3	5775	16.500	16.500

Mode	U-NII Band	Centre Frequency (MHz)	Power Setting		Mode	U-NII Band	Centre Frequency (MHz)	Power Setting	
			AUX	Main				AUX	Main
802.11ac-VT160	1 / 2A	5250	11.000	11.000	802.11ax-HE160	1 / 2A	5250	11.000	11.000
	2C	5570	13.750	13.750		2C	5570	13.750	13.750

Mode	U-NII Band	Centre Frequency (MHz)	RU Configuration	Power Setting	
				AUX	Main
802.11ax-HE20	1	5180	26/0	10.000	10.000
			52/37	13.000	13.000
			106/53	16.000	16.000
	2A	5320	26/8	10.000	10.000
			52/40	13.000	13.000
			106/54	15.750	15.750
	2C	5500	26/0	10.000	10.000
			52/37	13.000	13.000
			106/53	15.250	15.250
		5700	26/8	10.000	10.000
			52/40	13.000	13.000
			106/54	16.000	16.000
	3	5745	26/0	16.000	16.000
			52/37	13.000	13.000
			106/53	16.500	16.500
5825		26/8	16.000	16.000	
		52/40	13.000	13.000	
		106/54	16.500	16.500	
802.11ax-HE40	1	5190	242/61	16.500	16.500
	2A	5310	242/62	16.250	16.250
	2C	5510	242/61	16.500	16.500
		5670	242/62	16.500	16.500
	3	5755	242/61	16.500	16.500
		5795	242/62	16.500	16.500
802.11ax-HE80	1	5210	484/65	14.000	14.000
	2A	5290	484/66	12.000	12.000
	2C	5530	484/65	15.250	15.250
		5610	484/66	16.500	16.500
	3	5775	484/65	16.500	16.500
			484/66	16.500	16.500
802.11ax-HE160	1/ 2A	5250	996/67	14.000	14.000
			996/S67	12.500	12.500
	2C	5570	996/67	14.000	14.000
			996/S67	16.500	16.500

3.9. Tested Supporting System List

3.9.1. Support Peripheral Unit

No.	Product	Brand	Model No.	Serial No.	Approval
1.	LCD Monitor	DELL	U2718Qb	CN-0M5R5F-QDC 00-99P-04CL	N/A
2.	USB Mouse	Lenovo	SM-8823	8SSM50L24506AV LC99H049R	N/A
3.	Earphone	APPLE	N/A	N/A	N/A
Partner System					
4.	AP Server	ASUS	RT-AX88U	N/A	FCC ID: MSQ-RTAXHP00 IC: 3568A-RTAXHP00

3.9.2. Cable Lists

No.	Cable Description Of The Above Support Units
1.	HDMI Cable: Shielded, Detachable, 1.8 AC Power Cord: Unshielded, Detachable, 1.8m
2.	USB Cable: Unshielded, Undetachable, 1.8
3.	Earphone Cable: Unshielded, Undetachable, 1.2m
4.	AC adapter: M/N:WA-30B12, Cable: Unshielded, Detachable, 1.2m LAN cable: Unshielded, Detachable, 3.0m
5.	LAN cable: Unshielded, Detachable, 1.8m

3.10. Setup Configuration

3.10.1. EUT Configuration for Power Line & Radiated Emission

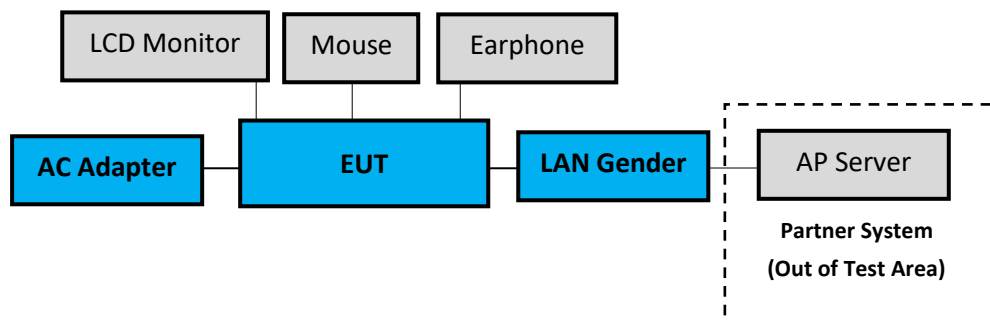

3.10.2. EUT Configuration for RF Conducted Test Items

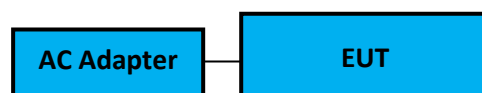

3.11. Operating Condition of EUT

Test program “DRTU” is used for enabling EUT WLAN function under continues transmitting and choosing data rate/ channel.

[ANT AUX port (A Button in DRTU) and ANT Main port (B Button in DRTU)].

3.12. Description of Test Facility

Name of Test Firm	Audix Technology Corporation / EMC Department No. 491, Zhongfu Rd., Linkou Dist., New Taipei City 244, Taiwan Tel: +886-2-26092133 Fax: +886-2-26099303 Website : www.audixtech.com Contact e-mail: attemc_report@audixtech.com
Accreditations	The laboratory is accredited by following organizations under ISO/IEC 17025:2017 (1) NVLAP(USA) NVLAP Lab Code 200077-0 (2) TAF(Taiwan) No. 1724
Test Facilities	FCC OET Designation Number under APEC MRA by NCC is : TW1724 ISED CAB Identifier Number under APEC TEL MRA by NCC is TW1724 (1) No.8 Shielded Room (2) No.1 3m Semi Anechoic Chamber

3.13.Measurement Uncertainty

The measurement uncertainty levels have been estimated as specified in ETSI TR 100 028-2001

Test Items/Facilities		Frequency Range	Uncertainty
Conduction Test	<input type="checkbox"/>	No. 7 Shielded Room	9kHz-150kHz ±3.7dB
			150kHz-30MHz ±3.4dB
	<input checked="" type="checkbox"/>	No. 8 Shielded Room	9kHz-150kHz ±3.7dB
			150kHz-30MHz ±3.5dB
Radiation Test	<input checked="" type="checkbox"/>	No.1 3m Semi Anechoic Chamber	30MHz-200MHz, 3m, Horizontal ±3.6dB
			200MHz-1000MHz, 3m, Horizontal ±4.3dB
			30MHz-200MHz, 3m, Vertical ±4.4dB
			200MHz-1000MHz, 3m, Vertical ±4.8dB
			1GHz-6GHz, 3m ±4.8dB
			6GHz-18GHz, 3m ±4.5dB
	<input type="checkbox"/>	No.3 3m Semi Anechoic Chamber	30MHz-200MHz, 3m, Horizontal ±4.0dB
			200MHz-1000MHz, 3m, Horizontal ±4.4dB
			30MHz-200MHz, 3m, Vertical ±4.7dB
			200MHz-1000MHz, 3m, Vertical ±4.5dB
			1GHz-6GHz, 3m ±4.8dB
			6GHz-18GHz, 3m ±4.5dB
	<input type="checkbox"/>	No.4 3m Semi Anechoic Chamber	30MHz-200MHz, 3m, Horizontal ±4.3dB
			200MHz-1000MHz, 3m, Horizontal ±4.2dB
			30MHz-200MHz, 3m, Vertical ±4.8dB
			200MHz-1000MHz, 3m, Vertical ±4.7dB
			1GHz-6GHz, 3m ±4.6dB
			6GHz-18GHz, 3m ±4.4dB
	<input type="checkbox"/>	No.5 3m Semi Anechoic Chamber	30MHz-200MHz, 3m, Horizontal ±4.6dB
			200MHz-1000MHz, 3m, Horizontal ±4.4dB
			30MHz-200MHz, 3m, Vertical ±4.5dB
			200MHz-1000MHz, 3m, Vertical ±4.9dB
			1GHz-6GHz, 3m ±4.9dB
			6GHz-18GHz, 3m ±4.6dB
Radiated emissions (18GHz-40GHz)		18GHz-40GHz, 3m ±3.4dB	

Remark : Uncertainty = $ku_c(y)$

Test Items	Uncertainty
Bandwidth	± 0.2kHz
Maximum output power	± 0.33dB
Power spectral density	± 0.13dB

4. MEASUREMENT EQUIPMENT LIST

4.1. Conducted Emission Measurement

Item	Type	Manufacturer	Model No.	Serial No.	Cal. Date	Cal. Interval
1.	Test Receiver	R&S	ESR3	101774	2023. 01. 11	1 Year
2.	A.M.N.	R&S	ENV432	101567	2023. 06. 02	1 Year
3.	L.I.S.N.	Kyoritsu	KNW-407	8-855-9	2022. 12. 19	1 Year
4.	Pulse Limiter	R&S	ESH3-Z2	100354	2022. 12. 14	1 Year
5.	Digital Thermo-Hygro Meter	iMax	HTC-1	No.8 S/R	2023. 04. 13	1 Year
6.	Coaxial Cable	Yeida	RG/58AU	CE-08	2023. 09. 06	1 Year
7.	Test Software	Audix	e3	V9 18621a	N.C.R.	N.C.R.

4.2. Radiated Emission Measurement

Item	Type	Manufacturer	Model No.	Serial No.	Cal. Date	Cal. Interval
1.	Spectrum Analyzer	Agilent	N9010A-526	MY53400071	2023.08.16	1 Year
2.	Spectrum Analyzer	Keysight	N9010B-544	MY55460198	2023.03.29	1 Year
3.	Test Receiver	R&S	ESCS30	100338	2023.06.20	1 Year
4.	Amplifier	HP	8447D	2944A06305	2022.12.29	1 Year
5.	Microwave Amplifier	Keysight	83051A	MY56480113	2023.09.11	1 Year
6.	Microwave Amplifier	Agilent	8449B	3008A02678	2023.02.17	1 Year
7.	Loop Antenna	TESEQ	HLA 6121	60478	2023.02.21	1 Year
8.	Bilog Antenna	TESEQ	CBL6112D	33821	2023.06.30	1 Year
9.	Horn Antenna	EMCO	3115	9112-3775	2023.05.04	1 Year
10.	Horn Antenna	COM-POWER	AH-840	101092	2022.12.30	1 Year
11.	5G Notch Filter	Microwave Circuits	N0452502	459775	2023.05.03	1 Year
12.	5G Notch Filter	Microwave Circuits	N0555983	504921	2023.08.02	1 Year
13.	5G Notch Filter	Microwave Circuits	N0257881	459776	2023.08.01	1 Year
14.	Coaxial Cable	MIYAZAKI	5D2W	RE-11	2023.01.07	1 Year
15.	Coaxial Cable	HUBER+SUHNER	RG223/U	RE-33	2023.03.02	1 Year
16.	Coaxial Cable	HUBER+SUHNER	SUCOFLEX 106	RE-14	2023.01.07	1 Year
17.	Coaxial Cable	HUBER+SUHNER	SUCOFLEX 102	RE-30	2023.08.21	1 Year
18.	Digital Thermo-Hygro Meter	iMax	HTC-1	No.1 3m A/C	2023.04.13	1 Year
19.	Test Software	Audix	e3	V9 18621a	N.C.R.	N.C.R.

4.3. RF Conducted Measurement

Item	Type	Manufacturer	Model No.	Serial No.	Cal. Date	Cal. Interval
1.	Spectrum Analyzer	Keysight	N9020B-544	MY57120357	2023. 02. 22	1 Year
2.	Power Meter	Anritsu	ML2495A	2127005	2022. 12. 01	1 Year
3.	Power Meter	Anritsu	ML2495A	2127004	2022. 12. 07	1 Year
4.	Power Sensor	Anritsu	MA2411B	1911360	2022. 12. 07	1 Year
5.	Power Sensor	Anritsu	MA2411B	1911356	2022. 12. 01	1 Year
6.	Digital Thermo-Hygro Meter	iMax	HTC-1	RF-03	2023. 04. 13	1 Year

5. CONDUCTED EMISSION

5.1. Block Diagram of Test Setup

5.1.1. Block Diagram of EUT

Indicated as section 3.10

5.1.2. Shielded Room Setup Diagram

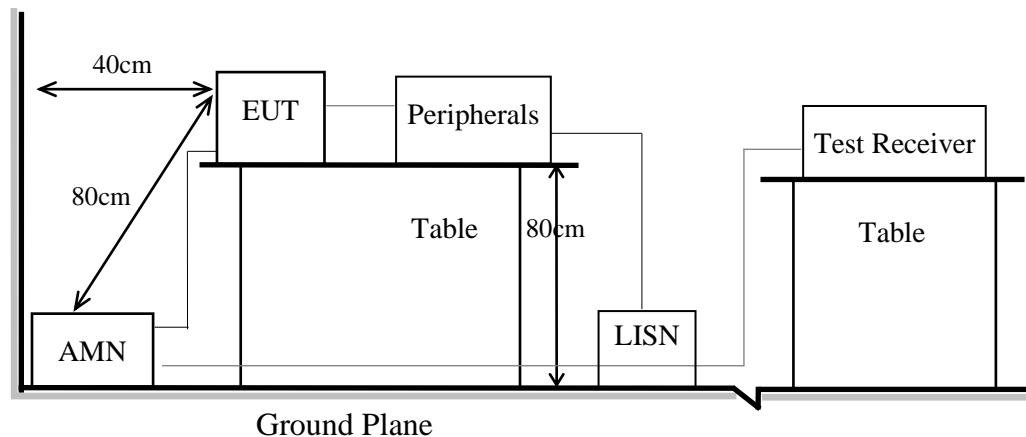

5.2. Conducted Emission Limit

Frequency	Conducted Limit	
	Quasi-Peak Level	Average Level
150kHz ~ 500kHz	66 ~ 56 dB μ V	56 ~ 46 dB μ V
500kHz ~ 5MHz	56 dB μ V	46 dB μ V
5MHz ~ 30MHz	60 dB μ V	50 dB μ V

Remark1.: If the average limit is met when using a Quasi-Peak detector, the measurement using the average detector is not required.

2.: The lower limit applies to the band edges.

5.3. Test Procedure

- 5.3.1. To set up the EUT as indicated in ANSI C63.10. The EUT was placed on the table which has 80 cm height to the ground and 40 cm distance to the conducting wall.
- 5.3.2. Power supplier of the EUT was connected to the AC mains through an Artificial Mains Network (A.M.N.).
- 5.3.3. The AC power supplies to all peripheral devices must be provided through line impedance stabilization network (L.I.S.N.)
- 5.3.4. Checking frequency range from 150kHz to 30 MHz and record the emission which does not have 20 dB below limit.

5.4. Test Results

Please refer to Appendix A.

6. RADIATED EMISSION

6.1. Block Diagram of Test Setup

6.1.1. Block Diagram of EUT

Indicated as section 3.10

6.1.2. Setup Diagram for 9kHz-30MHz

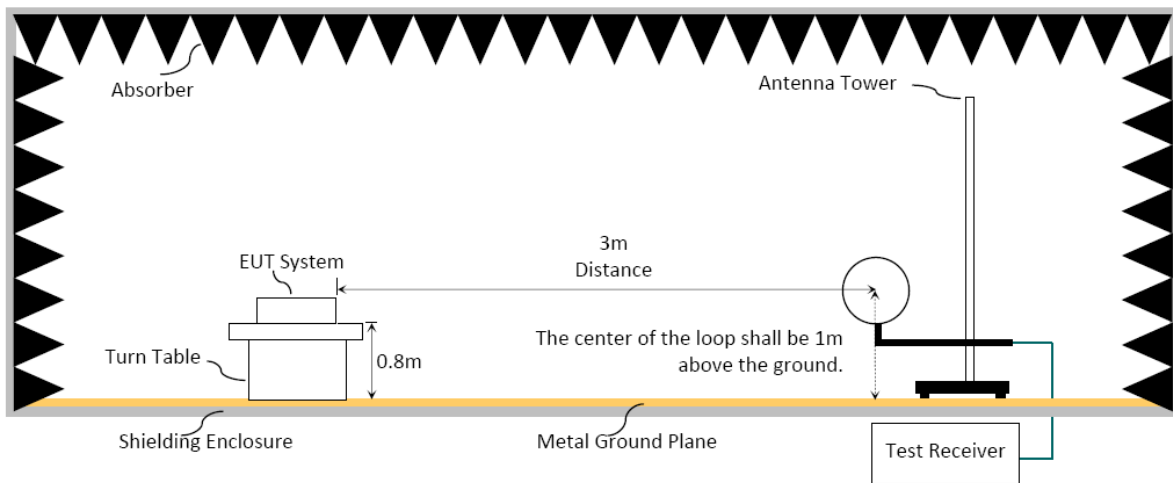

6.1.3. Setup Diagram for 30-1000MHz

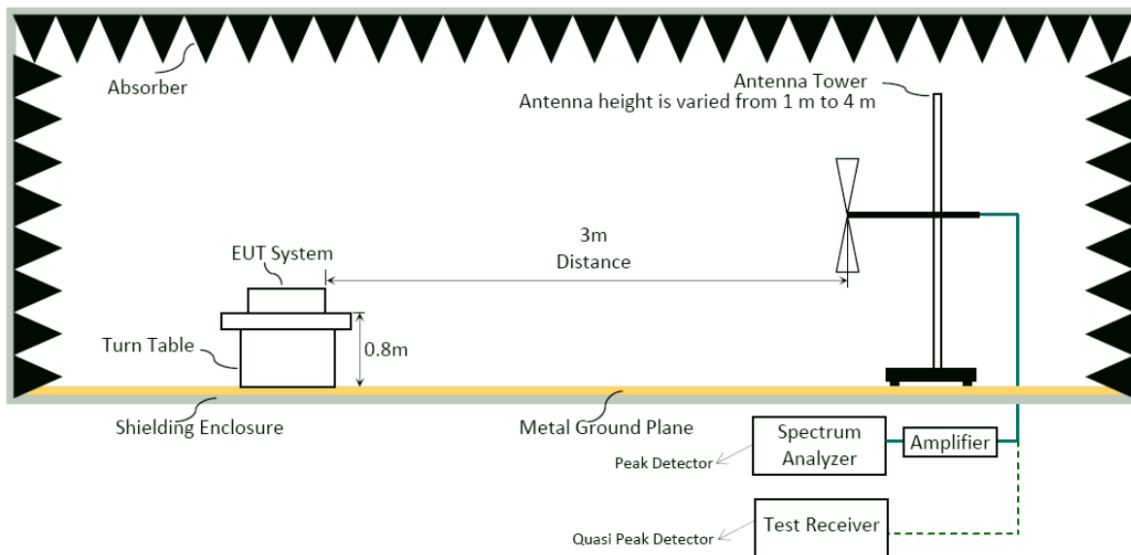

6.1.4. Setup Diagram for above 1GHz

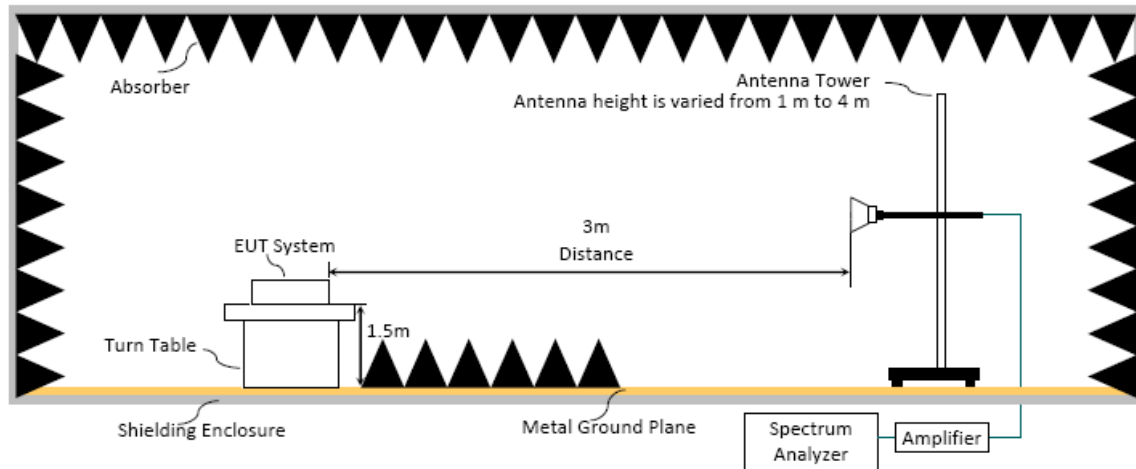

6.2. Radiated Emission Limits

Radiated emissions fall in restricted bands, as defined in Section 15.205 must be in compliance with the radiated emission limits specified in 15.209 as below.

6.2.1. General Limit

Frequency (MHz)	Distance(m)	Limits	
		dB μ V/m	μ V/m
0.009 - 0.490	300	67.6-20 log f(kHz)	2400/f kHz
0.490 - 1.705	30	87.6-20 log f(kHz)	24000/f kHz
1.705 - 30	30	29.5	30
30 - 88	3	40.0	100
88- 216	3	43.5	150
216- 960	3	46.0	200
Above 960	3	54.0	500
Above 1000	3	74.0 dB μ V/m (Peak) 54.0 dB μ V/m (Average)	

Remark : (1) dB μ V/m = 20 log (μ V/m)

- (2) The tighter limit applies to the edge between two frequency bands.
- (3) Distance refers to the distance in meters between the measuring instrument antenna and the closed point of any part of the device or system.
- (4) Fundamental and emission fall within operation band are exempted from this section.
- (5) Pursuant to ANSI C63.10: 6.6.4.3, if the maximized peak measured value complies with the average limit, then it is unnecessary to perform an average measurement.

6.2.2. Limit for non-restricted frequency above 1 GHz

Frequency Band (MHz)	E.I.R.P. Limit	Field Strength Limit at 3 m
5150 to 5250	-27 dBm	68.2 dB μ V/m
5250 to 5350		68.2 dB μ V/m
5470 to 5725		68.2 dB μ V/m

Note: Field Strength at 3 m = E.I.R.P. + 95.2 dB

Frequency Band (MHz)	Field Strength Limit at 3 m	
5725 to 5850	<input checked="" type="checkbox"/>	15.407(b)(4)(i) All emissions shall be limited to a level of 68.2 dB μ V/m at 75 MHz or more above or below the band edge increasing linearly to 105.2 dB μ V/m at 25 MHz above or below the band edge, and from 25 MHz above or below the band edge increasing linearly to a level of 110.8 dB μ V/m at 5 MHz above or below the band edge, and from 5 MHz above or below the band edge increasing linearly to a level of 122.2 dB μ V/m at the band edge.
	<input type="checkbox"/>	15.407(b)(4)(ii), compliance with the emission limits in § 15.247(d) shall be at least 30dB below that in the 100 kHz bandwidth within the band that contains the highest level of the desired power. Attenuation below the general limits specified in § 15.209(a) is not required. In addition, radiated emissions which fall in the restricted bands, as defined in § 15.205(a), must also comply with the radiated emission limits specified in § 15.209(a) (see § 15.205(c))

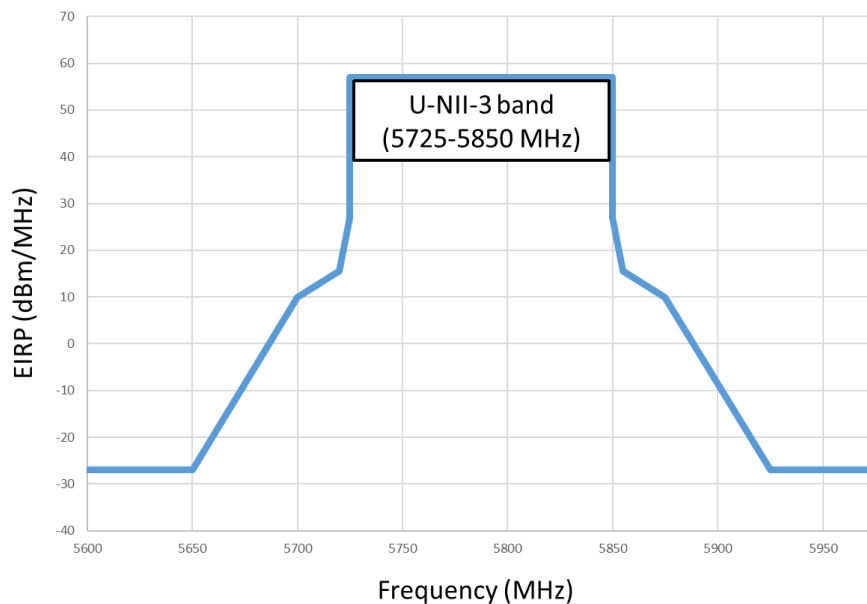

6.3. Test Procedure

Frequency Range 9kHz~30MHz:

The EUT setup on the turntable which has 0.8 m height to the ground. The turn table rotated 360 degrees and antenna fixed to 1 m to find the maximum emission level. In order to find the maximum emission, all of the interface cables were manipulated according to ANSI C63.10-2013 regulation.

- (1) RBW = 9kHz with peak and average detector.
- (2) Detector: average and peak (9kHz-490kHz)
Q.P. (490kHz-30MHz)

Frequency Range 30MHz ~ 40GHz:

The EUT setup on the turn table which has 80cm (for 30-1000MHz) and 1.5m (for above 1GHz) height to the ground. The turn table rotated 360 degrees and antenna varied from 1 m to 4 m to find the maximum emission level. Both horizontal and vertical polarization are required. In order to find the maximum emission, all of the interface cables were manipulated according to ANSI C63.10-2013 regulation.

Frequency below 1GHz:

Spectrum Analyzer is used for pre-testing with following setting:

- (1)RBW = 120kHz
- (2)VBW $\geq 3 \times$ RBW.
- (3)Detector = Peak.
- (4)Sweep time = auto.
- (5)Trace mode = max hold.
- (6)Allow sweeps to continue until the trace stabilizes.

Note 1: When peak-detected value is lower than limit that the measurement using the Q.P. detector is not required, otherwise using Q.P. for final measurement.

Note 2: When the radiated emissions limits are expressed in terms of the average value of the emissions, and pulsed operation is employed, the measurement field strength shall be determined by averaging over one complete pulse train, including blanking intervals, as long as the pulse train does not exceed 0.1 seconds.

Frequency above 1GHz to 10th harmonic(up to 40 GHz):

Peak Detector:

- (1)RBW = 1MHz
- (2)VBW $\geq 3 \times$ RBW.
- (3)Detector = Peak.
- (4)Sweep time = auto.
- (5)Trace mode = max hold.
- (6)Allow sweeps to continue until the trace stabilizes.

Note: When peak-detected value is lower than limit that the measurement using the average detector is not required, otherwise using average detector for final measurement.

Average Detector:

Option 1:

- (1) RBW = 1MHz
- (2) VBW ≥ 1/ T. (Duty Cycle < 98%, when duty cycle presented in section 3.7)
- (3) VBW = set VBW ≤ RBW / 100, but not less than 10Hz (Duty Cycle ≥ 98%, when duty cycle presented in section 3.7)

Mode	VBW Setting
802.11a	10Hz
802.11n-HT20	10Hz
802.11n-HT40	10Hz
802.11ac-VHT80	10Hz
802.11ac-VHT160	10Hz
802.11ax-HE20	10Hz
802.11ax-HE40	10Hz
802.11ax-HE80	10Hz
802.11ac-VHT160	10Hz
802.11ax-HE20 (RU Config 26)	10Hz
802.11ax-HE20 (RU Config 52)	10Hz
802.11ax-HE20 (RU Config 106)	10Hz
802.11ax-HE40 (RU Config 242)	10Hz
802.11ax-HE80 (RU Config 484)	10Hz
802.11ax-HE160 (RU Config 996)	10Hz

- (4) Detector = Peak.
- (5) Sweep time = auto.
- (6) Trace mode = max hold.
- (7) Allow sweeps to continue until the trace stabilizes.

Option 2:

Average Emission Level(dBμV/m)= Peak Emission Level(dBμV/m)+ DCCF(dB).

6.4. Measurement Result Explanation

Peak Emission Level(dBμV/m)=Antenna Factor(dB/m) + Cable Loss (dB)– Preamp Gain (dB)+ Reading(dBμV).

Average Emission Level(dBμV/m)= Antenna Factor(dB/m) + Cable Loss (dB)– Preamp Gain (dB)+ Reading(dBμV).

Average Emission Level(dBμV/m)= Peak Emission Level(dBμV/m)+ DCCF(dB)
 Duty Cycle Correction Factor (DCCF)(dB)= 20log(TX_{on}/TX_{on+off}) presented in section 3.7.

ERP(dBm)= Peak Emission Level(dBμV/m) -95.2dB-2.14dB

6.5. Test Results

Please refer to Appendix A.

7. EMISSION/OCCUPIED BANDWIDTH

7.1. Block Diagram of Test Setup

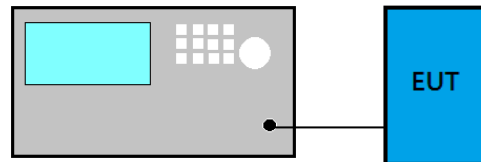

7.2. Specification Limits

Frequency Band (MHz)	Limit
5150 to 5250	Reference only
5250 to 5350	
5470 to 5725	
5725 to 5850	≥ 500kHz

7.3. Test Procedure

Following measurement procedure is reference to KDB 789033 D02 General UNII Test Procedures New Rules v02r01:

For Emission Bandwidth

- Applicable to all bands except to 5725 MHz- 5850 MHz
 - (1) Set RBW= 1% of the emission bandwidth
 - (2) Set VBW > RBW
 - (3) Detector = Peak
 - (4) Trace mode = max hold
 - (5) Setting channel bandwidth function x dB to -26 dB to record the final bandwidth.
- 5725 MHz- 5850 MHz
 - (1) Set RBW = 100 kHz.
 - (2) Set the video bandwidth (VBW) ≥ 3 × RBW.
 - (3) Detector = Peak.
 - (4) Trace mode = max hold.
 - (5) Sweep = auto couple.
 - (6) Allow the trace to stabilize.
 - (7) Setting channel bandwidth function x dB to -6 dB to record the final bandwidth.

For 99% Occupied Bandwidth

- (1) Set Span range 1.5~5 times the OBW
- (2) Set RBW close to 1% to 5% of OBW.
- (3) Set $VBW \geq 3 \times RBW$.
- (4) Detector = Peak.
- (5) Trace mode = Max hold
- (6) Sweep = Auto couple.
- (7) Allow the trace to stabilize.

7.4. Test Results

Please refer to Appendix A

8. MAXIMUM OUTPUT POWER

8.1. Block Diagram of Test Setup

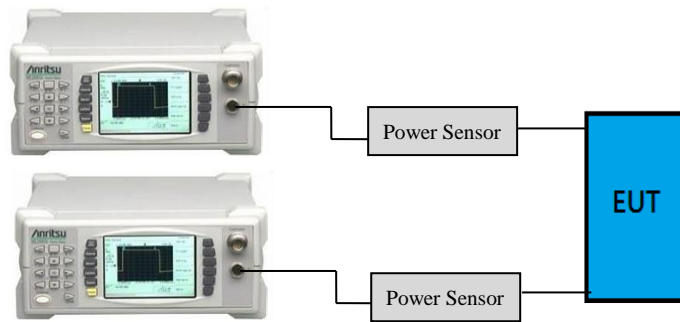

- For 802.11ac-VHT80/160, 802.11ax-HE160 modes only

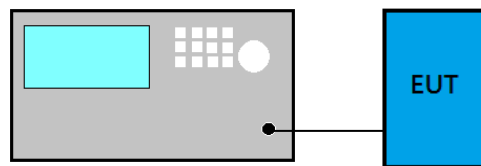

8.2. Specification Limits

Frequency Band (MHz)	Category	Limit
5150 to 5250	Outdoor Access Point	1 W(30 dBm)/ Max e.i.r.p. ≤125 mW(21 dBm) at any elevation angle above 30 degrees as measured from the horizon
	Fixed point-to-point Access Point	1 W(30 dBm)
	Indoor Access Point	1 W(30 dBm)
	Mobile and Portable client device	250 mW(24 dBm)
5250 to 5350	N/A	250 mW or 11 dBm + 10 log B ^{Note1}
5470 to 5725		250 mW or 11 dBm + 10 log B ^{Note1}
5725 to 5850		1 W(30 dBm)

Note 1: B is the 26 dB emission bandwidth, which presented in section 7 and appendix A.1.

8.3. Test Procedure

Following measurement procedure is reference to KDB 789033 D02 General UNII Test Procedures New Rules v02r01:

■ **Method AVGPM (Measurement using an RF average power meter):**

EUT is connected to power sensor and record the maximum average output power and duty cycle factor is added when duty cycle presented in section 3.7 is < 98%.

■ **Method AVGSA-2 (Spectrum channel power) for 802.11ac-VHT80/160, 802.11ax-HE80/160 modes only**

- (1) Set span to at least 1.5 times the OBW
- (2) Set RBW = 1 MHz
- (3) Set the video bandwidth (VBW) \geq 3 MHz.
- (4) Detector = RMS.
- (5) Trace mode = trace average at least 100 traces
- (6) Sweep = auto couple.
- (7) Compute power by integrating the spectrum across the OBW of the signal using the instrument's band power measurement function with band limits set equal to the OBW band edges.
- (8) Duty cycle factor is added when duty cycle presented in section 3.7 is < 98%.

8.4. Test Results

Please refer to Appendix A

9. POWER SPECTRAL DENSITY

9.1. Block Diagram of Test Setup

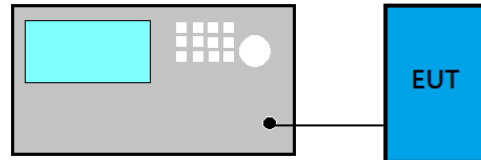

9.2. Specification Limits

Frequency Band (MHz)	Category	Limit
5150 to 5250	Outdoor Access Point	17dBm/MHz
	Fixed point-to-point Access Point	
	Indoor Access Point	
	Mobile and Portable client device	11 dBm/MHz
5250 to 5350	N/A	11 dBm/MHz
5470 to 5725		11 dBm/MHz
5725 to 5850		30dBm/500 kHz

9.3. Test Procedure

Following measurement procedure is reference to KDB 789033 D02 General UNII Test Procedures New Rules v02r01:

■ Method AVGSA-2

- (1) Set span to encompass the EBW (or 99% OBW) of the signal.
- (2) Set RBW = 1 MHz (Applicable to all bands except to 5725 MHz- 5850 MHz)/
Set RBW=100 KHz(when EUT operate at 5725 MHz- 5850 MHz)
- (3) Set the video bandwidth (VBW) ≥ 3 RBW.
- (4) Detector = RMS.
- (5) Trace mode = trace average at least 100 traces
- (6) Sweep = auto couple.
- (7) Use peak search function to find out the maximum power density.
- (8) Duty cycle factor is added when duty cycle presented in section 3.7 is $< 98\%$.
- (9) Offset BWCF (7dB) when EUT operate at 5725 MHz – 5850 MHz.

9.4. Test Results

Please refer to Appendix A

10. FREQUENCY STABILITY

10.1. Block Diagram of Test Setup

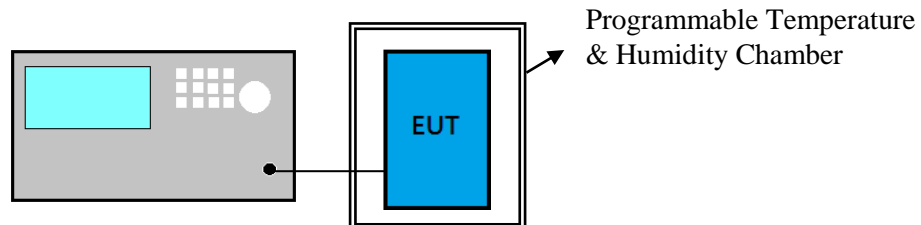

10.2. Specification Limits

NONE

10.3. Test Procedure

- (1) Frequency: Test frequency.
- (2) Span: enough to cover the complete power envelope
- (3) RBW: 1MHz(modulation ON) ; 10KHz(CW)
- (4) VBW: 1MHz(modulation ON) ; 10KHz(CW)
- (5) Detector Mode: Positive Peak
- (6) Indication mode: Max hold
- (7) Find the peak frequency and take calculate by the formula:
(Measurement Value-declaration frequency)/ declaration frequency)

10.4. Test Results

Please refer to Appendix A



11.DEVIATION TO TEST SPECIFICATIONS

【NONE】



APPENDIX A

TEST DATA AND PLOTS

(Model: 16Z90SP)



*Audix Technology Corp.
No. 491, Zhongfu Rd., Linkou Dist.,
New Taipei City 244, Taiwan*

*Tel: +886 2 26099301
Fax: +886 2 26099303*

APPENDIX B

TEST PHOTOGRAPHS

(Model: 16Z90SP)