

客戶名稱 : **LG 16Z90SP**
CUSTOMER

Document No.: _____
Approval Sheet Rev.: P0
Spec. Rev. : P0

承 認 書

APPROVAL SHEET

產品品名/Product Model No. : **WA-P-LBLB-04-111**

客戶料號/Customer No. : **EAA65985601**

專案名稱/Project Name: **16Z90SP**

發行日期/ Issue Date : **2023/08/15**

承認日期/ Approved Date : _____

Approved by customer: (signing or stamping here)



WA-P-LBLB-04-111 Specification

1. Explanation of part number :

WA - P - LBLB - 04 - 111
 (1) (2) (3) (4) (5)

- (1) Product Type : Wireless Antenna
- (2) P: PCB+Cable
- (3) Frequency : 2400~2500MHz&5100~5800MHz&5925~7125MHz
- (4) Coaxial Cable Type : With ϕ 0.81 Main Black / AUX Gray
- (5) Suffix : 111

2. Storage Condition:

Temperature -40 to +70°C
 Humidity 20 to 65 %RH

3. Operating Condition:

Temperature -40 to +70°C
 Humidity 10 to 85 %RH

4. Electrical Specification :

Those specifications were specially defined for LG 16Z90SP WIFI model, and all characteristics were measured under the model's handset testing jig .

4-1. Frequency Band:

Frequency Band	MHz
WIFI\BT	2400~2500 & 5100~5800 & 5925~7125

UNLESS OTHER SPECIFIED TOLERANCES ON :		 佳邦科技股份有限公司 INPAQ TECHNOLOGY CO., LTD.	
X = ± X.X = ± X.XX = ±	ANGLES = ± HOLEDIA = ±		
SCALE :	UNIT : mm	THIS DRAWINGS AND SPECIFICATIONS ARE THE PROPERTY OF INPAQ TECHNOLOGY CO.,LTD.AND SHALL NOT BE REPRODUCED OR USED AS THE BASIS FOR THE MANUFACTURE OR SALE OF APPARATUS OR DEVICES WITHOUT PERMISSION	
DRAWN BY: 毕岩	CHECKED BY: 张涛		
DESIGNED BY : 张翔	APPROVED BY : 徐克文		
TITLE : WA-P-LBLB-04-111 Specification		DOCUMENT NO.	PAGE REV. P0

4-2. Impedance

50 ohm nominal

4-3. Matching circuit

None

4-4. VSWR

4-4.1 Measuring Method

1. A 50Ω coaxial cable is connected to the antenna. Then this cable is connected

to a network analyzer to measure the VSWR

2. Keeping this jig away from metal at least 20cm

4-4.2 Measurement frequency points and VSWR value

VSWR	Frequency (Unit MHz)	Spec	1
Main Antenna	2400	≤3.0	1.4
	2500	≤3.0	1.3
	5150	≤3.0	1.7
	7125	≤3.0	1.4
	Judgement		
Aux Antenna	2400	≤3.0	1.8
	2500	≤3.0	1.5
	5150	≤3.0	1.5
	7125	≤3.0	2.1
	Judgement		

Main Antenna-1

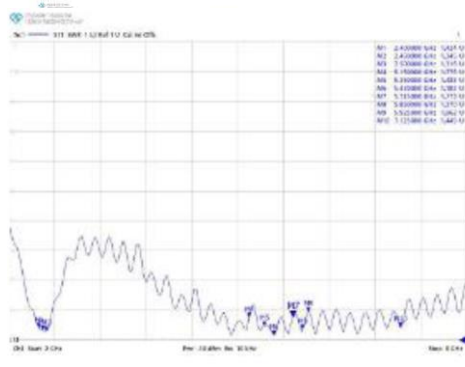

UNLESS OTHER SPECIFIED TOLERANCES ON :

X = ±

X.X = ±

X.XX = ±

ANGLES = ±

HOLEDIA = ±



佳邦科技股份有限公司

AUX Antenna-3

INPAQ TECHNOLOGY CO., LTD.

SCALE :

UNIT : mm

DRAWN BY: 毕岩

CHECKED BY: 张涛

DESIGNED BY: 张翔

APPROVED BY: 徐克文

THIS DRAWINGS AND SPECIFICATIONS ARE THE PROPERTY OF INPAQ TECHNOLOGY CO.,LTD.AND SHALL NOT BE REPRODUCED OR USED AS THE BASIS FOR THE MANUFACTURE OR SALE OF APPARATUS OR DEVICES WITHOUT PERMISSION

TITLE : WA-P-LBLB-04-111 Specification

DOCUMENT
NO.

PAGE REV.
P0

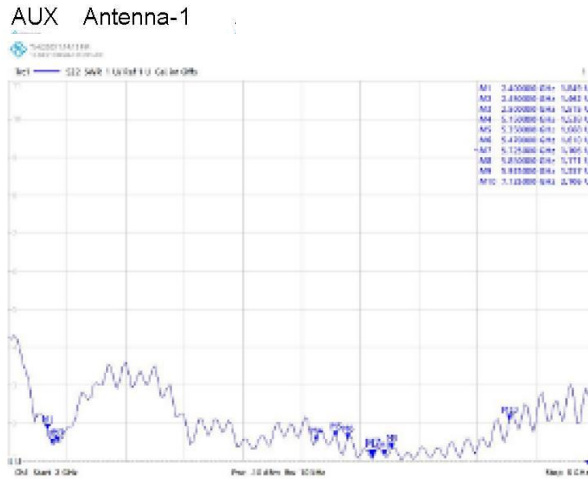

4-5. Efficiency and Gain

4-5.1 Measuring equipment

Measuring instrument:

Microwave chamber, Network analyzer, and standard antenna.

Instructions for microwave chamber:

This is a microwave chamber set up by our company in Suzhou. This microwave chamber belongs to a set of near-field measurement system. The size of the chamber is 2.95M * 3M * 3M.



RayZone2800 Test Setup

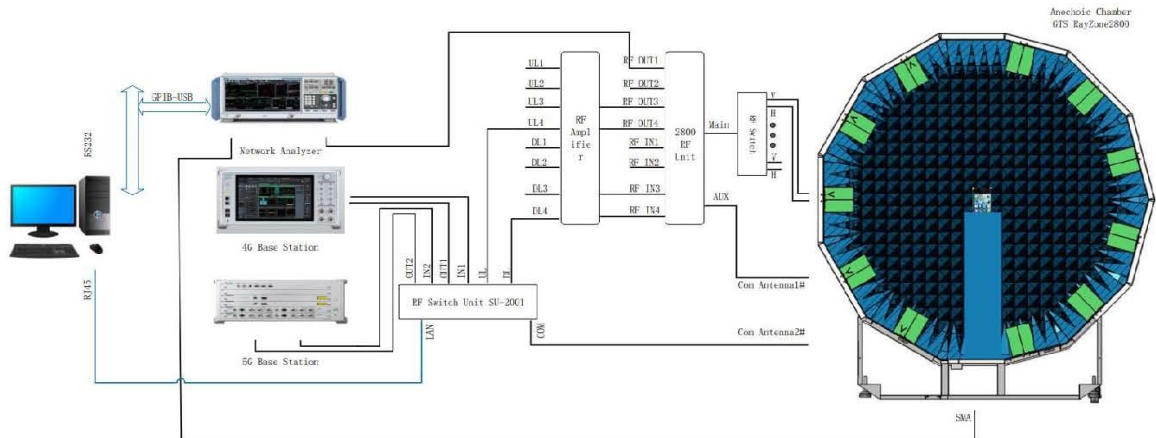

The microwave chamber, shown above, using a unique multi-probe technique, The aim is to reduce the measurement time of the whole measurement system. The

UNLESS OTHER SPECIFIED TOLERANCES ON :		 佳邦科技股份有限公司 INPAQ TECHNOLOGY CO., LTD.	
X = ±	X.X = ± X.XX = ±		
ANGLES = ±	HOLEDIA = ±	THIS DRAWINGS AND SPECIFICATIONS ARE THE PROPERTY OF INPAQ TECHNOLOGY CO.,LTD.AND SHALL NOT BE REPRODUCED OR USED AS THE BASIS FOR THE MANUFACTURE OR SALE OF APPARATUS OR DEVICES WITHOUT PERMISSION	
SCALE :	UNIT : mm		
DRAWN BY: 毕岩	CHECKED BY: 张涛		
DESIGNED BY: 张翔	APPROVED BY: 徐克文		
TITLE : WA-P-LBLB-04-111 Specification		DOCUMENT NO.	PAGE REV. P0

measuring system use multi-probe array instead of single probe to scan the measured surface of the antenna under test, a single probe has the capability of measuring orthogonal polarization amplitude and phase, it also has a wide frequency range, the corresponding multi-probe array is switched quickly by electronic switch, greatly improved the measurement efficiency.

The probe model: MA186960A(400MHz~7.5GHz) . Because of its capability of broadband frequency and the orthogonal polarization function, the number of probes needed to be equipped with the system is reduced; The small size of the probe reduces the coupling between the probes, make it is possible to insert probes of other frequency bands between probes, then a single system can support a wider frequency range

4-5.2 Efficiency and Gain

Antenna gain is marked (dBi) and is based on STANDARD HORN antenna. The data shows Peak Gain and Average Gain.

4-5-2-1 Electrical specification

Frequency (MHz)	Average Efficiency (%)
2400~2500	>30
5100~5825	>30
5925~7125	>30

4-5.2-2 Efficiency and Gain Test Data

Frequency (MHz)	Main Antenna-1		
	Efficiency (%)	Gain w/ cable loss (dBi)	Peak Gain w/ cable loss (dBi)
2.4GHz (2400~2500MHz)	-2.8	52.1	2.2
5.2&5.3GHz (5150~5350MHz)	-5.0	31.4	1.8
5.5GHz (5470~5725MHz)	-4.0	39.9	2.9
5.8GHz (5725~5850MHz)	-4.2	38.0	2.3
6.2GHz (5925~6425MHz)	-2.9	51.0	3.3

Frequency (MHz)	Main Antenna-1		
	Efficiency (%)	Gain w/ cable loss (dBi)	Peak Gain w/ cable loss (dBi)
6.5GHz (6425~6525MHz)	-3.5	45.1	2.7
6.7GHz (6525~6875MHz)	-4.7	33.8	1.3
6.9GHz (6875~7125MHz)	-4.1	39.2	1.4

UNLESS OTHER SPECIFIED TOLERANCES ON :

X = ± X.X = ± X.XX = ±

ANGLES = ± HOLEDIA = ±

SCALE : UNIT : mm

DRAWN BY: 毕岩 CHECKED BY: 张涛

DESIGNED BY: 张翔 APPROVED BY: 徐克文

TITLE : WA-P-LBLB-04-111 Specification



佳邦科技股份有限公司
INPAQ TECHNOLOGY CO., LTD.

THIS DRAWINGS AND SPECIFICATIONS ARE THE PROPERTY OF INPAQ TECHNOLOGY CO.,LTD.AND SHALL NOT BE REPRODUCED OR USED AS THE BASIS FOR THE MANUFACTURE OR SALE OF APPARATUS OR DEVICES WITHOUT PERMISSION

DOCUMENT NO.

PAGE REV.
P0

Frequency (MHz)	Aux Antenna-1		
	Efficiency (%)	Gain w/ cable loss (dBi)	Peak Gain w/ cable loss (dBi)
2.4GHz (2400-2500MHz)	-2.5	55.7	2.1
5.2&5.3GHz (5150-5350MHz)	-4.4	36.6	1.8
5.5GHz (5470-5725MHz)	-4.9	32.5	2.8
5.8GHz (5725-5850MHz)	-3.9	40.9	3.0
6.2GHz (5925-6425MHz)	-3.6	43.9	1.8
6.5GHz (6425-6525MHz)	-4.1	38.9	2.5
6.7GHz (6525-6875MHz)	-4.3	37.1	3.3
6.9GHz (6875-7125MHz)	-3.6	43.8	2.9

4-5.2-3 Antenna 3D Radiation Pattern

Main Antenna-1

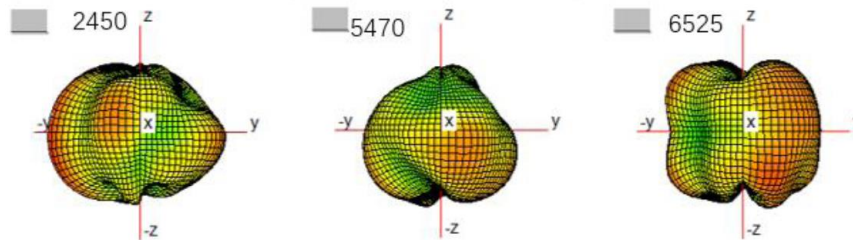

AUX Antenna-1

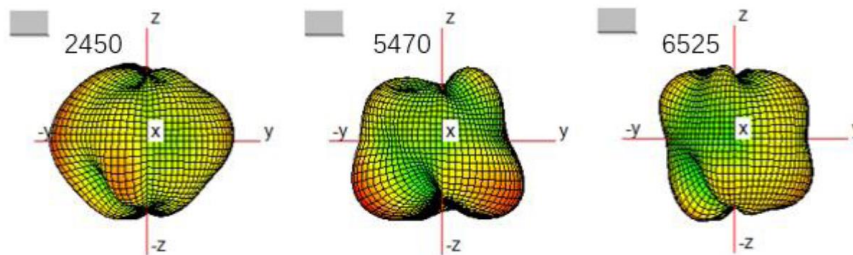

UNLESS OTHER SPECIFIED TOLERANCES ON :

X = ± X.X = ± X.XX = ±

ANGLES = ± HOLEDIA = ±



佳邦科技股份有限公司

INPAQ TECHNOLOGY CO., LTD.

SCALE :

UNIT : mm

DRAWN BY: 毕岩

CHECKED BY: 张涛

DESIGNED BY: 张翔

APPROVED BY: 徐克文

THIS DRAWINGS AND SPECIFICATIONS ARE THE PROPERTY OF INPAQ TECHNOLOGY CO.,LTD.AND SHALL NOT BE REPRODUCED OR USED AS THE BASIS FOR THE MANUFACTURE OR SALE OF APPARATUS OR DEVICES WITHOUT PERMISSION

TITLE : WA-P-LBLB-04-111 Specification

DOCUMENT NO.

PAGE REV.
P0

Mechanical Configuration:

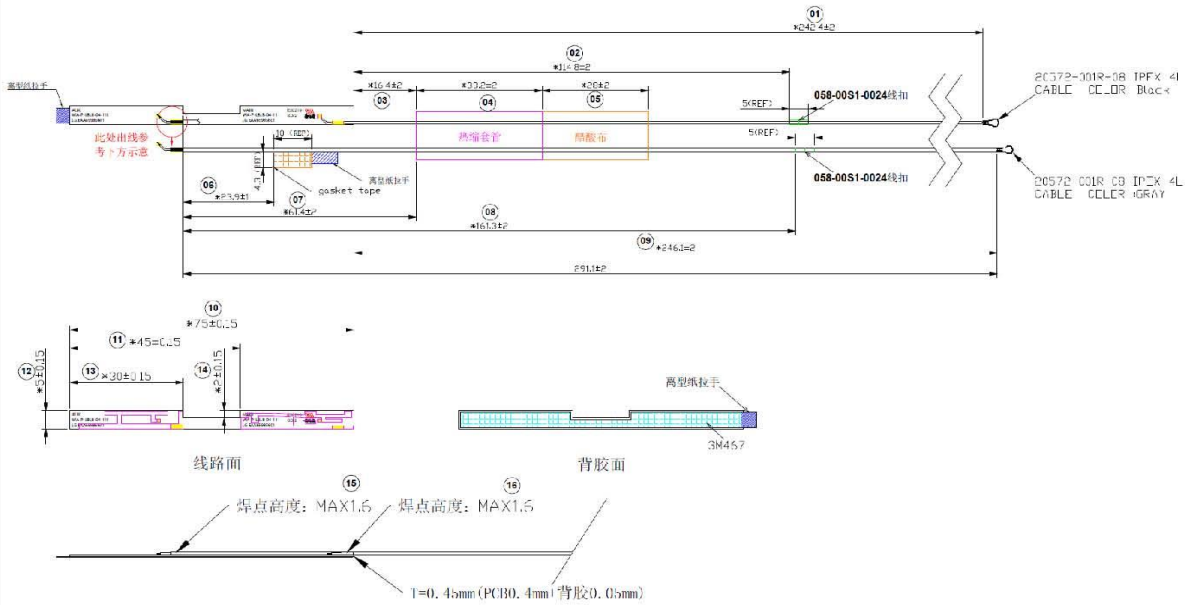

Material list :

Item	Description	Material	Quantity
1	PCB	PCB T0.4 WA-P-LBLB-04-111	1
2	Acetate tape	Acetate tape 18x10mm, T0.12mm	1
3	Shrink Tube	Shrink Tube black, ϕ 1.5 x33.2mm	1
4	Cable black	Cable 0.81 black	1
5	Cable gray	Cable 0.81 gray	1
6	Connector	I-PEX MHF 4L for 0.81, 20572	2
7	TAP	TAP 3M467 74x4mm	1
8	Clamp	Clamp 0.81 5mm	2
9	Acetate tape	醋酸布 28x10x0.08	1

6. UL File No:

ITEM	DESCRIPTION	SUPPLIER	UL File No
1	PCB	HA0129	E202191
2	CABLE	HA0008	E318898
		HA0053	E464731

UNLESS OTHER SPECIFIED TOLERANCES ON :		 佳邦科技股份有限公司 INPAQ TECHNOLOGY CO., LTD.
X = ±	X.X = ± X.XX = ±	
ANGLES = ±		THIS DRAWINGS AND SPECIFICATIONS ARE THE PROPERTY OF INPAQ TECHNOLOGY CO.,LTD.AND SHALL NOT BE REPRODUCED OR USED AS THE BASIS FOR THE MANUFACTURE OR SALE OF APPARATUS OR DEVICES WITHOUT PERMISSION
SCALE :		
UNIT : mm		
DRAWN BY: 毕岩	CHECKED BY: 张涛	
DESIGNED BY: 张翔	APPROVED BY: 徐克文	
TITLE : WA-P-LBLB-04-111 Specification		DOCUMENT NO.
		PAGE REV. P0