

FCC 15.247 & RSS-247 2.4GHz Test Report

for

LG Electronics Inc.

**222, LG-ro, Jinwi-myeon Pyeongtaek-Si, Gyeonggi-Do,
17709 Republic of Korea**

Product Name : Notebook Computer
Model Name : (1)16Z90RS (2)16ZD90RS
Brand : LG
FCC ID : BEJNT-16Z90RS
IC : 2703H-16Z90RS

**Prepared by: : AUDIX Technology Corporation,
EMC Department**



The test report is based on a single evaluation of one sample of the above-mentioned products. It does not imply an assessment of the whole production and does not permit the use of the test lab logo.

TABLE OF CONTENTS

Description	Page
TEST REPORT	4
1. REVISION RECORD OF TEST REPORT	5
2. SUMMARY OF TEST RESULTS	6
3. GENERAL INFORMATION	7
3.1. Description of Application	7
3.2. Description of EUT	8
3.3. Reference Test Guidance	9
3.4. Antenna Information	9
3.5. EUT Specifications Assessed in Current Report	10
3.6. Description of Key Components	11
3.7. Test Configuration	13
3.8. Output Power Setting	14
3.9. Tested Supporting System List	14
3.10. Setup Configuration	15
3.11. Operating Condition of EUT	15
3.12. Description of Test Facility	15
3.13. Measurement Uncertainty	16
4. MEASUREMENT EQUIPMENT LIST	18
4.1. Conducted Emission Measurement	18
4.2. Radiated Emission Measurement	19
4.3. RF Conducted Measurement	19
5. CONDUCTED EMISSION	20
5.1. Block Diagram of Test Setup	20
5.2. Conducted Emission Limit	20
5.3. Test Procedure	20
5.4. Test Results	21
6. RADIATED EMISSION	22
6.1. Block Diagram of Test Setup	22
6.2. Radiated Emission Limits	23
6.3. Test Procedure	24
6.4. Measurement Result Explanation	25
6.5. Test Results	25
7. 20dB/OCCUPIED BANDWIDTH	26
7.1. Block Diagram of Test Setup	26
7.2. Specification Limits	26
7.3. Test Procedure	26
7.4. Test Results	26
8. CARRIER FREQUENCY SEPARATION	27
8.1. Block Diagram of Test Setup	27
8.2. Specification Limits	27
8.3. Test Procedure	27
8.4. Test Results	27
9. TIME OF OCCUPANCY	28
9.1. Block Diagram of Test Setup	28



Audix Technology Corp.
No. 491, Zhongfu Rd., Linkou Dist.,
New Taipei City 244, Taiwan

Tel: +886 2 26099301
Fax: +886 2 26099303

9.2. Specification Limits.....	28
9.3. Test Procedure.....	28
9.4. Test Results	28
10. NUMBER OF HOPPING CHANNELS	29
10.1. Block Diagram of Test Setup	29
10.2. Specification Limits.....	29
10.3. Test Procedure	29
10.4. Test Results	29
11. MAXIMUM PEAK OUTPUT POWER	30
11.1. Block Diagram of Test Setup	30
11.2. Specification Limits.....	30
11.3. Test Procedure	30
11.4. Test Results	30
12. EMISSION LIMITATIONS	31
12.1. Block Diagram of Test Setup	31
12.2. Specification Limits.....	31
12.3. Test Procedure	31
12.4. Test Results	31
13. DEVIATION TO TEST SPECIFICATIONS	32

APPENDIX A TEST DATA AND PLOTS
APPENDIX B TEST PHOTOGRAPHS



Audix Technology Corp.
No. 491, Zhongfu Rd., Linkou Dist.,
New Taipei City 244, Taiwan

Tel: +886 2 26099301
Fax: +886 2 26099303

TEST REPORT

Applicant : LG Electronics Inc.
Manufacturer : LG Electronics Inc.
Factory : LG Electronics Nanjing New Technology Co., Ltd.
EUT Description
(1) Product : Notebook Computer
(2) Model : (1)16Z90RS (2)16ZD90RS
(3) Brand : LG
(4) Power Supply: DC 20V, 3.25A

Applicable Standards:

Title 47 CFR FCC Part 15 Subpart C
RSS-Gen (Issue 5), Amendment 2, February 2021
RSS-247 (Issue 2), February 2017

Audix Technology Corp. tested the equipment mentioned in accordance with the requirements set forth in the above standards. Test results indicate that the equipment tested is capable of demonstrating compliance with the requirements as documented within this report.

Audix Technology Corp. does not assume responsibility for any conclusions and generalizations drawn from the test results with regard to other specimens and samples.

Date of Report: 2022. 12. 02

Reviewed by:

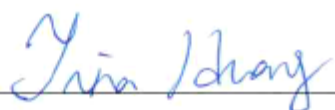

(Tina Huang/Section Manager)

Approved by:



(Johnny Hsueh/Section Manager)



Audix Technology Corp.
No. 491, Zhongfu Rd., Linkou Dist.,
New Taipei City 244, Taiwan

Tel: +886 2 26099301
Fax: +886 2 26099303

1. REVISION RECORD OF TEST REPORT

Edition No	Issued Date	Revision Summary	Report Number
0	2022. 12. 02	Original Report	EM-F220801

2. SUMMARY OF TEST RESULTS

Rule		Description	Results
FCC	IC		
15.207	RSS-Gen §8.8	Conducted Emission	PASS
15.247(d)/15.205	RSS-Gen §8.9 RSS-247 §5.5	Radiated Band Edge and Radiated Spurious Emission	PASS
15.247(a)(1)	RSS-247 §5.1(2)	20dB/Occupied Bandwidth	PASS
15.247(a)(1)	RSS-247 §5.1(2)	Carrier Frequency Separation	PASS
15.247(a)(1)(iii)	RSS-247 §5.1(4)	Time of Occupancy	PASS
15.247(a)(1)(iii)	RSS-247 §5.1(4)	Number of Hopping Channels	PASS
15.247(b)(1)	RSS-247 §5.1(2)	Maximum Peak Output Power	PASS
15.247(d)	RSS-247 §5.5	Conducted Band Edges and Conducted Spurious Emission	PASS
15.203	---	Antenna Requirement	Compliance

Note: The uncertainties value is not used in determining the result.

3. GENERAL INFORMATION

3.1. Description of Application

Applicant	LG Electronics Inc. 222, LG-ro, Jinwi-myeon Pyeongtaek-Si, Gyeonggi-Do, 17709 Republic of Korea
Manufacturer	LG Electronics Inc. 222, LG-ro, Jinwi-myeon Pyeongtaek-Si, Gyeonggi-Do, 17709 Republic of Korea
Factory	LG Electronics Nanjing New Technology Co., Ltd. No.346, Yaoxin Road, Economic & Technical Development Zone, Nanjing, China.
Product	Notebook Computer
Model	(1)16Z90RS (2)16ZD90RS The difference between all models is different in the sales customers.
Brand	LG

3.2. Description of EUT

Test Model	16Z90RS			
Serial Number	N/A			
Power Rating	DC 20V, 3.25A			
Software Version	XY (X, Y can be 0 to 9 for different SW version not influence RF parameter)			
RF Features	WLAN: 802.11 a/b/g/n/ac/ax Bluetooth: BT and BLE (BT 5.1)			
Transmit Type	2.4 GHz			
	802.11b		1T1R	
	802.11g		1T1R	
	802.11n-HT20		2T2R	
	802.11n-HT40		2T2R	
	802.11ax-HE20		2T2R	
	802.11ax-HE40		2T2R	
	BT/BLE		1T1R	
	U-NII Bands			
	802.11a		1T1R	
	802.11n-HT20/802.11ac-VHT20/802.11ax-HE20		2T2R	
	802.11n-HT40/802.11ac-VHT40/802.11ax-HE40		2T2R	
	802.11ac-VHT80/802.11ax-HE80		2T2R	
	802.11ac-VHT160/802.11ax-HE160		2T2R	
	The MIMO is uncorrelated and supported SDM (Spatial Division Multiplexing) mode only. This radio device doesn't support beamforming and Cyclic Delay Diversity (CDD).			
	Sample Status	Trial sample		
	Test Sample	Sample No.	Test Item	Firmware
02		AC Conduction, RSE, Output Power	N/A	
Date of Receipt	2022. 10. 13			
Date of Test	2022. 10. 26 ~ 11. 30			
Interface Ports of EUT	<ul style="list-style-type: none"> • One Micro SD Card Slot • One USB 3.2 Port • Two USB Type C Port • One Earphone Port 			
Accessories Supplied	<ul style="list-style-type: none"> • AC Adapter • USB C Cable • LAN Gender 			

3.3. Reference Test Guidance

ANSI C63.10:2013

3.4. Antenna Information

No.	Antenna Part Number	Manufacture	Antenna Type	Frequency (MHz)	Gain(dBi)		Directional Gain ^{Note1 & 2}
					Main	AUX	
1.	WA-P-LELE-04-035	INPAQ	Mono-Pole	2400	2.8	1.8	2.33
				2450	3.3	1.1	2.34
				2500	3.8	1.4	2.76
				5150	1.8	0.2	1.07
				5250	2.0	5.8	4.30
				5470	1.9	0.9	1.43
				5850	1.1	1.5	1.30
				5925	2.9	2.9	2.90
				6425	0.7	1.4	1.06
				6825	0.3	2.8	1.73
			7125	-3.4	1.0	-0.67	

According to KDB 662911 D01 d) ii), transmit signals are completely uncorrelated, then

$$\text{Directional gain} = 10 \log[(10^{G1/10} + 10^{G2/10} + \dots + 10^{GN/10})/N_{\text{ANT}}] \text{ dBi}$$

Note 1. WLAN 2.4GHz: Directional gain =

$$2400\text{MHz: Directional gain} = 10 \log[(10^{2.8/10} + 10^{1.8/10})/2] = 2.33\text{dBi}$$

$$2450\text{MHz: Directional gain} = 10 \log[(10^{3.3/10} + 10^{1.1/10})/2] = 2.34\text{dBi}$$

$$2500\text{MHz: Directional gain} = 10 \log[(10^{3.8/10} + 10^{1.4/10})/2] = 2.76\text{dBi}$$

Note 2. WLAN 5G/6GHz: Directional gain =

$$5150\text{MHz: Directional gain} = 10 \log[(10^{1.8/10} + 10^{0.2/10})/2] = 1.07\text{dBi}$$

$$5250\text{MHz: Directional gain} = 10 \log[(10^{2.0/10} + 10^{5.8/10})/2] = 4.30\text{dBi}$$

$$5470\text{MHz: Directional gain} = 10 \log[(10^{1.9/10} + 10^{0.9/10})/2] = 1.43\text{dBi}$$

$$5850\text{MHz: Directional gain} = 10 \log[(10^{1.1/10} + 10^{1.5/10})/2] = 1.30\text{dBi}$$

$$5925\text{MHz: Directional gain} = 10 \log[(10^{2.9/10} + 10^{2.9/10})/2] = 2.90\text{dBi}$$

$$6425\text{MHz: Directional gain} = 10 \log[(10^{0.7/10} + 10^{1.4/10})/2] = 1.06\text{dBi}$$

$$6825\text{MHz: Directional gain} = 10 \log[(10^{0.3/10} + 10^{2.8/10})/2] = 1.73\text{dBi}$$

$$7125\text{MHz: Directional gain} = 10 \log[(10^{-3.4/10} + 10^{1.0/10})/2] = -0.67\text{dBi}$$

We chose the antenna gain corresponding to the frequency listed on the table which is closer to center frequency of WLAN/BT.

3.5. EUT Specifications Assessed in Current Report

Mode	Fundamental Range (MHz)	Channel Number	Modulation	Data Rate (Mbps)
Bluetooth	2402-2480	79	FHSS (GFSK, $\pi/4$ DQPSK, 8-DPSK)	1/2/3

Channel List							
Channel Number	Frequency (MHz)	Channel Number	Frequency (MHz)	Channel Number	Frequency (MHz)	Channel Number	Frequency (MHz)
00	2402	20	2422	40	2442	60	2462
01	2403	21	2423	41	2443	61	2463
02	2404	22	2424	42	2444	62	2464
03	2405	23	2425	43	2445	63	2465
04	2406	24	2426	44	2446	64	2466
05	2407	25	2427	45	2447	65	2467
06	2408	26	2428	46	2448	66	2468
07	2409	27	2429	47	2449	67	2469
08	2410	28	2430	48	2450	68	2470
09	2411	29	2431	49	2451	69	2471
10	2412	30	2432	50	2452	70	2472
11	2413	31	2433	51	2453	71	2473
12	2414	32	2434	52	2454	72	2474
13	2415	33	2435	53	2455	73	2475
14	2416	34	2436	54	2456	74	2476
15	2417	35	2437	55	2457	75	2477
16	2418	36	2438	56	2458	76	2478
17	2419	37	2439	57	2459	77	2479
18	2420	38	2440	58	2460	78	2480
19	2421	39	2441	59	2461		

3.6. Description of Key Components

3.6.1. For the All Component Lists

Item	Supplier	Model / Type	Character
System	Microsoft	Win 10	---
		Win 10 Pro	
		Win 11	
Main Board	LG	1XZ90RS MAIN B/D PCB	Manufacturer: #1 Hannstar Board Tech (Jiang Yin) Corp., Ltd. #2 Elec&Eltek Company (MCO) Limited.
WLAN SUB Board	LG	16Z90RS SUB B/D	Manufacturer: #1 Hannstar Board Tech (Jiang Yin) Corp., Ltd. #2 Jiang Su Hua Shen Electronic co., ltd (HXF) #3 Elec&Eltek Company (MCO) Limited.
CPU (Socket: BGA1744)	Intel	i7-1360P	2.2GHz
		i5-1340P	1.9GHz
16" LCD Panel	Samsung	ATNA60BX02-0	Resolution: 3200*2000/120Hz(WQHD)
Storage (SSD)	SK hynix	---	256GB
		---	512GB
		---	1TB
		---	2TB
	Samsung	---	128GB
		---	256GB
		---	512GB
		---	1TB
		---	2TB
		---	2TB
Memory (RAM)	Samsung	---	16GB LPDDR5x(On Board)
		---	8GB LPDDR5x(On Board)
		---	32GB LPDDR5x(On Board)
	SK Hynix	---	16GB LPDDR5x(On Board)
		---	8GB LPDDR5x(On Board)
		---	32GB LPDDR5x(On Board)
Battery Pack	LG	LBV7227E	80Wh with GM M/B DC 7.74V, 80Wh
WLAN Combo Card	Intel	AX211D2W	WLAN and BT, 2x2 PCIe M.2 1216 SD adapter card FCC ID: PD9AX211D2 IC: 1000M-AX211D2
WLAN Combo Antenna	LG (INPAQ)	WA-P-LELE-04-035	PCB, Mono-pole Type Main: Black, Aux: Gray

Item	Supplier	Model / Type	Character	
Touch Pad	Taifang	TF100AP02002	---	
Keyboard	TIC	KT0120B8	---	
	LITE ON	SN8B01	---	
	LY	990-LPE	---	
Web Camera	Chicony	CKFLF26(2Mic)	---	
	Luxvisions	1BF225N3(2Mic)	---	
LAN Gender (Type C to LAN)	SUZHOU MEC ELECTRONICS	80-5946-111	(White) 10/100 Megabit Ethernet	
		80-5946-230	(White) 10/100/1000 Megabit Ethernet	
	ARIN TECH CO. LTD	GD-08MF-36-WH-LP10	(White) 10/100 Megabit Ethernet	
		GD-08MF-36-WH-LP12	(White) 10/100/1000 Megabit Ethernet	
	Type C to LAN: Shielded, Undetached, 0.12m			
	HUIZHOU DEHONG TECHNOLOGY CO.,LTD.	370-50713	(White) 10/100 Megabit Ethernet	
	Type C to LAN: Shielded, Undetached, 0.12m			
AC Adapter	LG (PI ELECTRONICS)	LP65WFC20P-NJ W	I/P: AC 100-240V, 1.6A, 50-60Hz O/P:DC 5V,3A(15W) or DC 9V, 3A(27W)or DC 15V,3A (45W) or DC 20V,3.25A (65W) (US Type, Wall-mount)	
	Type C Cable, Shielded, Detached, 2.0m			

Remark: For more detailed features description, please refer to the manufacturer’s specifications or the user manual.

3.6.1.The EUT collocates with following worst components, which are used to establish a basic configuration of system during test:

SKU (Mode)		1
Main Board	LG, 1XZ90RS MAIN B/D PCB	V
SUB Board	LG, 16Z90RS SUB B/D	V
CPU	Intel, i7-1360P	V
16” LCD Panel	Samsung, ATNA60BX02-0	V
Storage (SSD)	SK hynix, 1TB	V
	Samsung, 256GB	V
Memory (RAM)	32GB	V
Battery Pack	LG, 80Wh	V
Keyboard	TIC, KT0120B8	V
Touch Pad	Taifang, TF100AP02002	V
Web Camera	Chicony, CKFLF26(2Mic)	V
WLAN Combo Card	Intel, AX211D2W	V
WLAN Combo Antenna	LG (INPAQ), WA-P-LELE-04-035	V
Type C #1	AC Adapter	LG (PI ELECTRONICS), LP65WFC20P-NJ W
Type C #2	Link to LAN Gender	MEC

3.7. Test Configuration

Mode	Duty Cycle (x)	T (ms)	Duty Cycle Correction Factor (dB)
BT	N/A	2.890	N/A

AC Conduction
Normal operation

Item	Mode	Data Rate	Test Channel
Radiated Test Case Radiated Spurious Emission (30MHz~1GHz)	GFSK	1Mbps	78

Item		Modulation	Data Rate	Test Channel	
Radiated Test Case	SKU #2	Radiated Band Edge ^{Note 1 & 2}	GFSK	1Mbps	00/78
			8-DPSK	3Mbps	00/78
		Radiated Spurious Emission ^{Note1}	GFSK	1Mbps	00/39/78
Conducted Test Case	20dB/Occupied Bandwidth		GFSK	1Mbps	00/39/78
			8-DPSK	3Mbps	00/39/78
	Carrier Frequency Separation		GFSK	1Mbps	00/39/78
			8-DPSK	3Mbps	00/39/78
	Time of Occupancy		GFSK	1Mbps	00/39/78
			8-DPSK	3Mbps	00/39/78
	Number of Hopping Channels		GFSK	1Mbps	39
			8-DPSK	3Mbps	39
	Maximum Peak Output Power		GFSK	1Mbps	00/39/78
			8-DPSK	3Mbps	00/39/78
	Band Edges		GFSK	1Mbps	00/78
			8-DPSK	3Mbps	00/78
Spurious Emission		GFSK	1Mbps	00/39/78	
		8-DPSK	3Mbps	00/39/78	

Note 1: Mobile Device Portable Device

and 3 axis were assessed. The worst scenario for Radiated Spurious Emission as follow:

Lie Side Stand

Note 2: We performed testing of the highest and lowest data rate.

3.8. Output Power Setting

Centre Frequency (MHz)	Power Setting	
	GFSK	8-DPSK
2402	12	7
2441	12	7
2480	12	7

3.9. Tested Supporting System List

3.9.1. Support Peripheral Unit

No.	Product	Brand	Model No.	Serial No.	Approval
1.	USB Mouse	hp	MOFYUO	FCMHH0AKZBD7 LC	N/A
2.	Earphone	APPLE	N/A	N/A	N/A
3.	SD Card	ADATA	MicroSDHC Card	N/A	N/A
Partner System					
4.	AP Server	ASUS	RT-AX88U	N/A	FCC ID: MSQ-RTAXHP00 IC: 3568A-RTAXHP00

3.9.2. Cable Lists

No.	Cable Description Of The Above Support Units
1.	USB Cable: Unshielded, Undetachable, 0.7m
2.	Earphone Cable: Unshielded, Undetachable, 1.2m
3.	N/A
4.	AC adapter: M/N:WA-30B12, Cable: Unshielded, Detachable, 1.2m LAN cable: Unshielded, Detachable, 3.0m
5.	LAN cable: Unshielded, Detachable, 1.8m

3.10. Setup Configuration

3.10.1. EUT Configuration for Power Line & Radiated Emission

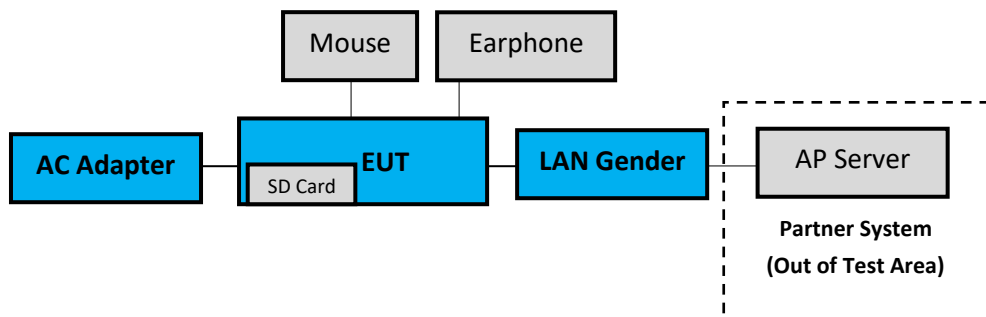

3.10.1. EUT Configuration for RF Conducted Test Items

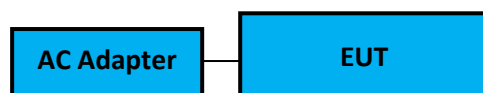

3.11. Operating Condition of EUT

Test program “DRTU” is used for enabling EUT BT function under continues transmitting and choosing data rate/ channel.

3.12. Description of Test Facility

Name of Test Firm	Audix Technology Corporation / EMC Department No. 491, Zhongfu Rd., Linkou Dist., New Taipei City 244, Taiwan Tel: +886-2-26092133 Fax: +886-2-26099303 Website : www.audixtech.com Contact e-mail: attemc_report@audixtech.com
Accreditations	The laboratory is accredited by following organizations under ISO/IEC 17025:2017 (1) NVLAP(USA) NVLAP Lab Code 200077-0 (2) TAF(Taiwan) No. 1724
Test Facilities	FCC OET Designation Number under APEC MRA by NCC is : TW1724 ISED CAB Identifier Number under APEC TEL MRA by NCC is TW1724 (1) No.8 Shielded Room (2) No.1 3m Semi Anechoic Chamber

3.13.Measurement Uncertainty

Test Items/Facilities		Frequency Range	Uncertainty
Conduction Test	<input type="checkbox"/>	No. 7 Shielded Room	9kHz-150kHz ±3.7dB
			150kHz-30MHz ±3.4dB
	<input checked="" type="checkbox"/>	No. 8 Shielded Room	9kHz-150kHz ±3.7dB
			150kHz-30MHz ±3.5dB
Radiation Test	<input checked="" type="checkbox"/>	No.1 3m Semi Anechoic Chamber	30MHz-200MHz, 3m, Horizontal ±3.8dB
			200MHz-1000MHz, 3m, Horizontal ±4.4dB
			30MHz-200MHz, 3m, Vertical ±4.5dB
			200MHz-1000MHz, 3m, Vertical ±4.7dB
			1GHz-6GHz, 3m ±4.9dB
			6GHz-18GHz, 3m ±4.5dB
	<input type="checkbox"/>	No.3 3m Semi Anechoic Chamber	30MHz-200MHz, 3m, Horizontal ±4.0dB
			200MHz-1000MHz, 3m, Horizontal ±4.3dB
			30MHz-200MHz, 3m, Vertical ±4.6dB
			200MHz-1000MHz, 3m, Vertical ±4.7dB
			1GHz-6GHz, 3m ±4.8dB
			6GHz-18GHz, 3m ±4.5dB
	<input type="checkbox"/>	No.4 3m Semi Anechoic Chamber	30MHz-200MHz, 3m, Horizontal ±4.3dB
			200MHz-1000MHz, 3m, Horizontal ±4.3dB
			30MHz-200MHz, 3m, Vertical ±4.6dB
			200MHz-1000MHz, 3m, Vertical ±4.7dB
			1GHz-6GHz, 3m ±4.8dB
			6GHz-18GHz, 3m ±4.4dB
	<input type="checkbox"/>	No.5 3m Semi Anechoic Chamber	30MHz-200MHz, 3m, Horizontal ±4.3dB
			200MHz-1000MHz, 3m, Horizontal ±4.3dB
			30MHz-200MHz, 3m, Vertical ±4.5dB
			200MHz-1000MHz, 3m, Vertical ±4.6dB
			1GHz-6GHz, 3m ±4.9dB
			6GHz-18GHz, 3m ±4.1dB
Radiated emissions (18GHz-40GHz)		18GHz-40GHz, 3m	±3.4dB

Remark : Uncertainty = $ku_c(y)$



Audix Technology Corp.
No. 491, Zhongfu Rd., Linkou Dist.,
New Taipei City 244, Taiwan

Tel: +886 2 26099301
Fax: +886 2 26099303

Test Item	Uncertainty
20dB Bandwidth	$\pm 0.2\text{kHz}$
99% Occupied Bandwidth	$\pm 0.38\%$
Carrier Frequency Separation	$\pm 0.2\text{kHz}$
Time of Occupancy	$\pm 0.03\text{sec}$
Maximum peak Output power	$\pm 0.52\text{dB}$
Conducted Emission Limitations	$\pm 0.13\text{dB}$

4. MEASUREMENT EQUIPMENT LIST

4.1. Conducted Emission Measurement

Item	Type	Manufacturer	Model No.	Serial No.	Cal. Date	Cal. Interval
1.	Test Receiver	R&S	ESR3	101774	2022. 01. 11	1 Year
2.	A.M.N.	R&S	ENV432	101567	2022. 05. 26	1 Year
3.	L.I.S.N.	Kyoritsu	KNW-407	8-855-9	2021. 12. 19	1 Year
4.	Pulse Limiter	R&S	ESH3-Z2	100354	2021. 12. 23	1 Year
5.	Digital Thermo-Hygro Meter	iMax	HTC-1	No.8 S/R	2022. 04. 14	1 Year
6.	Coaxial Cable	Yeida	RG/58AU	CE-08	2022. 09. 07	1 Year
7.	Test Software	Audix	e3	V9 18621a	N.C.R.	N.C.R.

4.2. Radiated Emission Measurement

Item	Type	Manufacturer	Model No.	Serial No.	Cal. Date	Cal. Interval
1.	Spectrum Analyzer	Agilent	N9010A-526	MY53400071	2022. 08. 24	1 Year
2.	Test Receiver	R&S	ESCS30	100338	2022. 06. 15	1 Year
3.	Amplifier	HP	8447D	2944A06305	2022. 01. 05	1 Year
4.	Microwave Amplifier	Keysight	83051A	MY56480113	2022. 09. 07	1 Year
5.	Microwave Amplifier	Agilent	8449B	3008A02678	2022. 02. 22	1 Year
6.	Loop Antenna	TESEQ	HLA 6121	60478	2022. 02. 17	1 Year
7.	Bilog Antenna	TESEQ	CBL6112D	33821	2022. 07. 01	1 Year
8.	Double-Ridged Waveguide Horn	ETS-Lindgren	3117	00135902	2022. 03. 21	1 Year
9.	Horn Antenna	COM-POWER	AH-840	101092	2022. 01. 06	1 Year
10.	2.4GHz Notch Filter	K&L Microwave	7NSL10-2441 .5/E130.5-O/O	2	2022 .07. 23	1 Year
11.	3GHz Notch Filter	Microwave	H3G018G1	484796	2022 .07. 23	1 Year
12.	Coaxial Cable	MIYAZAKI	5D2W	RE-11	2022. 01. 20	1 Year
13.	Coaxial Cable	HUBER+SUHNER	SUCOFLEX 106	RE-14	2022. 01. 20	1 Year
14.	Coaxial Cable	HUBER+SUHNER	SUCOFLEX 102	RE-30	2022. 08. 22	1 Year
15.	Digital Thermo-Hygro Meter	iMax	HTC-1	No.1 3m A/C	2022. 04. 14	1 Year
16.	Test Software	Audix	e3	V9 18621a	N.C.R.	N.C.R.

4.3. RF Conducted Measurement

Item	Type	Manufacturer	Model No.	Serial No.	Cal. Date	Cal. Interval
1.	Spectrum Analyzer	Keysight	N9020B-544	MY57120357	2022. 03. 02	1 Year
2.	Digital Thermo-Hygro Meter	iMax	HTC-1	RF-03	2022. 04. 14	1 Year

5. CONDUCTED EMISSION

5.1. Block Diagram of Test Setup

5.1.1. Block Diagram of EUT

Indicated as section 3.10

5.1.2. Shielded Room Setup Diagram

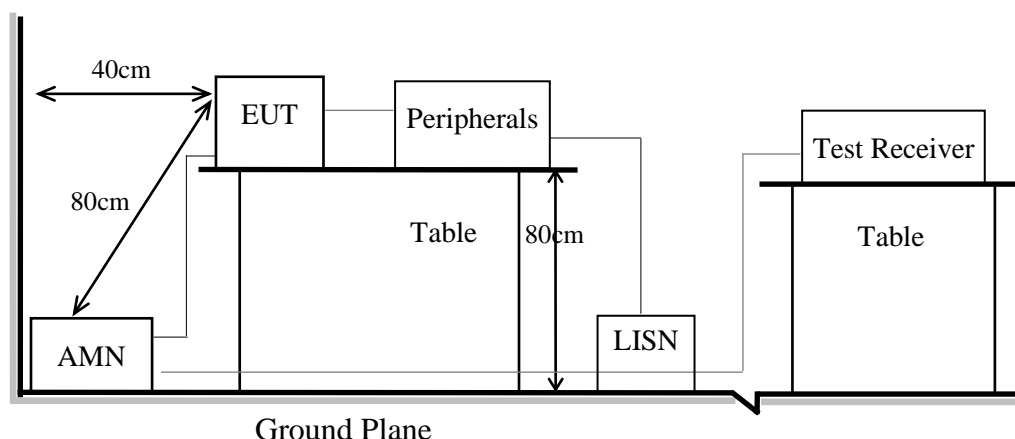

5.2. Conducted Emission Limit

Frequency	Conducted Limit	
	Quasi-Peak Level	Average Level
150kHz ~ 500kHz	66 ~ 56 dB μ V	56 ~ 46 dB μ V
500kHz ~ 5MHz	56 dB μ V	46 dB μ V
5MHz ~ 30MHz	60 dB μ V	50 dB μ V

Remark1.: If the average limit is met when using a Quasi-Peak detector, the measurement using the average detector is not required.

2.: The lower limit applies to the band edges.

5.3. Test Procedure

- 5.3.1. To set up the EUT as indicated in ANSI C63.10. The EUT was placed on the table which has 80 cm height to the ground and 40 cm distance to the conducting wall.
- 5.3.2. Power supplier of the EUT was connected to the AC mains through an Artificial Mains Network (A.M.N.).
- 5.3.3. The AC power supplies to all peripheral devices must be provided through line impedance stabilization network (L.I.S.N.)
- 5.3.4. Checking frequency range from 150kHz to 30 MHz and record the emission which does not have 20 dB below limit.



Audix Technology Corp.
No. 491, Zhongfu Rd., Linkou Dist.,
New Taipei City 244, Taiwan

Tel: +886 2 26099301
Fax: +886 2 26099303

5.4. Test Results

Please refer to Appendix A.

6. RADIATED EMISSION

6.1. Block Diagram of Test Setup

6.1.1. Block Diagram of EUT

Indicated as section 3.10

6.1.2. Setup Diagram for 9kHz-30MHz

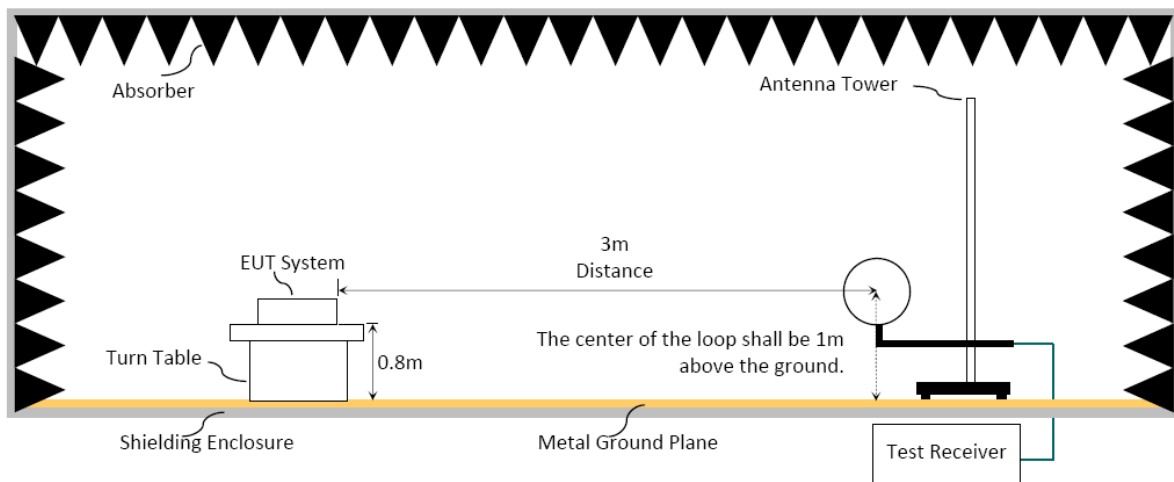

6.1.3. Setup Diagram for 30-1000MHz

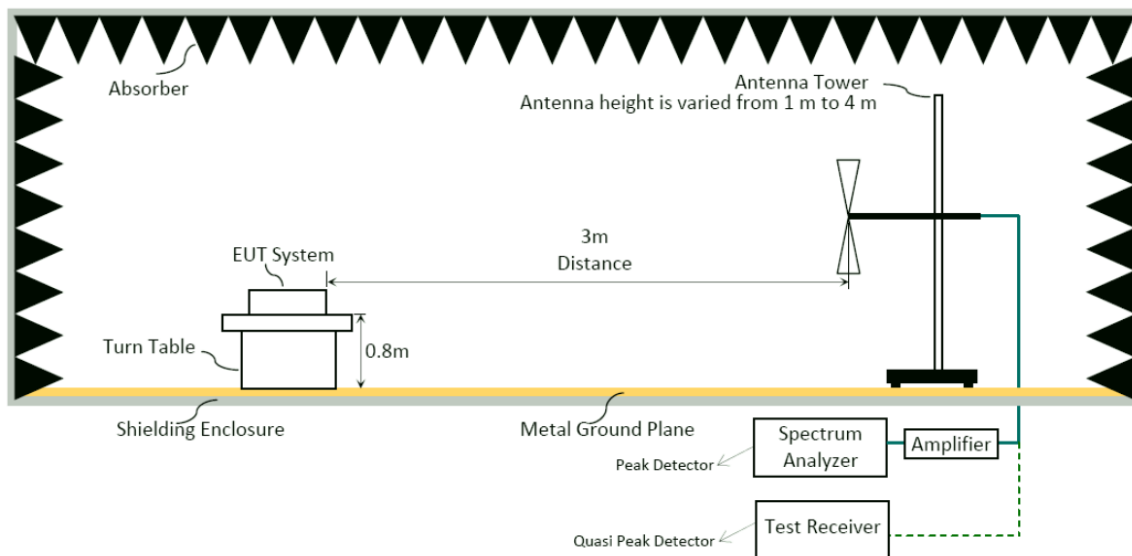

6.1.4. Setup Diagram for above 1GHz

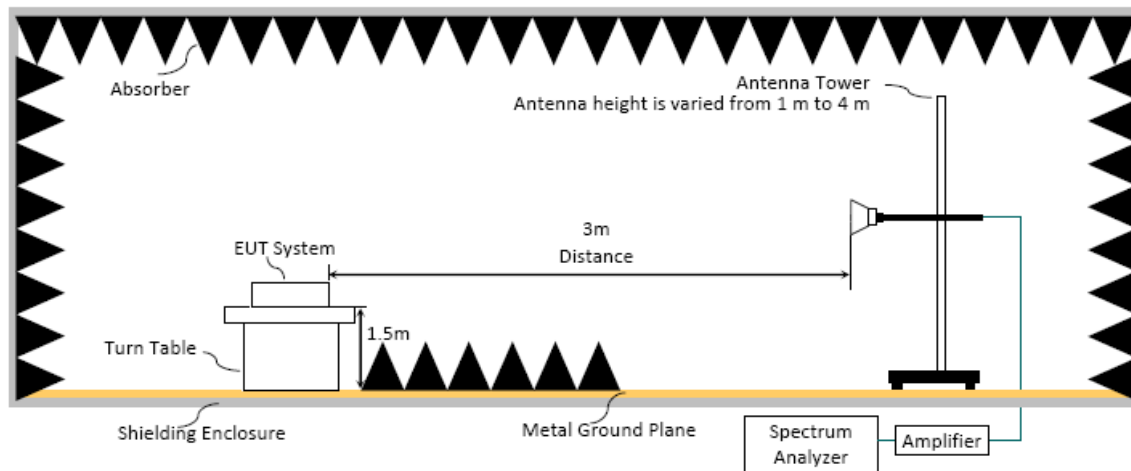

6.2. Radiated Emission Limits

In any 100kHz bandwidth outside the frequency band, the radio frequency power produced by the intentional radiator shall be at least 20dB below that in the 100kHz bandwidth within the band that contains the highest level. In addition, radiated emissions which fall in restricted bands, as defined in Section 15.205/RSS-Gen Section 8.10 table 6, must also comply with the radiated emission limits specified as below.

Frequency (MHz)	Distance(m)	Limits	
		dB μ V/m	μ V/m
0.009 - 0.490	300	67.6-20 log f(kHz)	2400/f kHz
0.490 - 1.705	30	87.6-20 log f(kHz)	24000/f kHz
1.705 - 30	30	29.5	30
30 - 88	3	40.0	100
88- 216	3	43.5	150
216- 960	3	46.0	200
Above 960	3	54.0	500
Above 1000	3	74.0 dB μ V/m (Peak) 54.0 dB μ V/m (Average)	

Remark : (1) dB μ V/m = 20 log (μ V/m)

- (2) The tighter limit applies to the edge between two frequency bands.
- (3) Distance refers to the distance in meters between the measuring instrument antenna and the closed point of any part of the device or system.
- (4) Fundamental and emission fall within operation band are exempted from this section.
- (5) Pursuant to ANSI C63.10: 6.6.4.3, if the maximized peak measured value complies with the average limit, then it is unnecessary to perform an average measurement.

6.3. Test Procedure

Frequency Range 9kHz~30MHz:

The EUT setup on the turntable which has 0.8 m height to the ground. The turn table rotated 360 degrees and antenna fixed to 1 m to find the maximum emission level. In order to find the maximum emission, all of the interface cables were manipulated according to ANSI C63.10-2013 regulation.

- (1) RBW = 9kHz with peak and average detector.
- (2) Detector: average and peak (9kHz-490kHz)
Q.P. (490kHz-30MHz)

Frequency Range 30MHz ~ 25GHz:

The EUT setup on the turn table which has 80cm (for 30-1000MHz) and 1.5m (for above 1GHz) height to the ground. The turn table rotated 360 degrees and antenna varied from 1 m to 4 m to find the maximum emission level. Both horizontal and vertical polarization are required. In order to find the maximum emission, all of the interface cables were manipulated according to ANSI C63.10-2013 regulation.

Frequency below 1GHz:

Spectrum Analyzer is used for pre-testing with following setting:

- (1)RBW = 120KHz
- (2)VBW \geq 3 x RBW.
- (3)Detector = Peak.
- (4)Sweep time = auto.
- (5)Trace mode = max hold.
- (6)Allow sweeps to continue until the trace stabilizes.

Note 1: When peak-detected value is lower than limit that the measurement using the Q.P. detector is not required, otherwise using Q.P. for final measurement.

Note 2: When the radiated emissions limits are expressed in terms of the average value of the emissions, and pulsed operation is employed, the measurement field strength shall be determined by averaging over one complete pulse train, including blanking intervals, as long as the pulse train does not exceed 0.1 seconds.

Frequency above 1GHz to 10th harmonic(up to 25 GHz):

Peak Detector:

- (1)RBW = 1MHz
- (2)VBW \geq 3 x RBW.
- (3)Detector = Peak.
- (4)Sweep time = auto.
- (5)Trace mode = max hold.
- (6)Allow sweeps to continue until the trace stabilizes.

Note: When peak-detected value is lower than limit that the measurement using the average detector is not required, otherwise using average detector for final measurement.

Average Detector: **Option 1:**

(1) RBW = 1MHz

(2) VBW \geq 1/ T

Mode	TX _{on} (ms)	1/ TX _{on} (kHz)	VBW(>1/ TX _{on}) (kHz)
BT	2.890	0.346	3

(3) Detector = Peak.

(4) Sweep time = auto.

(5) Trace mode = max hold.

(6) Allow sweeps to continue until the trace stabilizes.

 Option 2:

Average Emission Level = Peak Emission Level + D.C.C.F.

6.4. Measurement Result Explanation Peak Emission Level (dB μ V/m) = Antenna Factor (dB/m) + Cable Loss (dB) – Preamp Gain (dB) + Reading (dB μ V). Average Emission Level (dB μ V/m) = Antenna Factor (dB/m) + Cable Loss (dB) – Preamp Gain (dB) + Reading (dB μ V). Average Emission Level (dB μ V/m) = Peak Emission Level (dB μ V/m) + DCCF (dB) – Duty Cycle Correction Factor (DCCF) (dB) = $20\log(\text{TX}_{\text{on}}/\text{TX}_{\text{on+off}})$ presented in section 3.7. ERP (dBm) = Peak Emission Level (dB μ V/m) - 95.2dB - 2.14dB**6.5. Test Results**

Please refer to Appendix A.

7. 20dB/OCCUPIED BANDWIDTH

7.1. Block Diagram of Test Setup

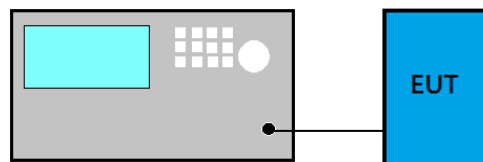

7.2. Specification Limits

Alternatively, frequency hopping systems operating in the 2400-2483.5MHz band may have hopping channel carrier frequencies that are separated by 25kHz or two-thirds of the 20dB bandwidth of the hopping channel, whichever is greater.

7.3. Test Procedure

Following measurement procedure is reference to ANSI C63.10:2013:

For 20dB Bandwidth

- (1) Set Span range 2~5 times the OBW
- (2) Set RBW close to 1% to 5% of OBW.
- (3) Set VBW $\geq 3 \times$ RBW.
- (4) Detector = Peak.
- (5) Trace mode = Max hold.
- (6) Sweep = Auto couple.
- (7) Allow the trace to stabilize.
- (8) Setting channel bandwidth function x dB to -20 dB to record the final bandwidth.

For 99% Occupied Bandwidth

- (9) Set Span range 1.5~5 times the OBW
- (10) Set RBW close to 1% to 5% of OBW.
- (11) Set VBW $\geq 3 \times$ RBW.
- (12) Detector = Peak.
- (13) Trace mode = Max hold
- (14) Sweep = Auto couple.
- (15) Allow the trace to stabilize.

7.4. Test Results

Please refer to Appendix A

8. CARRIER FREQUENCY SEPARATION

8.1. Block Diagram of Test Setup

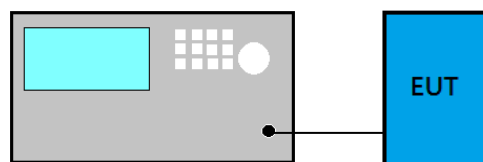

8.2. Specification Limits

Alternatively, frequency hopping systems operating in the 2400-2483.5MHz band may have hopping channel carrier frequencies that are separated by 25kHz or two-thirds of the 20dB bandwidth of the hopping channel, whichever is greater, provided the systems operate with an output no greater than 125mW.

8.3. Test Procedure

Following measurement procedure is reference to ANSI C63.10:2013:

- (1) Span = Wide enough to capture the peaks of two adjacent channels
- (2) RBW: Start with the RBW set to approximately 30% of the channel spacing; adjust as necessary to best identify the center of each individual channel.
- (3) $VBW \geq RBW$
- (4) Sweep = Auto
- (5) Detector function = Peak
- (6) Trace = Max hold
- (7) Allow the trace to stabilize.

8.4. Test Results

Please refer to Appendix A

9. TIME OF OCCUPANCY

9.1. Block Diagram of Test Setup

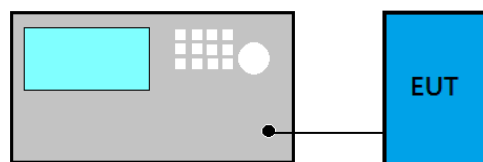

9.2. Specification Limits

Frequency hopping systems in the 2400-2483.5MHz shall use at least 15 non-overlapping channels. The average time of occupancy on any channel shall not be greater than 0.4 seconds within a period of 0.4 seconds multiplied by number of hopping channels employed.

9.3. Test Procedure

Following measurement procedure is reference to ANSI C63.10:2013:

- (1) Span: Zero span, centered on a hopping channel.
- (2) RBW shall be \leq channel spacing and where possible RBW should be set $\gg 1/T$, where T is the expected dwell time per channel.
- (3) Sweep: As necessary to capture the entire dwell time per hopping channel; where possible use a video trigger and trigger delay so that the transmitted signal starts a little to the right of the start of the plot. The trigger level might need slight adjustment to prevent triggering when the system hops on an adjacent channel; a second plot might be needed with a longer sweep time to show two successive hops on a channel.
- (4) Detector function = Peak
- (5) Trace = Max hold

9.4. Test Results

Please refer to Appendix A

10. NUMBER OF HOPPING CHANNELS

10.1. Block Diagram of Test Setup

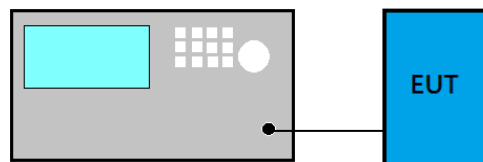

10.2. Specification Limits

Frequency hopping systems which use fewer than 20 hopping frequencies may employ intelligent hopping techniques to avoid interference to other transmissions. Frequency hopping systems may avoid or suppress transmissions on a particular hopping frequency provided that a minimum of 15 non-overlapping channels.

10.3. Test Procedure

Following measurement procedure is reference to ANSI C63.10:2013:

- (1) Span: The frequency band of operation. Depending on the number of channels the device supports, it may be necessary to divide the frequency range of operation across multiple spans, to allow the individual channels to be clearly seen.
- (2) RBW: To identify clearly the individual channels, set the RBW to less than 30% of the channel spacing or the 20 dB bandwidth, whichever is smaller.
- (3) VBW \geq RBW
- (4) Sweep = Auto
- (5) Detector function = Peak
- (6) Trace = m=Max hold
- (7) Allow the trace to stabilize.

10.4. Test Results

Please refer to Appendix A

11. MAXIMUM PEAK OUTPUT POWER

11.1. Block Diagram of Test Setup

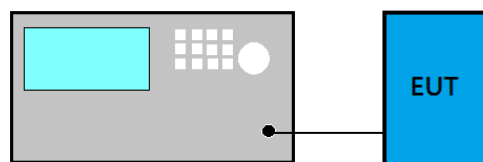

11.2. Specification Limits

The Limits of maximum Peak Output Power for frequency hopping systems in 2400-2483.5MHz is: 0.125Watt. (21dBm)

11.3. Test Procedure

Following measurement procedure is reference to ANSI C63.10:2013:

- (a) Use the following spectrum analyzer settings
 - (1) Span: Approximately five times the 20 dB bandwidth, centered on a hopping channel.
 - (2) RBW > 20 dB bandwidth of the emission being measured.
 - (3) VBW \geq RBW
 - (4) Sweep: Auto
 - (5) Detector function: Peak
 - (6) Trace: Max hold
- (b) Allow trace to stabilize.
- (c) Use the marker-to-peak function to set the marker to the peak of the emission.

11.4. Test Results

Please refer to Appendix A

12. EMISSION LIMITATIONS

12.1. Block Diagram of Test Setup

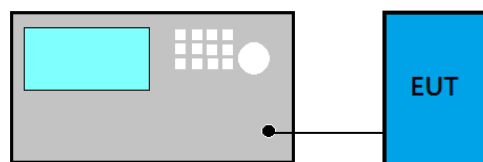

12.2. Specification Limits

In any 100kHz bandwidth outside the frequency band in which the spread spectrum or digitally modulated intentional radiator is operating, the radio frequency power that is produced by the intentional radiator shall be at least 20dB below that in the 100kHz bandwidth within the band that contains the highest level of the desired power, based on either an RF conducted or a radiated measurement. If the transmitter complies with the conducted power limits based on the use of RMS averaging over a time interval, that the required attenuation shall be 30 dB instead of 20 dB.

Attenuation below the general limits specified in Section 15.209(a)/RSS-Gen Section 8.9 table 4 is not required. In addition, radiated emissions which fall in restricted bands, as defined in Section 15.205(a)/RSS-Gen Section 8.10 table 6., must also comply with the radiated emission limits specified in Section 15.209(a)/RSS-Gen Section 8.9 table 4 (See Section 15.205(c)).

12.3. Test Procedure

Following measurement procedure is reference to ANSI C63.10:2013:

- (1) Set span wide enough to capture the peak level of the in-band emission and all spurious emissions; up to 10th harmonic.
- (2) RBW = 100 kHz
- (3) VBW \geq RBW
- (4) Sweep = Auto
- (5) Detector function = Peak
- (6) Trace = Max hold

12.4. Test Results

Please refer to Appendix A



13. DEVIATION TO TEST SPECIFICATIONS

【NONE】



Audix Technology Corp.
No. 491, Zhongfu Rd., Linkou Dist.,
New Taipei City 244, Taiwan

APPENDIX A

Tel: +886 2 26099301
Fax: +886 2 26099303

APPDNDIX A

TEST DATA AND PLOTS

(Model: 16Z90RS)



Audix Technology Corp.
No. 491, Zhongfu Rd., Linkou Dist.,
New Taipei City 244, Taiwan

Tel: +886 2 26099301
Fax: +886 2 26099303

APPDNDIX B

TEST PHOTOGRAPHS

(Model: 16Z90RS)