

**FCC 15.407 NII
(Permissive Change)
5GHz Test Report**

for

LG Electronics Inc.

**222, LG-ro, Jinwi-myeon Pyeongtaek-Si, Gyeonggi-Do,
17709 Republic of Korea**

Product Name : Notebook Computer
**Model Name : (1)16Z90Q (2)16ZB90Q
(3)16ZD90Q (4)16ZG90Q**
Brand : LG
FCC ID : BEJNT-16Z90Q

**Prepared by: : AUDIX Technology Corporation,
EMC Department**



The test report is based on a single evaluation of one sample of the above-mentioned products. It does not imply an assessment of the whole production and does not permit the use of the test lab logo.

TABLE OF CONTENTS

Description	Page
TEST REPORT.....	4
1. REVISION RECORD OF TEST REPORT	4
2. SUMMARY OF TEST RESULTS	5
3. GENERAL INFORMATION	6
3.1. Description of Application	6
3.2. Description of EUT	7
3.3. Reference Test Guidance.....	8
3.4. Information for Permissive Change.....	8
3.5. Antenna Information	9
3.6. EUT Specifications Assessed in Current Report	10
3.7. Description of Key Components	13
3.8. Test Configuration.....	15
3.9. Output Power Setting	21
3.10. Tested Supporting System List.....	24
3.11. Setup Configuration.....	24
3.12. Operating Condition of EUT	25
3.13. Description of Test Facility	25
3.14. Measurement Uncertainty	26
4. MEASUREMENT EQUIPMENTLIST.....	27
4.1. Conducted Emission Measurement	27
4.2. Radiated Emission Measurement	28
4.3. RF Conducted Measurement	28
5. CONDUCTED EMISSION.....	29
5.1. Block Diagram of Test Setup	29
5.2. Conducted Emission Limit	29
5.3. Test Procedure	29
5.4. Test Results	30
6. RADIATED EMISSION	31
6.1. Block Diagram of Test Setup	31
6.2. Radiated Emission Limits.....	33
6.3. Test Procedure	35
6.4. Measurement Result Explanation.....	36
6.5. Test Results	36
7. MAXIMUM OUTPUT POWER	37
7.1. Block Diagram of Test Setup	37
7.2. Specification Limits.....	37
7.3. Test Procedure	38
7.4. Test Results	38
8. DEVIATION TO TEST SPECIFICATIONS	39
 APPENDIX A TEST DATA AND PLOTS	
APPENDIX B TESTPHOTOGRAPHS	

TEST REPORT (Permissive Change)

Applicant : LG Electronics Inc.
Manufacturer : LG Electronics Inc.
Factory : LG Electronics Nanjing New Technology Co., Ltd.
EUT Description
(1) Product : Notebook Computer
(2) Model : (1)16Z90Q (2)16ZB90Q (3)16ZD90Q (4)16ZG90Q
(3) Brand : LG
(4) Power Supply: DC 20V, 3.25A

Applicable Standards:

Title 47 FCC CFR Part 15 Subpart E

Audix Technology Corp. tested the equipment mentioned in accordance with the requirements set forth in the above standards. Test results indicate that the equipment tested is capable of demonstrating compliance with the requirements as documented within this report.

Audix Technology Corp. does not assume responsibility for any conclusions and generalizations drawn from the test results with regard to other specimens and samples.

Date of Report: 2022. 06. 23

Reviewed by:

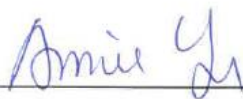

(Annie Yu/Administrator)

Approved by:

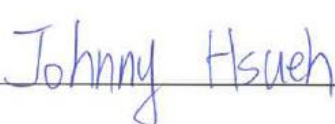

(Johnny Hsueh/Section Manager)

1. REVISION RECORD OF TEST REPORT

Edition No	Issued Data	Revision Summary	Report Number
0	2022. 06. 13	Original Report	EM-F220378
A	2022. 06. 23	To revise output power test data.	EM-F220378

2. SUMMARY OF TEST RESULTS

Rule	Description	Results
15.207	Conducted Emission	PASS
15.205/15.209	Radiated Band Edge and Radiated Spurious Emission	N/A, NOTE 2/3
15.407(a)(5)/15.407(e)	Emission/Occupied Bandwidth	N/A, NOTE 2
15.407(a)	Maximum Output Power	PASS
15.407(b)	Conducted Band Edges	N/A
15.407(a)	Power Spectral Density	N/A, NOTE 2
15.407	Frequency Stability	N/A, NOTE 2
15.407(h)(2)	Dynamic Frequency Selection(DFS)	N/A, NOTE 2
15.203	Antenna Requirement	Compliance

Note: 1. The uncertainties value is not used in determining the result.
2. To add new Configuration with new components is not influence on this item
3. Due to the above difference, it is unnecessary to test Radiated Band Edge.

3. GENERAL INFORMATION

3.1. Description of Application

Applicant	LG Electronics Inc. 222, LG-ro, Jinwi-myeon Pyeongtaek-Si, Gyeonggi-Do, 17709 Republic of Korea
Manufacturer	LG Electronics Inc. 222, LG-ro, Jinwi-myeon Pyeongtaek-Si, Gyeonggi-Do, 17709 Republic of Korea
Factory	LG Electronics Nanjing New Technology Co., Ltd. No.346, Yaoxin Road, Economic & Technical Development Zone, Nanjing, China.
Product	Notebook Computer
Model	(1)16Z90Q (2)16ZB90Q (3)16ZD90Q (4)16ZG90Q The difference between all models is different in the sales customers.
Configuration (HVIN)	16Z90Q-K, 16Z90Q-N, 16Z90Q-A, 16Z90Q-R The difference please refer to the following.
Brand	LG

The difference list for Configuration (HVIN):

Difference Configuration (HVIN)	Main Board	GPU	TPM (Trusted Platform Module)
16Z90Q-K	Queen MAIN B/D PCB	Intel Iris Xe UHD Graphics	Not Support
16Z90Q-N	Queen MAIN B/D PCB	Intel Iris Xe UHD Graphics	Support
16Z90Q-A	QUEEN NVIDIA MAIN B/D PCB	NVIDIA RTX2050	Not Support
16Z90Q-R	QUEEN NVIDIA MAIN B/D PCB	NVIDIA RTX2050	Support

3.2. Description of EUT

Test Model	16Z90Q		
Serial Number	N/A		
Power Rating	DC 20V, 3.52A		
Software Version	XY (X, Y can be 0 to 9 for different SW version not influence RF parameter)		
RF Features	WLAN:802.11 a/b/g/n/ac/ax Bluetooth: BT and BLE (BT 5.1)		
Transmit Type	2.4 GHz		
	802.11b		1T1R
	802.11g		1T1R
	802.11n-HT20		2T2R
	802.11n-HT40		2T2R
	802.11ax-HE20		2T2R
	802.11ax-HE40		2T2R
	BT/BLE		1T1R
	U-NII Bands		
	802.11a		1T1R
	802.11n-HT20/802.11ac-VHT20/802.11ax-HE20		2T2R
	802.11n-HT40/802.11ac-VHT40/802.11ax-HE40		2T2R
	802.11ac-VHT80/802.11ax-HE80		2T2R
	802.11ac-VHT160/802.11ax-HE160		2T2R
	The MIMO is uncorrelated and supported SDM mode only.		
	Device Category	<input type="checkbox"/> Outdoor Access Point <input type="checkbox"/> Fixed point-to-point Access Point <input type="checkbox"/> Indoor Access Point <input checked="" type="checkbox"/> Mobile and Portable client device	
Test Sample	Sample No.	Test Item	Firmware
	03	AC Conduction, RSE	N/A
	04	AC Conduction, RSE, RF Conducted	N/A
Sample Status	Trial sample		
Date of Receipt	2022. 03. 24		
Date of Test	2022. 05. 21 ~ 06. 22		
Interface Ports of EUT	<ul style="list-style-type: none"> • One HDMI Port • Two USB Type C Ports • One Earphone Port • One Micro SD Card Slot • Two USB 3.0 Ports 		
Accessories Supplied	<ul style="list-style-type: none"> • AC Adapter • LAN Gender 		

3.3. Reference Test Guidance

KDB 789033 D02 General UNII Test Procedures New Rules v02r01
 ANSI C63.10:2013

3.4. Information for Permissive Change

- The EUT is an addition version with original FCC ID: BEJNT-16Z90Q is to add new Configuration (HVIN) and components, and the detail for component list please refer to section 3.7.1
- The differences between this application and original's ID as clarify in following list.

Difference		Main Board	GPU	TPM (Trusted Platform Module)
Original	16Z90Q	Queen MAIN B/D PCB	Intel Iris Xe UHD Graphics	Not Support
		Queen MAIN B/D PCB	Intel Iris Xe UHD Graphics	Support
Permissive Change	16Z90Q-K	Queen MAIN B/D PCB	Intel Iris Xe UHD Graphics	Not Support
	16Z90Q-N	Queen MAIN B/D PCB	Intel Iris Xe UHD Graphics	Support
	16Z90Q-A	QUEEN NVIDIA MAIN B/D PCB	NVIDIA RTX2050	Not Support
	16Z90Q-R	QUEEN NVIDIA MAIN B/D PCB	NVIDIA RTX2050	Support

Note: 1. The Configuration (HVIN) 16Z90Q-K and 16Z90Q-N with original components were measured in the original application.
 2 The Configuration (HVIN) 16Z90Q-A and 16Z90Q-R with new components were measured in this Permissive Change application.

- Due to above different item, there have some test item should be re-tested (see section 2), the test data are recorded in this report.

3.5. Antenna Information

No.	Antenna Part Number	Manufacture	Antenna Type	Frequency (MHz)	Max Gain(dBi)	
					Main	AUX
1.	WA-P-LELE-04-009	INPAQ	Mono-Pole	2400	2.3	2.0
				2450	2.4	2.6
				2500	3.2	2.4
				5150	4.2	3.5
				5400	4.2	3.6
				5850	4.4	3.5
				5925	4.1	3.4
				6525	4.1	3.2
				7125	4.2	2.3
Note 1. 2.4G: Directional gain = $10 \log[(10^{3.2/10} + 10^{2.6/10})/2] = 2.91\text{dBi}$ Note 2. UNII Band (WLAN 5G): Directional gain = $10 \log[(10^{4.4/10} + 10^{3.6/10})/2] = 4.02\text{dBi}$ Note 3. UNII Band (WLAN 6G): Directional gain = $10 \log[(10^{4.2/10} + 10^{3.4/10})/2] = 3.82\text{dBi}$						
2.	L1LRF008-CS-H	LUXSHARE-ICT	Mono-Pole	2400	6.3	0.9
				2450	5.7	1.6
				2500	2.7	3.5
				5150	-1.5	2.3
				5400	3.4	4.5
				5850	3.3	5.8
				5925	2.9	4.7
				6525	3.4	1.3
				7125	-4.9	-1.6
Note 1. 2.4G: Directional gain = $10 \log[(10^{6.3/10} + 10^{3.5/10})/2] = 5.12\text{dBi}$ Note 2. UNII Band (WLAN 5G): Directional gain = $10 \log[(10^{3.3/10} + 10^{5.8/10})/2] = 4.73\text{dBi}$ Note 3. UNII Band (WLAN 6G): Directional gain = $10 \log[(10^{3.4/10} + 10^{4.7/10})/2] = 4.10\text{dBi}$						

3.6. EUT Specifications Assessed in Current Report

Mode	U-NII Band	Fundamental Range (MHz)	Channel Number
802.11a	1	5180-5240	4
	2A	5260-5320	4
	2C	5500-5720	12
	3	5745-5825	5
802.11n-HT20/ 802.11ac-VHT20 802.11ax-HE20	1	5180-5240	4
	2A	5260-5320	4
	2C	5500-5720	12
	3	5745-5825	5
802.11n-HT40/ 802.11ac-VHT40 802.11ax-HE40	1	5190-5230	2
	2A	5270-5310	2
	2C	5510-5710	6
	3	5755-5795	2
802.11ac-VHT80 802.11ax-HE80	1	5210	1
	2A	5290	1
	2C	5530-5690	3
	3	5775	1
802.11ac-VHT160 802.11ax-HE160	1	5250	1
	2A		
	2C	5570	1
Remark: U-NII Band 2A and 2C (DFS Function, Slave/no In service monitor, no Ad-Hoc mode)			

Mode	Modulation	Data Rate (Mbps)
802.11a	OFDM (BPSK/QPSK/16QAM/64QAM)	Up to 54
802.11n-HT20	OFDM (BPSK/QPSK/16QAM/64QAM)	Up to 144.4
802.11n-HT40		Up to 300
802.11ac-VHT20	OFDM (BPSK/QPSK/16QAM/64QAM/256QAM)	Up to 173.3
802.11ac-VHT40		Up to 400
802.11ac-VHT80		Up to 866.7
802.11ac-VHT160		Up to 1733.3
802.11ax-HE20	OFDMA (BPSK/ QPSK/ 16QAM/ 64QAM/ 256QAM/1024QAM)	Up to 287
802.11ax-HE40		Up to 574
802.11ax-HE80		Up to 1201
802.11ax-HE160		Up to 2402

Channel List						
802.11a/802.11n-HT20/802.11ac-VHT20/802.11ax-HE20						
U-NII Band	Channel Number	Frequency (MHz)	U-NII Band	Channel Number	Frequency (MHz)	
1	36	5180	2C	120	5600	
	40	5200		124	5620	
	44	5220		128	5640	
	48	5240		132	5660	
2A	52	5260		136	5680	
	56	5280		140	5700	
	60	5300		144	5720	
	64	5320		149	5745	
2C	100	5500		3	153	5765
	104	5520			157	5785
	108	5540	161		5805	
	112	5560	165		5825	
	116	5580				

Channel List					
802.11n-HT40/802.11ac-VHT40/802.11ax-HE40					
U-NII Band	Channel Number	Frequency (MHz)	U-NII Band	Channel Number	Frequency (MHz)
1	38	5190	2C	118	5590
	46	5230		126	5630
2A	54	5270		134	5670
	62	5310		142	5710
2C	102	5510	3	151	5755
	110	5550		159	5795

Channel List					
802.11ac-VHT80/802.11ax-HE80					
U-NII Band	Channel Number	Frequency (MHz)	U-NII Band	Channel Number	Frequency (MHz)
1	42	5210	2C	138	5690
2A	58	5290	3	155	5775
2C	106	5530			
	122	5610			

Channel List					
802.11ac-VHT160/802.11ax-HE160					
U-NII Band	Channel Number	Frequency (MHz)	U-NII Band	Channel Number	Frequency (MHz)
1	50	5250	2C	114	5570
2A					

Note: Test modes are presented at section 3.7.

3.7. Description of Key Components

3.7.1. For the All Component Lists

Item	Supplier	Model / Type	Character
System	Microsoft	Win11 Home	---
Main Board	LG	Queen MAIN B/D PCB	Main Board (GM) Manufacturer: #1 Hannstar Board Tech(Jiang Yin) Corp.,Ltd. #2 Elec & Eltek Company (MCO) Limited.
		QUEEN NVIDIA MAIN B/D PCB	Main Board (PM)* Manufacturer: #1 Hannstar Board Tech(Jiang Yin) Corp.,Ltd. #2 Elec & Eltek Company (MCO) Limited.
WLAN SUB Board	LG	16Z90Q Sub B/D	Manufacturer: #1 Hannstar Board Tech(Jiang Yin) Corp.,Ltd. #2 Elec & Eltek Company (MCO) Limited. #3 JiangSu HuaShen Electronic co.,ltd (HXF)
CPU (Socket: BGA1744)	Intel	i7-1260P	2.5GHz
	Intel	i5-1240P	2.1GHz
16" LCD Panel	LG Display	LP160WQ1(SP)(B2)	Resolution: 2560 x 1600, 60Hz WQXGA IPS (Non Touch)
Storage (SSD)	SK hynix	HFM001TD3JX013N	1TB
		HFM512GD3JX013N	512GB
		HFM256GD3JX013N	256GB
	Samsung	MZ-VL21T00	1TB
		MZ-VL25120	512GB
		MZ-VL22560	256GB
MZ-VL22T00		2TB*	
Memory (RAM)	Samsung	---	16GB LPDDR5x(On Board)
		---	8GB LPDDR5x(On Board)
		---	32GB LPDDR5x(On Board)*
	SK Hynix	---	16GB LPDDR5x(On Board)
		---	8GB LPDDR5x(On Board)
		---	32GB LPDDR5x(On Board)*
Battery Pack	LG	LBV7227E	80Wh, DC 7.74V, 80Wh Typ 10336mAh
	LG	LBV122CM	90Wh, DC 7.76V, 90Wh Typ 11600mAh
WLAN Combo Card	Intel	AX211D2W	WLAN and BT, 2x2 PCIe M.2 1216 SD adapter card FCC ID: PD9AX211D2 IC: 1000M-AX211D2
WLAN Combo Antenna	LG (INPAQ)	WA-P-LELE-04-009	PCB, Mono-pole Type Main: Black, Aux: Gray
	LG (LUXSHARE-ICT)	L1LRF008-CS-H	PCB, Mono-pole Type Main: Black, Aux: Gray

Item	Supplier	Model / Type	Character
Keyboard	TIC	KT0120B8E	---
	LITE ON	SN8101	---
Web Camera	Chicony	CKFLF26	---
	Luxvisions	1BF225N3	---
LAN Gender (Type C to LAN)	SUZHOU MEC ELECTRONICS	80-5946-111	(White) 10/100 Megabit Ethernet
		80-5946-101	(Black) 10/100 Megabit Ethernet
		80-5946-230	(White) 10/100/1000 Megabit Ethernet
		80-5946-240	(Black) 10/100/1000 Megabit Ethernet
	Type C to LAN: Shielded, Undetached, 0.12m		
	ARIN TECH CO. LTD	GD-08MF-36-WH-LP10	(White) 10/100 Megabit Ethernet
		GD-08MF-36-BK-LP11	(Black) 10/100 Megabit Ethernet
		GD-08MF-50-WH-LP12	(White) 10/100/1000 Megabit Ethernet
		GD-08MF-50-BK-LP13	(Black) 10/100/1000 Megabit Ethernet
	Type C to LAN: Shielded, Undetached, 0.12m		
AC Adapter (65W)	LG (HONOR)	ADT-65DSU-D03-2	I/P: AC 100-240V, 1.6A, 50-60Hz O/P: DC 20V, 3.25A
	DC Power Cord: Non-Shielded, Undetached, 1.5m		
	AC Power Cord: Non-Shielded, Detached, 1.0m (2C) (For Other Countries)		
	AC Power Cord: Non-Shielded, Detached, 1.55m (2C) (For US, Canada, Mexico)		
Note: “*” Standing for adding new configuration.			

Remark: For more detailed features description, please refer to the manufacturer’s specifications or the user manual.

3.7.2. The EUT collocates with the original worst mode and new components, which are used to establish a basic configuration of system during test:

SKU (Mode)		1	2
Main Board	LG, QUEEN NVIDIA MAIN B/D PCB (w/ TPM)	√	
	LG, QUEEN NVIDIA MAIN B/D PCB (w/o TPM)		√
SUB Board	LG, 16Z90Q Sub B/D (Type A)	√	√
CPU	Intel, i7-1260P	√	√
16” LCD Panel	LG Display, LP160WQ1(SP)(B2)	√	√
Storage (SSD)	Samsung, 2TB	√	√
	SK hynix, 1TB	√	√
Memory (RAM)	32GB	√	√
Battery Pack	LG, 90Wh	√	√
Keyboard	TIC, KT0120B8E	√	√
Web Camera	Chicony, CKFLF26	√	√
WLAN Combo Card	Intel, AX211D2W	√	√
WLAN Combo Antenna	LG (INPAQ), WA-P-LELE-04-009	√	
	LG (LUXSHARE-ICT), L1LRF008-CS-H		√
Type C #1	AC Adapter	√	√
Type C #2	Link to LAN Gender	√	√

3.8. Test Configuration

Mode	TX _{on} (ms)	TX _{on+off} (ms)	Duty Cycle (x)	Duty Cycle Factor [10log(1/x)] (dB)
802.11a	2.090	2.120	0.986	N/A
802.11n-HT20	7.920	7.940	0.997	N/A
802.11n-HT40	7.960	7.980	0.997	N/A
802.11ac-VHT80	7.880	7.920	0.995	N/A
802.11ac-VHT160	5.520	5.560	0.993	N/A
802.11ax-HE20	3.960	4.000	0.990	N/A
802.11ax-HE40	3.960	4.000	0.990	N/A
802.11ax-HE80	3.970	4.010	0.990	N/A
802.11ax-HE160	2.300	2.340	0.983	N/A
802.11ax-HE20 (RU Config 26)	2.590	2.620	0.989	N/A
802.11ax-HE20 (RU Config 52)	2.590	2.630	0.985	N/A
802.11ax-HE20 (RU Config 106)	2.590	2.630	0.985	N/A
802.11ax-HE40 (RU Config 242)	2.590	2.630	0.985	N/A
802.11ax-HE80 (RU Config 484)	2.590	2.630	0.985	N/A
802.11ax-HE160 (RU Config 996)	2.590	2.630	0.985	N/A

Note: When duty cycle is less than 98% (0.98) that duty cycle factor $10\log(1/x)$ is needed to add in conducted test items measured in average detector.

Mode	TX _{on} (ms)	T _{on} +T _{off} (ms)
802.11a		
802.11n-HT20		
802.11n-HT40		
802.11ac-VHT80		
802.11ac-VHT160		

Mode	TX _{on} (ms)	T _{on} +T _{off} (ms)
802.11ax-HE20	<p>Center: 5.180000000 GHz Res BW: 1.0 MHz AMK1: 3.960 MHz -7.17 dB</p>	<p>Center: 5.180000000 GHz Res BW: 1.0 MHz AMK1: 4.000 MHz -33.05 dB</p>
802.11ax-HE40	<p>Center: 5.190000000 GHz Res BW: 1.0 MHz AMK1: 3.960 MHz -14.27 dB</p>	<p>Center: 5.190000000 GHz Res BW: 1.0 MHz AMK1: 4.000 MHz -40.26 dB</p>
802.11ax-HE80	<p>Center: 5.190000000 GHz Res BW: 1.0 MHz AMK1: 3.970 MHz -9.93 dB</p>	<p>Center: 5.210000000 GHz Res BW: 1.0 MHz AMK1: 4.010 MHz -39.26 dB</p>
802.11ax-HE160	<p>Center: 5.200000000 GHz Res BW: 1.0 MHz AMK1: 2.300 MHz -1.82 dB</p>	<p>Center: 5.200000000 GHz Res BW: 1.0 MHz AMK1: 2.340 MHz -36.20 dB</p>

Mode	TX _{on} (ms)	T _{on} +T _{off} (ms)
802.11ax-HE20 (RU Config 26)		
802.11ax-HE20 (RU Config 52)		
802.11ax-HE20 (RU Config 106)		
802.11ax-HE40 (RU Config 242)		



AC Conduction	
SKU #1	Normal operation (with INPAQ Antenna)
SKU #2	Normal operation (with LUXSHARE-ICT Antenna)

Item	Mode	Data Rate	Test Channel
Radiated Test Case	SKU #1/ SKU #2	Radiated Spurious Emission ^{Note 1 & 2} (30MHz-1GHz)	802.11n-HT40 MCS8 151
	SKU #2	Radiated Spurious Emission ^{Note 1 & 2 & 3} (Above 1GHz)	802.11n-HT40 MCS8 151

Item	Mode	Data Rate	Test Channel
Conducted Test Case Maximum output power	802.11a	6 Mbps	36/40/48/52/60/64/100/116/140/ 144/149/157/165
	802.11n-HT20	MCS8	36/40/48/52/60/64/100/116/140/ 144/149/157/165
	802.11n-HT40	MCS8	38/46/54/62/102/110/134/142/ 151/159
	802.11ac-VHT80	MCS0	42/58/106/122/138/155
	802.11ac-VHT160	MCS0	50/114
	802.11ax-HE20	HE0	36/40/48/52/60/64/100/116/140/ 144/149/157/165
	802.11ax-HE40	HE0	38/46/54/62/102/110/ 134/142/151/159
	802.11ax-HE80	HE0	42/58/106/122/138/155
802.11ax-HE160	HE0	50/114	

Item		Mode	Data Rate	RU Configuration	Test Channel
Conducted Test Case	Maximum output power	802.11ax-HE20	HE0	26/0	36/100/149
				52/37	
				106/53	
			HE0	26/8	64/140/165
				52/40	
				106/5	
		802.11ax-HE40	HE0	242/61	38/102/151
			HE0	242/62	62/134/159
		802.11ax-HE80	HE0	484/65	42/106/155
			HE0	484/66	58/122/155
		802.11ax-HE160	HE0	996/67	50/114
			HE0	996/S67	50/114

Note 1: Mobile Device

Portable Device, and 3 axis were assessed. The worst scenario for Radiated Spurious Emission as follow: Lie Side Stand

Note 2: Low, mid, and high channels were measured, only the worst channel of each modulation was presented in this report.

Note 3: Both of the antennas are the same type. The max-gain condition with MIMO is SKU #2 for U-NII Band 1/2A/III and SKU #1 for U-NII Band 2C. We present worst case with maximum power. The MIMO is uncorrelated and supported SDM mode only.

Note 4: The modulation and bandwidth are similar for 802.11n mode for HT20/HT40 and 802.11ac mode for VHT20/VHT40, therefore investigated worst case to representative mode in the test report.

Note 5: The data rates were selected based on preliminary testing that identified rate as the worst case for output power.

3.9. Output Power Setting

Mode	U-NII Band	Centre Frequency (MHz)	Power Setting	
			Chain 0 (AUX)	Chain 1 (Main)
802.11a	1	5180	17.000	17.000
		5200	17.000	17.000
		5240	17.000	17.000
	2A	5260	17.000	17.000
		5300	17.000	17.000
		5320	17.000	17.000
	2C	5500	17.000	17.000
		5580	17.000	17.000
		5700	17.000	17.000
		5720	17.000	17.000
	3	5745	17.000	17.000
		5785	17.000	17.000
5825		17.000	17.000	

Mode	U-NII Band	Centre Frequency (MHz)	Power Setting	Mode	U-NII Band	Centre Frequency (MHz)	Power Setting
802.11n- HT20	1	5180	17.000	802.11ax- HE20	1	5180	17.000
		5200	17.000			5200	17.000
		5240	17.000			5240	17.000
	2A	5260	17.000		2A	5260	17.000
		5300	17.000			5300	17.000
		5320	17.000			5320	17.000
	2C	5500	17.000		2C	5500	17.000
		5580	17.000			5580	17.000
		5700	12.500			5700	15.500
		5720	17.000			5720	17.000
	3	5745	17.000		3	5745	17.000
		5785	17.000			5785	17.000
5825		17.000	5825	17.000			

Mode	U-NII Band	Centre Frequency (MHz)	Power Setting	Mode	U-NII Band	Centre Frequency (MHz)	Power Setting
802.11n- HT40	1	5190	15.000	802.11ax- HE40	1	5190	15.000
		5230	17.000			5230	17.000
	2A	5270	17.000		2A	5270	17.000
		5310	15.250			5310	15.250
	2C	5510	14.875		2C	5510	14.750
		5550	17.000			5550	17.000
		5670	17.000			5670	17.000
		5710	17.000			5710	17.000
	3	5755	17.000		3	5755	17.000
		5795	17.000			5795	17.000

Mode	U-NII Band	Centre Frequency (MHz)	Power Setting	Mode	U-NII Band	Centre Frequency (MHz)	Power Setting
802.11 ac-VT80	1	5210	14.000	802.11ax- HE80	1	5210	14.000
	2A	5290	15.250		2A	5290	15.250
	2C	5530	13.875		2C	5530	15.000
		5610	17.000			5610	17.000
		5690	17.000			5690	17.000
	3	5775	17.000		3	5775	17.000

Mode	U-NII Band	Centre Frequency (MHz)	Power Setting	Mode	U-NII Band	Centre Frequency (MHz)	Power Setting
802.11 ac- VT160	1 /2A	5250	11.000	802.11ax- HE160	1 /2A	5250	11.000
	2C	5570	13.750		2C	5570	14.000

Mode	U-NII Band	Centre Frequency (MHz)	RU Configuration	Power Setting
802.11ax-HE20	1	5180	26/0	10.000
			52/37	13.000
			106/53	16.000
	2A	5320	26/8	10.000
			52/40	13.000
			106/54	15.750
	2C	5500	26/0	10.000
			52/37	13.000
			106/53	15.250
		5700	26/8	10.000
			52/40	13.000
			106/54	16.000
3	5745	26/0	16.000	
		52/37	13.000	
		106/53	17.500	
	5825	26/8	16.000	
		52/40	13.000	
		106/54	17.000	
802.11ax-HE40	1	5190	242/61	17.000
	2A	5310	242/62	16.250
	2C	5510	242/61	17.000
		5670	242/62	17.000
	3	5755	242/61	17.000
		5795	242/62	17.000
802.11ax-HE80	1	5210	484/65	15.000
	2A	5290	484/66	12.000
	2C	5530	484/65	14.125
		5610	484/66	17.000
	3	5775	484/65	17.000
			484/66	17.000
802.11ax-HE160	1/2A	5250	996/67	14.250
			996/S67	12.500
	2C	5570	996/67	14.000
			996/S67	17.000

3.10. Tested Supporting System List

3.10.1. Support Peripheral Unit

No.	Product	Brand	Model No.	Serial No.	Approval
1.	TV	LG	22LK330-DB	N/A	N/A
2.	USB Mouse	hp	M-U0026	N/A	N/A
3.	Earphone	APPLE	N/A	N/A	N/A
4.	SD Card	ADATA	MicroSDHC Card	N/A	N/A
Partner System					
5.	AP Server	ASUS	RT-AX88U	N/A	FCC ID: MSQ-RTAXHP00 IC: 3568A-RTAXHP00

3.10.2. Cable Lists

No.	Cable Description Of The Above Support Units
1.	HDMI Cable: Shielded, Detachable, 1.2m AC Power Cord: Unshielded, Detachable, 1.8m
2.	USB Cable: Shielded, Undetachable, 2.0m
3.	Earphone Cable: Unshielded, Undetachable, 1.2m
4.	N/A
5.	AC adapter: M/N:WA-30B12, Cable: Unshielded, Detachable, 1.2m LAN cable: Unshielded, Detachable, 3.0m
6.	LAN cable: Unshielded, Detachable, 1.8m

3.11. Setup Configuration

3.11.1. EUT Configuration for Power Line & Radiated Emission

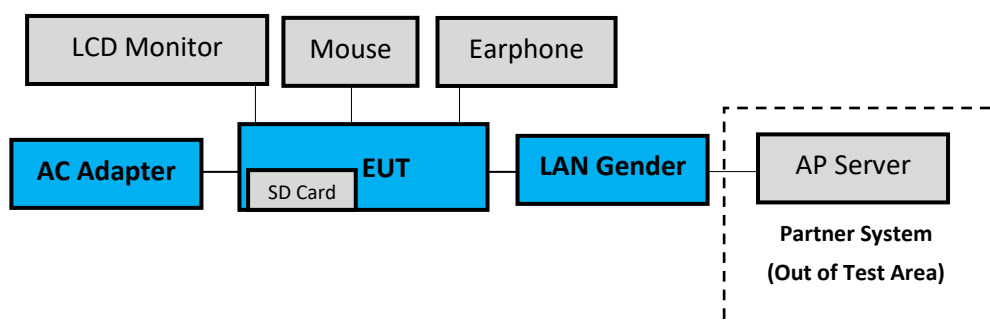

3.11.2. EUT Configuration for RF Conducted Test Items



3.12. Operating Condition of EUT

Test program “DRTU” is used for enabling EUT WLAN function under continues transmitting and choosing data rate/ channel.

[Chain 0 is aux port (A Button in DRTU) Chain 1 is main port (B Button in DRTU)].

3.13. Description of Test Facility

Name of Test Firm	Audix Technology Corporation / EMC Department No. 491, Zhongfu Rd., Linkou Dist., New Taipei City 244, Taiwan Tel: +886-2-26092133 Fax: +886-2-26099303 Website : www.audixtech.com Contact e-mail: attemc_report@audixtech.com
Accreditations	The laboratory is accredited by following organizations under ISO/IEC 17025:2017 (1) NVLAP(USA) NVLAP Lab Code 200077-0 (2) TAF(Taiwan) No. 1724
Test Facilities	FCC OET Designation Number under APEC MRA by NCC is : TW1724 ISED CAB Identifier Number under APEC TEL MRA by NCC is TW1724 (1) No.8 Shielded Room (2) No.1 3m Semi Anechoic Chamber

3.14. Measurement Uncertainty

Test Items/Facilities		Frequency Range	Uncertainty	
Conduction Test		9kHz-150kHz	±3.7dB	
		150kHz-30MHz	±3.4dB	
Radiation Test	<input checked="" type="checkbox"/>	No.1 3m Semi Anechoic Chamber	30MHz-200MHz, 3m, Horizontal	±3.8dB
			200MHz-1000MHz, 3m, Horizontal	±4.1dB
			30MHz-200MHz, 3m, Vertical	±4.5dB
			200MHz-1000MHz, 3m, Vertical	±4.5dB
			1GHz-6GHz, 3m	±4.7dB
			6GHz-18GHz, 3m	±4.1dB
			18GHz-40GHz, 3m	±3.52dB
	<input type="checkbox"/>	No.3 3m Semi Anechoic Chamber	30MHz-200MHz, 3m, Horizontal	±3.9dB
			200MHz-1000MHz, 3m, Horizontal	±4.2dB
			30MHz-200MHz, 3m, Vertical	±4.3dB
			200MHz-1000MHz, 3m, Vertical	±4.5dB
	<input type="checkbox"/>	No.4 3m Semi Anechoic Chamber	30MHz-200MHz, 3m, Horizontal	±4.1dB
			200MHz-1000MHz, 3m, Horizontal	±4.5dB
			30MHz-200MHz, 3m, Vertical	±4.4dB
			200MHz-1000MHz, 3m, Vertical	±4.8dB
			1GHz-6GHz, 3m	±5.0dB
			6GHz-18GHz, 3m	±4.7dB
	<input type="checkbox"/>	No.5 3m Semi Anechoic Chamber	30MHz-200MHz, 3m, Horizontal	±4.2dB
			200MHz-1000MHz, 3m, Horizontal	±4.3dB
			30MHz-200MHz, 3m, Vertical	±4.3dB
			200MHz-1000MHz, 3m, Vertical	±4.7dB
			1GHz-6GHz, 3m	±4.8dB
			6GHz-18GHz, 3m	±4.5dB

Remark : Uncertainty = $ku_c(y)$

Test Items	Uncertainty
Bandwidth	± 0.2kHz
Maximum output power	± 0.33dB
Power spectral density	± 0.13dB

4. MEASUREMENT EQUIPMENT LIST

4.1. Conducted Emission Measurement

Item	Type	Manufacturer	Model No.	Serial No.	Cal. Date	Cal. Interval
1.	Test Receiver	R&S	ESR3	101774	2022. 01. 11	1 Year
2.	A.M.N.	R&S	ENV4200	100169	2021. 11. 04	1 Year
3.	L.I.S.N.	Kyoritsu	KNW-407	8-855-9	2021. 12. 19	1 Year
4.	Pulse Limiter	R&S	ESH3-Z2	100354	2021. 12. 23	1 Year
5.	Digital Thermo-Hygro Meter	iMax	HTC-1	No.8 S/R	2022. 04. 14	1 Year
6.	Coaxial Cable	Yeida	RG/58AU	CE-08	2021. 09. 13	1 Year
7.	Test Software	Audix	e3	V6.120619c	N.C.R.	N.C.R.

4.2. Radiated Emission Measurement

Item	Type	Manufacturer	Model No.	Serial No.	Cal. Date	Cal. Interval
1.	Spectrum Analyzer	Agilent	N9010A-526	MY53400071	2021. 09. 09	1 Year
2.	Spectrum Analyzer	Keysight	N9010B-544	MY55460198	2022. 04. 08	1 Year
3.	Test Receiver	R&S	ESCS30	100039	2022. 04. 08	1 Year
4.	Amplifier	HP	8447D	2944A06305	2022. 01. 05	1 Year
5.	Microwave Amplifier	Keysight	83051A	MY53010042	2021. 07. 30	1 Year
6.	Microwave Amplifier	Keysight	83017A	MY53270365	2021. 05. 27	1 Year
7.	Loop Antenna	ETS • LINDGREN	6512	00035867	2021. 09. 29	1 Year
8.	Bilog Antenna	TESEQ	CBL6112D	33821	2021. 07. 16	1 Year
9.	Double-Ridged Waveguide Horn	EMCO	3115	9609-4927	2021. 07. 02	1 Year
10.	Horn Antenna	COM-POW ER	AH-840	101092	2022. 01. 06	1 Year
11.	5G Notch Filter	Microware Circuits	N0257881	459776	2021. 08. 16	1 Year
12.	Coaxial Cable	MIYAZAKI	5D2W	RE-11	2022. 01. 20	1 Year
13.	Coaxial Cable	HUBER+SU HNER	SUCOFLEX 106	RE-14	2021. 01. 29	1 Year
14.	Coaxial Cable	HUBER+SU HNER	SUCOFLEX 102	RE-30	2021. 08. 25	1 Year
15.	Digital Thermo-Hygro Meter	iMax	HTC-1	No.3 3m A/C	2022. 04. 14	1 Year
16.	Test Software	Audix	e3	V6.120619c	N.C.R.	N.C.R.

4.3. RF Conducted Measurement

Item	Type	Manufacturer	Model No.	Serial No.	Cal. Date	Cal. Interval
1.	Spectrum Analyzer	Keysight	N9030B	MY61330403	2021. 12. 21	1 Year
2.	Power Meter	Anritsu	ML2495A	1145008	2021. 06. 30	1 Year
3.	Power Sensor	Anritsu	MA2411B	1126096	2021. 06. 30	1 Year
4.	Digital Thermo-Hygro Meter	iMax	HTC-1	RF-03	2022. 04. 14	1 Year

5. CONDUCTED EMISSION

5.1. Block Diagram of Test Setup

5.1.1. Block Diagram of EUT

Indicated as section 3.11

5.1.2. Shielded Room Setup Diagram

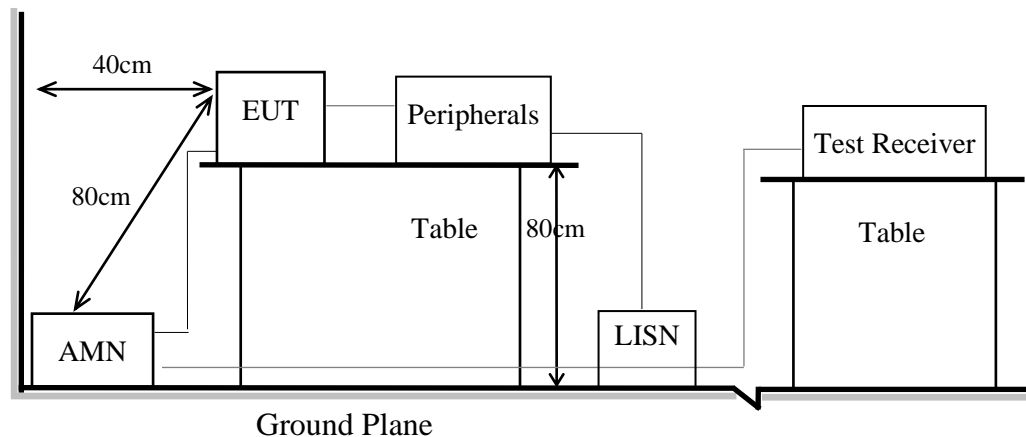

5.2. Conducted Emission Limit

Frequency	Conducted Limit	
	Quasi-Peak Level	Average Level
150kHz ~ 500kHz	66 ~ 56 dB μ V	56 ~ 46 dB μ V
500kHz ~ 5MHz	56 dB μ V	46 dB μ V
5MHz ~ 30MHz	60 dB μ V	50 dB μ V

Remark1.: If the average limit is met when using a Quasi-Peak detector, the measurement using the average detector is not required.

2.: The lower limit applies to the band edges.

5.3. Test Procedure

- 5.3.1. To set up the EUT as indicated in ANSI C63.10. The EUT was placed on the table which has 80 cm height to the ground and 40 cm distance to the conducting wall.
- 5.3.2. Power supplier of the EUT was connected to the AC mains through an Artificial Mains Network (A.M.N.).
- 5.3.3. The AC power supplies to all peripheral devices must be provided through line impedance stabilization network (L.I.S.N.)
- 5.3.4. Checking frequency range from 150kHz to 30 MHz and record the emission which does not have 20 dB below limit.



Audix Technology Corp.
No. 491, Zhongfu Rd., Linkou Dist.,
New Taipei City 244, Taiwan

Tel: +886 2 26099301
Fax: +886 2 26099303

5.4. Test Results

Please refer to Appendix A.

6. RADIATED EMISSION

6.1. Block Diagram of Test Setup

6.1.1. Block Diagram of EUT

Indicated as section 3.11

6.1.2. Setup Diagram for 9kHz-30MHz

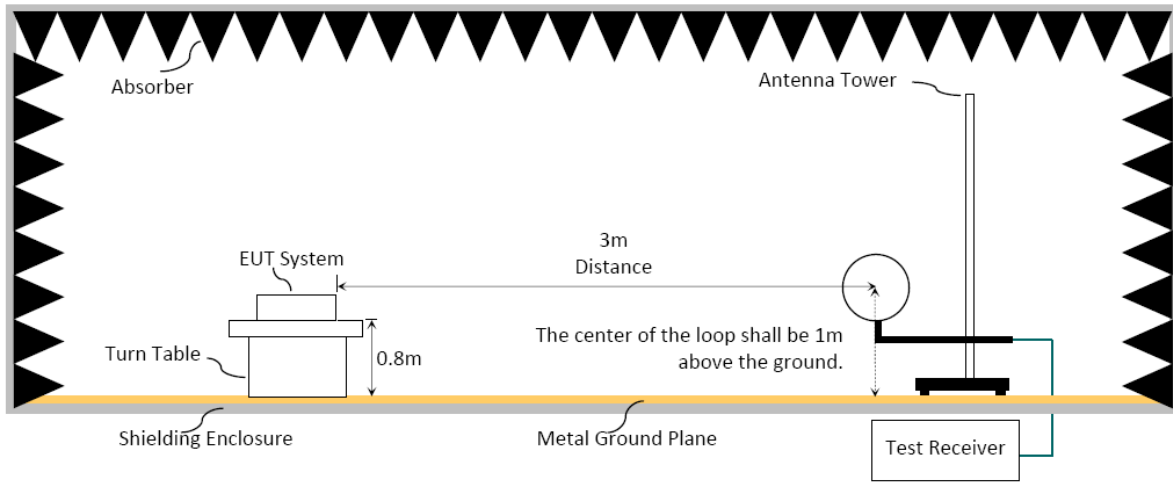

6.1.3. Setup Diagram for 30-1000MHz

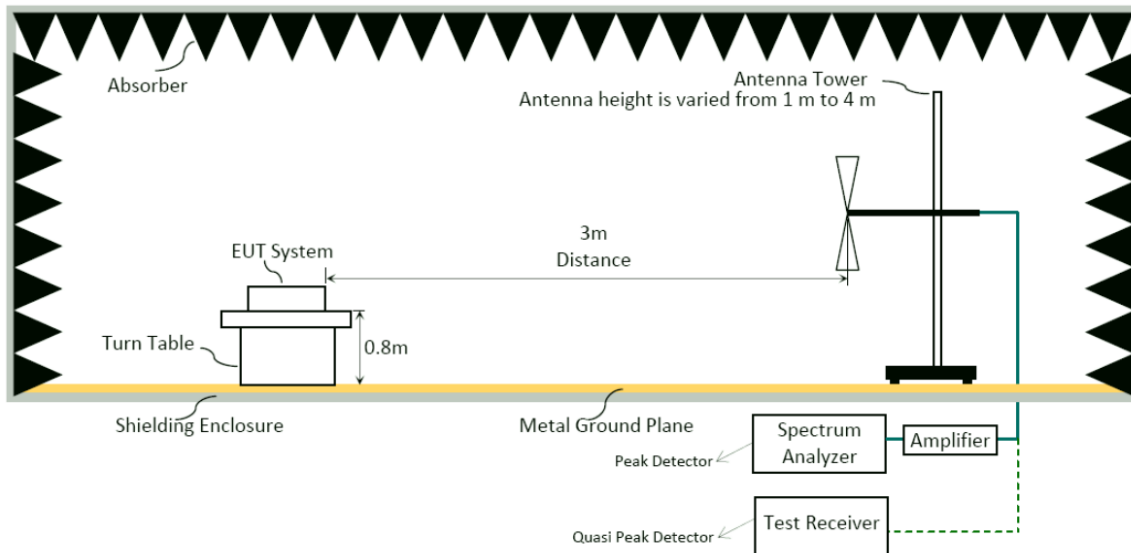

6.1.4. Setup Diagram for above 1GHz

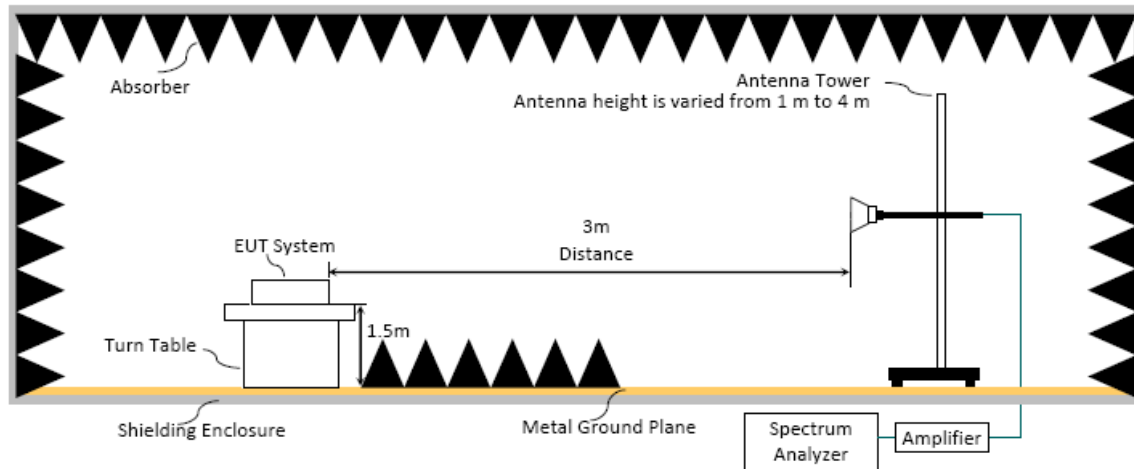

6.2. Radiated Emission Limits

Radiated emissions fall in restricted bands, as defined in Section 15.205 must be in compliance with the radiated emission limits specified in 15.209 as below.

6.2.1. General Limit

Frequency (MHz)	Distance(m)	Limits	
		dB μ V/m	μ V/m
0.009 - 0.490	300	67.6-20 log f(kHz)	2400/f kHz
0.490 - 1.705	30	87.6-20 log f(kHz)	24000/f kHz
1.705 - 30	30	29.5	30
30 - 88	3	40.0	100
88- 216	3	43.5	150
216- 960	3	46.0	200
Above 960	3	54.0	500
Above 1000	3	74.0 dB μ V/m (Peak) 54.0 dB μ V/m (Average)	

Remark : (1) dB μ V/m = 20 log (μ V/m)

- (2) The tighter limit applies to the edge between two frequency bands.
- (3) Distance refers to the distance in meters between the measuring instrument antenna and the closed point of any part of the device or system.
- (4) Fundamental and emission fall within operation band are exempted from this section.
- (5) Pursuant to ANSI C63.10: 6.6.4.3, if the maximized peak measured value complies with the average limit, then it is unnecessary to perform an average measurement.

6.2.2. Limit for non-restricted frequency above 1 GHz

Frequency Band (MHz)	E.I.R.P. Limit	Field Strength Limit at 3 m
5150 to 5250	-27 dBm	68.2
5250 to 5350		68.2
5470 to 5725		68.2

Note: Field Strength at 3 m= E.I.R.P. + 95.2 dB

Frequency Band (MHz)	Field Strength Limit at 3 m
5725 to 5850	<input checked="" type="checkbox"/> 15.407(b)(4)(i) All emissions shall be limited to a level of 68.2 dB μ V/mat 75 MHz or more above or below the band edge increasing linearly to 105.2dB μ V/m at 25 MHz above or below the band edge, and from 25 MHz above or below the band edge increasing linearly to a level of 110.8 dB μ V/m at 5 MHz above or below the band edge increasing linearly to a level of 68.2 dB μ V/m at the band edge.
	<input type="checkbox"/> 15.407(b)(4)(ii) ,compliance with the emission limits in § 15.247(d) Shall be at least 30dB below that in the 100 kHz bandwidth within the band that contains the highest level of the desired power,. Attenuation below the general limits specified in §15.209(a) is not required. In addition,radiated emissions which fall in the restricted bands, as defined in §15.205(a), must also comply with the radiated emission limits specified in §15.209(a) (see §15.205(c))

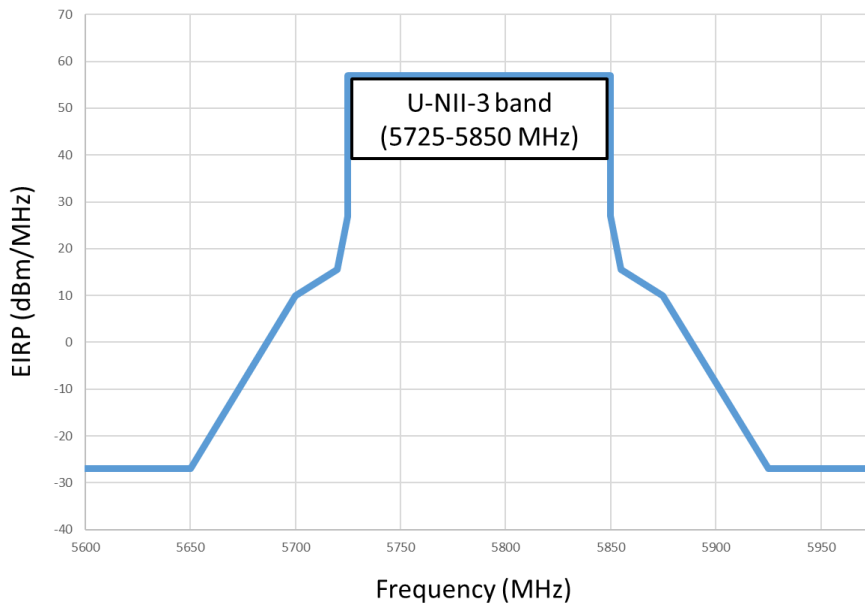

6.3. Test Procedure

Frequency Range 9kHz~30MHz:

The EUT setup on the turntable which has 0.8 m height to the ground. The turn table rotated 360 degrees and antenna fixed to 1 m to find the maximum emission level. In order to find the maximum emission, all of the interface cables were manipulated according to ANSI C63.10-2013 regulation.

- (1) RBW = 9kHz with peak and average detector.
- (2) Detector: average and peak (9kHz-490kHz)
Q.P. (490kHz-30MHz)

Frequency Range 30MHz ~ 40GHz:

The EUT setup on the turn table which has 80cm (for 30-1000MHz) and 1.5m (for above 1GHz) height to the ground. The turn table rotated 360 degrees and antenna varied from 1 m to 4 m to find the maximum emission level. Both horizontal and vertical polarization are required. In order to find the maximum emission, all of the interface cables were manipulated according to ANSI C63.10-2013 regulation.

Frequency below 1GHz:

Spectrum Analyzer is used for pre-testing with following setting:

- (1)RBW = 120kHz
- (2)VBW $\geq 3 \times$ RBW.
- (3)Detector = Peak.
- (4)Sweep time = auto.
- (5)Trace mode = max hold.
- (6)Allow sweeps to continue until the trace stabilizes.

Note 1: When peak-detected value is lower than limit that the measurement using the Q.P. detector is not required, otherwise using Q.P. for final measurement.

Note 2: When the radiated emissions limits are expressed in terms of the average value of the emissions, and pulsed operation is employed, the measurement field strength shall be determined by averaging over one complete pulse train, including blanking intervals, as long as the pulse train does not exceed 0.1 seconds.

Frequency above 1GHz to 10th harmonic(up to 40 GHz):

Peak Detector:

- (1)RBW = 1MHz
- (2)VBW $\geq 3 \times$ RBW.
- (3)Detector = Peak.
- (4)Sweep time = auto.
- (5)Trace mode = max hold.
- (6)Allow sweeps to continue until the trace stabilizes.

Note: When peak-detected value is lower than limit that the measurement using the average detector is not required, otherwise using average detector for final measurement.

Average Detector:

Option 1:

- (1) RBW = 1MHz
- (2) VBW $\geq 1/T$. (Duty Cycle < 98%, when duty cycle presented in section 3.8)
- (3) VBW = set VBW \leq RBW / 100, but not less than 10Hz (Duty Cycle \geq 98%, when duty cycle presented in section 3.8)

Modulation Type	VBW Setting(kHz)
802.11a	10Hz
802.11n-HT20	10Hz
802.11n-HT40	10Hz
802.11ac-VHT80	10Hz
802.11ac-VHT160	10Hz
802.11ax-HE20	10Hz
802.11ax-HE40	10Hz
802.11ax-HE80	10Hz
802.11ax-HE160	10Hz
802.11ax-HE20 (RU Config 26)	10Hz
802.11ax-HE20 (RU Config 52)	10Hz
802.11ax-HE20 (RU Config 106)	10Hz
802.11ax-HE40 (RU Config 242)	10Hz
802.11ax-HE80 (RU Config 484)	10Hz
802.11ax-HE160 (RU Config 996)	10Hz

- (4) Detector = Peak.
- (5) Sweep time = auto.
- (6) Trace mode = max hold.
- (7) Allow sweeps to continue until the trace stabilizes.

Option 2:

Average Emission Level(dB μ V/m)= Peak Emission Level(dB μ V/m)+ DCCF(dB).

6.4. Measurement Result Explanation

- Peak Emission Level (dB μ V/m) =Antenna Factor (dB/m) + Cable Loss (dB) + Meter Reading (dB μ V) (including Preamp factor if test used)
- Average Emission Level (dB μ V/m) =Antenna Factor (dB/m) + Cable Loss (dB) + Meter Reading (dB μ V) (including Preamp factor if test used)
- Average Emission Level (dB μ V/m)= Peak Emission Level (dB μ V/m)+ DCCF(dB)
 Duty Cycle Correction Factor (DCCF)= 20log(TX_{on}/TX_{on+off}) presented in section 3.8.
- ERP= Peak Emission Level (dB μ V/m) -95.2dB-2.14dB

6.5. Test Results

Please refer to Appendix A.

7. MAXIMUM OUTPUT POWER

7.1. Block Diagram of Test Setup

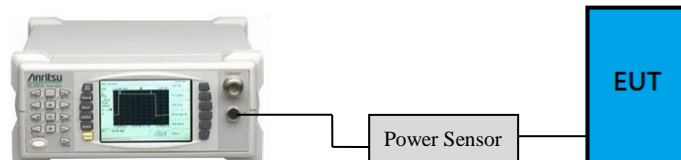

- For 802.11ac-VHT80/160, 802.11ax-HE160 modes only

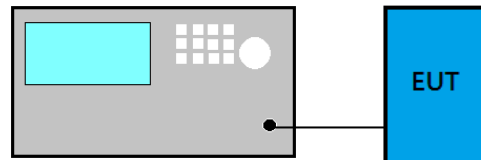

7.2. Specification Limits

Frequency Band (MHz)	Category	Limit
5150 to 5250	Outdoor Access Point	1 W(30 dBm)/ Max e.i.r.p. ≤125 mW(21 dBm) at any elevation angle above 30 degrees as measured from the horizon
	Fixed point-to-point Access Point	1 W(30 dBm)
	Indoor Access Point	1 W(30 dBm)
	Mobile and Portable client device	250 mW(24 dBm)
5250 to 5350	N/A	250 mW or 11 dBm + 10 log B ^{Note1}
5470 to 5725		250 mW or 11 dBm + 10 log B ^{Note1}
5725 to 5850		1 W(30 dBm)

Note 1: B is the 26 dB emission bandwidth, which presented in section 7 and appendix A.1.

7.3. Test Procedure

Following measurement procedure is reference to KDB 789033 D02 General UNII Test Procedures New Rules v02r01:

■ **Method AVGPM (Measurement using an RF average power meter):**

EUT is connected to power sensor and record the maximum average output power and duty cycle factor is added when duty cycle presented in section 3.8 is < 98%.

■ **Method AVGSA-2 (Spectrum channel power) for 802.11ac-VHT80/160, 802.11ax-HE80/160 modes only**

- (1) Set span to at least 1.5 times the OBW
- (2) Set RBW = 1 MHz
- (3) Set the video bandwidth (VBW) \geq 3 MHz.
- (4) Detector = RMS.
- (5) Trace mode = trace average at least 100 traces
- (6) Sweep = auto couple.
- (7) Compute power by integrating the spectrum across the OBW of the signal using the instrument's band power measurement function with band limits set equal to the OBW band edges.
- (8) Duty cycle factor is added when duty cycle presented in section 3.8 is < 98%.

7.4. Test Results

Please refer to Appendix A



8. DEVIATION TO TEST SPECIFICATIONS

【NONE】



*Audix Technology Corp.
No. 491, Zhongfu Rd., Linkou Dist.,
New Taipei City 244, Taiwan*

*Tel: +886 2 26099301
Fax: +886 2 26099303*

APPDNDIX A

TEST DATA AND PLOTS

(Model: 16Z90Q)

TABLE OF CONTENTS

A.1 CONDUCTED EMISSION	2
A.2 RADIATED EMISSION	6
A.2.1 Emissions within Restricted Frequency Bands.....	6
A.2.2 Emissions outside the frequency band.....	8
A.2.3 Emissions in Non-restricted Frequency Bands.....	8
A.3 MAXIMUM OUTPUT POWER	9
A.3.1 Average Output Power	9

A.1 CONDUCTED EMISSION

Test Date	2022/05/21	Temp./Hum.	24°C/71%
Test Voltage	AC 120V 60Hz (Via AC Adapter)	Tested By	Chucky Chiu
Test SKU	SKU #1 (with INPAQ Antenna)		

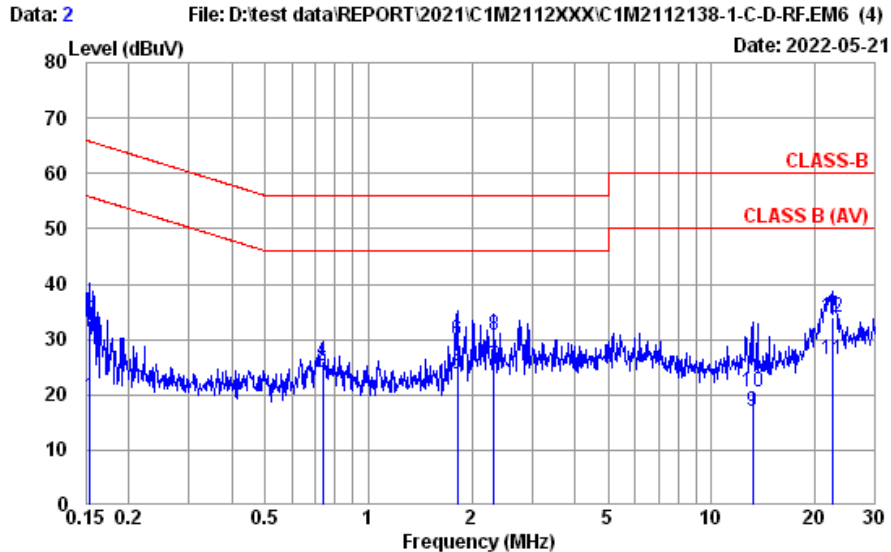

Site No.	: No.8 Shielded Room	Data No.	: 2
Instrument 1	: Receiver ESR3(774)		
Instrument 2	: EHV4200 (169)(A) CE-08 ESH3-Z2 (354)		
Limit	: CLASS-B	Phase	: NEUTRAL
Environment	: 24°C / 71%	Engineer	: Chucky Chiu
EUT Model	: 16Z90Q	Test Rating	: 120Vac/60Hz
Test Mode	: Operating		
	Inpaq		

	Freq. (MHz)	AMN Factor (dB)	Cable Loss (dB)	Pulse Att. (dB)	Reading (dBµV)	Emission Level (dBµV)	Limits (dBµV)	Margin (dB)	Remark
1	0.154	10.64	0.03	9.85	-0.77	19.75	55.78	36.03	Average
2	0.154	10.64	0.03	9.85	12.97	33.49	65.78	32.29	QP
3	0.735	10.43	0.04	9.85	3.73	24.05	46.00	21.95	Average
4	0.735	10.43	0.04	9.85	5.75	26.07	56.00	29.93	QP
5	1.819	10.46	0.06	9.86	3.33	23.71	46.00	22.29	Average
6	1.819	10.46	0.06	9.86	9.56	29.94	56.00	26.06	QP
7	2.321	10.50	0.07	9.86	4.81	25.24	46.00	20.76	Average
8	2.321	10.50	0.07	9.86	10.30	30.73	56.00	25.27	QP
9	13.197	12.23	0.16	9.90	-5.28	17.01	50.00	32.99	Average
10	13.197	12.23	0.16	9.90	-1.84	20.45	60.00	39.55	QP
11	22.416	14.38	0.20	9.95	1.96	26.49	50.00	23.51	Average
12	22.416	14.38	0.20	9.95	9.55	34.08	60.00	25.92	QP

Remarks: 1. Emission Level= AMN Factor + Cable Loss + Pulse Att. + Reading.
 2. If the average limit is met when using a quasi-peak detector, the EUT shall be deemed to meet both limits and measurement with average detector is unnecessary.

Audix Technology Corp.
 No. 491, Zhongfu Rd., Linkou Dist.,
 New Taipei City 244, Taiwan

Tel: +886 2 26099301
 Fax: +886 2 26099303

Test Date	2022/05/21	Temp./Hum.	24°C/71%
Test Voltage	AC 120V 60Hz (Via AC Adapter)	Tested By	Chucky Chiu
Test SKU	SKU #1 (with INPAQ Antenna)		

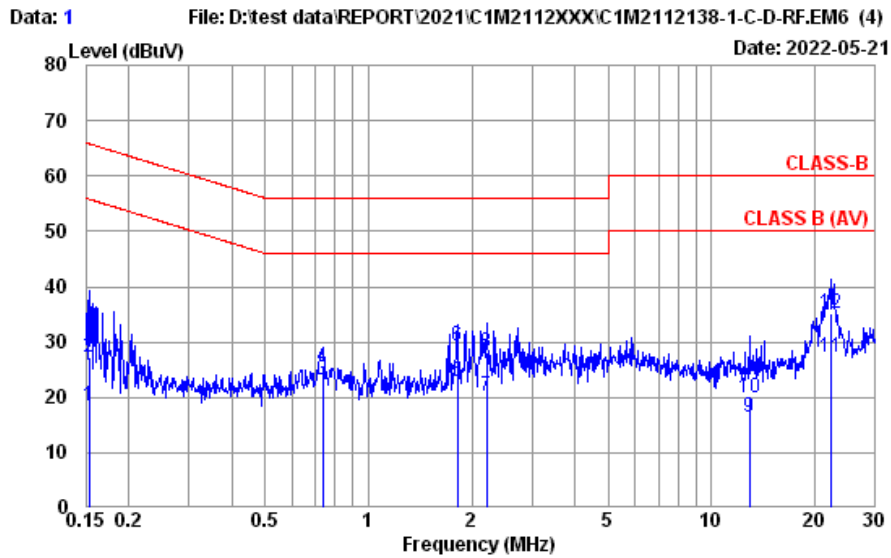

Site No.	: No.8 Shielded Room	Data No.	: 1
Instrument 1	: Receiver ESR3(774)		
Instrument 2	: EHV4200 (169)(A) CE-08 ESH3-Z2 (354)		
Limit	: CLASS-B	Phase	: LINE
Environment	: 24°C / 71%	Engineer	: Chucky Chiu
EUT Model	: 16Z90Q	Test Rating	: 120Vac/60Hz
Test Mode	: Operating Inpaq		

	Freq. (MHz)	AMI Factor (dB)	Cable Loss (dB)	Pulse Att. (dB)	Reading (dBµV)	Emission Level (dBµV)	Limits (dBµV)	Margin (dB)	Remark
1	0.153	10.60	0.03	9.85	-1.99	18.49	55.82	37.33	Average
2	0.153	10.60	0.03	9.85	6.83	27.31	65.82	38.51	QP
3	0.735	10.41	0.04	9.85	2.99	23.29	46.00	22.71	Average
4	0.735	10.41	0.04	9.85	5.22	25.52	56.00	30.48	QP
5	1.819	10.43	0.06	9.86	2.58	22.93	46.00	23.07	Average
6	1.819	10.43	0.06	9.86	8.98	29.33	56.00	26.67	QP
7	2.213	10.44	0.06	9.86	-0.12	20.24	46.00	25.76	Average
8	2.213	10.44	0.06	9.86	7.67	28.03	56.00	27.97	QP
9	12.920	11.74	0.16	9.90	-5.25	16.55	50.00	33.45	Average
10	12.920	11.74	0.16	9.90	-1.86	19.94	60.00	40.06	QP
11	22.180	13.59	0.20	9.95	3.43	27.17	50.00	22.83	Average
12	22.180	13.59	0.20	9.95	11.28	35.02	60.00	24.98	QP

Remarks: 1. Emission Level= AMI Factor + Cable Loss + Pulse Att. + Reading.
 2. If the average limit is met when using a quasi-peak detector, the EUT shall be deemed to meet both limits and measurement

Test Date	2022/05/21	Temp./Hum.	24°C/71%
Test Voltage	AC 120V 60Hz (Via AC Adapter)	Tested By	Chucky Chiu
Test SKU	SKU #2 (with LUXSHARE-ICT Antenna)		

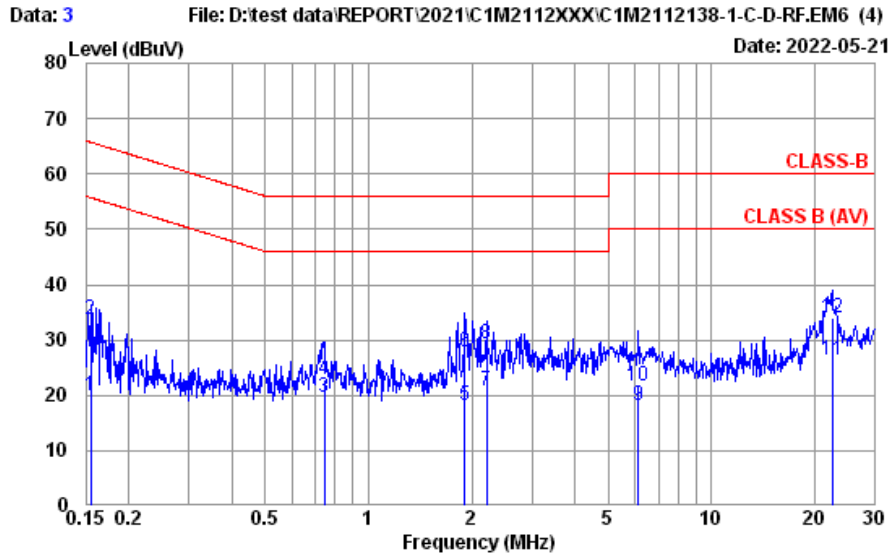

Site No. : No.8 Shielded Room Data No. : 3
 Instrument 1 : Receiver ESR3(774)
 Instrument 2 : EHV4200 (169)(A)|CE-08|ESH3-Z2 (354)
 Limit : CLASS-B Phase : NEUTRAL
 Environment : 24°C / 71% Engineer : Chucky Chiu
 EUT Model : 16Z90Q Test Rating : 120Vac/60Hz
 Test Mode : Operating
 Luxshare

	Freq. (MHz)	AMN Factor (dB)	Cable Loss (dB)	Pulse Att. (dB)	Reading (dBμV)	Emission Level (dBμV)	Limits (dBμV)	Margin (dB)	Remark
1	0.155	10.64	0.03	9.85	-0.48	20.04	55.74	35.70	Average
2	0.155	10.64	0.03	9.85	13.18	33.70	65.74	32.04	QP
3	0.743	10.43	0.04	9.85	-0.82	19.50	46.00	26.50	Average
4	0.743	10.43	0.04	9.85	2.64	22.96	56.00	33.04	QP
5	1.908	10.47	0.06	9.86	-2.17	18.22	46.00	27.78	Average
6	1.908	10.47	0.06	9.86	7.48	27.87	56.00	28.13	QP
7	2.213	10.49	0.06	9.86	0.54	20.95	46.00	25.05	Average
8	2.213	10.49	0.06	9.86	8.75	29.16	56.00	26.84	QP
9	6.121	10.94	0.11	9.87	-2.77	18.15	50.00	31.85	Average
10	6.121	10.94	0.11	9.87	0.64	21.56	60.00	38.44	QP
11	22.416	14.38	0.20	9.95	1.90	26.43	50.00	23.57	Average
12	22.416	14.38	0.20	9.95	9.42	33.95	60.00	26.05	QP

Remarks: 1. Emission Level= AMN Factor + Cable Loss + Pulse Att. + Reading.
 2. If the average limit is met when using a quasi-peak detector, the EUT shall be deemed to meet both limits and measurement with average detector is unnecessary.

Test Date	2022/05/21	Temp./Hum.	24°C/71%
Test Voltage	AC 120V 60Hz (Via AC Adapter)	Tested By	Chucky Chiu
Test SKU	SKU #2 (with LUXSHARE-ICT Antenna)		

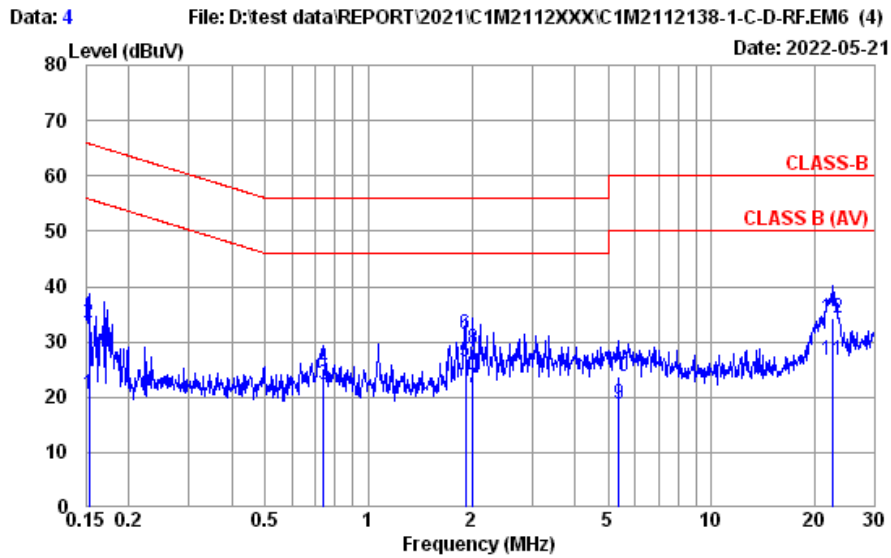

Site No.	: No.8 Shielded Room	Data No.	: 4
Instrument 1	: Receiver ESR3(774)		
Instrument 2	: EHV4200 (169)(A) CE-08 ESH3-Z2 (354)		
Limit	: CLASS-B	Phase	: LINE
Environment	: 24°C / 71%	Engineer	: Chucky Chiu
EUT Model	: 16Z90Q	Test Rating	: 120Vac/60Hz
Test Mode	: Operating Luxshare		

	Freq. (MHz)	AMN Factor (dB)	Cable Loss (dB)	Pulse Att. (dB)	Reading (dBµV)	Emission Level (dBµV)	Limits (dBµV)	Margin (dB)	Remark
1	0.153	10.60	0.03	9.85	-0.04	20.44	55.82	35.38	Average
2	0.153	10.60	0.03	9.85	12.87	33.35	65.82	32.47	QP
3	0.739	10.41	0.04	9.85	1.92	22.22	46.00	23.78	Average
4	0.739	10.41	0.04	9.85	4.82	25.12	56.00	30.88	QP
5	1.918	10.43	0.06	9.86	6.16	26.51	46.00	19.49	Average
6	1.918	10.43	0.06	9.86	10.92	31.27	56.00	24.73	QP
7	2.012	10.43	0.06	9.86	1.46	21.81	46.00	24.19	Average
8	2.012	10.43	0.06	9.86	8.36	28.71	56.00	27.29	QP
9	5.362	10.70	0.10	9.87	-1.95	18.72	50.00	31.28	Average
10	5.362	10.70	0.10	9.87	3.19	23.86	60.00	36.14	QP
11	22.535	13.70	0.21	9.96	2.85	26.72	50.00	23.28	Average
12	22.535	13.70	0.21	9.96	10.40	34.27	60.00	25.73	QP

Remarks: 1. Emission Level= AMN Factor + Cable Loss + Pulse Att. + Reading.
2. If the average limit is met when using a quasi-peak detector, the EUT shall be deemed to meet both limits and measurement with average detector is unnecessary.

A.2 RADIATED EMISSION

Test Date	2022/05/23 ~ 06/08	Temp./Hum.	22 ~ 23°C/65%
Test Voltage	AC 120V 60Hz (Via AC Adapter)	Tested By	Brian Hsieh

A.2.1 Emissions within Restricted Frequency Bands

A.2.1.1 Frequency 9kHz~30MHz

The emissions (9kHz~30MHz) not reported for there is no emission be found.

A.2.1.2 Frequency Below 1GHz

- **Test SKU #1 (with INPAQ Antenna)**

Mode	802.11n-HT40	U-NII Band	3
		Frequency	TX 5755MHz

Antenna at Horizontal Polarization

Emission Frequency (MHz)	Antenna Factor (dB/m)	Cable Loss (dB)	Preamplifier Gain (dB)	Read Level (dBμV)	Emission Level (dBμV/m)	Limits (dBμV/m)	Margin (dB)	Detector
37.760	20.13	1.59	26.48	33.46	28.70	40.00	11.30	Peak
167.740	15.40	3.39	25.91	34.85	27.73	43.50	15.77	Peak
276.380	18.67	4.49	25.64	39.38	36.90	46.00	9.10	Peak
630.430	24.45	7.27	27.41	27.52	31.83	46.00	14.17	Peak
827.340	26.05	8.36	27.20	29.07	36.28	46.00	9.72	Peak
913.670	26.41	8.83	26.93	27.48	35.79	46.00	10.21	Peak

Antenna at Vertical Polarization

Emission Frequency (MHz)	Antenna Factor (dB/m)	Cable Loss (dB)	Preamplifier Gain (dB)	Read Level (dBμV)	Emission Level (dBμV/m)	Limits (dBμV/m)	Margin (dB)	Detector
55.220	13.00	1.92	26.43	40.26	28.75	40.00	11.25	Peak
207.510	15.63	3.80	25.77	36.84	30.50	43.50	13.00	Peak
276.380	18.67	4.49	25.64	33.90	31.42	46.00	14.58	Peak
380.170	20.97	5.70	26.28	31.43	31.82	46.00	14.18	Peak
719.670	25.02	7.75	27.40	30.66	36.03	46.00	9.97	Peak
831.220	26.06	8.38	27.18	29.96	37.22	46.00	8.78	Peak

● **Test SKU #2 (with LUXSHARE-ICT Antenna)**

Mode	802.11n-HT40	U-NII Band	3
		Frequency	TX 5755MHz

Antenna at Horizontal Polarization

Emission Frequency (MHz)	Antenna Factor (dB/m)	Cable Loss (dB)	Preamplifier Gain (dB)	Read Level (dBμV)	Emission Level (dBμV/m)	Limits (dBμV/m)	Margin (dB)	Detector
82.380	13.34	2.39	26.34	40.06	29.45	40.00	10.55	Peak
148.340	16.41	3.18	26.00	42.35	35.94	43.50	7.56	Peak
267.650	18.52	4.42	25.66	38.85	36.13	46.00	9.87	Peak
378.230	20.95	5.69	26.28	31.23	31.59	46.00	14.41	Peak
485.900	22.89	6.65	27.04	34.28	36.78	46.00	9.22	Peak
741.980	25.30	7.89	27.36	36.07	41.90	46.00	4.10	Peak

Antenna at Vertical Polarization

Emission Frequency (MHz)	Antenna Factor (dB/m)	Cable Loss (dB)	Preamplifier Gain (dB)	Read Level (dBμV)	Emission Level (dBμV/m)	Limits (dBμV/m)	Margin (dB)	Detector
35.820	21.22	1.55	26.48	38.42	34.71	40.00	5.29	Peak
81.410	13.17	2.38	26.34	45.50	34.71	40.00	5.29	Peak
148.340	16.41	3.18	26.00	39.48	33.07	43.50	10.43	Peak
323.910	19.70	5.02	25.82	35.64	34.54	46.00	11.46	Peak
445.160	22.21	6.33	26.77	33.68	35.45	46.00	10.55	Peak
485.900	22.89	6.65	27.04	31.94	34.44	46.00	11.56	Peak

A.2.2 Emissions outside the frequency band

The emissions (up to 40GHz) not reported for there is no emission be found.

● **Test SKU #2 (with LUXSHARE-ICT Antenna)**

Mode	802.11n-HT40	U-NII Band	3
		Frequency	TX 5755MHz

Antenna at Horizontal Polarization

Emission Frequency (MHz)	Antenna Factor (dB/m)	Cable Loss (dB)	Preamp Gain (dB)	Read Level (dBμV)	Emission Level (dBμV/m)	Limits (dBμV/m)	Margin (dB)	Detector
11510.000	39.60	13.61	33.62	29.67	49.26	54.00	4.74	Peak

Antenna at Vertical Polarization

Emission Frequency (MHz)	Antenna Factor (dB/m)	Cable Loss (dB)	Preamp Gain (dB)	Read Level (dBμV)	Emission Level (dBμV/m)	Limits (dBμV/m)	Margin (dB)	Detector
11510.000	39.60	13.61	33.62	28.06	47.65	54.00	6.35	Peak

A.2.3 Emissions in Non-restricted Frequency Bands

Pursuant to KDB 789033 D02 General UNII Test Procedures New Rules v02r01 that emission levels below the 15.209 general radiated emissions limits is not required.

A.3 MAXIMUM OUTPUT POWER

Test Date	2022/05/23 ~ 06/22	Temp./Hum.	24 ~ 25°C/49 ~ 68%
Cable Loss	1.0dB	Tested By	Brian Hsieh
Test Voltage	AC 120V 60Hz (Via AC Adapter)		

A.3.1 Average Output Power

Mode	U-NII Band	Centre Frequency (MHz)	Average Output Power(dBm)		10log (1/X)	Max Average Output Power		Limit
			Chain 0	Chain 1		(dBm)	(W)	
802.11a	1	5180	17.32	17.31	N/A	17.32	0.054	< 250 mW (24 dBm)
		5200	16.71	17.38		17.38	0.055	
		5240	17.17	16.75		17.17	0.052	
	2A	5260	16.62	16.79		16.79	0.048	
		5300	17.41	17.48		17.48	0.056	
		5320	17.06	16.97		17.06	0.051	
	2C	5500	17.23	17.43		17.43	0.055	
		5580	16.50	16.66		16.66	0.046	
		5700	16.63	16.76		16.76	0.047	
		5720	16.78	17.13		17.13	0.052	
	3	5745	16.79	17.47		17.47	0.056	
		5785	16.5	14.12		16.50	0.045	
		5825	16.79	17.49		17.49	0.056	

Note: The results have been included cable loss.

Mode	U-NII Band	Centre Frequency (MHz)	Average Output Power(dBm)		10log (1/X)	Total Average Output Power		Limit
			Chain 0	Chain 1		(dBm)	(W)	
802.11n-HT20	1	5180	16.54	16.97	N/A	19.77	0.095	< 250 mW (24 dBm)
		5200	16.26	16.79		19.54	0.090	
		5240	16.64	16.82		19.74	0.094	
	2A	5260	16.46	16.95		19.72	0.094	
		5300	16.51	16.31		19.42	0.087	
		5320	16.15	16.91		19.56	0.090	
	2C	5500	16.81	16.94		19.89	0.097	
		5580	16.67	16.98		19.84	0.096	
		5700	12.99	12.47		15.75	0.038	
		5720	17.02	16.60		19.83	0.096	
	3	5745	16.59	16.56		19.59	0.091	
		5785	16.93	17.38		20.17	0.104	
5825		16.49	16.89	19.70	0.093			
802.11n-HT40	1	5190	15.10	15.06	N/A	18.09	0.064	< 250 mW (24 dBm)
		5230	17.41	17.23		20.33	0.108	
	2A	5270	16.72	17.22		19.99	0.100	
		5310	14.76	15.34		18.07	0.064	
	2C	5510	14.93	15.44		18.20	0.066	
		5550	17.46	17.44		20.46	0.111	
		5670	17.81	16.76		20.33	0.108	
	3	5710	17.44	16.79		20.14	0.103	
		5755	17.41	17.83		20.64	0.116	
	5795	16.70	17.41	20.08		0.102		
802.11ac-VHT80	1	5210	13.92	13.49	N/A	16.72	0.047	< 250 mW (24 dBm)
	2A	5290	14.33	14.13		17.24	0.053	
		5530	13.40	13.60		16.51	0.045	
	2C	5610	16.13	15.75		18.95	0.079	
		5690	16.08	15.57		18.84	0.077	
	3	5775	16.65	16.46		19.57	0.091	
802.11ac-VHT160	1/ 2A	5250	10.37	10.47	N/A	13.43	0.022	< 250 mW (24 dBm)
	2C	5570	12.85	13.15		16.01	0.040	

Note: The results have been included cable loss.

Mode	U-NII Band	Centre Frequency (MHz)	Average Output Power(dBm)		10log (1/X)	Total Average Output Power		Limit
			Chain 0	Chain 1		(dBm)	(W)	
802.11ax-HE20	1	5180	16.69	16.72	N/A	19.72	0.094	< 250 mW (24 dBm)
		5200	16.89	16.52		19.72	0.094	
		5240	16.93	16.95		19.95	0.099	
	2A	5260	16.95	17.25		20.11	0.103	
		5300	16.72	17.23		19.99	0.100	
		5320	16.91	16.29		19.62	0.092	
	2C	5500	16.75	16.96		19.87	0.097	
		5580	16.97	16.90		19.95	0.099	
		5700	14.99	15.45		18.24	0.067	
		5720	16.78	17.44		20.13	0.103	
	3	5745	16.90	16.86		19.89	0.097	
		5785	16.93	16.69		19.82	0.096	
5825		16.96	16.76	19.87	0.097			
802.11ax-HE40	1	5190	15.22	14.89	18.07	0.064	< 250 mW (24 dBm)	
		5230	17.44	16.88	20.18	0.104		
	2A	5270	17.21	16.65	19.95	0.099		
		5310	14.91	14.95	17.94	0.062		
	2C	5510	14.42	14.80	17.62	0.058		
		5550	17.13	16.80	19.98	0.100		
		5670	16.84	17.27	20.07	0.102		
		5710	17.14	16.72	19.95	0.099		
	3	5755	16.93	17.48	20.22	0.105		
		5795	16.87	17.04	19.97	0.099		
802.11ax-HE80	1	5210	13.28	13.32	16.31	0.043	< 250 mW (24 dBm)	
	2A	5290	14.14	14.08	17.12	0.052		
		5530	13.67	14.01	16.85	0.048		
	2C	5610	15.74	15.95	18.86	0.077		
		5690	15.76	15.81	18.80	0.076		
	3	5775	15.86	16.42	19.16	0.082		
802.11ax-HE160	1/2A	5250	10.42	10.23	13.34	0.022	< 250 mW (24 dBm)	
	2C	5570	13.25	13.46	16.37	0.043		

Note: The results have been included cable loss.

Mode	U-NII Band	Centre Frequency (MHz)	RU Configuration	Average Output Power(dBm)		10log (1/X)	Total Average Output Power		Limit
				Chain 0	Chain 1		(dBm)	(W)	
802.11ax-HE20	1	5180	26/0	9.39	9.66	N/A	12.54	0.018	< 250 mW (24 dBm)
			52/37	12.81	12.81		15.82	0.038	
			106/53	15.93	15.47		18.72	0.074	
	2A	5320	26/8	10.05	9.65		12.86	0.019	
			52/40	12.80	12.58		15.70	0.037	
			106/54	15.46	15.27		18.38	0.069	
	2C	5500	26/0	9.99	9.28		12.66	0.018	
			52/37	12.60	12.37		15.50	0.035	
			106/53	14.39	14.68		17.55	0.057	
		5700	26/8	9.51	9.78		12.66	0.018	
			52/40	13.37	13.35		16.37	0.043	
			106/54	15.87	15.81		18.85	0.077	
	3	5745	26/0	15.35	15.58		18.48	0.070	
			52/37	12.52	13.00		15.78	0.038	
			106/53	17.42	14.78		19.31	0.085	
		5825	26/8	15.26	15.46		18.37	0.069	
			52/40	13.05	13.46		16.27	0.042	
			106/54	16.79	16.90		19.86	0.097	
802.11ax-HE40	1	5190	242/61	16.46	16.56	N/A	19.52	0.090	< 250 mW (24 dBm)
	2A	5310	242/62	15.57	16.12		18.86	0.077	
	2C	5510	242/61	17.00	16.68		19.85	0.097	
		5670	242/62	17.29	17.30		20.31	0.107	
	3	5755	242/61	16.57	16.77		19.68	0.093	
		5795	242/62	16.54	16.90		19.73	0.094	

Note: The results have been included cable loss.

Mode	U-NII Band	Centre Frequency (MHz)	RU Configuration	Average Output Power(dBm)		10log (1/X)	Total Average Output Power		Limit
				Chain 0	Chain 1		(dBm)	(W)	
802.11ax-HE80	1	5210	484/65	15.12	14.96	N/A	18.05	0.064	< 250 mW (24 dBm)
	2A	5290	484/66	11.77	11.64		14.72	0.030	
	2C	5530	484/65	14.18	14.43		17.32	0.054	
		5610	484/66	16.57	16.92		19.76	0.095	
	3	5775	484/65	16.58	17.13		19.87	0.097	< 1 W (30 dBm)
			484/66	16.94	17.25		20.11	0.103	
802.11ax-HE160	1/2A	5250	996/67	12.79	13.00	N/A	15.91	0.039	< 250 mW (24 dBm)
			996/S67	11.60	11.82		14.72	0.030	
	2C	5570	996/67	13.48	13.43		16.47	0.044	
			996/S67	15.78	16.28		19.05	0.080	

Note: The results have been included cable loss.



Audix Technology Corp.
No. 491, Zhongfu Rd., Linkou Dist.,
New Taipei City 244, Taiwan

Tel: +886 2 26099301
Fax: +886 2 26099303

APPDNDIX B

TEST PHOTOGRAPHS

(Model: 16Z90Q)