

FCC 15.407 WLAN 6GHz Test Report

for

LG Electronics Inc.

**222, LG-ro, Jinwi-myeon Pyeongtaek-Si, Gyeonggi-Do,
17709 Republic of Korea**

Product Name : Notebook Computer
**Model Name : (1)16U75R (2)16UD75R
(3)16UB75R (4)16UG75R**
Brand : LG
FCC ID : BEJNT-16U75R

**Prepared by: : AUDIX Technology Corporation,
EMC Department**



The test report is based on a single evaluation of one sample of the above-mentioned products. It does not imply an assessment of the whole production and does not permit the use of the test lab logo.

TABLE OF CONTENTS

Description	Page
TEST REPORT.....	4
1. REVISION RECORD OF TEST REPORT	5
2. SUMMARY OF TEST RESULTS	6
3. GENERAL INFORMATION	7
3.1. Description of Application	7
3.2. Description of EUT	8
3.3. Reference Test Guidance.....	9
3.4. Antenna Information	9
3.5. EUT Specifications Assessed in Current Report	10
3.6. Description of Key Components	13
3.7. Test Configuration.....	16
3.8. Output Power Setting	23
3.9. Tested Supporting System List.....	24
3.10. Setup Configuration.....	25
3.11. Operating Condition of EUT	25
3.12. Description of Test Facility	26
3.13. Measurement Uncertainty	27
4. MEASUREMENT EQUIPMENTLIST.....	28
4.1. Conducted Emission Measurement	28
4.2. Radiated Emission Measurement	29
4.3. RF Conducted Measurement	30
4.4. Contention Based Protocol Measurement	30
5. CONDUCTED EMISSION.....	31
5.1. Block Diagram of Test Setup	31
5.2. Conducted Emission Limit	31
5.3. Test Procedure	31
5.4. Test Results	31
6. RADIATED EMISSION	32
6.1. Block Diagram of Test Setup	32
6.2. Radiated Emission Limits.....	34
6.3. Test Procedure	35
6.4. Measurement Result Explanation.....	37
6.5. Test Results	37
7. MAXIMUM POWER SPECTRAL DENSITY.....	38
7.1. Block Diagram of Test Setup	38
7.2. Specification Limits.....	38
7.3. Test Procedure	38
7.4. Test Results	38
8. MAXIMUM CONDUCTED OUTPUT POWER	39
8.1. Block Diagram of Test Setup	39
8.2. Specification Limits.....	39
8.3. Test Procedure	40
8.4. Test Results	40
9. EMISSION/OCCUPIED BANDWIDTH.....	41

9.1. Block Diagram of Test Setup	41
9.2. Specification Limits.....	41
9.3. Test Procedure	41
9.4. Test Results	41
10. UNDERSIRABLE EMISSIONS LIMITS: SPURIOUS EMISSION (CONDUCTED)	42
10.1. Block Diagram of Test Setup	42
10.2. Spurious Emission Specification Limits.....	42
10.3. Test Procedure	42
10.4. Test Results	42
11. IN-BAND EMISSION (CHANNEL MASK).....	43
11.1. Block Diagram of Test Setup	43
11.2. Specification Limits.....	43
11.3. Test Procedure	43
11.4. Test Results	44
12. CONTENTION BASED PROTOCOL	45
12.1. Block Diagram of Test Setup	45
12.2. Specification Limits.....	45
12.3. Test Procedure	47
12.4. Test Results	47
13. DEVIATION TO TEST SPECIFICATIONS	48

APPENDIX A TEST DATA AND PLOTS
APPENDIX B TEST PHOTOGRAPHS

TEST REPORT

Applicant : LG Electronics Inc.
Manufacturer : LG Electronics Inc.
Factory : LG Electronics Nanjing New Technology Co., Ltd.
EUT Description
(1) Product : Notebook Computer
(2) Model : (1)16U75R (2)16UD75R (3)16UB75R (4)16UG75R
(3) Brand : LG
(4) Power Supply: DC 19V, 3.42A

Applicable Standards:

Title 47 FCC CFR Part 15 Subpart E

Audix Technology Corp. tested the equipment mentioned in accordance with the requirements set forth in the above standards. Test results indicate that the equipment tested is capable of demonstrating compliance with the requirements as documented within this report.

Audix Technology Corp. does not assume responsibility for any conclusions and generalizations drawn from the test results with regard to other specimens and samples.

Date of Report: 2023. 04. 10

Reviewed by:



(Annie Yu/Administrator)

Approved by:



(Johnny Hsueh/Section Manager)

1. REVISION RECORD OF TEST REPORT

Edition No	Issued Date	Revision Summary	Report Number
0	2023. 04. 10	Original Report	EM-F230160

2. SUMMARY OF TEST RESULTS

FCC Part Section(s)	Description	Results
15.207	Conducted Emission	PASS
15.205/15.209 15.407 (b)(6)	Radiated Band Edge and Radiated Spurious Emission	PASS
15.407(a)(8)	Maximum Power Spectral Density	PASS
15.407(a)(8)	Maximum Conducted Output Power	PASS
2.1049 15.407(a)(10)	Emission/Occupied Bandwidth	PASS
15.407(b)(6)	Undesirable emission limits: Spurious Emission (Conducted)	PASS
15.407(b)(7)	In-Band Emission (Channel Mask)	PASS
15.407(d)(6)	Contention Based Protocol	PASS
15.203	Antenna Requirement	PASS
Note: The uncertainties value is not used in determining the result.		

3. GENERAL INFORMATION

3.1. Description of Application

Applicant	LG Electronics Inc. 222, LG-ro, Jinwi-myeon Pyeongtaek-Si, Gyeonggi-Do, 17709 Republic of Korea
Manufacturer	LG Electronics Inc. 222, LG-ro, Jinwi-myeon Pyeongtaek-Si, Gyeonggi-Do, 17709 Republic of Korea
Factory	LG Electronics Nanjing New Technology Co., Ltd. No.346, Yaoxin Road, Economic & Technical Development Zone, Nanjing, China.
Product	Notebook Computer
Model	(1)16U75R (2)16UD75R (3)16UB75R (4)16UG75R The difference between all models is different in the sales customers and color difference.
Brand	LG

3.2. Description of EUT

Test Model	16U75R		
Serial Number	N/A		
Power Rating	DC 19V, 3.42A		
Software Version	XY (X, Y can be 0 to 9 for different SW version not influence RF parameter)		
RF Features	WLAN:802.11 a/b/g/n/ac/ax Bluetooth: BT and BLE (BT 5.1)		
Transmit Type	2.4 GHz		
	802.11b		1T1R
	802.11g		1T1R
	802.11n-HT20		2T2R
	802.11n-HT40		2T2R
	802.11ax-HE20		2T2R
	802.11ax-HE40		2T2R
	BT/BLE		1T1R
	U-NII Bands		
	802.11a		1T1R
	802.11n-HT20/802.11ac-VHT20/802.11ax-HE20		2T2R
	802.11n-HT40/802.11ac-VHT40/802.11ax-HE40		2T2R
	802.11ac-VHT80/802.11ax-HE80		2T2R
	802.11ac-VHT160/802.11ax-HE160		2T2R
	The MIMO is uncorrelated and supported SDM(Spatial Division Multiplexing) mode only. This radio device doesn't support beamforming and Cyclic Delay Diversity (CDD).		
Device Category	<input type="checkbox"/> Outdoor Access Point <input type="checkbox"/> Fixed point-to-point Access Point <input type="checkbox"/> Indoor Access Point <input checked="" type="checkbox"/> Mobile and Portable client device		
Test Sample	Sample No.	Test Item	Firmware
	01	AC Conduction, RSE, RF Conducted	N/A
Sample Status	Trial sample		
Date of Receipt	2023. 03. 03		
Date of Test	2023. 03. 07 ~ 04. 07		

Interface Ports of EUT	<ul style="list-style-type: none"> • One USB Type C Port • One Earphone Port • One HDMI Port • One DC In Port • One Memory Card Slot • Two USB 3.0 Ports
Accessories Supplied	<ul style="list-style-type: none"> • AC Adapter • LAN Gender

3.3. Reference Test Guidance

ANSI C63.10:2013

KDB 789033 D02 v02r01, KDB 662911 D01 v02r01, KDB 987594 D02 v01r01

3.4. Antenna Information

No.	Antenna Part Number	Manufacture	Antenna Type	Frequency (MHz)	Gain(dBi)	
					Main	AUX
1.	WA-P-LE-02-080	INPAQ	Mono-Pole	2400	2.6	2.7
				2450	2.7	2.2
				2500	2.4	1.5
				5150	2.6	2.3
				5400	2.7	2.4
				5850	2.8	2.2
				5925	2.6	1.6
				6525	2.2	2.0
				7125	2.1	2.6

According to KDB 662911 D01 d) ii), transmit signals are completely uncorrelated, then

$$\text{Directional gain} = 10 \log[(10^{G1/10} + 10^{G2/10} + \dots + 10^{GN/10})/N_{\text{ANT}}] \text{ dBi}$$

Note : WLAN 2.4GHz: Directional gain =

$$5925\text{MHz: Directional gain} = 10 \log[(10^{2.6/10} + 10^{1.6/10})/2] = 2.13\text{dBi}$$

$$6525\text{MHz: Directional gain} = 10 \log[(10^{2.2/10} + 10^{2.0/10})/2] = 2.10\text{dBi}$$

$$7125\text{MHz: Directional gain} = 10 \log[(10^{2.1/10} + 10^{2.6/10})/2] = 2.36\text{dBi}$$

We chose the antenna gain corresponding to the frequency listed on the table which is closer to center frequency of WLAN/BT.

3.5. EUT Specifications Assessed in Current Report

Mode	U-NII Band	Fundamental Range (MHz)	Channel Number
802.11ax-HE20	5	5955-6415	24
	6	6435-6515	5
	7	6535-6855	17
	8	6875-7115	13
802.11ax-HE40	5	5965-6405	12
	6	6445-6485	2
	7	6525-6845	9
	8	6885-7085	6
802.11ax-HE80	5	5985-6385	6
	6	6465-6545	2
	7	6625-6785	3
	8	6865-7025	3
802.11ax-HE160	5	6025-6345	3
	6	6505	1
	7	6665-6825	2
	8	6985	1

Mode	Modulation	Data Rate (Mbps)
802.11ax-HE20	OFDMA (BPSK/ QPSK/ 16QAM/ 64QAM/ 256QAM/1024QAM)	Up to 287
802.11ax-HE40		Up to 574
802.11ax-HE80		Up to 1201
802.11ax-HE160		Up to 2402

Channel List								
802.11ax-HE20								
U-NII Band	Channel Number	Freq. (MHz)	U-NII Band	Channel Number	Freq. (MHz)	U-NII Band	Channel Number	Freq. (MHz)
5	2	5955	5	81	6335	7	161	6755
	5	5975		85	6375		165	6775
	9	5995		89	6395		169	6795
	13	6015		93	6415		173	6815
	17	6035		97	6435		177	6835
	21	6055	6	101	6455	181	6855	
	25	6075		105	6475	185	6875	
	29	6095		109	6495	189	6895	
	33	6115		113	6515	193	6915	
	37	6135	7	117	6535	197	6935	
	41	6155		121	6555	201	6955	
	45	6175		125	6575	205	6975	
	49	6195		129	6595	209	6995	
	53	6215		133	6615	213	7015	
	57	6235		137	6635	217	7035	
	61	6255		141	6655	221	7055	
	65	6275		145	6675	225	7075	
	69	6295		149	6695	229	7095	
	73	6315		153	6715	233	7115	
	77	6335	157	6735				

Channel List								
802.11ax-HE40								
U-NII Band	Channel Number	Freq. (MHz)	U-NII Band	Channel Number	Freq. (MHz)	U-NII Band	Channel Number	Freq. (MHz)
5	3	5965	5	83	6365	7	163	6765
	11	6005		91	6405		171	6805
	19	6045		99	6445		179	6845
	27	6085	6	107	6485	187	6885	
	35	6125	7	115	6525	195	6925	
	43	6165		123	6565	203	6965	
	51	6205		131	6505	211	7005	
	59	6245		139	6645	219	7045	
	67	6285		147	6685	227	7085	
	75	6325		155	6725			

Channel List								
802.11ax-HE80								
U-NII Band	Channel Number	Freq. (MHz)	U-NII Band	Channel Number	Freq. (MHz)	U-NII Band	Channel Number	Freq. (MHz)
5	7	5985	5	87	6385	7	167	6785
	23	6065	6	103	6465	8	183	6865
	39	6145		119	6545		199	6945
	55	6225	7	135	6625		215	7025
	71	6305		151	6705			

Channel List					
802.11ax-HE160					
U-NII Band	Channel Number	Frequency (MHz)	U-NII Band	Channel Number	Frequency (MHz)
5	15	6025	7	143	6665
	47	6185	8	175	6825
	79	6345		207	6985
6	111	6505			

Note: Test modes are presented at section 3.7.

3.6. Description of Key Components

3.6.1. For the All Component Lists

Item	Supplier	Model / Type	Character
System	Microsoft	Win11 Home	---
		Win11 Pro	
Main Board	LG	16U75R MAIN B/D	Manufacturer: #1 Hannstar Board Tech (Jiang Yin) Corp.,Ltd. #2 Elec&Eltek Company (MCO) Limited.
WLAN SUB Board	LG	16U75R SUB B/D	Manufacturer: #1 HannstarBoardTech(Jiang Yin)Corp.,Ltd. #2Elec&Eltek Company (MCO) Limited.
CPU (Socket: BGA1744)	Intel	i7-1365U	1.8GHz
	Intel	i5-1345U	1.6GHz
16" LCD Panel	LG Display	LP160WU1	WUXGA (1920*1200) IPS LCD
	LG Display	LP160WQ1	WQXGA (2560*1600) IPS LCD, 60Hz
Storage (SSD)	SK hynix	---	256GB
		---	512GB
		---	1TB
	Samsung	---	256GB
		---	512GB
		---	1TB
Memory (RAM)	Samsung	---	16GB LPDDR5x(On Board)
		---	8GB LPDDR5x(On Board)
	SK Hynix	---	16GB LPDDR5x(On Board)
		---	8GB LPDDR5x(On Board)
Battery Pack	LG	LBZ722DM	72Wh, DC7.76V, Typ9279mAh
WLAN Combo Card	Intel	AX211D2W	WLAN and BT, 2x2 PCIe M.2 1216 SD adapter card FCC ID: PD9AX211D2 IC: 1000M-AX211D2
WLAN Combo Antenna	LG (INPAQ)	WA-P-LE-02-080	PCB, Mono-pole Type Main: Black, Aux: Gray
Keyboard	TIC	KT0120B8	---
	LITE-ON	SN8B01	---
Touch Pad	Lite-On	EBD63285207	---
	Elan	EBD62827905	---
Web Camera	Luxvisions Innovation Limited	1BF115N3	HD Webcam with Mic

Item	Supplier	Model / Type	Character
LAN Gender (Type C to LAN)	SUZHOU MEC ELECTRONICS	80-5946-111	(White) 10/100Megabit Ethernet
		80-5946-101	(Black) 10/100 Megabit Ethernet
	ARIN TECH CO. LTD	GD-08MF-36-WH-LP10	(White) 10/100Megabit Ethernet
		GD-08MF-36-BK-LP11	(Black) 10/100 Megabit Ethernet
	HUIZHOU DEHONG TECHNOLOGY CO.,LTD	370-50713	(White) 10/100Megabit Ethernet
		370-50714	(Black) 10/100 Megabit Ethernet
Type C to LAN: Shielded, Undetached, 0.12m			
AC Adapter	LG (HONOR)	ADS-65AI-19-3 19065E	Manufacturer: HONOR I/P: AC 100-240V, 1.5A, 50/60Hz O/P: DC 19V, 3.42A
	DC Power Cord: Non-Shielded, Undetached, 1.5m, With one ferrite core AC Power Cord: Non-Shielded, Detached, 1.8m (3C)		

Remark: For more detailed features description, please refer to the manufacturer's specifications or the user manual.

3.6.2. The EUT collocates with following worst components, which are used to establish a basic configuration of system during test:

SKU (Mode) 1		
Main Board		LG, 16U75R MAIN B/D
SUB Board		LG, 16U75R SUB B/D
CPU		Intel, i7-1365U
16" LCD Panel		LG Display, LP160WU1
Storage (SSD)		Samsung, 1TB
Memory (RAM)		SK hynix, 16GB
Battery Pack		LG, 72Wh
Keyboard		TIC, KT0120B8
Touch Pad		LITE-ON, EBD63285207
Web Camera		Luxvisions, 1BF115N3
WLAN Combo Card		Intel, AX211D2W
WLAN Combo Antenna		LG (INPAQ), WA-P-LE-02-080
AC Adapter		LG (HONOR), ADS-65AI-19-3 19065E
Type C	Link to LAN Gender	MEC (Black)

3.7. Test Configuration

Mode	TX _{on} (ms)	1/ TX _{on} (kHz)	TX _{on+off} (ms)	Duty Cycle (x)	Duty Cycle Factor [10log(1/x)] (dB)
802.11ax-HE20	2.600	0.385	2.650	0.981	N/A
802.11ax-HE40	2.600	0.385	2.650	0.981	N/A
802.11ax-HE80	2.600	0.385	2.640	0.985	N/A
802.11ax-HE160	2.290	0.437	2.330	0.983	N/A
RU (26T)	0.760	1.316	0.800	0.950	0.223
RU (52T)	1.460	0.685	1.500	0.973	0.119
RU (106T)	3.040	0.329	3.080	0.987	N/A
RU (242T)	1.410	0.709	1.460	0.966	0.150
RU (484T)	2.780	0.360	2.830	0.982	N/A
RU (996T)	1.330	0.752	1.380	0.964	0.159

Note: When duty cycle is less than 98% (0.98) that duty cycle factor $10\log(1/x)$ is needed to add in conducted test items measured in average detector.

Mode	TX _{on} (ms)	T _{on} +T _{off} (ms)
802.11ax-HE20		
802.11ax-HE40		
802.11ax-HE80		
802.11ax-HE160		

Mode	TX _{on} (ms)	T _{on} +T _{off} (ms)
RU (26T)		
RU (52T)		
RU (106T)		
RU (242T)		

Mode	TX _{on} (ms)	T _{on} +T _{off} (ms)
RU (484T)		
RU (996T)		

AC Conduction	
Normal operation	

Item	Mode	Data Rate	Test Channel
Radiated Test Case Radiated Spurious Emission (30MHz~1GHz)	802.11ax-HE160	HE0	15

● OFDM Modulation

Item	Mode	Data Rate	Test Channel	
Radiated Test Case	Radiated Spurious Emission (Above 1GHz)	802.11ax-HE20	HE0	2/113/117/185
		802.11ax-HE40	HE0	3/107/115/227
		802.11ax-HE80	HE0	7/103/135/199
		802.11ax-HE160	HE0	15/111/143/207
	Band Edge	802.11ax-HE20	HE0	2/233
		802.11ax-HE40	HE0	3/227
		802.11ax-HE80	HE0	7/215
		802.11ax-HE160	HE0	15/207

Item	Mode	Data Rate	Test Channel	
Conducted Test Case	Maximum Power Spectral Density/ Maximum Conducted Output power/ Emission/ Occupied Bandwidth	802.11ax-HE20	HE0	2/45/93/97/105/113/117/149/181/185/209/233
		802.11ax-HE40	HE0	3/43/91/99/107/115/147/179/187/211/227
		802.11ax-HE80	HE0	7/39/87/103/119/135/151/167/183/199/215
		802.11ax-HE160	HE0	15/47/79/111/143/175/207
	Band Edge	802.11ax-HE20	HE0	2/233
		802.11ax-HE40	HE0	3/227
		802.11ax-HE80	HE0	7/215
		802.11ax-HE160	HE0	15/207
	Spurious Emission	802.11ax-HE20	HE0	2/113/117/185
		802.11ax-HE40	HE0	3/107/115/227
		802.11ax-HE80	HE0	7/103/135/199
		802.11ax-HE160	HE0	15/111/143/207

Item		Mode	Data Rate	Test Channel
Conducted Test Case	In-Band Emission (Channel Mask)	802.11ax-HE20	HE0	2/45/93/97/105/113/117/149/181/185/209/233
		802.11ax-HE40	HE0	3/43/91/99/107/115/147/179/187/211/227
		802.11ax-HE80	HE0	7/39/87/103/119/135/151/167/183/199/215
		802.11ax-HE160	HE0	15/47/79/111/143/175/207
	Contention Based Protocol	802.11ax-HE20	HE0	45/105/149/209
		802.11ax-HE160	HE0	47/111/143/207

● OFDMA Modulation

Item		Tones	RU Index	Mode	Data Rate	Test Channel		
Radiated Test Case	Radiated Spurious Emission (Above 1GHz) ^{Note 4}	26T	18	802.11ax-HE80	HE0	7		
		52T	39	802.11ax-HE20	HE0	2		
		106T	56	802.11ax-HE80	HE0	7		
		242T	62	802.11ax-HE160	HE0	47		
		484T	65	802.11ax-HE80	HE0	119		
		996T	67	802.11ax-HE160	HE0	79		
	Band Edge ^{Note 5}	26T	0	802.11ax-HE20	HE0	2		
			37	802.11ax-HE20	HE0	2		
			40	802.11ax-HE20	HE0	233		
		52T	44	802.11ax-HE40	HE0	227		
			53	802.11ax-HE20	HE0	2		
			54	802.11ax-HE20	HE0	233		
		106T	56	802.11ax-HE40	HE0	227		
			61	802.11ax-HE20	HE0	2		
			61	802.11ax-HE20	HE0	2233		
		242T	61	802.11ax-HE80	HE0	7		
			62	802.11ax-HE40	HE0	227		
			65	802.11ax-HE80	HE0	7		
		484T	65	802.11ax-HE40	HE0	227		
			67	802.11ax-HE160	HE0	15		
		996T	67	802.11ax-HE80	HE0	215		
			26T	8	802.11ax-HE20	HE0	233	
		Band Edge- Marker Delta						

Item	Tones	RU Index	Mode	Data Rate	Test Channel	
Conducted Test Case	Maximum Power Spectral Density/ In-Band Emission (Channel Mask) ^{Note 4}	26T	18	802.11ax-HE80	HE0	7
		52T	39	802.11ax-HE20	HE0	2
		106T	56	802.11ax-HE80	HE0	7
		242T	62	802.11ax-HE160	HE0	47
		484T	65	802.11ax-HE80	HE0	119
		996T	67	802.11ax-HE160	HE0	79
	Maximum Conducted Output power	802.11ax-HE20	26T	0/4/8	HE0	2/45/93/97/ 105/113/117/ 149/181/185/ 209/233
			52T	37/39/40		
			106T	53/54		
			242T	61		
		802.11ax-HE40	26T	0/8/17	HE0	3/43/91/99/10 7/115/147/179 /187/211/227
			52T	37/40/44		
			106T	53/54/56		
			242T	61/62		
		802.11ax-HE80	26T	0/18/36	HE0	7/39/87/103/1 19/135/151/16 7/183/199/215
			52T	37/44/52		
			106T	53/56/60		
			242T	61/62/64		
		802.11ax-HE160	26T	0/18/36 S0/S18/S36	HE0	15/47/79/111/ 143/175/207
			52T	37/44/52 S37/S44/S52		
			106T	53/56/60 S53/S56/S60		
			242T	61/62/64 S61/S62/S64		
			484T	65/66 S65/S66		
			996T	65/S67		

- Note 1: Mobile Device Portable Device
 and 3 axis were assessed. The worst scenario for Radiated Spurious Emission as follow:
 Lie Side Stand
- Note 2: Low, mid, and high channels were measured, only the worst channel of each modulation was presented in this report.
- Note 3: The data rates were selected based on preliminary testing that identified rate as the worst case for output power.
- Note 4: After preliminary test, we present worst case with maximum power of each RU type.
- Note 5: We present worst case (max. power, closest band-edge channel or both) in the report.

3.8. Output Power Setting

Mode	U-NII Band	Centre Frequency (MHz)	Power Setting		Mode	U-NII Band	Centre Frequency (MHz)	Power Setting	
			AUX	Main				AUX	Main
802.11ax-HE20	5	5955	1.50	1.50	802.11ax-HE20	7	6535	0.75	0.75
		6175	1.50	1.50			6695	0.75	0.75
		6415	1.50	1.50			6855	0.75	0.75
	6	6435	1.50	1.50		8	6875	0.75	0.75
		6475	1.50	1.50			6995	0.75	0.75
		6515	1.50	1.50			7115	-3.00	-3.00

Mode	U-NII Band	Centre Frequency (MHz)	Power Setting		Mode	U-NII Band	Centre Frequency (MHz)	Power Setting	
			AUX	Main				AUX	Main
802.11ax-HE40	5	5965	4.75	4.75	802.11ax-HE0	7	6525	4.75	4.75
		6165	4.75	4.75			6685	4.00	4.00
		6405	4.75	4.75			6845	4.00	4.00
	6	6445	4.75	4.75		8	6885	4.00	4.00
		6485	4.75	4.75			7005	4.00	4.00
							7085	4.00	4.00

Mode	U-NII Band	Centre Frequency (MHz)	Power Setting		Mode	U-NII Band	Centre Frequency (MHz)	Power Setting	
			AUX	Main				AUX	Main
802.11ax-HE80	5	5985	7.25	7.25	802.11ax-HE80	7	6625	6.50	6.50
		6145	7.25	7.25			6705	6.50	6.50
		6385	7.25	7.25			6785	6.50	6.50
	6	6465	7.25	7.25		8	6865	6.50	6.50
		6545	7.25	7.25			6945	6.50	6.50
							7025	6.50	6.50

Mode	U-NII Band	Centre Frequency (MHz)	Power Setting		Mode	U-NII Band	Centre Frequency (MHz)	Power Setting	
			AUX	Main				AUX	Main
802.11ax-HE160	5	6025	10.00	10.00	802.11ax-HE160	7	6665	9.25	9.25
		6185	10.00	10.00			6825	9.25	9.25
		6345	10.00	10.00		8	6985	9.25	9.25
	6	6505	10.00	10.00					

3.9. Tested Supporting System List

3.9.1. Support Peripheral Unit

No.	Product	Brand	Model No.	Serial No.	Approval
1.	LCD Monitor	DELL	U2718Qb	CN-0M5R5F-QD C00-8BK-04CL	N/A
		Fujitsu	B24-9 WE	N/A	N/A
2.	USB Mouse	Lenovo	MOJU00	008ZZCZ	N/A
		ASUS	ROG STRIX IMPACT II	N/A	N/A
3.	Earphone	APPLE	N/A	N/A	N/A
4.	SD Card	ADATA	MicroSDHC Card	N/A	N/A
Partner System					
5	AP Server	ASUS	RT-AX88U	N/A	FCC ID: MSQ-RTAXHP00 IC: 3568A-RTAXHP00

3.9.2. Cable Lists

No.	Cable Description Of The Above Support Units
1.	HDMI Cable: Shielded, Detachable, 1.8 AC Power Cord: Unshielded, Detachable, 1.8m
2.	USB Cable: Unshielded, Undetachable, 1.8m
3.	Earphone Cable: Unshielded, Undetachable, 1.2m
4.	USB Cable: Unshielded, Undetachable, 1.8m
5.	AC adapter: M/N:WA-30B12, Cable: Unshielded, Detachable, 1.2m LAN cable: Unshielded, Detachable, 3.0m
6.	LAN cable: Unshielded, Detachable, 1.8m

3.10. Setup Configuration

3.10.1. EUT Configuration for Power Line & Radiated Emission

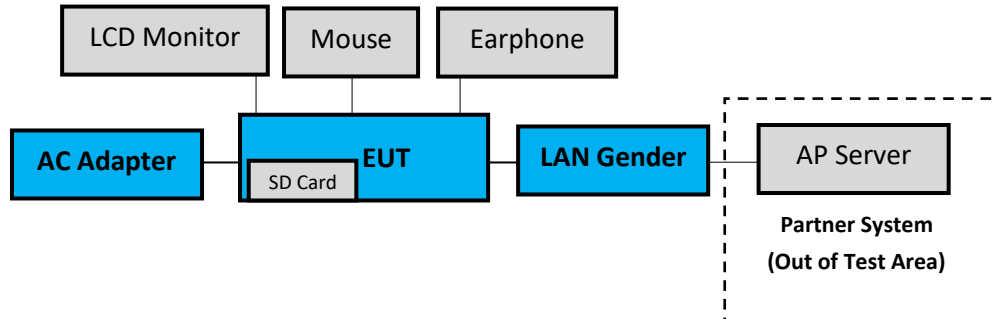

3.10.2. EUT Configuration for RF Conducted Test Items

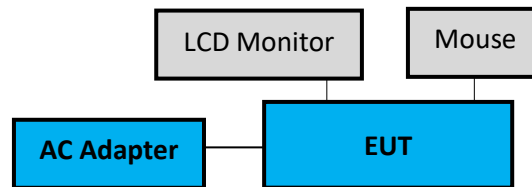

3.11. Operating Condition of EUT

Test program “DRTU” is used for enabling EUT WLAN function under continues transmitting and choosing data rate/ channel.

[ANT AUX port (A Button in DRTU), ANT Main port (B Button in DRTU)].

3.12. Description of Test Facility

Name of Test Firm	Audix Technology Corporation / EMC Department No. 491, Zhongfu Rd., Linkou Dist., New Taipei City 244, Taiwan Tel: +886-2-26092133 Fax: +886-2-26099303 Website : www.audixtech.com Contact e-mail: attemc_report@audixtech.com
Accreditations	The laboratory is accredited by following organizations under ISO/IEC 17025:2017 (1) NVLAP(USA) NVLAP Lab Code 200077-0 (2) TAF(Taiwan) No. 1724
Test Facilities	FCC OET Designation Number under APEC MRA by NCC is : TW1724 ISED CAB Identifier Number under APEC TEL MRA by NCC is TW1724 (1) No.8 Shielded Room (2) No.1 3m Semi Anechoic Chamber

3.13.Measurement Uncertainty

Test Items/Facilities		Frequency Range	Uncertainty	
Conduction Test	<input type="checkbox"/>	No. 7 Shielded Room	9kHz-150kHz	±3.7dB
			150kHz-30MHz	±3.4dB
	<input checked="" type="checkbox"/>	No. 8 Shielded Room	9kHz-150kHz	±3.7dB
			150kHz-30MHz	±3.5dB
Radiation Test	<input checked="" type="checkbox"/>	No.1 3m Semi Anechoic Chamber	30MHz-200MHz, 3m, Horizontal	±3.6dB
			200MHz-1000MHz, 3m, Horizontal	±4.3dB
			30MHz-200MHz, 3m, Vertical	±4.4dB
			200MHz-1000MHz, 3m, Vertical	±4.8dB
			1GHz-6GHz, 3m	±4.8dB
			6GHz-18GHz, 3m	±4.5dB
	<input type="checkbox"/>	No.3 3m Semi Anechoic Chamber	30MHz-200MHz, 3m, Horizontal	±4.0dB
			200MHz-1000MHz, 3m, Horizontal	±4.4dB
			30MHz-200MHz, 3m, Vertical	±4.7dB
			200MHz-1000MHz, 3m, Vertical	±4.5dB
			1GHz-6GHz, 3m	±4.8dB
			6GHz-18GHz, 3m	±4.5dB
	<input type="checkbox"/>	No.4 3m Semi Anechoic Chamber	30MHz-200MHz, 3m, Horizontal	±4.3dB
			200MHz-1000MHz, 3m, Horizontal	±4.2dB
			30MHz-200MHz, 3m, Vertical	±4.8dB
			200MHz-1000MHz, 3m, Vertical	±4.7dB
			1GHz-6GHz, 3m	±4.6dB
			6GHz-18GHz, 3m	±4.4dB
	<input type="checkbox"/>	No.5 3m Semi Anechoic Chamber	30MHz-200MHz, 3m, Horizontal	±4.6dB
			200MHz-1000MHz, 3m, Horizontal	±4.4dB
			30MHz-200MHz, 3m, Vertical	±4.5dB
			200MHz-1000MHz, 3m, Vertical	±4.9dB
			1GHz-6GHz, 3m	±4.9dB
			6GHz-18GHz, 3m	±4.6dB
Radiated emissions (18GHz-40GHz)		18GHz-40GHz, 3m	±3.4dB	

Remark : Uncertainty = $ku_c(y)$

Test Items	Uncertainty
Maximum Power Spectral Density	± 0.52dB
Maximum Conducted Output Power	± 0.72dB
Emission Bandwidth	± 0.38%
Contention Based Protocol	± 2%

4. MEASUREMENT EQUIPMENT LIST

4.1. Conducted Emission Measurement

Item	Type	Manufacturer	Model No.	Serial No.	Cal. Date	Cal. Interval
1.	Test Receiver	R&S	ESR3	101774	2023. 01. 11	1 Year
2.	A.M.N.	R&S	ENV432	101567	2022. 05. 26	1 Year
3.	L.I.S.N.	Kyoritsu	KNW-407	8-855-9	2022. 12. 19	1 Year
4.	Pulse Limiter	R&S	ESH3-Z2	100354	2022. 12. 14	1 Year
5.	Digital Thermo-Hygro Meter	iMax	HTC-1	No.8 S/R	2022. 04. 14	1 Year
6.	Coaxial Cable	Yeida	RG/58AU	CE-08	2022. 09. 07	1 Year
7.	Test Software	Audix	e3	V9 18621a	N.C.R.	N.C.R.

4.2. Radiated Emission Measurement

Item	Type	Manufacturer	Model No.	Serial No.	Cal. Date	Cal. Interval
1.	Spectrum Analyzer	Agilent	N9010A-526	MY53400071	2022. 08. 24	1 Year
2.	Test Receiver	R&S	ESCS30	100039	2022. 06. 01	1 Year
3.	Amplifier	HP	8447D	2944A06305	2022. 12. 29	1 Year
4.	Microwave Amplifier	Keysight	83051A	MY56480113	2022. 09. 07	1 Year
5.	Microwave Amplifier	Agilent	8449B	3008A02678	2023. 02. 17	1 Year
6.	Loop Antenna	TESEQ	HLA 6121	60478	2023. 02. 21	1 Year
7.	Bilog Antenna	TESEQ	CBL6112D	33821	2022. 07. 01	1 Year
8.	Double-Ridged Waveguide Horn	ETS-Lindgren	3117	00135902	2022. 03. 21	1 Year
9.	Horn Antenna	COM-POWER	AH-840	101092	2022. 12. 30	1 Year
10.	Notch Filter	Warison	WFIL-N5925-6425F	WR61CFWC4 B1	2023. 01. 13	1 Year
11.	Notch Filter	Warison	WFIL-N6425-6525F	WR61CFWC6 B1	2023. 01. 13	1 Year
12.	Notch Filter	Warison	WFIL-N6525-6875F	WR61CFWC8 B1	2023. 01. 13	1 Year
13.	Notch Filter	Warison	WFIL-N6875-7125F	WR61CFWC2 B1	2023. 01. 13	1 Year
14.	Coaxial Cable	MIYAZAKI	5D2W	RE-11	2023. 01. 07	1 Year
15.	Coaxial Cable	HUBER+SUHNER	SUCOFLEX 106	RE-14	2023. 01. 07	1 Year
16.	Coaxial Cable	HUBER+SUHNER	SUCOFLEX 102	RE-30	2022. 08. 22	1 Year
17.	Digital Thermo-Hygro Meter	iMax	HTC-1	No.1 3m A/C	2022. 04. 14	1 Year
18.	Test Software	Audix	e3	V9 18621a	N.C.R.	N.C.R.

4.3. RF Conducted Measurement

Item	Type	Manufacturer	Model No.	Serial No.	Cal. Date	Cal. Interval
1.	Spectrum Analyzer	Keysight	N9020B-544	MY57120357	2023. 02. 22	1 Year
2.	Power Meter	Anritsu	ML2495A	2127005	2022. 12. 01	1 Year
3.	Power Meter	Anritsu	ML2495A	2127004	2022. 12. 07	1 Year
4.	Power Sensor	Anritsu	MA2411B	1911360	2022. 12. 07	1 Year
5.	Power Sensor	Anritsu	MA2411B	1911356	2022. 12. 01	1 Year
6.	Digital Thermo-Hygro Meter	iMax	HTC-1	RF-03	2022. 04. 14	1 Year

4.4. Contention Based Protocol Measurement

Item	Type	Manufacturer	Model No.	Serial No.	Cal. Date	Cal. Interval
1.	Spectrum Analyzer	Keysight	N9030B	MY61330403	2022. 12. 16	1 Year
2.	Spectrum Analyzer	Keysight	N9010B	MY59071380	2023. 03. 02	1 Year
3.	MXG RF Vector Signal Generator	Agilent	N5182B	MY53050409	2022. 11.14	1 Year
4.	Frequency Extender	KEYSIGHT	N5182BX07	MY59362533	2022. 11.14	1 Year
5.	Digital Thermo-Hygro Meter	iMax	HTC-1	RF-03	2022. 04. 14	1 Year
6.	Power Splitter	minicircuit	ZFRSC-183-S ⁺	SF688901703	2023. 03. 30	1 Year
7.	Attenuator (10dB) X2	Worken	WK0602-10	0120A022080 01S	N.C.R	N.C.R
8.	Attenuator (30dB) X1	Worken	WK0602-30	0120A022080 02S	N.C.R	N.C.R
9.	Power Divider	EMEC	EM-MPD-0.5/ 8-2SS	22072002-17	2023. 03. 30	1 Year

5. CONDUCTED EMISSION

5.1. Block Diagram of Test Setup

5.1.1. Block Diagram of EUT

Indicated as section 3.10

5.1.2. Shielded Room Setup Diagram

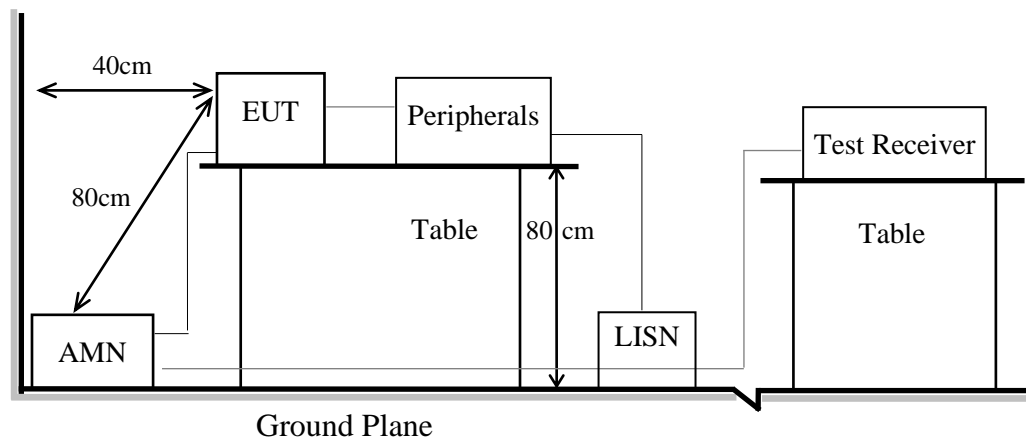

5.2. Conducted Emission Limit

Frequency	Conducted Limit	
	Quasi-Peak Level	Average Level
150kHz ~ 500kHz	66 ~ 56 dB μ V	56 ~ 46 dB μ V
500kHz ~ 5MHz	56 dB μ V	46 dB μ V
5MHz ~ 30MHz	60 dB μ V	50 dB μ V

Remark 1.: If the average limit is met when using a Quasi-Peak detector, the measurement using the average detector is not required.

2.: The lower limit applies to the band edges.

5.3. Test Procedure

- 5.3.1. To set up the EUT as indicated in ANSI C63.10. The EUT was placed on the table which has 80 cm height to the ground and 40 cm distance to the conducting wall.
- 5.3.2. Power supplier of the EUT was connected to the AC mains through an Artificial Mains Network (A.M.N.).
- 5.3.3. The AC power supplies to all peripheral devices must be provided through line impedance stabilization network (L.I.S.N.)
- 5.3.4. Checking frequency range from 150 kHz to 30 MHz and record the emission which does not have 20 dB below limit.

5.4. Test Results

Please refer to Appendix A.

6. RADIATED EMISSION

6.1. Block Diagram of Test Setup

6.1.1. Block Diagram of EUT

Indicated as section 3.10

6.1.2. Setup Diagram for 9kHz-30MHz

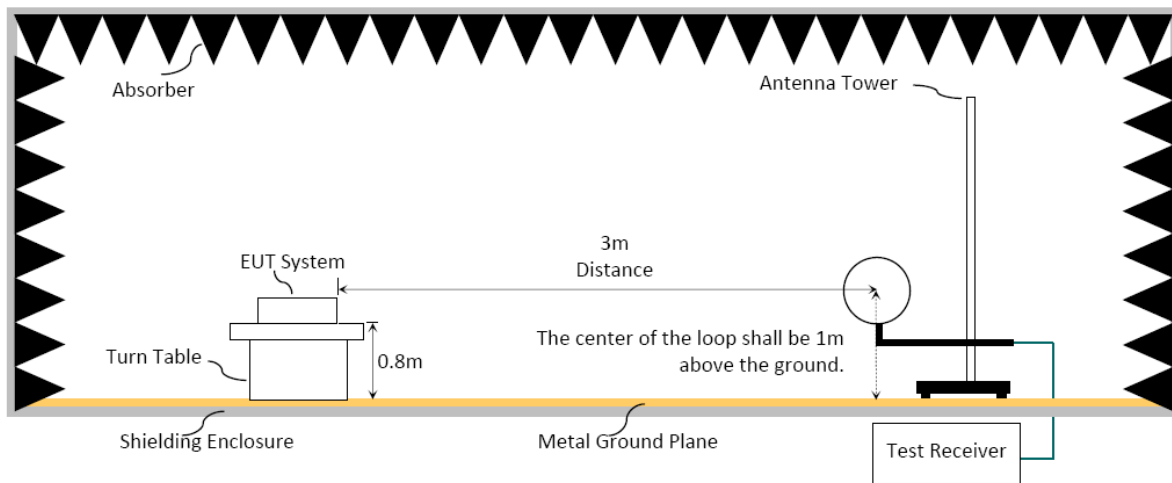

6.1.3. Setup Diagram for 30-1000MHz

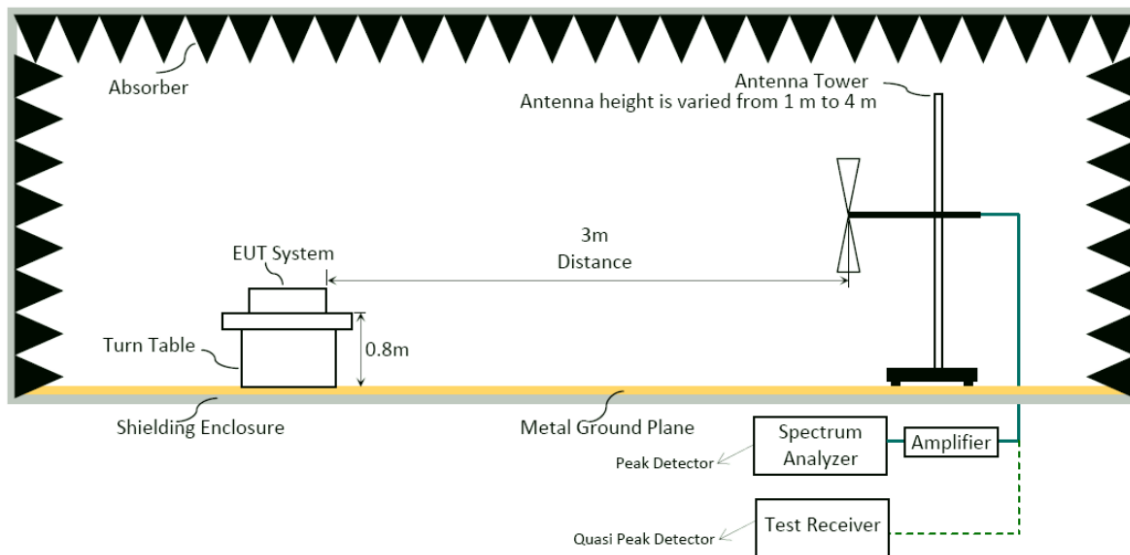

6.1.4. Setup Diagram for above 1GHz

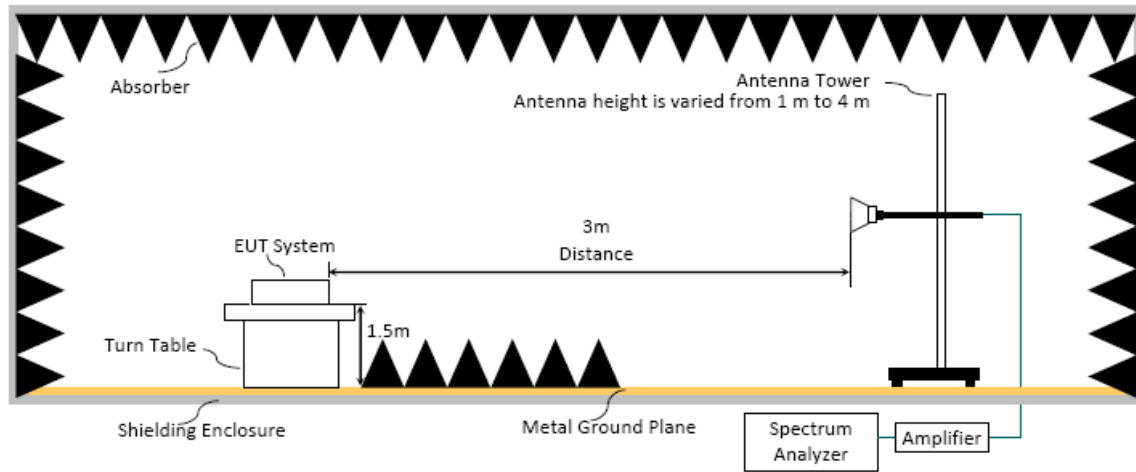

6.2. Radiated Emission Limits

Radiated emissions fall in restricted bands, as defined in FCC Section 15.205/RSS-Gen Section 8.10 table 7 must be in compliance with the radiated emission limits specified in FCC Section 15.209/RSS-Gen Section 8.9 table 6 as below.

6.2.1. General Limit

Frequency (MHz)	Distance(m)	Limits	
		dB μ V/m	μ V/m
0.009 - 0.490	300	67.6-20 log f(kHz)	2400/f kHz
0.490 - 1.705	30	87.6-20 log f(kHz)	24000/f kHz
1.705 - 30	30	29.5	30
30 - 88	3	40.0	100
88- 216	3	43.5	150
216- 960	3	46.0	200
Above 960	3	54.0	500
Above 1000	3	74.0 dB μ V/m (Peak) 54.0 dB μ V/m (Average)	

Remark : (1) dB μ V/m = 20 log (μ V/m)

- (2) The tighter limit applies to the edge between two frequency bands.
- (3) Distance refers to the distance in meters between the measuring instrument antenna and the closed point of any part of the device or system.
- (4) Fundamental and emission fall within operation band are exempted from this section.
- (5) Pursuant to ANSI C63.10: 6.6.4.3, if the maximized peak measured value complies with the average limit, then it is unnecessary to perform an average measurement.

6.2.2. Limit for non-restricted frequency above 1 GHz

Frequency Band (MHz)	E.I.R.P. Limit	Field Strength Limit at 3 m
Out of 5925 to 7125	-27 dBm/MHz	68.2 dB μ V/m

Note: Field Strength at 3 m= E.I.R.P. + 95.2 dB

6.3. Test Procedure

Frequency Range 9kHz~30MHz:

The EUT setup on the turntable which has 0.8 m height to the ground. The turn table rotated 360 degrees and antenna fixed to 1 m to find the maximum emission level. In order to find the maximum emission, all of the interface cables were manipulated according to ANSI C63.10-2013 regulation.

- (1) RBW = 9kHz with peak and average detector.
- (2) Detector: average and peak (9kHz-490kHz)
Q.P. (490kHz-30MHz)

Frequency Range 30MHz ~ 40GHz:

The EUT setup on the turn table which has 80cm (for 30-1000MHz) and 1.5m (for above 1GHz) height to the ground. The turn table rotated 360 degrees and antenna varied from 1 m to 4 m to find the maximum emission level. Both horizontal and vertical polarization are required. In order to find the maximum emission, all of the interface cables were manipulated according to ANSI C63.10-2013 regulation.

6.3.1. Radiated measurement Spectrum Analyzer Setting

6.3.1.1 Frequency below 1GHz:

Spectrum Analyzer is used for pre-testing with following setting:

- (1) RBW = 120kHz
- (2) VBW $\geq 3 \times$ RBW.
- (3) Detector = Peak.
- (4) Sweep time = auto.
- (5) Trace mode = max hold.
- (6) Allow sweeps to continue until the trace stabilizes.

Note 1: When peak-detected value is lower than limit that the measurement using the Q.P. detector is not required, otherwise using Q.P. for final measurement.

Note 2: When the radiated emissions limits are expressed in terms of the average value of the emissions, and pulsed operation is employed, the measurement field strength shall be determined by averaging over one complete pulse train, including blanking intervals, as long as the pulse train does not exceed 0.1 seconds.

6.3.1.2 Frequency above 1GHz to 10th harmonic (up to 40 GHz):

Peak Detector:

- (1) RBW = 1MHz
- (2) VBW $\geq 3 \times$ RBW.
- (3) Detector = Peak.
- (4) Sweep time = auto.
- (5) Trace mode = max hold.
- (6) Allow sweeps to continue until the trace stabilizes.

Note: When peak-detected value is lower than limit that the measurement using the average detector is not required, otherwise using average detector for final measurement.

Average Detector:**■ Option 1:**

(1) RBW = 1MHz

(2) VBW $\geq 1/T$. (Duty Cycle < 98%, when duty cycle presented in section 3.7)

Mode	VBW Setting
RU (26T)	1.5kHz
RU (52T)	750Hz
RU (242T)	750Hz
RU (996T)	820Hz

(3) VBW = set VBW \leq RBW / 100, but not less than 10Hz (Duty Cycle \geq 98%, when duty cycle presented in section 3.7)

Mode	VBW Setting
802.11ax-HE20	10Hz
802.11ax-HE40	10Hz
802.11ax-HE80	10Hz
802.11ax-HE160	10Hz
RU (106T)	10Hz
RU (484T)	10Hz

(4) Detector = Peak.

(5) Sweep time = auto.

(6) Trace mode = max hold.

(7) Allow sweeps to continue until the trace stabilizes.

□ Option 2:

Average Emission Level = Peak Emission Level + D.C.C.F.

6.3.2. Radiated band edge measurement Spectrum Analyzer Setting

For without 99% OBW edge within 2 MHz of the authorized band edge:

The spectrum analyzer setting, please refer to section 6.3.1.2

For with 99% OBW edge within 2 MHz of the authorized band edge:

Per KDB 789033 Section G.3.d and ANSI C63.10 -2013 6.10.4, SA setting as below:

a. Fundamental field strength of SA setting:

The spectrum analyzer setting, please refer to section 6.3.1.2

b. Delta of SA setting:

- (1) RBW = 1% SPAN but no less than 30 KHz
(In this case, RBW = 500 KHz)
- (2) VBW \geq 3 x RBW.
- (3) Detector = Peak.
- (4) Sweep time = auto.
- (5) Trace mode = max hold.
- (6) Allow sweeps to continue until the trace stabilizes.

Correction Factor (Via delta, dB) = Fundamental Emission Level (dB μ V/m) @ RBW 500KHz - Band Edge Emission Level (dB μ V/m) @ RBW 500kHz

Band Edge Emission Level (dB μ V/m) =
Fundamental Emission Level (dB μ V/m) @ RBW 1MHz - Marker Delta (dB)

6.4. Measurement Result Explanation

- Peak Emission Level (dB μ V/m) = Antenna Factor (dB/m) + Cable Loss (dB) + Meter Reading (dB μ V) (including Preamp factor if test used)
- Average Emission Level (dB μ V/m) = Antenna Factor (dB/m) + Cable Loss (dB) + Meter Reading (dB μ V) (including Preamp factor if test used)
- Average Emission Level (dB μ V/m) = Peak Emission Level (dB μ V/m) + DCCF (dB)
Duty Cycle Correction Factor (DCCF) = $20\log(TX_{on}/TX_{on+off})$ presented in section 3.7.
- ERP = Peak Emission Level (dB μ V/m) - 95.2dB - 2.14dB
- Band Edge Emission Level (dB μ V/m) = Fundamental Emission Level (dB μ V/m) - Marker-Delta (dB)

6.5. Test Results

Please refer to Appendix A.

7. MAXIMUM POWER SPECTRAL DENSITY

7.1. Block Diagram of Test Setup

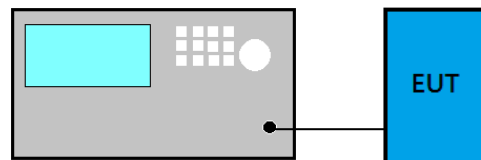

7.2. Specification Limits

For client devices operating under the control of an indoor access point in the 5.925-7.125 GHz bands, the maximum power spectral density must not exceed -1dBm e.i.r.p. in any 1-megahertz band

7.3. Test Procedure

Following measurement procedure is reference to KDB 789033 D02 General UNII Test Procedures New Rules v02r01:

■ Method AVGSA-2 (Spectrum channel power)

- (1) Set span to at least 1.5 times the OBW
- (2) Set RBW = 1 MHz
- (3) Set the video bandwidth (VBW) \geq 3 MHz.
- (4) Detector = RMS.
- (5) Trace mode = trace average at least 100 traces
- (6) Sweep = auto couple.
- (7) Use peak search function to find out the maximum power density.
- (8) Duty cycle factor is added when duty cycle presented in section 3.7 is $<$ 98%.

For power density emission measurements from multiple outputs of a transmitter or from multiple transmitters: Please refer to KDB 662911 E 2) c).

7.4. Test Results

Please refer to Appendix A

8. MAXIMUM CONDUCTED OUTPUT POWER

8.1. Block Diagram of Test Setup

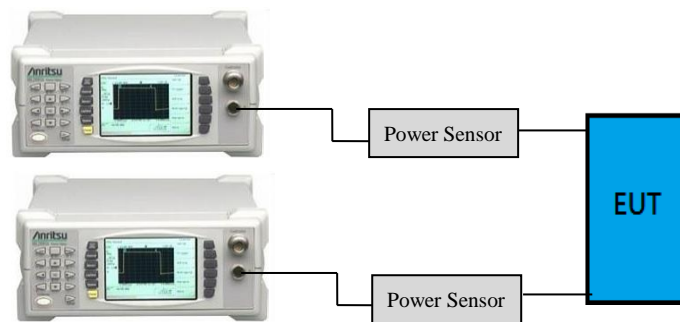

- For 802.11ac-VHT80/160, 802.11ax-HE160 modes only

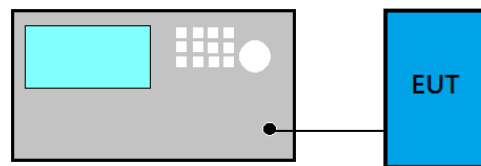

8.2. Specification Limits

For client devices operating under the control of an indoor access point in the 5.925-7.125 GHz bands, the maximum e.i.r.p. over the frequency band of operation must not exceed 24 dBm.

8.3. Test Procedure

Following measurement procedure is reference to KDB 789033 D02 General UNII Test Procedures New Rules v02r01:

■ **Method AVGPM (Measurement using an RF average power meter):**

EUT is connected to power sensor and record the maximum average output power and duty cycle factor is added when duty cycle presented in section 3.7 is < 98%.

■ **Method AVGSA-2 (Spectrum channel power) for 802.11ac-VHT80/160, 802.11ax-HE80/160 modes only**

- (1) Set span to at least 1.5 times the OBW
- (2) Set RBW = 1 MHz
- (3) Set the video bandwidth (VBW) \geq 3 MHz.
- (4) Detector = RMS.
- (5) Trace mode = trace average at least 100 traces
- (6) Sweep = auto couple.
- (7) Compute power by integrating the spectrum across the OBW of the signal using the instrument's band power measurement function with band limits set equal to the OBW band edges.
- (8) Duty cycle factor is added when duty cycle presented in section 3.7 is < 98%.

8.4. Test Results

Please refer to Appendix A

9. EMISSION/OCCUPIED BANDWIDTH

9.1. Block Diagram of Test Setup

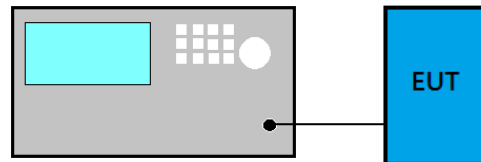

9.2. Specification Limits

The maximum transmitter channel bandwidth for U-NII devices in the 5.925-7.125 GHz band is 320 megahertz

9.3. Test Procedure

Following measurement procedure is reference to KDB 789033 D02 General UNII Test Procedures New Rules v02r01:

- (1) Set RBW = 1% of the emission bandwidth
- (2) Set VBW > RBW
- (3) Detector = Peak
- (4) Trace mode = max hold
- (5) Setting channel bandwidth function x dB to -26 dB to record the final bandwidth.

9.4. Test Results

Please refer to Appendix A

10. UNDERSIRABLE EMISSIONS LIMITS: SPURIOUS EMISSION (CONDUCTED)

10.1. Block Diagram of Test Setup

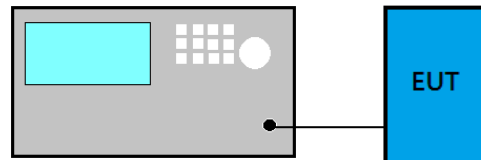

10.2. Spurious Emission Specification Limits

For transmitters operating within the 5.925-7.125 GHz band: Any emissions outside of the 5.925- 7.125 GHz band must not exceed an e.i.r.p. of -27 dBm/MHz.

Unless otherwise specified, on any frequency or frequencies above 1000 MHz, the radiated emission limits are based on the use of measurement instrumentation employing an average detector function. Unless otherwise specified, measurements above 1000 MHz shall be performed using a minimum resolution bandwidth of 1 MHz. When average radiated emission measurements are specified in this part, including average emission measurements below 1000 MHz, there also is a limit on the peak level of the radio frequency emissions. Unless otherwise specified, e.g., see FCC Part §§ 15.250, 15.252, 15.253(d), 15.255, 15.256, and 15.509 through 15.519, the limit on peak radio frequency emissions is 20 dB above the maximum permitted average emission limit applicable to the equipment under test. This peak limit applies to the total peak emission level radiated by the device, e.g., the total peak power level

10.3. Test Procedure

Please refer to KDB 789033 D02 v02r01 G5

For spurious emission measurements from multiple outputs of a transmitter or from multiple transmitters: Please refer to KDB 662911 E 3) a) (iii).

10.4. Test Results

Please refer to Appendix A

11. IN-BAND EMISSION (CHANNEL MASK)

11.1. Block Diagram of Test Setup

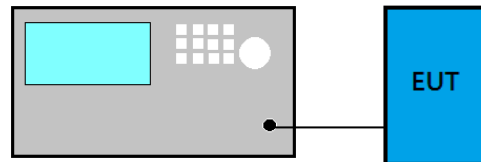

11.2. Specification Limits

For transmitters operating within the 5.925-7.125 GHz bands: Power spectral density must be suppressed by 20 dB at 1 MHz outside of channel edge, by 28 dB at one channel bandwidth from the channel center, and by 40 dB at one- and one-half times the channel bandwidth away from channel center. At frequencies between one megahertz outside an unlicensed device's channel edge and one channel bandwidth from the center of the channel, the limits must be linearly interpolated between 20 dB and 28 dB suppression, and at frequencies between one and one- and one-half times an unlicensed device's channel bandwidth, the limits must be linearly interpolated between 28 dB and 40 dB suppression. Emissions removed from the channel center by more than one- and one-half times the channel bandwidth must be suppressed by at least 40 dB.

11.3. Test Procedure

Following measurement procedure is reference to KDB 987594 D02 U-NII 6GHz EMC Measurement v01v01:

Measure the power spectral density (which will be used for emissions mask reference) using the following procedure:

- (a) Set the span to encompass the entire 26 dB EBW of the signal.
- (b) Set RBW = same RBW used for 26 dB EBW measurement.
- (c) Set VBW $\geq 3 \times$ RBW
- (d) Number of points in sweep $\geq (2 \times \text{span} / \text{RBW})$.
- (e) Sweep time = auto.
- (f) Detector = RMS (i.e., power averaging)
- (g) Trace average at least 100 traces in power averaging (rms) mode.
- (h) Use the peak search function on the instrument to find the peak of the spectrum.

- (1) Using the measuring equipment limit line function, develop the emissions mask based on the following requirements. The emissions power spectral density must be reduced below the peak power spectral density (in dB) as follows:
 - (a) Suppressed by 20 dB at 1 MHz outside of the channel edge.
 - (b) Suppressed by 28 dB at one channel bandwidth from the channel center.
 - (c) Suppressed by 40 dB at one- and one-half times the channel bandwidth from the channel center.
- (2) Adjust the span to encompass the entire mask as necessary.
- (3) Clear trace.
- (4) Trace average at least 100 traces in power averaging (rms) mode.
- (5) Adjust the reference level as necessary so that the crest of the channel touches the top of the emission mask.

11.4. Test Results

Please refer to Appendix A

12. CONTENTION BASED PROTOCOL

12.1. Block Diagram of Test Setup

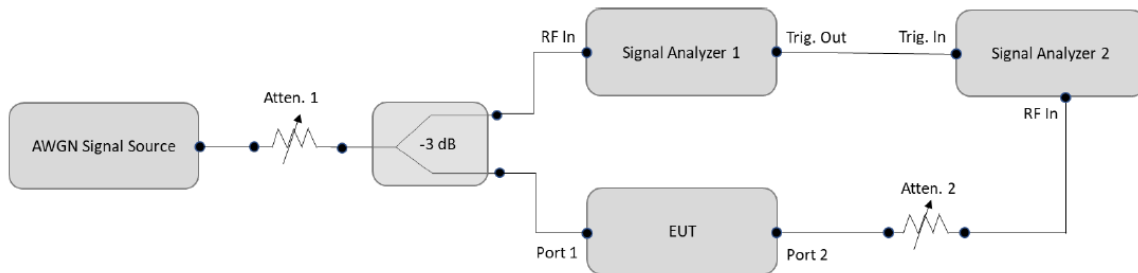

12.2. Specification Limits

Indoor access points, subordinate devices and client devices operating in the 5.925-7.125 GHz band must employ a contention-based protocol

FCC KDB 987594 D02 U-NII 6GHz EMC Measurement v01v01

Unlicensed low-power indoor devices must detect co-channel radio frequency power that is at least -62 dBm or lower. Upon detection of energy in the band, unlicensed low power indoor devices must vacate the channel (in which incumbent signal is transmitted) and stay off the incumbent channel as long as detected radio frequency power is equal to or greater than the threshold (-62 dBm)¹. The -62 dBm (or lower) threshold is referenced to a 0 dBi antenna gain

To ensure incumbent operations are reliably detected in the band, low power indoor devices must detect RF energy throughout their intended operating channel. For example, an 802.11 device that plans to transmit a 40 MHz- wide signal (on a primary 20 MHz channel and a secondary 20 MHz channel) must detect energy throughout the entire 40 MHz channel. Additionally, low-power indoor devices must detect co-channel energy with 90% or greater certainty.

Table 1. Criteria to determine number of times detection threshold test may be performed

If	Number of Tests	Placement of Incumbent Transmission
$BW_{EUT} \leq BW_{Inc}$	One	Tune incumbent and EUT transmission ($f_{c1} = f_{c2}$)
$BW_{Inc} < BW_{EUT} \leq 2BW_{Inc}$	One	Incumbent transmission is contained within BW_{EUT}
$2BW_{Inc} < BW_{EUT} \leq 4BW_{Inc}$	Twice. Incumbent transmission is contained within BW_{EUT}	Incumbent transmission is located as closely as possible to the lower edge and upper edge, respectively, of the EUT channel
$BW_{EUT} > 4BW_{Inc}$	Three times	Incumbent transmission is located as closely as possible to the lower edge of the EUT channel, in the middle of EUT channel, and as closely as possible to the upper edge of the EUT channel

Where:

BW_{EUT} : Transmission bandwidth of EUT signal

BW_{Inc} : Transmission bandwidth of the simulated incumbent signal (10 MHz wide AWGN signal)

f_{c1} : Center frequency of EUT transmission

f_{c2} : Center frequency of simulated incumbent signal

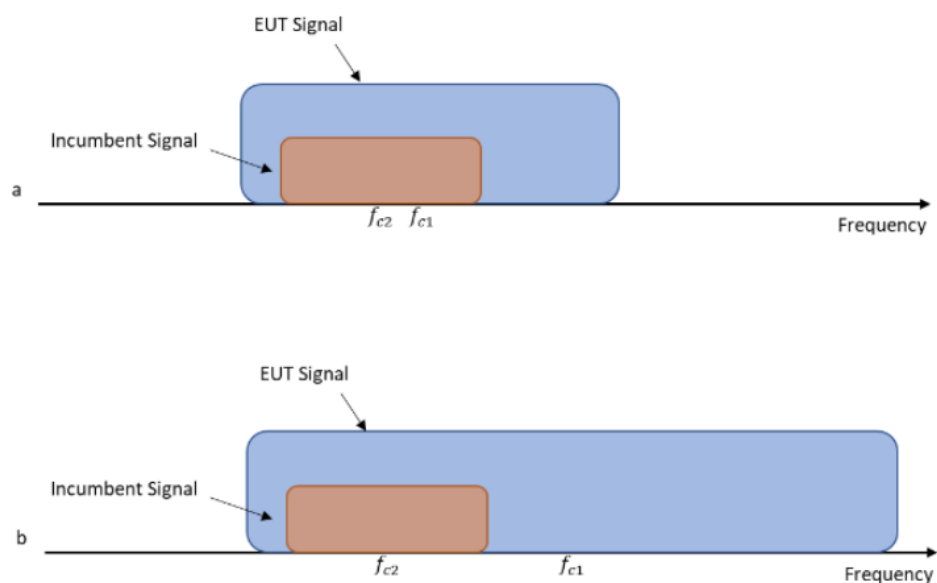

Figure 1. Two possible scenarios where a) center frequency of EUT transmission falls within incumbent's bandwidth, or b) outside of it

12.3. Test Procedure

Following measurement procedure is reference to KDB 987594 D02 U-NII 6GHz EMC Measurement v01v01:

- (1) To ensure EUT reliably detects an incumbent signal in both scenarios shown in Figure 1, the detection threshold test may be repeated more than once with the incumbent signal (having center frequency f_{c2}) tuned to different center frequencies within the EUT transmission bandwidth. The criteria specified in Table 1 determines how many times the detection threshold test must be performed
- (2) Using an AWGN signal source, generate (but do not transmit, i.e., RF OFF) a 10 MHz-wide AWGN signal. Use Table 1 to determine the center frequency of the 10 MHz AWGN signal relative to the EUT's channel bandwidth and center frequency.
- (3) Monitor the signal analyzer to verify if the AWGN signal has been detected and the EUT has ceased transmission. If the EUT continues to transmit, then incrementally increase the AWGN signal power level until the EUT stops transmitting.
- (4) (Including all losses in the RF paths) Determine and record the AWGN signal power level (at the EUT's antenna port) at which the EUT ceased transmission. Repeat the procedure at least 10 times to verify the EUT can detect an AWGN signal with 90% (or better) level of certainty.
- (5) Refer to Table 1 to determine number of times the detection threshold testing needs to be repeated. If testing is required more than once, then go back to step 2, choose a different center frequency for the AWGN signal and repeat the process.
- (6) The test tool is "LAN test" to let the EUT to transmit with a constant duty cycle.

12.4. Test Results

Please refer to Appendix A



Audix Technology Corp.
No. 491, Zhongfu Rd., Linkou Dist.,
New Taipei City 244, Taiwan

Tel: +886 2 26099301
Fax: +886 2 26099303

13.DEVIATION TO TEST SPECIFICATIONS

【NONE】



*Audix Technology Corp.
No. 491, Zhongfu Rd., Linkou Dist.,
New Taipei City 244, Taiwan*

*Tel: +886 2 26099301
Fax: +886 2 26099303*

APPENDIX A

TEST DATA AND PLOTS

(Model: 16U75R)



Audix Technology Corp.
No. 491, Zhongfu Rd., Linkou Dist.,
New Taipei City 244, Taiwan

Tel: +886 2 26099301
Fax: +886 2 26099303

APPENDIX B

TEST PHOTOGRAPHS

(Model: 16U75R)