

# ANTENNA INFORMATION

Brand	
ODM	PEGATRON
Platform model name	SL16MC
Intel platform (ex: Yes, No or NA)	Yes
Platform type (ex: regular NB, convertible PC, AIO...etc)	convertible NB
SAR minimum separation (mm)	

Antenna manufacturer	INPAQ	
Address	No.5,Chunqiu Road, Panyang Industrial Park Huangdai Town, Xiangcheng Zone, Suzhou	
Antenna Part number	Main: 1415-0ADT000 (WA-F-LELE-04-003)	Aux: 1415-0ADT000 (WA-F-LELE-04-003)
Antenna type (ex: PIFA, Dipole...etc)	PIFA	

Antenna Peak gain w/ cable loss (dBi)*										
	2.4GHz 2400-2483.5 MHz	5.2GHz 5150-5250MHz	5.3GHz 5250-5350MHz	5.6GHz 5470-5725MHz	5.8GHz 5725-5850MHz	5.9GHz 5850-5895MHz	6.2GHz 5925-6425MHz	6.5GHz 6425-6525MHz	6.7GHz 6525-6875MHz	7.0 GHz 6875-7125MHz
Main	-1.89	1.85	2.39	2.86	2.65	2.29	3.39	1.73	0.55	1.63
Aux	-1.75	0.11	-0.19	1.25	1.27	0.39	1.08	0.58	-0.15	-0.11

Cable Assembly Part Number and Information					
	Cable PN	Cable length(cm)	Cable diameter(mm)	Impedance(ohm)	Connector type
Main	WIR,RF-OD1.13/50, Low Loss, Black	150mm	1.13mm	50Ω	I-PEX 4L 20565-001R-13
Aux	WIR,RF-OD1.13/50, Low Loss, White	160mm	1.13mm	50Ω	I-PEX 4L 20565-001R-13

\* 3D Antenna Peak Gain required being test in system basis.

# Table of Contents

<b>Cover page</b> .....	<b>1</b>
<b>1. Intel Reference Gain and Type</b> .....	<b>3</b>
<b>2. Document Revision History</b> .....	<b>3</b>
<b>3. Test &amp; System Description</b>	
3.1 Measurement Method and System.....	4
3.2 Test setup.....	4
3.3 Equipment list.....	5
<b>4. Radiation characteristics of antenna loaded in Host Platform</b> .....	<b>6</b>
<b>Annex A. Photographs</b>	
A.1 Setup Photo.....	16
A.2 Test sample.....	17
<b>Annex B. Antenna Location</b>	
B.1 Antenna Host Platform Location Information.....	19
B.2 Antenna dimensional information for SAR evaluation.....	20

## 1. Intel Reference Gain and Type

Antenna Peak gain w/ cable loss (dBi)											
Band/Frequency		2.4GHz 2400-2483.5 MHz	5.2GHz 5150-5250MHz	5.3GHz 5250-5350MHz	5.6GHz 5470-5725MHz	5.8GHz 5725-5850MHz	5.9GHz 5850-5895MHz	6.2GHz 5925-6425MHz	6.5GHz 6425-6525MHz	6.7GHz 6525-6875MHz	7.0 GHz 6875-7125MHz
Design	EU/UK	3.00	5.00	5.00	5.00	5.00	5.00	5.00	5.00	5.00	5.00
PIFA	For WiFi 6E and earlier	3.24	3.64	3.73	4.77	4.97	4.72	4.83	4.30	5.37	5.59
	From WiFi 7	2.95	5.11	4.55	5.15	5.13	4.45	5.02	5.02	4.96	4.96
Dipole	For WiFi 6E and earlier	2.89	2.92	3.19	4.41	4.22	4.22	4.83	4.30	4.49	5.34
	From WiFi 7	2.95	4.03	4.11	5.15	5.13	4.45	5.02	4.71	4.49	4.96

### 3D Peak Antenna gain should be equal or greater than -2 dBi

If a host integrator plans to use a lower gain antenna of the same type, additional CBP(FCC)/EDT(EU) testing need to be performed while the module is installed in the host.

Revision #	Revision Details	Issued Date
Rev. 00	First Issue	2023.06.20

## 2. Document Revision History

### 3. Test & System Description

#### 3.1 Measurement Method and System

ETS-Lindgren AMS-8500 system is 3D fully anechoic chamber, it is applied to the “Conical Cut test method”, the detail description is described as below.

The Conical Cut method requires the ability of the Measurement Antenna to be physically rotated in the theta plane (overhead) of the EUT for implementations using a single Measurement Antenna, Eleven conical cuts are required to capture data at every 15 degrees from the EUT, with the top (0 degrees) and bottom (180 degrees) cuts not being measured. Typically, the EUT will remain affixed to a turntable during the entire measurement process. The Measurement Antenna will be positioned at a starting theta angle. The EUT will then be rotated around the full 360 degrees of phi rotation. The Measurement Antenna will then be positioned at the next theta angle, and the process repeated.

		$\theta$ -Axis	$\Phi$ -Axis
Passive	Step size	15°~165° step: 15°	0°~345° step: 15°
	N / M (Points)	12	24

#### 3.2 Test setup

Typical Setup for ETS-Lindgren AMS-8500:

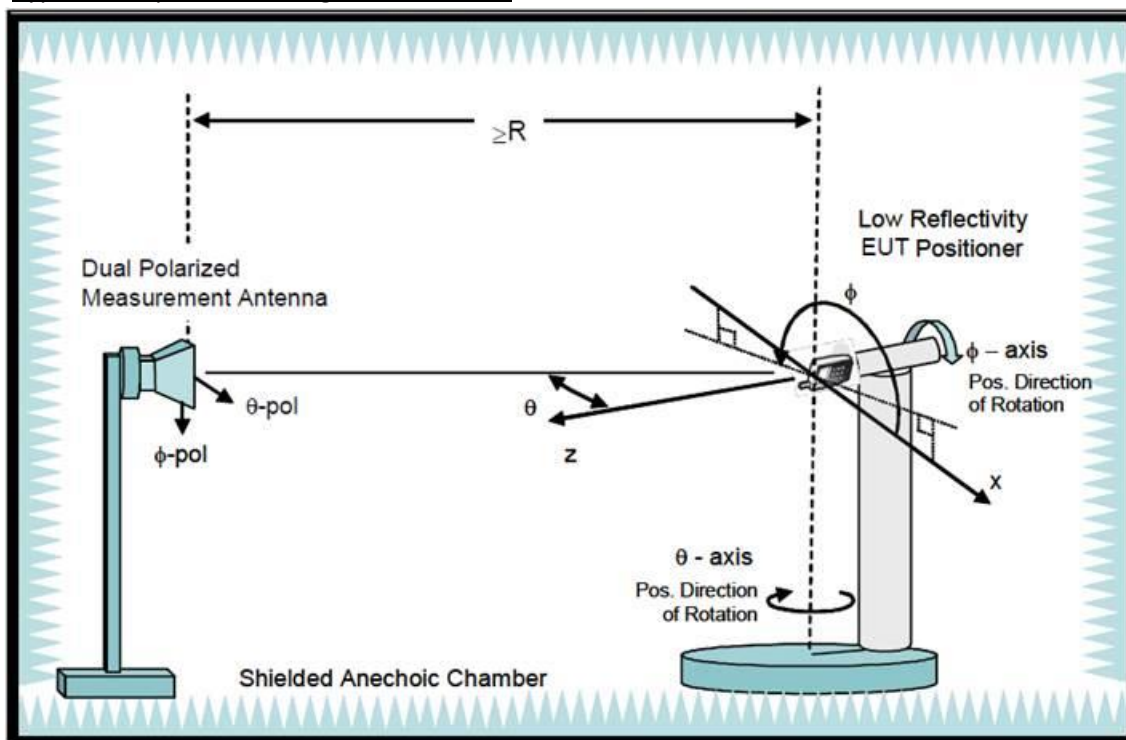

### 3.3 Equipment list

Equipment Description	Manufacturer	Identification no.	Current calibration date	Next calibration date
Network analyzer	Agilent	E5071C	2023/01/07	2024/01/06
Measurement software	ETS-Lindgren	EMQuest	2023/03/03	2024/03/03
Multi axis positioning system(MAPSTM)	ETS-Lindgren	EMCO 2115	2023/03/03	2024/03/03
Multi axis positioning system(MAPSTM)	ETS-Lindgren	EMCO 2110	2023/03/03	2024/03/03
MAPSTM controller	ETS-Lindgren	EMCO 2090	2023/03/03	2024/03/03
Horn antenna	ETS-Lindgren	3164-10	2023/03/03	2024/03/03
Cable 40cm 18 GHz	Jmtt	201EH012010400	2023/04/07	2024/04/07
Cable 6m 18 GHz	Jmtt	201EH012016000	2023/04/07	2024/04/07
Cable 6m 18 GHz	Jmtt	201EH012016000	2023/04/07	2024/04/07
Cable 3.5m 18 GHz	Jmtt	201EH012013500	2023/04/07	2024/04/07
Cable 1.5m 18 GHz	Jmtt	201EH012011500	2023/04/07	2024/04/07

#### 4. Radiation characteristics of antenna loaded in Host Platform

##### Main Antenna

Max Antenna 3D Radiation Pattern 2400 – 2483.5 MHz

Frequency (MHz)	Peak Gain w/ Cable Loss (dBi)
2400-2483.5	-1.89

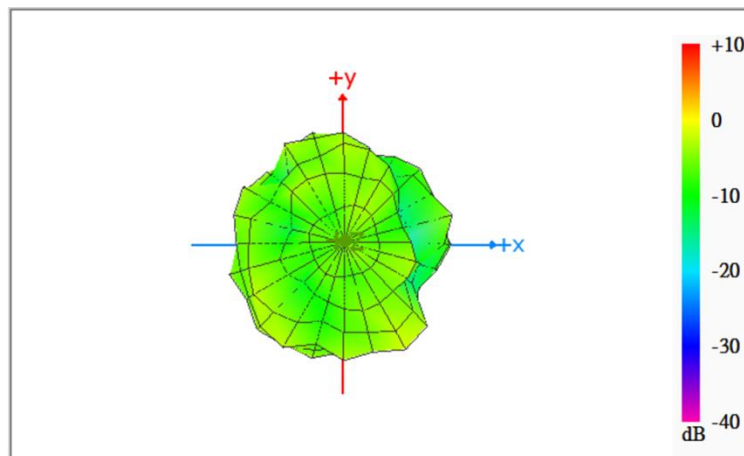

Max Antenna 3D Radiation Pattern 5150-5250 MHz

Frequency (MHz)	Peak Gain w/ Cable Loss (dBi)
5150-5250	1.85

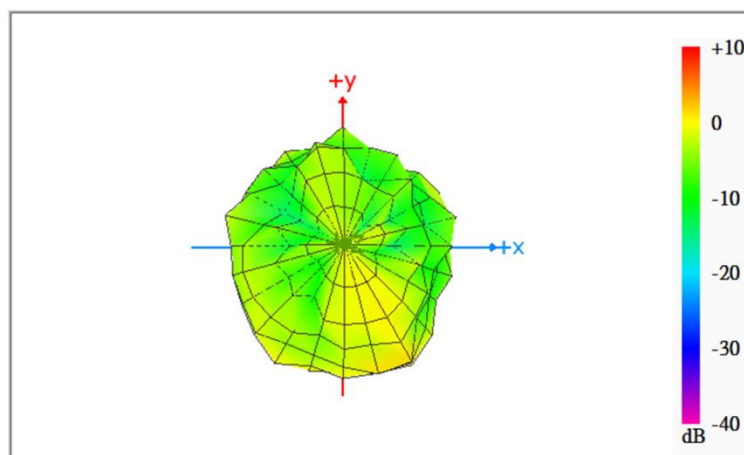

## Max Antenna 3D Radiation Pattern 5250-5350 MHz

Frequency (MHz)	Peak Gain w/ Cable Loss (dBi)
5250-5350	2.39

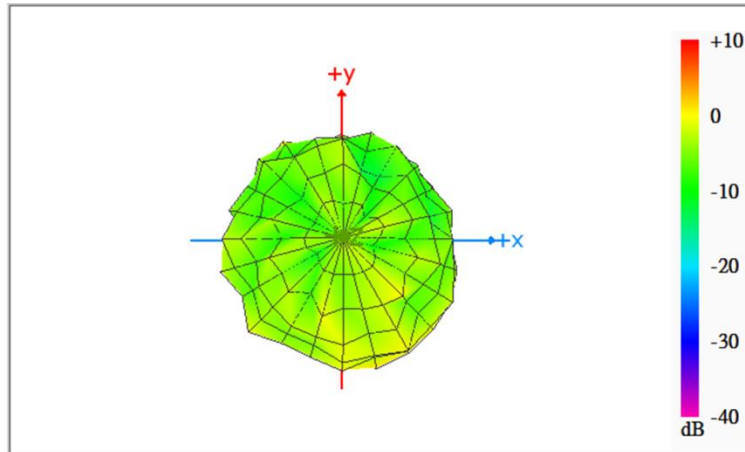

## Max Antenna 3D Radiation Pattern 5470-5725 MHz

Frequency (MHz)	Peak Gain w/ Cable Loss (dBi)
5470-5725	2.86

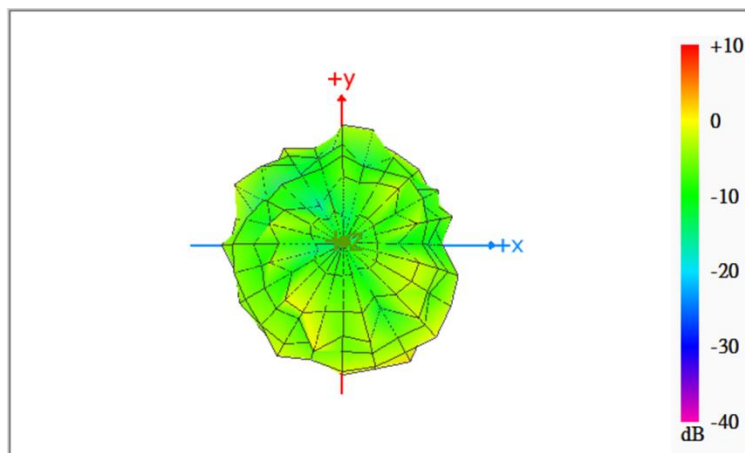

## Max Antenna 3D Radiation Pattern 5725-5850 MHz

Frequency (MHz)	Peak Gain w/ Cable Loss (dBi)
5725-5850	3.65

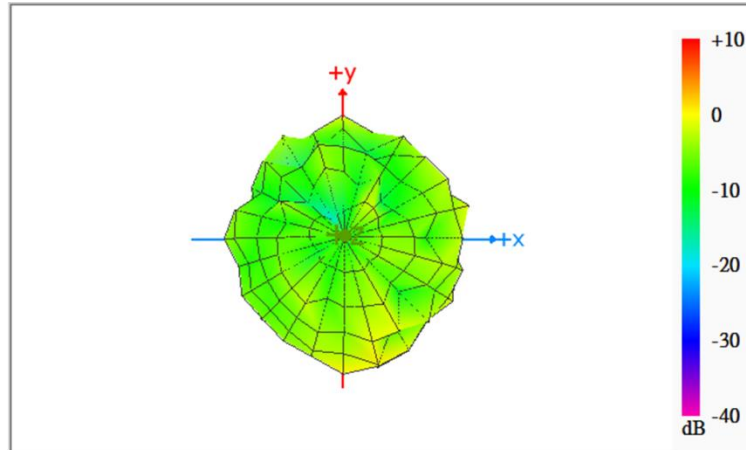

## Max Antenna 3D Radiation Pattern 5850-5895 MHz

Frequency (MHz)	Peak Gain w/ Cable Loss (dBi)
5850-5895	2.65

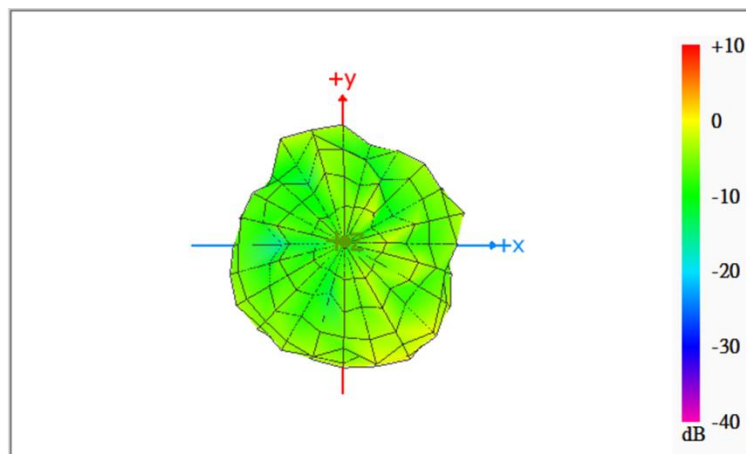



## Max Antenna 3D Radiation Pattern 5925-6425 MHz

Frequency (MHz)	Peak Gain w/ Cable Loss (dBi)
5925-6425	2.29

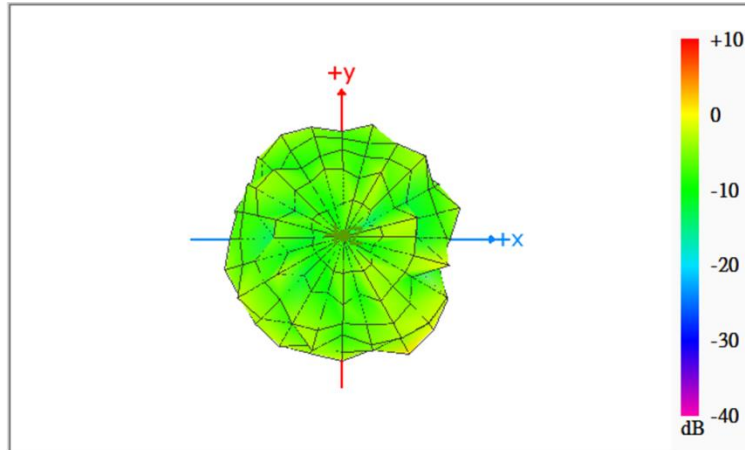

## Max Antenna 3D Radiation Pattern 6425-6525 MHz

Frequency (MHz)	Peak Gain w/ Cable Loss (dBi)
6425-6525	1.73

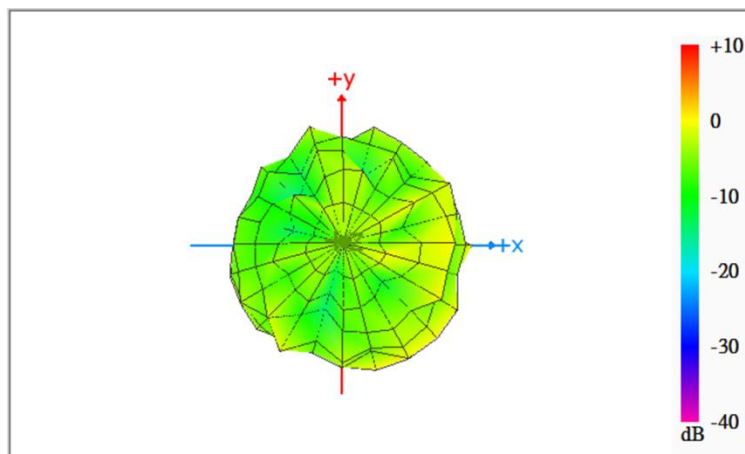

## Max Antenna 3D Radiation Pattern 6525-6875 MHz

Frequency (MHz)	Peak Gain w/ Cable Loss (dBi)
6525-6875	0.55

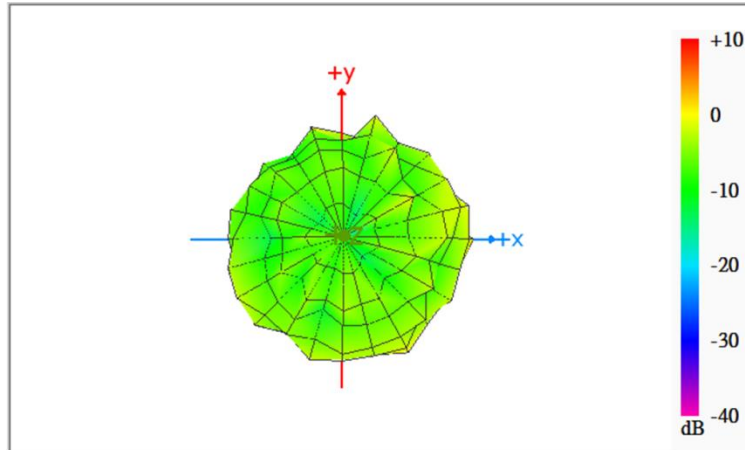

## Max Antenna 3D Radiation Pattern 6875-7125 MHz

Frequency (MHz)	Peak Gain w/ Cable Loss (dBi)
6875-7125	1.63

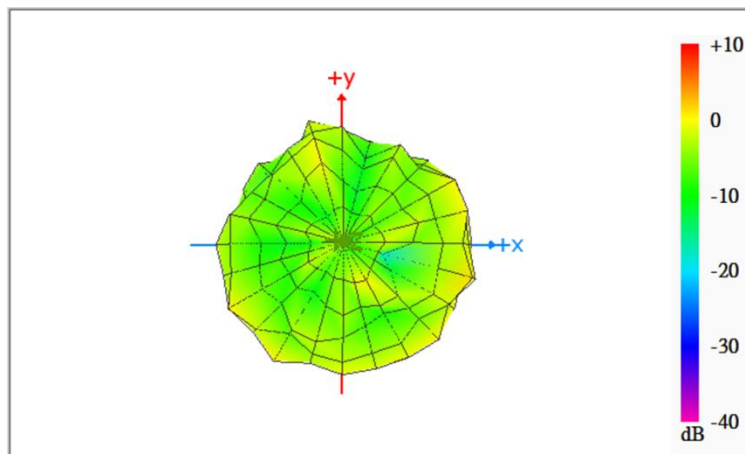

## Auxiliary Antenna

### Max Antenna 3D Radiation Pattern 2400 – 2483.5 MHz

Frequency (MHz)	Peak Gain w/ Cable Loss (dBi)
2400-2483.5	-1.75

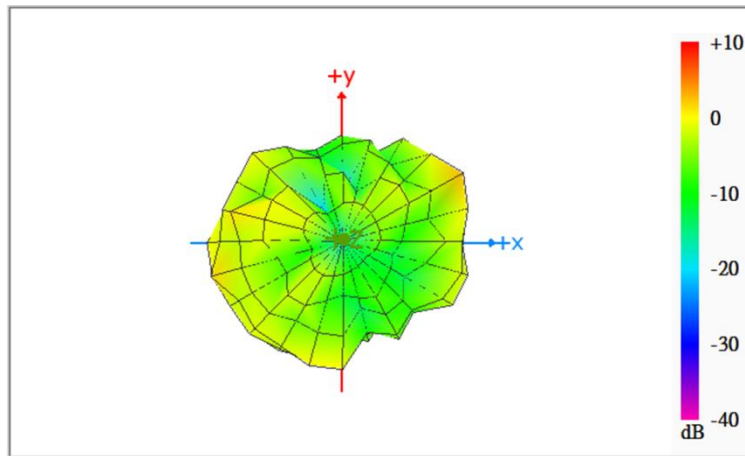

### Max Antenna 3D Radiation Pattern 5150-5250 MHz

Frequency (MHz)	Peak Gain w/ Cable Loss (dBi)
5150-5250	0.11

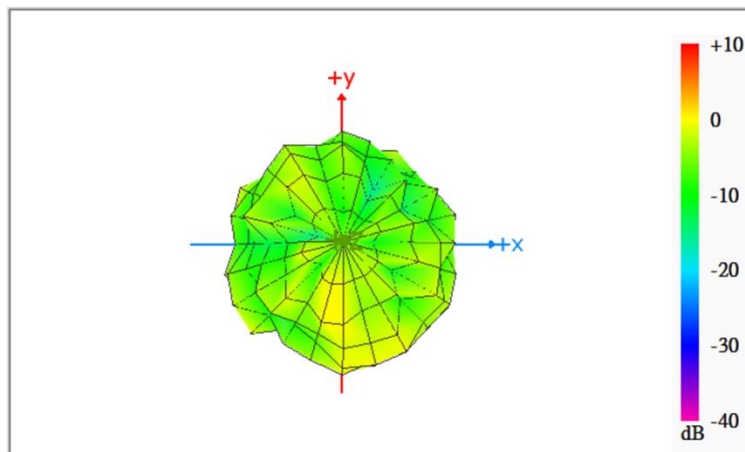

## Max Antenna 3D Radiation Pattern 5250-5350 MHz

Frequency (MHz)	Peak Gain w/ Cable Loss (dBi)
5250-5350	-0.19

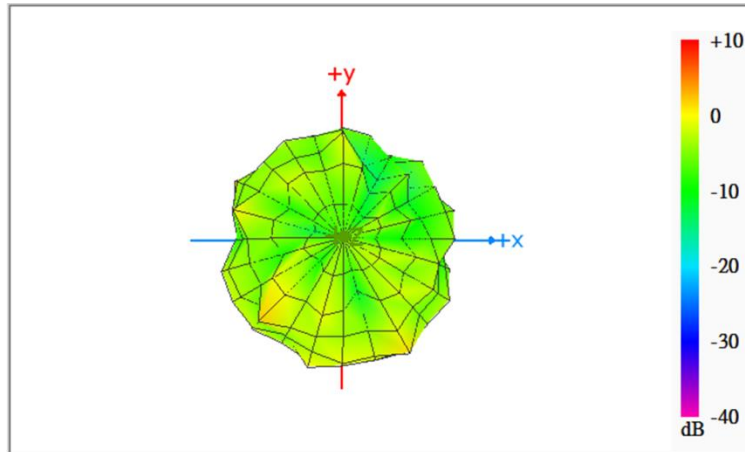

## Max Antenna 3D Radiation Pattern 5470-5725 MHz

Frequency (MHz)	Peak Gain w/ Cable Loss (dBi)
5470-5725	1.25

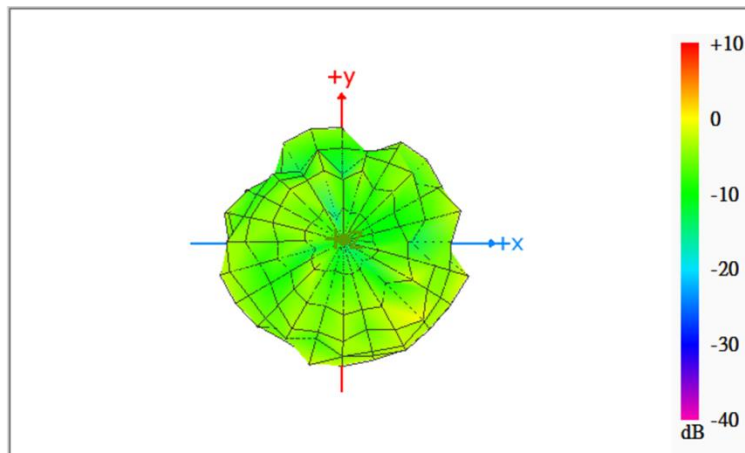

## Max Antenna 3D Radiation Pattern 5725-5850 MHz

Frequency (MHz)	Peak Gain w/ Cable Loss (dBi)
5725-5850	1.27

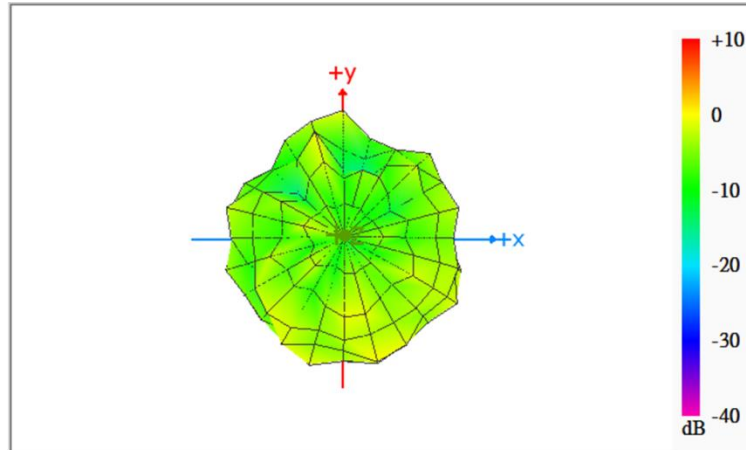

## Max Antenna 3D Radiation Pattern 5850-5895 MHz

Frequency (MHz)	Peak Gain w/ Cable Loss (dBi)
5850-5895	0.39

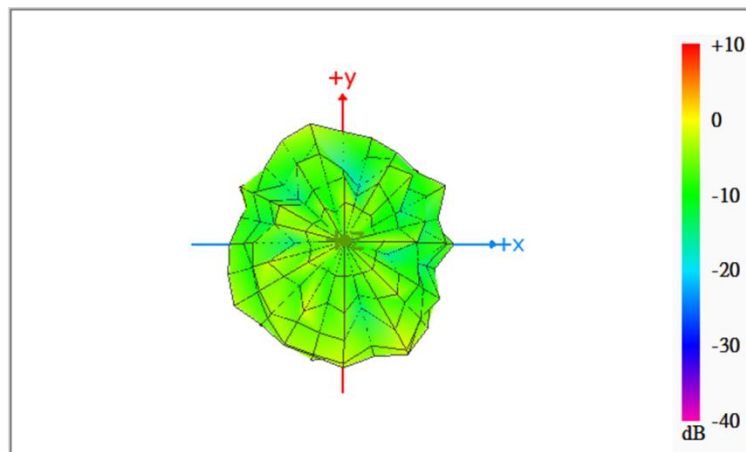

## Max Antenna 3D Radiation Pattern 5925-6425 MHz

Frequency (MHz)	Peak Gain w/ Cable Loss (dBi)
5925-6425	1.08

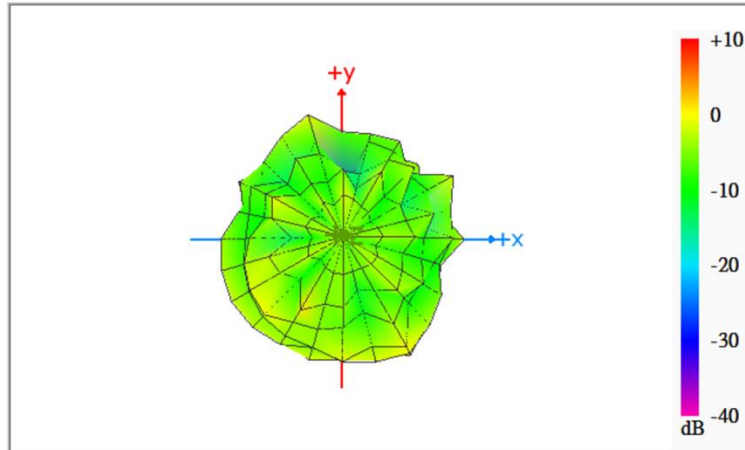

## Max Antenna 3D Radiation Pattern 6425-6525 MHz

Frequency (MHz)	Peak Gain w/ Cable Loss (dBi)
6425-6525	0.58

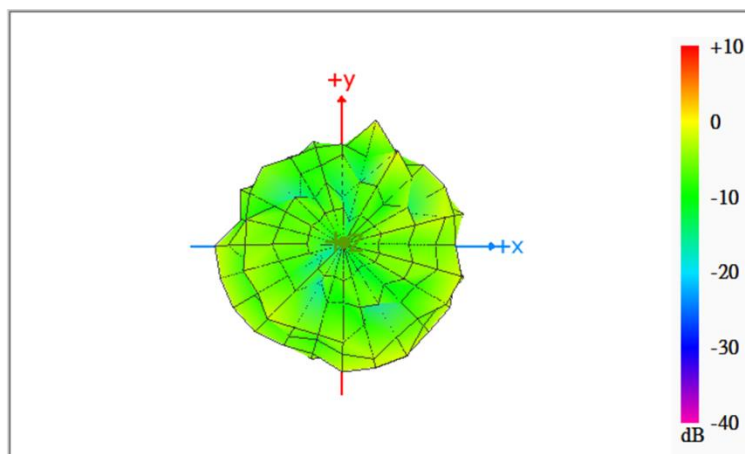

## Max Antenna 3D Radiation Pattern 6525-6875 MHz

Frequency (MHz)	Peak Gain w/ Cable Loss (dBi)
6525-6875	-0.15

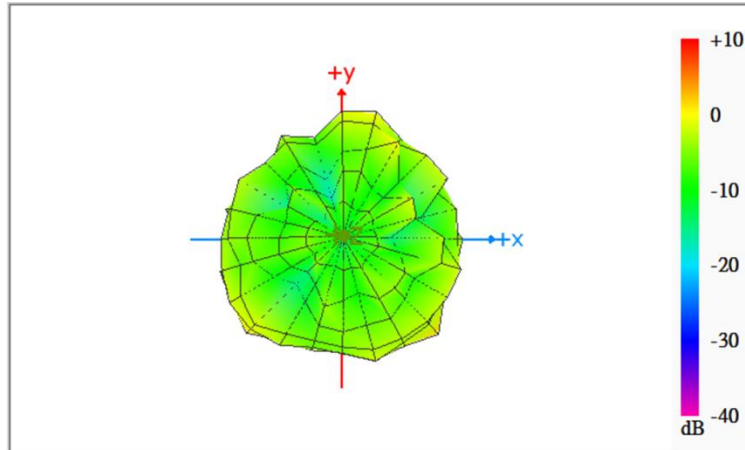

## Max Antenna 3D Radiation Pattern 6875-7125 MHz

Frequency (MHz)	Peak Gain w/ Cable Loss (dBi)
6875-7125	-0.11

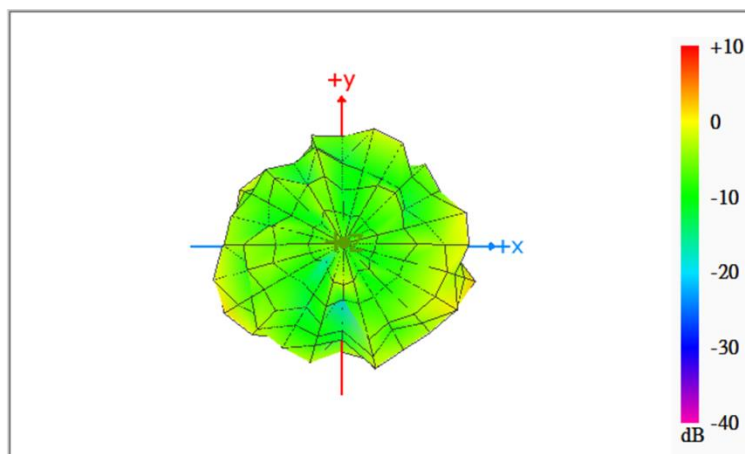

# Annex B. Antenna Location

## B.1 Antenna Host Platform Location Information

Include a dimensioned photo(s) or dimensioned drawing(s) of Main and Aux antenna placements (measurements are not required for receive-only antenna).

Any antenna that transmits must show dimensions to bottom of laptop. Provide a description of the materials that are used for supporting or surrounding transmit antennas; for example, non-conductive plastics vs. conductive coated plastic or metallic materials.

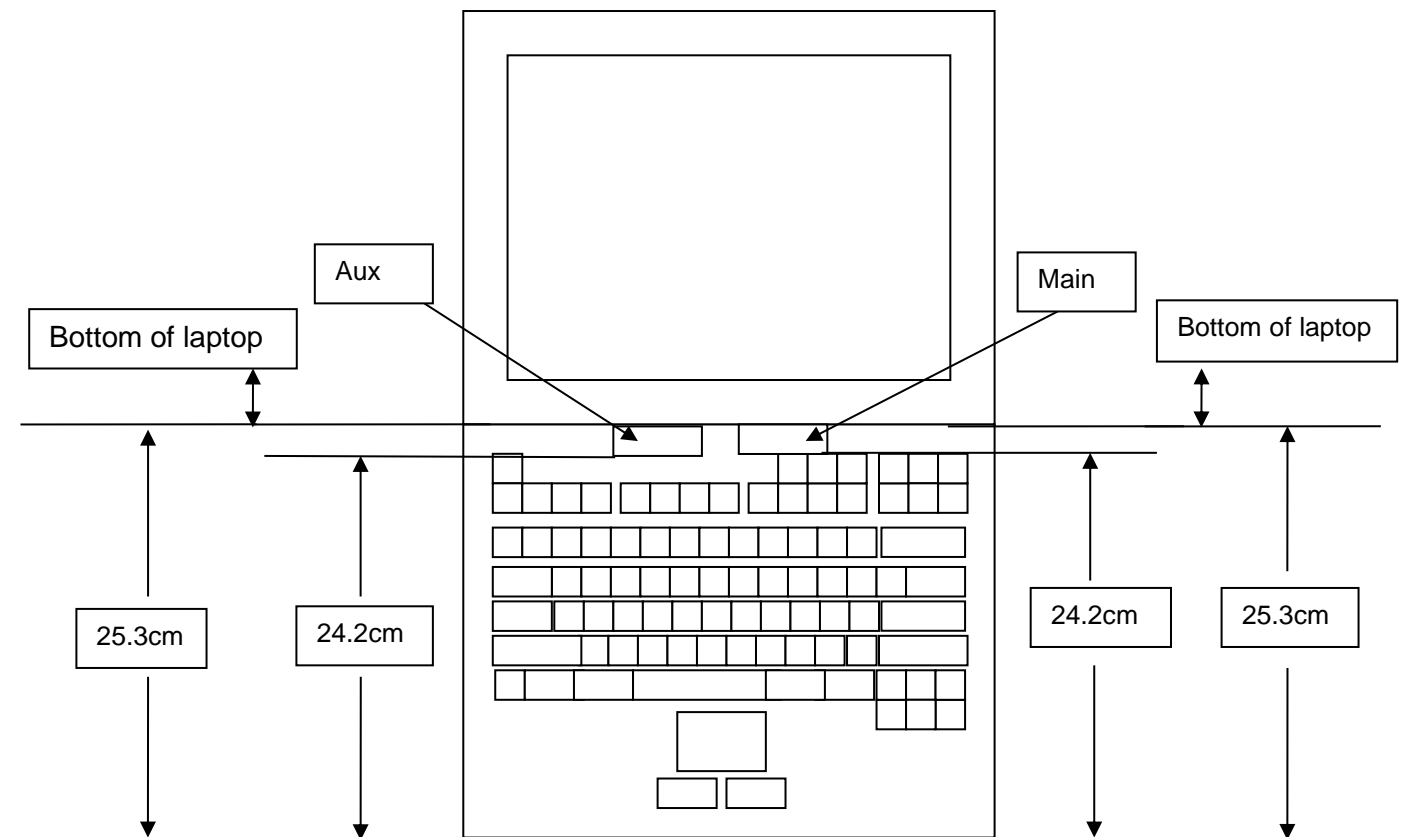



## B.2 Antenna dimensional information for SAR evaluation

Include a dimensioned photo(s) or dimensioned drawing(s) showing the distance (mm) between the transmit antennas and the user. For notebook/laptop hosts show lapheld position (example below). For tablet hosts show all orientations including lapheld, primary & secondary portrait, primary & secondary landscape positions. Include a description of any proximity sensors or power throttling implementations that limit or exclude use of any host orientation.

