

Regulatory WLAN Antenna Information (Template)

English Language Required for Intel Regulatory Review / Approval

(OEM/ODM or antenna vendor is required to complete this document with platform antenna information.

Remove Intel references and make this your own document)

Platform information											
Brand	ODM	****End product model name				Intel platform (ex: Yes, No or NA)	Platform type (ex: regular NB, convertible PC, AIO...etc)			*SAR minimum separation (mm)	
LG	Quanta	16TD90R, 16TB90R , 16TG90R, 16T90R*				Yes	Convertible PC			2.35	
****Please fill in exact product model name and make sure the model name is visible on product cover or any parts for end users recognize for authority inspection.											
Antenna information											
Vendor		Type			Antenna Part number (Main)			Antenna Part number (Aux)			
Pulse		PIFA			DQ602119000 (TZ21190)			DQ602119000 (TZ21190)			
Peak gain w/ cable loss (dBi)*											
	2.4GHz 2400-2483.5 MHz	5.2GHz 5150-5250MHz	5.3GHz 5250-5350MHz	5.6GHz 5470-5725MHz	5.8GHz 5725-5850MHz	5.9GHz 5850-5895MHz	6.2GHz 5925-6425MHz	6.5GHz 6425-6525MHz	6.7GHz 6525-6875MHz	7.0 GHz 6875-7125MHz	
Main	2.68	2.38	1.65	1.02	1.11	0.73	0.35	0.35	-1.49	-1.49	
Aux	2.42	1.34	1.14	2.38	2.06	0.92	2.56	1.65	1.03	0.88	
Intel Reference Gain/Type/ Separation distance											
Antenna Type	Antenna Peak gain (In dBi)*										Distance to the end user (mm)
	2.4GHz 2400-2483.5 MHz	5.2GHz 5150-5250MHz	5.3GHz 5250-5350MHz	5.6GHz 5470-5725MHz	5.8GHz 5725-5850MHz	5.9GHz 5850-5895MHz	6.2GHz 5925-6425MHz	6.5GHz 6425-6525MHz	6.7GHz 6525-6875MHz	7.0GHz 6875-7125MHz	Generic: refer to modular FCC SAR report
Design	3.00	5.00	5.00	5.00	5.00	5.00	5.00	5.00	5.00	5.00	Mid-power: ≥ 8 mm Low power: ≥ 5 mm
PIFA	3.24	3.64	3.73	4.77	4.97	4.72	4.83	4.30	5.37	5.59	
Dipole	2.89	2.92	3.19	4.41	4.22	4.22	4.83	4.30	4.49	5.34	
Notes (marked with *)											
* SAR minimum separation (mm)											
- Regular NB: Minimum antenna-to-body (from antenna bottom to the bottom of the device)											
- Tablet / Convertible PC: Minimum antenna-to-edge (5 sides of the device)											
- Mini-tablet: Minimum antenna-to-edge (6 sides of the device)											
* 3D Peak Antenna gain should be equal or greater than -2 dBi											
- If a host integrator plans to use a lower gain antenna of the same type, additional CBP(FCC)/EDT(EU) testing need to be performed while the module is installed in the host.											

Table of contents

1. Applicable test method
2. Test & System Description
 - a. Test setup
 - b. Equipment list

3. Setup photo

[Section 1. Antenna Assembly Specifications](#)

[Section 2. Dimensioned Photos or Drawings of Antennas](#)

[Section 3. Radiation characteristics of antenna loaded in Host Platform](#)

[Section 4. Antenna Host Platform Location Information](#)

[Section 5. Antenna dimensional information for SAR evaluation](#)

[Section 6. Diagram Example of Co-Location Antenna Separation](#)

1. **Applicable test methods**

This test report is prepared for host antenna testing under a Full Anechoic Chamber.

2. **Test & System Description**

a. Test setup

Radiated Setup 0.6GHz-8.5GHz

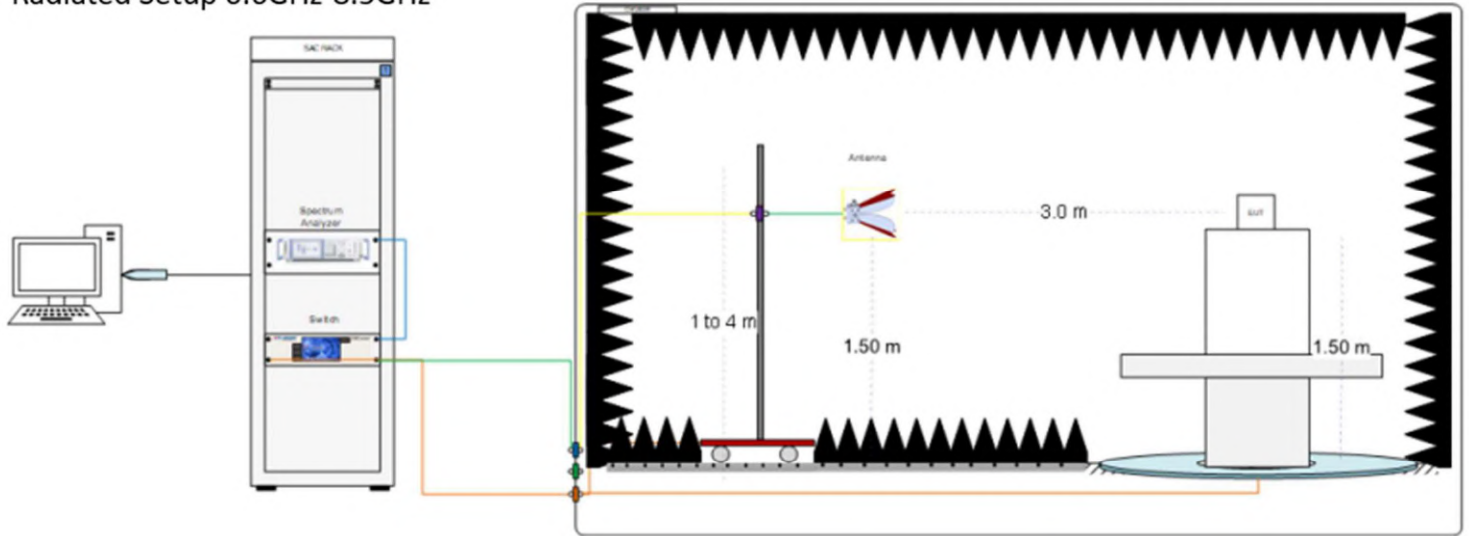

b. Equipment list

ID#	Device	Type/Model	Serial#	Manufactuter	Cal. Date	Cal. Due Date
1	Anechoic Chamber	AMS8500	-	ETS-Lindgren	2022-05-10	2023-05-10
2	Turn Table	ETS	-	ETS-Lindgren	N/A	N/A
3	Switch & Positioning system	2090	-	ETS-Lindgren	N/A	N/A
4	Horn Antenna	3164-08	99210	ETS-Lindgren	N/A	N/A
5	Network Analyzer	E5071C	MY46103999	Agilent	2022-05-10	2023-05-10
6	Commercial test software	EMQuest	Version 1.14 Build 10265 SN:1156	ETS-Lindgren	2022-05-10	2023-05-10
7	Test Operator	Mars Tsai		Pulse	2022/11/24	

3. Setup photo

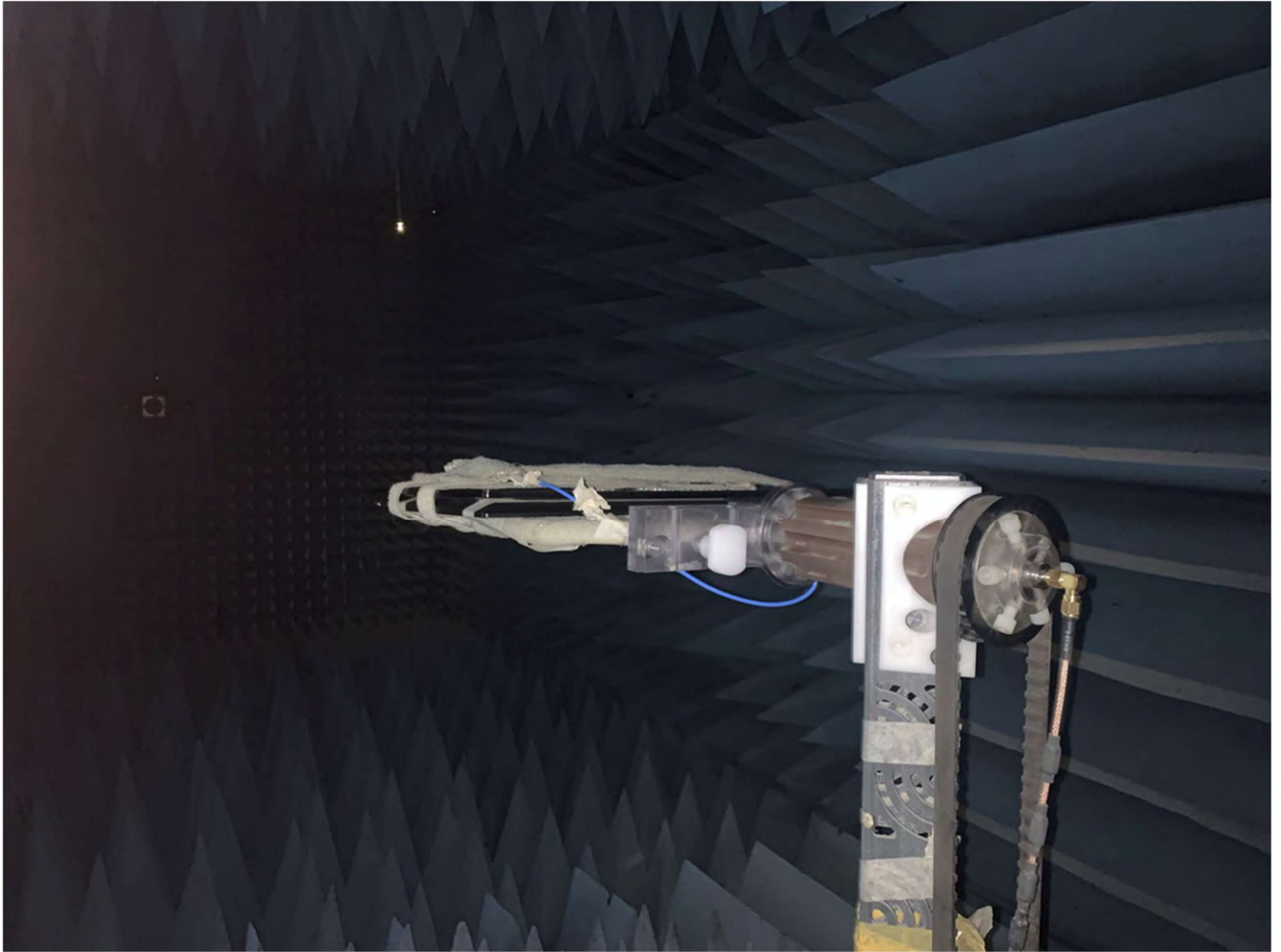

Antenna Information

Section 1. Antenna Assembly Specifications

1A Antenna Part Number	1B Manufacturer	1C Antenna Type	1D Cable Assembly Part Number and Information	Freq RangeMHz	1E *Total Peak Gain W/ Cable loss (dBi)	1F Total Peak Gain w/o Cable Loss (dBi)	1G Max VSWR	1H Cable Loss (dB)
Customer P/N: DQ602119000 Pulse P/N: TZ21190 Tx1 Main Antenna	Pulse	PIFA	Connector: IPEX 20565-001R-13 or compatible. Cable: SY113L/50-001 or compatible. 50 ohm Coaxial. Length: 135 mm diameter: 1.13 LLS mm	2400-2483.5	2.68	3.09	3.00 max	0.41
				5150-5250	2.38	2.92	3.00 max	0.54
				5250-5350	1.65	2.20	3.00 max	0.55
				5470-5725	1.02	1.59	3.00 max	0.57
				5725-5850	1.11	1.68	3.00 max	0.57
				5850-5895	0.73	1.30	3.00 max	0.57
				5925-6425	0.35	0.95	3.00 max	0.60
				6425-6525	0.35	0.96	3.00 max	0.61
				6525-6875	-1.49	-0.87	3.00 max	0.62
6875-7125	-1.49	-0.86	3.00 max	0.63				
Customer P/N: DQ602119000 Pulse P/N: TZ21190 Tx2 Aux Antenna	Pulse	PIFA	Connector: IPEX 20565-001R-13 or compatible. Cable: SY113L/50-001 or compatible. 50 ohm Coaxial. Length: 135 mm diameter: 1.13 LLS mm	2400-2483.5	2.42	2.83	3.00 max	0.41
				5150-5250	1.34	1.88	3.00 max	0.54
				5250-5350	1.14	1.69	3.00 max	0.55
				5470-5725	2.38	2.95	3.00 max	0.57
				5725-5850	2.06	2.63	3.00 max	0.57
				5850-5895	0.92	1.49	3.00 max	0.57
				5925-6425	2.56	3.16	3.00 max	0.60
				6425-6525	1.65	2.26	3.00 max	0.61
				6525-6875	1.03	1.65	3.00 max	0.62
6875-7125	0.88	1.51	3.00 max	0.63				

- 3D Antenna Peak Gain required being test in system basis.

Section 2. Dimensioned Photos and Drawings of Antennas

Include the dimensioned photo and drawing of Main antenna here.

Main Antenna Drawing:

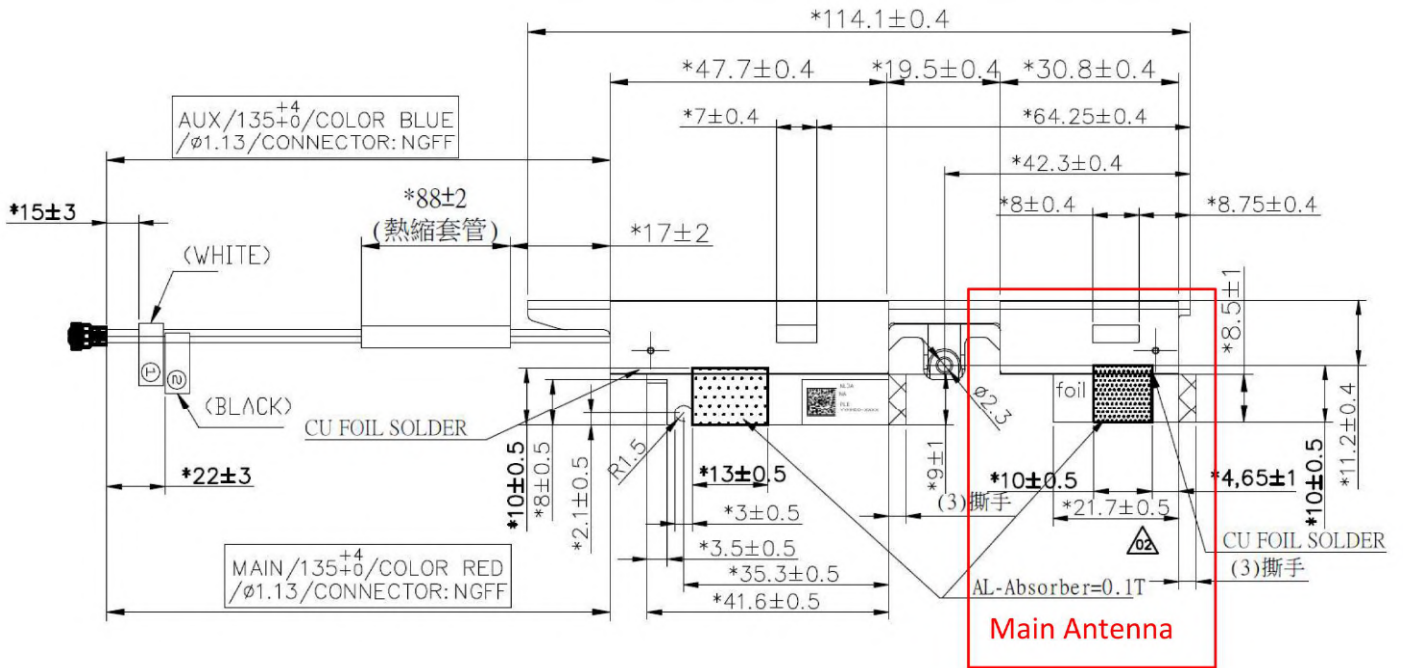

Main Antenna Photo (Front/Back):

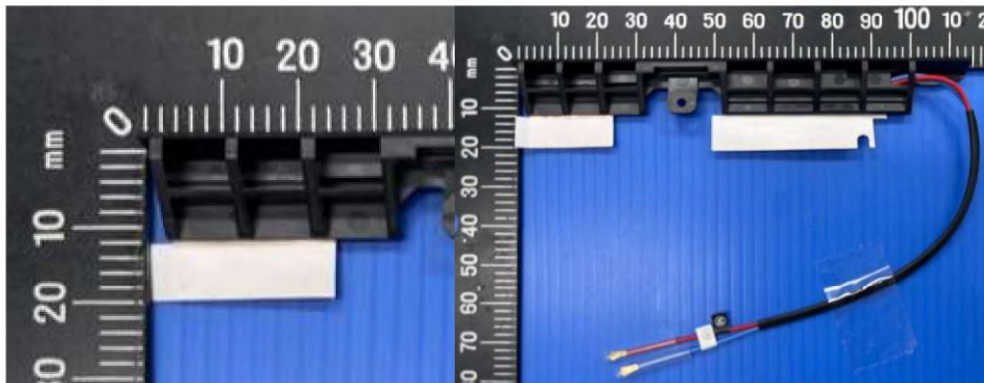
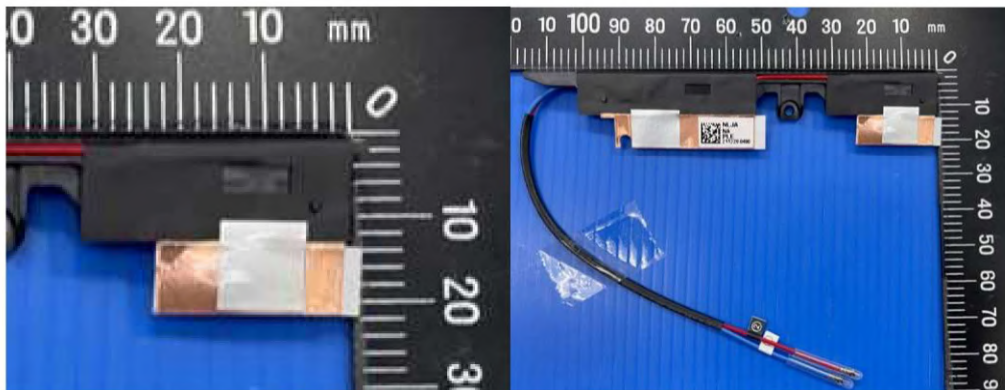

Note: antenna photo should include L type ruler

Include the dimensioned photo and drawing of Aux antenna here.

Aux Antenna Drawing:

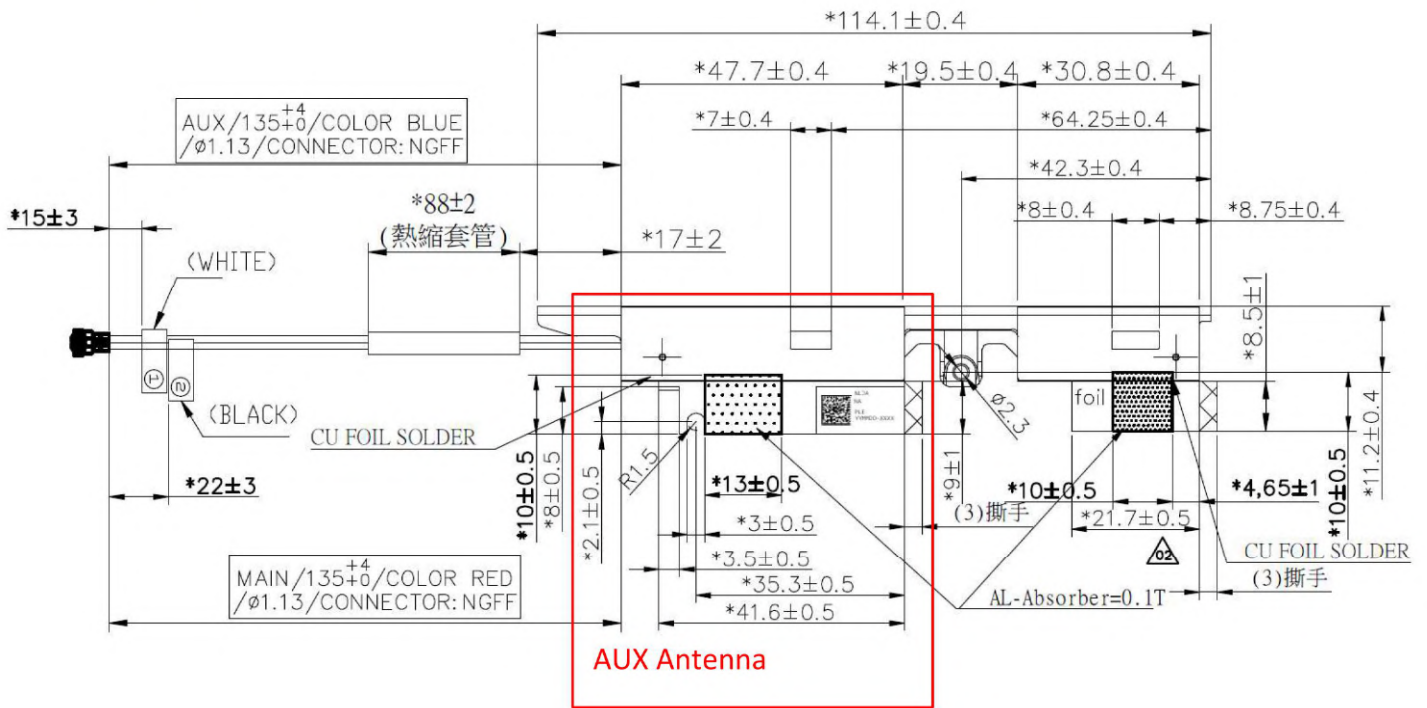

Aux Antenna Photo (Front/Back):

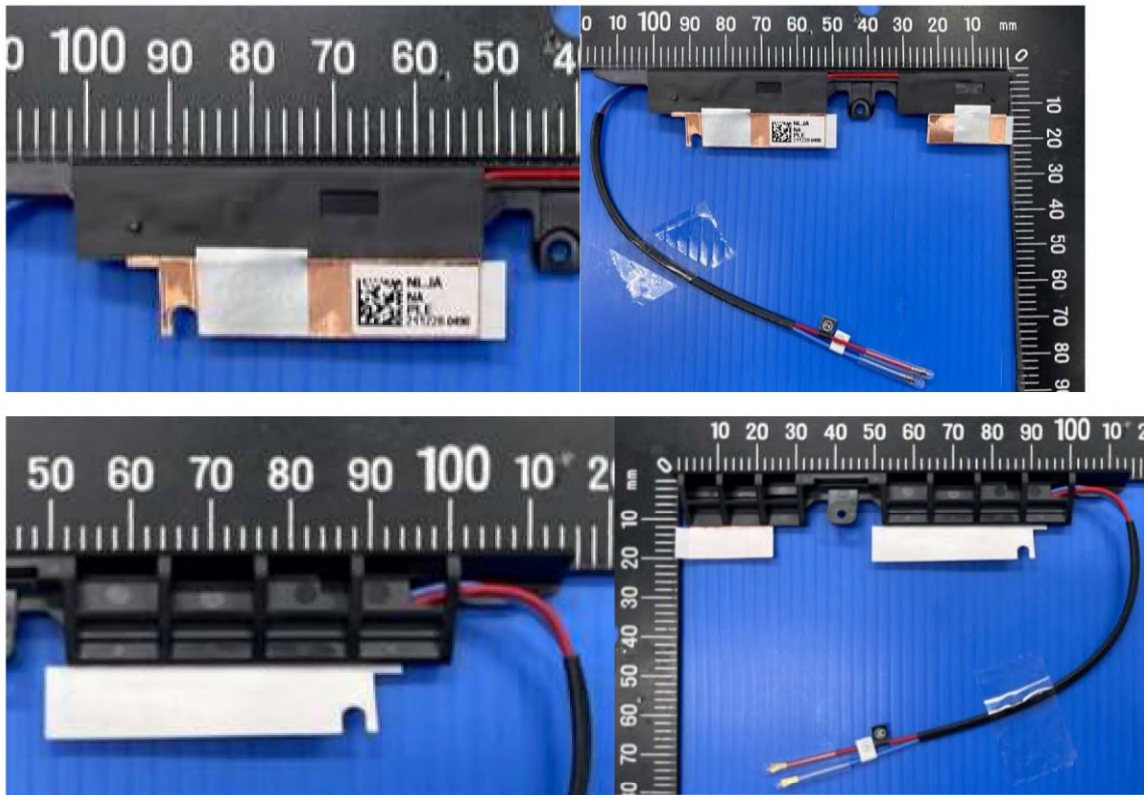

Note: antenna photo should include L type ruler

Section 3. Radiation characteristics of antenna loaded in Host Platform

Main Antenna

Max Antenna 3D Radiation Pattern 2400 – 2483.5 MHz

Frequency (MHz)	Peak Gain w/ Cable Loss (dBi)
2400-2483.5	2.68

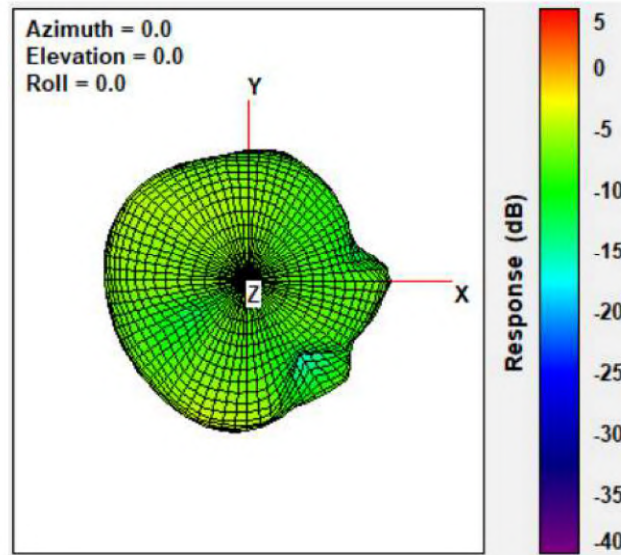

Max Antenna 3D Radiation Pattern 5150-5250 MHz

Frequency (MHz)	Peak Gain w/ Cable Loss (dBi)
5150-5250	2.38

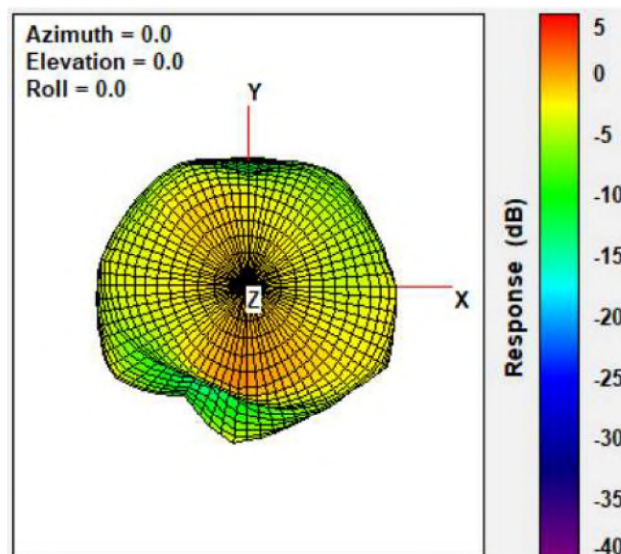

Max Antenna 3D Radiation Pattern 5250-5350 MHz

Frequency (MHz)	Peak Gain w/ Cable Loss (dBi)
5250-5350	1.65

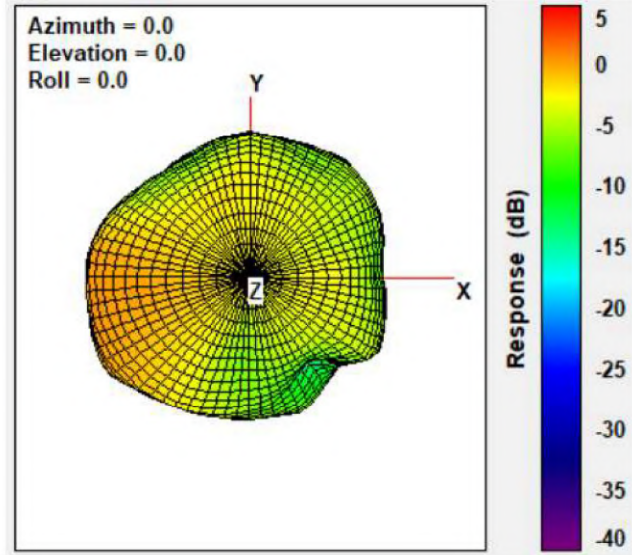

Max Antenna 3D Radiation Pattern 5470-5725 MHz

Frequency (MHz)	Peak Gain w/ Cable Loss (dBi)
5470-5725	1.02

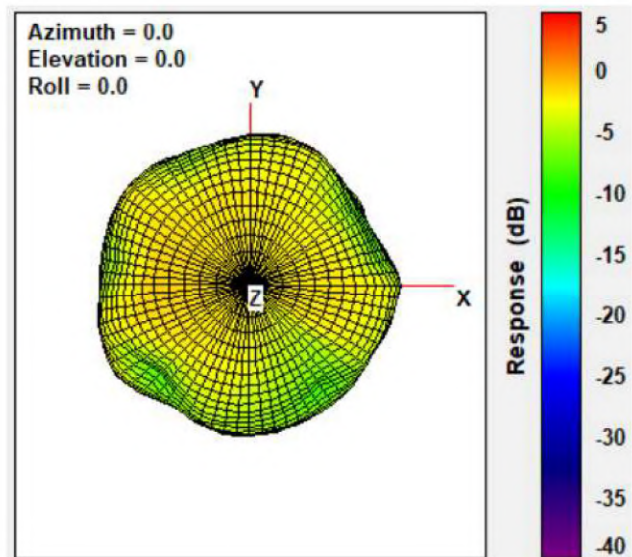

Max Antenna 3D Radiation Pattern 5725-5850 MHz

Frequency (MHz)	Peak Gain w/ Cable Loss (dBi)
5725-5850	1.11

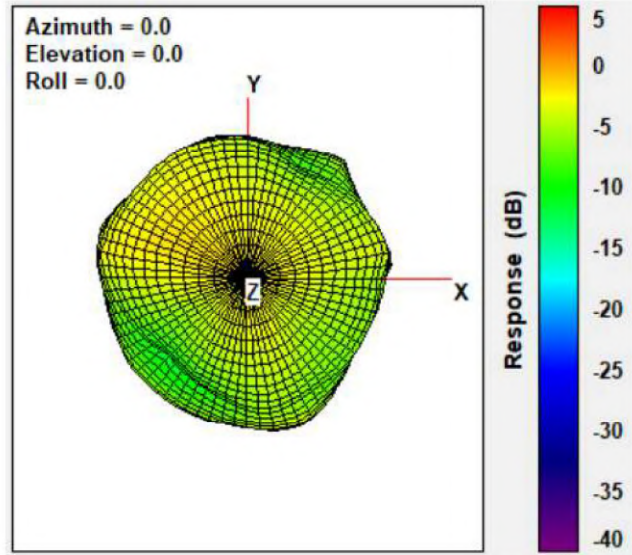

Max Antenna 3D Radiation Pattern 5850-5895 MHz

Frequency (MHz)	Peak Gain w/ Cable Loss (dBi)
5850-5895	0.73

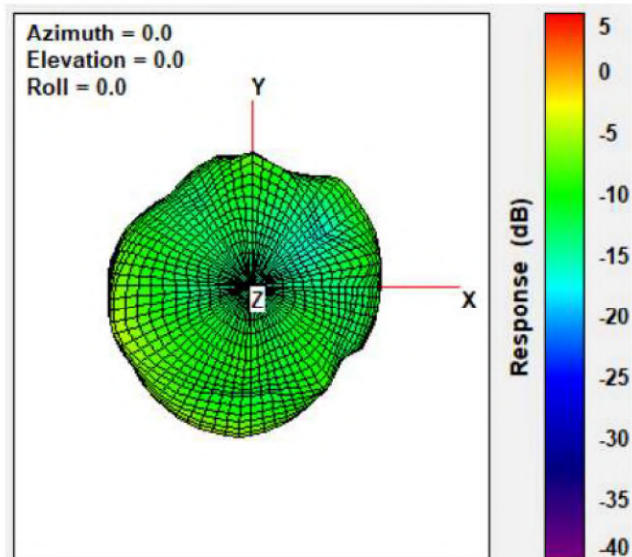

Max Antenna 3D Radiation Pattern 5925-6425 MHz

Frequency (MHz)	Peak Gain w/ Cable Loss (dBi)
5925-6425	0.35

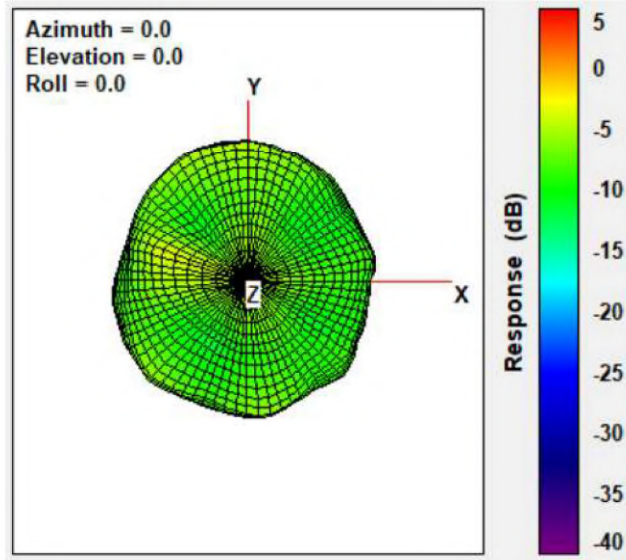

Max Antenna 3D Radiation Pattern 6425-6525 MHz

Frequency (MHz)	Peak Gain w/ Cable Loss (dBi)
6425-6525	0.35

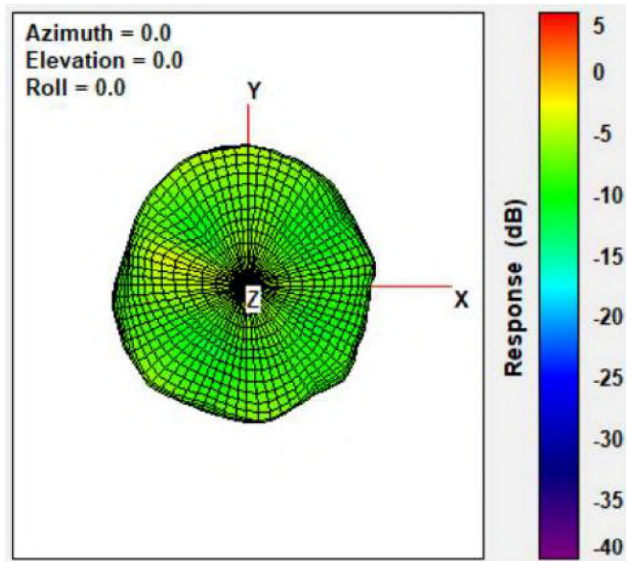

Max Antenna 3D Radiation Pattern 6525-6875 MHz

Frequency (MHz)	Peak Gain w/ Cable Loss (dBi)
6525-6875	-1.49

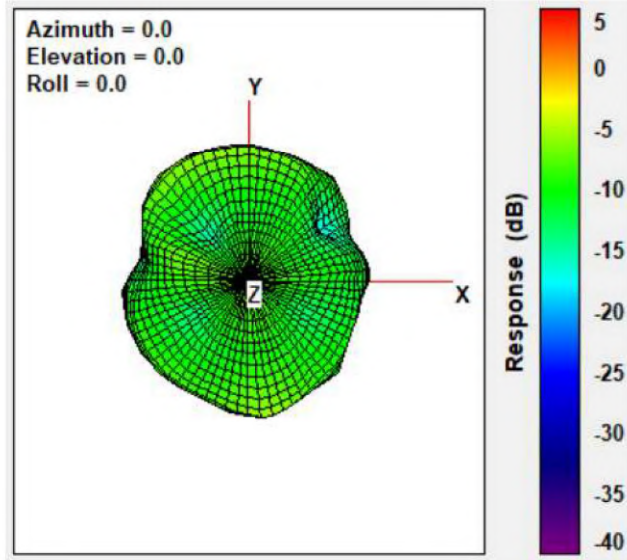

Max Antenna 3D Radiation Pattern 6875-7125 MHz

Frequency (MHz)	Peak Gain w/ Cable Loss (dBi)
6875-7125	-1.49

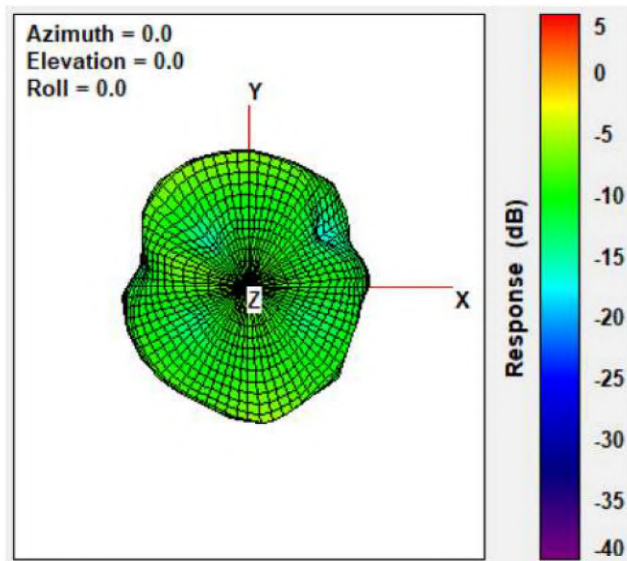

Auxiliary Antenna

Max Antenna 3D Radiation Pattern 2400 – 2483.5 MHz

Frequency (MHz)	Peak Gain w/ Cable Loss (dBi)
2400-2483.5	2.42

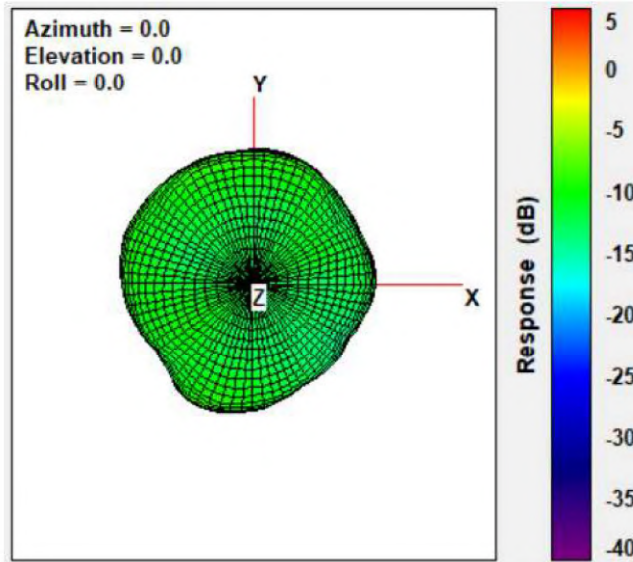

Max Antenna 3D Radiation Pattern 5150-5250 MHz

Frequency (MHz)	Peak Gain w/ Cable Loss (dBi)
5150-5250	1.34

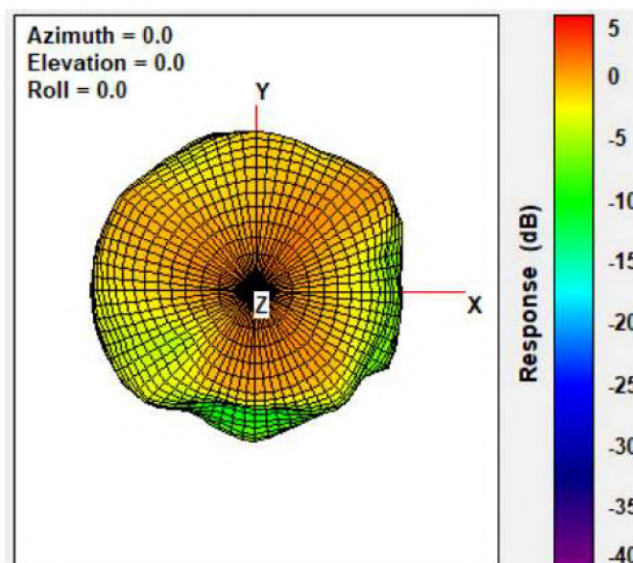

Max Antenna 3D Radiation Pattern 5250-5350 MHz

Frequency (MHz)	Peak Gain w/ Cable Loss (dBi)
5250-5350	1.14

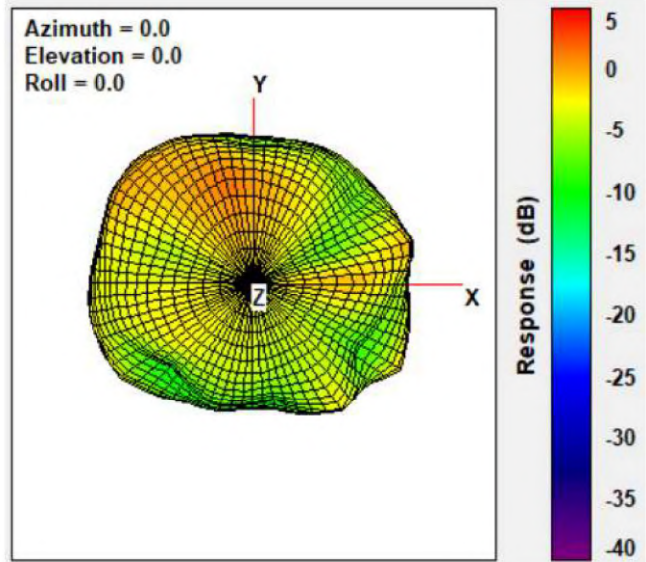

Max Antenna 3D Radiation Pattern 5470-5725 MHz

Frequency (MHz)	Peak Gain w/ Cable Loss (dBi)
5470-5725	2.38

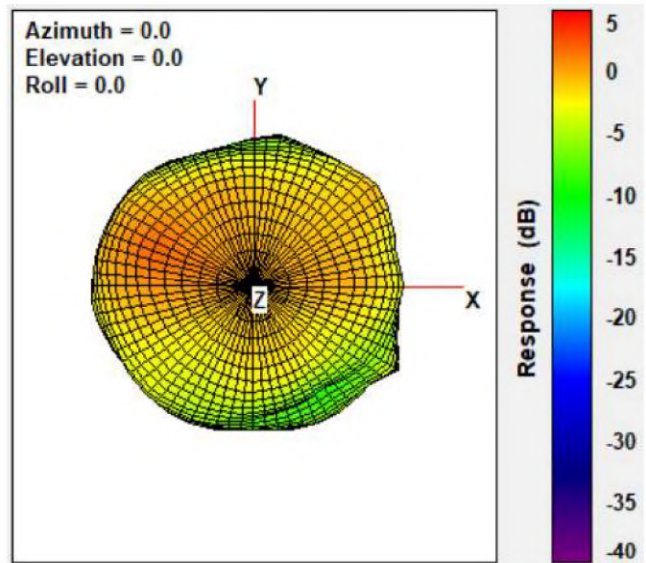

Max Antenna 3D Radiation Pattern 5725-5850 MHz

Frequency (MHz)	Peak Gain w/ Cable Loss (dBi)
5725-5850	2.06

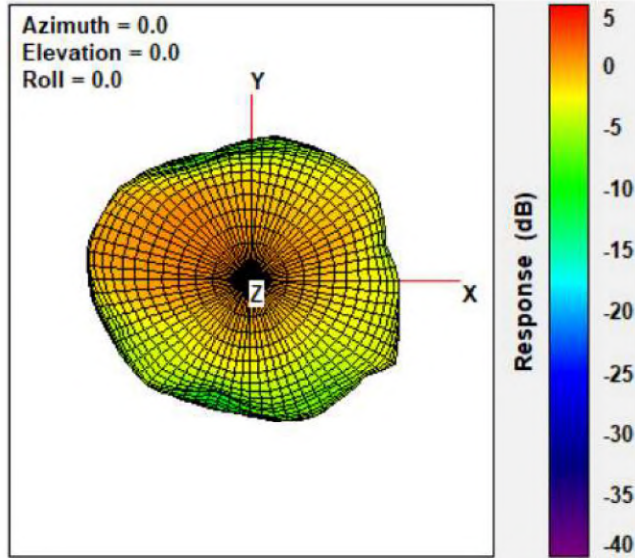

Max Antenna 3D Radiation Pattern 5850-5895 MHz

Frequency (MHz)	Peak Gain w/ Cable Loss (dBi)
5850-5895	0.92

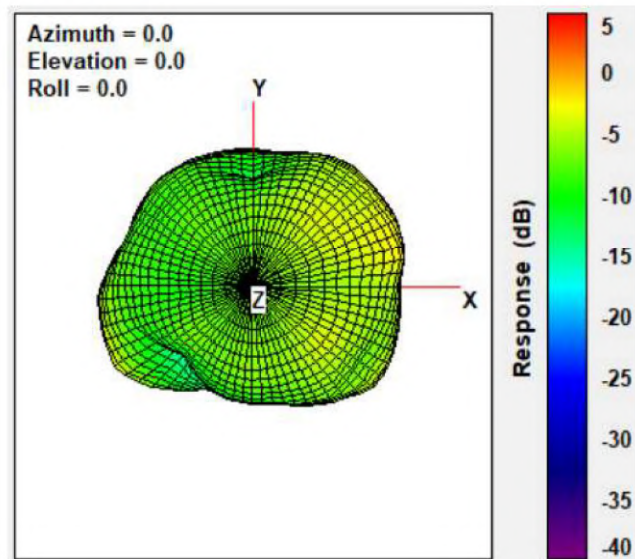

Max Antenna 3D Radiation Pattern 5925-6425 MHz

Frequency (MHz)	Peak Gain w/ Cable Loss (dBi)
5925-6425	2.56

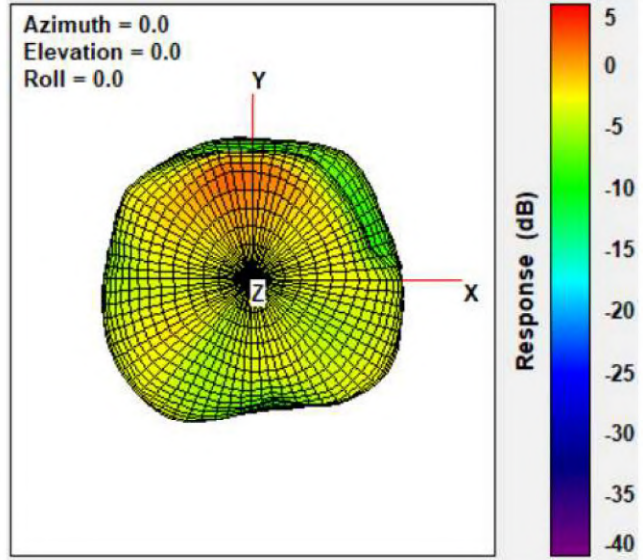

Max Antenna 3D Radiation Pattern 6425-6525 MHz

Frequency (MHz)	Peak Gain w/ Cable Loss (dBi)
6425-6525	1.65

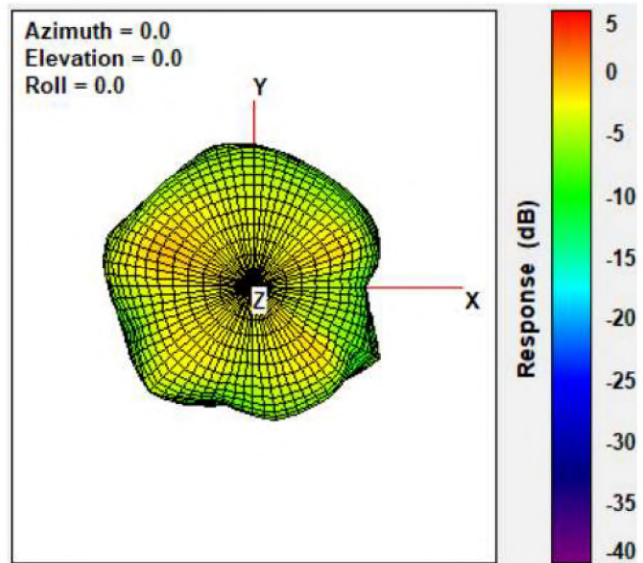

Max Antenna 3D Radiation Pattern 6525-6875 MHz

Frequency (MHz)	Peak Gain w/ Cable Loss (dBi)
6525-6875	1.03

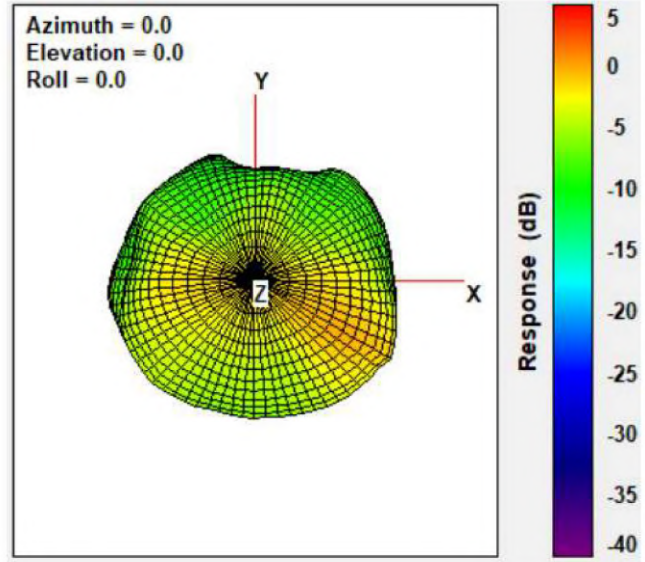

Max Antenna 3D Radiation Pattern 6875-7125 MHz

Frequency (MHz)	Peak Gain w/ Cable Loss (dBi)
6875-7125	0.88

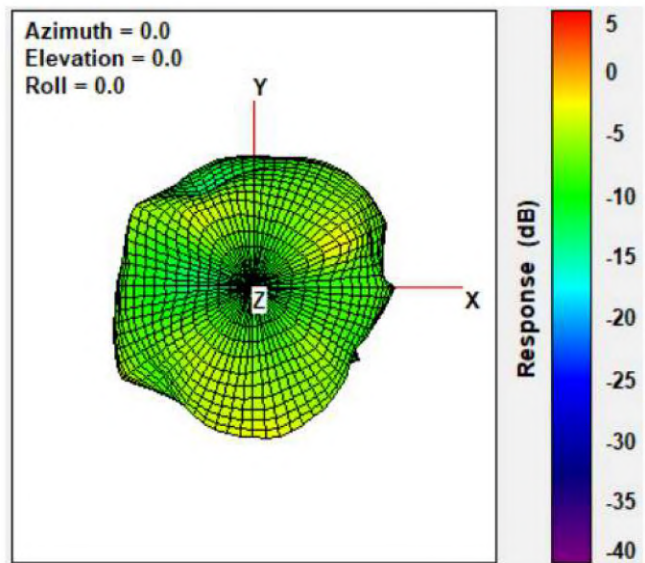

Section 4. Antenna Host Platform Location Information

Include a **dimensioned photo(s) or dimensioned drawing(s)** of Main and Aux antenna placements (measurements are not required for receive-only antenna).

Any antenna that transmits must show dimensions to bottom of laptop. Provide a description of the materials that are used for supporting or surrounding transmit antennas; for example, non-conductive plastics vs. conductive coated plastic or metallic materials.

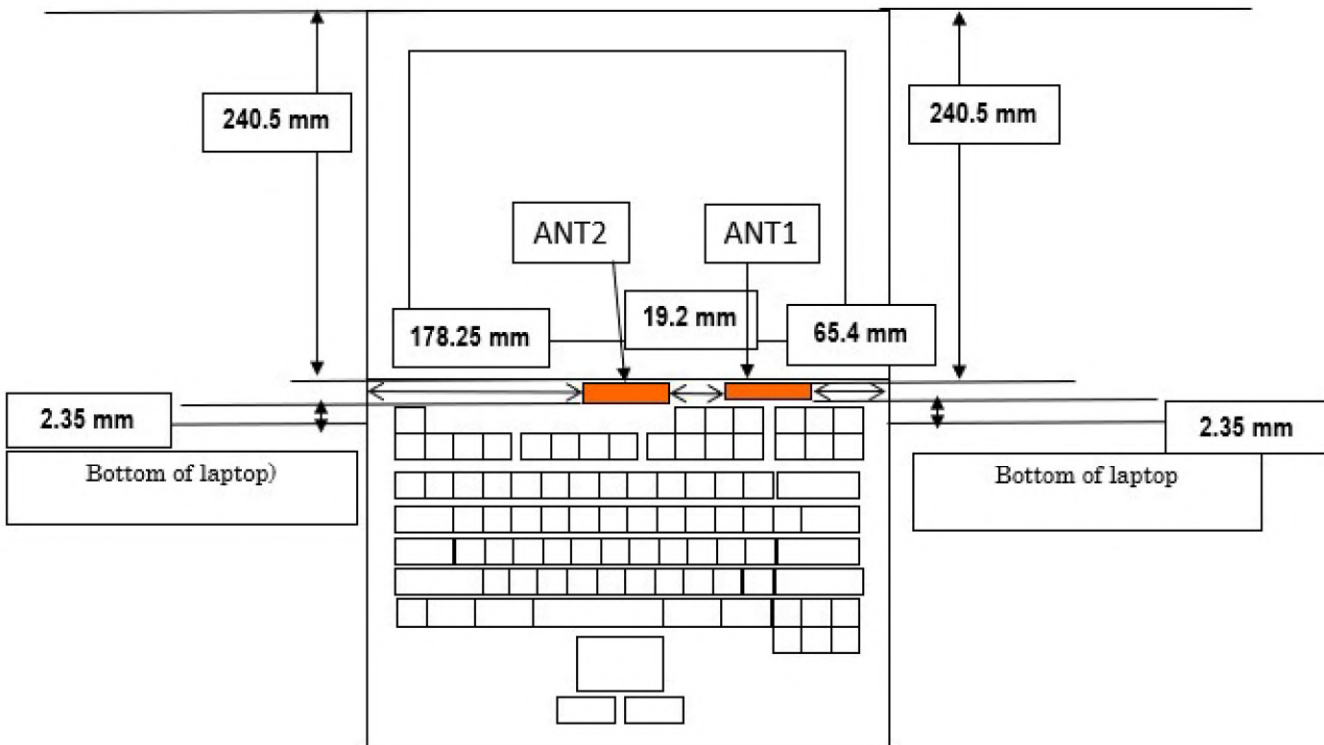

Section 5. Antenna dimensional information for SAR evaluation

Include a **dimensioned photo(s) or dimensioned drawing(s)** showing the distance (mm) between the transmit antennas and the user. For notebook/laptop hosts show lapheld position (example below). For tablet hosts show all orientations including lapheld, primary & secondary portrait, primary & secondary landscape positions. Include a description of any proximity sensors or power throttling implementations that limit or exclude use of any host orientation.

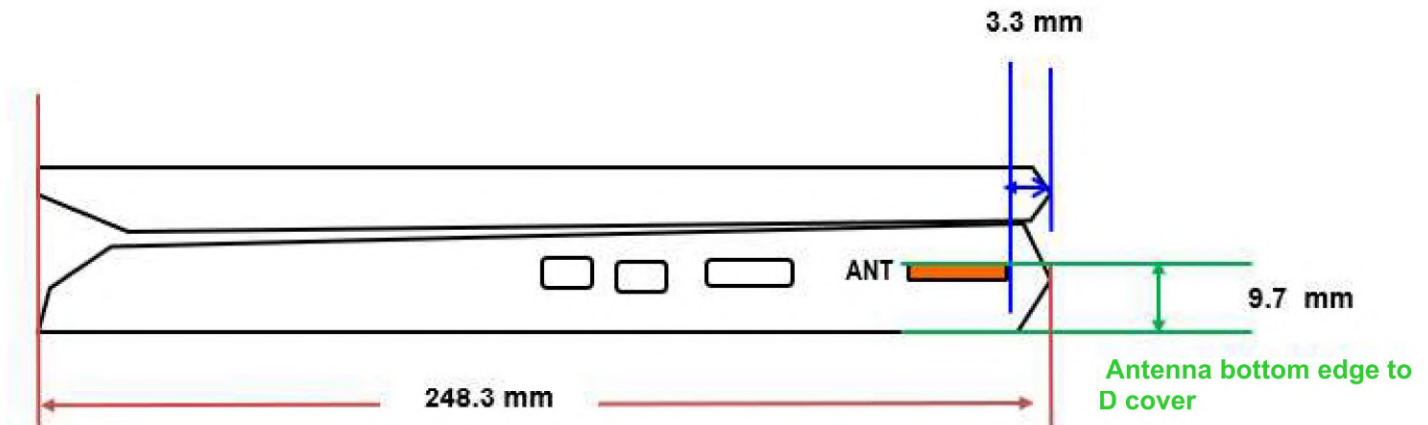
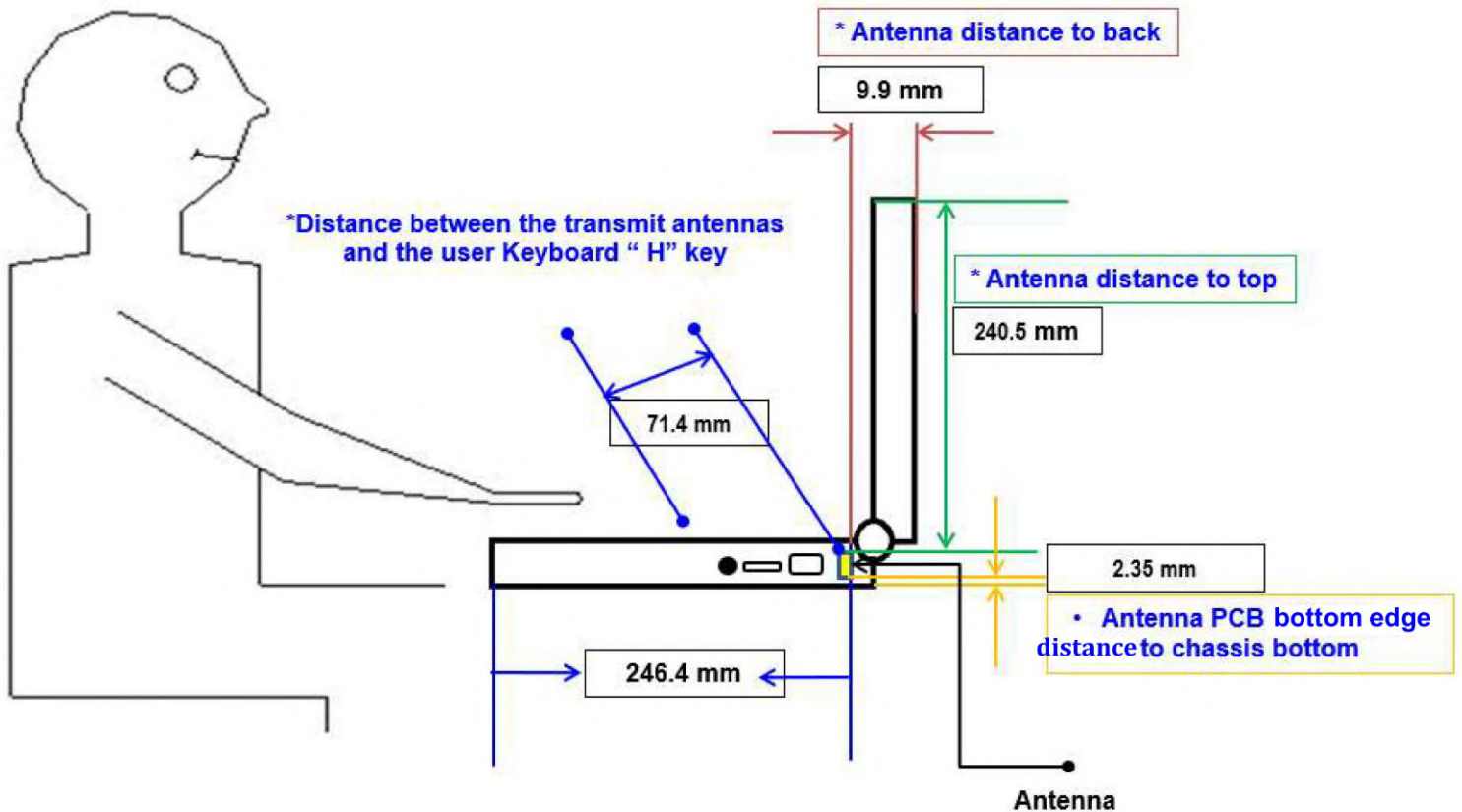

Section 6. Diagram Example of Co-Location Antenna Separation

Include a **dimensioned photo or dimensioned drawing** showing the distance (mm) between **all WLAN transmit antennas** and other co-located radiator transmit antenna such as Bluetooth, WWAN,..

(Note: Due to the evolving rules regarding co-location, each platform will need to be reviewed on a case by case basis)

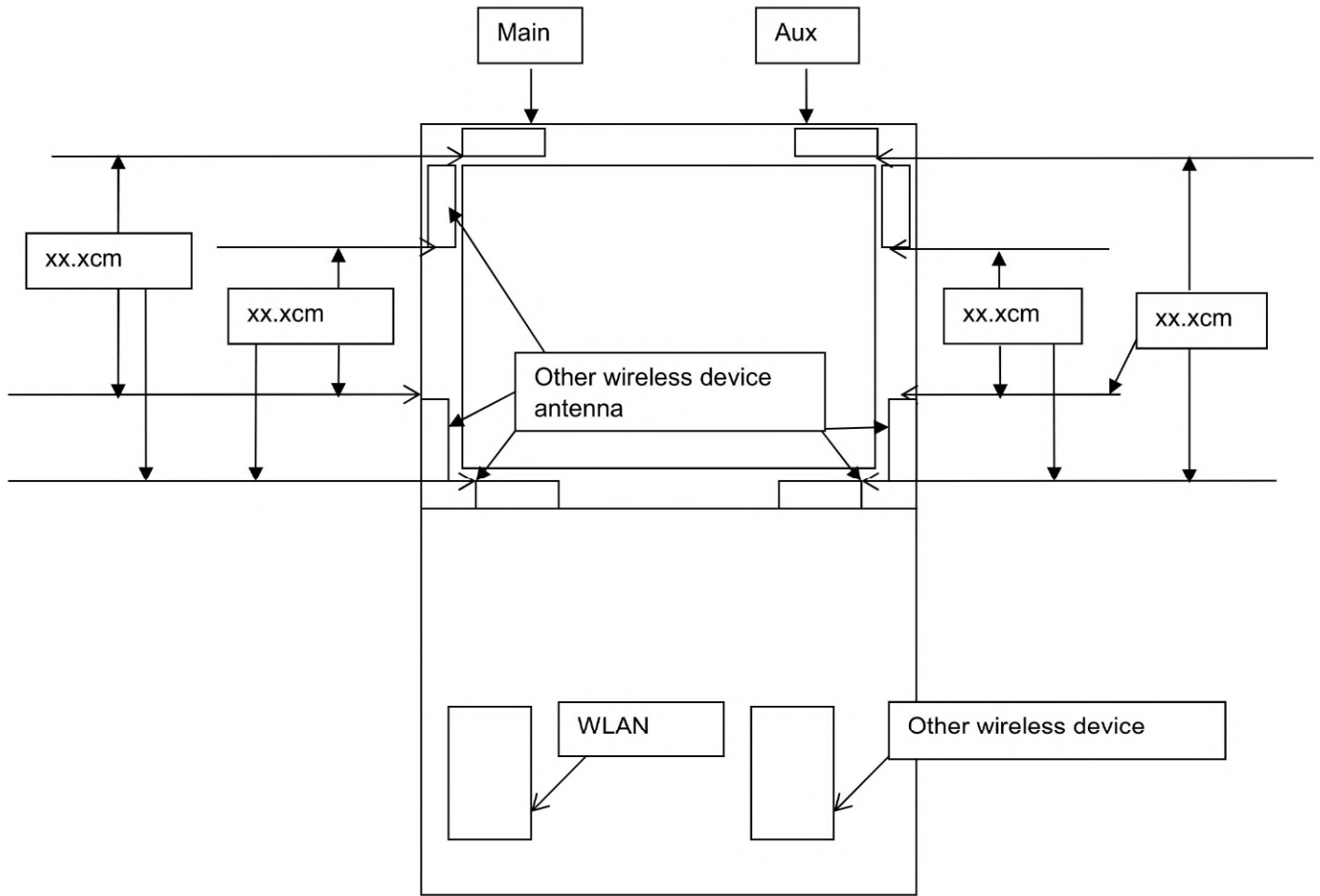

Revision History

Revision	Description	Date
10.3	Page2-5 Add Applicable test method, Test & System Description and Setup photo	July 24, 2022
10.4	Cover page Add Intel 5.9GHz reference antenna gain Cover page/Section1/Section3 Add 5.9GHz antenna gain information	September 15, 2022