

FCC Test Report

Report No.: RFBEQF-WTW-P22100397-3

FCC ID: BEJNT-16T90R

Model No.: 16T90R, 16TD90R, 16TB90R, 16TG90R, 16T90R*
(* can be 0 to 9 or A to Z or blank denoting buyer request)

Received Date: 2022/10/19

Test Date: 2022/10/26 ~ 2022/11/22

Issued Date: 2022/12/7

Applicant: LG Electronics USA

Address: 111 Sylvan Avenue North Bulding Englewood Cliffs New Jerssy United States

Issued By: Bureau Veritas Consumer Products Services (H.K.) Ltd., Taoyuan Branch
Lin Kou Laboratories

Lab Address: No. 47-2, 14th Ling, Chia Pau Vil., Lin Kou Dist., New Taipei City, Taiwan

Test Location: No. 19, Hwa Ya 2nd Rd., Wen Hwa Vil., Kewi Shan Dist., Taoyuan City
33383, Taiwan

FCC Registration / Designation Number: 788550 / TW0003



This report is governed by, and incorporates by reference, the Conditions of Testing as posted at the date of issuance of this report at <http://www.bureauveritas.com/home/about-us/our-business/cps/about-us/terms-conditions/> and is intended for your exclusive use. Any copying or replication of this report to or for any other person or entity, or use of our name or trademark, is permitted only with our prior written permission. This report sets forth our findings solely with respect to the test samples identified herein. The results set forth in this report are not indicative or representative of the quality or characteristics of the lot from which a test sample was taken or any similar or identical product unless specifically and expressly noted. Our report includes all of the tests requested by you and the results thereof based upon the information that you provided to us. Measurement uncertainty is only provided upon request for accredited tests. Statements of conformity are based on simple acceptance criteria without taking measurement uncertainty into account, unless otherwise requested in writing. You have 60 days from date of issuance of this report to notify us of any material error or omission caused by our negligence or if you require measurement uncertainty; provided, however, that such notice shall be in writing and shall specifically address the issue you wish to raise. A failure to raise such issue within the prescribed time shall constitute your unqualified acceptance of the completeness of this report, the tests conducted and the correctness of the report contents.

Table of Contents

Release Control Record	4
1 Certificate of Conformity	5
2 Summary of Test Results	6
2.1 Measurement Uncertainty.....	6
2.2 Modification Record.....	6
3 General Information	7
3.1 General Description of EUT.....	7
3.2 Description of Test Modes.....	10
3.2.1 Test Mode Applicability and Tested Channel Detail.....	12
3.3 Duty Cycle of Test Signal.....	15
3.4 Description of Support Units.....	16
3.4.1 Configuration of System under Test.....	16
3.5 General Description of Applied Standards and References.....	16
4 Test Types and Results	17
4.1 Radiated Emission and Bandedge Measurement.....	17
4.1.1 Limits of Radiated Emission and Bandedge Measurement.....	17
4.1.2 Test Instruments.....	18
4.1.3 Test Procedures.....	20
4.1.4 Deviation from Test Standard.....	20
4.1.5 Test Setup.....	21
4.1.6 EUT Operating Conditions.....	22
4.1.7 Test Results.....	23
4.2 In-Band Emission (Mask) Measurement.....	65
4.2.1 Limits of In-Band Emission (Mask) Measurement.....	65
4.2.2 Test Setup.....	65
4.2.3 Test Instruments.....	65
4.2.4 Test Procedure.....	66
4.2.5 EUT Operating Condition.....	66
4.2.6 Test Results.....	67
4.3 Conducted Emission Measurement.....	81
4.3.1 Limits of Conducted Emission Measurement.....	81
4.3.2 Test Instruments.....	81
4.3.3 Test Procedures.....	82
4.3.4 Deviation from Test Standard.....	82
4.3.5 Test Setup.....	82
4.3.6 EUT Operating Conditions.....	82
4.3.7 Test Results.....	83
4.4 Transmit Power Measurement.....	85
4.4.1 Limits of Transmit Power Measurement.....	85
4.4.2 Test Setup.....	85
4.4.3 Test Instruments.....	85
4.4.4 Test Procedure.....	86
4.4.5 EUT Operating Conditions.....	86
4.4.6 Test Result.....	87
4.5 Emission Bandwidth Measurement.....	89
4.5.1 Test Setup.....	89
4.5.2 Test Instruments.....	89
4.5.3 Test Procedure.....	89
4.5.4 Test Result.....	90
4.6 Peak Power Spectral Density Measurement.....	102
4.6.1 Limits of Peak Power Spectral Density Measurement.....	102
4.6.2 Test Setup.....	102
4.6.3 Test Instruments.....	102

4.6.4	Test Procedures.....	102
4.6.5	Deviation from Test Standard	102
4.6.6	EUT Operating Conditions.....	102
4.6.7	Test Results	103
4.7	Contention Based Protocol Measurement	108
4.7.1	Limits of Contention Based Protocol Measurement	108
4.7.2	Test Setup.....	108
4.7.3	Test Instruments	108
4.7.4	Test Procedure	109
4.7.5	EUT Operating Condition	109
4.7.6	Test Results	110
4.8	Frequency Stability.....	122
4.8.1	Limits of Frequency Stability Measurement	122
4.8.2	Test Setup.....	122
4.8.3	Test Instruments	122
4.8.4	Test Procedure	122
4.8.5	Deviation from Test Standard	123
4.8.6	EUT Operating Condition	123
4.8.7	Test Results	123
4.9	Operational Restrictions for 6 GHz U-NII Devices	124
4.9.1	Limits of Operational Restrictions for 6 GHz U-NII Devices.....	124
4.9.2	Test Setup.....	124
4.9.3	Test Instruments	124
4.9.4	Test Procedure	124
4.9.5	Test Results	124
5	Pictures of Test Arrangements.....	125
	Annex A - Band Edge Measurement.....	126
	Appendix – Information of the Testing Laboratories	130

Release Control Record

Issue No.	Description	Date Issued
RFBEQF-WTW-P22100397-3	Original release.	2022/12/7

1 Certificate of Conformity

Product: Notebook Computer

Brand: LG

Model No.: 16T90R, 16TD90R, 16TB90R, 16TG90R, 16T90R*
(* can be 0 to 9 or A to Z or blank denoting buyer request)

Sample Status: Engineering sample

Applicant: LG Electronics USA

Test Date: 2022/10/26 ~ 2022/11/22

Standards: 47 CFR FCC Part 15, Subpart E (Section 15.407)
ANSI C63.10:2013

The above equipment has been tested by **Bureau Veritas Consumer Products Services (H.K.) Ltd., Taoyuan Branch**, and found compliance with the requirement of the above standards. The test record, data evaluation & Equipment Under Test (EUT) configurations represented herein are true and accurate accounts of the measurements of the sample's RF characteristics under the conditions specified in this report.

Prepared by : Celine Chou , **Date:** 2022/12/7
Celine Chou / Senior Specialist

Approved by : Jeremy Lin , **Date:** 2022/12/7
Jeremy Lin / Project Engineer

2 Summary of Test Results

47 CFR FCC Part 15, Subpart E (Section 15.407)			
FCC Clause	Test Item	Result	Remarks
15.407(b)(9)	AC Power Conducted Emissions	Pass	Meet the requirement of limit. Minimum passing margin is -4.17dB at 0.15000MHz.
15.407(b)(6)(9)	Radiated Emissions	Pass	Meet the requirement of limit. Minimum passing margin is -2.1dB at 7125.00MHz.
15.407(b)(7)	In-Band Emission (Mask)	Pass	Meet the requirement of limit.
15.407(a)(6)	Max Average Transmit Power	Pass	Meet the requirement of limit.
15.407(a)(10)	Emission Bandwidth Measurement	Pass	Meet the requirement of limit.
15.407(a)(6)	Peak Power Spectral Density	Pass	Meet the requirement of limit.
15.407 (d)(6)	Contention-based Protocol.	Pass	Meet the requirement of limit.
15.407(g)	Frequency Stability	Pass	Meet the requirement of limit.
15.407(a)(7)(8)	Dual Client- Proper Power Adjustment	N/A	Device associates with low power indoor AP only.
15.407(d)(5)	Operational restrictions for 6 GHz U-NII devices	Pass	Declaration by applicant
15.203	Antenna Requirement	Pass	Antenna connector is I-PEX not a standard connector.

Note: Determining compliance based on the results of the compliance measurement, not taking into account measurement instrumentation uncertainty.

2.1 Measurement Uncertainty

Where relevant, the following measurement uncertainty levels have been estimated for tests performed on the EUT as specified in CISPR 16-4-2:

Measurement	Specification	Expanded Uncertainty (k=2) (±)
AC Power Conducted Emissions	9 kHz ~ 30 MHz	2.79 dB
Unwanted Emissions below 1 GHz	9 kHz ~ 30 MHz	3.59 dB
	30 MHz ~ 1 GHz	3.60 dB
Unwanted Emissions above 1 GHz	1 GHz ~ 18 GHz	2.29 dB
	18 GHz ~ 40 GHz	2.29 dB

2.2 Modification Record

There were no modifications required for compliance.

3 General Information

3.1 General Description of EUT

Product	Notebook Computer
Brand	LG
Model No.	16T90R, 16TD90R, 16TB90R, 16TG90R, 16T90R* (* can be 0 to 9 or A to Z or blank denoting buyer request)
Status of EUT	Engineering sample
Power Supply Rating	7.74 Vdc (Battery) 5 Vdc / 9Vdc / 15Vdc / 20Vdc (Adapter)
Modulation Type	1024QAM, 256QAM, 64QAM, 16QAM, QPSK, BPSK for OFDMA
Modulation Technology	OFDMA
Transfer Rate	802.11ax: up to 2402Mbps
Operating Frequency	5945 ~ 6425MHz, 6425 ~ 6525MHz, 6525 ~ 6875MHz, 6875 ~ 7125MHz
Number of Channel	802.11ax (HE20): 59 802.11ax (HE40): 29 802.11ax (HE80): 14 802.11ax (HE160): 7
Output EIRP Power	5945 ~ 6425MHz: 27.608mW (EIRP: 16.97dBm / 49.774mW) 6425 ~ 6525MHz: 27.267mW (EIRP: 16.33dBm / 42.954mW) 6525 ~ 6875MHz: 27.360mW (EIRP: 16.34dBm / 43.053mW) 6875 ~ 7125MHz: 27.928mW (EIRP: 15.52dBm / 35.645mW)
Antenna Type	Refer to note
Antenna Connector	Refer to note
Accessory Device	Refer to note
Cable Supplied	NA

Note:

- The following models are provided to this EUT. The model 16T90R was chosen for final test.

Brand	Model No.	Difference
LG	16T90R	For marketing purpose
	16TD90R	
	16TB90R	
	16TG90R	
	16T90R* (* can be 0 to 9 or A to Z or blank denoting buyer request)	

2. The EUT uses following accessories.

Product	Brand	Model	Description
Battery	LG	LBV7227E	7.74 Vdc, 80 Wh Typ. 10336 mAh
Adapter	LG	LP65WFC20P-NJ	I/P: 100-240 Vac, 50-60 Hz, 1.6 A O/P: (PDO) 5.0 Vdc, 3.0 A, 15.0 W or 9.0 Vdc, 3.0 A, 27.0 W or 15.0 Vdc, 3.0 A, 45.0 W or 20 Vdc, 3.25 A, 65 W (PPS) 5.0-20.0 Vdc, 3.25 A, Max 65.0 W
Type-C to Type-C Cable	Luxshare	L1LUC020-CS-H	2m/20V 5A/USB2.0/Black
Module	Intel	AX211D2W	-

3. The EUT incorporates a MIMO function:

6GHz Band		
Modulation Mode	Tx & Rx configuration	
802.11ax (HE20)	2TX	2RX
802.11ax (HE40)	2TX	2RX
802.11ax (HE80)	2TX	2RX
802.11ax (HE160)	2TX	2RX

4. The antenna information is listed as below.

NB:

Ant. Type	Brand	Ant.	Model	Antenna Peak Gain (dBi)				Connector
				5925-6425 MHz	6425-6525 MHz	6525-6875 MHz	6875-7125 MHz	
PIFA	CHILISIN	Main	DQ600111500 (BTEA00111525GC1A01)	1.00	-1.63	-1.80	-1.85	I-PEX
		Aux.	DQ600111500 (BTEA00111525GC1A01)	1.34	1.83	1.83	0.80	
	Pulse	Main	DQ602119000 (TZ21190)	1.58	-1.33	-1.74	-1.79	I-PEX
		Aux.	DQ602119000 (TZ21190)	1.60	1.97	1.97	1.06	

Tablet:

Ant. Type	Brand	Ant.	Model	Antenna Peak Gain (dBi)				Connector
				5925-6425 MHz	6425-6525 MHz	6525-6875 MHz	6875-7125 MHz	
PIFA	CHILISIN	Main	DQ600111500 (BTEA00111525GC1A01)	-0.08	-0.49	-1.58	-1.63	I-PEX
		Aux.	DQ600111500 (BTEA00111525GC1A01)	2.06	1.27	0.84	0.60	
	Pulse	Main	DQ602119000 (TZ21190)	0.35	0.35	-1.49	-1.49	I-PEX
		Aux.	DQ602119000 (TZ21190)	2.56	1.65	1.03	0.88	

* The worst case (NB mode) with the largest antenna gain was chosen for radiated emission and conducted emission final test.

* The maximum antenna gain for each band were chosen for antenna port conducted final test.

* Detail antenna specification please refer to antenna datasheet and/or antenna measurement report.

5. The above EUT information is declared by manufacturer and for more detailed features description, please refer to the manufacturer's specifications or user's manual.

3.2 Description of Test Modes

For 5925 ~ 6425MHz (U-NII-5 Band)

24 channels are provided for 802.11a, 802.11ax (HE20):

Channel	Frequency	Channel	Frequency	Channel	Frequency	Channel	Frequency
1	5955 MHz	5	5975 MHz	9	5995 MHz	13	6015 MHz
17	6035 MHz	21	6055 MHz	25	6075 MHz	29	6095 MHz
33	6115 MHz	37	6135 MHz	41	6155 MHz	45	6175 MHz
49	6195 MHz	53	6215 MHz	57	6235 MHz	61	6255 MHz
65	6275 MHz	69	6295 MHz	73	6315 MHz	77	6335 MHz
81	6355 MHz	85	6375 MHz	89	6395 MHz	93	6415 MHz

12 channels are provided for 802.11ax (HE40):

Channel	Frequency	Channel	Frequency	Channel	Frequency	Channel	Frequency
3	5965 MHz	11	6005 MHz	19	6045 MHz	27	6085 MHz
35	6125 MHz	43	6165 MHz	51	6205 MHz	59	6245 MHz
67	6285 MHz	75	6325 MHz	83	6365 MHz	91	6405 MHz

6 channel is provided for 802.11ax (HE80):

Channel	Frequency	Channel	Frequency	Channel	Frequency	Channel	Frequency
7	5985 MHz	23	6065 MHz	39	6145 MHz	55	6225 MHz
71	6305 MHz	87	6385 MHz				

3 channels are provided for 802.11ax (HE160):

Channel	Frequency	Channel	Frequency	Channel	Frequency
15	6025 MHz	47	6185 MHz	79	6345 MHz

For 6425 ~ 6525MHz (U-NII-6 Band)

5 channels are provided for 802.11a, 802.11ax (HE20):

Channel	Frequency	Channel	Frequency	Channel	Frequency	Channel	Frequency
97	6435 MHz	101	6455 MHz	105	6475 MHz	109	6495 MHz
113	6515 MHz						

3 channels are provided for 802.11ax (HE40):

Channel	Frequency	Channel	Frequency	Channel	Frequency
99	6445 MHz	107	6485 MHz	*115	6525 MHz

2 channel are provided for 802.11ax (HE80):

Channel	Frequency	Channel	Frequency
103	6465 MHz	*119	6545 MHz

1 channel is provided for 802.11ax (HE160):

Channel	Frequency
*111	6505 MHz

For 6525 ~ 6875MHz (U-NII-7 Band)

18 channels are provided for 802.11a, 802.11ax (HE20):

Channel	Frequency	Channel	Frequency	Channel	Frequency	Channel	Frequency
117	6535 MHz	121	6555 MHz	125	6575 MHz	129	6595 MHz
133	6615 MHz	137	6635 MHz	141	6655 MHz	145	6675 MHz
149	6695 MHz	153	6715 MHz	157	6735 MHz	161	6755 MHz
165	6775 MHz	169	6795 MHz	173	6815 MHz	177	6835 MHz
181	6855 MHz	*185	6875 MHz				

9 channels are provided for 802.11ax (HE40):

Channel	Frequency	Channel	Frequency	Channel	Frequency	Channel	Frequency
123	6565 MHz	131	6605 MHz	139	6645 MHz	147	6685 MHz
155	6725 MHz	163	6765 MHz	171	6805 MHz	179	6845 MHz
*187	6885 MHz						

4 channels are provided for 802.11ax (HE80):

Channel	Frequency	Channel	Frequency	Channel	Frequency	Channel	Frequency
135	6625 MHz	151	6705 MHz	167	6785 MHz	*183	6865 MHz

2 channels are provided for 802.11ax (HE160):

Channel	Frequency	Channel	Frequency
143	6665 MHz	*175	6825 MHz

For 6875 ~ 7125MHz (U-NII-8 band):

12 channels are provided for 802.11a, 802.11ax (HE20):

Channel	Frequency	Channel	Frequency	Channel	Frequency	Channel	Frequency
189	6895 MHz	193	6915 MHz	197	6935 MHz	201	6955 MHz
205	6975 MHz	209	6995 MHz	213	7015 MHz	217	7035 MHz
221	7055 MHz	225	7075 MHz	229	7095 MHz	233	7115 MHz

5 channels are provided for 802.11ax (HE40):

Channel	Frequency	Channel	Frequency	Channel	Frequency
195	6925 MHz	203	6965 MHz	211	7005 MHz
219	7045 MHz	227	7085 MHz		

2 channel is provided for 802.11ax (HE80):

Channel	Frequency	Channel	Frequency
199	6945 MHz	215	7025 MHz

1 channel is provided for 802.11ax (HE160):

Channel	Frequency
207	6985 MHz

Note: * mean this's straddle channel.

3.2.1 Test Mode Applicability and Tested Channel Detail

EUT Configure Mode	Applicable to						Description
	RE≥1G	RE<1G	IBE	PLC	CBP	APCM	
-	√	√	√	√	√	√	-

Where **RE≥1G**: Radiated Emission above 1GHz **RE<1G**: Radiated Emission below 1GHz
PLC: Power Line Conducted Emission **APCM**: Antenna Port Conducted Measurement
IBE: In-Band Emission (MASK) **CBP**:Contention Based Protocol

Note: The EUT's antenna (PIFA) had been pre-tested on the positioned of NB mode and each 3 axis of Tablet Mode. The worst case was found when positioned on NB mode.

Radiated Emission Measurement (Above 1GHz):

- Pre-Scan has been conducted to determine the worst-case mode from all possible combinations between available modulations, data rates and antenna ports (if EUT with antenna diversity architecture).
- Following channel(s) was (were) selected for the final test as listed below.

Mode	Frequency Band (MHz)	Available Channel	Tested Channel	Modulation Technology	Modulation Type	Data Rate Parameter
802.11ax (HE20)	5945-6525	1 to 93	1, 45, 93	OFDMA	BPSK	MCS0
	6425-6525	97 to 113	97, 105, 113	OFDMA	BPSK	MCS0
	6525-6875	117 to 185	117, 149, 181, 185	OFDMA	BPSK	MCS0
	6875-7125	189 to 233	213, 233	OFDMA	BPSK	MCS0
802.11ax (HE40)	5945-6525	3 to 91	3, 43, 91	OFDMA	BPSK	MCS0
	6425-6525	99 to 115	99, 107, 115	OFDMA	BPSK	MCS0
	6525-6875	123 to 187	123, 155, 179, 187	OFDMA	BPSK	MCS0
	6875-7125	195 to 227	211, 227	OFDMA	BPSK	MCS0
802.11ax (HE80)	5945-6525	7 to 87	7, 39, 87	OFDMA	BPSK	MCS0
	6425-6525	103 to 119	103, 119	OFDMA	BPSK	MCS0
	6525-6875	135 to 183	151, 183	OFDMA	BPSK	MCS0
	6875-7125	199 to 215	199, 215	OFDMA	BPSK	MCS0
802.11ax (HE160)	5945-6525	15 to 79	15, 47, 79	OFDMA	BPSK	MCS0
	6425-6525	111	111	OFDMA	BPSK	MCS0
	6525-6875	143 to 175	143, 175	OFDMA	BPSK	MCS0
	6875-7125	207	207	OFDMA	BPSK	MCS0

Radiated Emission Measurement (Below 1GHz):

- Pre-Scan has been conducted to determine the worst-case mode from all possible combinations between available modulations, data rates and antenna ports (if EUT with antenna diversity architecture).
- Following channel(s) was (were) selected for the final test as listed below.

Mode	Frequency Band (MHz)	Available Channel	Tested Channel	Modulation Technology	Modulation Type	Data Rate Parameter
802.11ax (HE160)	5945-6525	15 to 79	207	OFDMA	BPSK	MCS0
	6425-6525	111		OFDMA	BPSK	MCS0
	6525-6875	143 to 175		OFDMA	BPSK	MCS0
	6875-7125	207		OFDMA	BPSK	MCS0

In-Band Emission (MASK) Measurement:

Mode	Frequency Band (MHz)	Available Channel	Tested Channel	Modulation Technology	Modulation Type	Data Rate Parameter
802.11ax (HE20)	5945-6525	1 to 93	1, 45, 93	OFDMA	BPSK	MCS0
	6425-6525	97 to 113	97, 105, 113	OFDMA	BPSK	MCS0
	6525-6875	117 to 185	117, 149, 181, 185	OFDMA	BPSK	MCS0
	6875-7125	189 to 233	213, 233	OFDMA	BPSK	MCS0
802.11ax (HE40)	5945-6525	3 to 91	3, 43, 91	OFDMA	BPSK	MCS0
	6425-6525	99 to 115	99, 107, 115	OFDMA	BPSK	MCS0
	6525-6875	123 to 187	123, 155, 179, 187	OFDMA	BPSK	MCS0
	6875-7125	195 to 227	211, 227	OFDMA	BPSK	MCS0
802.11ax (HE80)	5945-6525	7 to 87	7, 39, 87	OFDMA	BPSK	MCS0
	6425-6525	103 to 119	103, 119	OFDMA	BPSK	MCS0
	6525-6875	135 to 183	151, 183	OFDMA	BPSK	MCS0
	6875-7125	199 to 215	199, 215	OFDMA	BPSK	MCS0
802.11ax (HE160)	5945-6525	15 to 79	15, 47, 79	OFDMA	BPSK	MCS0
	6425-6525	111	111	OFDMA	BPSK	MCS0
	6525-6875	143 to 175	143, 175	OFDMA	BPSK	MCS0
	6875-7125	207	207	OFDMA	BPSK	MCS0

Power Line Conducted Emission Measurement:

- Pre-Scan has been conducted to determine the worst-case mode from all possible combinations between available modulations, data rates and antenna ports (if EUT with antenna diversity architecture).
- Following channel(s) was (were) selected for the final test as listed below.

Mode	Frequency Band (MHz)	Available Channel	Tested Channel	Modulation Technology	Modulation Type	Data Rate Parameter
802.11ax (HE160)	5945-6525	15 to 79	207	OFDMA	BPSK	MCS0
	6425-6525	111		OFDMA	BPSK	MCS0
	6525-6875	143 to 175		OFDMA	BPSK	MCS0
	6875-7125	207		OFDMA	BPSK	MCS0

Antenna Port Conducted Measurement:

- This item includes all test value of each mode, but only includes spectrum plot of worst value of each mode.
- Pre-Scan has been conducted to determine the worst-case mode from all possible combinations between available modulations, data rates and antenna ports (if EUT with antenna diversity architecture).
- Following channel(s) was (were) selected for the final test as listed below.

Mode	Frequency Band (MHz)	Available Channel	Tested Channel	Modulation Technology	Modulation Type	Data Rate Parameter
802.11ax (HE20)	5945-6525	1 to 93	1, 45, 93	OFDMA	BPSK	MCS0
	6425-6525	97 to 113	97, 105, 113	OFDMA	BPSK	MCS0
	6525-6875	117 to 185	117, 149, 181, 185	OFDMA	BPSK	MCS0
	6875-7125	189 to 233	213, 233	OFDMA	BPSK	MCS0
802.11ax (HE40)	5945-6525	3 to 91	3, 43, 91	OFDMA	BPSK	MCS0
	6425-6525	99 to 115	99, 107, 115	OFDMA	BPSK	MCS0
	6525-6875	123 to 187	123, 155, 179, 187	OFDMA	BPSK	MCS0
	6875-7125	195 to 227	211, 227	OFDMA	BPSK	MCS0
802.11ax (HE80)	5945-6525	7 to 87	7, 39, 87	OFDMA	BPSK	MCS0
	6425-6525	103 to 119	103, 119	OFDMA	BPSK	MCS0
	6525-6875	135 to 183	151, 183	OFDMA	BPSK	MCS0
	6875-7125	199 to 215	199, 215	OFDMA	BPSK	MCS0
802.11ax (HE160)	5945-6525	15 to 79	15, 47, 79	OFDMA	BPSK	MCS0
	6425-6525	111	111	OFDMA	BPSK	MCS0
	6525-6875	143 to 175	143, 175	OFDMA	BPSK	MCS0
	6875-7125	207	207	OFDMA	BPSK	MCS0

Contention Based Protocol Measurement:

- Pre-Scan has been conducted to determine the worst-case mode from all possible combinations between available modulations, data rates and antenna ports (if EUT with antenna diversity architecture).
- Following channel(s) was (were) selected for the final test as listed below.

Mode	Frequency Band (MHz)	Available Channel	Tested Channel	Modulation Technology	Modulation Type	Data Rate Parameter
802.11ax (HE20)	5945-6525	1 to 93	45	OFDMA	BPSK	MCS0
	6425-6525	97 to 113	105	OFDMA	BPSK	MCS0
	6525-6875	117 to 185	149	OFDMA	BPSK	MCS0
	6875-7125	189 to 233	209	OFDMA	BPSK	MCS0
802.11ax (HE160)	5945-6525	15 to 79	47	OFDMA	BPSK	MCS0
	6425-6525	111	111	OFDMA	BPSK	MCS0
	6525-6875	143 to 175	143	OFDMA	BPSK	MCS0
	6875-7125	207	207	OFDMA	BPSK	MCS0

Test Condition:

Applicable to	Environmental Conditions	Input Power	Tested by
RE \geq 1G	23 deg. C, 67% RH	120Vac, 60Hz	Adair Peng
RE<1G	24 deg. C, 73% RH	120Vac, 60Hz	Adair Peng
PLC	25 deg. C, 75% RH	120Vac, 60Hz	Rex Wang
APCM	25 deg. C, 60% RH	120Vac, 60Hz	Gary Lin

3.3 Duty Cycle of Test Signal

802.11ax (HE20), 802.11ax (HE40), 802.11ax (HE160): Duty cycle of test signal is $\geq 98\%$, duty factor is not required.

802.11ax (HE80): Duty cycle of test signal is 100%, duty factor is not required.

802.11ax (HE20): Duty cycle = $2.095/2.130 = 0.984$

802.11ax (HE40): Duty cycle = $7.920/7.940 = 0.997$

802.11ax (HE160): Duty cycle = $4.520/4.540 = 0.996$

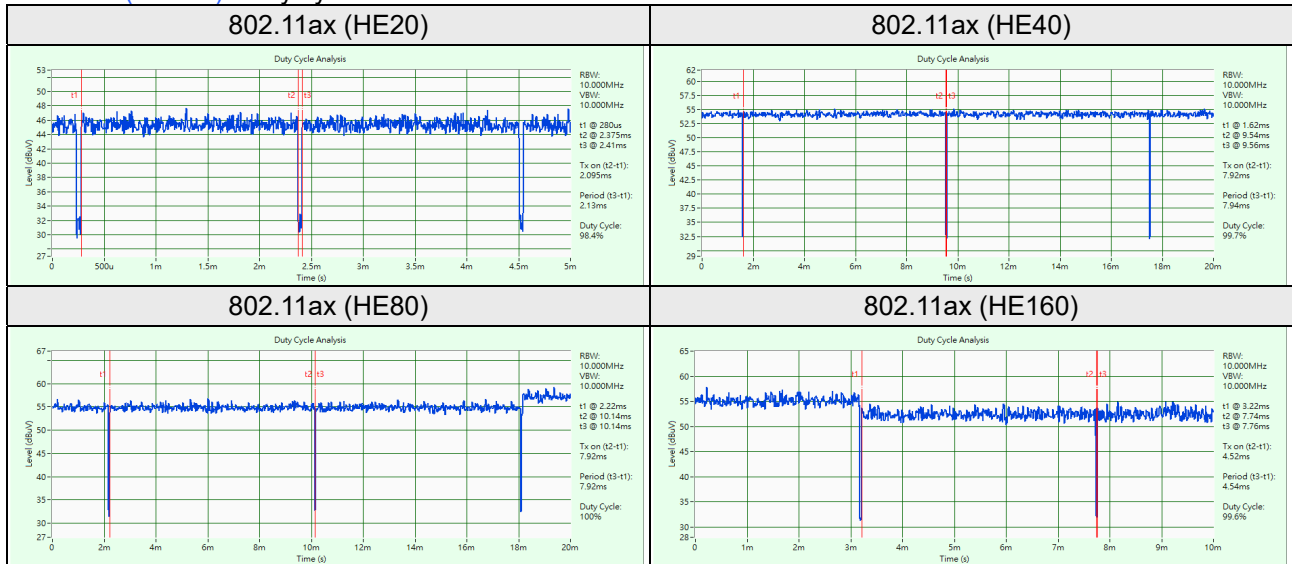

3.4 Description of Support Units

The EUT has been tested as an independent unit together with other necessary accessories or support units. The following support units or accessories were used to form a representative test configuration during the tests.

ID	Product	Brand	Model No.	Serial No.	FCC ID	Remarks
A	Earphone	APPLE	MB77PFEB	N/A	N/A	Provided by Lab
B	USB Flash	Sandisk	SDDDC3-032G	N/A	N/A	Provided by Lab
C	USB Flash	Sandisk	SDDDC3-032G	N/A	N/A	Provided by Lab

ID	Cable Descriptions	Qty.	Length (m)	Shielding (Yes/No)	Cores (Qty.)	Remarks
1	Earphone	1	1.8	N	0	Provided by Lab
2	Type-C to Type-C Cable	1	2.0	Y	0	Accessory of EUT

3.4.1 Configuration of System under Test

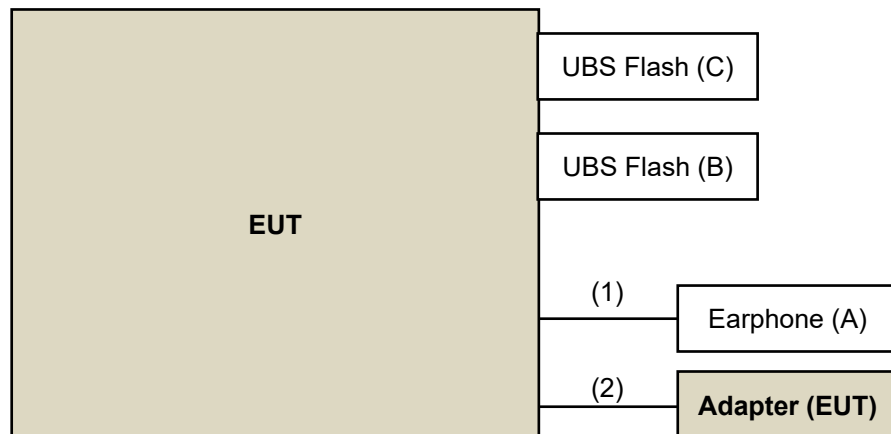

3.5 General Description of Applied Standards and References

The EUT is a RF Product. According to the specifications of the manufacturer, it must comply with the requirements of the following standards and references:

Test standard:

FCC Part 15, Subpart E (15.407)

ANSI C63.10:2013

All test items have been performed and recorded as per the above standards.

References Test Guidance:

KDB 987594 D02 EMC Measurement v01r01

KDB 789033 D02 General UNII Test Procedure New Rules v02r01

KDB 662911 D01 Multiple Transmitter Output v02r01

All test items have been performed as a reference to the above KDB test guidance.

4 Test Types and Results

4.1 Radiated Emission and Bandedge Measurement

4.1.1 Limits of Radiated Emission and Bandedge Measurement

Radiated emissions which fall in the restricted bands must comply with the radiated emission limits specified as below table.

Frequencies (MHz)	Field Strength (microvolts/meter)	Measurement Distance (meters)
0.009 ~ 0.490	2400/F(kHz)	300
0.490 ~ 1.705	24000/F(kHz)	30
1.705 ~ 30.0	30	30
30 ~ 88	100	3
88 ~ 216	150	3
216 ~ 960	200	3
Above 960	500	3

Note:

1. The lower limit shall apply at the transition frequencies.
2. Emission level (dBuV/m) = 20 log Emission level (uV/m).
3. For frequencies above 1000MHz, the field strength limits are based on average detector, however, the peak field strength of any emission shall not exceed the maximum permitted average limits, specified above by more than 20dB under any condition of modulation.

Limits of unwanted emission out of the restricted bands

Frequencies (MHz)	EIRP Limit	Equivalent Field Strength at 3m
5925MHz > F > 7125MHz	Peak:-7 (dBm/MHz)	88.2(dBμV/m)
	Average: -27 (dBm/MHz)	68.2(dBμV/m)

Note: The following formula is used to convert the equipment isotropic radiated power (eirp) to field strength:

$$E = \frac{1000000\sqrt{30P}}{3} \mu\text{V/m, where P is the eirp (Watts).}$$

4.1.2 Test Instruments

Unwanted Emissions below 1 GHz

Description Manufacturer	Model No.	Serial No.	Calibrated Date	Calibrated Until
Antenna Tower & Turn BV ADT	AT100	AT93021705	N/A	N/A
Bi_Log Antenna Schwarbeck	VULB9168	9168-160	2022/10/20	2023/10/19
Loop Antenna EMCI	EM-6879	269	2022/9/19	2023/9/18
Loop Antenna TESEQ	HLA 6121	45745	2022/7/27	2023/7/26
Pre-amplifier EMCI	EMC001340	980201	2022/9/23	2023/9/22
Preamplifier Agilent	8447D	2944A10638	2022/5/14	2023/5/13
RF Coaxial Cable EMCI	5D-NM-BM	140903+140902	2022/1/15	2023/1/14
RF Coaxial Cable WOKEN	8D-FB	Cable-CH9-01	2022/5/14	2023/5/13
Software BV ADT	ADT_Radiated_ V7.6.15.9.5	N/A	N/A	N/A
Spectrum Analyzer R&S	FSW43	101867	2022/1/7	2023/1/6
Test Receiver KEYSIGHT	N9038A	MY55420137	2022/4/27	2023/4/26
Turn Table BV ADT	TT100	TT93021705	N/A	N/A
Turn Table Controller BV ADT	SC100	SC93021705	N/A	N/A

Notes:

1. The test was performed in HY - 966 chamber 4.
2. Tested Date: 2022/10/28

Unwanted Emissions above 1 GHz

Description Manufacturer	Model No.	Serial No.	Calibrated Date	Calibrated Until
Antenna Tower & Turn BV ADT	AT100	AT93021705	N/A	N/A
Boresight antenna tower fixture BV	BAF-02	5	N/A	N/A
Horn Antenna Schwarzbeck	9120D	9120D-1169	2021/11/14	2022/11/13
	BBHA 9170	9170-480	2021/11/14	2022/11/13
		BBHA9170241	2021/10/26	2022/10/25
		BBHA9170243	2021/11/14	2022/11/13
Pre-Amplifier EMCI	EMC 184045	980116	2022/10/1	2023/9/30
Preamplifier Agilent	8449B	3008A02367	2022/2/16	2023/2/15
RF Coaxial Cable EMCI	EMC102-KM-KM-600	150928	2022/7/9	2023/7/8
	EMC102-KM-KM-3000	150929	2022/7/9	2023/7/8
RF Coaxial Cable HUBER+SUHNER	SUCOFLEX 104	CABLE-CH9-(250795/4)	2022/1/15	2023/1/14
RF Coaxial Cable HUBER+SUHNER&EMCI	SUCOFLEX 104& EMC104-SM-SM8000	CABLE-CH9-02 (248780+171006)	2022/1/15	2023/1/14
RF FILTER MICRO-TRONICS	BRM17690	004	2022/1/10	2023/1/9
	BRM50716	060	2022/1/10	2023/1/9
Software BV ADT	ADT_Radiated_ V7.6.15.9.5	N/A	N/A	N/A
Spectrum Analyzer R&S	FSW43	101867	2022/1/7	2023/1/6
Test Receiver KEYSIGHT	N9038A	MY55420137	2022/4/27	2023/4/26
Turn Table BV ADT	TT100	TT93021705	N/A	N/A
Turn Table Controller BV ADT	SC100	SC93021705	N/A	N/A

Notes:

1. The test was performed in HY - 966 chamber 4.
2. Tested Date: 2022/10/26 ~ 2022/10/28

4.1.3 Test Procedures

For Radiated emission below 30MHz

- a. The EUT was placed on the top of a rotating table 0.8 meters above the ground at a 3 meter chamber room. The table was rotated 360 degrees to determine the position of the highest radiation.
- b. The EUT was set 3 meters away from the interference-receiving antenna, which was mounted on the top of a variable-height antenna tower.
- c. Parallel, perpendicular, and ground-parallel orientations of the antenna are set to make the measurement.
- d. For each suspected emission, the EUT was arranged to its worst case and the rotatable table was turned from 0 degrees to 360 degrees to find the maximum reading.
- e. The test-receiver system was set to Quasi-Peak Detect Function and Specified Bandwidth with Maximum Hold Mode.

Note:

1. The resolution bandwidth and video bandwidth of test receiver/spectrum analyzer is 9kHz at frequency below 30MHz.

For Radiated emission above 30MHz

- a. The EUT was placed on the top of a rotating table 0.8 meters (for 30MHz ~ 1GHz) / 1.5 meters (for above 1GHz) above the ground at 3 meter chamber room for test. The table was rotated 360 degrees to determine the position of the highest radiation.
- b. The EUT was set 3 meters away from the interference-receiving antenna, which was mounted on the top of a variable-height antenna tower.
- c. The height of antenna is varied from one meter to four meters above the ground to determine the maximum value of the field strength. Both horizontal and vertical polarizations of the antenna are set to make the measurement.
- d. For each suspected emission, the EUT was arranged to its worst case and then the antenna was tuned to heights from 1 meter to 4 meters and the rotatable table was turned from 0 degrees to 360 degrees to find the maximum reading.
- e. The test-receiver system was set to quasi-peak detect function and specified bandwidth with maximum hold mode when the test frequency is below 1 GHz.
- f. The test-receiver system was set to peak and average detect function and specified bandwidth with maximum hold mode when the test frequency is above 1 GHz. If the peak reading value also meets average limit, measurement with the average detector is unnecessary.

Note:

1. The resolution bandwidth and video bandwidth of test receiver/spectrum analyzer is 120kHz for Quasi-peak detection (QP) at frequency below 1GHz.
2. The resolution bandwidth of test receiver/spectrum analyzer is 1 MHz and the video bandwidth is 3 MHz for Peak detection (PK) at frequency above 1GHz.
3. The resolution bandwidth of test receiver/spectrum analyzer is 1MHz and the video bandwidth is $\geq 1/T$ (Duty cycle < 98%) or 10Hz (Duty cycle $\geq 98\%$) for Average detection (AV) at frequency above 1GHz. (RBW = 1MHz, VBW = 10Hz)
4. All modes of operation were investigated and the worst-case emissions are reported.

4.1.4 Deviation from Test Standard

No deviation.

4.1.5 Test Setup

For Radiated emission below 30MHz

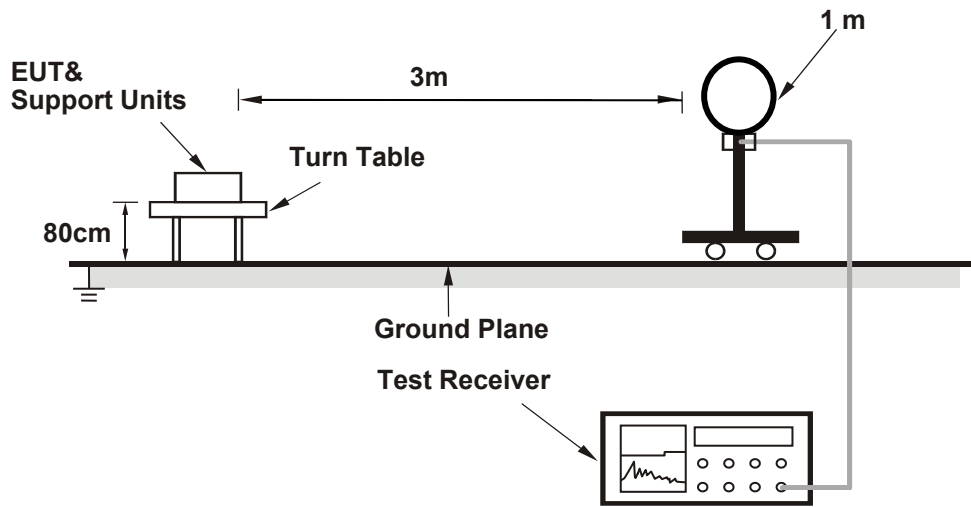

For Radiated emission 30MHz to 1GHz

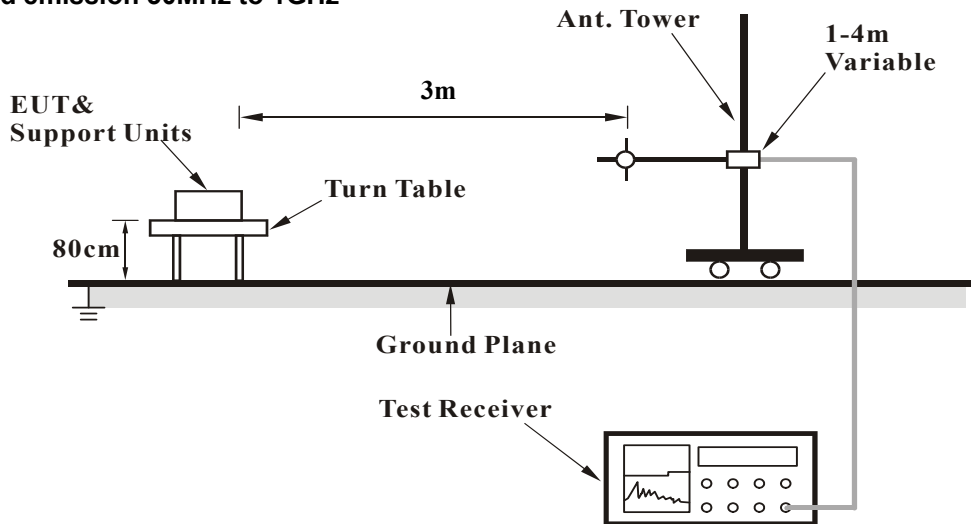

For Radiated emission above 1GHz

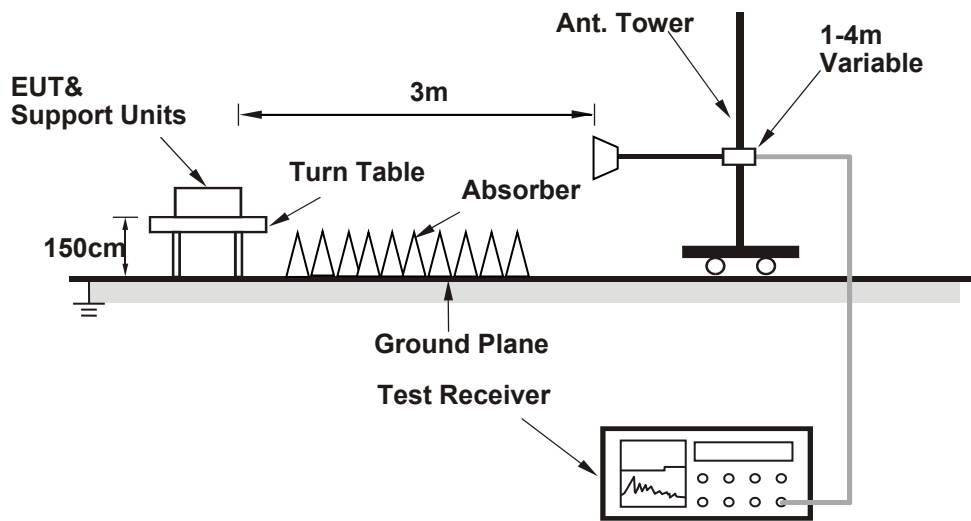

For the actual test configuration, please refer to the attached file (Test Setup Photo).

4.1.6 EUT Operating Conditions

- a. Set the EUT under transmission condition continuously at specific channel frequency.

4.1.7 Test Results

Above 1GHz data:

RF Mode	TX 802.11ax (HE20)	Channel	CH 1 : 5955 MHz
Frequency Range	1GHz ~ 40GHz	Detector Function	Peak (PK) Average (AV)

Antenna Polarity & Test Distance : Horizontal at 3 m								
No	Frequency (MHz)	Emission Level (dBuV/m)	Limit (dBuV/m)	Margin (dB)	Antenna Height (m)	Table Angle (Degree)	Raw Value (dBuV)	Correction Factor (dB/m)
1	#5925.00	57.7 PK	88.2	-30.5	2.81 H	89	50.6	7.1
2	#5925.00	44.2 AV	68.2	-24.0	2.81 H	89	37.1	7.1
3	*5955.00	100.3 PK			2.81 H	89	59.2	41.1
4	*5955.00	87.8 AV			2.81 H	89	46.7	41.1
5	11910.00	58.2 PK	74.0	-15.8	2.11 H	293	41.6	16.6
6	11910.00	45.0 AV	54.0	-9.0	2.11 H	293	28.4	16.6
Antenna Polarity & Test Distance : Vertical at 3 m								
No	Frequency (MHz)	Emission Level (dBuV/m)	Limit (dBuV/m)	Margin (dB)	Antenna Height (m)	Table Angle (Degree)	Raw Value (dBuV)	Correction Factor (dB/m)
1	#5925.00	57.5 PK	88.2	-30.7	1.23 V	321	50.4	7.1
2	#5925.00	44.1 AV	68.2	-24.1	1.23 V	321	37.0	7.1
3	*5955.00	99.2 PK			1.23 V	321	58.1	41.1
4	*5955.00	86.8 AV			1.23 V	321	45.7	41.1
5	11910.00	57.9 PK	74.0	-16.1	1.75 V	260	41.3	16.6
6	11910.00	44.8 AV	54.0	-9.2	1.75 V	260	28.2	16.6

Remarks:

1. Emission Level(dBuV/m) = Raw Value(dBuV) + Correction Factor(dB/m).
2. Correction Factor(dB/m) = Antenna Factor(dB/m) + Cable Factor(dB) – Pre-Amplifier Factor(dB).
3. Margin value = Emission Level – Limit value.
4. The other emission levels were very low against the limit.
5. " * " : Fundamental frequency.
6. " # " : The radiated frequency is out of the restricted band.

RF Mode	TX 802.11ax (HE20)	Channel	CH 45 : 6175 MHz
Frequency Range	1GHz ~ 40GHz	Detector Function	Peak (PK) Average (AV)

Antenna Polarity & Test Distance : Horizontal at 3 m								
No	Frequency (MHz)	Emission Level (dBuV/m)	Limit (dBuV/m)	Margin (dB)	Antenna Height (m)	Table Angle (Degree)	Raw Value (dBuV)	Correction Factor (dB/m)
1	*6175.00	101.0 PK			2.87 H	92	59.0	42.0
2	*6175.00	88.5 AV			2.87 H	92	46.5	42.0
3	12350.00	57.8 PK	74.0	-16.2	2.13 H	289	41.1	16.7
4	12350.00	44.9 AV	54.0	-9.1	2.13 H	289	28.2	16.7
Antenna Polarity & Test Distance : Vertical at 3 m								
No	Frequency (MHz)	Emission Level (dBuV/m)	Limit (dBuV/m)	Margin (dB)	Antenna Height (m)	Table Angle (Degree)	Raw Value (dBuV)	Correction Factor (dB/m)
1	*6175.00	99.5 PK			1.12 V	336	57.5	42.0
2	*6175.00	87.4 AV			1.12 V	336	45.4	42.0
3	12350.00	57.6 PK	74.0	-16.4	1.64 V	254	40.9	16.7
4	12350.00	44.7 AV	54.0	-9.3	1.64 V	254	28.0	16.7

Remarks:

1. Emission Level(dBuV/m) = Raw Value(dBuV) + Correction Factor(dB/m).
2. Correction Factor(dB/m) = Antenna Factor(dB/m) + Cable Factor(dB) – Pre-Amplifier Factor(dB).
3. Margin value = Emission Level – Limit value.
4. The other emission levels were very low against the limit.
5. " * " : Fundamental frequency.

RF Mode	TX 802.11ax (HE20)	Channel	CH 93 : 6415 MHz
Frequency Range	1GHz ~ 40GHz	Detector Function	Peak (PK) Average (AV)

Antenna Polarity & Test Distance : Horizontal at 3 m								
No	Frequency (MHz)	Emission Level (dBuV/m)	Limit (dBuV/m)	Margin (dB)	Antenna Height (m)	Table Angle (Degree)	Raw Value (dBuV)	Correction Factor (dB/m)
1	*6415.00	101.0 PK			2.82 H	88	57.0	43.0
2	*6415.00	88.5 AV			2.82 H	88	44.5	43.0
3	#12830.00	59.0 PK	88.2	-29.2	2.03 H	299	41.3	17.7
4	#12830.00	45.9 AV	68.2	-22.3	2.03 H	299	28.2	17.7
Antenna Polarity & Test Distance : Vertical at 3 m								
No	Frequency (MHz)	Emission Level (dBuV/m)	Limit (dBuV/m)	Margin (dB)	Antenna Height (m)	Table Angle (Degree)	Raw Value (dBuV)	Correction Factor (dB/m)
1	*6415.00	100.1 PK			1.19 V	328	57.1	43.0
2	*6415.00	87.7 AV			1.19 V	328	44.7	43.0
3	#12830.00	58.7 PK	88.2	-29.5	1.72 V	251	41.0	17.7
4	#12830.00	45.6 AV	68.2	-22.6	1.72 V	251	27.9	17.7

Remarks:

1. Emission Level(dBuV/m) = Raw Value(dBuV) + Correction Factor(dB/m).
2. Correction Factor(dB/m) = Antenna Factor(dB/m) + Cable Factor(dB) – Pre-Amplifier Factor(dB).
3. Margin value = Emission Level – Limit value.
4. The other emission levels were very low against the limit.
5. " * " : Fundamental frequency.
6. " # " : The radiated frequency is out of the restricted band.

RF Mode	TX 802.11ax (HE20)	Channel	CH 97 : 6435 MHz
Frequency Range	1GHz ~ 40GHz	Detector Function	Peak (PK) Average (AV)

Antenna Polarity & Test Distance : Horizontal at 3 m								
No	Frequency (MHz)	Emission Level (dBuV/m)	Limit (dBuV/m)	Margin (dB)	Antenna Height (m)	Table Angle (Degree)	Raw Value (dBuV)	Correction Factor (dB/m)
1	*6435.00	95.8 PK			3.38 H	89	52.5	43.3
2	*6435.00	84.9 AV			3.38 H	89	41.6	43.3
3	#12870.00	58.3 PK	88.2	-29.9	2.05 H	292	40.6	17.7
4	#12870.00	44.8 AV	68.2	-23.4	2.05 H	292	27.1	17.7
Antenna Polarity & Test Distance : Vertical at 3 m								
No	Frequency (MHz)	Emission Level (dBuV/m)	Limit (dBuV/m)	Margin (dB)	Antenna Height (m)	Table Angle (Degree)	Raw Value (dBuV)	Correction Factor (dB/m)
1	*6435.00	94.6 PK			1.22 V	66	51.3	43.3
2	*6435.00	83.8 AV			1.22 V	66	40.5	43.3
3	#12870.00	58.1 PK	88.2	-30.1	1.79 V	255	40.4	17.7
4	#12870.00	44.5 AV	68.2	-23.7	1.79 V	255	26.8	17.7

Remarks:

1. Emission Level(dBuV/m) = Raw Value(dBuV) + Correction Factor(dB/m).
2. Correction Factor(dB/m) = Antenna Factor(dB/m) + Cable Factor(dB) – Pre-Amplifier Factor(dB).
3. Margin value = Emission Level – Limit value.
4. The other emission levels were very low against the limit.
5. " * " : Fundamental frequency.
6. " # " : The radiated frequency is out of the restricted band.

RF Mode	TX 802.11ax (HE20)	Channel	CH 105 : 6475 MHz
Frequency Range	1GHz ~ 40GHz	Detector Function	Peak (PK) Average (AV)

Antenna Polarity & Test Distance : Horizontal at 3 m								
No	Frequency (MHz)	Emission Level (dBuV/m)	Limit (dBuV/m)	Margin (dB)	Antenna Height (m)	Table Angle (Degree)	Raw Value (dBuV)	Correction Factor (dB/m)
1	*6475.00	95.7 PK			3.62 H	80	52.4	43.3
2	*6475.00	84.9 AV			3.62 H	80	41.6	43.3
3	#12950.00	58.3 PK	88.2	-29.9	2.00 H	295	40.3	18.0
4	#12950.00	45.1 AV	68.2	-23.1	2.00 H	295	27.1	18.0
Antenna Polarity & Test Distance : Vertical at 3 m								
No	Frequency (MHz)	Emission Level (dBuV/m)	Limit (dBuV/m)	Margin (dB)	Antenna Height (m)	Table Angle (Degree)	Raw Value (dBuV)	Correction Factor (dB/m)
1	*6475.00	94.7 PK			1.06 V	64	51.4	43.3
2	*6475.00	83.6 AV			1.06 V	64	40.3	43.3
3	#12950.00	57.9 PK	88.2	-30.3	1.82 V	256	39.9	18.0
4	#12950.00	44.9 AV	68.2	-23.3	1.82 V	256	26.9	18.0

Remarks:

1. Emission Level(dBuV/m) = Raw Value(dBuV) + Correction Factor(dB/m).
2. Correction Factor(dB/m) = Antenna Factor(dB/m) + Cable Factor(dB) – Pre-Amplifier Factor(dB).
3. Margin value = Emission Level – Limit value.
4. The other emission levels were very low against the limit.
5. " * " : Fundamental frequency.
6. " # " : The radiated frequency is out of the restricted band.

RF Mode	TX 802.11ax (HE20)	Channel	CH 113 : 6515 MHz
Frequency Range	1GHz ~ 40GHz	Detector Function	Peak (PK) Average (AV)

Antenna Polarity & Test Distance : Horizontal at 3 m								
No	Frequency (MHz)	Emission Level (dBuV/m)	Limit (dBuV/m)	Margin (dB)	Antenna Height (m)	Table Angle (Degree)	Raw Value (dBuV)	Correction Factor (dB/m)
1	*6515.00	95.8 PK			3.34 H	90	52.6	43.2
2	*6515.00	85.0 AV			3.34 H	90	41.8	43.2
3	#13030.00	58.6 PK	88.2	-29.6	2.04 H	288	40.5	18.1
4	#13030.00	45.1 AV	68.2	-23.1	2.04 H	288	27.0	18.1
Antenna Polarity & Test Distance : Vertical at 3 m								
No	Frequency (MHz)	Emission Level (dBuV/m)	Limit (dBuV/m)	Margin (dB)	Antenna Height (m)	Table Angle (Degree)	Raw Value (dBuV)	Correction Factor (dB/m)
1	*6515.00	94.7 PK			1.00 V	62	51.5	43.2
2	*6515.00	83.9 AV			1.00 V	62	40.7	43.2
3	#13030.00	58.4 PK	88.2	-29.8	1.77 V	256	40.3	18.1
4	#13030.00	44.8 AV	68.2	-23.4	1.77 V	256	26.7	18.1

Remarks:

1. Emission Level(dBuV/m) = Raw Value(dBuV) + Correction Factor(dB/m).
2. Correction Factor(dB/m) = Antenna Factor(dB/m) + Cable Factor(dB) – Pre-Amplifier Factor(dB).
3. Margin value = Emission Level – Limit value.
4. The other emission levels were very low against the limit.
5. " * " : Fundamental frequency.
6. " # " : The radiated frequency is out of the restricted band.

RF Mode	TX 802.11ax (HE20)	Channel	CH 117 : 6535 MHz
Frequency Range	1GHz ~ 40GHz	Detector Function	Peak (PK) Average (AV)

Antenna Polarity & Test Distance : Horizontal at 3 m								
No	Frequency (MHz)	Emission Level (dBuV/m)	Limit (dBuV/m)	Margin (dB)	Antenna Height (m)	Table Angle (Degree)	Raw Value (dBuV)	Correction Factor (dB/m)
1	*6535.00	99.9 PK			3.74 H	87	56.8	43.1
2	*6535.00	87.2 AV			3.74 H	87	44.1	43.1
3	#13070.00	58.6 PK	88.2	-29.6	2.20 H	291	40.5	18.1
4	#13070.00	45.5 AV	68.2	-22.7	2.20 H	291	27.4	18.1
Antenna Polarity & Test Distance : Vertical at 3 m								
No	Frequency (MHz)	Emission Level (dBuV/m)	Limit (dBuV/m)	Margin (dB)	Antenna Height (m)	Table Angle (Degree)	Raw Value (dBuV)	Correction Factor (dB/m)
1	*6535.00	98.9 PK			1.19 V	62	55.8	43.1
2	*6535.00	86.2 AV			1.19 V	62	43.1	43.1
3	#13070.00	58.4 PK	88.2	-29.8	1.88 V	252	40.3	18.1
4	#13070.00	45.3 AV	68.2	-22.9	1.88 V	252	27.2	18.1

Remarks:

1. Emission Level(dBuV/m) = Raw Value(dBuV) + Correction Factor(dB/m).
2. Correction Factor(dB/m) = Antenna Factor(dB/m) + Cable Factor(dB) – Pre-Amplifier Factor(dB).
3. Margin value = Emission Level – Limit value.
4. The other emission levels were very low against the limit.
5. " * " : Fundamental frequency.
6. " # " : The radiated frequency is out of the restricted band.

RF Mode	TX 802.11ax (HE20)	Channel	CH 149 : 6695 MHz
Frequency Range	1GHz ~ 40GHz	Detector Function	Peak (PK) Average (AV)

Antenna Polarity & Test Distance : Horizontal at 3 m								
No	Frequency (MHz)	Emission Level (dBuV/m)	Limit (dBuV/m)	Margin (dB)	Antenna Height (m)	Table Angle (Degree)	Raw Value (dBuV)	Correction Factor (dB/m)
1	*6695.00	100.2 PK			3.53 H	82	56.4	43.8
2	*6695.00	87.5 AV			3.53 H	82	43.7	43.8
3	13390.00	60.0 PK	74.0	-14.0	2.28 H	301	40.9	19.1
4	13390.00	46.8 AV	54.0	-7.2	2.28 H	301	27.7	19.1
Antenna Polarity & Test Distance : Vertical at 3 m								
No	Frequency (MHz)	Emission Level (dBuV/m)	Limit (dBuV/m)	Margin (dB)	Antenna Height (m)	Table Angle (Degree)	Raw Value (dBuV)	Correction Factor (dB/m)
1	*6695.00	99.1 PK			1.21 V	65	55.3	43.8
2	*6695.00	86.4 AV			1.21 V	65	42.6	43.8
3	13390.00	59.8 PK	74.0	-14.2	1.82 V	260	40.7	19.1
4	13390.00	46.6 AV	54.0	-7.4	1.82 V	260	27.5	19.1

Remarks:

1. Emission Level(dBuV/m) = Raw Value(dBuV) + Correction Factor(dB/m).
2. Correction Factor(dB/m) = Antenna Factor(dB/m) + Cable Factor(dB) – Pre-Amplifier Factor(dB).
3. Margin value = Emission Level – Limit value.
4. The other emission levels were very low against the limit.
5. " * " : Fundamental frequency.

RF Mode	TX 802.11ax (HE20)	Channel	CH 181 : 6855 MHz
Frequency Range	1GHz ~ 40GHz	Detector Function	Peak (PK) Average (AV)

Antenna Polarity & Test Distance : Horizontal at 3 m								
No	Frequency (MHz)	Emission Level (dBuV/m)	Limit (dBuV/m)	Margin (dB)	Antenna Height (m)	Table Angle (Degree)	Raw Value (dBuV)	Correction Factor (dB/m)
1	*6855.00	99.8 PK			3.26 H	81	55.5	44.3
2	*6855.00	87.1 AV			3.26 H	81	42.8	44.3
3	#13710.00	60.2 PK	88.2	-28.0	2.30 H	290	40.7	19.5
4	#13710.00	47.1 AV	68.2	-21.1	2.30 H	290	27.6	19.5
Antenna Polarity & Test Distance : Vertical at 3 m								
No	Frequency (MHz)	Emission Level (dBuV/m)	Limit (dBuV/m)	Margin (dB)	Antenna Height (m)	Table Angle (Degree)	Raw Value (dBuV)	Correction Factor (dB/m)
1	*6855.00	98.8 PK			1.14 V	63	54.5	44.3
2	*6855.00	86.1 AV			1.14 V	63	41.8	44.3
3	#13710.00	60.0 PK	88.2	-28.2	1.79 V	266	40.5	19.5
4	#13710.00	47.0 AV	68.2	-21.2	1.79 V	266	27.5	19.5

Remarks:

1. Emission Level(dBuV/m) = Raw Value(dBuV) + Correction Factor(dB/m).
2. Correction Factor(dB/m) = Antenna Factor(dB/m) + Cable Factor(dB) – Pre-Amplifier Factor(dB).
3. Margin value = Emission Level – Limit value.
4. The other emission levels were very low against the limit.
5. " * " : Fundamental frequency.
6. " # " : The radiated frequency is out of the restricted band.

RF Mode	TX 802.11ax (HE20)	Channel	CH 185 : 6875 MHz
Frequency Range	1GHz ~ 40GHz	Detector Function	Peak (PK) Average (AV)

Antenna Polarity & Test Distance : Horizontal at 3 m								
No	Frequency (MHz)	Emission Level (dBuV/m)	Limit (dBuV/m)	Margin (dB)	Antenna Height (m)	Table Angle (Degree)	Raw Value (dBuV)	Correction Factor (dB/m)
1	*6875.00	100.0 PK			3.85 H	83	55.9	44.1
2	*6875.00	86.9 AV			3.85 H	83	42.8	44.1
3	#13750.00	59.0 PK	88.2	-29.2	2.04 H	289	39.3	19.7
4	#13750.00	46.5 AV	68.2	-21.7	2.04 H	289	26.8	19.7
Antenna Polarity & Test Distance : Vertical at 3 m								
No	Frequency (MHz)	Emission Level (dBuV/m)	Limit (dBuV/m)	Margin (dB)	Antenna Height (m)	Table Angle (Degree)	Raw Value (dBuV)	Correction Factor (dB/m)
1	*6875.00	98.4 PK			1.21 V	66	54.3	44.1
2	*6875.00	85.7 AV			1.21 V	66	41.6	44.1
3	#13750.00	58.5 PK	88.2	-29.7	1.79 V	252	38.8	19.7
4	#13750.00	46.2 AV	68.2	-22.0	1.79 V	252	26.5	19.7

Remarks:

1. Emission Level(dBuV/m) = Raw Value(dBuV) + Correction Factor(dB/m).
2. Correction Factor(dB/m) = Antenna Factor(dB/m) + Cable Factor(dB) – Pre-Amplifier Factor(dB).
3. Margin value = Emission Level – Limit value.
4. The other emission levels were very low against the limit.
5. " * " : Fundamental frequency.
6. " # " : The radiated frequency is out of the restricted band.

RF Mode	TX 802.11ax (HE20)	Channel	CH 209 : 6995 MHz
Frequency Range	1GHz ~ 40GHz	Detector Function	Peak (PK) Average (AV)

Antenna Polarity & Test Distance : Horizontal at 3 m								
No	Frequency (MHz)	Emission Level (dBuV/m)	Limit (dBuV/m)	Margin (dB)	Antenna Height (m)	Table Angle (Degree)	Raw Value (dBuV)	Correction Factor (dB/m)
1	*6995.00	99.9 PK			2.99 H	77	55.3	44.6
2	*6995.00	87.2 AV			2.99 H	77	42.6	44.6
3	#13990.00	60.5 PK	88.2	-27.7	2.11 H	292	39.8	20.7
4	#13990.00	47.4 AV	68.2	-20.8	2.11 H	292	26.7	20.7
Antenna Polarity & Test Distance : Vertical at 3 m								
No	Frequency (MHz)	Emission Level (dBuV/m)	Limit (dBuV/m)	Margin (dB)	Antenna Height (m)	Table Angle (Degree)	Raw Value (dBuV)	Correction Factor (dB/m)
1	*6995.00	98.4 PK			1.22 V	66	53.8	44.6
2	*6995.00	86.5 AV			1.22 V	66	41.9	44.6
3	13390.00	58.6 PK	74.0	-15.4	1.90 V	259	39.5	19.1
4	13390.00	45.5 AV	54.0	-8.5	1.90 V	259	26.4	19.1

Remarks:

1. Emission Level(dBuV/m) = Raw Value(dBuV) + Correction Factor(dB/m).
2. Correction Factor(dB/m) = Antenna Factor(dB/m) + Cable Factor(dB) – Pre-Amplifier Factor(dB).
3. Margin value = Emission Level – Limit value.
4. The other emission levels were very low against the limit.
5. " * " : Fundamental frequency.
6. " # " : The radiated frequency is out of the restricted band.

RF Mode	TX 802.11ax (HE20)	Channel	CH 233 : 7115 MHz
Frequency Range	1GHz ~ 40GHz	Detector Function	Peak (PK) Average (AV)

Antenna Polarity & Test Distance : Horizontal at 3 m								
No	Frequency (MHz)	Emission Level (dBuV/m)	Limit (dBuV/m)	Margin (dB)	Antenna Height (m)	Table Angle (Degree)	Raw Value (dBuV)	Correction Factor (dB/m)
1	*7115.00	96.1 PK			2.74 H	91	50.4	45.7
2	*7115.00	84.0 AV			2.74 H	91	38.3	45.7
3	#7125.00	75.7 PK	88.2	-12.5	2.74 H	91	64.8	10.9
4	#7125.00	61.5 AV	68.2	-6.7	2.74 H	91	50.6	10.9
5	#14230.00	61.8 PK	88.2	-26.4	2.08 H	287	40.5	21.3
6	#14230.00	47.9 AV	68.2	-20.3	2.08 H	287	26.6	21.3

Antenna Polarity & Test Distance : Vertical at 3 m								
No	Frequency (MHz)	Emission Level (dBuV/m)	Limit (dBuV/m)	Margin (dB)	Antenna Height (m)	Table Angle (Degree)	Raw Value (dBuV)	Correction Factor (dB/m)
1	*7115.00	95.9 PK			1.24 V	69	50.2	45.7
2	*7115.00	83.8 AV			1.24 V	69	38.1	45.7
3	#7125.00	75.6 PK	88.2	-12.6	1.24 V	69	64.7	10.9
4	#7125.00	66.1 AV	68.2	-2.1	1.24 V	69	55.2	10.9
5	#14230.00	60.9 PK	88.2	-27.3	1.85 V	256	39.6	21.3
6	#14230.00	47.8 AV	68.2	-20.4	1.85 V	256	26.5	21.3

Remarks:

1. Emission Level(dBuV/m) = Raw Value(dBuV) + Correction Factor(dB/m).
2. Correction Factor(dB/m) = Antenna Factor(dB/m) + Cable Factor(dB) – Pre-Amplifier Factor(dB).
3. Margin value = Emission Level – Limit value.
4. The other emission levels were very low against the limit.
5. " * " : Fundamental frequency.
6. " # " : The radiated frequency is out of the restricted band.

RF Mode	TX 802.11ax (HE40)	Channel	CH 3 : 5965 MHz
Frequency Range	1GHz ~ 40GHz	Detector Function	Peak (PK) Average (AV)

Antenna Polarity & Test Distance : Horizontal at 3 m								
No	Frequency (MHz)	Emission Level (dBuV/m)	Limit (dBuV/m)	Margin (dB)	Antenna Height (m)	Table Angle (Degree)	Raw Value (dBuV)	Correction Factor (dB/m)
1	#5925.00	58.3 PK	88.2	-29.9	2.86 H	84	51.2	7.1
2	#5925.00	44.9 AV	68.2	-23.3	2.86 H	84	37.8	7.1
3	*5965.00	101.8 PK			2.86 H	84	60.6	41.2
4	*5965.00	88.6 AV			2.86 H	84	47.4	41.2
5	11930.00	58.3 PK	74.0	-15.7	2.14 H	282	41.6	16.7
6	11930.00	45.2 AV	54.0	-8.8	2.14 H	282	28.5	16.7

Antenna Polarity & Test Distance : Vertical at 3 m								
No	Frequency (MHz)	Emission Level (dBuV/m)	Limit (dBuV/m)	Margin (dB)	Antenna Height (m)	Table Angle (Degree)	Raw Value (dBuV)	Correction Factor (dB/m)
1	#5925.00	58.2 PK	88.2	-30.0	1.00 V	333	51.1	7.1
2	#5925.00	44.8 AV	68.2	-23.4	1.00 V	333	37.7	7.1
3	*5965.00	100.6 PK			1.00 V	333	59.4	41.2
4	*5965.00	87.4 AV			1.00 V	333	46.2	41.2
5	11930.00	58.2 PK	74.0	-15.8	1.71 V	260	41.5	16.7
6	11930.00	45.0 AV	54.0	-9.0	1.71 V	260	28.3	16.7

Remarks:

1. Emission Level(dBuV/m) = Raw Value(dBuV) + Correction Factor(dB/m).
2. Correction Factor(dB/m) = Antenna Factor(dB/m) + Cable Factor(dB) – Pre-Amplifier Factor(dB).
3. Margin value = Emission Level – Limit value.
4. The other emission levels were very low against the limit.
5. " * " : Fundamental frequency.
6. " # " : The radiated frequency is out of the restricted band.

RF Mode	TX 802.11ax (HE40)	Channel	CH 43 : 6165 MHz
Frequency Range	1GHz ~ 40GHz	Detector Function	Peak (PK) Average (AV)

Antenna Polarity & Test Distance : Horizontal at 3 m								
No	Frequency (MHz)	Emission Level (dBuV/m)	Limit (dBuV/m)	Margin (dB)	Antenna Height (m)	Table Angle (Degree)	Raw Value (dBuV)	Correction Factor (dB/m)
1	*6165.00	102.0 PK			2.80 H	86	60.0	42.0
2	*6165.00	88.8 AV			2.80 H	86	46.8	42.0
3	12330.00	58.5 PK	74.0	-15.5	2.21 H	291	41.8	16.7
4	12330.00	45.3 AV	54.0	-8.7	2.21 H	291	28.6	16.7
Antenna Polarity & Test Distance : Vertical at 3 m								
No	Frequency (MHz)	Emission Level (dBuV/m)	Limit (dBuV/m)	Margin (dB)	Antenna Height (m)	Table Angle (Degree)	Raw Value (dBuV)	Correction Factor (dB/m)
1	*6165.00	100.9 PK			1.11 V	336	58.9	42.0
2	*6165.00	87.9 AV			1.11 V	336	45.9	42.0
3	12330.00	58.3 PK	74.0	-15.7	1.77 V	258	41.6	16.7
4	12330.00	45.2 AV	54.0	-8.8	1.77 V	258	28.5	16.7

Remarks:

1. Emission Level(dBuV/m) = Raw Value(dBuV) + Correction Factor(dB/m).
2. Correction Factor(dB/m) = Antenna Factor(dB/m) + Cable Factor(dB) – Pre-Amplifier Factor(dB).
3. Margin value = Emission Level – Limit value.
4. The other emission levels were very low against the limit.
5. " * " : Fundamental frequency.

RF Mode	TX 802.11ax (HE40)	Channel	CH 91 : 6405 MHz
Frequency Range	1GHz ~ 40GHz	Detector Function	Peak (PK) Average (AV)

Antenna Polarity & Test Distance : Horizontal at 3 m								
No	Frequency (MHz)	Emission Level (dBuV/m)	Limit (dBuV/m)	Margin (dB)	Antenna Height (m)	Table Angle (Degree)	Raw Value (dBuV)	Correction Factor (dB/m)
1	*6405.00	101.5 PK			2.93 H	79	58.5	43.0
2	*6405.00	88.3 AV			2.93 H	79	45.3	43.0
3	#12810.00	59.5 PK	88.2	-28.7	2.03 H	297	41.8	17.7
4	#12810.00	46.4 AV	68.2	-21.8	2.03 H	297	28.7	17.7
Antenna Polarity & Test Distance : Vertical at 3 m								
No	Frequency (MHz)	Emission Level (dBuV/m)	Limit (dBuV/m)	Margin (dB)	Antenna Height (m)	Table Angle (Degree)	Raw Value (dBuV)	Correction Factor (dB/m)
1	*6405.00	100.6 PK			1.23 V	325	57.6	43.0
2	*6405.00	87.2 AV			1.23 V	325	44.2	43.0
3	#12810.00	59.1 PK	88.2	-29.1	1.67 V	257	41.4	17.7
4	#12810.00	46.2 AV	68.2	-22.0	1.67 V	257	28.5	17.7

Remarks:

1. Emission Level(dBuV/m) = Raw Value(dBuV) + Correction Factor(dB/m).
2. Correction Factor(dB/m) = Antenna Factor(dB/m) + Cable Factor(dB) – Pre-Amplifier Factor(dB).
3. Margin value = Emission Level – Limit value.
4. The other emission levels were very low against the limit.
5. " * " : Fundamental frequency.
6. " # " : The radiated frequency is out of the restricted band.

RF Mode	TX 802.11ax (HE40)	Channel	CH 99 : 6445 MHz
Frequency Range	1GHz ~ 40GHz	Detector Function	Peak (PK) Average (AV)

Antenna Polarity & Test Distance : Horizontal at 3 m								
No	Frequency (MHz)	Emission Level (dBuV/m)	Limit (dBuV/m)	Margin (dB)	Antenna Height (m)	Table Angle (Degree)	Raw Value (dBuV)	Correction Factor (dB/m)
1	*6445.00	99.8 PK			3.17 H	81	56.5	43.3
2	*6445.00	88.5 AV			3.17 H	81	45.2	43.3
3	#12890.00	58.4 PK	88.2	-29.8	2.21 H	294	40.6	17.8
4	#12890.00	45.1 AV	68.2	-23.1	2.21 H	294	27.3	17.8
Antenna Polarity & Test Distance : Vertical at 3 m								
No	Frequency (MHz)	Emission Level (dBuV/m)	Limit (dBuV/m)	Margin (dB)	Antenna Height (m)	Table Angle (Degree)	Raw Value (dBuV)	Correction Factor (dB/m)
1	*6445.00	98.7 PK			1.24 V	63	55.4	43.3
2	*6445.00	88.0 AV			1.24 V	63	44.7	43.3
3	#12890.00	58.2 PK	88.2	-30.0	1.76 V	250	40.4	17.8
4	#12890.00	44.7 AV	68.2	-23.5	1.76 V	250	26.9	17.8

Remarks:

1. Emission Level(dBuV/m) = Raw Value(dBuV) + Correction Factor(dB/m).
2. Correction Factor(dB/m) = Antenna Factor(dB/m) + Cable Factor(dB) – Pre-Amplifier Factor(dB).
3. Margin value = Emission Level – Limit value.
4. The other emission levels were very low against the limit.
5. " * " : Fundamental frequency.
6. " # " : The radiated frequency is out of the restricted band.

RF Mode	TX 802.11ax (HE40)	Channel	CH 107 : 6485 MHz
Frequency Range	1GHz ~ 40GHz	Detector Function	Peak (PK) Average (AV)

Antenna Polarity & Test Distance : Horizontal at 3 m								
No	Frequency (MHz)	Emission Level (dBuV/m)	Limit (dBuV/m)	Margin (dB)	Antenna Height (m)	Table Angle (Degree)	Raw Value (dBuV)	Correction Factor (dB/m)
1	*6485.00	99.7 PK			3.16 H	80	56.4	43.3
2	*6485.00	88.6 AV			3.16 H	80	45.3	43.3
3	#12970.00	58.5 PK	88.2	-29.7	2.27 H	289	40.5	18.0
4	#12970.00	45.4 AV	68.2	-22.8	2.27 H	289	27.4	18.0
Antenna Polarity & Test Distance : Vertical at 3 m								
No	Frequency (MHz)	Emission Level (dBuV/m)	Limit (dBuV/m)	Margin (dB)	Antenna Height (m)	Table Angle (Degree)	Raw Value (dBuV)	Correction Factor (dB/m)
1	*6485.00	98.4 PK			1.20 V	60	55.1	43.3
2	*6485.00	87.6 AV			1.20 V	60	44.3	43.3
3	#12970.00	58.2 PK	88.2	-30.0	1.79 V	255	40.2	18.0
4	#12970.00	45.0 AV	68.2	-23.2	1.79 V	255	27.0	18.0

Remarks:

1. Emission Level(dBuV/m) = Raw Value(dBuV) + Correction Factor(dB/m).
2. Correction Factor(dB/m) = Antenna Factor(dB/m) + Cable Factor(dB) – Pre-Amplifier Factor(dB).
3. Margin value = Emission Level – Limit value.
4. The other emission levels were very low against the limit.
5. " * " : Fundamental frequency.
6. " # " : The radiated frequency is out of the restricted band.

RF Mode	TX 802.11ax (HE40)	Channel	CH 115 : 6525 MHz
Frequency Range	1GHz ~ 40GHz	Detector Function	Peak (PK) Average (AV)

Antenna Polarity & Test Distance : Horizontal at 3 m								
No	Frequency (MHz)	Emission Level (dBuV/m)	Limit (dBuV/m)	Margin (dB)	Antenna Height (m)	Table Angle (Degree)	Raw Value (dBuV)	Correction Factor (dB/m)
1	*6525.00	99.8 PK			3.18 H	83	56.6	43.2
2	*6525.00	88.7 AV			3.18 H	83	45.5	43.2
3	#13050.00	58.6 PK	88.2	-29.6	2.03 H	293	40.6	18.0
4	#13050.00	45.3 AV	68.2	-22.9	2.03 H	293	27.3	18.0
Antenna Polarity & Test Distance : Vertical at 3 m								
No	Frequency (MHz)	Emission Level (dBuV/m)	Limit (dBuV/m)	Margin (dB)	Antenna Height (m)	Table Angle (Degree)	Raw Value (dBuV)	Correction Factor (dB/m)
1	*6525.00	98.4 PK			1.04 V	63	55.2	43.2
2	*6525.00	87.9 AV			1.04 V	63	44.7	43.2
3	#13050.00	58.3 PK	88.2	-29.9	1.72 V	259	40.3	18.0
4	#13050.00	45.0 AV	68.2	-23.2	1.72 V	259	27.0	18.0

Remarks:

1. Emission Level(dBuV/m) = Raw Value(dBuV) + Correction Factor(dB/m).
2. Correction Factor(dB/m) = Antenna Factor(dB/m) + Cable Factor(dB) – Pre-Amplifier Factor(dB).
3. Margin value = Emission Level – Limit value.
4. The other emission levels were very low against the limit.
5. " * " : Fundamental frequency.
6. " # " : The radiated frequency is out of the restricted band.

RF Mode	TX 802.11ax (HE40)	Channel	CH 123 : 6565 MHz
Frequency Range	1GHz ~ 40GHz	Detector Function	Peak (PK) Average (AV)

Antenna Polarity & Test Distance : Horizontal at 3 m								
No	Frequency (MHz)	Emission Level (dBuV/m)	Limit (dBuV/m)	Margin (dB)	Antenna Height (m)	Table Angle (Degree)	Raw Value (dBuV)	Correction Factor (dB/m)
1	*6565.00	101.2 PK			3.73 H	81	58.0	43.2
2	*6565.00	88.3 AV			3.73 H	81	45.1	43.2
3	#13130.00	58.3 PK	88.2	-29.9	2.37 H	287	40.2	18.1
4	#13130.00	45.4 AV	68.2	-22.8	2.37 H	287	27.3	18.1
Antenna Polarity & Test Distance : Vertical at 3 m								
No	Frequency (MHz)	Emission Level (dBuV/m)	Limit (dBuV/m)	Margin (dB)	Antenna Height (m)	Table Angle (Degree)	Raw Value (dBuV)	Correction Factor (dB/m)
1	*6565.00	100.0 PK			1.13 V	68	56.8	43.2
2	*6565.00	87.1 AV			1.13 V	68	43.9	43.2
3	#13130.00	58.1 PK	88.2	-30.1	1.80 V	267	40.0	18.1
4	#13130.00	45.2 AV	68.2	-23.0	1.80 V	267	27.1	18.1

Remarks:

1. Emission Level(dBuV/m) = Raw Value(dBuV) + Correction Factor(dB/m).
2. Correction Factor(dB/m) = Antenna Factor(dB/m) + Cable Factor(dB) – Pre-Amplifier Factor(dB).
3. Margin value = Emission Level – Limit value.
4. The other emission levels were very low against the limit.
5. " * " : Fundamental frequency.
6. " # " : The radiated frequency is out of the restricted band.

RF Mode	TX 802.11ax (HE40)	Channel	CH 155 : 6725 MHz
Frequency Range	1GHz ~ 40GHz	Detector Function	Peak (PK) Average (AV)

Antenna Polarity & Test Distance : Horizontal at 3 m								
No	Frequency (MHz)	Emission Level (dBuV/m)	Limit (dBuV/m)	Margin (dB)	Antenna Height (m)	Table Angle (Degree)	Raw Value (dBuV)	Correction Factor (dB/m)
1	*6725.00	100.7 PK			3.43 H	83	57.0	43.7
2	*6725.00	88.5 AV			3.43 H	83	44.8	43.7
3	#13450.00	59.5 PK	88.2	-28.7	2.42 H	297	40.2	19.3
4	#13450.00	45.8 AV	68.2	-22.4	2.42 H	297	26.5	19.3
Antenna Polarity & Test Distance : Vertical at 3 m								
No	Frequency (MHz)	Emission Level (dBuV/m)	Limit (dBuV/m)	Margin (dB)	Antenna Height (m)	Table Angle (Degree)	Raw Value (dBuV)	Correction Factor (dB/m)
1	*6725.00	99.6 PK			1.22 V	59	55.9	43.7
2	*6725.00	87.4 AV			1.22 V	59	43.7	43.7
3	#13450.00	59.3 PK	88.2	-28.9	1.91 V	259	40.0	19.3
4	#13450.00	45.6 AV	68.2	-22.6	1.91 V	259	26.3	19.3

Remarks:

1. Emission Level(dBuV/m) = Raw Value(dBuV) + Correction Factor(dB/m).
2. Correction Factor(dB/m) = Antenna Factor(dB/m) + Cable Factor(dB) – Pre-Amplifier Factor(dB).
3. Margin value = Emission Level – Limit value.
4. The other emission levels were very low against the limit.
5. " * " : Fundamental frequency.
6. " # " : The radiated frequency is out of the restricted band.

RF Mode	TX 802.11ax (HE40)	Channel	CH 179 : 6845 MHz
Frequency Range	1GHz ~ 40GHz	Detector Function	Peak (PK) Average (AV)

Antenna Polarity & Test Distance : Horizontal at 3 m								
No	Frequency (MHz)	Emission Level (dBuV/m)	Limit (dBuV/m)	Margin (dB)	Antenna Height (m)	Table Angle (Degree)	Raw Value (dBuV)	Correction Factor (dB/m)
1	*6845.00	100.6 PK			3.57 H	85	56.3	44.3
2	*6845.00	88.4 AV			3.57 H	85	44.1	44.3
3	#13690.00	60.0 PK	88.2	-28.2	2.33 H	287	40.5	19.5
4	#13690.00	46.1 AV	68.2	-22.1	2.33 H	287	26.6	19.5
Antenna Polarity & Test Distance : Vertical at 3 m								
No	Frequency (MHz)	Emission Level (dBuV/m)	Limit (dBuV/m)	Margin (dB)	Antenna Height (m)	Table Angle (Degree)	Raw Value (dBuV)	Correction Factor (dB/m)
1	*6845.00	99.4 PK			1.14 V	60	55.1	44.3
2	*6845.00	87.2 AV			1.14 V	60	42.9	44.3
3	#13690.00	59.7 PK	88.2	-28.5	1.79 V	263	40.2	19.5
4	#13690.00	45.8 AV	68.2	-22.4	1.79 V	263	26.3	19.5

Remarks:

1. Emission Level(dBuV/m) = Raw Value(dBuV) + Correction Factor(dB/m).
2. Correction Factor(dB/m) = Antenna Factor(dB/m) + Cable Factor(dB) – Pre-Amplifier Factor(dB).
3. Margin value = Emission Level – Limit value.
4. The other emission levels were very low against the limit.
5. " * " : Fundamental frequency.
6. " # " : The radiated frequency is out of the restricted band.

RF Mode	TX 802.11ax (HE40)	Channel	CH 187 : 6885 MHz
Frequency Range	1GHz ~ 40GHz	Detector Function	Peak (PK) Average (AV)

Antenna Polarity & Test Distance : Horizontal at 3 m								
No	Frequency (MHz)	Emission Level (dBuV/m)	Limit (dBuV/m)	Margin (dB)	Antenna Height (m)	Table Angle (Degree)	Raw Value (dBuV)	Correction Factor (dB/m)
1	*6885.00	99.6 PK			3.69 H	83	55.6	44.0
2	*6885.00	87.7 AV			3.69 H	83	43.7	44.0
3	#13770.00	60.3 PK	88.2	-27.9	2.12 H	290	40.5	19.8
4	#13770.00	46.8 AV	68.2	-21.4	2.12 H	290	27.0	19.8
Antenna Polarity & Test Distance : Vertical at 3 m								
No	Frequency (MHz)	Emission Level (dBuV/m)	Limit (dBuV/m)	Margin (dB)	Antenna Height (m)	Table Angle (Degree)	Raw Value (dBuV)	Correction Factor (dB/m)
1	*6885.00	98.4 PK			1.05 V	66	54.4	44.0
2	*6885.00	86.8 AV			1.05 V	66	42.8	44.0
3	#13770.00	60.0 PK	88.2	-28.2	1.91 V	263	40.2	19.8
4	#13770.00	46.6 AV	68.2	-21.6	1.91 V	263	26.8	19.8

Remarks:

1. Emission Level(dBuV/m) = Raw Value(dBuV) + Correction Factor(dB/m).
2. Correction Factor(dB/m) = Antenna Factor(dB/m) + Cable Factor(dB) – Pre-Amplifier Factor(dB).
3. Margin value = Emission Level – Limit value.
4. The other emission levels were very low against the limit.
5. " * " : Fundamental frequency.
6. " # " : The radiated frequency is out of the restricted band.

RF Mode	TX 802.11ax (HE40)	Channel	CH 211 : 7005 MHz
Frequency Range	1GHz ~ 40GHz	Detector Function	Peak (PK) Average (AV)

Antenna Polarity & Test Distance : Horizontal at 3 m								
No	Frequency (MHz)	Emission Level (dBuV/m)	Limit (dBuV/m)	Margin (dB)	Antenna Height (m)	Table Angle (Degree)	Raw Value (dBuV)	Correction Factor (dB/m)
1	*7005.00	100.1 PK			3.84 H	81	55.4	44.7
2	*7005.00	88.5 AV			3.84 H	81	43.8	44.7
3	#14010.00	61.4 PK	88.2	-26.8	2.14 H	289	40.6	20.8
4	#14010.00	47.7 AV	68.2	-20.5	2.14 H	289	26.9	20.8
Antenna Polarity & Test Distance : Vertical at 3 m								
No	Frequency (MHz)	Emission Level (dBuV/m)	Limit (dBuV/m)	Margin (dB)	Antenna Height (m)	Table Angle (Degree)	Raw Value (dBuV)	Correction Factor (dB/m)
1	*7005.00	99.0 PK			1.22 V	69	54.3	44.7
2	*7005.00	87.2 AV			1.22 V	69	42.5	44.7
3	#14010.00	60.5 PK	88.2	-27.7	1.88 V	256	39.7	20.8
4	#14010.00	47.4 AV	68.2	-20.8	1.88 V	256	26.6	20.8

Remarks:

1. Emission Level(dBuV/m) = Raw Value(dBuV) + Correction Factor(dB/m).
2. Correction Factor(dB/m) = Antenna Factor(dB/m) + Cable Factor(dB) – Pre-Amplifier Factor(dB).
3. Margin value = Emission Level – Limit value.
4. The other emission levels were very low against the limit.
5. " * " : Fundamental frequency.
6. " # " : The radiated frequency is out of the restricted band.

RF Mode	TX 802.11ax (HE40)	Channel	CH 227 : 7085 MHz
Frequency Range	1GHz ~ 40GHz	Detector Function	Peak (PK) Average (AV)

Antenna Polarity & Test Distance : Horizontal at 3 m								
No	Frequency (MHz)	Emission Level (dBuV/m)	Limit (dBuV/m)	Margin (dB)	Antenna Height (m)	Table Angle (Degree)	Raw Value (dBuV)	Correction Factor (dB/m)
1	*7085.00	101.3 PK			2.67 H	86	55.5	45.8
2	*7085.00	88.4 AV			2.67 H	86	42.6	45.8
3	#7125.00	62.2 PK	88.2	-26.0	2.67 H	86	51.3	10.9
4	#7125.00	48.7 AV	68.2	-19.5	2.67 H	86	37.8	10.9
5	#14170.00	61.9 PK	88.2	-26.3	2.09 H	293	40.6	21.3
6	#14170.00	48.6 AV	68.2	-19.6	2.09 H	293	27.3	21.3

Antenna Polarity & Test Distance : Vertical at 3 m								
No	Frequency (MHz)	Emission Level (dBuV/m)	Limit (dBuV/m)	Margin (dB)	Antenna Height (m)	Table Angle (Degree)	Raw Value (dBuV)	Correction Factor (dB/m)
1	*7085.00	100.6 PK			1.00 V	62	54.8	45.8
2	*7085.00	87.4 AV			1.00 V	62	41.6	45.8
3	#7125.00	61.2 PK	88.2	-27.0	1.00 V	62	50.3	10.9
4	#7125.00	48.6 AV	68.2	-19.6	1.00 V	62	37.7	10.9
5	#14170.00	61.1 PK	88.2	-27.1	1.86 V	257	39.8	21.3
6	#14170.00	48.2 AV	68.2	-20.0	1.86 V	257	26.9	21.3

Remarks:

1. Emission Level(dBuV/m) = Raw Value(dBuV) + Correction Factor(dB/m).
2. Correction Factor(dB/m) = Antenna Factor(dB/m) + Cable Factor(dB) – Pre-Amplifier Factor(dB).
3. Margin value = Emission Level – Limit value.
4. The other emission levels were very low against the limit.
5. " * " : Fundamental frequency.
6. " # " : The radiated frequency is out of the restricted band.

RF Mode	TX 802.11ax (HE80)	Channel	CH 7 : 5985 MHz
Frequency Range	1GHz ~ 40GHz	Detector Function	Peak (PK) Average (AV)

Antenna Polarity & Test Distance : Horizontal at 3 m								
No	Frequency (MHz)	Emission Level (dBuV/m)	Limit (dBuV/m)	Margin (dB)	Antenna Height (m)	Table Angle (Degree)	Raw Value (dBuV)	Correction Factor (dB/m)
1	#5925.00	58.5 PK	88.2	-29.7	2.82 H	82	51.4	7.1
2	#5925.00	46.3 AV	68.2	-21.9	2.82 H	82	39.2	7.1
3	*5985.00	101.6 PK			2.82 H	82	60.4	41.2
4	*5985.00	89.0 AV			2.82 H	82	47.8	41.2
5	11970.00	57.6 PK	74.0	-16.4	2.00 H	282	40.9	16.7
6	11970.00	45.3 AV	54.0	-8.7	2.00 H	282	28.6	16.7

Antenna Polarity & Test Distance : Vertical at 3 m								
No	Frequency (MHz)	Emission Level (dBuV/m)	Limit (dBuV/m)	Margin (dB)	Antenna Height (m)	Table Angle (Degree)	Raw Value (dBuV)	Correction Factor (dB/m)
1	#5925.00	58.4 PK	88.2	-29.8	1.07 V	335	51.3	7.1
2	#5925.00	46.1 AV	68.2	-22.1	1.07 V	335	39.0	7.1
3	*5985.00	100.2 PK			1.07 V	335	59.0	41.2
4	*5985.00	87.7 AV			1.07 V	335	46.5	41.2
5	11970.00	57.4 PK	74.0	-16.6	1.82 V	257	40.7	16.7
6	11970.00	45.0 AV	54.0	-9.0	1.82 V	257	28.3	16.7

Remarks:

1. Emission Level(dBuV/m) = Raw Value(dBuV) + Correction Factor(dB/m).
2. Correction Factor(dB/m) = Antenna Factor(dB/m) + Cable Factor(dB) – Pre-Amplifier Factor(dB).
3. Margin value = Emission Level – Limit value.
4. The other emission levels were very low against the limit.
5. " * " : Fundamental frequency.
6. " # " : The radiated frequency is out of the restricted band.

RF Mode	TX 802.11ax (HE80)	Channel	CH 39 : 6145 MHz
Frequency Range	1GHz ~ 40GHz	Detector Function	Peak (PK) Average (AV)

Antenna Polarity & Test Distance : Horizontal at 3 m								
No	Frequency (MHz)	Emission Level (dBuV/m)	Limit (dBuV/m)	Margin (dB)	Antenna Height (m)	Table Angle (Degree)	Raw Value (dBuV)	Correction Factor (dB/m)
1	*6145.00	101.5 PK			2.90 H	92	59.6	41.9
2	*6145.00	88.8 AV			2.90 H	92	46.9	41.9
3	12290.00	58.1 PK	74.0	-15.9	2.16 H	296	41.2	16.9
4	12290.00	45.6 AV	54.0	-8.4	2.16 H	296	28.7	16.9
Antenna Polarity & Test Distance : Vertical at 3 m								
No	Frequency (MHz)	Emission Level (dBuV/m)	Limit (dBuV/m)	Margin (dB)	Antenna Height (m)	Table Angle (Degree)	Raw Value (dBuV)	Correction Factor (dB/m)
1	*6145.00	100.3 PK			1.13 V	327	58.4	41.9
2	*6145.00	87.7 AV			1.13 V	327	45.8	41.9
3	12290.00	57.7 PK	74.0	-16.3	1.93 V	264	40.8	16.9
4	12290.00	45.2 AV	54.0	-8.8	1.93 V	264	28.3	16.9

Remarks:

1. Emission Level(dBuV/m) = Raw Value(dBuV) + Correction Factor(dB/m).
2. Correction Factor(dB/m) = Antenna Factor(dB/m) + Cable Factor(dB) – Pre-Amplifier Factor(dB).
3. Margin value = Emission Level – Limit value.
4. The other emission levels were very low against the limit.
5. " * " : Fundamental frequency.

RF Mode	TX 802.11ax (HE80)	Channel	CH 87 : 6385 MHz
Frequency Range	1GHz ~ 40GHz	Detector Function	Peak (PK) Average (AV)

Antenna Polarity & Test Distance : Horizontal at 3 m								
No	Frequency (MHz)	Emission Level (dBuV/m)	Limit (dBuV/m)	Margin (dB)	Antenna Height (m)	Table Angle (Degree)	Raw Value (dBuV)	Correction Factor (dB/m)
1	*6385.00	101.1 PK			2.75 H	87	58.3	42.8
2	*6385.00	88.4 AV			2.75 H	87	45.6	42.8
3	#12770.00	58.8 PK	88.2	-29.4	2.13 H	284	41.3	17.5
4	#12770.00	46.0 AV	68.2	-22.2	2.13 H	284	28.5	17.5
Antenna Polarity & Test Distance : Vertical at 3 m								
No	Frequency (MHz)	Emission Level (dBuV/m)	Limit (dBuV/m)	Margin (dB)	Antenna Height (m)	Table Angle (Degree)	Raw Value (dBuV)	Correction Factor (dB/m)
1	*6385.00	100.2 PK			1.20 V	323	57.4	42.8
2	*6385.00	87.6 AV			1.20 V	323	44.8	42.8
3	#12770.00	58.5 PK	88.2	-29.7	1.79 V	262	41.0	17.5
4	#12770.00	45.7 AV	68.2	-22.5	1.79 V	262	28.2	17.5

Remarks:

1. Emission Level(dBuV/m) = Raw Value(dBuV) + Correction Factor(dB/m).
2. Correction Factor(dB/m) = Antenna Factor(dB/m) + Cable Factor(dB) – Pre-Amplifier Factor(dB).
3. Margin value = Emission Level – Limit value.
4. The other emission levels were very low against the limit.
5. " * " : Fundamental frequency.
6. " # " : The radiated frequency is out of the restricted band.

RF Mode	TX 802.11ax (HE80)	Channel	CH 103 : 6465 MHz
Frequency Range	1GHz ~ 40GHz	Detector Function	Peak (PK) Average (AV)

Antenna Polarity & Test Distance : Horizontal at 3 m								
No	Frequency (MHz)	Emission Level (dBuV/m)	Limit (dBuV/m)	Margin (dB)	Antenna Height (m)	Table Angle (Degree)	Raw Value (dBuV)	Correction Factor (dB/m)
1	*6465.00	101.3 PK			3.16 H	85	57.9	43.4
2	*6465.00	88.6 AV			3.16 H	85	45.2	43.4
3	#12930.00	58.5 PK	88.2	-29.7	2.11 H	295	40.6	17.9
4	#12930.00	45.4 AV	68.2	-22.8	2.11 H	295	27.5	17.9
Antenna Polarity & Test Distance : Vertical at 3 m								
No	Frequency (MHz)	Emission Level (dBuV/m)	Limit (dBuV/m)	Margin (dB)	Antenna Height (m)	Table Angle (Degree)	Raw Value (dBuV)	Correction Factor (dB/m)
1	*6465.00	99.9 PK			1.24 V	64	56.5	43.4
2	*6465.00	87.9 AV			1.24 V	64	44.5	43.4
3	#12930.00	58.2 PK	88.2	-30.0	1.75 V	252	40.3	17.9
4	#12930.00	45.0 AV	68.2	-23.2	1.75 V	252	27.1	17.9

Remarks:

1. Emission Level(dBuV/m) = Raw Value(dBuV) + Correction Factor(dB/m).
2. Correction Factor(dB/m) = Antenna Factor(dB/m) + Cable Factor(dB) – Pre-Amplifier Factor(dB).
3. Margin value = Emission Level – Limit value.
4. The other emission levels were very low against the limit.
5. " * " : Fundamental frequency.
6. " # " : The radiated frequency is out of the restricted band.

RF Mode	TX 802.11ax (HE80)	Channel	CH 119 : 6545 MHz
Frequency Range	1GHz ~ 40GHz	Detector Function	Peak (PK) Average (AV)

Antenna Polarity & Test Distance : Horizontal at 3 m								
No	Frequency (MHz)	Emission Level (dBuV/m)	Limit (dBuV/m)	Margin (dB)	Antenna Height (m)	Table Angle (Degree)	Raw Value (dBuV)	Correction Factor (dB/m)
1	*6545.00	101.0 PK			3.75 H	88	57.9	43.1
2	*6545.00	88.2 AV			3.75 H	88	45.1	43.1
3	#13090.00	58.6 PK	88.2	-29.6	2.30 H	287	40.5	18.1
4	#13090.00	45.1 AV	68.2	-23.1	2.30 H	287	27.0	18.1
Antenna Polarity & Test Distance : Vertical at 3 m								
No	Frequency (MHz)	Emission Level (dBuV/m)	Limit (dBuV/m)	Margin (dB)	Antenna Height (m)	Table Angle (Degree)	Raw Value (dBuV)	Correction Factor (dB/m)
1	*6545.00	100.0 PK			1.09 V	63	56.9	43.1
2	*6545.00	87.1 AV			1.09 V	63	44.0	43.1
3	#13090.00	58.3 PK	88.2	-29.9	1.82 V	257	40.2	18.1
4	#13090.00	44.9 AV	68.2	-23.3	1.82 V	257	26.8	18.1

Remarks:

1. Emission Level(dBuV/m) = Raw Value(dBuV) + Correction Factor(dB/m).
2. Correction Factor(dB/m) = Antenna Factor(dB/m) + Cable Factor(dB) – Pre-Amplifier Factor(dB).
3. Margin value = Emission Level – Limit value.
4. The other emission levels were very low against the limit.
5. " * " : Fundamental frequency.
6. " # " : The radiated frequency is out of the restricted band.

RF Mode	TX 802.11ax (HE80)	Channel	CH 151 : 6705 MHz
Frequency Range	1GHz ~ 40GHz	Detector Function	Peak (PK) Average (AV)

Antenna Polarity & Test Distance : Horizontal at 3 m								
No	Frequency (MHz)	Emission Level (dBuV/m)	Limit (dBuV/m)	Margin (dB)	Antenna Height (m)	Table Angle (Degree)	Raw Value (dBuV)	Correction Factor (dB/m)
1	*6705.00	101.2 PK			3.39 H	89	57.4	43.8
2	*6705.00	88.4 AV			3.39 H	89	44.6	43.8
3	#13410.00	60.1 PK	88.2	-28.1	2.34 H	293	40.8	19.3
4	#13410.00	46.5 AV	68.2	-21.7	2.34 H	293	27.2	19.3
Antenna Polarity & Test Distance : Vertical at 3 m								
No	Frequency (MHz)	Emission Level (dBuV/m)	Limit (dBuV/m)	Margin (dB)	Antenna Height (m)	Table Angle (Degree)	Raw Value (dBuV)	Correction Factor (dB/m)
1	*6705.00	99.9 PK			1.10 V	66	56.1	43.8
2	*6705.00	87.2 AV			1.10 V	66	43.4	43.8
3	#13410.00	59.8 PK	88.2	-28.4	1.82 V	255	40.5	19.3
4	#13410.00	46.3 AV	68.2	-21.9	1.82 V	255	27.0	19.3

Remarks:

1. Emission Level(dBuV/m) = Raw Value(dBuV) + Correction Factor(dB/m).
2. Correction Factor(dB/m) = Antenna Factor(dB/m) + Cable Factor(dB) – Pre-Amplifier Factor(dB).
3. Margin value = Emission Level – Limit value.
4. The other emission levels were very low against the limit.
5. " * " : Fundamental frequency.
6. " # " : The radiated frequency is out of the restricted band.

RF Mode	TX 802.11ax (HE80)	Channel	CH 183 : 6865 MHz
Frequency Range	1GHz ~ 40GHz	Detector Function	Peak (PK) Average (AV)

Antenna Polarity & Test Distance : Horizontal at 3 m								
No	Frequency (MHz)	Emission Level (dBuV/m)	Limit (dBuV/m)	Margin (dB)	Antenna Height (m)	Table Angle (Degree)	Raw Value (dBuV)	Correction Factor (dB/m)
1	*6865.00	100.9 PK			3.42 H	87	56.7	44.2
2	*6865.00	88.1 AV			3.42 H	87	43.9	44.2
3	#13730.00	60.5 PK	88.2	-27.7	2.40 H	282	41.0	19.5
4	#13730.00	46.8 AV	68.2	-21.4	2.40 H	282	27.3	19.5
Antenna Polarity & Test Distance : Vertical at 3 m								
No	Frequency (MHz)	Emission Level (dBuV/m)	Limit (dBuV/m)	Margin (dB)	Antenna Height (m)	Table Angle (Degree)	Raw Value (dBuV)	Correction Factor (dB/m)
1	*6865.00	99.7 PK			1.21 V	64	55.5	44.2
2	*6865.00	87.0 AV			1.21 V	64	42.8	44.2
3	#13730.00	60.3 PK	88.2	-27.9	1.79 V	264	40.8	19.5
4	#13730.00	46.5 AV	68.2	-21.7	1.79 V	264	27.0	19.5

Remarks:

1. Emission Level(dBuV/m) = Raw Value(dBuV) + Correction Factor(dB/m).
2. Correction Factor(dB/m) = Antenna Factor(dB/m) + Cable Factor(dB) – Pre-Amplifier Factor(dB).
3. Margin value = Emission Level – Limit value.
4. The other emission levels were very low against the limit.
5. " * " : Fundamental frequency.
6. " # " : The radiated frequency is out of the restricted band.

RF Mode	TX 802.11ax (HE80)	Channel	CH 199 : 6945 MHz
Frequency Range	1GHz ~ 40GHz	Detector Function	Peak (PK) Average (AV)

Antenna Polarity & Test Distance : Horizontal at 3 m								
No	Frequency (MHz)	Emission Level (dBuV/m)	Limit (dBuV/m)	Margin (dB)	Antenna Height (m)	Table Angle (Degree)	Raw Value (dBuV)	Correction Factor (dB/m)
1	*6945.00	100.7 PK			3.79 H	82	56.8	43.9
2	*6945.00	88.0 AV			3.79 H	82	44.1	43.9
3	#13890.00	60.1 PK	88.2	-28.1	2.17 H	288	39.7	20.4
4	#13890.00	47.3 AV	68.2	-20.9	2.17 H	288	26.9	20.4
Antenna Polarity & Test Distance : Vertical at 3 m								
No	Frequency (MHz)	Emission Level (dBuV/m)	Limit (dBuV/m)	Margin (dB)	Antenna Height (m)	Table Angle (Degree)	Raw Value (dBuV)	Correction Factor (dB/m)
1	*6945.00	99.4 PK			1.22 V	70	55.5	43.9
2	*6945.00	87.2 AV			1.22 V	70	43.3	43.9
3	#13890.00	59.9 PK	88.2	-28.3	1.82 V	263	39.5	20.4
4	#13890.00	47.1 AV	68.2	-21.1	1.82 V	263	26.7	20.4

Remarks:

1. Emission Level(dBuV/m) = Raw Value(dBuV) + Correction Factor(dB/m).
2. Correction Factor(dB/m) = Antenna Factor(dB/m) + Cable Factor(dB) – Pre-Amplifier Factor(dB).
3. Margin value = Emission Level – Limit value.
4. The other emission levels were very low against the limit.
5. " * " : Fundamental frequency.
6. " # " : The radiated frequency is out of the restricted band.

RF Mode	TX 802.11ax (HE80)	Channel	CH 215 : 7025 MHz
Frequency Range	1GHz ~ 40GHz	Detector Function	Peak (PK) Average (AV)

Antenna Polarity & Test Distance : Horizontal at 3 m								
No	Frequency (MHz)	Emission Level (dBuV/m)	Limit (dBuV/m)	Margin (dB)	Antenna Height (m)	Table Angle (Degree)	Raw Value (dBuV)	Correction Factor (dB/m)
1	*7025.00	101.9 PK			3.68 H	83	56.8	45.1
2	*7025.00	89.3 AV			3.68 H	83	44.2	45.1
3	#7125.00	61.5 PK	88.2	-26.7	3.68 H	83	50.6	10.9
4	#7125.00	48.9 AV	68.2	-19.3	3.68 H	83	38.0	10.9
5	#14050.00	61.5 PK	88.2	-26.7	2.19 H	295	40.6	20.9
6	#14050.00	47.8 AV	68.2	-20.4	2.19 H	295	26.9	20.9

Antenna Polarity & Test Distance : Vertical at 3 m								
No	Frequency (MHz)	Emission Level (dBuV/m)	Limit (dBuV/m)	Margin (dB)	Antenna Height (m)	Table Angle (Degree)	Raw Value (dBuV)	Correction Factor (dB/m)
1	*7025.00	99.9 PK			1.00 V	62	54.8	45.1
2	*7025.00	88.0 AV			1.00 V	62	42.9	45.1
3	#7125.00	61.3 PK	88.2	-26.9	1.00 V	62	50.4	10.9
4	#7125.00	48.6 AV	68.2	-19.6	1.00 V	62	37.7	10.9
5	#14050.00	61.1 PK	88.2	-27.1	2.95 V	254	40.2	20.9
6	#14050.00	47.5 AV	68.2	-20.7	2.95 V	254	26.6	20.9

Remarks:

1. Emission Level(dBuV/m) = Raw Value(dBuV) + Correction Factor(dB/m).
2. Correction Factor(dB/m) = Antenna Factor(dB/m) + Cable Factor(dB) – Pre-Amplifier Factor(dB).
3. Margin value = Emission Level – Limit value.
4. The other emission levels were very low against the limit.
5. " * " : Fundamental frequency.
6. " # " : The radiated frequency is out of the restricted band.

RF Mode	TX 802.11ax (HE160)	Channel	CH 15 : 6025 MHz
Frequency Range	1GHz ~ 40GHz	Detector Function	Peak (PK) Average (AV)

Antenna Polarity & Test Distance : Horizontal at 3 m								
No	Frequency (MHz)	Emission Level (dBuV/m)	Limit (dBuV/m)	Margin (dB)	Antenna Height (m)	Table Angle (Degree)	Raw Value (dBuV)	Correction Factor (dB/m)
1	#5925.00	58.6 PK	88.2	-29.6	2.63 H	80	51.5	7.1
2	#5925.00	46.2 AV	68.2	-22.0	2.63 H	80	39.1	7.1
3	*6025.00	99.7 PK			2.63 H	80	58.3	41.4
4	*6025.00	87.1 AV			2.63 H	80	45.7	41.4
5	12050.00	57.9 PK	74.0	-16.1	2.09 H	299	41.1	16.8
6	12050.00	45.2 AV	54.0	-8.8	2.09 H	299	28.4	16.8

Antenna Polarity & Test Distance : Vertical at 3 m								
No	Frequency (MHz)	Emission Level (dBuV/m)	Limit (dBuV/m)	Margin (dB)	Antenna Height (m)	Table Angle (Degree)	Raw Value (dBuV)	Correction Factor (dB/m)
1	#5925.00	58.3 PK	88.2	-29.9	1.03 V	331	51.2	7.1
2	#5925.00	46.0 AV	68.2	-22.2	1.03 V	331	38.9	7.1
3	*6025.00	97.9 PK			1.03 V	331	56.5	41.4
4	*6025.00	85.9 AV			1.03 V	331	44.5	41.4
5	12050.00	57.7 PK	74.0	-16.3	1.91 V	258	40.9	16.8
6	12050.00	45.0 AV	54.0	-9.0	1.91 V	258	28.2	16.8

Remarks:

1. Emission Level(dBuV/m) = Raw Value(dBuV) + Correction Factor(dB/m).
2. Correction Factor(dB/m) = Antenna Factor(dB/m) + Cable Factor(dB) – Pre-Amplifier Factor(dB).
3. Margin value = Emission Level – Limit value.
4. The other emission levels were very low against the limit.
5. " * " : Fundamental frequency.
6. " # " : The radiated frequency is out of the restricted band.

RF Mode	TX 802.11ax (HE160)	Channel	CH 47 : 6185 MHz
Frequency Range	1GHz ~ 40GHz	Detector Function	Peak (PK) Average (AV)

Antenna Polarity & Test Distance : Horizontal at 3 m								
No	Frequency (MHz)	Emission Level (dBuV/m)	Limit (dBuV/m)	Margin (dB)	Antenna Height (m)	Table Angle (Degree)	Raw Value (dBuV)	Correction Factor (dB/m)
1	*6185.00	100.0 PK			2.72 H	83	58.0	42.0
2	*6185.00	87.4 AV			2.72 H	83	45.4	42.0
3	12370.00	58.0 PK	74.0	-16.0	2.03 H	286	41.4	16.6
4	12370.00	45.2 AV	54.0	-8.8	2.03 H	286	28.6	16.6
Antenna Polarity & Test Distance : Vertical at 3 m								
No	Frequency (MHz)	Emission Level (dBuV/m)	Limit (dBuV/m)	Margin (dB)	Antenna Height (m)	Table Angle (Degree)	Raw Value (dBuV)	Correction Factor (dB/m)
1	*6185.00	99.0 PK			1.03 V	333	57.0	42.0
2	*6185.00	86.2 AV			1.03 V	333	44.2	42.0
3	12370.00	57.7 PK	74.0	-16.3	1.89 V	252	41.1	16.6
4	12370.00	45.1 AV	54.0	-8.9	1.89 V	252	28.5	16.6

Remarks:

1. Emission Level(dBuV/m) = Raw Value(dBuV) + Correction Factor(dB/m).
2. Correction Factor(dB/m) = Antenna Factor(dB/m) + Cable Factor(dB) – Pre-Amplifier Factor(dB).
3. Margin value = Emission Level – Limit value.
4. The other emission levels were very low against the limit.
5. " * " : Fundamental frequency.

RF Mode	TX 802.11ax (HE160)	Channel	CH 79 : 6345 MHz
Frequency Range	1GHz ~ 40GHz	Detector Function	Peak (PK) Average (AV)

Antenna Polarity & Test Distance : Horizontal at 3 m								
No	Frequency (MHz)	Emission Level (dBuV/m)	Limit (dBuV/m)	Margin (dB)	Antenna Height (m)	Table Angle (Degree)	Raw Value (dBuV)	Correction Factor (dB/m)
1	*6345.00	99.6 PK			2.72 H	79	57.3	42.3
2	*6345.00	87.0 AV			2.72 H	79	44.7	42.3
3	12690.00	58.5 PK	74.0	-15.5	2.16 H	291	41.4	17.1
4	12690.00	45.6 AV	54.0	-8.4	2.16 H	291	28.5	17.1
Antenna Polarity & Test Distance : Vertical at 3 m								
No	Frequency (MHz)	Emission Level (dBuV/m)	Limit (dBuV/m)	Margin (dB)	Antenna Height (m)	Table Angle (Degree)	Raw Value (dBuV)	Correction Factor (dB/m)
1	*6345.00	98.6 PK			1.11 V	336	56.3	42.3
2	*6345.00	85.9 AV			1.11 V	336	43.6	42.3
3	12690.00	58.2 PK	74.0	-15.8	1.87 V	252	41.1	17.1
4	12690.00	45.2 AV	54.0	-8.8	1.87 V	252	28.1	17.1

Remarks:

1. Emission Level(dBuV/m) = Raw Value(dBuV) + Correction Factor(dB/m).
2. Correction Factor(dB/m) = Antenna Factor(dB/m) + Cable Factor(dB) – Pre-Amplifier Factor(dB).
3. Margin value = Emission Level – Limit value.
4. The other emission levels were very low against the limit.
5. " * " : Fundamental frequency.

RF Mode	TX 802.11ax (HE160)	Channel	CH 111 : 6505 MHz
Frequency Range	1GHz ~ 40GHz	Detector Function	Peak (PK) Average (AV)

Antenna Polarity & Test Distance : Horizontal at 3 m								
No	Frequency (MHz)	Emission Level (dBuV/m)	Limit (dBuV/m)	Margin (dB)	Antenna Height (m)	Table Angle (Degree)	Raw Value (dBuV)	Correction Factor (dB/m)
1	*6505.00	99.7 PK			3.14 H	81	56.4	43.3
2	*6505.00	86.5 AV			3.14 H	81	43.2	43.3
3	#13010.00	58.7 PK	88.2	-29.5	2.07 H	284	40.6	18.1
4	#13010.00	45.4 AV	68.2	-22.8	2.07 H	284	27.3	18.1
Antenna Polarity & Test Distance : Vertical at 3 m								
No	Frequency (MHz)	Emission Level (dBuV/m)	Limit (dBuV/m)	Margin (dB)	Antenna Height (m)	Table Angle (Degree)	Raw Value (dBuV)	Correction Factor (dB/m)
1	*6505.00	99.2 PK			1.19 V	65	55.9	43.3
2	*6505.00	85.8 AV			1.19 V	65	42.5	43.3
3	#13010.00	58.4 PK	88.2	-29.8	1.83 V	249	40.3	18.1
4	#13010.00	45.0 AV	68.2	-23.2	1.83 V	249	26.9	18.1

Remarks:

1. Emission Level(dBuV/m) = Raw Value(dBuV) + Correction Factor(dB/m).
2. Correction Factor(dB/m) = Antenna Factor(dB/m) + Cable Factor(dB) – Pre-Amplifier Factor(dB).
3. Margin value = Emission Level – Limit value.
4. The other emission levels were very low against the limit.
5. " * " : Fundamental frequency.
6. " # " : The radiated frequency is out of the restricted band.

RF Mode	TX 802.11ax (HE160)	Channel	CH 143 : 6665 MHz
Frequency Range	1GHz ~ 40GHz	Detector Function	Peak (PK) Average (AV)

Antenna Polarity & Test Distance : Horizontal at 3 m								
No	Frequency (MHz)	Emission Level (dBuV/m)	Limit (dBuV/m)	Margin (dB)	Antenna Height (m)	Table Angle (Degree)	Raw Value (dBuV)	Correction Factor (dB/m)
1	*6665.00	101.0 PK			3.67 H	81	57.2	43.8
2	*6665.00	88.2 AV			3.67 H	81	44.4	43.8
3	13330.00	59.5 PK	74.0	-14.5	2.19 H	291	40.7	18.8
4	13330.00	45.5 AV	54.0	-8.5	2.19 H	291	26.7	18.8
Antenna Polarity & Test Distance : Vertical at 3 m								
No	Frequency (MHz)	Emission Level (dBuV/m)	Limit (dBuV/m)	Margin (dB)	Antenna Height (m)	Table Angle (Degree)	Raw Value (dBuV)	Correction Factor (dB/m)
1	*6665.00	99.8 PK			1.06 V	65	56.0	43.8
2	*6665.00	86.0 AV			1.06 V	65	42.2	43.8
3	13330.00	59.3 PK	74.0	-14.7	1.77 V	258	40.5	18.8
4	13330.00	45.3 AV	54.0	-8.7	1.77 V	258	26.5	18.8

Remarks:

1. Emission Level(dBuV/m) = Raw Value(dBuV) + Correction Factor(dB/m).
2. Correction Factor(dB/m) = Antenna Factor(dB/m) + Cable Factor(dB) – Pre-Amplifier Factor(dB).
3. Margin value = Emission Level – Limit value.
4. The other emission levels were very low against the limit.
5. " * " : Fundamental frequency.

RF Mode	TX 802.11ax (HE160)	Channel	CH 175 : 6825 MHz
Frequency Range	1GHz ~ 40GHz	Detector Function	Peak (PK) Average (AV)

Antenna Polarity & Test Distance : Horizontal at 3 m								
No	Frequency (MHz)	Emission Level (dBuV/m)	Limit (dBuV/m)	Margin (dB)	Antenna Height (m)	Table Angle (Degree)	Raw Value (dBuV)	Correction Factor (dB/m)
1	*6825.00	101.2 PK			3.55 H	83	57.1	44.1
2	*6825.00	88.4 AV			3.55 H	83	44.3	44.1
3	#13650.00	60.6 PK	88.2	-27.6	2.30 H	282	40.9	19.7
4	#13650.00	46.5 AV	68.2	-21.7	2.30 H	282	26.8	19.7
Antenna Polarity & Test Distance : Vertical at 3 m								
No	Frequency (MHz)	Emission Level (dBuV/m)	Limit (dBuV/m)	Margin (dB)	Antenna Height (m)	Table Angle (Degree)	Raw Value (dBuV)	Correction Factor (dB/m)
1	*6825.00	100.2 PK			1.20 V	66	56.1	44.1
2	*6825.00	87.4 AV			1.20 V	66	43.3	44.1
3	#13650.00	60.3 PK	88.2	-27.9	1.80 V	264	40.6	19.7
4	#13650.00	46.3 AV	68.2	-21.9	1.80 V	264	26.6	19.7

Remarks:

1. Emission Level(dBuV/m) = Raw Value(dBuV) + Correction Factor(dB/m).
2. Correction Factor(dB/m) = Antenna Factor(dB/m) + Cable Factor(dB) – Pre-Amplifier Factor(dB).
3. Margin value = Emission Level – Limit value.
4. The other emission levels were very low against the limit.
5. " * " : Fundamental frequency.
6. " # " : The radiated frequency is out of the restricted band.

RF Mode	TX 802.11ax (HE160)	Channel	CH 207 : 6985 MHz
Frequency Range	1GHz ~ 40GHz	Detector Function	Peak (PK) Average (AV)

Antenna Polarity & Test Distance : Horizontal at 3 m								
No	Frequency (MHz)	Emission Level (dBuV/m)	Limit (dBuV/m)	Margin (dB)	Antenna Height (m)	Table Angle (Degree)	Raw Value (dBuV)	Correction Factor (dB/m)
1	*6985.00	100.8 PK			3.74 H	83	56.4	44.4
2	*6985.00	87.7 AV			3.74 H	83	43.3	44.4
3	#7125.00	62.0 PK	88.2	-26.2	3.74 H	83	51.1	10.9
4	#7125.00	48.6 AV	68.2	-19.6	3.74 H	83	37.7	10.9
5	9313.33	56.6 PK	74.0	-17.4	1.93 H	228	41.8	14.8
6	9313.33	43.7 AV	54.0	-10.3	1.93 H	228	28.9	14.8
7	#13970.00	60.8 PK	88.2	-27.4	2.14 H	297	40.2	20.6
8	#13970.00	47.9 AV	68.2	-20.3	2.14 H	297	27.3	20.6
Antenna Polarity & Test Distance : Vertical at 3 m								
No	Frequency (MHz)	Emission Level (dBuV/m)	Limit (dBuV/m)	Margin (dB)	Antenna Height (m)	Table Angle (Degree)	Raw Value (dBuV)	Correction Factor (dB/m)
1	*6985.00	97.7 PK			1.11 V	64	53.3	44.4
2	*6985.00	86.4 AV			1.11 V	64	42.0	44.4
3	#7125.00	64.9 PK	88.2	-23.3	1.11 V	64	54.0	10.9
4	#7125.00	51.5 AV	68.2	-16.7	1.11 V	64	40.6	10.9
5	9313.33	56.3 PK	74.0	-17.7	2.39 V	115	41.5	14.8
6	9313.33	43.4 AV	54.0	-10.6	2.39 V	115	28.6	14.8
7	#13970.00	60.2 PK	88.2	-28.0	1.89 V	264	39.6	20.6
8	#13970.00	47.3 AV	68.2	-20.9	1.89 V	264	26.7	20.6

Remarks:

1. Emission Level(dBuV/m) = Raw Value(dBuV) + Correction Factor(dB/m).
2. Correction Factor(dB/m) = Antenna Factor(dB/m) + Cable Factor(dB) – Pre-Amplifier Factor(dB).
3. Margin value = Emission Level – Limit value.
4. The other emission levels were very low against the limit.
5. " * " : Fundamental frequency.
6. " # " : The radiated frequency is out of the restricted band.

Below 1GHz Worst-Case Data:

RF Mode	TX 802.11ax (HE160)	Channel	CH 207 : 6985 MHz
Frequency Range	30MHz ~ 1GHz	Detector Function	Quasi-Peak (QP)

Antenna Polarity & Test Distance : Horizontal at 3 m								
No	Frequency (MHz)	Emission Level (dBuV/m)	Limit (dBuV/m)	Margin (dB)	Antenna Height (m)	Table Angle (Degree)	Raw Value (dBuV)	Correction Factor (dB/m)
1	78.50	29.3 QP	40.0	-10.7	2.00 H	325	42.3	-13.0
2	155.13	33.0 QP	43.5	-10.5	1.50 H	124	41.7	-8.7
3	283.17	21.7 QP	46.0	-24.3	1.00 H	289	28.9	-7.2
4	465.53	25.7 QP	46.0	-20.3	1.00 H	16	28.7	-3.0
5	565.44	29.3 QP	46.0	-16.7	2.00 H	168	30.6	-1.3
6	628.49	29.3 QP	46.0	-16.7	1.00 H	92	29.0	0.3

Remarks:

1. Emission Level(dBuV/m) = Raw Value(dBuV) + Correction Factor(dB/m).
2. Correction Factor(dB/m) = Antenna Factor(dB/m) + Cable Factor(dB) – Pre-Amplifier Factor(dB).
3. Margin value = Emission Level – Limit value.
4. The other emission levels were very low against the limit of frequency range 30MHz~1000MHz.
5. The emission levels were very low against the limit of frequency range 9kHz~30MHz: the amplitude of spurious emissions attenuated more than 20 dB below the permissible value to be report.

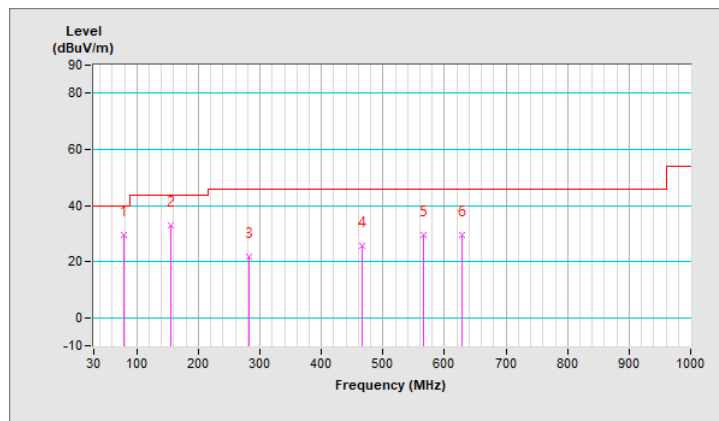

RF Mode	TX 802.11ax (HE160)	Channel	CH 207 : 6985 MHz
Frequency Range	30MHz ~ 1GHz	Detector Function	Quasi-Peak (QP)

Antenna Polarity & Test Distance : Vertical at 3 m								
No	Frequency (MHz)	Emission Level (dBuV/m)	Limit (dBuV/m)	Margin (dB)	Antenna Height (m)	Table Angle (Degree)	Raw Value (dBuV)	Correction Factor (dB/m)
1	45.52	29.4 QP	40.0	-10.6	1.50 V	9	38.4	-9.0
2	69.77	31.4 QP	40.0	-8.6	1.00 V	84	42.4	-11.0
3	154.16	31.0 QP	43.5	-12.5	2.00 V	228	39.5	-8.5
4	368.53	22.5 QP	46.0	-23.5	1.00 V	65	28.0	-5.5
5	510.15	26.5 QP	46.0	-19.5	1.50 V	16	28.6	-2.1
6	683.78	30.1 QP	46.0	-15.9	1.00 V	259	29.1	1.0

Remarks:

1. Emission Level(dBuV/m) = Raw Value(dBuV) + Correction Factor(dB/m).
2. Correction Factor(dB/m) = Antenna Factor(dB/m) + Cable Factor(dB) – Pre-Amplifier Factor(dB).
3. Margin value = Emission Level – Limit value.
4. The other emission levels were very low against the limit of frequency range 30MHz~1000MHz.
5. The emission levels were very low against the limit of frequency range 9kHz~30MHz: the amplitude of spurious emissions attenuated more than 20 dB below the permissible value to be report.

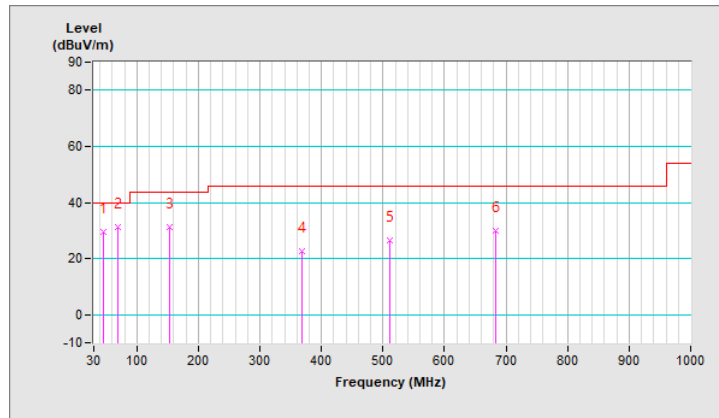

4.2 In-Band Emission (Mask) Measurement

4.2.1 Limits of In-Band Emission (Mask) Measurement

Test Item	Frequencies (MHz)	(X) dBc ^{*1}
Emission Mask	At 1 MHz outside of channel edge	20
	At one channel bandwidth from the channel center ^{*2}	28
	At one- and one-half times the channel bandwidth away from channel center ^{*3}	40
	More than one- and one-half times the channel bandwidth	40

*1 : The power spectral density must be suppressed by “x” dB

*2 : At frequencies between one megahertz outside an unlicensed device’s channel edge and one channel bandwidth from the center of the channel, the limits must be linearly interpolated between 20 dB and 28 dB suppression,

*3 : At frequencies between one and one- and one-half times an unlicensed device’s channel bandwidth, the limits must be linearly interpolated between 28 dB and 40 dB suppression.

4.2.2 Test Setup

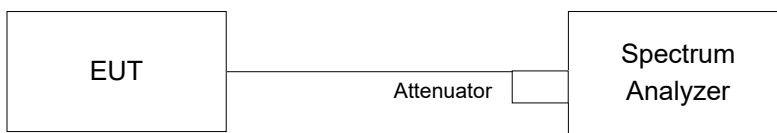

4.2.3 Test Instruments

Description Manufacturer	Model No.	Serial No.	Calibrated Date	Calibrated Until
Software BV	ADT_RF Test Software V6.6.5.4	N/A	N/A	N/A
Spectrum Analyzer R&S	FSV40	100979	2022/3/25	2023/3/24

Notes:

1. The test was performed in Oven room.
2. Tested Date: 2022/11/17

4.2.4 Test Procedure

- a. Connect output of the antenna port to a spectrum analyzer and adjust appropriate attenuation.
- b. Measure the 26 dB EBW using the test procedure 12.4.1 of ANSI C63.10-2013. (Determine the channel edge.)
- c. Measure the power spectral density (for emissions mask reference) using the following procedure:
 - a) Set the span to encompass the entire 26 dB EBW of the signal.
 - b) Set RBW = same RBW used for 26 dB EBW measurement.
 - c) Set VBW $\geq 3 \times$ RBW
 - d) Number of points in sweep $\geq [2 \times \text{span} / \text{RBW}]$.
 - e) Sweep time = auto.
 - f) Detector = RMS (i.e., power averaging)
 - g) Trace average at least 100 traces in power averaging (rms) mode.
 - h) Use the peak search function on the instrument to find the peak of the spectrum.
- d. Using the measuring equipment limit line function, develop the emissions mask based on the following requirements. The emissions power spectral density must be reduced below the peak power spectral density (in dB) as follows:
 - a) Suppressed by 20 dB at 1 MHz outside of the channel edge. (The channel edge is defined as the 26-dB point on either side of the carrier center frequency.)
 - b) Suppressed by 28 dB at one channel bandwidth from the channel center.
 - c) Suppressed by 40 dB at one- and one-half times the channel bandwidth from the channel center.
- e. Adjust the span to encompass the entire mask as necessary and clear trace.
- f. Trace average at least 100 traces in power averaging (rms) mode.
- g. Adjust the reference level as necessary so that the crest of the channel touches the top of the emission mask

4.2.5 EUT Operating Condition

The software provided by client to enable the EUT under transmission condition continuously at lowest, middle and highest channel frequencies individually.

4.2.6 Test Results

802.11ax (HE20)_Chain 0

Spectrum Plot

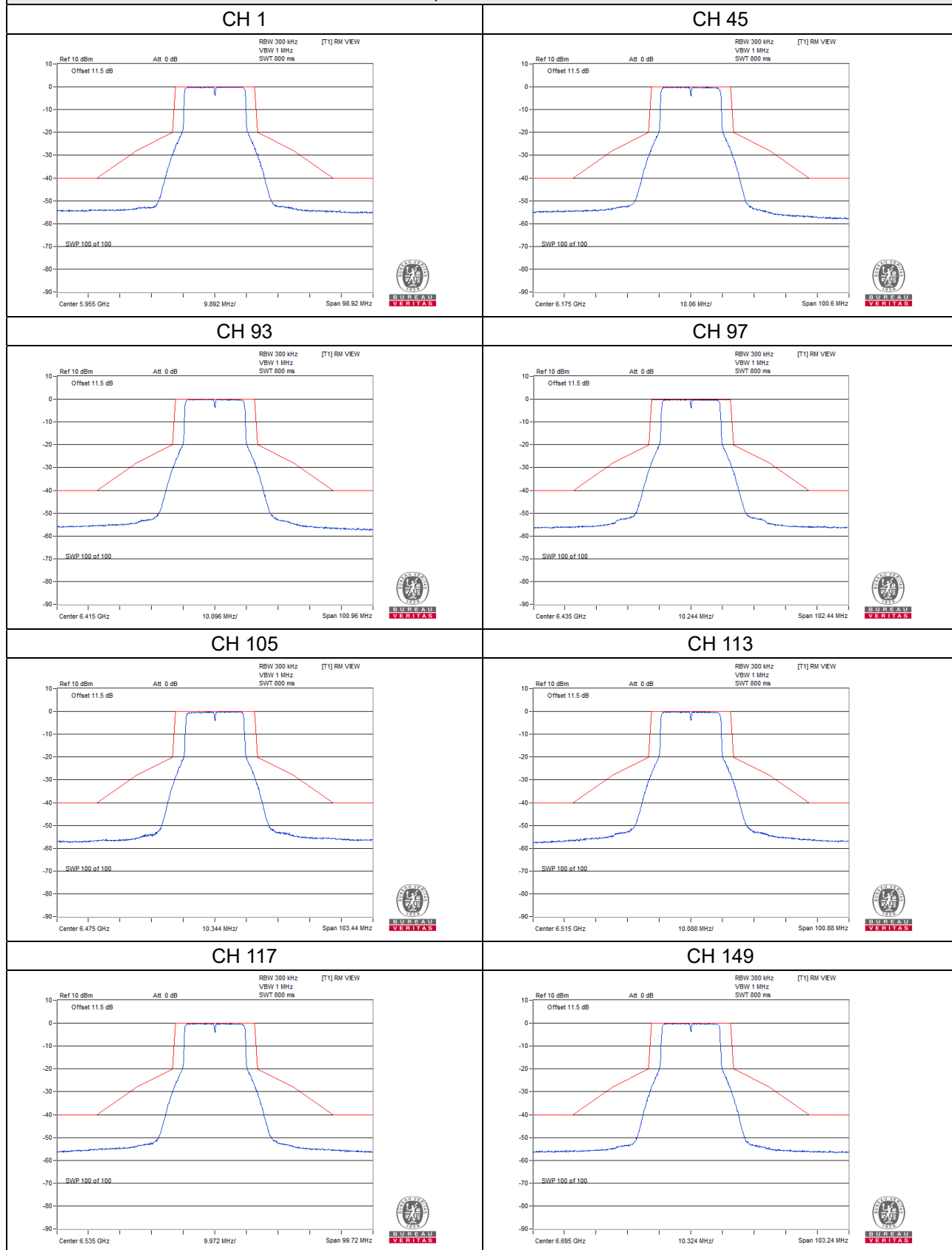

Spectrum Plot

CH 181

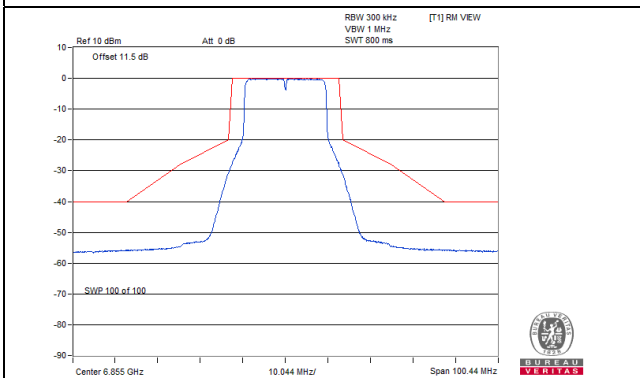

CH 185

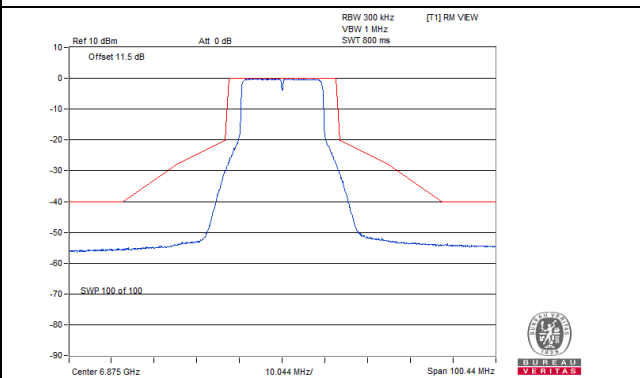

CH 209

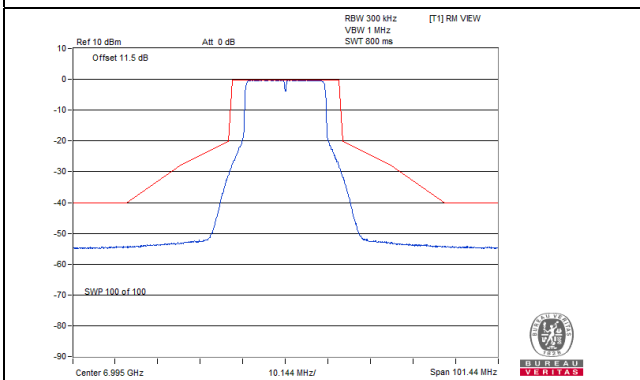

CH 233

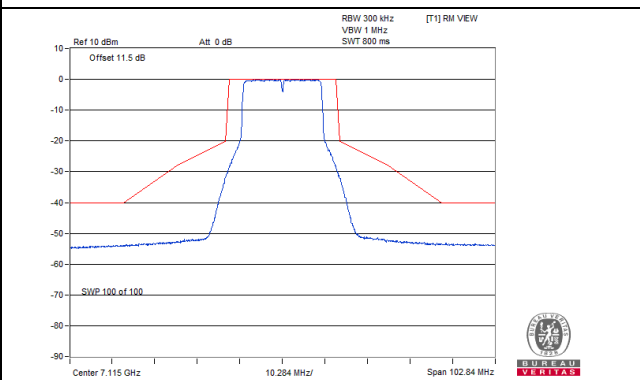

802.11ax (HE20)_Chain 1

Spectrum Plot

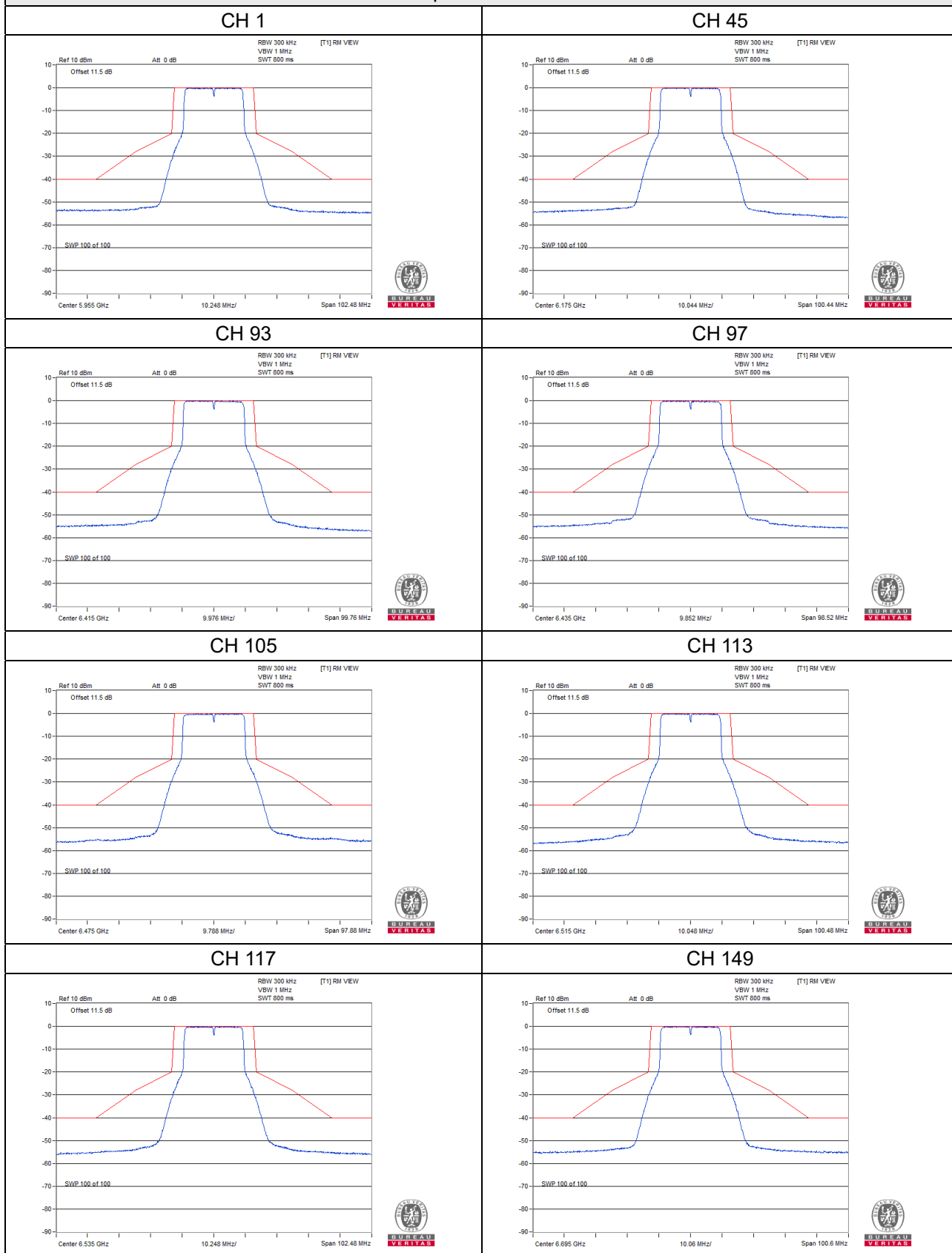

Spectrum Plot

CH 181

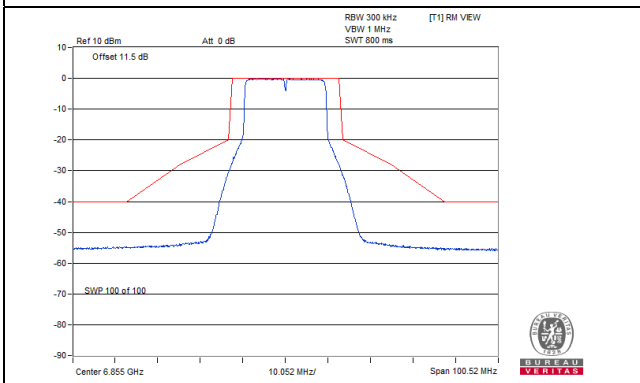

CH 185

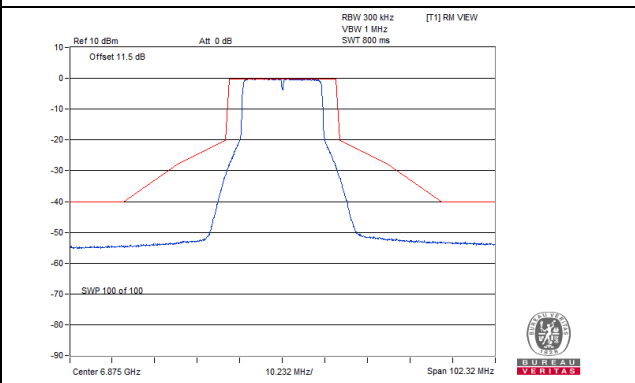

CH 209

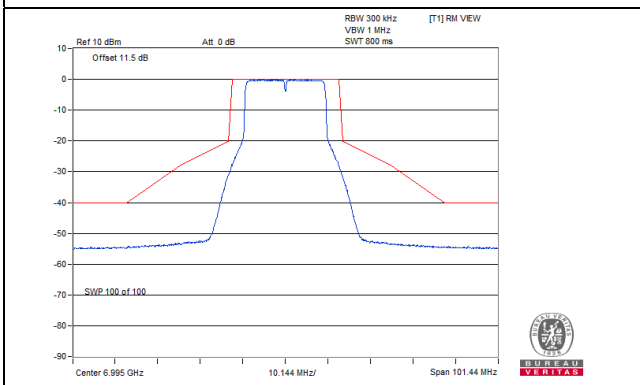

CH 233

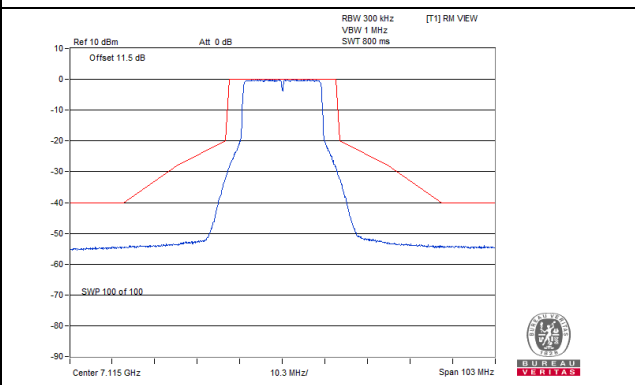

802.11ax (HE40)_Chain 0

Spectrum Plot

CH 3

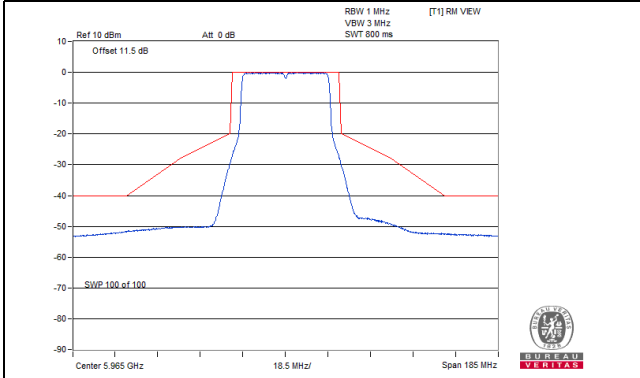

CH 43

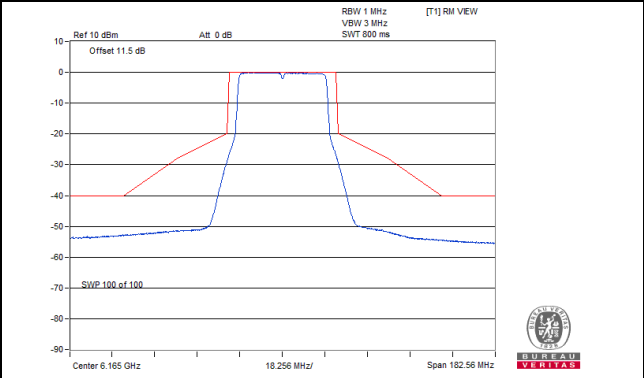

CH 91

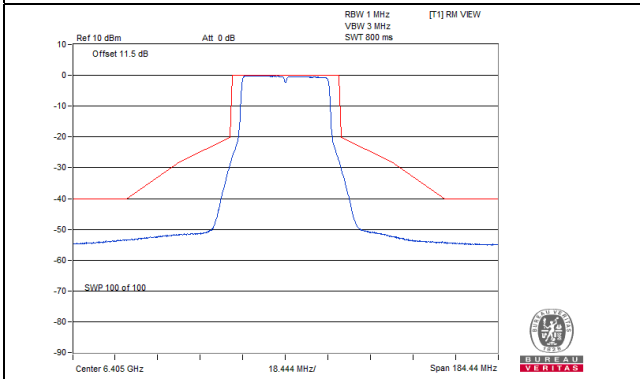

CH 99

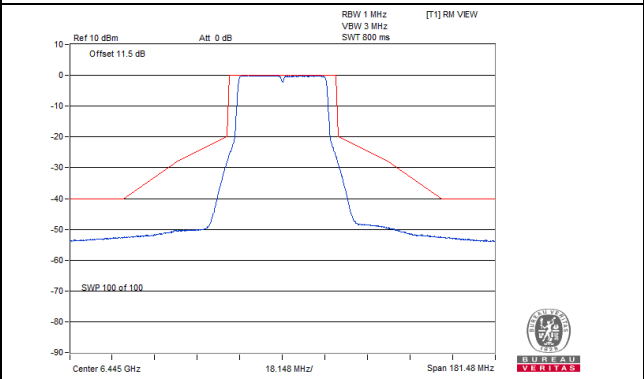

CH 107

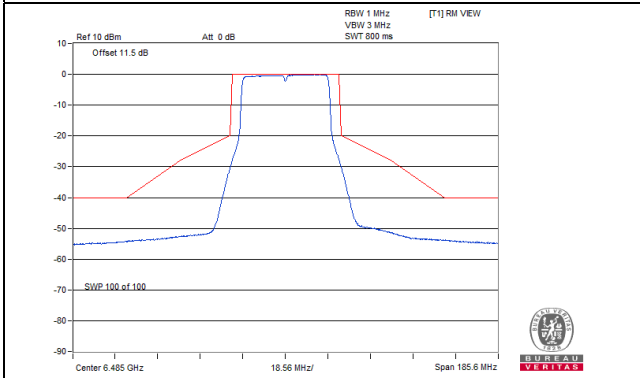

CH 115

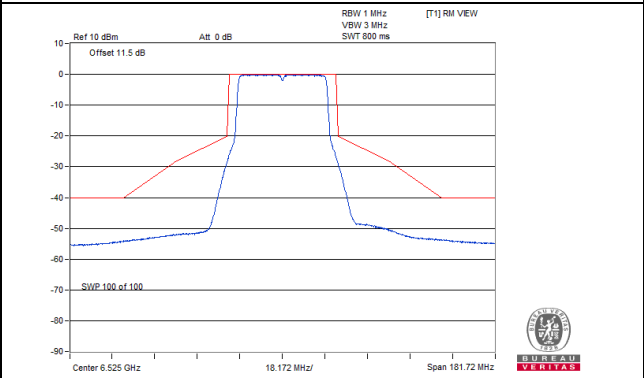

CH 123

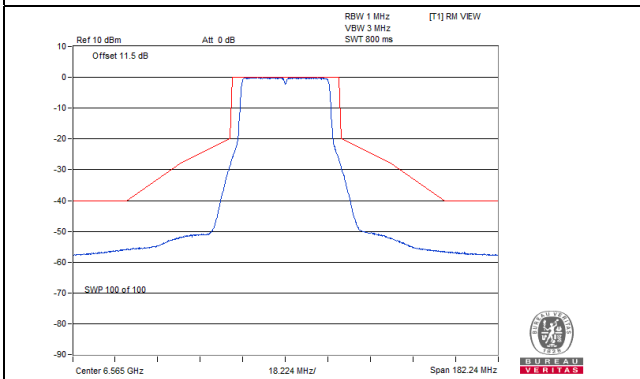

CH 155

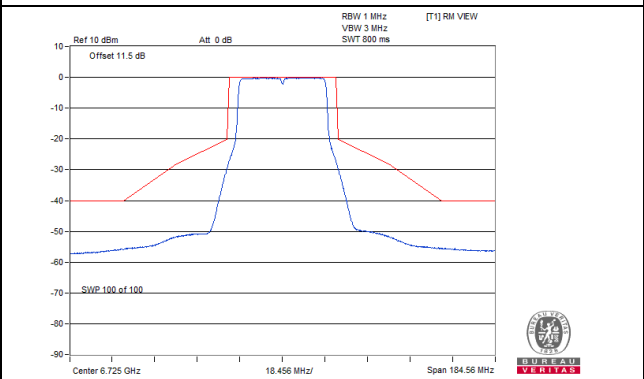

Spectrum Plot

CH 179

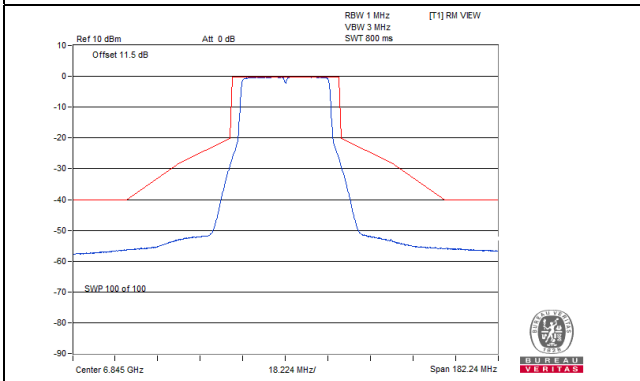

CH 187

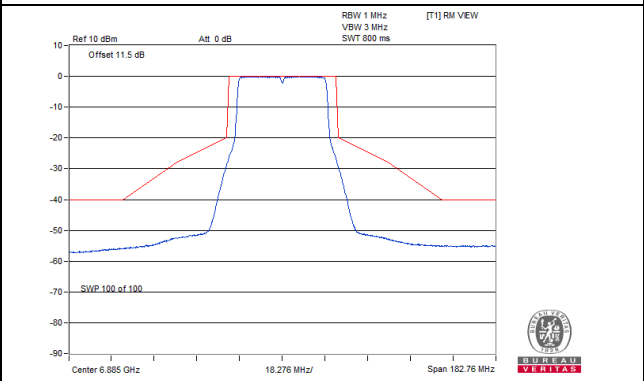

CH 211

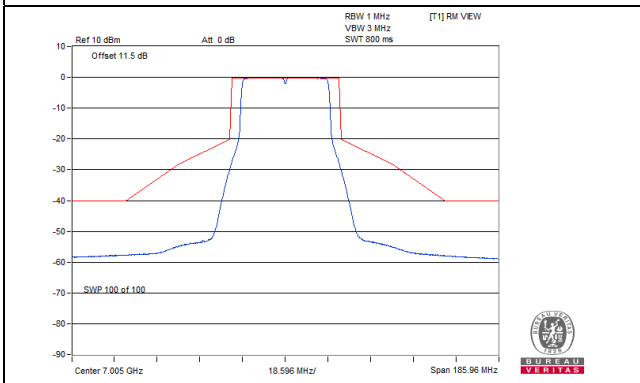

CH 227

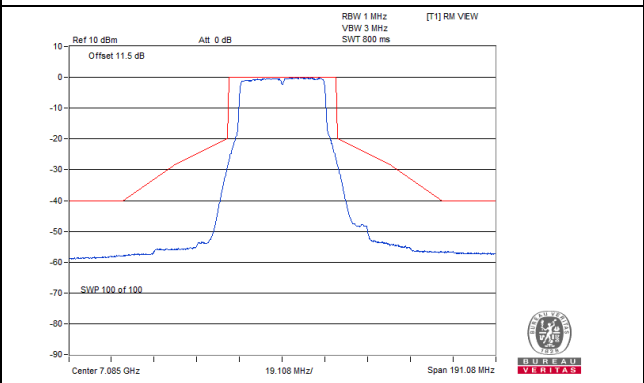

802.11ax (HE40)_Chain 1

Spectrum Plot

CH 3

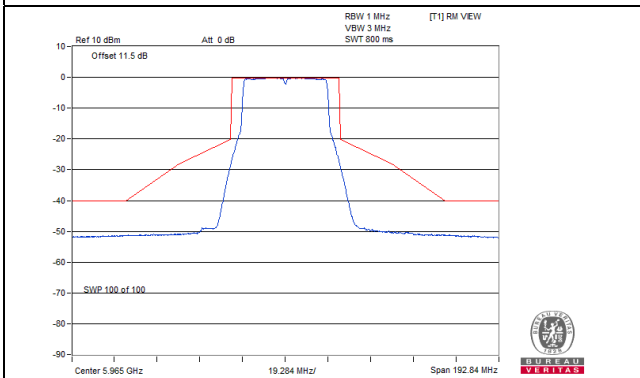

CH 43

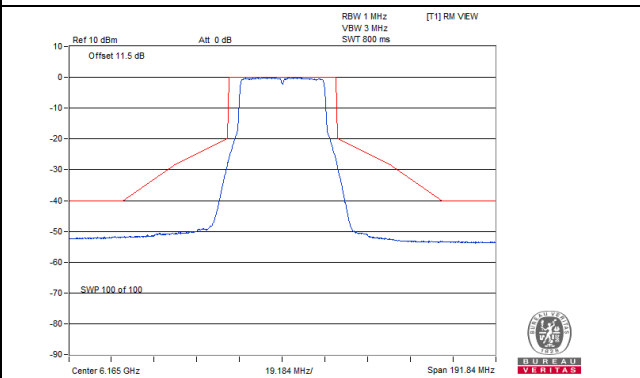

CH 91

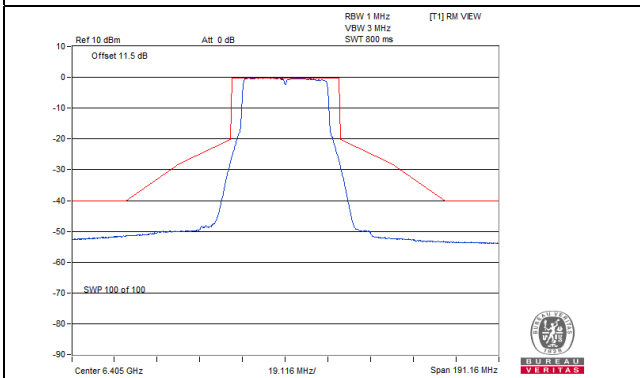

CH 99

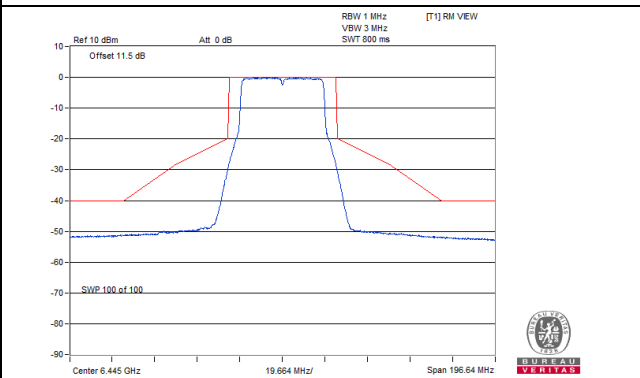

CH 107

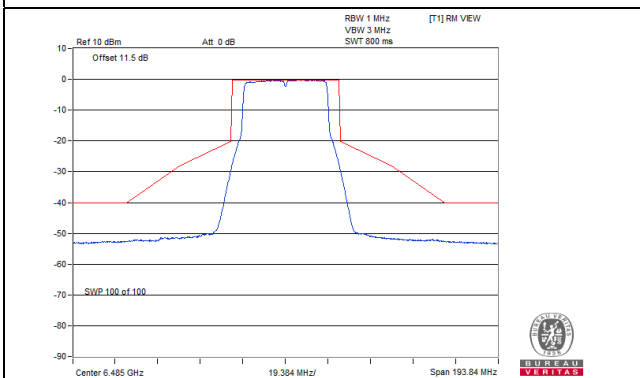

CH 115

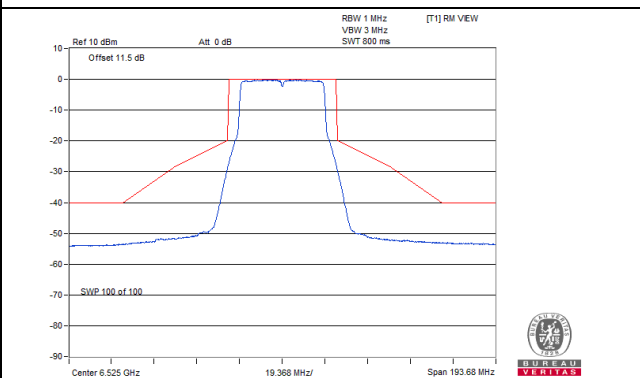

CH 123

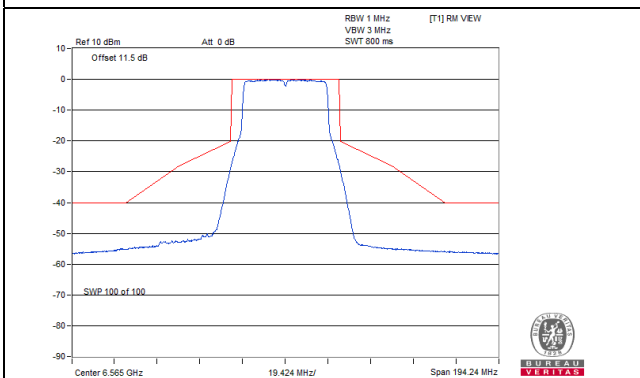

CH 155

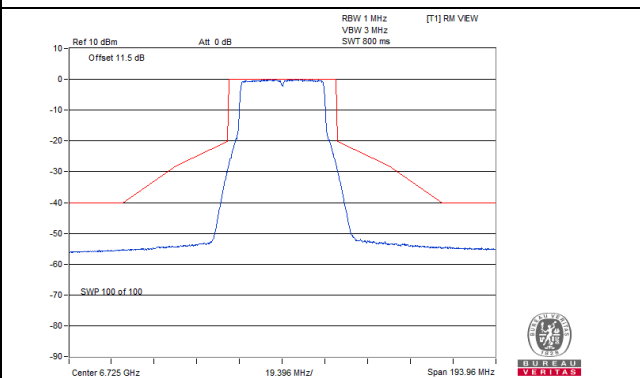

Spectrum Plot

CH 179

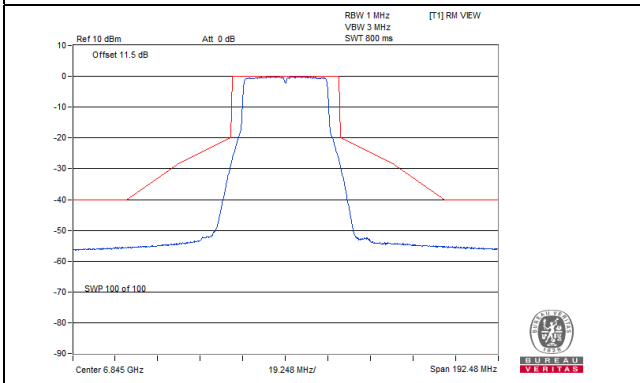

CH 187

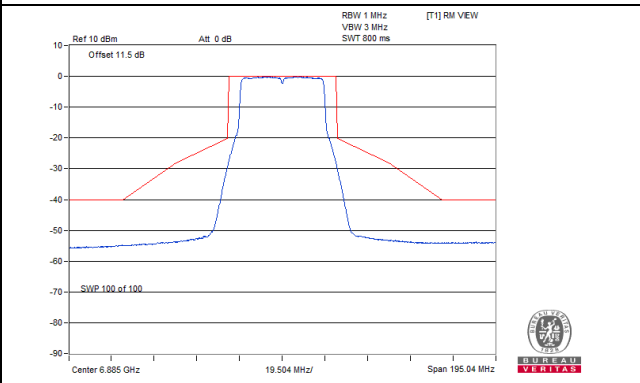

CH 211

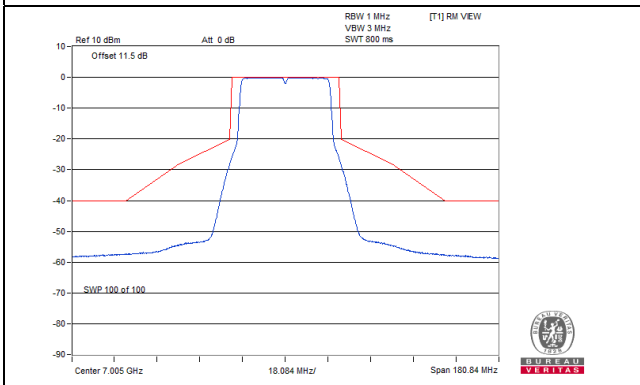

CH 227

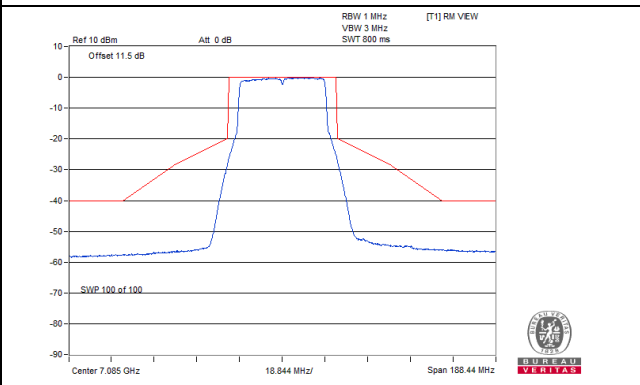

802.11ax (HE80)_Chain 0

Spectrum Plot

CH 7

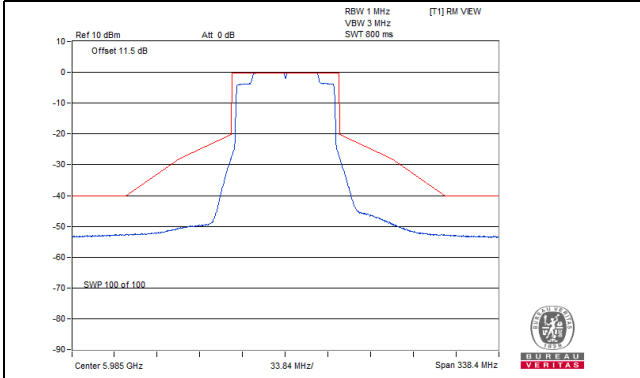

CH 39

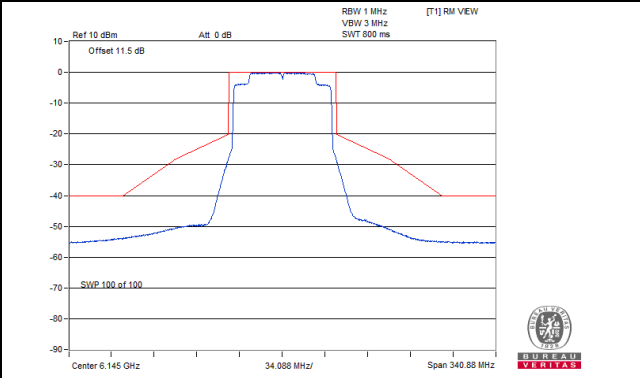

CH 87

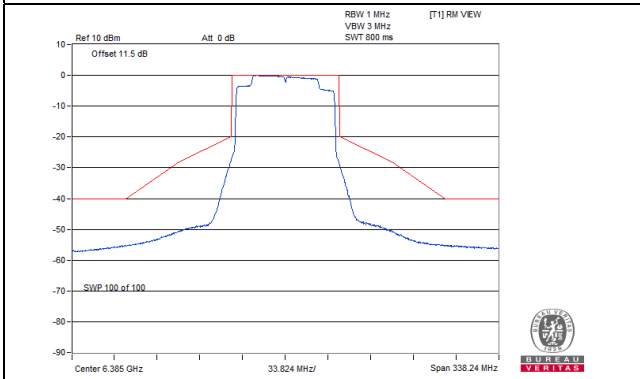

CH 103

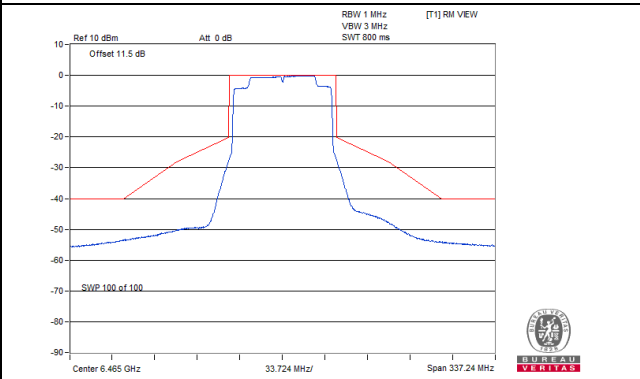

CH 119

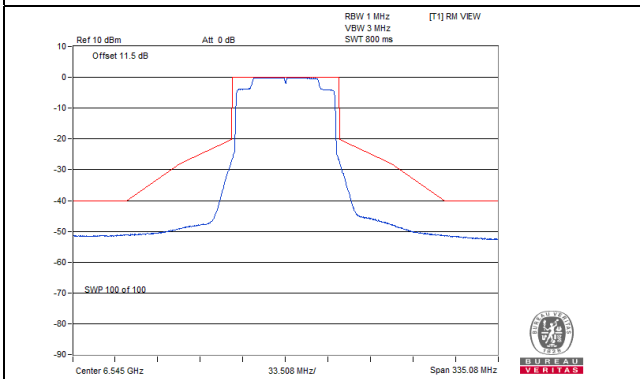

CH 151

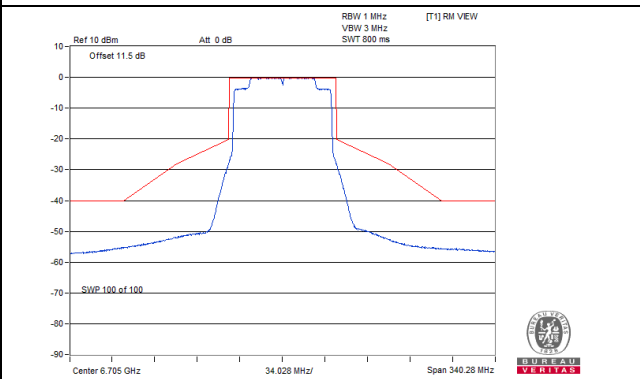

CH 183

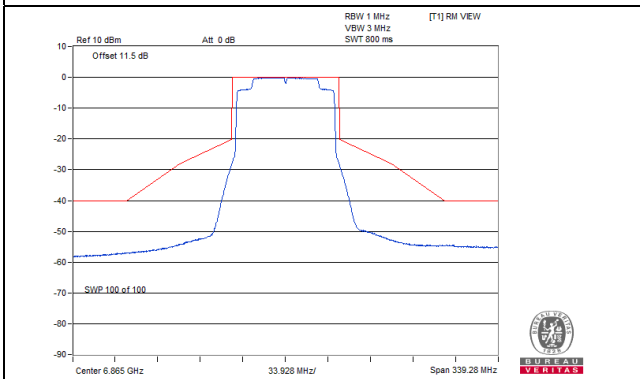

CH 199

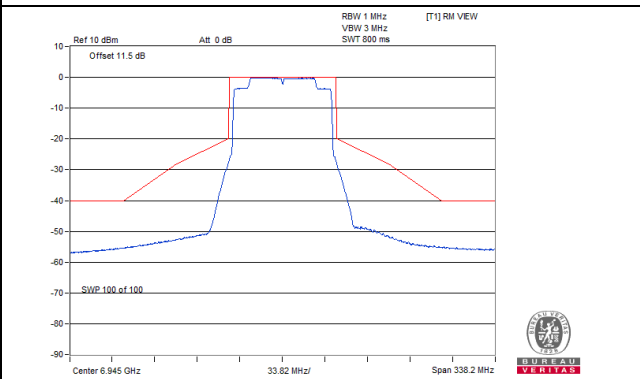

Spectrum Plot

CH 215

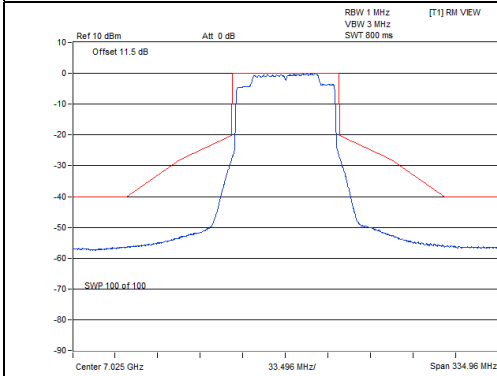

802.11ax (HE80)_Chain 1

Spectrum Plot

CH 7

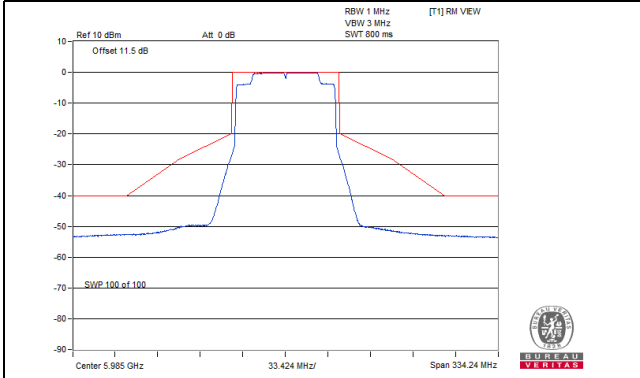

CH 39

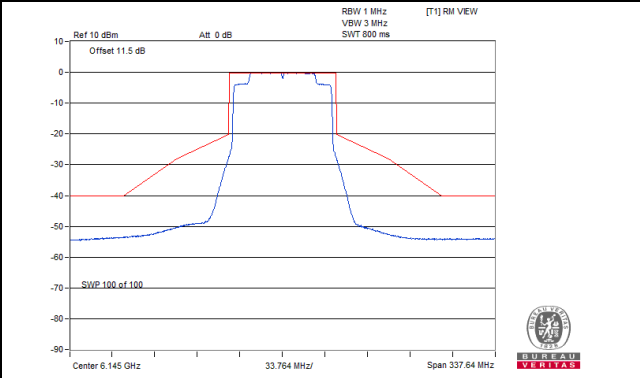

CH 87

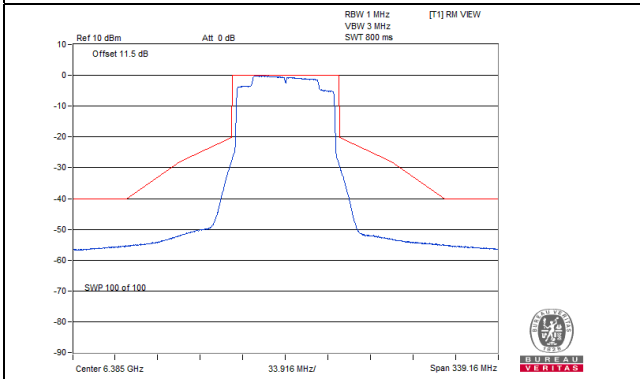

CH 103

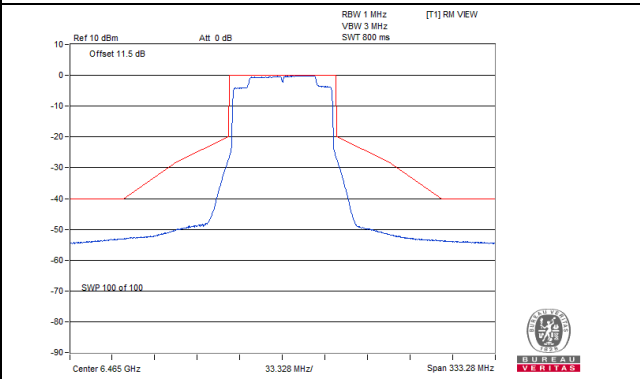

CH 119

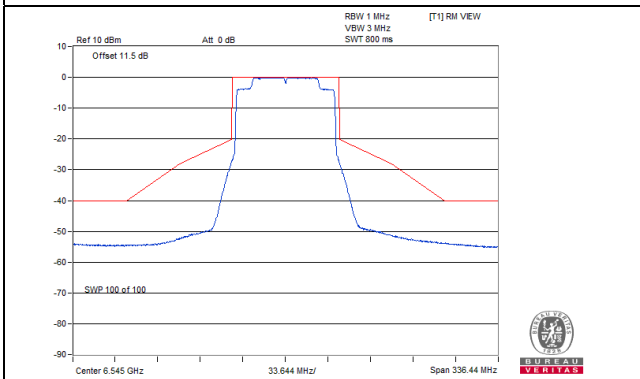

CH 151

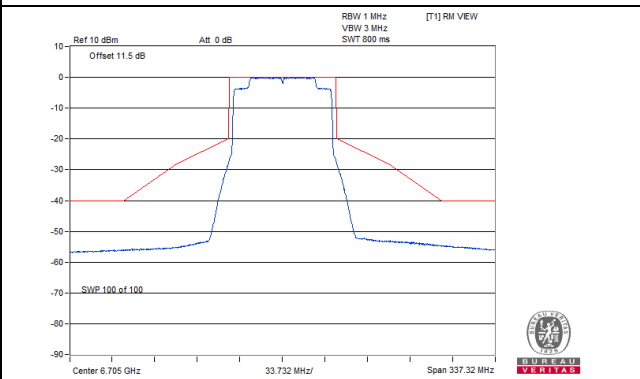

CH 183

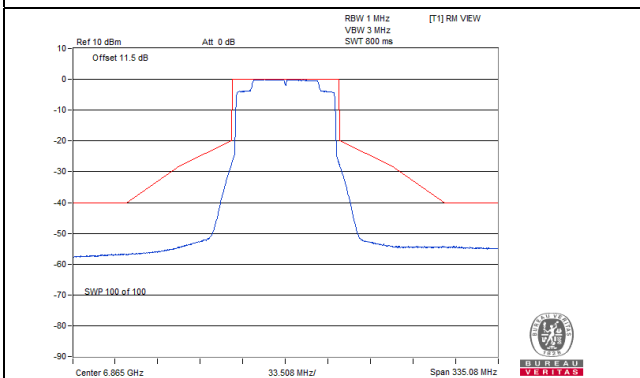

CH 199

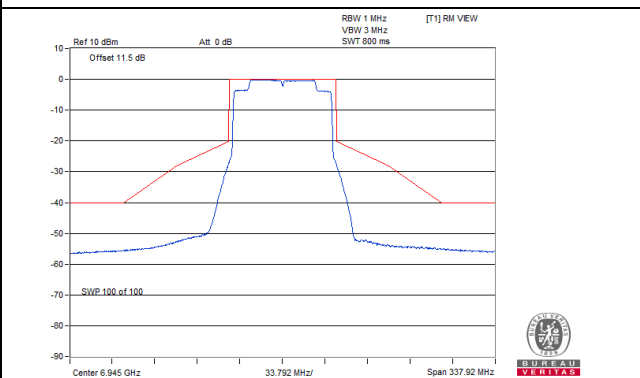

Spectrum Plot

CH 215

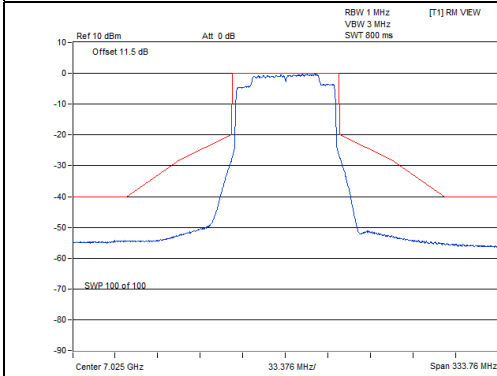

802.11ax (HE160)_Chain 0

Spectrum Plot

CH 15

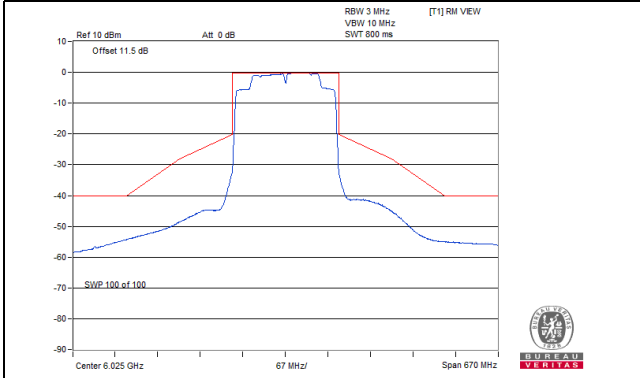

CH 47

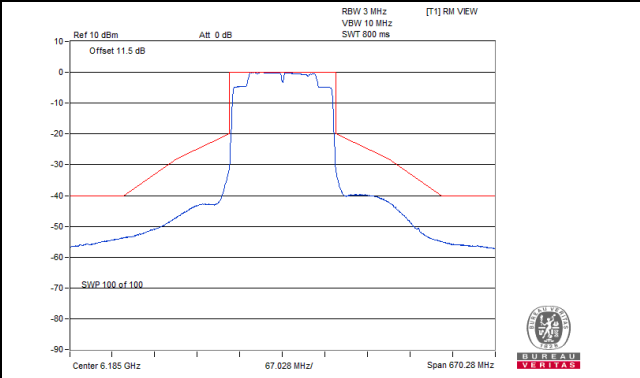

CH 79

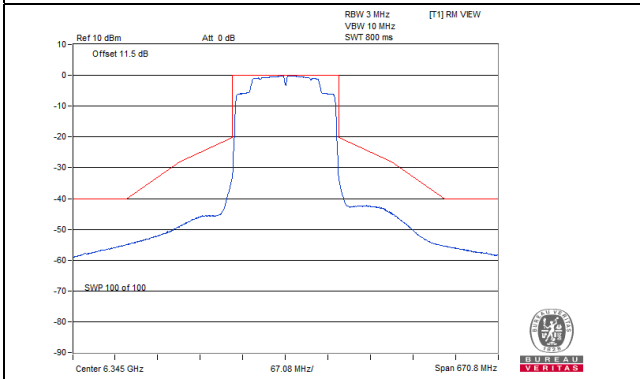

CH 111

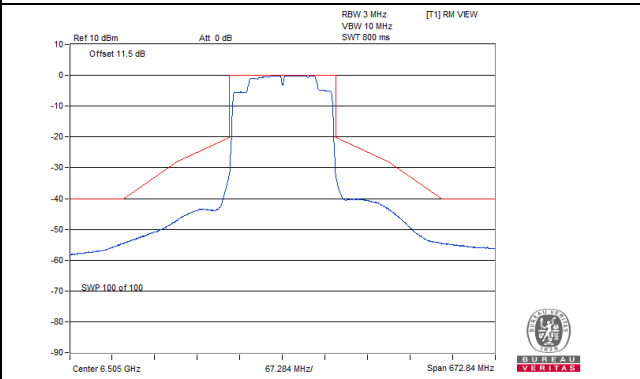

CH 143

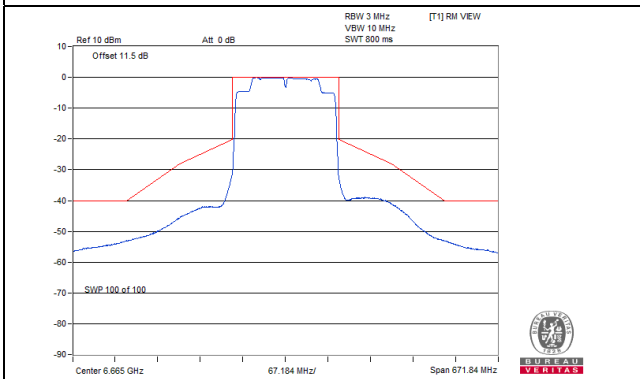

CH 175

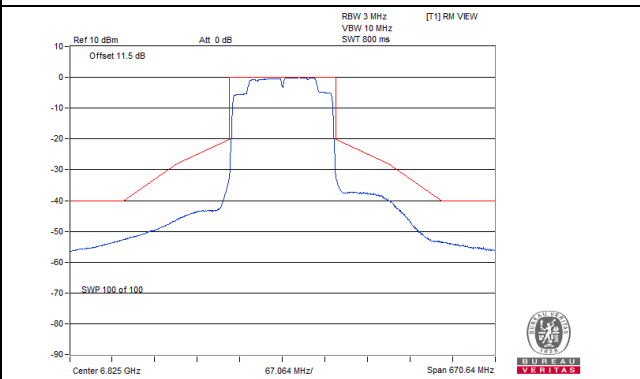

CH 207

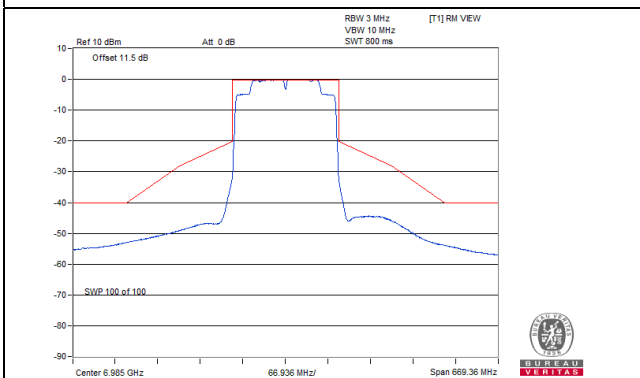

802.11ax (HE160)_Chain 1

Spectrum Plot

CH 15

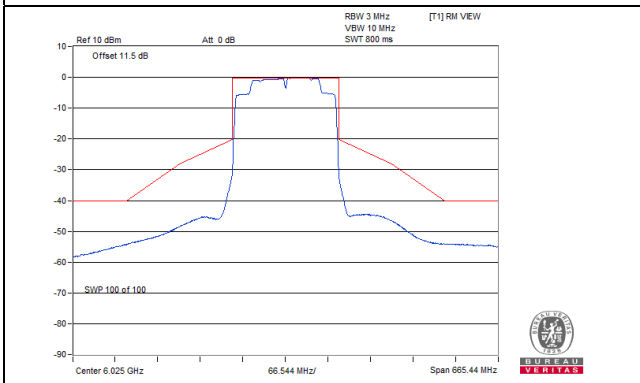

CH 47

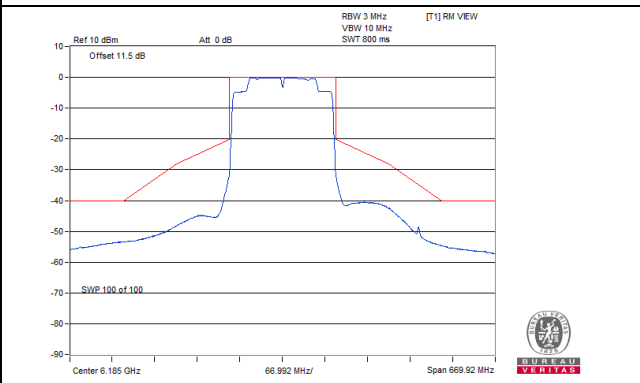

CH 79

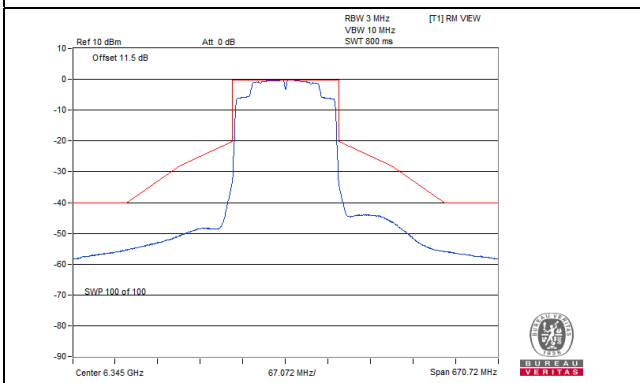

CH 111

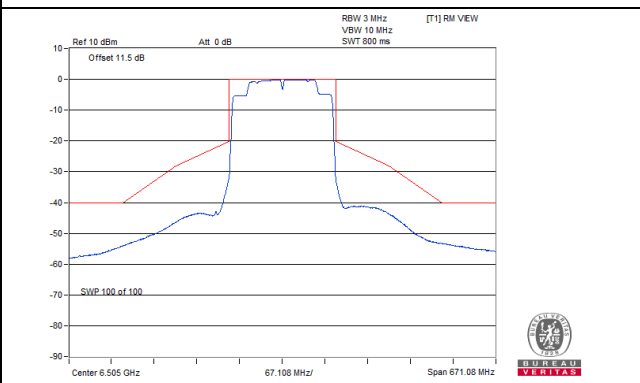

CH 143

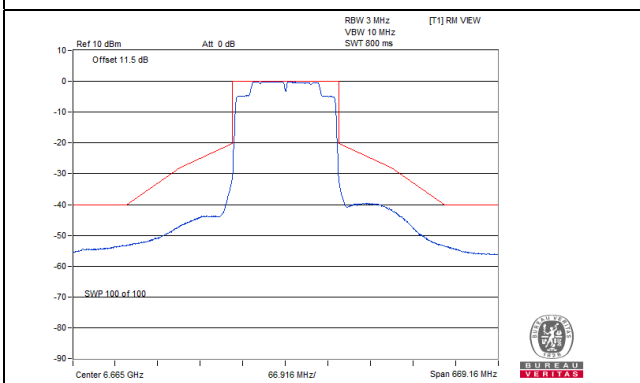

CH 175

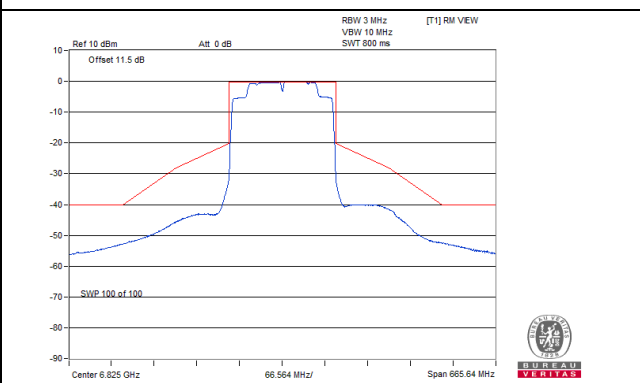

CH 207

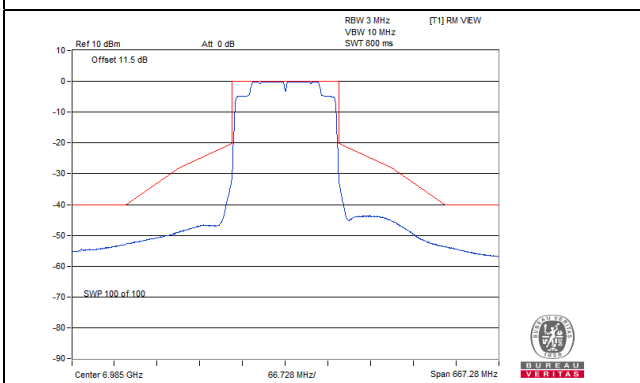

4.3 Conducted Emission Measurement

4.3.1 Limits of Conducted Emission Measurement

Frequency (MHz)	Conducted Limit (dBuV)	
	Quasi-peak	Average
0.15 - 0.5	66 - 56	56 - 46
0.50 - 5.0	56	46
5.0 - 30.0	60	50

Note: 1. The lower limit shall apply at the transition frequencies.
 2. The limit decreases in line with the logarithm of the frequency in the range of 0.15 to 0.50MHz.

4.3.2 Test Instruments

Description Manufacturer	Model No.	Serial No.	Calibrated Date	Calibrated Until
DC-LISN SCHWARZBECK MESS-ELETRONIK	NNBM 8126G	8126G-069	2021/11/10	2022/11/9
LISN R&S	ESH2-Z5	100100	2022/2/17	2023/2/16
LISN Schwarzbeck	NNLK 8121	8121-731	2022/5/26	2023/5/25
RF Coaxial Cable WORKEN	5D-FB	Cable-cond2-01	2022/9/3	2023/9/2
Software BVADT	BVADT_Cond_ V7.3.7.4	N/A	N/A	N/A
Temperature&Humidity Meter Lufft	5098.00	Lf11015	2022/1/7	2023/1/6
Test Receiver R&S	ESR3	102783	2021/12/20	2022/12/19
V-LISN Schwarzbeck	NNBL 8226-2	8226-142	2022/8/31	2023/8/30

Notes:
 1. The test was performed in HY - Conduction 2.
 2. Tested Date: 2022/10/28

4.3.3 Test Procedures

- The EUT was placed 0.4 meters from the conducting wall of the shielded room with EUT being connected to the power mains through a line impedance stabilization network (LISN). Other support units were connected to the power mains through another LISN. The two LISNs provide 50 ohm/ 50uH of coupling impedance for the measuring instrument.
- Both lines of the power mains connected to the EUT were checked for maximum conducted interference.
- The frequency range from 150kHz to 30MHz was searched. Emission levels under (Limit - 20dB) was not recorded.

Note: The resolution bandwidth and video bandwidth of test receiver is 9kHz for quasi-peak detection (QP) and average detection (AV) at frequency 0.15MHz-30MHz.

4.3.4 Deviation from Test Standard

No deviation.

4.3.5 Test Setup

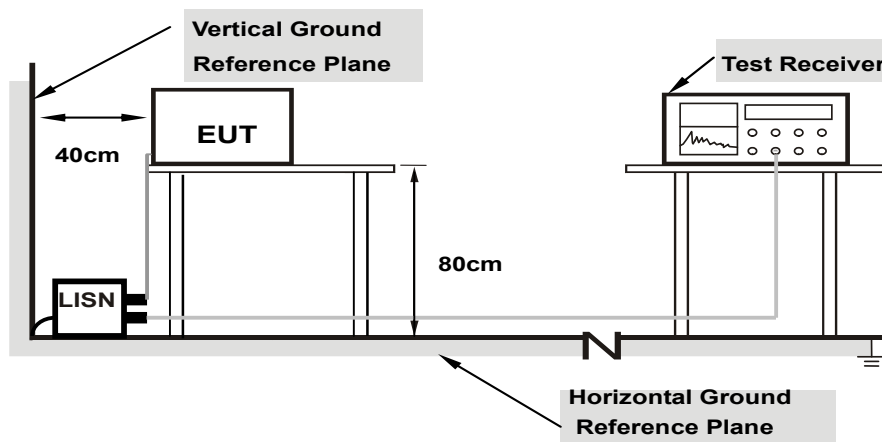

Note: 1.Support units were connected to second LISN.

For the actual test configuration, please refer to the attached file (Test Setup Photo).

4.3.6 EUT Operating Conditions

Same as 4.1.6.

4.3.7 Test Results

Worst-case data:

802.11ax (HE160)

Phase	Line (L)	Detector Function	Quasi-Peak (QP) / Average (AV)
-------	----------	-------------------	--------------------------------

No	Freq. [MHz]	Corr. Factor (dB)	Reading Value [dB (uV)]		Emission Level [dB (uV)]		Limit [dB (uV)]		Margin (dB)	
			Q.P.	AV.	Q.P.	AV.	Q.P.	AV.	Q.P.	AV.
			1	0.15000	10.19	51.64	34.79	61.83	44.98	66.00
2	0.16200	10.20	47.85	31.58	58.05	41.78	65.36	55.36	-7.31	-13.58
3	0.18200	10.21	42.33	20.60	52.54	30.81	64.39	54.39	-11.85	-23.58
4	0.20200	10.22	40.08	19.03	50.30	29.25	63.53	53.53	-13.23	-24.28
5	2.36600	10.35	27.28	21.29	37.63	31.64	56.00	46.00	-18.37	-14.36
6	11.57800	10.50	29.36	23.77	39.86	34.27	60.00	50.00	-20.14	-15.73

Remarks:

1. Q.P. and AV. are abbreviations of quasi-peak and average individually.
2. The emission levels of other frequencies were very low against the limit.
3. Margin value = Emission level - Limit value
4. Correction factor = Insertion loss + Cable loss
5. Emission Level = Correction Factor + Reading Value.

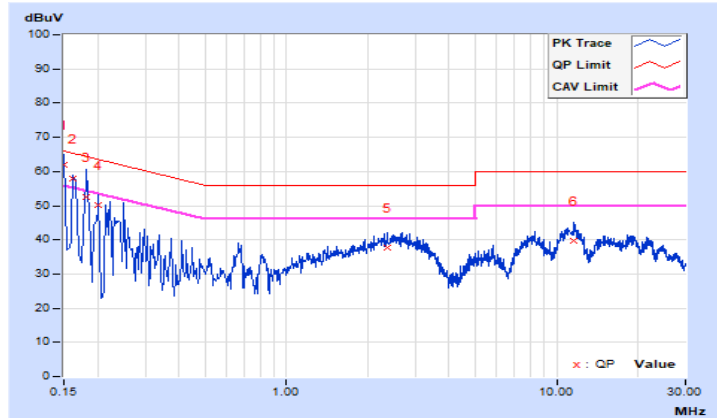

Phase	Neutral (N)	Detector Function	Quasi-Peak (QP) / Average (AV)
-------	-------------	-------------------	--------------------------------

No	Freq. [MHz]	Corr. Factor (dB)	Reading Value [dB (uV)]		Emission Level [dB (uV)]		Limit [dB (uV)]		Margin (dB)	
			Q.P.	AV.	Q.P.	AV.	Q.P.	AV.	Q.P.	AV.
			1	0.16190	10.19	44.89	34.29	55.08	44.48	65.37
2	0.17400	10.19	46.75	29.58	56.94	39.77	64.77	54.77	-7.83	-15.00
3	0.19400	10.21	38.70	20.11	48.91	30.32	63.86	53.86	-14.95	-23.54
4	0.21400	10.21	35.91	17.33	46.12	27.54	63.05	53.05	-16.93	-25.51
5	0.28200	10.23	30.27	13.04	40.50	23.27	60.76	50.76	-20.26	-27.49
6	14.17800	10.64	28.43	22.77	39.07	33.41	60.00	50.00	-20.93	-16.59

Remarks:

1. Q.P. and AV. are abbreviations of quasi-peak and average individually.
2. The emission levels of other frequencies were very low against the limit.
3. Margin value = Emission level - Limit value
4. Correction factor = Insertion loss + Cable loss
5. Emission Level = Correction Factor + Reading Value.

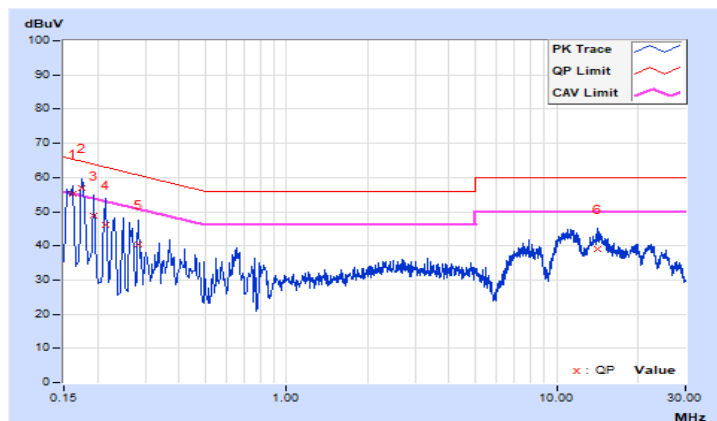

4.4 Transmit Power Measurement

4.4.1 Limits of Transmit Power Measurement

Operation Band	EUT Category	Limit
		Max Average Power
U-NII-5 U-NII-6 U-NII-7 U-NII-8	Client Devices (controlled of an indoor AP)	EIRP 24 dBm

Per KDB 662911 Method of conducted output power measurement on IEEE 802.11 devices,

- Array Gain = 0 dB (i.e., no array gain) for $N_{ANT} \leq 4$;
- Array Gain = 0 dB (i.e., no array gain) for channel widths ≥ 40 MHz for any N_{ANT} ;
- Array Gain = $5 \log(N_{ANT}/N_{SS})$ dB or 3 dB, whichever is less for 20-MHz channel widths with $N_{ANT} \geq 5$.

For power measurements on all other devices: Array Gain = $10 \log(N_{ANT}/N_{SS})$ dB.

4.4.2 Test Setup

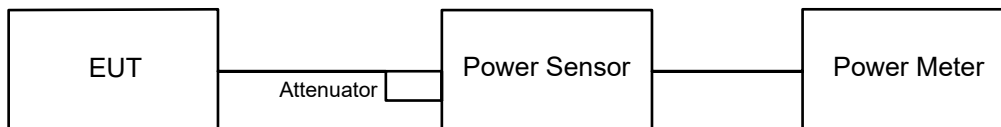

4.4.3 Test Instruments

Description Manufacturer	Model No.	Serial No.	Calibrated Date	Calibrated Until
Peak Power Analyzer KEYSIGHT	8990B	MY51000485	2022/1/18	2023/1/17
Power sensor Keysight	U2021XA	MY55380009	2022/3/23	2023/3/22
Software BV	ADT_RF Test Software V6.6.5.4	N/A	N/A	N/A
Spectrum Analyzer R&S	FSV40	100979	2022/3/25	2023/3/24
Wideband Power Sensor(N1923A) KEYSIGHT	N1923A	MY58020002	2022/1/17	2023/1/16

Notes:

1. The test was performed in Oven room.
2. Tested Date: 2022/11/17

4.4.4 Test Procedure

Method PM is used to perform output power measurement, trigger and gating function of wide band power meter is enabled to measure max output power of TX on burst. Duty factor is not added to measured value.

4.4.5 EUT Operating Conditions

The software provided by client to enable the EUT under transmission condition continuously at lowest, middle and highest channel frequencies individually.

4.4.6 Test Result

802.11ax (HE20)

Chan.	Chan. Freq. (MHz)	Average Power (dBm)		Total Power (mW)	Total Power (dBm)	Max. Gain (dBi)	EIRP (mW)	EIRP (dBm)	EIRP Limit (dBm)	Pass / Fail
		Chain 0	Chain 1							
1	5955	4.33	4.81	5.737	7.59	2.56	10.351	10.15	24.00	Pass
45	6175	3.98	4.62	5.398	7.32	2.56	9.727	9.88	24.00	Pass
93	6415	4.16	4.54	5.451	7.36	2.56	9.817	9.92	24.00	Pass
97	6435	4.04	4.70	5.486	7.39	1.97	8.63	9.36	24.00	Pass
105	6475	4.15	4.75	5.586	7.47	1.97	8.79	9.44	24.00	Pass
113	6515	4.15	4.70	5.551	7.44	1.97	8.73	9.41	24.00	Pass
117	6535	3.46	3.62	4.520	6.55	1.97	7.112	8.52	24.00	Pass
149	6695	3.34	3.79	4.551	6.58	1.97	7.161	8.55	24.00	Pass
181	6855	3.40	3.63	4.495	6.53	1.97	7.079	8.50	24.00	Pass
185	6875	3.38	3.62	4.479	6.51	1.97	7.047	8.48	24.00	Pass
209	6995	3.39	3.65	4.500	6.53	1.06	5.741	7.59	24.00	Pass
233	7115	1.69	1.95	3.042	4.83	1.06	3.882	5.89	24.00	Pass

802.11ax (HE40)

Chan.	Chan. Freq. (MHz)	Average Power (dBm)		Total Power (mW)	Total Power (dBm)	Max. Gain (dBi)	EIRP (mW)	EIRP (dBm)	EIRP Limit (dBm)	Pass / Fail
		Chain 0	Chain 1							
3	5965	7.55	7.75	11.645	10.66	2.56	20.989	13.22	24.00	Pass
43	6165	7.55	7.79	11.700	10.68	2.56	21.086	13.24	24.00	Pass
91	6405	7.48	7.65	11.419	10.58	2.56	20.606	13.14	24.00	Pass
99	6445	7.56	7.73	11.631	10.66	1.97	18.323	12.63	24.00	Pass
107	6485	7.56	7.67	11.550	10.63	1.97	18.197	12.60	24.00	Pass
115	6525	7.61	7.80	11.793	10.72	1.97	18.578	12.69	24.00	Pass
123	6565	7.59	7.78	11.739	10.70	1.97	18.493	12.67	24.00	Pass
155	6725	6.45	6.72	9.115	9.60	1.97	14.355	11.57	24.00	Pass
179	6845	6.51	6.58	9.027	9.56	1.97	14.223	11.53	24.00	Pass
187	6885	6.61	6.91	9.490	9.77	1.06	12.106	10.83	24.00	Pass
211	7005	6.63	6.74	9.323	9.70	1.06	11.912	10.76	24.00	Pass
227	7085	6.50	6.83	9.286	9.68	1.06	11.858	10.74	24.00	Pass

802.11ax (HE80)

Chan.	Chan. Freq. (MHz)	Average Power (dBm)		Total Power (mW)	Total Power (dBm)	Max. Gain (dBi)	EIRP (mW)	EIRP (dBm)	EIRP Limit (dBm)	Pass / Fail
		Chain 0	Chain 1							
7	5985	9.66	9.70	18.580	12.69	2.56	33.497	15.25	24.00	Pass
39	6145	9.61	9.69	18.452	12.66	2.56	33.266	15.22	24.00	Pass
87	6385	9.33	9.77	18.055	12.57	2.56	32.584	15.13	24.00	Pass
103	6465	9.46	9.81	18.403	12.65	1.97	28.973	14.62	24.00	Pass
119	6545	9.44	9.71	18.144	12.59	1.97	28.576	14.56	24.00	Pass
151	6705	9.42	9.86	18.433	12.66	1.97	29.040	14.63	24.00	Pass
183	6865	8.62	8.81	14.881	11.73	1.97	23.442	13.70	24.00	Pass
199	6945	8.48	8.55	14.208	11.53	1.06	18.155	12.59	24.00	Pass
215	7025	8.54	8.64	14.456	11.60	1.06	18.450	12.66	24.00	Pass

802.11ax (HE160)

Chan.	Chan. Freq. (MHz)	Average Power (dBm)		Total Power (mW)	Total Power (dBm)	Max. Gain (dBi)	EIRP (mW)	EIRP (dBm)	EIRP Limit (dBm)	Pass / Fail
		Chain 0	Chain 1							
15	6025	11.30	11.37	27.198	14.35	2.56	49.091	16.91	24.00	Pass
47	6185	11.41	11.39	27.608	14.41	2.56	49.774	16.97	24.00	Pass
79	6345	11.25	11.45	27.299	14.36	2.56	49.204	16.92	24.00	Pass
111	6505	11.25	11.44	27.267	14.36	1.97	42.954	16.33	24.00	Pass
143	6665	11.26	11.29	26.825	14.29	1.97	42.267	16.26	24.00	Pass
175	6825	11.27	11.45	27.36	14.37	1.97	43.053	16.34	24.00	Pass
207	6985	11.42	11.48	27.928	14.46	1.06	35.645	15.52	24.00	Pass

4.5 Emission Bandwidth Measurement

4.5.1 Test Setup

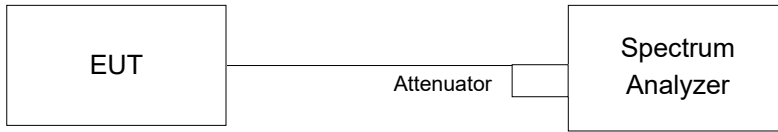

4.5.2 Test Instruments

Description Manufacturer	Model No.	Serial No.	Calibrated Date	Calibrated Until
Software BV	ADT_RF Test Software V6.6.5.4	N/A	N/A	N/A
Spectrum Analyzer R&S	FSV40	100979	2022/3/25	2023/3/24

Notes:

1. The test was performed in Oven room.
2. Tested Date: 2022/11/17

4.5.3 Test Procedure

For 99% Occupied Bandwidth

The transmitter output was connected to the spectrum analyzer through an attenuator. The bandwidth of the fundamental frequency was measured by spectrum analyzer with resolution bandwidth in the range of 1% to 5% of the anticipated emission bandwidth, and a video bandwidth at least 3x the resolution bandwidth and set the detector to sampling. The width of a frequency band such that, below the lower and above the upper frequency limits, the mean powers emitted are each equal to a specified percentage 0.5 %of the total mean power of a given emission.

For 26dB Bandwidth

- a. Set RBW = approximately 1% of the emission bandwidth.
- b. Set the VBW > RBW.
- c. Detector = Peak.
- d. Trace mode = max hold.
- e. Measure the maximum width of the emission that is 26 dB down from the peak of the emission. Compare this with the RBW setting of the analyzer. Readjust RBW and repeat measurement as needed until the RBW/EBW ratio is approximately 1%.

4.5.4 Test Result

99% Occupied Bandwidth

802.11ax (HE20)

Chan.	Freq. (MHz)	Occupied Bandwidth (MHz)		
		Chain 0	Chain 1	Limit (MHz)
1	5955	19.22	19.13	320
45	6175	19.20	19.20	320
93	6415	19.32	19.20	320
97	6435	19.20	19.20	320
105	6475	19.20	19.08	320
113	6515	19.20	19.20	320
117	6535	19.32	19.32	320
149	6695	19.08	19.32	320
181	6855	19.08	19.08	320
185	6875	19.08	19.08	320
209	6995	19.14	19.14	320
233	7115	19.13	19.20	320

802.11ax (HE40)

Chan.	Freq. (MHz)	Occupied Bandwidth (MHz)		
		Chain 0	Chain 1	Limit (MHz)
3	5965	39.13	38.26	320
43	6165	38.26	38.40	320
91	6405	38.16	38.40	320
99	6445	38.40	38.16	320
107	6485	38.40	38.40	320
115	6525	38.16	38.40	320
123	6565	38.16	38.64	320
155	6725	38.40	38.64	320
179	6845	38.16	38.16	320
187	6885	38.40	38.64	320
211	7005	38.28	38.28	320
227	7085	38.43	38.64	320

802.11ax (HE80)

Chan.	Freq. (MHz)	Occupied Bandwidth (MHz)		
		Chain 0	Chain 1	Limit (MHz)
7	5985	77.22	77.57	320
39	6145	76.80	76.80	320
87	6385	76.80	76.80	320
103	6465	76.80	77.28	320
119	6545	76.80	77.28	320
151	6705	76.80	77.28	320
183	6865	76.80	77.28	320
199	6945	76.32	76.80	320
215	7025	76.80	76.80	320

802.11ax (HE160)

Chan.	Freq. (MHz)	Occupied Bandwidth (MHz)		
		Chain 0	Chain 1	Limit (MHz)
15	6025	155.13	154.44	320
47	6185	155.52	155.52	320
79	6345	154.56	154.56	320
111	6505	155.52	155.52	320
143	6665	154.56	154.56	320
175	6825	155.52	155.13	320
207	6985	154.56	155.04	320

Spectrum Plot of Max. Value

802.11ax (HE20)_Chain 0 / CH 93 (U-NII-5 Band)

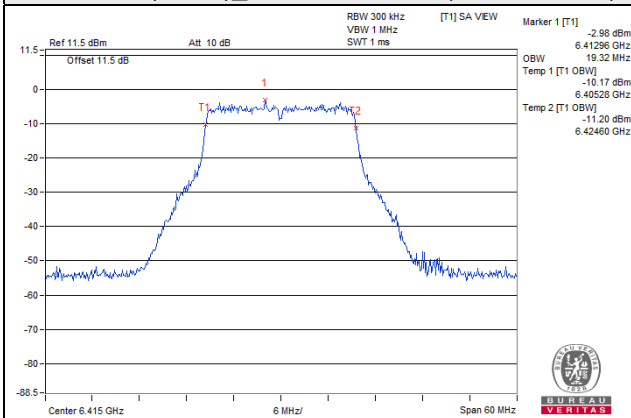

802.11ax (HE20)_Chain 0 / CH113 (U-NII-6 Band)

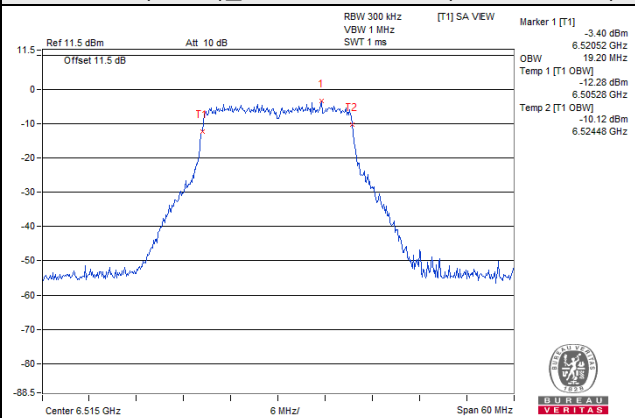

802.11ax (HE20)_Chain 0 / CH 117 (U-NII-7 Band)

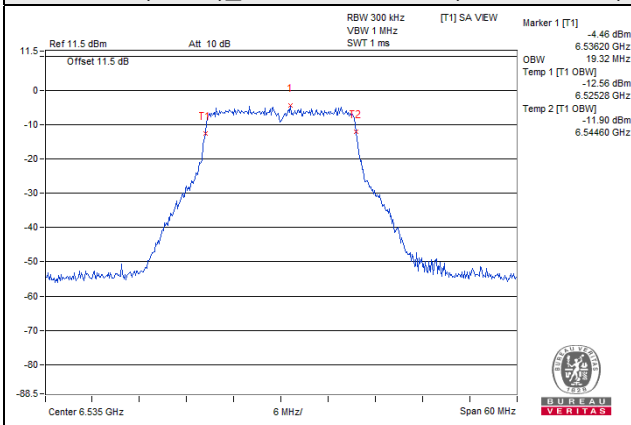

802.11ax (HE20)_Chain 1 / CH 233 (U-NII-8 Band)

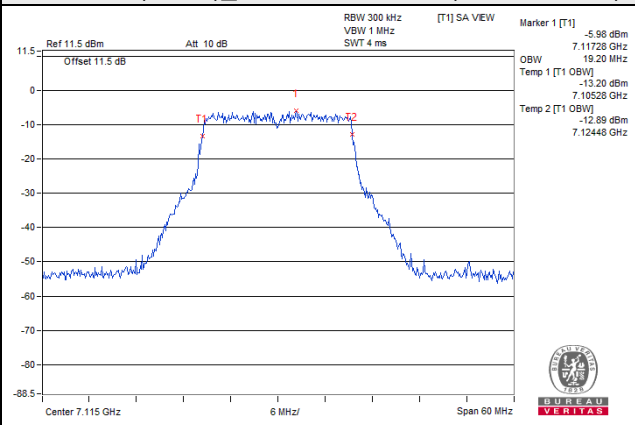

Spectrum Plot of Max. Value

802.11ax (HE40)_Chain 0 / CH 3 (U-NII-5 Band)

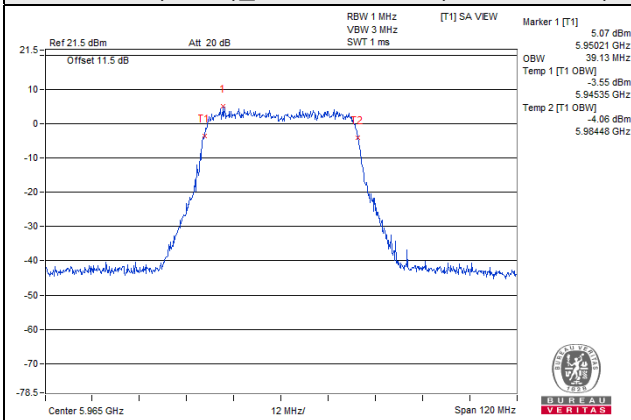

802.11ax (HE40)_Chain 0 / CH 107 (U-NII-6 Band)

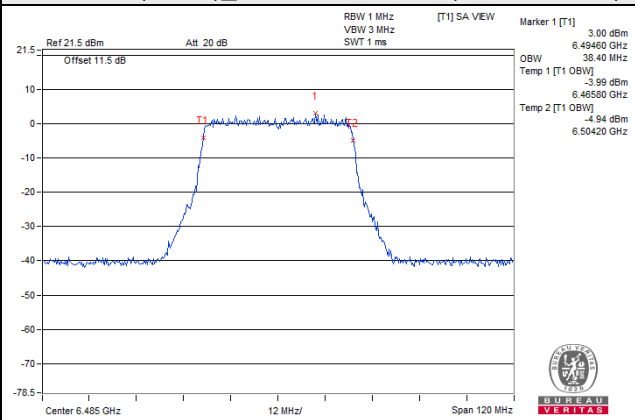

802.11ax (HE40)_Chain 1 / CH 155 (U-NII-7 Band)

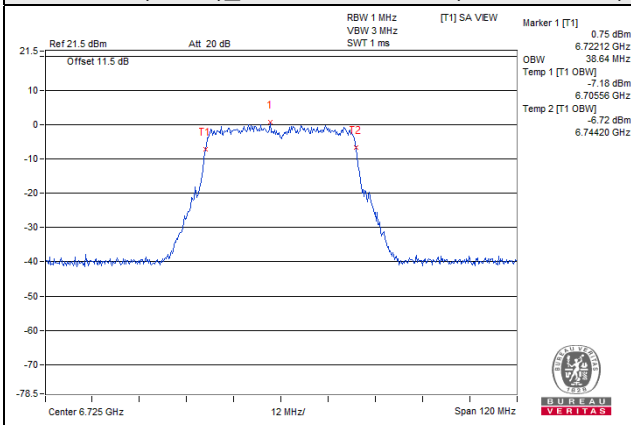

802.11ax (HE40)_Chain 1 / CH 227 (U-NII-8 Band)

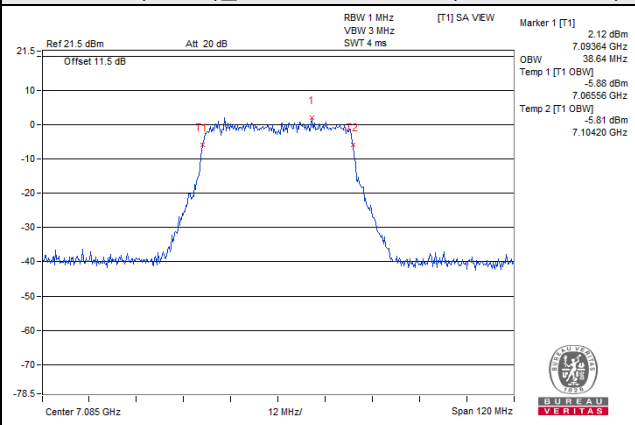

Spectrum Plot of Max. Value

802.11ax (HE80)_Chain 1 / CH 7 (U-NII-5 Band)

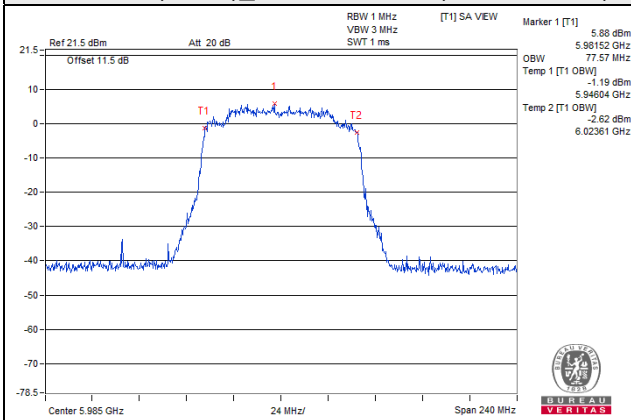

802.11ax (HE80)_Chain 1 / CH 103 (U-NII-6 Band)

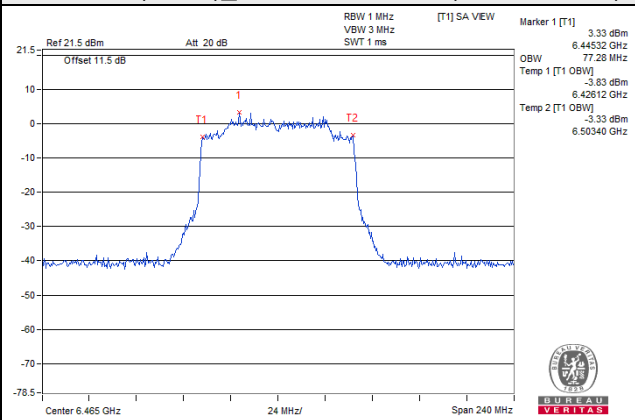

802.11ax (HE80)_Chain 1 / CH151 (U-NII-7 Band)

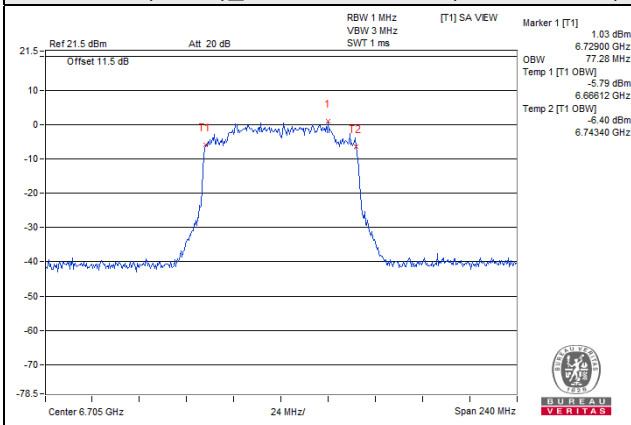

802.11ax (HE80)_Chain 1 / CH 215 (U-NII-8 Band)

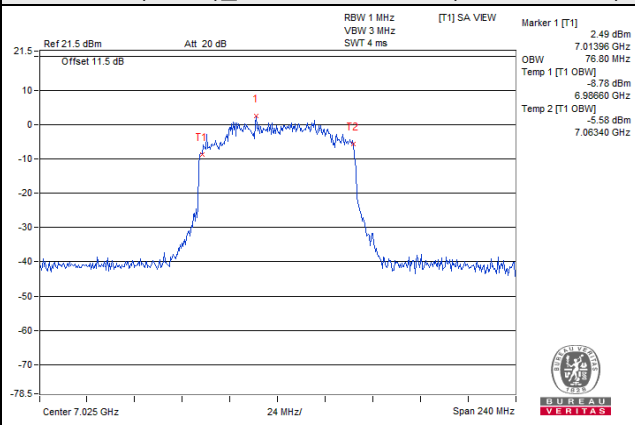

Spectrum Plot of Max. Value

802.11ax (HE160)_Chain 1 / CH 47 (U-NII-5 Band)

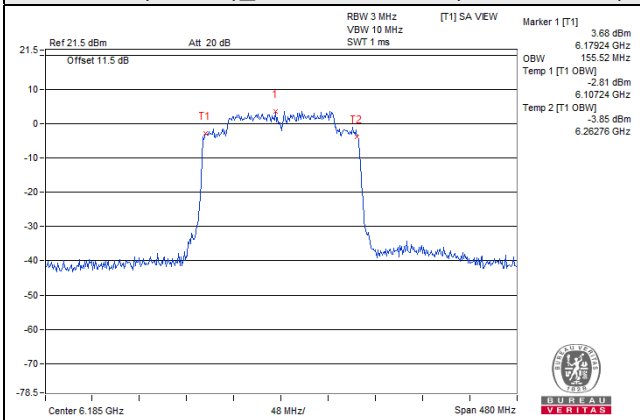

802.11ax (HE160)_Chain 1 / CH 111 (U-NII-6 Band)

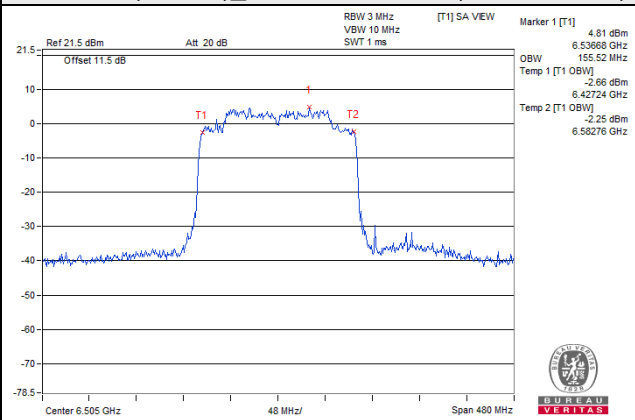

802.11ax (HE160)_Chain 0 / CH175 (U-NII-7 Band)

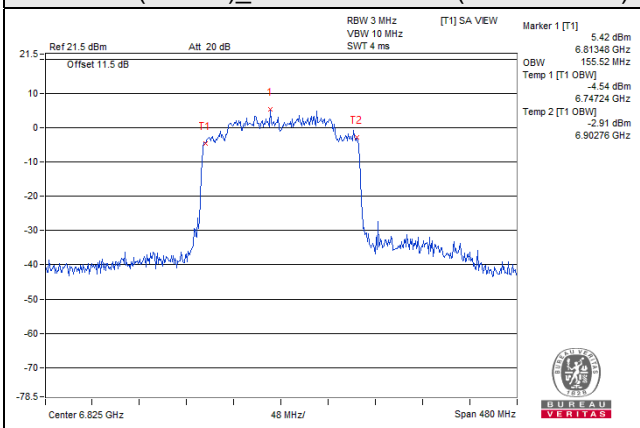

802.11ax (HE160)_Chain 1 / CH 207 (U-NII-8 Band)

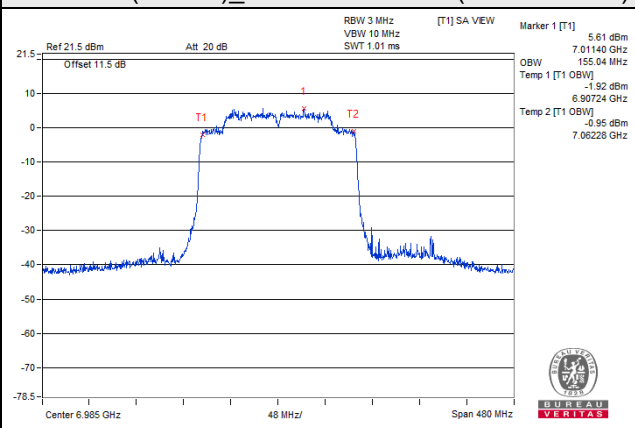

26dB Bandwidth

802.11ax (HE20)

Chan.	Freq. (MHz)	26dB Bandwidth (MHz)	
		Chain 0	Chain 1
1	5955	24.73	25.62
45	6175	25.15	25.11
93	6415	25.24	24.94
97	6435	25.61	24.63
105	6475	25.86	24.47
113	6515	25.22	25.12
117	6535	24.93	25.62
149	6695	25.81	25.15
181	6855	25.11	25.13
185	6875	25.11	25.58
209	6995	25.36	25.36
233	7115	25.71	25.75

802.11ax (HE40)

Chan.	Freq. (MHz)	26dB Bandwidth (MHz)	
		Chain 0	Chain 1
3	5965	46.25	48.21
43	6165	45.64	47.96
91	6405	46.11	47.79
99	6445	45.37	49.16
107	6485	46.40	48.46
115	6525	45.43	48.42
123	6565	45.56	48.56
155	6725	46.14	48.49
179	6845	45.56	48.12
187	6885	45.69	48.76
211	7005	46.49	45.21
227	7085	47.77	47.11

802.11ax (HE80)

Chan.	Freq. (MHz)	26dB Bandwidth (MHz)	
		Chain 0	Chain 1
7	5985	84.60	83.56
39	6145	85.22	84.41
87	6385	84.56	84.79
103	6465	84.31	83.32
119	6545	83.77	84.11
151	6705	85.07	84.33
183	6865	84.82	83.77
199	6945	84.55	84.48
215	7025	83.74	83.44

802.11ax (HE160)

Chan.	Freq. (MHz)	26dB Bandwidth (MHz)	
		Chain 0	Chain 1
15	6025	167.50	166.36
47	6185	167.57	167.48
79	6345	167.70	167.68
111	6505	168.21	167.77
143	6665	167.96	167.29
175	6825	167.66	166.41
207	6985	167.34	166.82

Spectrum Plot of Max. Value

802.11ax (HE20)_Chain 1 / CH 1 (U-NII-5 Band)

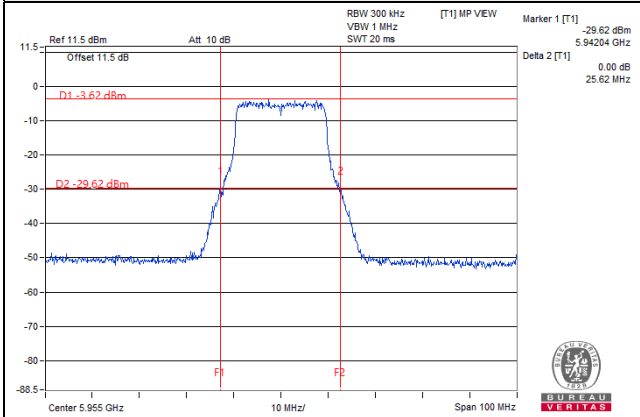

802.11ax (HE20)_Chain 0 / CH 105 (U-NII-6 Band)

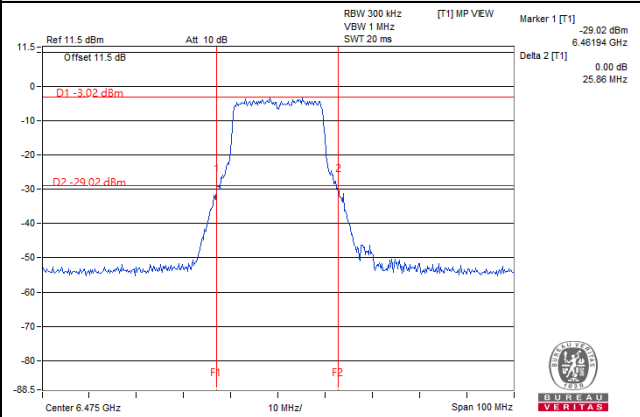

802.11ax (HE20)_Chain 0 / CH 149 (U-NII-7 Band)

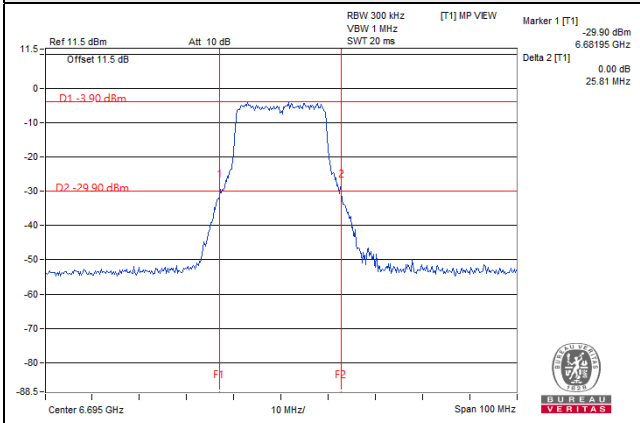

802.11ax (HE20)_Chain 1 / CH 233 (U-NII-8 Band)

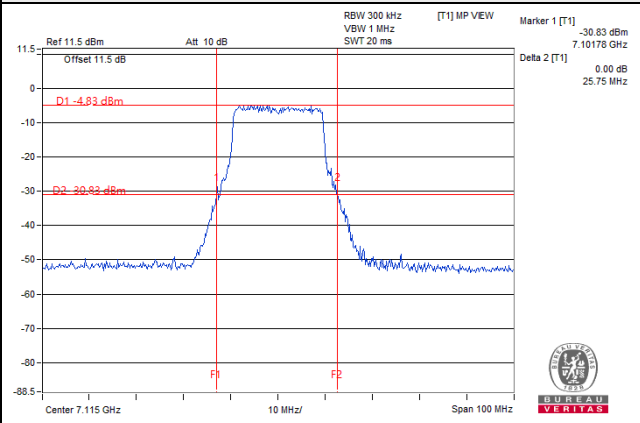

Spectrum Plot of Max. Value

802.11ax (HE40)_Chain 1 / CH 3 (U-NII-5 Band)

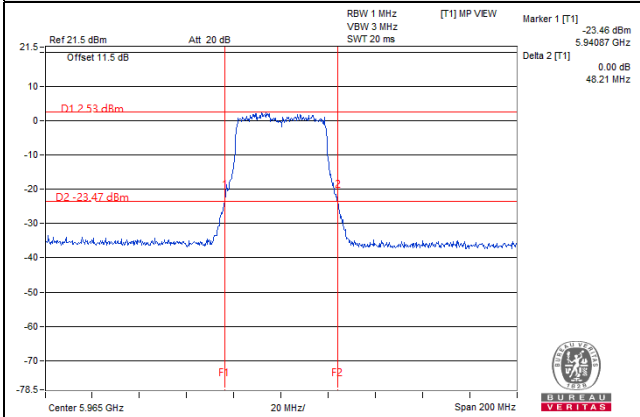

802.11ax (HE40)_Chain 1 / CH 99 (U-NII-6 Band)

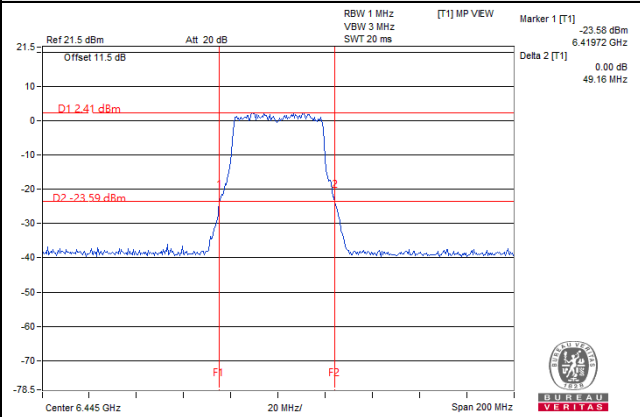

802.11ax (HE40)_Chain 1 / CH 123 (U-NII-7 Band)

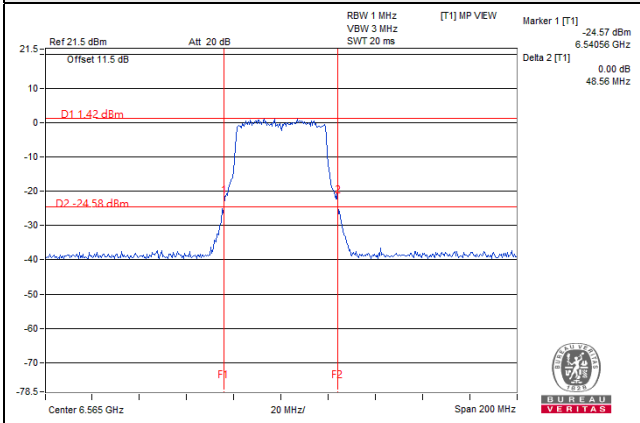

802.11ax (HE40)_Chain 1 / CH 187 (U-NII-8 Band)

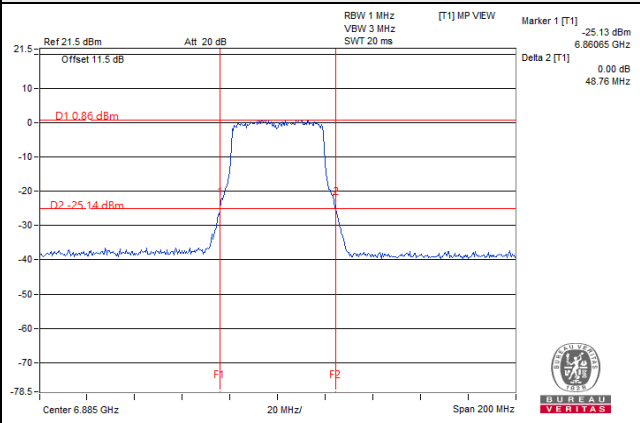

Spectrum Plot of Max. Value

802.11ax (HE80)_Chain 0 / CH 39 (U-NII-5 Band)

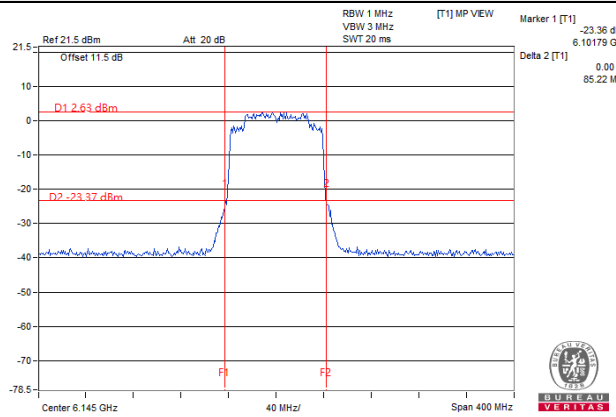

802.11ax (HE80)_Chain 0 / CH 103 (U-NII-6 Band)

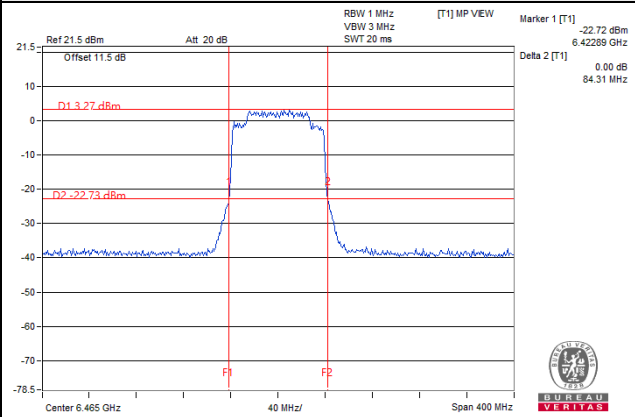

802.11ax (HE80)_Chain 0 / CH 151 (U-NII-7 Band)

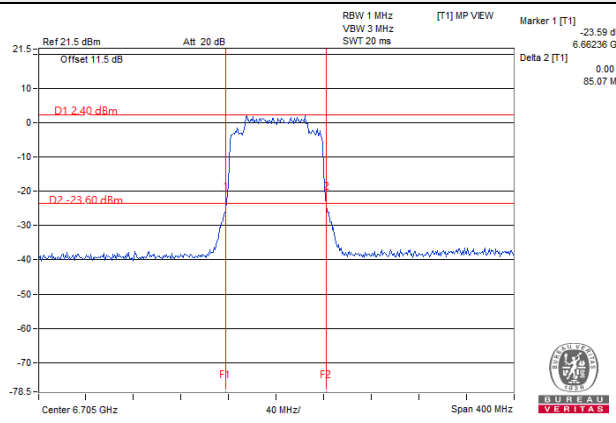

802.11ax (HE80)_Chain 0 / CH 199 (U-NII-8 Band)

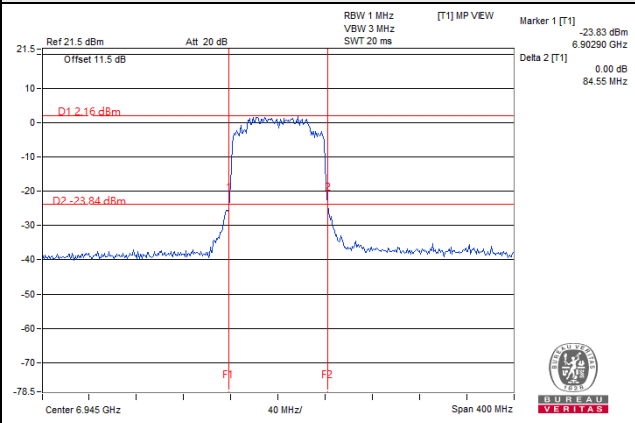

Spectrum Plot of Max. Value

802.11ax (HE160)_Chain 0 / CH 79 (U-NII-5 Band)

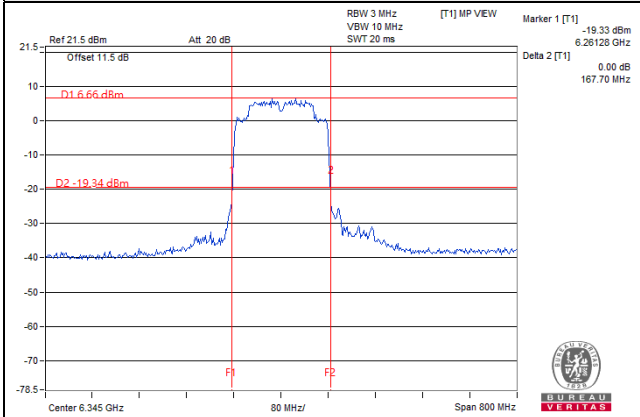

802.11ax (HE160)_Chain 0 / CH 111 (U-NII-6 Band)

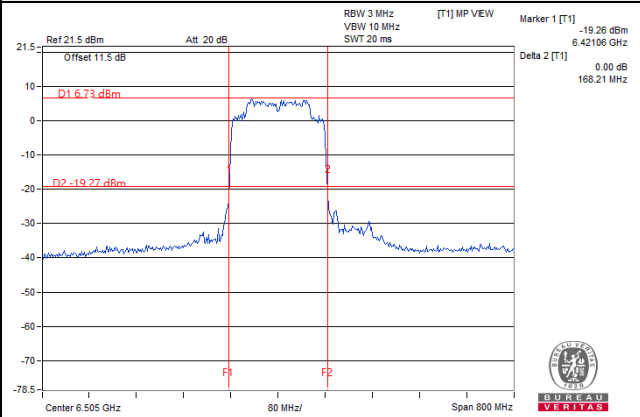

802.11ax (HE160)_Chain 0 / CH 173 (U-NII-7 Band)

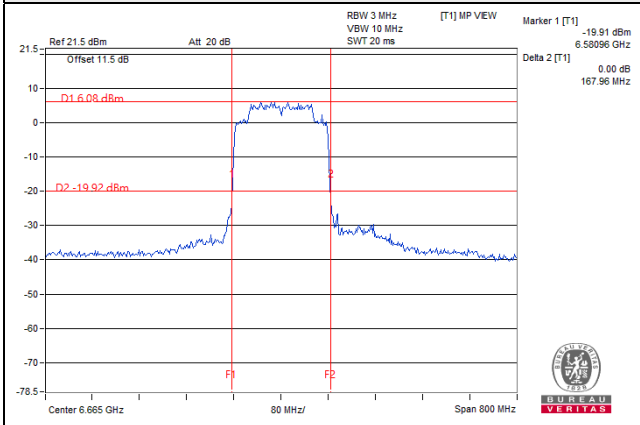

802.11ax (HE160)_Chain 0 / CH 207 (U-NII-8 Band)

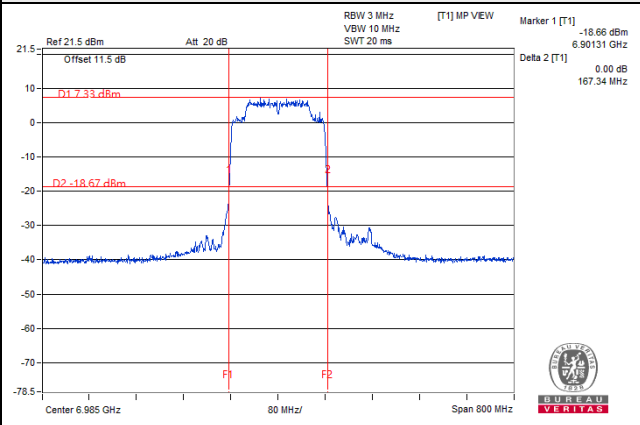

4.6 Peak Power Spectral Density Measurement

4.6.1 Limits of Peak Power Spectral Density Measurement

Operation Band	EUT Category	Limit
		Peak Power Density (EIRP)
U-NII-5 U-NII-6 U-NII-7 U-NII-8	Client Devices (controlled of an indoor AP)	-1 dBm/MHz

4.6.2 Test Setup

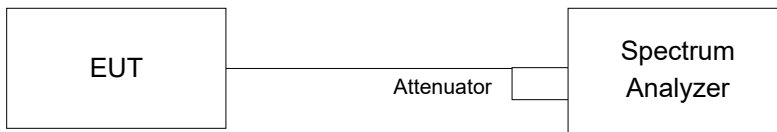

4.6.3 Test Instruments

Description Manufacturer	Model No.	Serial No.	Calibrated Date	Calibrated Until
Software BV	ADT_RF Test Software V6.6.5.4	N/A	N/A	N/A
Spectrum Analyzer R&S	FSV40	100979	2022/3/25	2023/3/24

Notes:

1. The test was performed in Oven room.
2. Tested Date: 2022/11/17

4.6.4 Test Procedures

Using method SA-1

- a. Set span to encompass the entire emission bandwidth (EBW) of the signal.
- b. Set RBW = 1 MHz, Set VBW \geq 3 MHz
- c. Number of points in sweep \geq $[2 \times \text{span} / \text{RBW}]$
- d. Sweep time = auto, trigger set to "free run".
- e. Detector = RMS
- f. Trace average at least 100 traces in power averaging mode.
- g. Record the max value

4.6.5 Deviation from Test Standard

No deviation.

4.6.6 EUT Operating Conditions

Same as 4.3.6.

4.6.7 Test Results

802.11ax (HE20)

Chan.	Chan. Freq. (MHz)	PSD w/o Duty Factor (dBm/MHz)		Total PSD (dBm/MHz)	Directional Gain (dBi)	EIRP PSD (dBm/MHz)	EIRP PSD Limit (dBm/MHz)	Pass / Fail
		Chain 0	Chain 1					
1	5955	-9.20	-9.07	-6.12	5.09	-1.03	-1.00	Pass
45	6175	-9.54	-8.92	-6.21	5.09	-1.12	-1.00	Pass
93	6415	-9.40	-9.00	-6.19	5.09	-1.10	-1.00	Pass
97	6435	-9.56	-8.84	-6.17	4.21	-1.96	-1.00	Pass
105	6475	-9.38	-8.81	-6.08	4.21	-1.87	-1.00	Pass
113	6515	-9.40	-8.88	-6.12	4.21	-1.91	-1.00	Pass
117	6535	-10.11	-9.90	-6.99	3.42	-3.57	-1.00	Pass
149	6695	-10.24	-9.82	-7.01	3.42	-3.59	-1.00	Pass
181	6855	-10.12	-9.95	-7.02	3.42	-3.60	-1.00	Pass
185	6875	-10.18	-9.95	-7.05	2.89	-4.16	-1.00	Pass
209	6995	-10.10	-9.83	-6.95	2.89	-4.06	-1.00	Pass
233	7115	-11.76	-11.66	-8.70	2.89	-5.81	-1.00	Pass

Note:

- Method E) 2) a) of power density measurement of KDB 662911 is using for calculating total power density. Total power density is summing entire spectra across corresponding frequency bins on the various outputs by computer.
- Directional gain = gain of antenna element + 10 log (2 of TX antenna elements)
- For U-NII-5, The directional gain is 5.09dBi
- For U-NII-6, The directional gain is 4.21dBi
- For U-NII-7, The directional gain is 3.42dBi
- For U-NII-8, The directional gain is 2.89dBi

802.11ax (HE40)

Chan.	Chan. Freq. (MHz)	PSD w/o Duty Factor (dBm/MHz)		Total PSD (dBm/MHz)	Directional Gain (dBi)	EIRP PSD (dBm/MHz)	EIRP PSD Limit (dBm/MHz)	Pass / Fail
		Chain 0	Chain 1					
3	5965	-9.18	-9.11	-6.13	5.09	-1.04	-1.00	Pass
43	6165	-9.21	-9.06	-6.12	5.09	-1.03	-1.00	Pass
91	6405	-9.32	-9.09	-6.19	5.09	-1.10	-1.00	Pass
99	6445	-9.02	-8.83	-5.91	4.21	-1.70	-1.00	Pass
107	6485	-8.93	-8.88	-5.89	4.21	-1.68	-1.00	Pass
115	6525	-8.96	-8.78	-5.86	3.42	-2.44	-1.00	Pass
123	6565	-9.03	-8.78	-5.89	3.42	-2.47	-1.00	Pass
155	6725	-10.07	-9.88	-6.96	3.42	-3.54	-1.00	Pass
179	6845	-10.02	-9.97	-6.98	3.42	-3.56	-1.00	Pass
187	6885	-9.94	-9.62	-6.77	2.89	-3.88	-1.00	Pass
211	7005	-9.90	-9.75	-6.81	2.89	-3.92	-1.00	Pass
227	7085	-10.09	-9.72	-6.89	2.89	-4.00	-1.00	Pass

Note:

- Method E) 2) a) of power density measurement of KDB 662911 is using for calculating total power density. Total power density is summing entire spectra across corresponding frequency bins on the various outputs by computer.
- Directional gain = gain of antenna element + 10 log (2 of TX antenna elements)
- For U-NII-5, The directional gain is 5.09dBi
- For U-NII-6, The directional gain is 4.21dBi
- For U-NII-7, The directional gain is 3.42dBi
- For U-NII-8, The directional gain is 2.89dBi

802.11ax (HE80)

Chan.	Chan. Freq. (MHz)	PSD w/o Duty Factor (dBm/MHz)		Total PSD (dBm/MHz)	Directional Gain (dBi)	EIRP PSD (dBm/MHz)	EIRP PSD Limit (dBm/MHz)	Pass / Fail
		Chain 0	Chain 1					
7	5985	-9.43	-9.38	-6.39	5.09	-1.30	-1.00	Pass
39	6145	-9.49	-9.37	-6.42	5.09	-1.33	-1.00	Pass
87	6385	-9.73	-9.19	-6.44	5.09	-1.35	-1.00	Pass
103	6465	-9.58	-9.23	-6.39	4.21	-2.18	-1.00	Pass
119	6545	-9.56	-9.26	-6.40	3.42	-2.98	-1.00	Pass
151	6705	-9.68	-9.24	-6.44	3.42	-3.02	-1.00	Pass
183	6865	-10.49	-10.21	-7.34	3.42	-3.92	-1.00	Pass
199	6945	-10.65	-10.46	-7.54	2.89	-4.65	-1.00	Pass
215	7025	-10.43	-10.43	-7.42	2.89	-4.53	-1.00	Pass

Note:

- Method E) 2) a) of power density measurement of KDB 662911 is using for calculating total power density. Total power density is summing entire spectra across corresponding frequency bins on the various outputs by computer.
- Directional gain = gain of antenna element + 10 log (2 of TX antenna elements)
- For U-NII-5, The directional gain is 5.09dBi
- For U-NII-6, The directional gain is 4.21dBi
- For U-NII-7, The directional gain is 3.42dBi
- For U-NII-8, The directional gain is 2.89dBi

802.11ax (HE160)

Chan.	Chan. Freq. (MHz)	PSD w/o Duty Factor (dBm/MHz)		Total PSD (dBm/MHz)	Directional Gain (dBi)	EIRP PSD (dBm/MHz)	EIRP PSD Limit (dBm/MHz)	Pass / Fail
		Chain 0	Chain 1					
15	6025	-10.75	-10.69	-7.71	5.09	-2.62	-1.00	Pass
47	6185	-10.64	-10.64	-7.63	5.09	-2.54	-1.00	Pass
79	6345	-10.87	-10.56	-7.70	5.09	-2.61	-1.00	Pass
111	6505	-10.77	-10.66	-7.70	4.21	-3.49	-1.00	Pass
143	6665	-10.78	-10.80	-7.78	3.42	-4.36	-1.00	Pass
175	6825	-10.64	-10.63	-7.62	3.42	-4.20	-1.00	Pass
207	6985	-10.55	-10.50	-7.51	2.89	-4.62	-1.00	Pass

Note:

- Method E) 2) a) of power density measurement of KDB 662911 is using for calculating total power density. Total power density is summing entire spectra across corresponding frequency bins on the various outputs by computer.
- Directional gain = gain of antenna element + 10 log (2 of TX antenna elements)
- For U-NII-5, The directional gain is 5.09dBi
- For U-NII-6, The directional gain is 4.21dBi
- For U-NII-7, The directional gain is 3.42dBi
- For U-NII-8, The directional gain is 2.89dBi

Spectrum Plot of Worst Value

802.11ax (HE20) / Chain 1 / CH 105

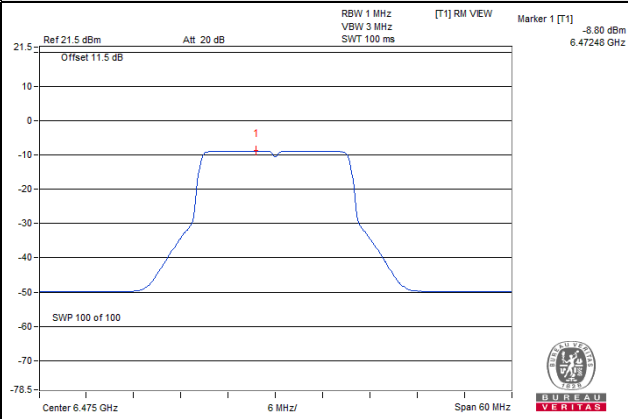

802.11ax (HE40) / Chain 1 / CH 123

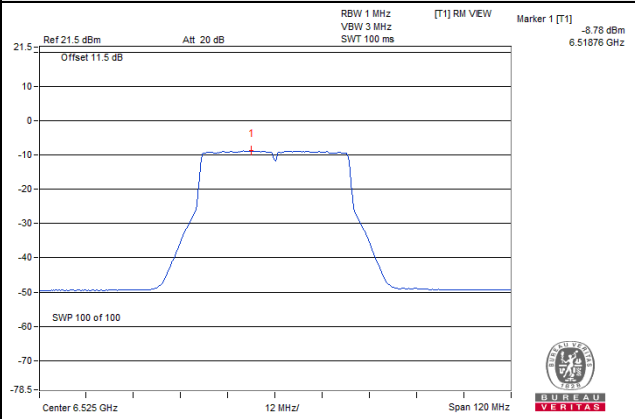

802.11ax (HE80) / Chain 1 / CH 87

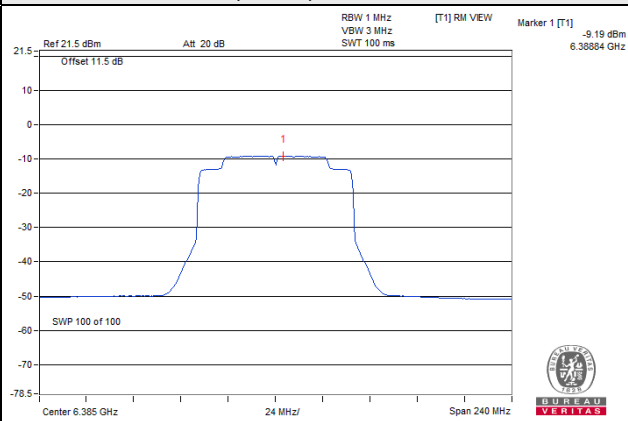

802.11ax (HE160) / Chain 1 / CH 207

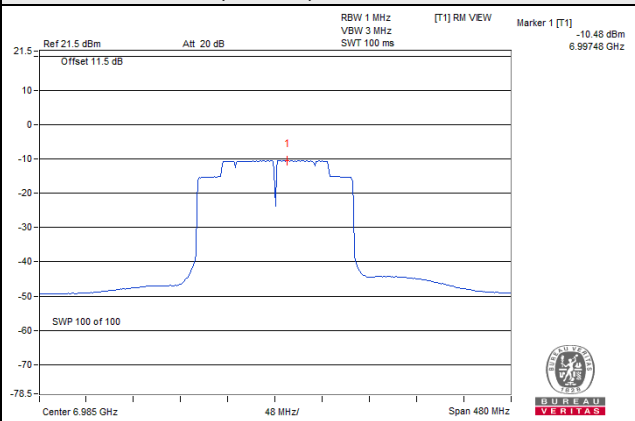

4.7 Contention Based Protocol Measurement

4.7.1 Limits of Contention Based Protocol Measurement

Unlicensed indoor low-power devices must detect co-channel radio frequency power that is at least -62 dBm (The threshold is referenced to a 0 dBi antenna gain.) or lower. Additionally, indoor low-power devices must detect co-channel energy with 90% or greater certainty.

4.7.2 Test Setup

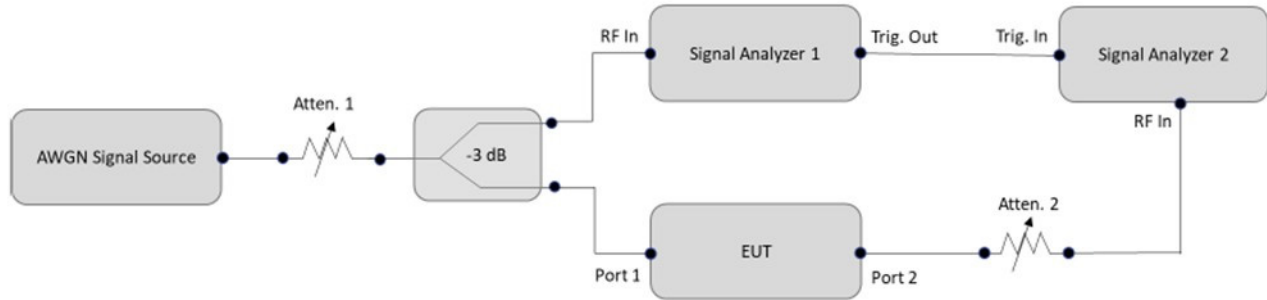

4.7.3 Test Instruments

Description Manufacturer	Model No.	Serial No.	Calibrated Date	Calibrated Until
Spectrum Analyzer R&S	FSW	102023	2022/11/8	2023/11/7
Spectrum Analyzer R&S	FSV40	101516	2022/3/7	2023/3/6
MXG X-Series RF Vector Signal Generator Agilent	N5182B	MY59100182	2022/4/26	2023/4/25
N5182BU KEYSIGHT	N5182BX07	MY59360203	2022/4/26	2023/4/25
Power Splitter/combiner Mini-Circuits	ZFRSC-123-S+	F698501347_01	2022/1/26	2023/1/25

Notes:

1. The test was performed in Oven room.
2. Tested Date: 2022/11/21 ~ 2022/11/22

4.7.4 Test Procedure

- a. Set the signal analyzer center frequency to the nominal EUT channel center frequency. The span range of the signal analyzer shall be between two times and five times the OBW of the EUT. Connect the output port of the EUT to the signal analyzer 2. Ensure that the attenuator 2 provides enough attenuation to not overload the signal analyzer 2 receiver.
- b. Monitoring the signal analyzer 2, verify the EUT is operating and transmitting with the parameters (set as following section 4.7.5 EUT operating condition).
- c. Determine number of times detection threshold test as following table,

If	Number of Tests	Placement of Incumbent Transmission
$BW_{EUT} \leq BW_{Inc}$	Once	Same as EUT transmission
$BW_{Inc} < BW_{EUT} \leq 2x BW_{Inc}$	Once	Contained within BW_{EUT}
$2x BW_{Inc} < BW_{EUT} \leq 4x BW_{Inc}$	Twice. (Incumbent transmission is contained within BW_{EUT})	Closely to the lower edge and upper edge of the EUT Channel
$BW_{EUT} > 4x BW_{Inc}$	Three times	Closely to the lower edge ,in the middle and upper edge of the EUT Channel

- d. Using an AWGN signal source, generate (but do not transmit, i.e., RF OFF) a 10 MHz-wide AWGN signal. Use step c table to determine the center frequency of the 10 MHz AWGN signal relative to the EUT's channel bandwidth and center frequency.
- e. Set the AWGN signal power to an extremely low level (more than 20 dB below the -62 dBm threshold). Connect the AWGN signal source, via a 3-dB splitter, to the signal analyzer 1 and the EUT.
- f. Transmit the AWGN signal (RF ON) and verify its characteristics on the signal analyzer 1.
- g. Monitor the signal analyzer 2 to verify if the AWGN signal has been detected and the EUT has ceased transmission. If the EUT continues to transmit, then incrementally increase the AWGN signal power level until the EUT stops transmitting.
- h. (Including all losses in the RF paths) Determine and record the AWGN signal power level (at the EUT's antenna port) at which the EUT ceased transmission. Repeat the procedure at least 10 times to verify the EUT can detect an AWGN signal with 90% (or better) level of certainty.
- i. Refer to step c table to determine number of times the detection threshold testing needs to be repeated. If testing is required more than once, then go back to step d, choose a different center frequency for the AWGN signal and repeat the process.

4.7.5 EUT Operating Condition

Set the EUT to transmit with a constant duty cycle and relative operating parameters which including power level, operating frequency, modulation and bandwidth.

4.7.6 Test Results

U-NII-5 Band:

Contention Based Protocol Measurement										
Operation Mode	Channel Bandwidth (MHz)	Channel Number	Channel Freq. (MHz)	Injected Signal (AWGN)		Antenna Gain (dBi)	Path Loss (dB)	Adjusted Power (dBi)	Detection Limit	EUT TX Status
				Freq. (MHz)	Power (dBm)					
802.11ax	20	45	6175	6175	-63	-0.08	0	-62.92	-62	OFF
					-73	-0.08	0	-72.92	-62	Minimal
					-83	-0.08	0	-82.92	-62	ON
	160	47	6185	6110	-63	-0.08	0	-62.92	-62	OFF
					-73	-0.08	0	-72.92	-62	Minimal
					-83	-0.08	0	-82.92	-62	ON
				6185	-63	-0.08	0	-62.92	-62	OFF
					-73	-0.08	0	-72.92	-62	Minimal
					-83	-0.08	0	-82.92	-62	ON
				6260	-63	-0.08	0	-62.92	-62	OFF
					-73	-0.08	0	-72.92	-62	Minimal
					-83	-0.08	0	-82.92	-62	ON

Note: Adjusted Power = Injected Signal (AWGN) Power - Antenna Gain + Path Loss

Contention Based Protocol Detection Probability															
Operation Mode	Channel Bandwidth (MHz)	AWGN Signal Freq. (MHz)	#01	#02	#03	#04	#05	#06	#07	#08	#09	#10	Detection Probability	Detection Limit	Test Result
802.11ax	20	6175	v	v	v	v	v	v	v	v	v	v	100%	90%	Pass
	160	6110	v	v	v	v	v	v	v	v	v	v	100%	90%	Pass
		6185	v	v	v	v	v	v	v	v	v	v	100%	90%	Pass
		6260	v	v	v	v	v	v	v	v	v	v	100%	90%	Pass

U-NII-6 Band:

Contention Based Protocol Measurement										
Operation Mode	Channel Bandwidth (MHz)	Channel Number	Channel Freq. (MHz)	Injected Signal (AWGN)		Antenna Gain (dBi)	Path Loss (dB)	Adjusted Power (dBi)	Detection Limit	EUT TX Status
				Freq. (MHz)	Power (dBm)					
802.11ax	20	105	6475	6475	-64	-1.63	0	-62.37	-62	OFF
					-71	-1.63	0	-69.37	-62	Minimal
					-84	-1.63	0	-82.37	-62	ON
	160	111	6505	6430	-64	-1.63	0	-62.37	-62	OFF
					-65	-1.63	0	-63.37	-62	Minimal
					-84	-1.63	0	-82.37	-62	ON
				6505	-64	-1.63	0	-62.37	-62	OFF
					-65	-1.63	0	-63.37	-62	Minimal
					-84	-1.63	0	-82.37	-62	ON
				6580	-64	-1.63	0	-62.37	-62	OFF
					-65	-1.63	0	-63.37	-62	Minimal
					-84	-1.63	0	-82.37	-62	ON

Note: Adjusted Power = Injected Signal (AWGN) Power - Antenna Gain + Path Loss

Contention Based Protocol Detection Probability															
Operation Mode	Channel Bandwidth (MHz)	AWGN Signal Freq. (MHz)	#01	#02	#03	#04	#05	#06	#07	#08	#09	#10	Detection Probability	Detection Limit	Test Result
802.11ax	20	6475	v	v	v	v	v	v	v	v	v	v	100%	90%	Pass
	160	6430	v	v	v	v	v	v	v	v	v	v	100%	90%	Pass
		6505	v	v	v	v	v	v	v	v	v	v	100%	90%	Pass
		6580	v	v	v	v	v	v	v	v	v	v	100%	90%	Pass

U-NII-7 Band:

Contention Based Protocol Measurement										
Operation Mode	Channel Bandwidth (MHz)	Channel Number	Channel Freq. (MHz)	Injected Signal (AWGN)		Antenna Gain (dBi)	Path Loss (dB)	Adjusted Power (dBi)	Detection Limit	EUT TX Status
				Freq. (MHz)	Power (dBm)					
802.11ax	20	149	6695	6695	-64	-1.8	0	-62.2	-62	OFF
					-71	-1.8	0	-69.2	-62	Minimal
					-84	-1.8	0	-82.2	-62	ON
	160	143	6665	6590	-64	-1.8	0	-62.2	-62	OFF
					-69	-1.8	0	-67.2	-62	Minimal
					-84	-1.8	0	-82.2	-62	ON
				6665	-64	-1.8	0	-62.2	-62	OFF
					-69	-1.8	0	-67.2	-62	Minimal
					-84	-1.8	0	-82.2	-62	ON
				6740	-64	-1.8	0	-62.2	-62	OFF
					-69	-1.8	0	-67.2	-62	Minimal
					-84	-1.8	0	-82.2	-62	ON

Note: Adjusted Power = Injected Signal (AWGN) Power - Antenna Gain + Path Loss

Contention Based Protocol Detection Probability															
Operation Mode	Channel Bandwidth (MHz)	AWGN Signal Freq. (MHz)	#01	#02	#03	#04	#05	#06	#07	#08	#09	#10	Detection Probability	Detection Limit	Test Result
802.11ax	20	6695	v	v	v	v	v	v	v	v	v	v	100%	90%	Pass
	160	6590	v	v	v	v	v	v	v	v	v	v	100%	90%	Pass
		6665	v	v	v	v	v	v	v	v	v	v	100%	90%	Pass
		6740	v	v	v	v	v	v	v	v	v	v	100%	90%	Pass

U-NII-8 Band:

Contention Based Protocol Measurement										
Operation Mode	Channel Bandwidth (MHz)	Channel Number	Channel Freq. (MHz)	Injected Signal (AWGN)		Antenna Gain (dBi)	Path Loss (dB)	Adjusted Power (dBi)	Detection Limit	EUT TX Status
				Freq. (MHz)	Power (dBm)					
802.11ax	20	209	6995	6995	-64	-1.85	0	-62.15	-62	OFF
					-69	-1.85	0	-67.15	-62	Minimal
					-84	-1.85	0	-82.15	-62	ON
	160	207	6985	6910	-64	-1.85	0	-62.15	-62	OFF
					-69	-1.85	0	-67.15	-62	Minimal
					-84	-1.85	0	-82.15	-62	ON
				6985	-64	-1.85	0	-62.15	-62	OFF
					-69	-1.85	0	-67.15	-62	Minimal
					-84	-1.85	0	-82.15	-62	ON
				7060	-64	-1.85	0	-62.15	-62	OFF
					-69	-1.85	0	-67.15	-62	Minimal
					-84	-1.85	0	-82.15	-62	ON

Note: Adjusted Power = Injected Signal (AWGN) Power - Antenna Gain + Path Loss

Contention Based Protocol Detection Probability															
Operation Mode	Channel Bandwidth (MHz)	AWGN Signal Freq. (MHz)	#01	#02	#03	#04	#05	#06	#07	#08	#09	#10	Detection Probability	Detection Limit	Test Result
802.11ax	20	6995	v	v	v	v	v	v	v	v	v	v	100%	90%	Pass
	160	6910	v	v	v	v	v	v	v	v	v	v	100%	90%	Pass
		6985	v	v	v	v	v	v	v	v	v	v	100%	90%	Pass
		7060	v	v	v	v	v	v	v	v	v	v	100%	90%	Pass

For U-NII-5 Band

Plots of EUT Tx waveform

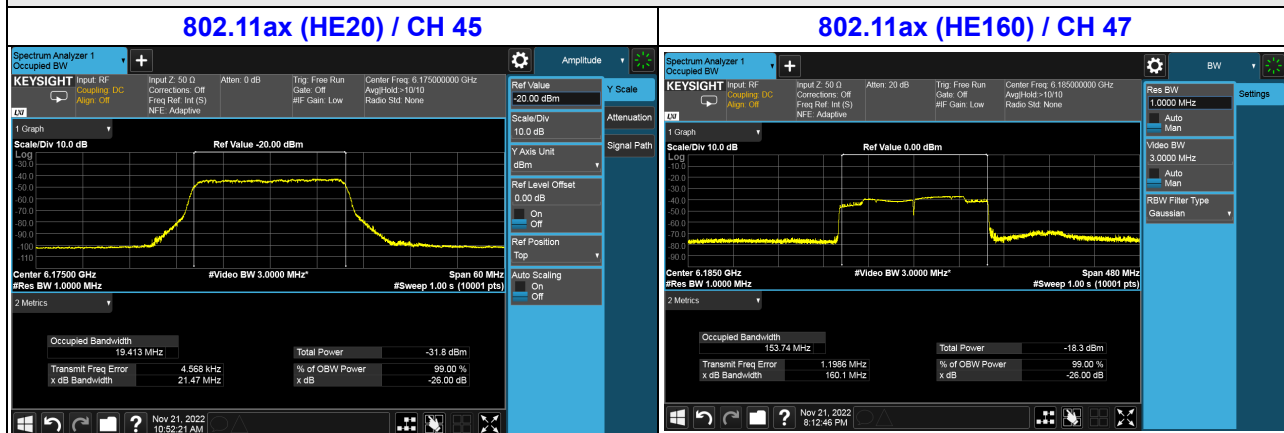

Plots of Incumbent signal (AWGN) Level

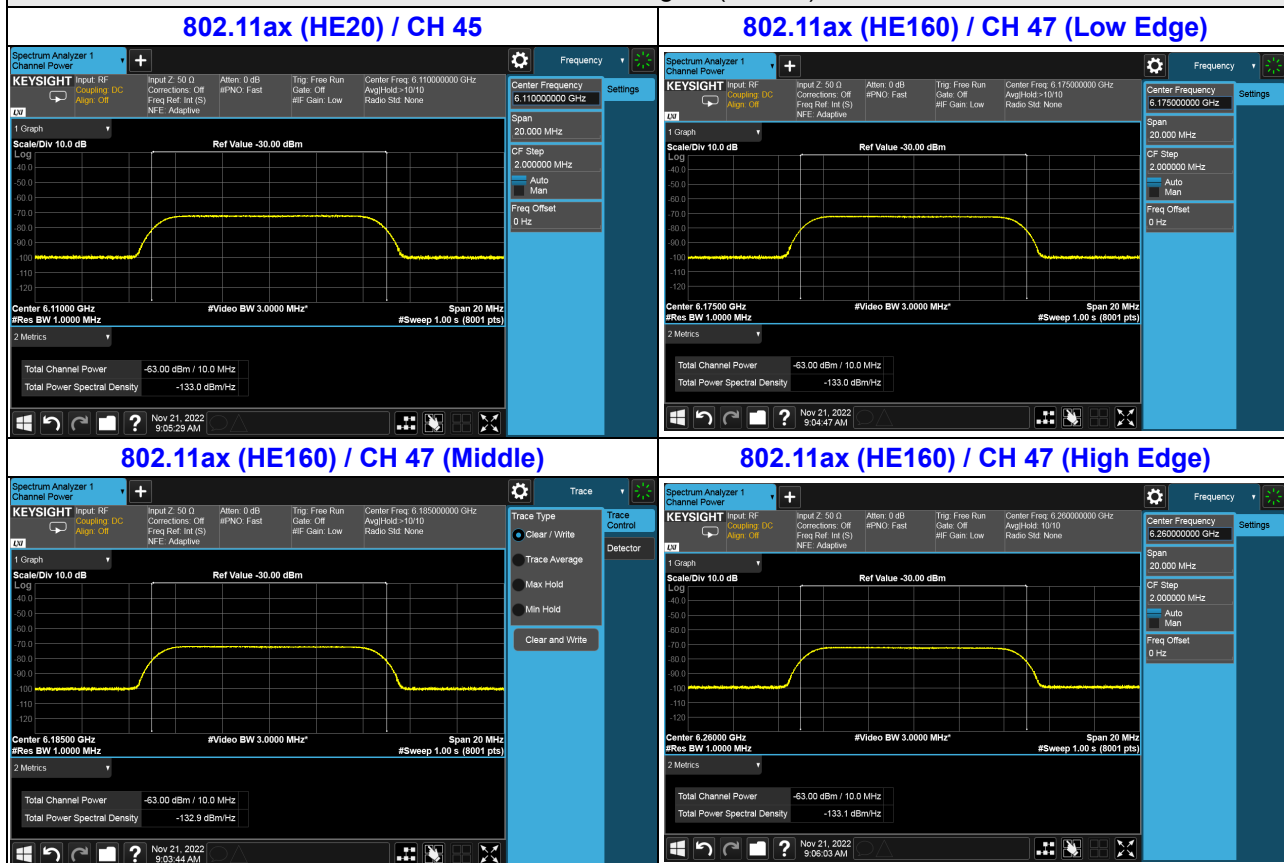

Plots of EUT ceased transmission in the time domain

802.11ax (HE20) / CH 45

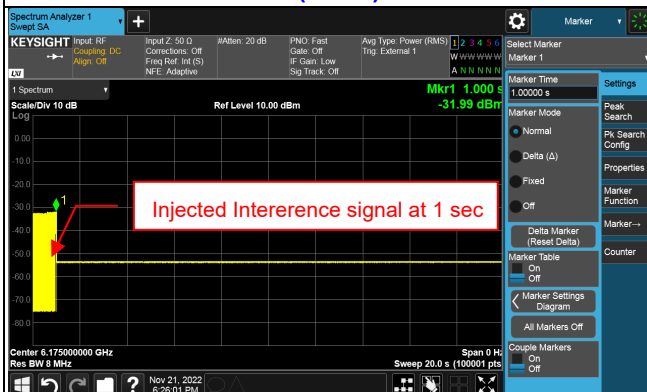

802.11ax (HE160) / CH 47 (Low Edge)

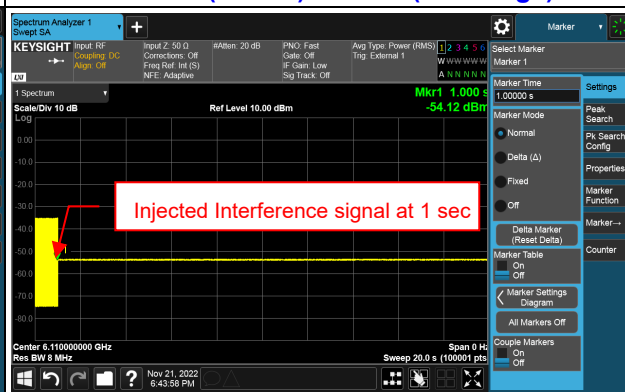

802.11ax (HE160) / CH 47 (Middle)

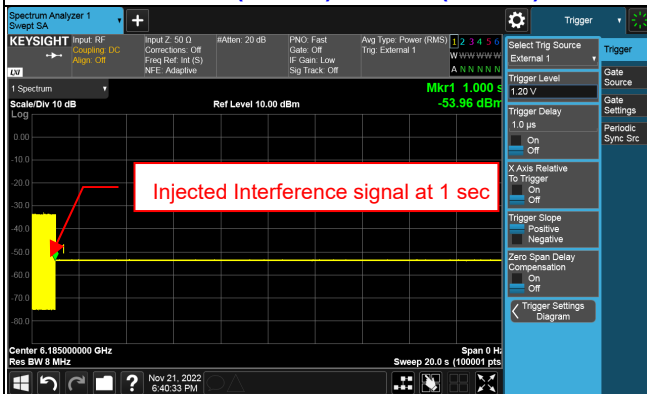

802.11ax (HE160) / CH 47 (High Edge)

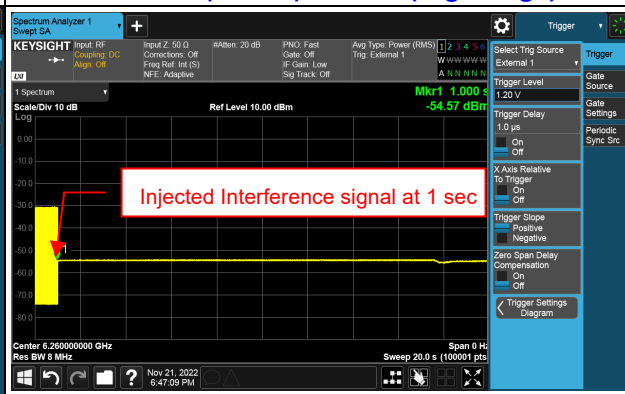

For U-NII-6 Band

Plots of EUT Tx waveform

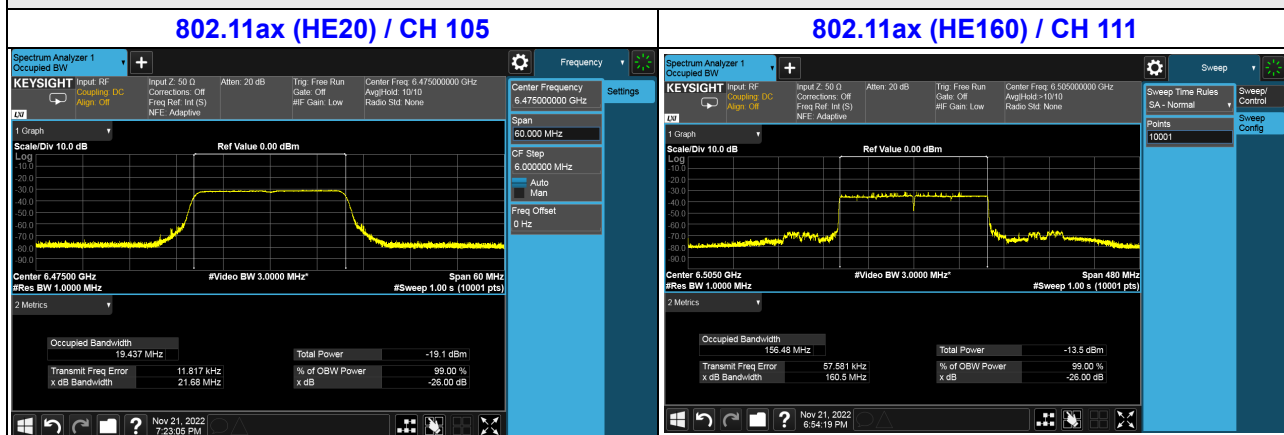

Plots of Incumbent signal (AWGN) Level

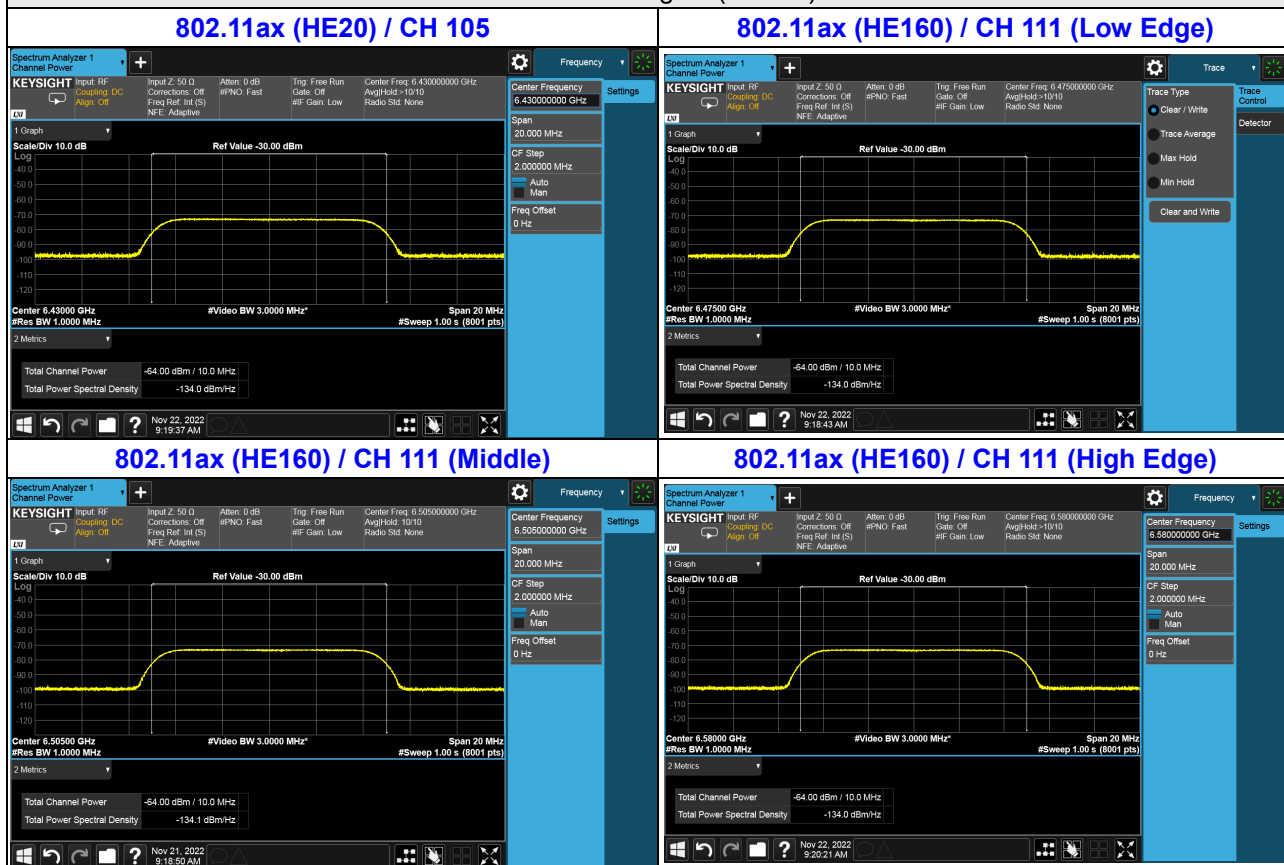

Plots of EUT ceased transmission in the time domain

802.11ax (HE20) / CH 105

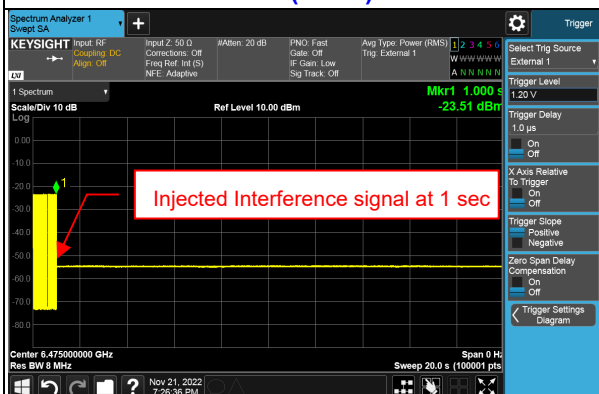

802.11ax (HE160) / CH 111 (Low Edge)

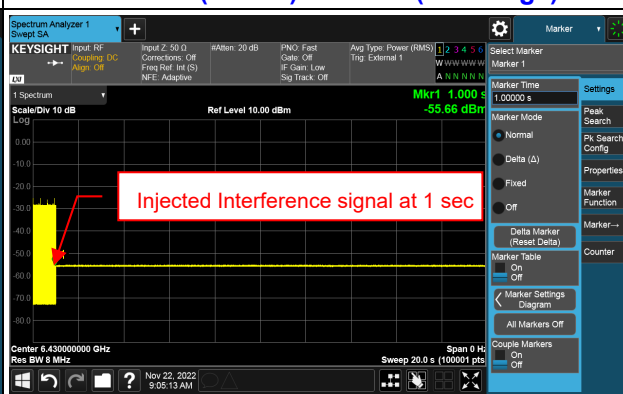

802.11ax (HE160) / CH 111 (Middle)

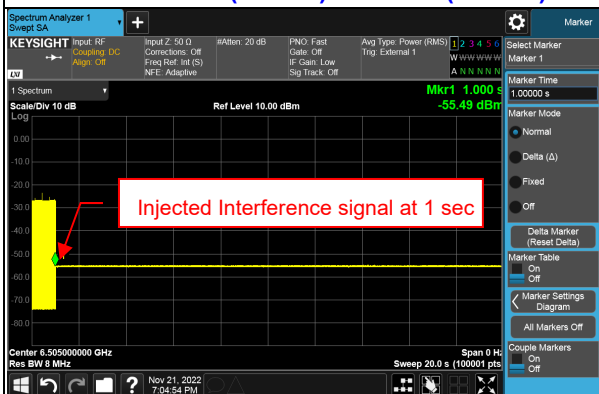

802.11ax (HE160) / CH 111 (High Edge)

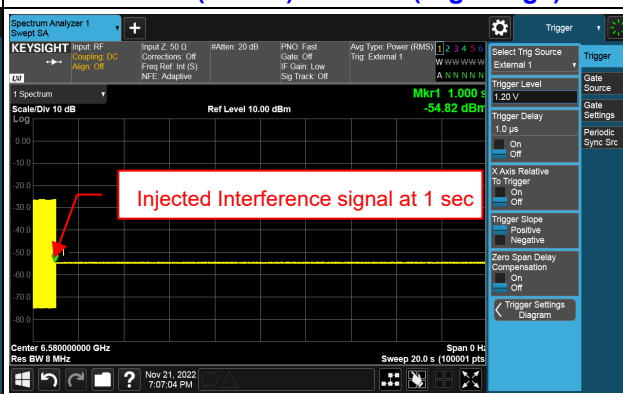

For U-NII-7 Band

Plots of EUT Tx waveform

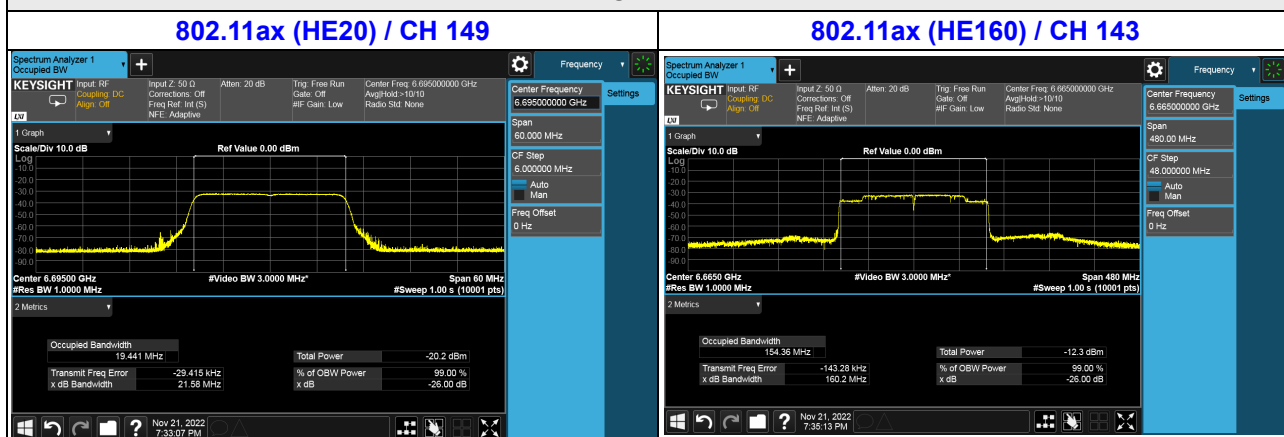

Plots of Incumbent signal (AWGN) Level

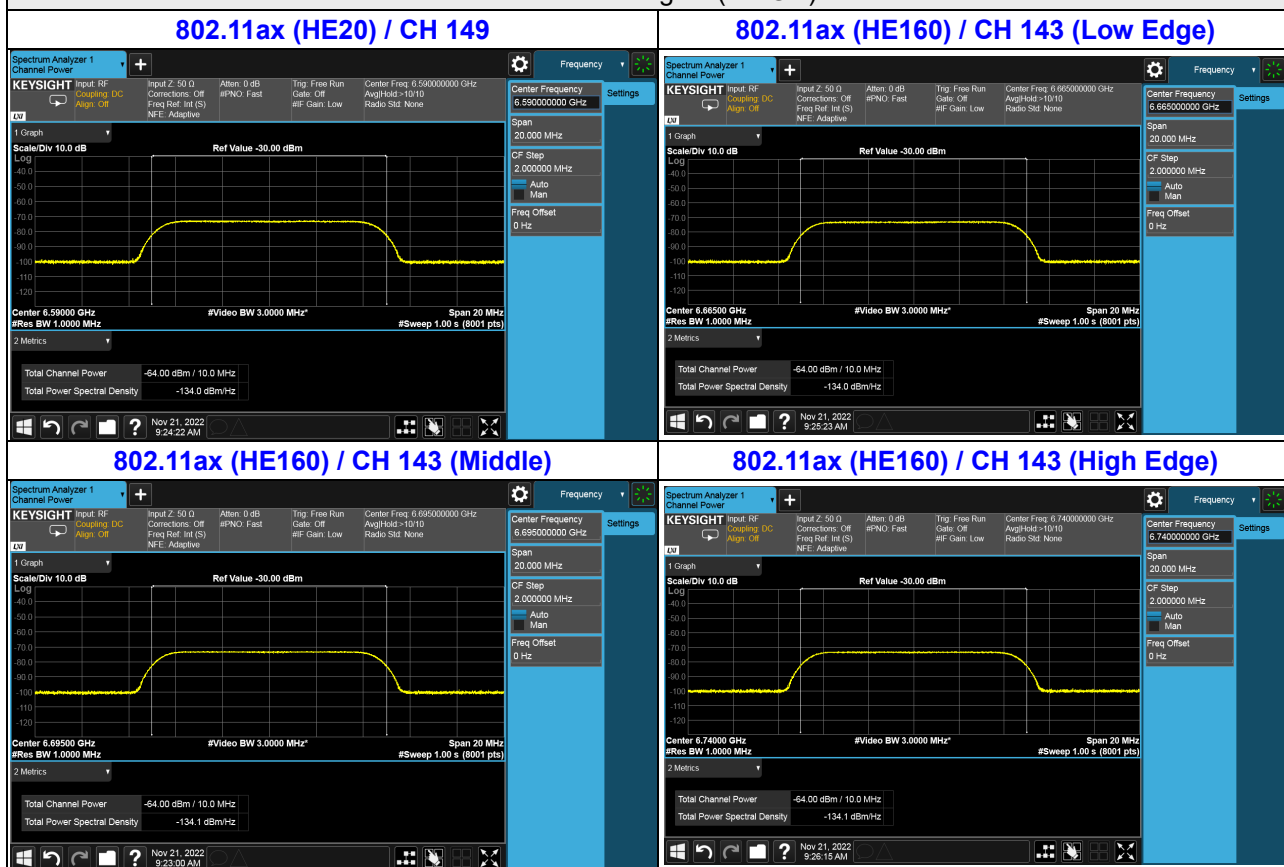

Plots of EUT ceased transmission in the time domain

802.11ax (HE20) / CH 149

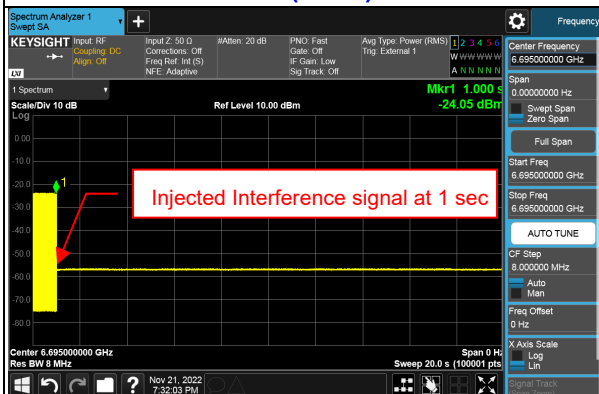

802.11ax (HE160) / CH 143 (Low Edge)

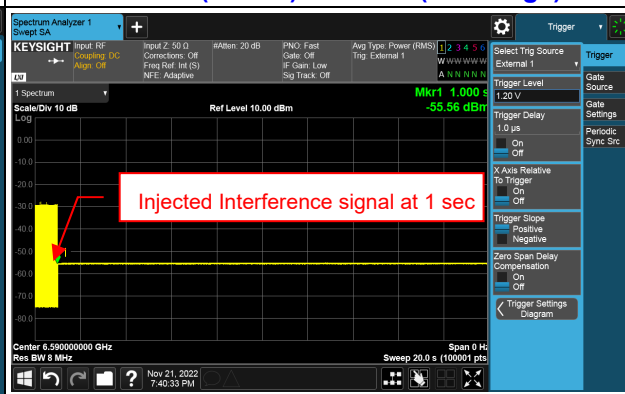

802.11ax (HE160) / CH 143 (Middle)

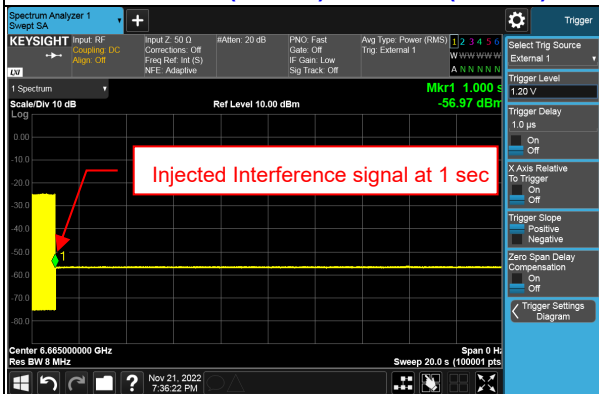

802.11ax (HE160) / CH 143 (High Edge)

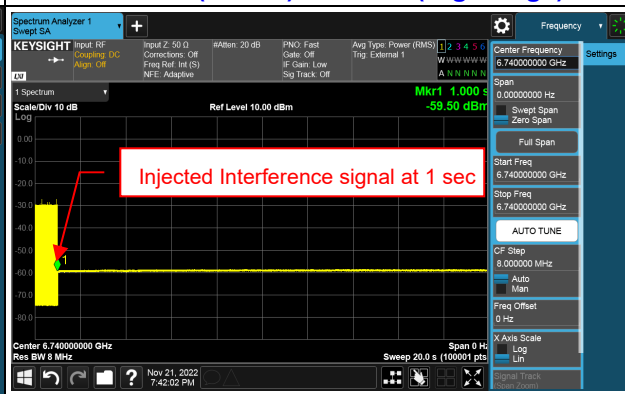

For U-NII-8 Band

Plots of EUT Tx waveform



Plots of Incumbent signal (AWGN) Level

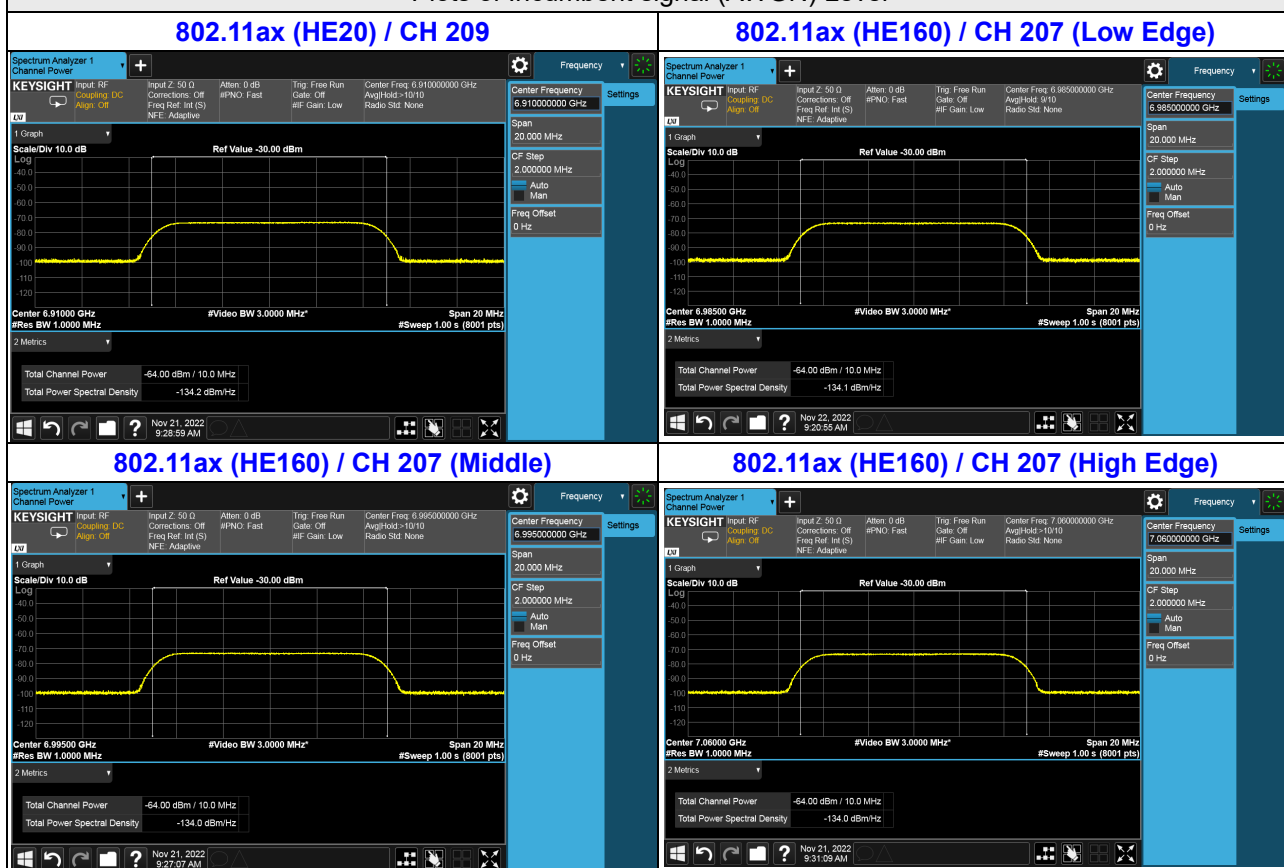

Plots of EUT ceased transmission in the time domain

802.11ax (HE160) / CH 207 (Low Edge)

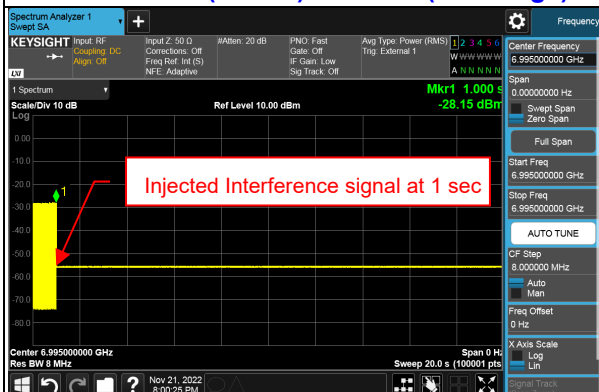

802.11ax (HE160) / CH 207 (Low Edge)

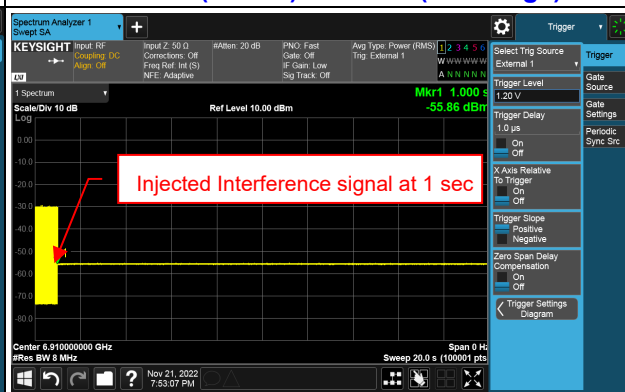

802.11ax (HE160) / CH 207 (Middle)

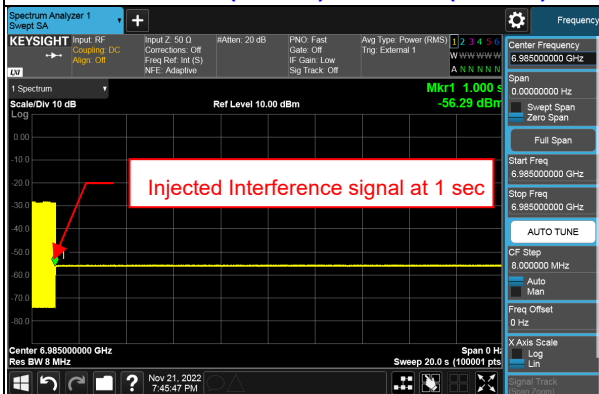

802.11ax (HE160) / CH 207 (High Edge)

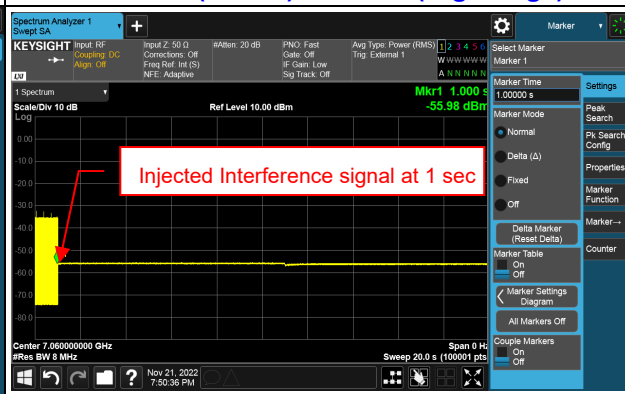

4.8 Frequency Stability

4.8.1 Limits of Frequency Stability Measurement

The frequency of the carrier signal shall be maintained within band of operation

4.8.2 Test Setup

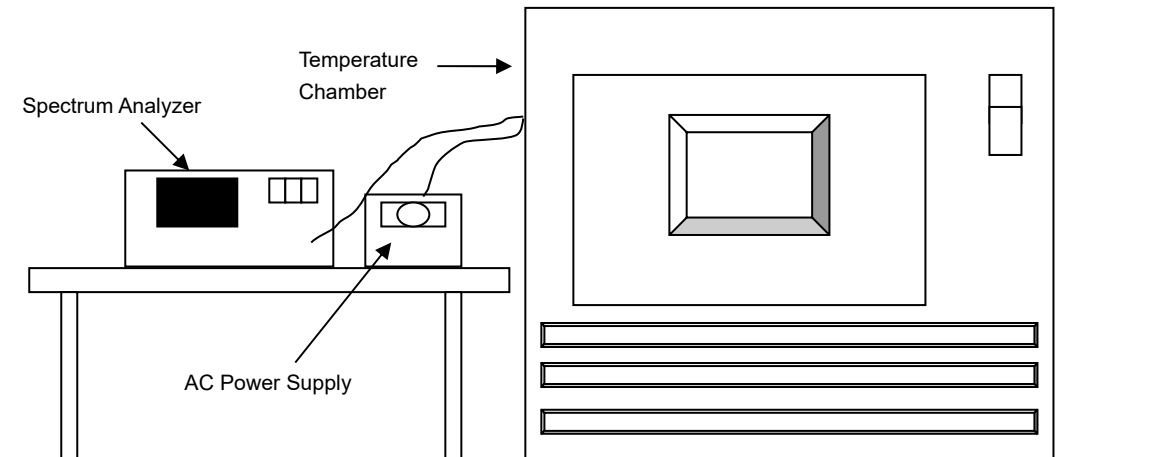

4.8.3 Test Instruments

Description Manufacturer	Model No.	Serial No.	Calibrated Date	Calibrated Until
Spectrum Analyzer ROHDE & SCHWARZ	FSP40	100040	2022/9/16	2023/9/15
WIT Standard Temperature And Humidity Chamber	TH-4S-C	W981030	2022/5/30	2023/5/29
Three-phase coupling / decoupling network TESEQ	CDN 3063	4006	2022/3/8	2023/3/7
AC Power Supply Extech	CFW-105	E000603	NA	NA

Notes:

1. The test was performed in Oven room.
2. Tested Date: 2022/11/17

4.8.4 Test Procedure

- a. The EUT was placed inside the environmental test chamber and powered by nominal AC voltage.
- b. Turn the EUT on and couple its output to a spectrum analyzer.
- c. Turn the EUT off and set the chamber to the highest temperature specified.
- d. Allow sufficient time (approximately 30 min) for the temperature of the chamber to stabilize, turn the EUT on and measure the operating frequency after 2, 5, and 10 minutes.
- e. Repeat step d with every 10 degrees reduction until the lowest temperature achieved.
- f. The test chamber was allowed to stabilize at +20 degree C for a minimum of 30 minutes. The supply voltage was then adjusted on the EUT from 85% to 115% and the frequency record.

4.8.5 Deviation from Test Standard

No deviation.

4.8.6 EUT Operating Condition

Set the EUT transmit at un-modulation mode to test frequency stability.

4.8.7 Test Results

Frequency Stability Versus Temp.									
Operating Frequency: 5955MHz									
Temp. (°C)	Power Supply (Vac)	0 Minute		2 Minute		5 Minute		10 Minute	
		Measured Frequency (MHz)	Result	Measured Frequency (MHz)	Result	Measured Frequency (MHz)	Result	Measured Frequency (MHz)	Result
55	120	5955.0041	Pass	5955.0028	Pass	5955.0052	Pass	5955.0041	Pass
50	120	5954.9904	Pass	5954.9916	Pass	5954.9896	Pass	5954.9895	Pass
40	120	5954.9855	Pass	5954.9826	Pass	5954.9852	Pass	5954.9807	Pass
30	120	5954.9926	Pass	5954.9946	Pass	5954.993	Pass	5954.9934	Pass
20	120	5954.9986	Pass	5954.9983	Pass	5954.9976	Pass	5954.9997	Pass
10	120	5954.996	Pass	5954.9926	Pass	5954.9954	Pass	5954.996	Pass
0	120	5955.0189	Pass	5955.0177	Pass	5955.0135	Pass	5955.0159	Pass
-10	120	5955.0021	Pass	5955.0032	Pass	5955.0026	Pass	5955	Pass

Frequency Stability Versus Voltage									
Operating Frequency: 5955MHz									
Temp. (°C)	Power Supply (Vac)	0 Minute		2 Minute		5 Minute		10 Minute	
		Measured Frequency (MHz)	Result	Measured Frequency (MHz)	Result	Measured Frequency (MHz)	Result	Measured Frequency (MHz)	Result
20	138	5954.9994	Pass	5955.0017	Pass	5955.0039	Pass	5955.0033	Pass
	120	5954.9986	Pass	5954.9983	Pass	5954.9976	Pass	5954.9997	Pass
	102	5954.995	Pass	5954.9961	Pass	5954.9949	Pass	5954.9947	Pass

4.9 Operational Restrictions for 6 GHz U-NII Devices

4.9.1 Limits of Operational Restrictions for 6 GHz U-NII Devices

In the 5.925-7.125 GHz band, client devices, except fixed client devices, must operate under the control of a standard power access point, indoor access point or subordinate devices; Subordinate devices must operate under the control of an indoor access point.

4.9.2 Test Setup

N/A

4.9.3 Test Instruments

N/A

4.9.4 Test Procedure

N/A

4.9.5 Test Results

Device is an indoor client device under the control of a low power indoor access point. Please refer to the declaration letter exhibit supplied within this application.

5 Pictures of Test Arrangements

Please refer to the attached file (Test Setup Photo).

Annex A - Band Edge Measurement

802.11ax (HE20) Channel 1

Horizontal (Peak)

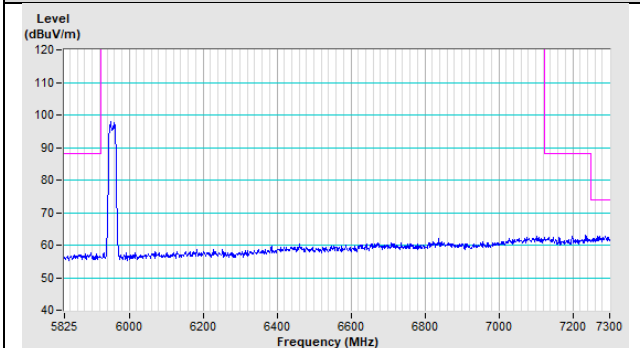

Horizontal (Average)

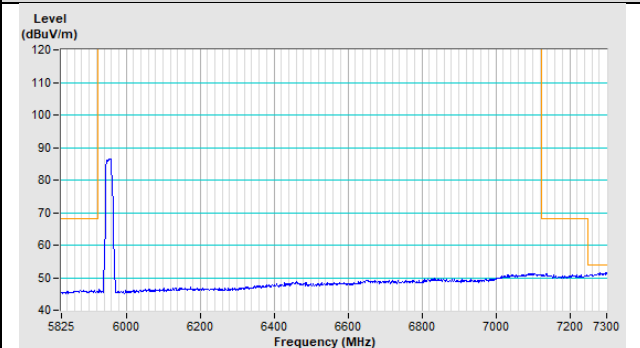

Vertical (Peak)

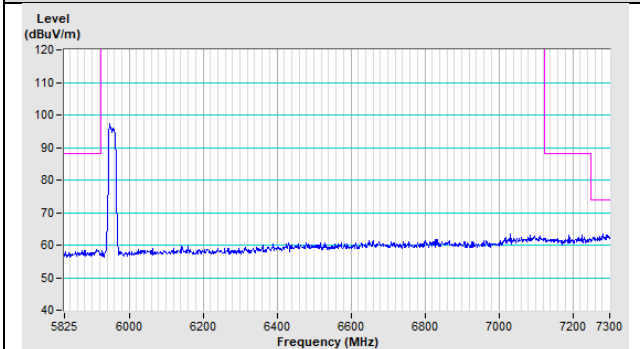

Vertical (Average)

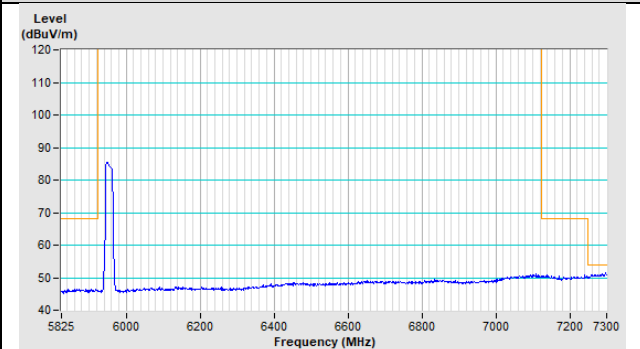

802.11ax (HE20) Channel 233

Horizontal (Peak)

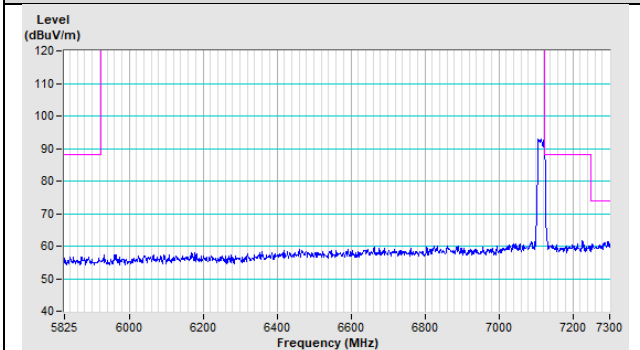

Horizontal (Average)

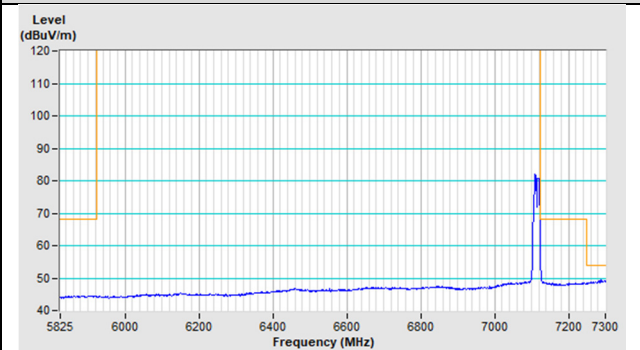

Vertical (Peak)

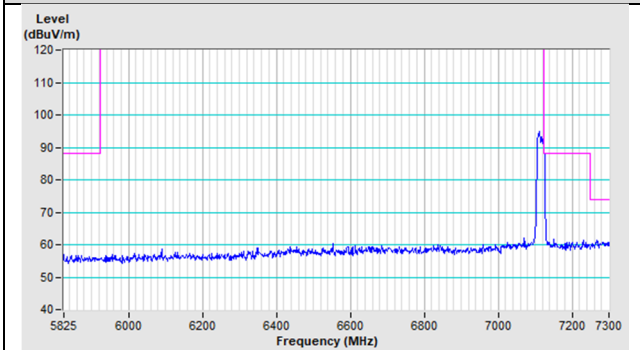

Vertical (Average)

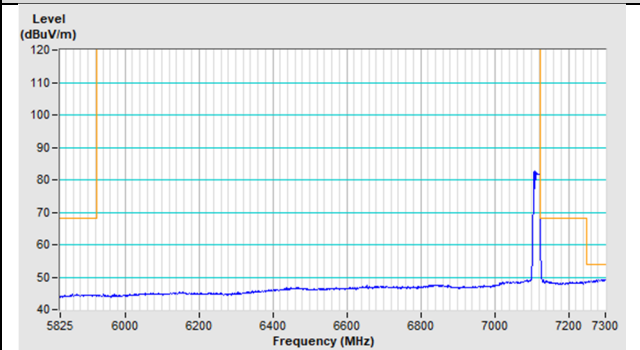

802.11ax (HE40) Channel 3

Horizontal (Peak)

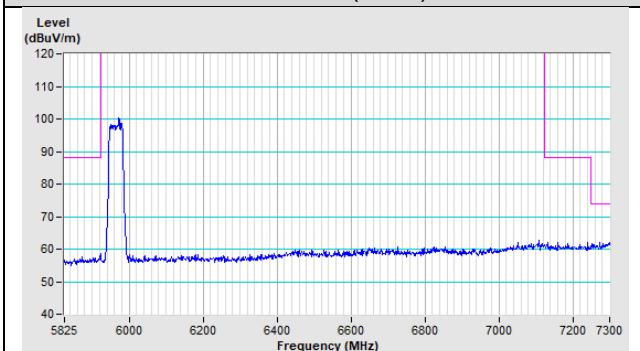

Horizontal (Average)

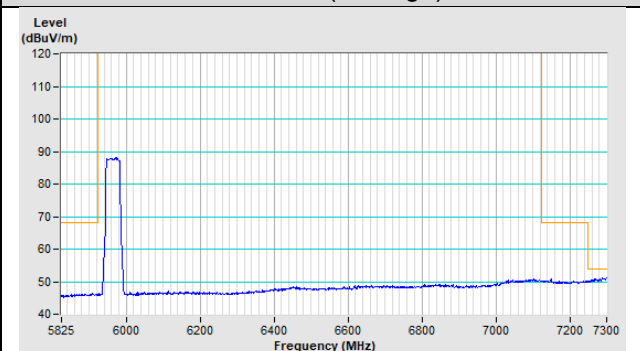

Vertical (Peak)

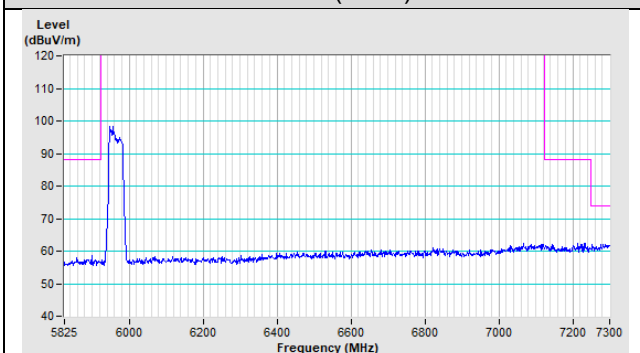

Vertical (Average)

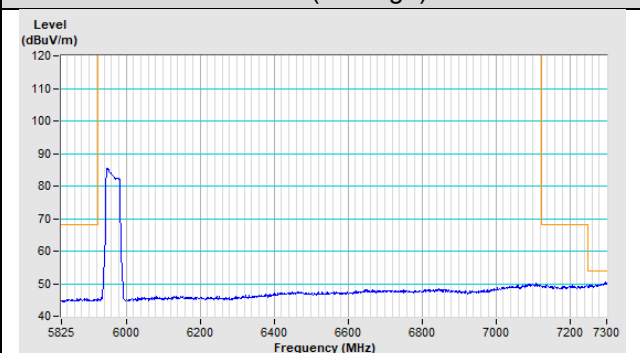

802.11ax (HE40) Channel 227

Horizontal (Peak)

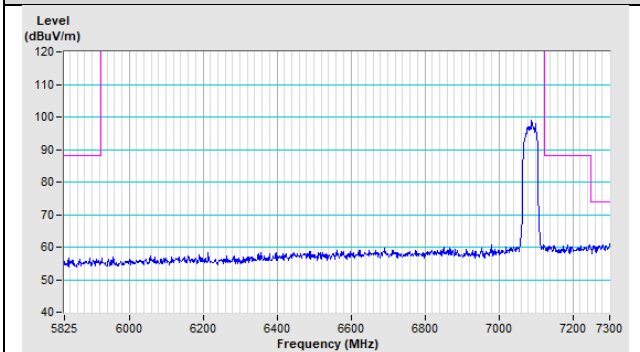

Horizontal (Average)

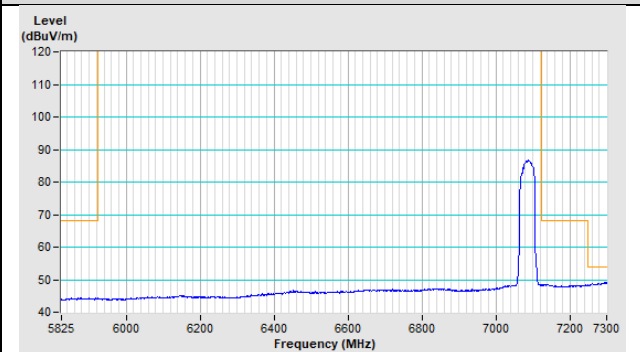

Vertical (Peak)

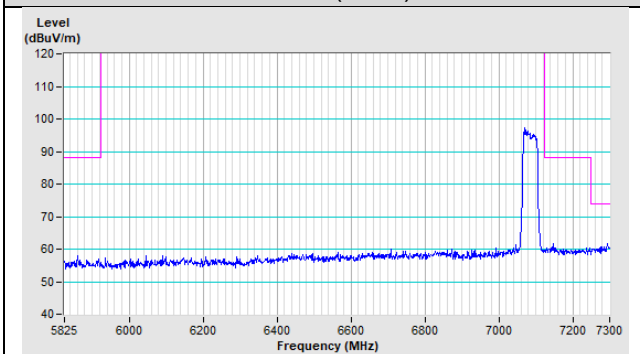

Vertical (Average)

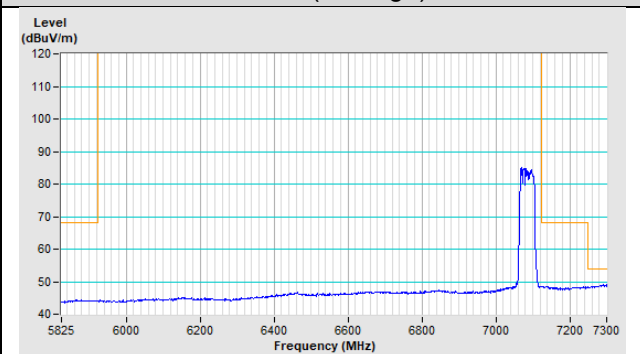

802.11ax (HE80) Channel 7

Horizontal (Peak)

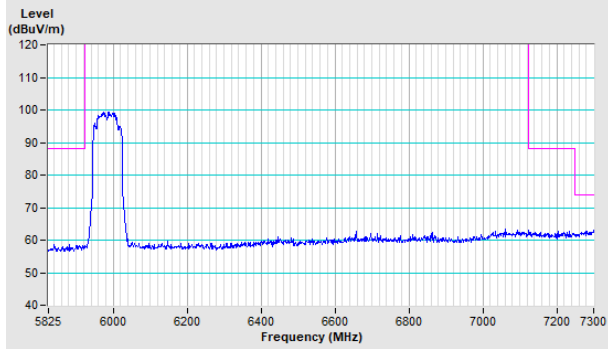

Horizontal (Average)

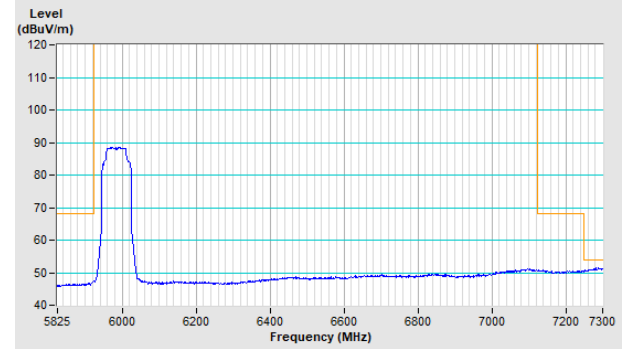

Vertical (Peak)

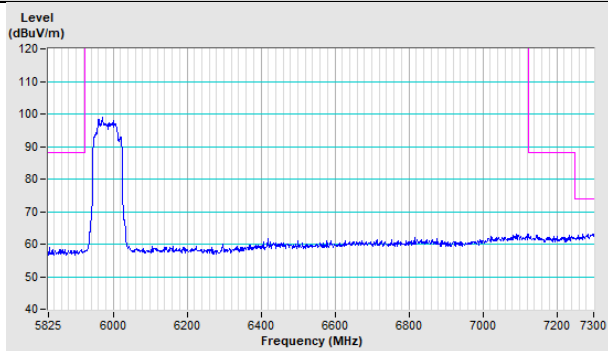

Vertical (Average)

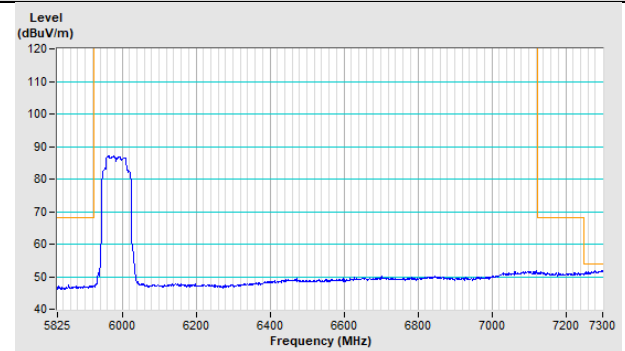

802.11ax (HE80) Channel 215

Horizontal (Peak)

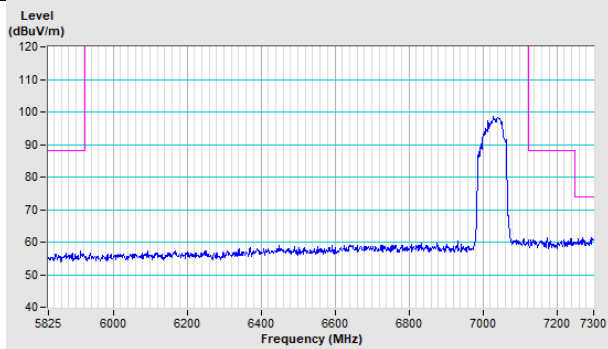

Horizontal (Average)

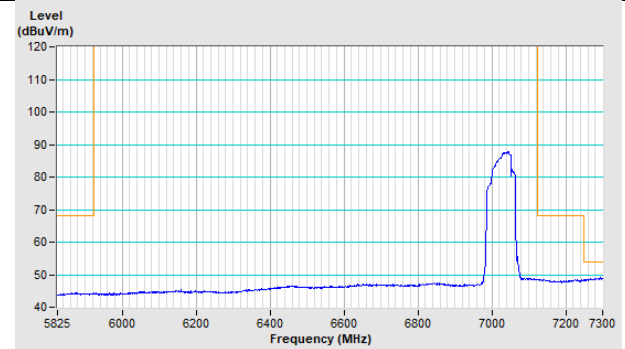

Vertical (Peak)

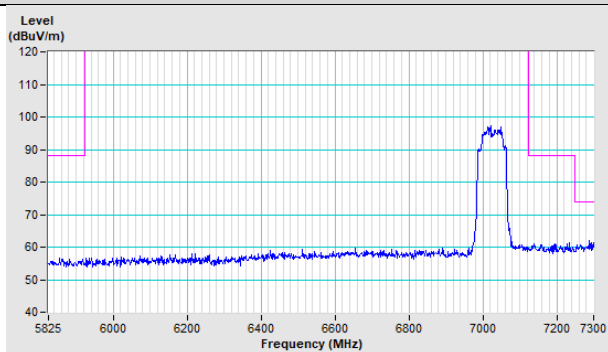

Vertical (Average)

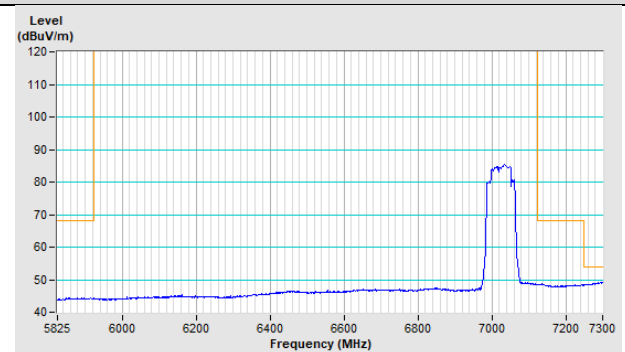

802.11ax (HE160) Channel 15

Horizontal (Peak)

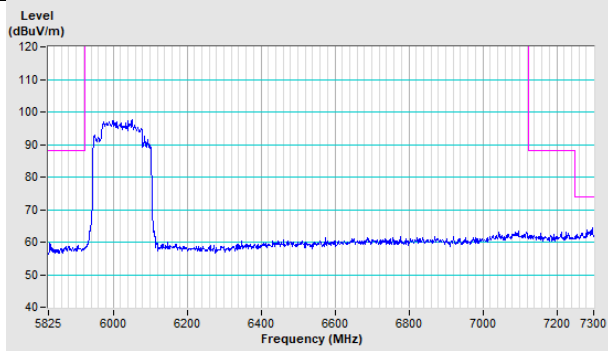

Horizontal (Average)

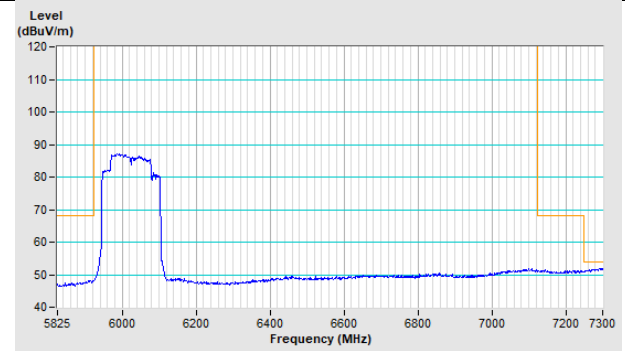

Vertical (Peak)

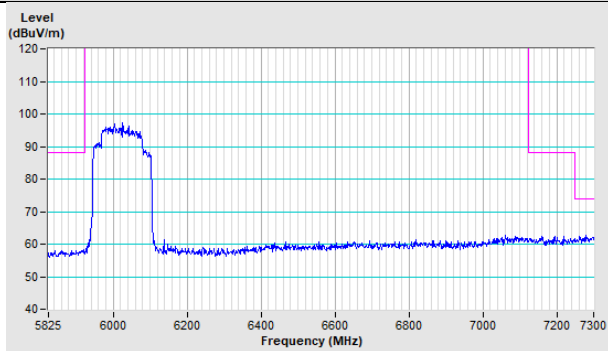

Vertical (Average)

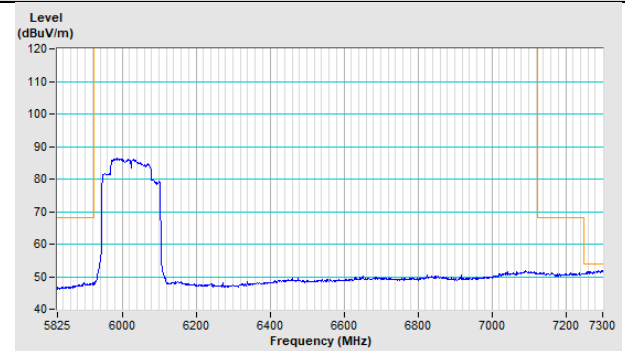

802.11ax (HE160) Channel 207

Horizontal (Peak)

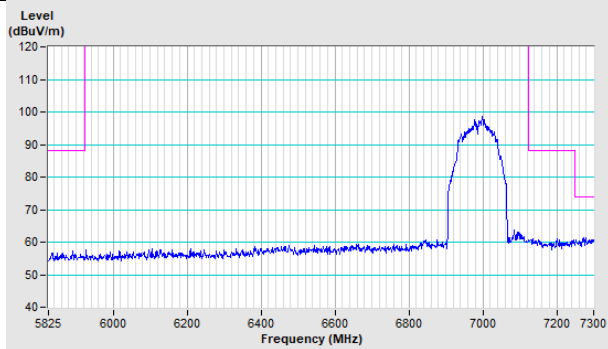

Horizontal (Average)

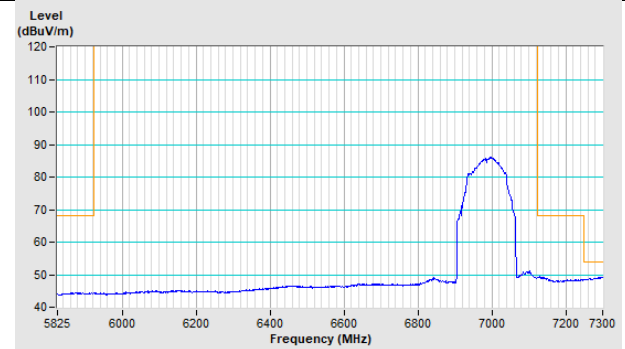

Vertical (Peak)

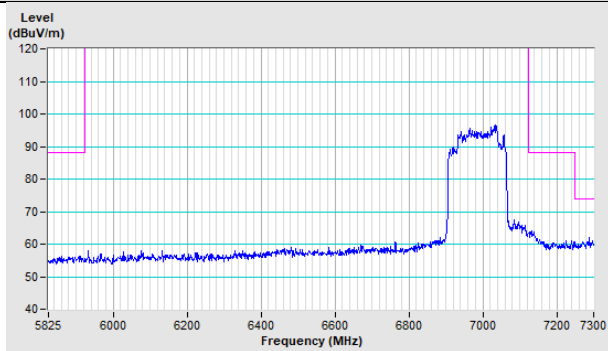

Vertical (Average)

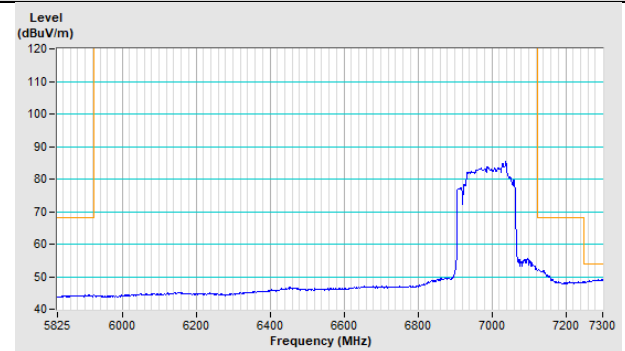

Appendix – Information of the Testing Laboratories

We, Bureau Veritas Consumer Products Services (H.K.) Ltd., Taoyuan Branch, were founded in 1988 to provide our best service in EMC, Radio, Telecom and Safety consultation. Our laboratories are FCC recognized accredited test firms and accredited and approved according to ISO/IEC 17025.

If you have any comments, please feel free to contact us at the following:

Lin Kou EMC/RF Lab

Tel: 886-2-26052180

Fax: 886-2-26051924

Hsin Chu EMC/RF/Telecom Lab

Tel: 886-3-6668565

Fax: 886-3-6668323

Hwa Ya EMC/RF/Safety

Tel: 886-3-3183232

Fax: 886-3-3270892

Email: service.adt@tw.bureauveritas.com

Web Site: www.bureauveritas-adt.com

The address and road map of all our labs can be found in our web site also.

--- END ---