

FCC 15.407 WLAN 6GHz Test Report

for

LG Electronics Inc.

**222, LG-ro, Jinwi-myeon Pyeongtaek-Si, Gyeonggi-Do,
17709 Republic of Korea**

Product Name : Notebook Computer
Model Name : (1)15ZB90Q (2)15ZG90Q
Brand : LG
FCC ID : BEJNT-15ZB90Q

**Prepared by: : AUDIX Technology Corporation,
EMC Department**



The test report is based on a single evaluation of one sample of the above-mentioned products. It does not imply an assessment of the whole production and does not permit the use of the test lab logo.

TABLE OF CONTENTS

Description	Page
TEST REPORT.....	4
1. REVISION RECORD OF TEST REPORT	5
2. SUMMARY OF TEST RESULTS	6
3. GENERAL INFORMATION	7
3.1. Description of Application	7
3.2. Description of EUT	8
3.3. Reference Test Guidance.....	9
3.4. Antenna Information	10
3.5. EUT Specifications Assessed in Current Report	11
3.6. Description of Key Components	14
3.7. Test Configuration.....	16
3.8. Output Power Setting	22
3.9. Tested Supporting System List.....	23
3.10. Setup Configuration.....	23
3.11. Operating Condition of EUT	24
3.12. Description of Test Facility	24
3.13. Measurement Uncertainty	25
4. MEASUREMENT EQUIPMENTLIST.....	26
4.1. Conducted Emission Measurement	26
4.2. Radiated Emission Measurement	27
4.3. RF Conducted Measurement	28
4.4. Contention Based Protocol Measurement	28
5. CONDUCTED EMISSION.....	29
5.1. Block Diagram of Test Setup	29
5.2. Conducted Emission Limit	29
5.3. Test Procedure	29
5.4. Test Results	29
6. RADIATED EMISSION	30
6.1. Block Diagram of Test Setup	30
6.2. Radiated Emission Limits.....	32
6.3. Test Procedure	33
6.4. Measurement Result Explanation.....	35
6.5. Test Results	35
7. MAXIMUM POWER SPECTRAL DENSITY.....	36
7.1. Block Diagram of Test Setup	36
7.2. Specification Limits.....	36
7.3. Test Procedure	36
7.4. Test Results	36
8. MAXIMUM CONDUCTED OUTPUT POWER	37
8.1. Block Diagram of Test Setup	37
8.2. Specification Limits.....	37
8.3. Test Procedure	37
8.4. Test Results	37
9. EMISSION/OCCUPIED BANDWIDTH.....	38

9.1. Block Diagram of Test Setup	38
9.2. Specification Limits.....	38
9.3. Test Procedure	38
9.4. Test Results	38
10. UNDERSIRABLE EMISSIONS LIMITS: SPURIOUS EMISSION (CONDUCTED)	39
10.1. Block Diagram of Test Setup	39
10.2. Spurious Emission Specification Limits.....	39
10.3. Test Procedure	39
10.4. Test Results	39
11. IN-BAND EMISSION (CHANNEL MASK).....	40
11.1. Block Diagram of Test Setup	40
11.2. Specification Limits.....	40
11.3. Test Procedure	40
11.4. Test Results	41
12. CONTENTION BASED PROTOCOL	42
12.1. Block Diagram of Test Setup	42
12.2. Specification Limits.....	42
12.3. Test Procedure	44
12.4. Test Results	44
13. DEVIATION TO TEST SPECIFICATIONS	45

APPENDIX A TEST DATA AND PLOTS

APPENDIX B TEST PHOTOGRAPHS

TEST REPORT

Applicant : LG Electronics Inc.
Manufacturer : LG Electronics Inc.
Factory : LG Electronics Nanjing New Technology Co., Ltd.
EUT Description
(1) Product : Notebook Computer
(2) Model : (1)15ZB90Q (2)15ZG90Q
(3) Brand : LG
(4) Power Supply: DC 20V, 3.25A

Applicable Standards:

Title 47 FCC CFR Part 15 Subpart E

Audix Technology Corp. tested the equipment mentioned in accordance with the requirements set forth in the above standards. Test results indicate that the equipment tested is capable of demonstrating compliance with the requirements as documented within this report.

Audix Technology Corp. does not assume responsibility for any conclusions and generalizations drawn from the test results with regard to other specimens and samples.

Date of Report: 2022. 08. 05

Reviewed by:



(Sunnie Huang/Administrator)

Approved by:

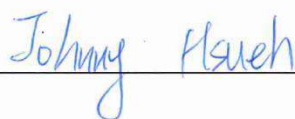

(Johnny Hsueh/Section Manager)

1. REVISION RECORD OF TEST REPORT

Edition No	Issued Date	Revision Summary	Report Number
0	2022. 08. 05	Original Report	EM-F220525

2. SUMMARY OF TEST RESULTS

FCC Part Section(s)	Description	Results
15.207	Conducted Emission	PASS
15.205/15.209 15.407 (b)(6)	Radiated Band Edge and Radiated Spurious Emission	PASS
15.407(a)(8)	Maximum Power Spectral Density	PASS
15.407(a)(8)	Maximum Conducted Output Power	PASS
2.1049 15.407(a)(10)	Emission/Occupied Bandwidth	PASS
15.407(b)(6)	Undesirable emission limits: Spurious Emission (Conducted)	PASS
15.407(b)(7)	In-Band Emission (Channel Mask)	PASS
15.407(d)(6)	Contention Based Protocol	PASS
15.203	Antenna Requirement	PASS
Note: The uncertainties value is not used in determining the result.		

3. GENERAL INFORMATION

3.1. Description of Application

Applicant	LG Electronics Inc. 222, LG-ro, Jinwi-myeon Pyeongtaek-Si, Gyeonggi-Do, 17709 Republic of Korea
Manufacturer	LG Electronics Inc. 222, LG-ro, Jinwi-myeon Pyeongtaek-Si, Gyeonggi-Do, 17709 Republic of Korea
Factory	LG Electronics Nanjing New Technology Co., Ltd. No.346, Yaoxin Road, Economic & Technical Development Zone, Nanjing, China.
Product	Notebook Computer
Model	(1)15ZB90Q (2)15ZG90Q The difference between all models is different in the sales customers.
Brand	LG

3.2. Description of EUT

Test Model	15ZB90Q	
Serial Number	N/A	
Power Rating	DC 20V, 3.25A	
Software Version	XY (X, Y can be 0 to 9 for different SW version not influence RF parameter)	
RF Features	WLAN: 802.11 a/b/g/n/ac/ax Bluetooth: BT and BLE (BT 5.1)	
Transmit Type	2.4 GHz	
	802.11b	1T1R
	802.11g	1T1R
	802.11n-HT20	2T2R
	802.11n-HT40	2T2R
	802.11ax-HE20	2T2R
	802.11ax-HE40	2T2R
	BT/BLE	1T1R
	U-NII Bands	
	802.11a	1T1R
	802.11n-HT20/802.11ac-VHT20/802.11ax-HE20	2T2R
	802.11n-HT40/802.11ac-VHT40/802.11ax-HE40	2T2R
	802.11ac-VHT80/802.11ax-HE80	2T2R
	802.11ac-VHT160/802.11ax-HE160	2T2R
	The MIMO is uncorrelated and supported SDM (Spatial Division Multiplexing) mode only. This radio device doesn't support beamforming and Cyclic Delay Diversity (CDD).	
Device Category	<input type="checkbox"/> Outdoor Access Point <input type="checkbox"/> Fixed point-to-point Access Point <input type="checkbox"/> Indoor Access Point <input checked="" type="checkbox"/> Mobile and Portable client device	
Test Sample	Sample No.	Test Item
	03	AC Conduction, RSE, RF Conducted
	Firmware	N/A
Sample Status	Trial sample	
Date of Receipt	2022. 06. 30	
Date of Test	2022. 07. 09 ~ 14	

Interface Ports of EUT	<ul style="list-style-type: none">• One HDMI Port• Two USB Type C Port• One Earphone Port• One Micro SD Card Slot• Two USB 3.0 Ports
Accessories Supplied	<ul style="list-style-type: none">• AC Adapter• LAN Gender

3.3. Reference Test Guidance

ANSI C63.10:2013

KDB 789033 D02 v02r01, KDB 662911 D01 v02r01, KDB 987594 D02 v01r01

3.4. Antenna Information

No.	Antenna Part Number	Manufacture	Antenna Type	Frequency (MHz)	Max Gain(dBi)	
					Main	AUX
1.	WA-P-LELE-04-026	INPAQ	Mono-Pole	2400	3.1	1.9
				2425	4.8	2.3
				2450	4.4	2.2
				2475	4.5	3.2
				2500	5.3	3.4
				5150	2.7	2.7
				5250	3.7	3.7
				5350	3.1	3.1
				5725	3.1	3.1
				5825	3.0	3.0
				5925	2.0	2.3
				6525	1.9	2.2
				7125	1.9	2.1

According to KDB 662911 D01 d) ii), transmit signals are completely uncorrelated, then
 Directional gain = $10 \log[(10^{G1/10} + 10^{G2/10} + \dots + 10^{GN/10})/N_{ANT}]$ dBi

Note 1. 2.4G: Directional gain =
 2400MHz: Directional gain = $10 \log[(10^{3.1/10} + 10^{1.9/10})/2] = 2.54$ dBi
 2425MHz: Directional gain = $10 \log[(10^{4.8/10} + 10^{2.3/10})/2] = 3.73$ dBi
 2450MHz: Directional gain = $10 \log[(10^{4.4/10} + 10^{2.2/10})/2] = 3.44$ dBi
 2475MHz: Directional gain = $10 \log[(10^{4.5/10} + 10^{3.2/10})/2] = 3.90$ dBi

Note 2. 5G: Directional gain =
 5150MHz: $= 10 \log[(10^{2.7/10} + 10^{2.7/10})/2] = 2.70$ dBi
 5250MHz: $= 10 \log[(10^{3.7/10} + 10^{3.7/10})/2] = 3.70$ dBi
 5350MHz: $= 10 \log[(10^{3.1/10} + 10^{3.1/10})/2] = 3.10$ dBi
 5725MHz: $= 10 \log[(10^{3.1/10} + 10^{3.1/10})/2] = 3.10$ dBi
 5825MHz: $= 10 \log[(10^{3.0/10} + 10^{3.0/10})/2] = 3.00$ dBi

Note 3. UNII Band (WLAN 6G):
 5925MHz: Directional gain = $10 \log[(10^{2.0/10} + 10^{2.3/10})/2] = 2.15$ dBi
 6525MHz: Directional gain = $10 \log[(10^{1.9/10} + 10^{2.2/10})/2] = 2.05$ dBi
 7125MHz: Directional gain = $10 \log[(10^{1.9/10} + 10^{2.1/10})/2] = 2.00$ dBi

We chose the antenna gain corresponding to the frequency listed on the table which is closer to center frequency of WLAN.

3.5. EUT Specifications Assessed in Current Report

Mode	U-NII Band	Fundamental Range (MHz)	Channel Number
802.11ax-HE20	5	5955-6415	24
	6	6435-6515	5
	7	6535-6855	17
	8	6875-7115	13
802.11ax-HE40	5	5965-6405	12
	6	6445-6485	2
	7	6525-6845	9
	8	6885-7085	6
802.11ax-HE80	5	5985-6385	6
	6	6465-6545	2
	7	6625-6785	3
	8	6865-7025	3
802.11ax-HE160	5	6025-6345	3
	6	6505	1
	7	6665-6825	2
	8	6985	1

Mode	Modulation	Data Rate (Mbps)
802.11ax-HE20	OFDMA (BPSK/ QPSK/ 16QAM/ 64QAM/ 256QAM/1024QAM)	Up to 287
802.11ax-HE40		Up to 574
802.11ax-HE80		Up to 1201
802.11ax-HE160		Up to 2402

Channel List								
802.11ax-HE20								
U-NII Band	Channel Number	Freq. (MHz)	U-NII Band	Channel Number	Freq. (MHz)	U-NII Band	Channel Number	Freq. (MHz)
5	2	5955	5	81	6335	7	161	6755
	5	5975		85	6375		165	6775
	9	5995		89	6395		169	6795
	13	6015		93	6415		173	6815
	17	6035		97	6435		177	6835
	21	6055	6	101	6455	181	6855	
	25	6075		105	6475	185	6875	
	29	6095		109	6495	189	6895	
	33	6115		113	6515	193	6915	
	37	6135	7	117	6535	197	6935	
	41	6155		121	6555	201	6955	
	45	6175		125	6575	205	6975	
	49	6195		129	6595	209	6995	
	53	6215		133	6615	213	7015	
	57	6235		137	6635	217	7035	
	61	6255		141	6655	221	7055	
	65	6275		145	6675	225	7075	
	69	6295		149	6695	229	7095	
	73	6315		153	6715	233	7115	
	77	6335	157	6735				

Channel List								
802.11ax-HE40								
U-NII Band	Channel Number	Freq. (MHz)	U-NII Band	Channel Number	Freq. (MHz)	U-NII Band	Channel Number	Freq. (MHz)
5	3	5965	5	83	6365	7	163	6765
	11	6005		91	6405		171	6805
	19	6045		99	6445		179	6845
	27	6085	6	107	6485	8	187	6885
	35	6125		115	6525		195	6925
	43	6165	7	123	6565		203	6965
	51	6205		131	6505		211	7005
	59	6245		139	6645		219	7045
	67	6285		147	6685		227	7085
	75	6325		155	6725			

Channel List								
802.11ax-HE80								
U-NII Band	Channel Number	Freq. (MHz)	U-NII Band	Channel Number	Freq. (MHz)	U-NII Band	Channel Number	Freq. (MHz)
5	7	5985	5	87	6385	7	167	6785
	23	6065	6	103	6465	8	183	6865
	39	6145		119	6545		199	6945
	55	6225	7	135	6625		215	7025
	71	6305		151	6705			

Channel List					
802.11ax-HE160					
U-NII Band	Channel Number	Frequency (MHz)	U-NII Band	Channel Number	Frequency (MHz)
5	15	6025	7	143	6665
	47	6185		175	6825
	79	6345	8	207	6985
6	111	6505			

Note: Test modes are presented at section 3.6.

3.6. Description of Key Components

3.6.1. For the All Component Lists

Item	Supplier	Model / Type	Character
System	Microsoft	Win 10	---
		Win 10 Pro	---
		Win 11	---
Main Board	LG	Queen LP4X MAIN B/D PCB	Main Board Manufacturer: #1 HannstarBoardTech(Jiang Yin)Corp.,Ltd. #2 Elec&Eltek Company (MCO) Limited.
WLAN SUB Board	LG	15Z90Q B2B SUB B/D	Manufacturer: #1 HannstarBoardTech(Jiang Yin)Corp.,Ltd. #2 Elec&Eltek Company (MCO) Limited. #3 JiangSuHuaShen Electronic co.,ltd (HXF)
CPU (Socket: BGA1744)	Intel	i7-1260P	2.5GHz
	Intel	i7-1255U	2.5GHz
	Intel	i5-1240P	2.1GHz
	Intel	i5-1235U	2.1GHz
	Intel	i3-1220P	1.5GHz
	Intel	i3-1215U	1.5GHz
15" LCD Panel	LG Display	LP156WQ1 (SP)(Z2)	Resolution: 1920 x 1080, 60Hz FHD IPS
Storage (SSD)	SK hynix	---	1TB
		---	512GB
		---	256GB
	Samsung	---	1TB
		---	512GB
		---	256GB
Memory (RAM)	Samsung	---	32GB LPDDR4x(On Board)
		---	16GB LPDDR4x(On Board)
		---	8GB LPDDR4x(On Board)
	SK Hynix	---	32GB LPDDR4x(On Board)
		---	16GB LPDDR4x(On Board)
		---	8GB LPDDR4x(On Board)
Battery Pack	LG	LBV7227E	DC7.74V, 80Wh Typ 10336mAh
WLAN Combo Card	Intel	AX211D2W	WLAN and BT, 2x2 PCIe M.2 1216 SD adapter card FCC ID: PD9AX211D2 IC: 1000M-AX211D2
WLAN Combo Antenna	LG (INPAQ)	WA-P-LELE-04-026	PCB, Mono-pole Type Main: Black, Aux: Gray
Keyboard	TIC	KT0120B8E	---
	LITE ON	SN8101	---
Touch Pad	LITE-ON	SP8000(SG-A0620-00A)	LGPN (EBD63285207)
	ELAN	SD068D-26H0	LGPN (EBD62827905)
Web Camera	Chicony	CKFKH33-0	EBP63421711
	Luxvisions	0BF108N3	EBP63421709

Item	Supplier	Model / Type	Character
LAN Gender (Type C to LAN)	SUZHOU MEC ELECTRONICS	80-5946-111	(White) 10/100Megabit Ethernet
		80-5946-101	(Black) 10/100 Megabit Ethernet
	ARIN TECH CO. LTD	GD-08MF-36-WH-LP10	(White) 10/100Megabit Ethernet
		GD-08MF-36-BK-LP11	(Black) 10/100 Megabit Ethernet
	HUIZHOU DEHONG TECHNOLOGY CO.,LTD.	370-50713	(White) 10/100Megabit Ethernet
		370-50714	(Black) 10/100 Megabit Ethernet
	Type C to LAN: Shielded, Undetached, 0.12m		
AC Adapter (65W)	LG (HONOR)	ADT-65DSU-D03-2	I/P: AC 100-240V, 1.6A, 50-60Hz O/P: DC 20V, 3.25A
	DC Power Cord: Non-Shielded, Undetached, 1.5m		
	AC Power Cord: Non-Shielded, Detached, 1.0m (2C) (For Other Countries) AC Power Cord: Non-Shielded, Detached, 1.55m (2C) (For US, Canada, Mexico)		

Remark: For more detailed features description, please refer to the manufacturer’s specifications or the user manual.

3.6.2. The EUT collocates with following worst components, which are used to establish a basic configuration of system during test:

SKU (Mode) 1		
Main Board	LG, Queen LP4X MAIN B/D PCB	
SUB Board	LG, 15Z90Q B2B SUB B/D	
CPU	Intel, i7-1260P	
15” LCD Panel	LG Display, LP156WQ1 (SP)(Z2)	
Storage (SSD)	SK hynix, 1TB	
	Samsung, 1TB	
Memory (RAM)	32GB	
Battery Pack	LG, 80Wh	
Keyboard	TIC, KT0120B8E	
Touch Pad	LITE-ON, SP8000(SG-A0620-00A)	
Web Camera	Chicony, CKFKH33-0	
WLAN Combo Card	Intel, AX211D2W	
	WL 2.4G+BT	
WLAN Combo Antenna	LG (INPAQ), WA-P-LELE-04-026	
HDMI	1920 x 1080, 60Hz	
Type C #1	AC Adapter	
Type C #2	Link to LAN Gender	
	MEC (Black)	10/100Mbps

3.7. Test Configuration

Mode	TX _{on} (ms)	TX _{on+off} (ms)	Duty Cycle (x)	Duty Cycle Factor [10log(1/x)] (dB)
802.11ax-HE20	2.576	2.622	0.982	N/A
802.11ax-HE40	2.580	2.620	0.985	N/A
802.11ax-HE80	2.590	2.630	0.985	N/A
802.11ax-HE160	2.300	2.340	0.983	N/A
802.11ax-HE20 (RU)	2.590	2.630	0.985	N/A
802.11ax-HE40 (RU)	2.590	2.640	0.981	N/A
802.11ax-HE80 (RU)	2.595	2.640	0.983	N/A
802.11ax-HE160 (RU)	2.600	2.650	0.981	N/A

Note: When duty cycle is less than 98% (0.98) that duty cycle factor $10\log(1/x)$ is needed to add in conducted test items measured in average detector.

Mode	TX _{on} (ms)	T _{on} +T _{off} (ms)
802.11ax-HE20		
802.11ax-HE40		
802.11ax-HE80		
802.11ax-HE160		

Mode	TX _{on} (ms)	T _{on} +T _{off} (ms)
802.11ax-HE20 (RU)		
802.11ax-HE40 (RU)		
802.11ax-HE80 (RU)		
802.11ax-HE160 (RU)		

AC Conduction	
Normal operation	

	Item	Mode	Data Rate	Test Channel
Radiated Test Case	Radiated Spurious Emission (30MHz~1GHz)	802.11ax-HE160	HE0	79

● OFDM Modulation

	Item	Mode	Data Rate	Test Channel
Radiated Test Case	Radiated Spurious Emission (Above 1GHz)	802.11ax-HE20	HE0	45/97/181/209
		802.11ax-HE40	HE0	91/99/115/211
		802.11ax-HE80	HE0	39/103/167/183
		802.11ax-HE160	HE0	79/111/175/207
	Band Edge	802.11ax-HE20	HE0	2/233
		802.11ax-HE40	HE0	3/227
		802.11ax-HE80	HE0	7/215
		802.11ax-HE160	HE0	15/207

	Item	Mode	Data Rate	Test Channel
Conducted Test Case	Maximum Power Spectral Density/ Maximum Conducted Output power/ Emission/Occupied Bandwidth	802.11ax-HE20	HE0	2/45/93/97/105/113/117/149/181/185/209/233
		802.11ax-HE40	HE0	3/43/91/99/107/115/147/179/187/211/227
		802.11ax-HE80	HE0	7/39/87/103/119/135/151/167/183/199/215
		802.11ax-HE160	HE0	15/47/79/111/143/175/207
	Band Edge	802.11ax-HE20	HE0	2/233
		802.11ax-HE40	HE0	3/227
		802.11ax-HE80	HE0	7/215
		802.11ax-HE160	HE0	15/207
	Spurious Emission	802.11ax-HE20	HE0	2/97/181/185
		802.11ax-HE40	HE0	3/99/179/227
		802.11ax-HE80	HE0	39/103/167/199
		802.11ax-HE160	HE0	47/111/175/207

Item		Mode	Data Rate	Test Channel
Conducted Test Case	In-Band Emission (Channel Mask)	802.11ax-HE20	HE0	2/45/93/97/105/113/117/149/181/185/209/233
		802.11ax-HE40	HE0	3/43/91/99/107/115/147/179/187/211/227
		802.11ax-HE80	HE0	7/39/87/103/119/135/151/167/183/199/215
		802.11ax-HE160	HE0	15/47/79/111/143/175/207
	Contention Based Protocol	802.11ax-HE20	HE0	37/101/149/213
		802.11ax-HE160	HE0	47/111/143/207

● OFDMA Modulation

Item		Tones	RU Index	Mode	Data Rate	Test Channel
Radiated Test Case	Radiated Spurious Emission (Above 1GHz) ^{Note 5}	26T	18	802.11ax-HE80	HE0	7
		52T	44	802.11ax-HE80	HE0	7
		106T	54	802.11ax-HE20	HE0	2
		242T	62	802.11ax-HE160	HE0	47
		484T	66	802.11ax-HE160	HE0	47
		996T	67	802.11ax-HE80	HE0	39
	Band Edge ^{Note 6}	26T	0	802.11ax-HE20	HE0	2
			8	802.11ax-HE20	HE0	233
		52T	37	802.11ax-HE20	HE0	2
			40	802.11ax-HE20	HE0	233
		106T	53	802.11ax-HE20	HE0	2
			54	802.11ax-HE20	HE0	233
			56	802.11ax-HE40	HE0	227
		242T	61	802.11ax-HE20	HE0	233
			62	802.11ax-HE40	HE0	227
			61	802.11ax-HE160	HE0	15
		484T	65	802.11ax-HE160	HE0	15
			65	802.11ax-HE40	HE0	227
			S66	802.11ax-HE160	HE0	207
		996T	67	802.11ax-HE160	HE0	15
67	802.11ax-HE80		HE0	215		

Item	Tones	RU Index	Mode	Data Rate	Test Channel	
Conducted Test Case	Maximum Power Spectral Density/ In-Band Emission (Channel Mask) ^{Note 5}	26T	18	802.11ax-HE80	HE0	7
		52T	44	802.11ax-HE80	HE0	7
		106T	54	802.11ax-HE20	HE0	2
		242T	62	802.11ax-HE160	HE0	47
		484T	66	802.11ax-HE160	HE0	47
		996T	67	802.11ax-HE80	HE0	39
	Maximum Conducted Output power	26T	0/4/8	802.11ax-HE20	HE0	2/45/93/97/105/ 113/117/149/ 181/185/209/ 233
			37/39/40			
			53/54			
			61			
		52T	0/8/17	802.11ax-HE40	HE0	3/43/91/99/107/ 115/147/179/ 187/211/227
			37/40/44			
			53/54/56			
			61/62			
		106T	0/18/36	802.11ax-HE80	HE0	7/39/87/103/119/ /135/151/167/ 183/199/215
			37/44/52			
			53/56/60			
			61/62/64			
		242T	65/66	802.11ax-HE160	HE0	15/47/79/111/ 143/175/207
			65/66			
			S61/S62/S64			
			S61/S62/S64			
		484T	65/66	802.11ax-HE160	HE0	15/47/79/111/ 143/175/207
			S65/S66			
			S65/S66			
			S65/S66			
		996T	65/S67	802.11ax-HE160	HE0	15/47/79/111/ 143/175/207
			S65/S66			
S65/S66						
S65/S66						

- Note 1: Mobile Device Portable Device
 and 3 axis were assessed. The worst scenario for Radiated Spurious Emission as follow:
 Lie Side Stand
- Note 2: Low, mid, and high channels were measured, only the worst channel of each modulation was presented in this report.
- Note 3: The modulation and bandwidth are similar for 802.11n mode for HT20/HT40 and 802.11ac mode for VHT20/VHT40, therefore investigated worst case to representative mode in the test report.
- Note 4: The data rates were selected based on preliminary testing that identified rate as the worst case for output power.
- Note 5: After preliminary test, we present worst case with maximum power of each RU type.
- Note 6: We present worst case (max. power, closest band-edge channel or both) in the report.

3.8. Output Power Setting

Mode	U-NII Band	Centre Frequency (MHz)	Power Setting		Mode	U-NII Band	Centre Frequency (MHz)	Power Setting	
			AUX	Main				AUX	Main
802.11ax-HE20	5	5955	1.500	1.500	802.11ax-HE20	7	6535	0.750	0.750
		6175	1.500	1.500			6695	0.750	0.750
		6415	1.500	1.500			6855	0.750	0.750
	6	6435	1.500	1.500		8	6875	0.750	0.750
		6475	1.500	1.500			6995	0.750	0.750
		6515	1.500	1.500			7115	-3.000	-3.000

Mode	U-NII Band	Centre Frequency (MHz)	Power Setting		Mode	U-NII Band	Centre Frequency (MHz)	Power Setting	
			AUX	Main				AUX	Main
802.11ax-HE40	5	5965	4.750	4.750	802.11ax-HE0	7	6525	4.750	4.750
		6165	4.750	4.750			6685	4.000	4.000
		6405	4.750	4.750			6845	4.000	4.000
	6	6445	4.750	4.750		8	6885	4.000	4.000
		6485	4.750	4.750			7005	4.000	4.000
							7085	4.000	4.000

Mode	U-NII Band	Centre Frequency (MHz)	Power Setting		Mode	U-NII Band	Centre Frequency (MHz)	Power Setting	
			AUX	Main				AUX	Main
802.11ax-HE80	5	5985	7.250	7.250	802.11ax-HE80	7	6625	6.500	6.500
		6145	7.250	7.250			6705	6.500	6.500
		6385	7.250	7.250			6785	6.500	6.500
	6	6465	7.250	7.250		8	6865	6.500	6.500
		6545	7.250	7.250			6945	6.500	6.500
							7025	6.500	6.500

Mode	U-NII Band	Centre Frequency (MHz)	Power Setting		Mode	U-NII Band	Centre Frequency (MHz)	Power Setting	
			AUX	Main				AUX	Main
802.11ax-HE160	5	6025	10.000	10.000	802.11ax-HE160	7	6665	9.250	9.250
		6185	10.000	10.000			6825	9.250	9.250
		6345	10.000	10.000		8	6985	9.250	9.250
	6	6505	10.000	10.000					

3.9. Tested Supporting System List

3.9.1. Support Peripheral Unit

No.	Product	Brand	Model No.	Serial No.	Approval
1.	TV	LG	22LK330-DB	N/A	N/A
2.	USB Mouse	Logitech	M-B0001	N/A	N/A
3.	Earphone	APPLE	N/A	N/A	N/A
4.	SD Card	ADATA	MicroSDHC Card	N/A	N/A
Partner System					
5.	Tri-Band WiFi 6E Router	NETGEAR	RAXE500	N/A	FCC ID: PY320300508
For Contention Based Protocol Test only					
6.	Wireless-AXE11000 Tri-band Gigabit Router	ASUS	GT-AXE1100	N/A	FCC ID: MSR-RTAXJF0

3.9.2. Cable Lists

No.	Cable Description Of The Above Support Units
1.	HDMI Cable: Shielded, Detachable, 1.2m AC Power Cord: Unshielded, Detachable, 1.8m
2.	USB Cable: Unshielded, Undetachable, 1.5m
3.	Earphone Cable: Unshielded, Undetachable, 1.2m
4.	N/A
5.	AC adapter: METGEAR, Model: 2ABS060K, Power Cable: Unshielded, Undetachable, 1.8m LAN cable: Unshielded, Detachable, 3.0m
6.	Adapter: AcBel, ADD011, DC Power cable: Non-shielded, 11.5m, Power Cable: Non-Shielded, 0.9m

3.10. Setup Configuration

3.10.1. EUT Configuration for Power Line & Radiated Emission

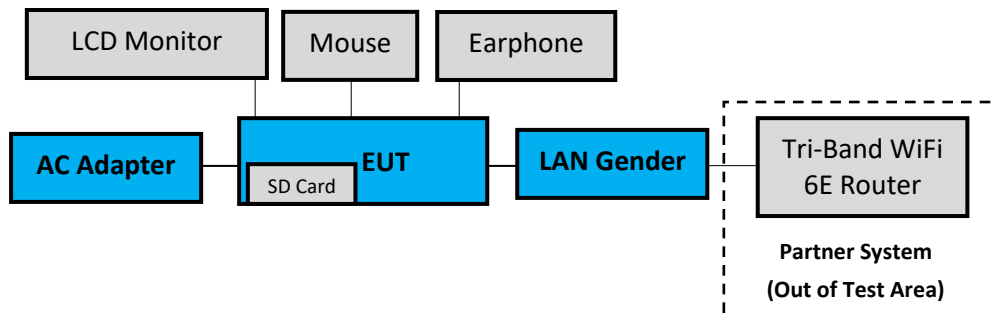

3.10.2. EUT Configuration for RF Conducted Test Items

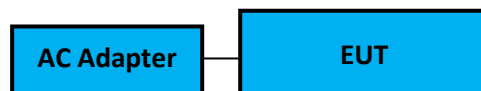

3.11. Operating Condition of EUT

Test program “DRTU” is used for enabling EUT WLAN function under continues transmitting and choosing data rate/ channel.

[ANT AUX port (A Button in DRTU), ANT Main port (B Button in DRTU)].

3.12. Description of Test Facility

Name of Test Firm	Audix Technology Corporation / EMC Department No. 491, Zhongfu Rd., Linkou Dist., New Taipei City 244, Taiwan Tel: +886-2-26092133 Fax: +886-2-26099303 Website : www.audixtech.com Contact e-mail: attemc_report@audixtech.com
Accreditations	The laboratory is accredited by following organizations under ISO/IEC 17025:2017 (1) NVLAP(USA) NVLAP Lab Code 200077-0 (2) TAF(Taiwan) No. 1724
Test Facilities	FCC OET Designation Number under APEC MRA by NCC is : TW1724 ISED CAB Identifier Number under APEC TEL MRA by NCC is TW1724 (1) No.8 Shielded Room (2) No.1 3m Semi Anechoic Chamber

3.13.Measurement Uncertainty

Test Items/Facilities		Frequency Range	Uncertainty	
Conduction Test		9kHz-150kHz	±3.7dB	
		150kHz-30MHz	±3.4dB	
Radiation Test	<input checked="" type="checkbox"/>	No.1 3m Semi Anechoic Chamber	30MHz-200MHz, 3m, Horizontal	±3.8dB
			200MHz-1000MHz, 3m, Horizontal	±4.1dB
			30MHz-200MHz, 3m, Vertical	±4.5dB
			200MHz-1000MHz, 3m, Vertical	±4.5dB
			1GHz-6GHz, 3m	±4.7dB
			6GHz-18GHz, 3m	±4.1dB
			18GHz-40GHz, 3m	±3.52dB
	<input type="checkbox"/>	No.3 3m Semi Anechoic Chamber	30MHz-200MHz, 3m, Horizontal	±3.9dB
			200MHz-1000MHz, 3m, Horizontal	±4.2dB
			30MHz-200MHz, 3m, Vertical	±4.3dB
			200MHz-1000MHz, 3m, Vertical	±4.5dB
			30MHz-200MHz, 3m, Horizontal	±4.1dB
			200MHz-1000MHz, 3m, Horizontal	±4.5dB
	<input type="checkbox"/>	No.4 3m Semi Anechoic Chamber	30MHz-200MHz, 3m, Vertical	±4.4dB
			200MHz-1000MHz, 3m, Vertical	±4.8dB
			1GHz-6GHz, 3m	±5.0dB
			6GHz-18GHz, 3m	±4.7dB
			30MHz-200MHz, 3m, Horizontal	±4.2dB
			200MHz-1000MHz, 3m, Horizontal	±4.3dB
	<input type="checkbox"/>	No.5 3m Semi Anechoic Chamber	30MHz-200MHz, 3m, Vertical	±4.3dB
			200MHz-1000MHz, 3m, Vertical	±4.7dB
			1GHz-6GHz, 3m	±4.8dB
			6GHz-18GHz, 3m	±4.5dB

Remark : Uncertainty = $ku_c(y)$

Test Items	Uncertainty
Maximum Power Spectral Density	± 0.52dB
Maximum Conducted Output Power	± 0.72dB
Emission Bandwidth	± 0.38%
Contention Based Protocol	± 2%

4. MEASUREMENT EQUIPMENT LIST

4.1. Conducted Emission Measurement

Item	Type	Manufacturer	Model No.	Serial No.	Cal. Date	Cal. Interval
1.	Test Receiver	R&S	ESR3	101774	2022. 01. 11	1 Year
2.	A.M.N.	R&S	ENV432	101567	2022. 05. 26	1 Year
3.	L.I.S.N.	Kyoritsu	KNW-407	8-855-9	2021. 12. 19	1 Year
4.	Pulse Limiter	R&S	ESH3-Z2	100354	2021. 12. 23	1 Year
5.	Digital Thermo-Hygro Meter	iMax	HTC-1	No.8 S/R	2022. 04. 14	1 Year
6.	Coaxial Cable	Yeida	RG/58AU	CE-08	2021. 09. 13	1 Year
7.	Test Software	Audix	e3	V6.120619c	N.C.R.	N.C.R.

4.2. Radiated Emission Measurement

Item	Type	Manufacturer	Model No.	Serial No.	Cal. Date	Cal. Interval
1.	Spectrum Analyzer	Agilent	N9010A-526	MY53400071	2021. 09. 09	1 Year
2.	Spectrum Analyzer	Keysight	N9010B-544	MY55460198	2022. 04. 08	1 Year
3.	Test Receiver	R&S	ESCS30	100338	2022. 06. 15	1 Year
4.	Amplifier	HP	8447D	2944A06305	2022. 01. 05	1 Year
5.	Microwave Amplifier	Keysight	83051A	MY53010042	2021. 07. 30	1 Year
6.	Microwave Amplifier	HP	8449B	3008A01284	2022. 06. 01	1 Year
7.	Loop Antenna	ETS LINDGREN	6512	00035867	2021. 09. 29	1 Year
8.	Bilog Antenna	TESEQ	CBL6112D	33821	2022. 07. 01	1 Year
9.	Double-Ridged Waveguide Horn	EMCO	3115	9112-3775	2022. 05. 18	1 Year
10.	Horn Antenna	COM-POWE R	AH-840	101092	2022. 01. 06	1 Year
11.	Notch Filter	Warison	WFIL-N5925 -6425F	WR61CFWC4 B1	2022. 01. 14	1 Year
12.	Notch Filter	Warison	WFIL-N6425 -6525F	WR61CFWC6 B1	2022. 01. 14	1 Year
13.	Notch Filter	Warison	WFIL-N6525 -6875F	WR61CFWC8 B1	2022. 01. 14	1 Year
14.	Notch Filter	Warison	WFIL-N6875 -7125F	WR61CFWC2 B1	2022. 01. 14	1 Year
15.	Coaxial Cable	MIYAZAKI	5D2W	RE-11	2022. 01. 20	1 Year
16.	Coaxial Cable	HUBER+SU HNER	SUCOFLEX 106	RE-14	2022. 01. 20	1 Year
17.	Coaxial Cable	HUBER+SU HNER	SUCOFLEX 102	RE-30	2021. 08. 25	1 Year
18.	Digital Thermo-Hygro Meter	iMax	HTC-1	No.1 3m A/C	2022. 04. 14	1 Year
19.	Test Software	Audix	e3	V6.120619c	N.C.R.	N.C.R.

4.3. RF Conducted Measurement

Item	Type	Manufacturer	Model No.	Serial No.	Cal. Date	Cal. Interval
1.	Spectrum Analyzer	Keysight	N9020B-544	MY57120357	2022. 03. 02	1 Year
2.	Power Meter	Anritsu	ML2495A	1145008	2022. 06. 22	1 Year
3.	Power Sensor	Anritsu	MA2411B	1126096	2022. 06. 22	1 Year
4.	MXG RF Vector Signal Generator	Agilent	N5182B	MY53050409	2022. 02. 15	1 Year
5.	Digital Thermo-Hygro Meter	iMax	HTC-1	RF-03	2021. 04. 15	1 Year

4.4. Contention Based Protocol Measurement

Item	Type	Manufacturer	Model No.	Serial No.	Cal. Date	Cal. Interval
1.	Spectrum Analyzer	Keysight	N9030B	MY61330403	2021. 12. 21	1 Year
2.	MXG RF Vector Signal Generator	Agilent	N5182B	MY53050409	2022. 02. 15	1 Year
3.	Frequency Extender	KEYSIGHT	N5182BX07	MY59362533	2021. 11.07	1 Year
4.	CBP Test Unit	KEYSIGHT	N/A	N/A	N.C.R.	N.C.R.
5.	Digital Thermo-Hygro Meter	iMax	HTC-1	RF-03	2022. 04. 14	1 Year

5. CONDUCTED EMISSION

5.1. Block Diagram of Test Setup

5.1.1. Block Diagram of EUT

Indicated as section 3.10

5.1.2. Shielded Room Setup Diagram

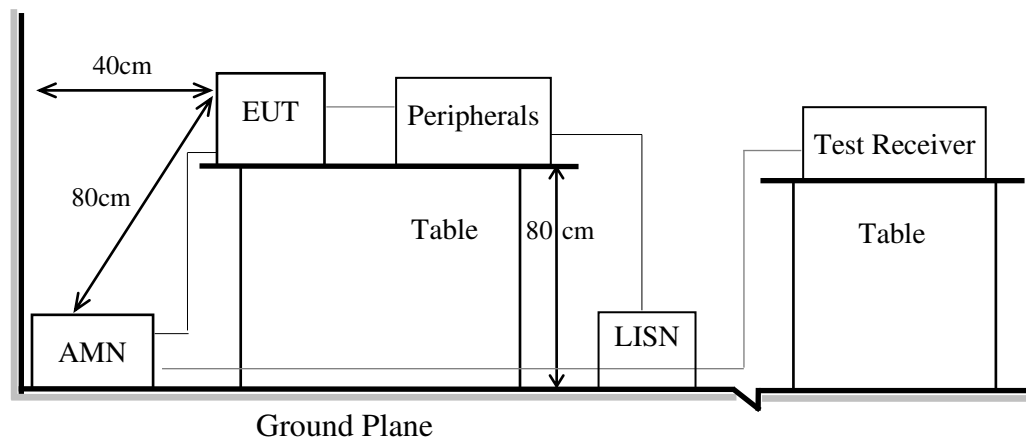

5.2. Conducted Emission Limit

Frequency	Conducted Limit	
	Quasi-Peak Level	Average Level
150kHz ~ 500kHz	66 ~ 56 dB μ V	56 ~ 46 dB μ V
500kHz ~ 5MHz	56 dB μ V	46 dB μ V
5MHz ~ 30MHz	60 dB μ V	50 dB μ V

Remark 1.: If the average limit is met when using a Quasi-Peak detector, the measurement using the average detector is not required.

2.: The lower limit applies to the band edges.

5.3. Test Procedure

- 5.3.1. To set up the EUT as indicated in ANSI C63.10. The EUT was placed on the table which has 80 cm height to the ground and 40 cm distance to the conducting wall.
- 5.3.2. Power supplier of the EUT was connected to the AC mains through an Artificial Mains Network (A.M.N.).
- 5.3.3. The AC power supplies to all peripheral devices must be provided through line impedance stabilization network (L.I.S.N.)
- 5.3.4. Checking frequency range from 150 kHz to 30 MHz and record the emission which does not have 20 dB below limit.

5.4. Test Results

Please refer to Appendix A.

6. RADIATED EMISSION

6.1. Block Diagram of Test Setup

6.1.1. Block Diagram of EUT

Indicated as section 3.10

6.1.2. Setup Diagram for 9kHz-30MHz

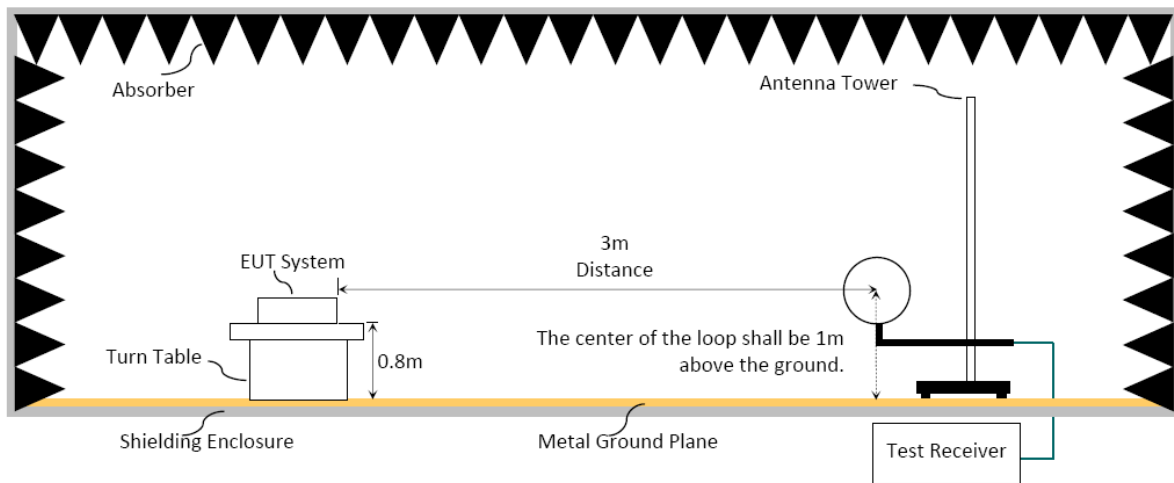

6.1.3. Setup Diagram for 30-1000MHz

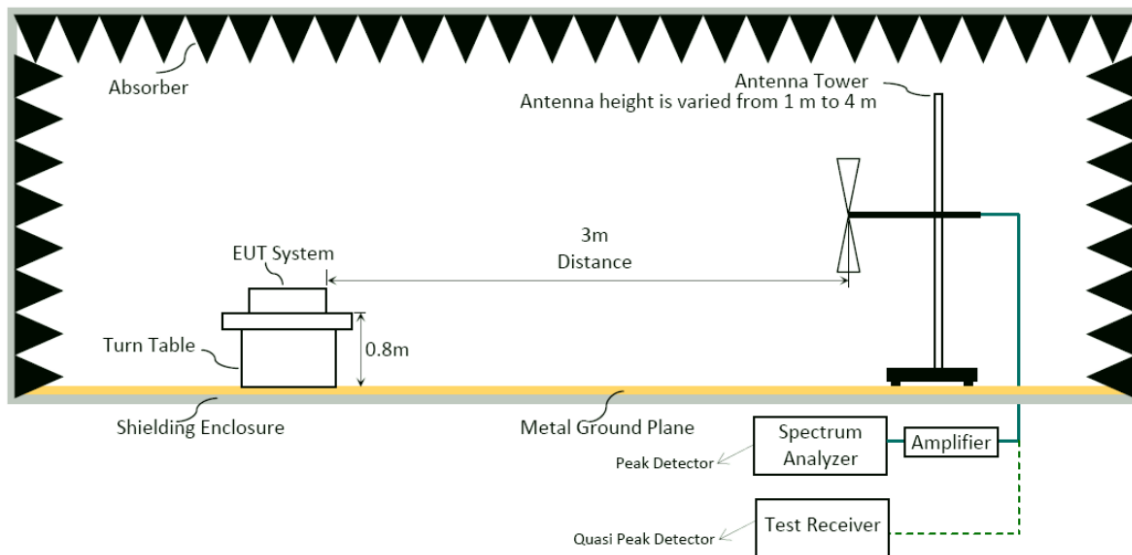

6.1.4. Setup Diagram for above 1GHz

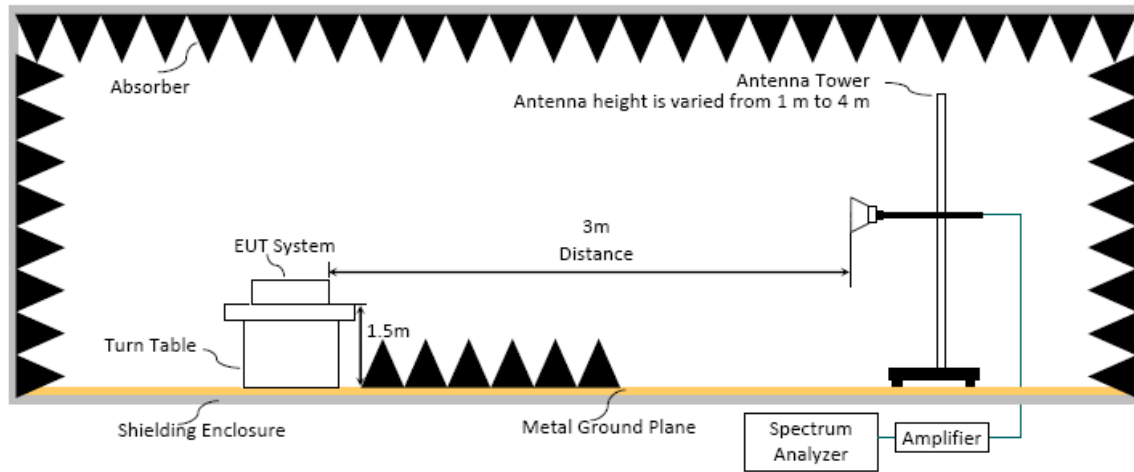

6.2. Radiated Emission Limits

Radiated emissions fall in restricted bands, as defined in FCC Section 15.205/RSS-Gen Section 8.10 table 7 must be in compliance with the radiated emission limits specified in FCC Section 15.209/RSS-Gen Section 8.9 table 6 as below.

6.2.1. General Limit

Frequency (MHz)	Distance(m)	Limits	
		dB μ V/m	μ V/m
0.009 - 0.490	300	67.6-20 log f(kHz)	2400/f kHz
0.490 - 1.705	30	87.6-20 log f(kHz)	24000/f kHz
1.705 - 30	30	29.5	30
30 - 88	3	40.0	100
88- 216	3	43.5	150
216- 960	3	46.0	200
Above 960	3	54.0	500
Above 1000	3	74.0 dB μ V/m (Peak) 54.0 dB μ V/m (Average)	

Remark : (1) dB μ V/m = 20 log (μ V/m)

- (2) The tighter limit applies to the edge between two frequency bands.
- (3) Distance refers to the distance in meters between the measuring instrument antenna and the closed point of any part of the device or system.
- (4) Fundamental and emission fall within operation band are exempted from this section.
- (5) Pursuant to ANSI C63.10: 6.6.4.3, if the maximized peak measured value complies with the average limit, then it is unnecessary to perform an average measurement.

6.2.2. Limit for non-restricted frequency above 1 GHz

Frequency Band (MHz)	E.I.R.P. Limit	Field Strength Limit at 3 m
Out of 5925 to 7125	-27 dBm/MHz	68.2 dB μ V/m

Note: Field Strength at 3 m= E.I.R.P. + 95.2 dB

6.3. Test Procedure

Frequency Range 9kHz~30MHz:

The EUT setup on the turntable which has 0.8 m height to the ground. The turn table rotated 360 degrees and antenna fixed to 1 m to find the maximum emission level. In order to find the maximum emission, all of the interface cables were manipulated according to ANSI C63.10-2013 regulation.

- (1) RBW = 9kHz with peak and average detector.
- (2) Detector: average and peak (9kHz-490kHz)
Q.P. (490kHz-30MHz)

Frequency Range 30MHz ~ 40GHz:

The EUT setup on the turn table which has 80cm (for 30-1000MHz) and 1.5m (for above 1GHz) height to the ground. The turn table rotated 360 degrees and antenna varied from 1 m to 4 m to find the maximum emission level. Both horizontal and vertical polarization are required. In order to find the maximum emission, all of the interface cables were manipulated according to ANSI C63.10-2013 regulation.

6.3.1. Radiated measurement Spectrum Analyzer Setting

6.3.1.1 Frequency below 1GHz:

Spectrum Analyzer is used for pre-testing with following setting:

- (1) RBW = 120kHz
- (2) VBW $\geq 3 \times$ RBW.
- (3) Detector = Peak.
- (4) Sweep time = auto.
- (5) Trace mode = max hold.
- (6) Allow sweeps to continue until the trace stabilizes.

Note 1: When peak-detected value is lower than limit that the measurement using the Q.P. detector is not required, otherwise using Q.P. for final measurement.

Note 2: When the radiated emissions limits are expressed in terms of the average value of the emissions, and pulsed operation is employed, the measurement field strength shall be determined by averaging over one complete pulse train, including blanking intervals, as long as the pulse train does not exceed 0.1 seconds.

6.3.1.2 Frequency above 1GHz to 10th harmonic (up to 40 GHz):

Peak Detector:

- (1) RBW = 1MHz
- (2) VBW $\geq 3 \times$ RBW.
- (3) Detector = Peak.
- (4) Sweep time = auto.
- (5) Trace mode = max hold.
- (6) Allow sweeps to continue until the trace stabilizes.

Note: When peak-detected value is lower than limit that the measurement using the average detector is not required, otherwise using average detector for final measurement.

Average Detector:

Option 1:

- (1) RBW = 1MHz
- (2) VBW \geq 1/ T.

Modulation Type	TX _{on} (ms)	1/ TX _{on} (kHz)	VBW Setting
802.11ax-HE20	2.576	0.388	10Hz
802.11ax-HE40	2.580	0.388	10Hz
802.11ax-HE80	2.590	0.386	10Hz
802.11ax-HE160	2.300	0.435	10Hz

N/A: 1/ TX_{on} is not implemented when duty cycle presented in section 3.6 is \geq 98%.

- (1) Detector = Peak.
- (2) Sweep time = auto.
- (3) Trace mode = max hold.
- (4) Allow sweeps to continue until the trace stabilizes.

Option 2:

Average Emission Level= Peak Emission Level+ D.C.C.F.

6.3.2. Radiated band edge measurement Spectrum Analyzer Setting

For without 99% OBW edge within 2 MHz of the authorized band edge:

The spectrum analyzer setting, please refer to section 6.3.1.2

For with 99% OBW edge within 2 MHz of the authorized band edge:

Per KDB 789033 Section G.3.d and ANSI C63.10 -2013 6.10.4, SA setting as below:

a. Fundamental field strength of SA setting:

The spectrum analyzer setting, please refer to section 6.3.1.2

b. Delta of SA setting:

- (1) RBW = 1% SPAN but no less than 30 KHz
(In this case, RBW = 500 KHz)
- (2) VBW \geq 3 x RBW.
- (3) Detector = Peak.
- (4) Sweep time = auto.
- (5) Trace mode = max hold.
- (6) Allow sweeps to continue until the trace stabilizes.

Correction Factor(Via delta, dB)= Fundamental Emission Level(dB μ V/m)@RBW 500KHz- Band Edge Emission Level(dB μ V/m)@RBW 500kHz

Band Edge Emission Level (dB μ V/m) =
Fundamental Emission Level (dB μ V/m)@RBW 1MHz – Marker Delta (dB)

6.4. Measurement Result Explanation

- Peak Emission Level (dB μ V/m) = Antenna Factor (dB/m) + Cable Loss (dB) + Meter Reading (dB μ V) (including Preamp factor if test used)
- Average Emission Level (dB μ V/m) = Antenna Factor (dB/m) + Cable Loss (dB) + Meter Reading (dB μ V) (including Preamp factor if test used)
- Average Emission Level (dB μ V/m) = Peak Emission Level (dB μ V/m) + DCCF (dB)
Duty Cycle Correction Factor (DCCF) = $20\log(TX_{on}/TX_{on+off})$ presented in section 3.6.
- ERP = Peak Emission Level (dB μ V/m) - 95.2dB - 2.14dB
- Band Edge Emission Level (dB μ V/m) = Fundamental Emission Level (dB μ V/m) - Maker-Delta (dB)

6.5. Test Results

Please refer to Appendix A.

7. MAXIMUM POWER SPECTRAL DENSITY

7.1. Block Diagram of Test Setup

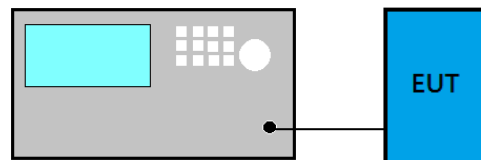

7.2. Specification Limits

For client devices operating under the control of an indoor access point in the 5.925-7.125 GHz bands, the maximum power spectral density must not exceed -1dBm e.i.r.p. in any 1-megahertz band

7.3. Test Procedure

Following measurement procedure is reference to KDB 789033 D02 General UNII Test Procedures New Rules v02r01:

■ Method AVGSA-2 (Spectrum channel power)

- (1) Set span to at least 1.5 times the OBW
- (2) Set RBW = 1 MHz
- (3) Set the video bandwidth (VBW) \geq 3 MHz.
- (4) Detector = RMS.
- (5) Trace mode = trace average at least 100 traces
- (6) Sweep = auto couple.
- (7) Use peak search function to find out the maximum power density.
- (8) Duty cycle factor is added when duty cycle presented in section 3.6 is $<$ 98%.

For power density emission measurements from multiple outputs of a transmitter or from multiple transmitters: Please refer to KDB 662911 E 2) c).

7.4. Test Results

Please refer to Appendix A

8. MAXIMUM CONDUCTED OUTPUT POWER

8.1. Block Diagram of Test Setup

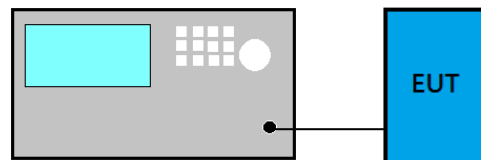

8.2. Specification Limits

For client devices operating under the control of an indoor access point in the 5.925-7.125 GHz bands, the maximum e.i.r.p. over the frequency band of operation must not exceed 24 dBm.

8.3. Test Procedure

Following measurement procedure is reference to KDB 789033 D02 General UNII Test Procedures New Rules v02r01:

■ **Method AVGPM (Measurement using an RF average power meter):**

EUT is connected to power sensor and record the maximum average output power and duty cycle factor is added when duty cycle presented in section 3.6 is < 98%.

■ **Method AVGSA-2 (Spectrum channel power) for 802.11ac-VHT80/160, 802.11ax-HE80/160 modes only**

- (1) Set span to at least 1.5 times the OBW
- (2) Set RBW = 1 MHz
- (3) Set the video bandwidth (VBW) \geq 3 MHz.
- (4) Detector = RMS.
- (5) Trace mode = trace average at least 100 traces
- (6) Sweep = auto couple.
- (7) Compute power by integrating the spectrum across the OBW of the signal using the instrument's band power measurement function with band limits set equal to the OBW band edges.
- (8) Duty cycle factor is added when duty cycle presented in section 3.7 is < 98%.

8.4. Test Results

Please refer to Appendix A

9. EMISSION/OCCUPIED BANDWIDTH

9.1. Block Diagram of Test Setup

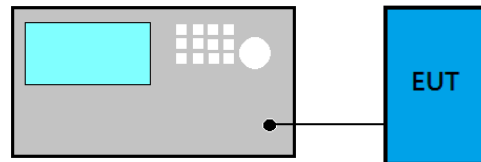

9.2. Specification Limits

The maximum transmitter channel bandwidth for U-NII devices in the 5.925-7.125 GHz band is 320 megahertz

9.3. Test Procedure

Following measurement procedure is reference to KDB 789033 D02 General UNII Test Procedures New Rules v02r01:

- (1) Set RBW = 1% of the emission bandwidth
- (2) Set VBW > RBW
- (3) Detector = Peak
- (4) Trace mode = max hold
- (5) Setting channel bandwidth function x dB to -26 dB to record the final bandwidth.

9.4. Test Results

Please refer to Appendix A

10. UNDERSIRABLE EMISSIONS LIMITS: SPURIOUS EMISSION (CONDUCTED)

10.1. Block Diagram of Test Setup

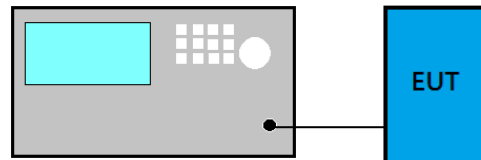

10.2. Spurious Emission Specification Limits

For transmitters operating within the 5.925-7.125 GHz band: Any emissions outside of the 5.925- 7.125 GHz band must not exceed an e.i.r.p. of -27 dBm/MHz.

Unless otherwise specified, on any frequency or frequencies above 1000 MHz, the radiated emission limits are based on the use of measurement instrumentation employing an average detector function. Unless otherwise specified, measurements above 1000 MHz shall be performed using a minimum resolution bandwidth of 1 MHz. When average radiated emission measurements are specified in this part, including average emission measurements below 1000 MHz, there also is a limit on the peak level of the radio frequency emissions. Unless otherwise specified, e.g., see FCC Part §§ 15.250, 15.252, 15.253(d), 15.255, 15.256, and 15.509 through 15.519, the limit on peak radio frequency emissions is 20 dB above the maximum permitted average emission limit applicable to the equipment under test. This peak limit applies to the total peak emission level radiated by the device, e.g., the total peak power level

10.3. Test Procedure

Please refer to KDB 789033 D02 v02r01 G5

For spurious emission measurements from multiple outputs of a transmitter or from multiple transmitters: Please refer to KDB 662911 E 3) a) (iii).

10.4. Test Results

Please refer to Appendix A

11. IN-BAND EMISSION (CHANNEL MASK)

11.1. Block Diagram of Test Setup

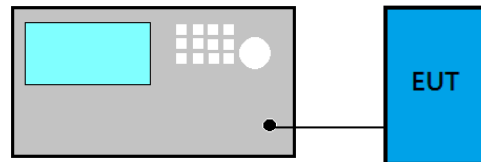

11.2. Specification Limits

For transmitters operating within the 5.925-7.125 GHz bands: Power spectral density must be suppressed by 20 dB at 1 MHz outside of channel edge, by 28 dB at one channel bandwidth from the channel center, and by 40 dB at one- and one-half times the channel bandwidth away from channel center. At frequencies between one megahertz outside an unlicensed device's channel edge and one channel bandwidth from the center of the channel, the limits must be linearly interpolated between 20 dB and 28 dB suppression, and at frequencies between one and one- and one-half times an unlicensed device's channel bandwidth, the limits must be linearly interpolated between 28 dB and 40 dB suppression. Emissions removed from the channel center by more than one- and one-half times the channel bandwidth must be suppressed by at least 40 dB.

11.3. Test Procedure

Following measurement procedure is reference to KDB 987594 D02 U-NII 6GHz EMC Measurement v01v01:

Measure the power spectral density (which will be used for emissions mask reference) using the following procedure:

- (a) Set the span to encompass the entire 26 dB EBW of the signal.
- (b) Set RBW = same RBW used for 26 dB EBW measurement.
- (c) Set VBW $\geq 3 \times$ RBW
- (d) Number of points in sweep $\geq (2 \times \text{span} / \text{RBW})$.
- (e) Sweep time = auto.
- (f) Detector = RMS (i.e., power averaging)
- (g) Trace average at least 100 traces in power averaging (rms) mode.
- (h) Use the peak search function on the instrument to find the peak of the spectrum.

- (1) Using the measuring equipment limit line function, develop the emissions mask based on the following requirements. The emissions power spectral density must be reduced below the peak power spectral density (in dB) as follows:
 - (a) Suppressed by 20 dB at 1 MHz outside of the channel edge.
 - (b) Suppressed by 28 dB at one channel bandwidth from the channel center.
 - (c) Suppressed by 40 dB at one- and one-half times the channel bandwidth from the channel center.
- (2) Adjust the span to encompass the entire mask as necessary.
- (3) Clear trace.
- (4) Trace average at least 100 traces in power averaging (rms) mode.
- (5) Adjust the reference level as necessary so that the crest of the channel touches the top of the emission mask.

11.4. Test Results

Please refer to Appendix A

12. CONTENTION BASED PROTOCOL

12.1. Block Diagram of Test Setup

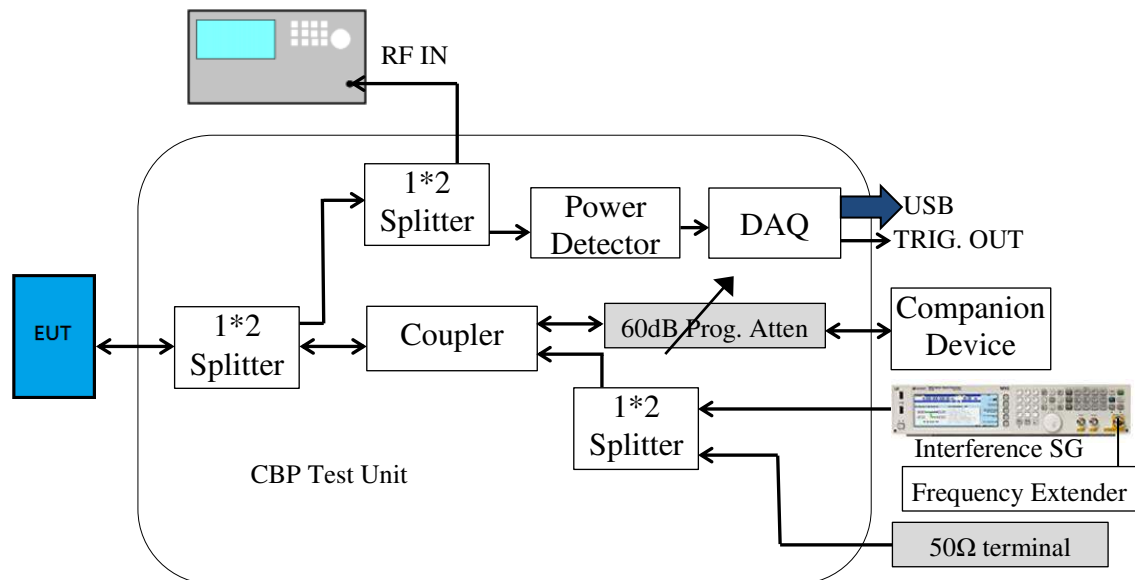

12.2. Specification Limits

Indoor access points, subordinate devices and client devices operating in the 5.925-7.125 GHz band must employ a contention-based protocol

FCC KDB 987594 D02 U-NII 6GHz EMC Measurement v01v01

Unlicensed low-power indoor devices must detect co-channel radio frequency power that is at least -62 dBm or lower. Upon detection of energy in the band, unlicensed low power indoor devices must vacate the channel (in which incumbent signal is transmitted) and stay off the incumbent channel as long as detected radio frequency power is equal to or greater than the threshold (-62 dBm)1. The -62 dBm (or lower) threshold is referenced to a 0 dBi antenna gain

To ensure incumbent operations are reliably detected in the band, low power indoor devices must detect RF energy throughout their intended operating channel. For example, an 802.11 device that plans to transmit a 40 MHz- wide signal (on a primary 20 MHz channel and a secondary 20 MHz channel) must detect energy throughout the entire 40 MHz channel. Additionally, low-power indoor devices must detect co-channel energy with 90% or greater certainty.

Table 1. Criteria to determine number of times detection threshold test may be performed

If	Number of Tests	Placement of Incumbent Transmission
$BW_{EUT} \leq BW_{Inc}$	One	Tune incumbent and EUT transmission ($f_{c1} = f_{c2}$)
$BW_{Inc} < BW_{EUT} \leq 2BW_{Inc}$	One	Incumbent transmission is contained within BW_{EUT}
$2BW_{Inc} < BW_{EUT} \leq 4BW_{Inc}$	Twice. Incumbent transmission is contained within BW_{EUT}	Incumbent transmission is located as closely as possible to the lower edge and upper edge, respectively, of the EUT channel
$BW_{EUT} > 4BW_{Inc}$	Three times	Incumbent transmission is located as closely as possible to the lower edge of the EUT channel, in the middle of EUT channel, and as closely as possible to the upper edge of the EUT channel

Where:

BW_{EUT} : Transmission bandwidth of EUT signal

BW_{Inc} : Transmission bandwidth of the simulated incumbent signal (10 MHz wide AWGN signal)

f_{c1} : Center frequency of EUT transmission

f_{c2} : Center frequency of simulated incumbent signal

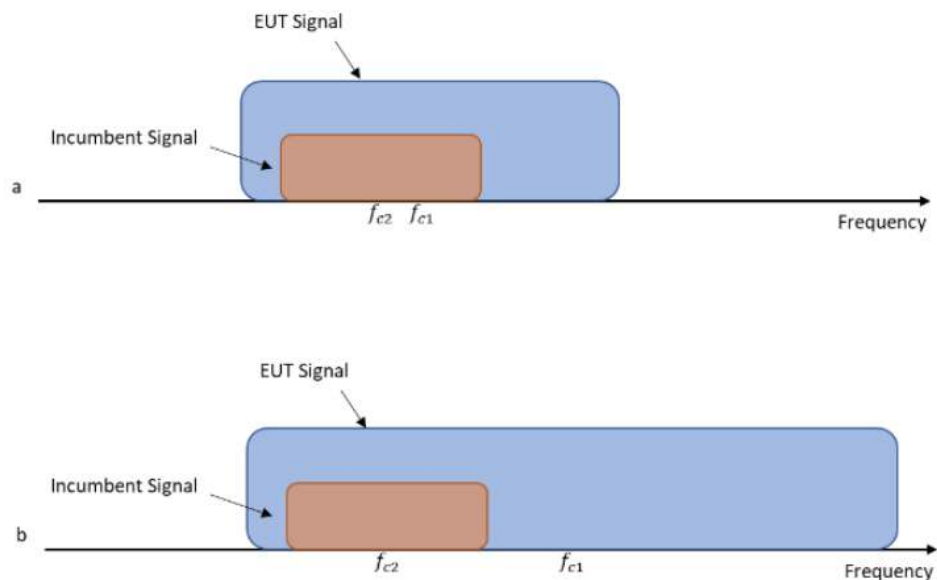

Figure 1. Two possible scenarios where a) center frequency of EUT transmission falls within incumbent's bandwidth, or b) outside of it

12.3. Test Procedure

Following measurement procedure is reference to KDB 987594 D02 U-NII 6GHz EMC Measurement v01v01:

- (1) To ensure EUT reliably detects an incumbent signal in both scenarios shown in Figure 1, the detection threshold test may be repeated more than once with the incumbent signal (having center frequency f_{c2}) tuned to different center frequencies within the UT transmission bandwidth. The criteria specified in Table 1 determines how many times the detection threshold test must be performed
- (2) Using an AWGN signal source, generate (but do not transmit, i.e., RF OFF) a 10 MHz-wide AWGN signal. Use Table 1 to determine the center frequency of the 10 MHz AWGN signal relative to the EUT's channel bandwidth and center frequency.
- (3) Monitor the signal analyzer to verify if the AWGN signal has been detected and the EUT has ceased transmission. If the EUT continues to transmit, then incrementally increase the AWGN signal power level until the EUT stops transmitting.
- (4) (Including all losses in the RF paths) Determine and record the AWGN signal power level (at the EUT's antenna port) at which the EUT ceased transmission. Repeat the procedure at least 10 times to verify the EUT can detect an AWGN signal with 90% (or better) level of certainty.
- (5) Refer to Table 1 to determine number of times the detection threshold testing needs to be repeated. If testing is required more than once, then go back to step 2, choose a different center frequency for the AWGN signal and repeat the process.
- (6) The test tool is "LAN test" to let the EUT to transmit with a constant duty cycle.

12.4. Test Results

Please refer to Appendix A

13.DEVIATION TO TEST SPECIFICATIONS

【NONE】



*Audix Technology Corp.
No. 491, Zhongfu Rd., Linkou Dist.,
New Taipei City 244, Taiwan*

*Tel: +886 2 26099301
Fax: +886 2 26099303*

APPDNDIX A

TEST DATA AND PLOTS

(Model: 15ZB90Q)

TABLE OF CONTENTS

A.1 CONDUCTED EMISSION	2
A.2 RADIATED EMISSION	4
A.2.1 Emissions within Restricted Frequency Bands.....	4
A.2.2 Emissions outside the frequency band.....	52
A.2.3 Emissions in Non-restricted Frequency Bands.....	74
A.3 MAXIMUM POWER SPECTRAL DENSITY	75
A.3.1 Power Spectral Density Result	75
A.3.2 Measurement Plots	77
A.4 MAXIMUM CONDUCTED OUTPUT POWER	93
A.4.1 Conducted Output Power Result	93
A.4.2 Measurement Plots	106
A.5 EMISSION/OCCUPIED BANDWIDTH	123
A.5.1 Emission/Occupied Bandwidth Result	123
A.5.2 Measurement Plots	124
A.6 UNDESIRABLE EMISSION LIMITS: SPURIOUS EMISSION (CONDUCTED)	138
A.7 IN-BAND EMISSION (CHANNEL MASK)	141
A.8 CONTENTION BASED PROTOCOL	157
A.8.1 Contention-based Protocol.....	157
A.8.2 Measurement Plots	160

A.1 CONDUCTED EMISSION

Test Date	2022/07/13	Temp./Hum.	26°C/47%
Test Voltage	AC 120V 60Hz (Via AC Adapter)	Tested By	Roy Hung

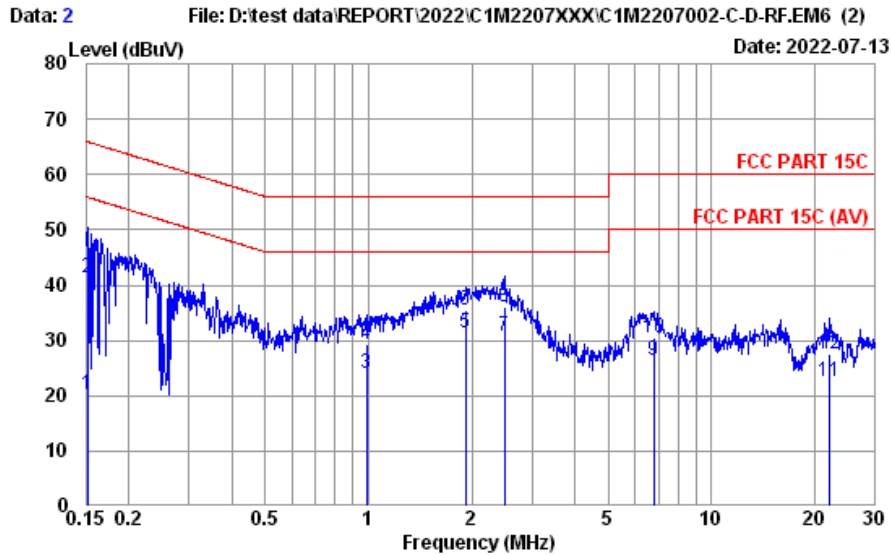

Site No.	: No.8 Shielded Room	Data No.	: 2
Instrument 1	: Receiver ESR3(774)		
Instrument 2	: EHV432 (567)(A) CE-08 ESH3-Z2 (354)		
Limit	: FCC PART 15C	Phase	: NEUTRAL
Environment	: 26°C / 47%	Engineer	: Roy Hung
EUT Model	: 15ZB90Q	Test Rating	: 120Vac/60Hz
Test Mode	: Operating		

	Freq. (MHz)	AMI Factor (dB)	Cable Loss (dB)	Pulse Att. (dB)	Reading (dBμV)	Emission Level (dBμV)	Limits (dBμV)	Margin (dB)	Remark
1	0.152	10.34	0.03	9.85	-0.05	20.17	55.91	35.74	Average
2	0.152	10.34	0.03	9.85	21.10	41.32	65.91	24.59	QP
3	0.989	10.34	0.04	9.85	3.92	24.15	46.00	21.85	Average
4	0.989	10.34	0.04	9.85	8.98	29.21	56.00	26.79	QP
5	1.918	10.36	0.06	9.86	10.98	31.26	46.00	14.74	Average
6	1.918	10.36	0.06	9.86	15.23	35.51	56.00	20.49	QP
7	2.487	10.37	0.07	9.86	10.49	30.79	46.00	15.21	Average
8	2.487	10.37	0.07	9.86	15.76	36.06	56.00	19.94	QP
9	6.769	10.53	0.11	9.87	5.88	26.39	50.00	23.61	Average
10	6.769	10.53	0.11	9.87	10.04	30.55	60.00	29.45	QP
11	21.946	11.12	0.20	9.95	1.29	22.56	50.00	27.44	Average
12	21.946	11.12	0.20	9.95	6.25	27.52	60.00	32.48	QP

Remarks: 1. Emission Level= AMI Factor + Cable Loss + Pulse Att. + Reading.
 2. If the average limit is met when using a quasi-peak detector, the EUT shall be deemed to meet both limits and measurement with average detector is unnecessary.

Test Date	2022/07/13	Temp./Hum.	26°C/47%
Test Voltage	AC 120V 60Hz (Via AC Adapter)	Tested By	Roy Hung

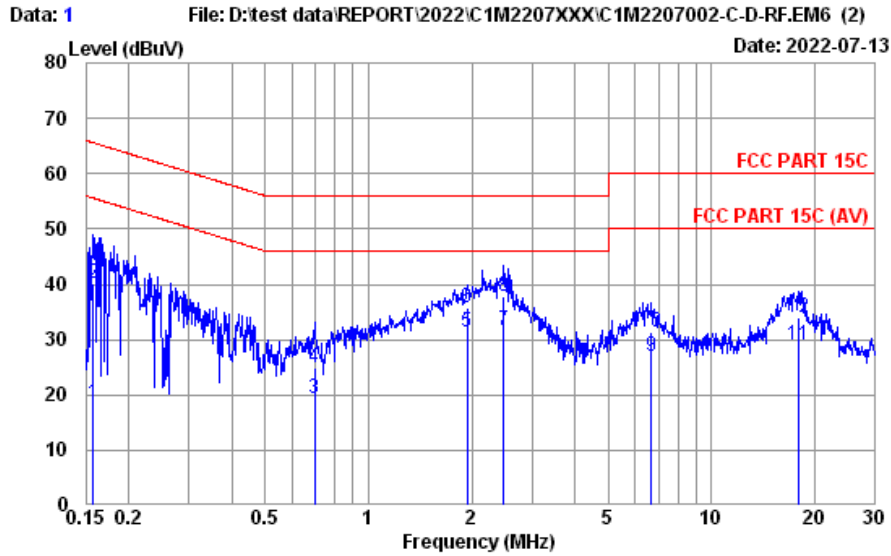

Site No. : No.8 Shielded Room Data No. : 1
 Instrument 1 : Receiver ESR3(774)
 Instrument 2 : EHV432 (567)(A)|CE-08|ESH3-Z2 (354)
 Limit : FCC PART 15C Phase : LINE
 Environment : 26°C / 47% Engineer : Roy Hung
 EUT Model : 15ZB90Q Test Rating : 120Vac/60Hz
 Test Mode : Operating

	Freq. (MHz)	AMN Factor (dB)	Cable Loss (dB)	Pulse Att. (dB)	Reading (dBµV)	Emission Level (dBµV)	Limits (dBµV)	Margin (dB)	Remark
1	0.157	10.22	0.03	9.85	-1.69	18.41	55.60	37.19	Average
2	0.157	10.22	0.03	9.85	20.18	40.28	65.60	25.32	QP
3	0.697	10.23	0.04	9.85	-0.83	19.29	46.00	26.71	Average
4	0.697	10.23	0.04	9.85	4.82	24.94	56.00	31.06	QP
5	1.939	10.25	0.06	9.86	11.31	31.48	46.00	14.52	Average
6	1.939	10.25	0.06	9.86	15.67	35.84	56.00	20.16	QP
7	2.474	10.26	0.07	9.86	11.32	31.51	46.00	14.49	Average
8	2.474	10.26	0.07	9.86	17.52	37.71	56.00	18.29	QP
9	6.662	10.36	0.11	9.87	6.48	26.82	50.00	23.18	Average
10	6.662	10.36	0.11	9.87	11.07	31.41	60.00	28.59	QP
11	17.849	10.60	0.18	9.93	8.24	28.95	50.00	21.05	Average
12	17.849	10.60	0.18	9.93	13.24	33.95	60.00	26.05	QP

Remarks: 1. Emission Level= AMN Factor + Cable Loss + Pulse Att. + Reading.
 2. If the average limit is met when using a quasi-peak detector,
 the EUT shall be deemed to meet both limits and measurement
 with average detector is unnecessary.

A.2 RADIATED EMISSION

Test Date	2022/07/11	Temp./Hum.	23°C/58%
Test Voltage	AC 120V 60Hz (Via AC Adapter)	Tested By	Hua Wu

A.2.1 Emissions within Restricted Frequency Bands

A.2.1.1 Frequency 9kHz~30MHz

The emissions (9kHz~30MHz) not reported for there is no emission be found.

A.2.1.2 Frequency Below 1GHz

Mode	802.11ax-HE160	U-NII Band	5
		Frequency	TX 6345MHz

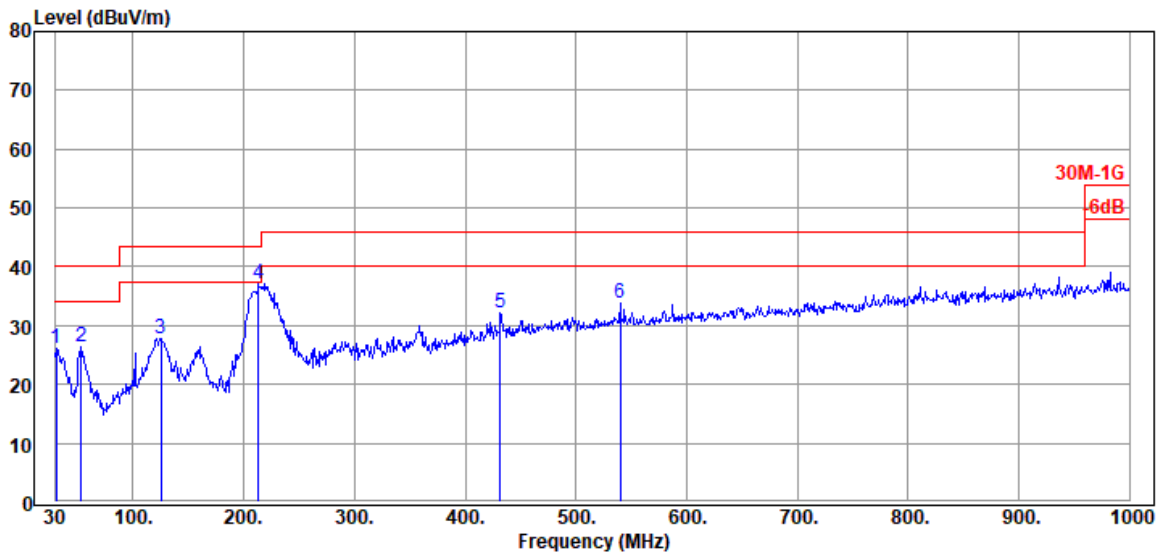

Antenna at Horizontal Polarization

Emission Frequency (MHz)	Antenna Factor (dB/m)	Cable Loss (dB)	Preamplifier Gain (dB)	Read Level (dBμV)	Emission Level (dBμV/m)	Limits (dBμV/m)	Margin (dB)	Detector
30.970	23.26	1.43	26.49	28.00	26.20	40.00	13.80	Peak
53.280	13.34	1.89	26.44	37.56	26.35	40.00	13.65	Peak
125.060	17.71	2.92	26.13	33.25	27.75	43.50	15.75	Peak
213.330	15.97	3.86	25.76	43.17	37.24	43.50	6.26	Peak
431.580	21.97	6.21	26.68	30.70	32.20	46.00	13.80	Peak
540.220	23.61	6.90	27.24	30.48	33.75	46.00	12.25	Peak

Mode	802.11ax-HE160	U-NII Band	5
		Frequency	TX 6345MHz

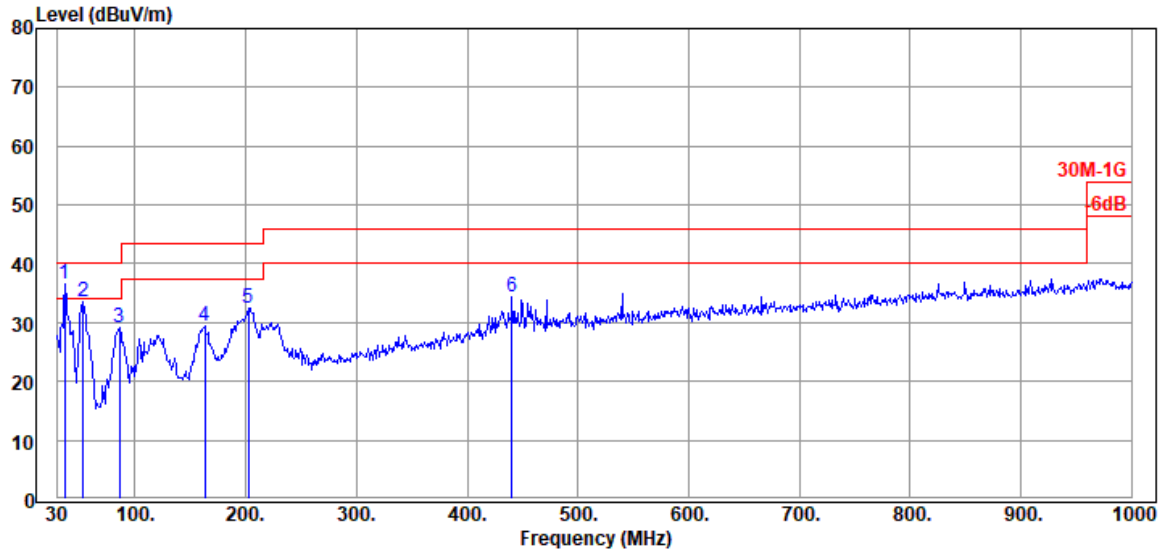

Antenna at Vertical Polarization

Emission Frequency (MHz)	Antenna Factor (dB/m)	Cable Loss (dB)	Preamplifier Gain (dB)	Read Level (dBμV)	Emission Level (dBμV/m)	Limits (dBμV/m)	Margin (dB)	Detector
36.790	20.71	1.57	26.48	40.85	36.65	40.00	3.35	Peak
53.280	13.34	1.89	26.44	44.74	33.53	40.00	6.47	Peak
86.260	14.05	2.44	26.32	39.05	29.22	40.00	10.78	Peak
162.890	15.59	3.33	25.93	36.36	29.35	43.50	14.15	Peak
202.660	15.29	3.74	25.78	39.20	32.45	43.50	11.05	Peak
440.310	22.13	6.29	26.74	32.65	34.33	46.00	11.67	Peak

A.2.1.3 Band Edge

- OFDM Modulation

Mode	802.11ax-HE20	U-NII Band	5
		Frequency	TX 5955MHz

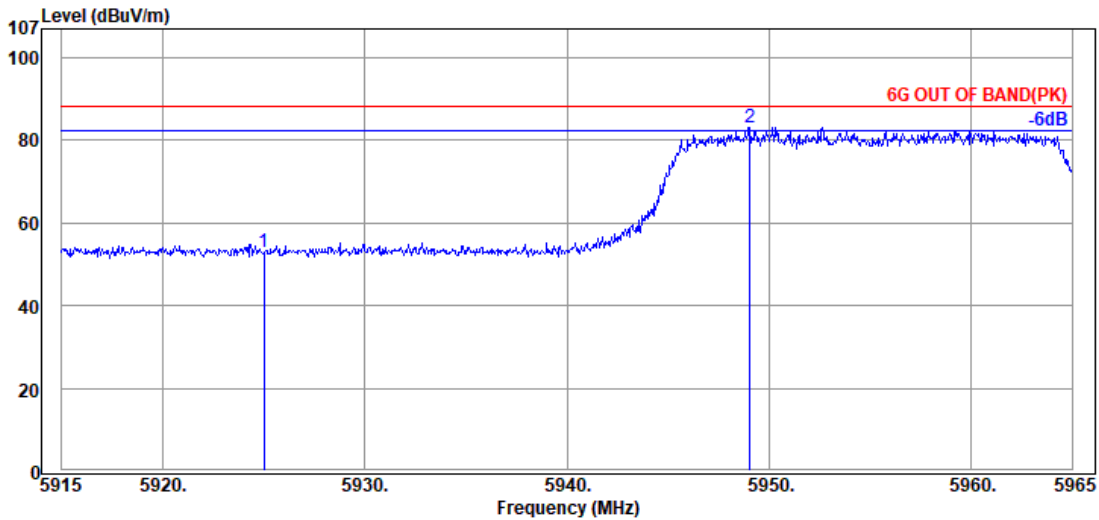

Antenna at Horizontal Polarization

Emission Frequency (MHz)	Antenna Factor (dB/m)	Cable Loss (dB)	Preamplifier Gain (dB)	Read Level (dBμV)	Emission Level (dBμV/m)	Limits (dBμV/m)	Margin (dB)	Detector
5925.000	34.23	9.30	39.35	48.61	52.79	88.20	35.41	Peak
@ 5949.050	34.30	9.30	39.35	78.90	83.15	---	---	Peak

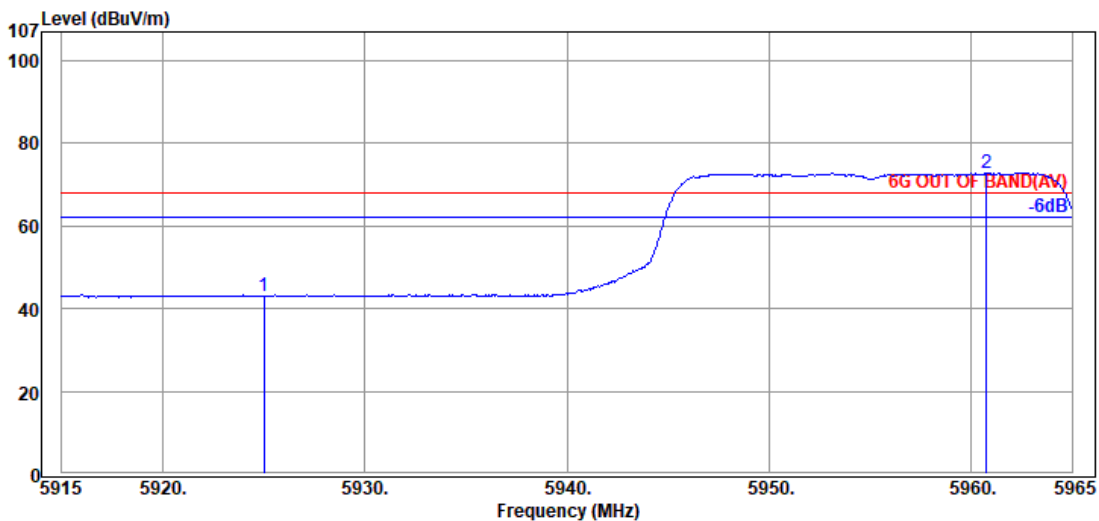

Antenna at Horizontal Polarization

Emission Frequency (MHz)	Antenna Factor (dB/m)	Cable Loss (dB)	Preamplifier Gain (dB)	Read Level (dBμV)	Emission Level (dBμV/m)	Limits (dBμV/m)	Margin (dB)	Detector
5925.000	34.23	9.30	39.35	38.90	43.08	68.20	25.12	Average
@ 5960.750	34.27	9.31	39.35	68.67	72.90	---	---	Average

Remark: The “@” means fundamental frequency, it is ignored in this section.

Mode	802.11ax-HE20	U-NII Band	5
		Frequency	TX 5955MHz

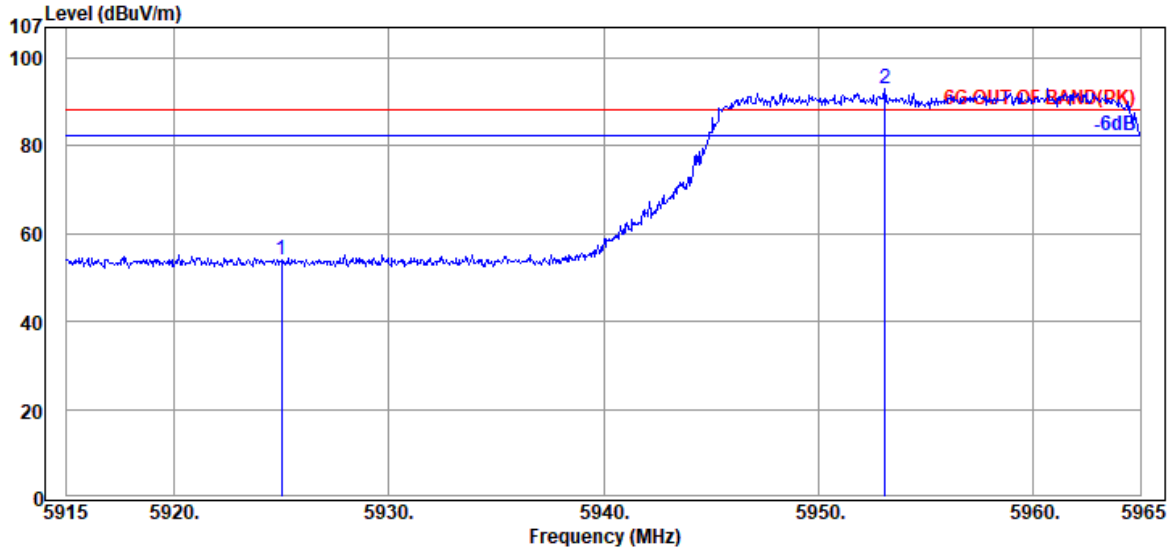

Antenna at Vertical Polarization

Emission Frequency (MHz)	Antenna Factor (dB/m)	Cable Loss (dB)	Preamplifier Gain (dB)	Read Level (dBμV)	Emission Level (dBμV/m)	Limits (dBμV/m)	Margin (dB)	Detector
5925.000	34.23	9.30	39.35	49.75	53.93	88.20	34.27	Peak
@ 5953.100	34.30	9.30	39.35	88.74	92.99	---	---	Peak

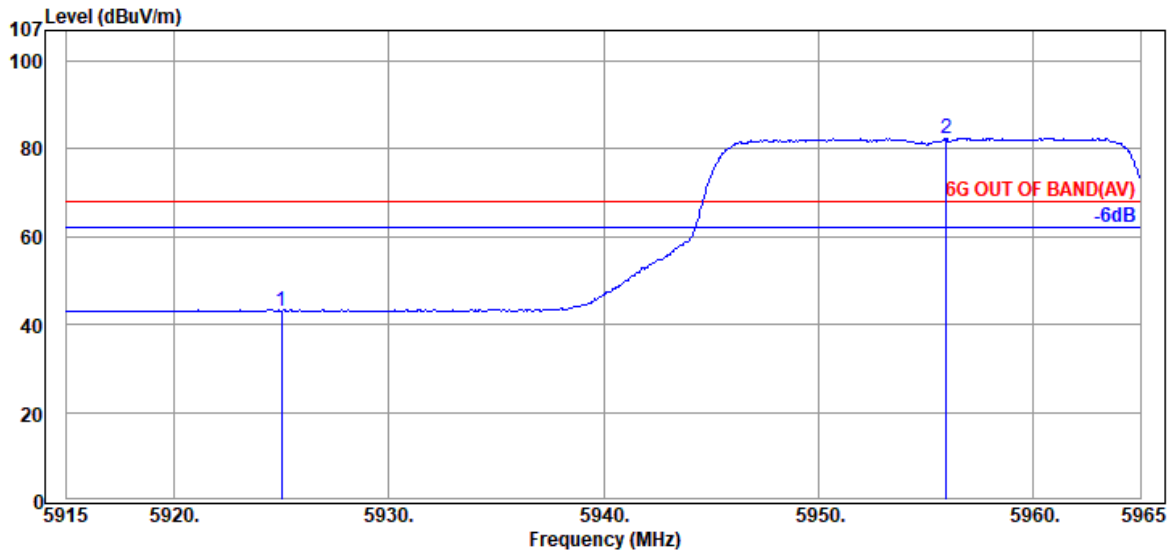

Antenna at Vertical Polarization

Emission Frequency (MHz)	Antenna Factor (dB/m)	Cable Loss (dB)	Preamplifier Gain (dB)	Read Level (dBμV)	Emission Level (dBμV/m)	Limits (dBμV/m)	Margin (dB)	Detector
5925.000	34.23	9.30	39.35	49.75	53.93	68.20	14.27	Average
@ 5953.100	34.30	9.30	39.35	88.74	92.99	---	---	Average

Remark: The “@” means fundamental frequency, it is ignored in this section.

Mode	802.11ax-HE20	U-NII Band	8
		Frequency	TX 7115MHz

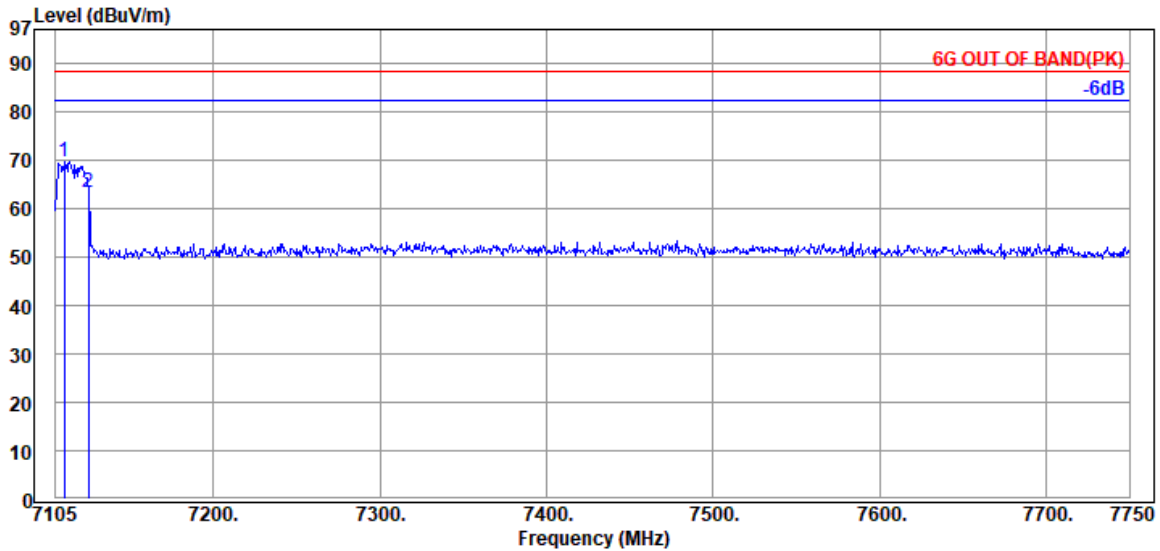

Antenna at Horizontal Polarization

Emission Frequency (MHz)	Antenna Factor (dB/m)	Cable Loss (dB)	Preamp Gain (dB)	Read Level (dBμV)	Emission Level (dBμV/m)	Limits (dBμV/m)	Margin (dB)	Detector
7110.160	35.87	9.82	39.50	63.39	69.58	---	---	Peak
@ 7124.995	35.87	9.82	39.50	57.15	63.34	88.20	24.86	Peak

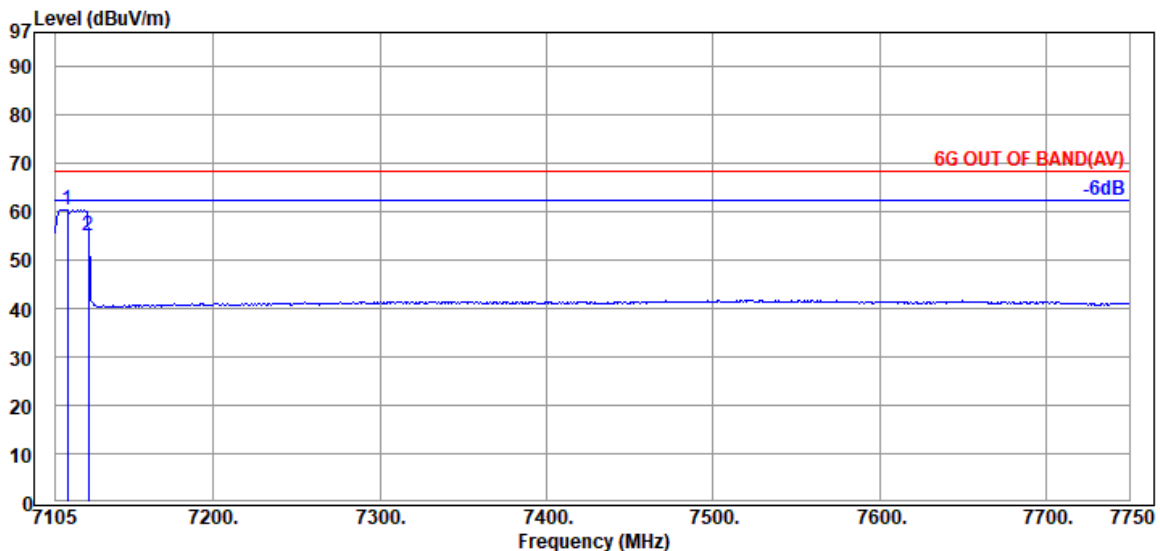

Antenna at Horizontal Polarization

Emission Frequency (MHz)	Antenna Factor (dB/m)	Cable Loss (dB)	Preamp Gain (dB)	Read Level (dBμV)	Emission Level (dBμV/m)	Limits (dBμV/m)	Margin (dB)	Detector
7112.095	35.87	9.82	39.50	54.25	60.44	---	---	Average
@ 7124.995	35.87	9.82	39.50	48.83	55.02	68.20	13.18	Average

Remark: The “@” means fundamental frequency, it is ignored in this section.

Mode	802.11ax-HE20	U-NII Band	8
		Frequency	TX 7115MHz

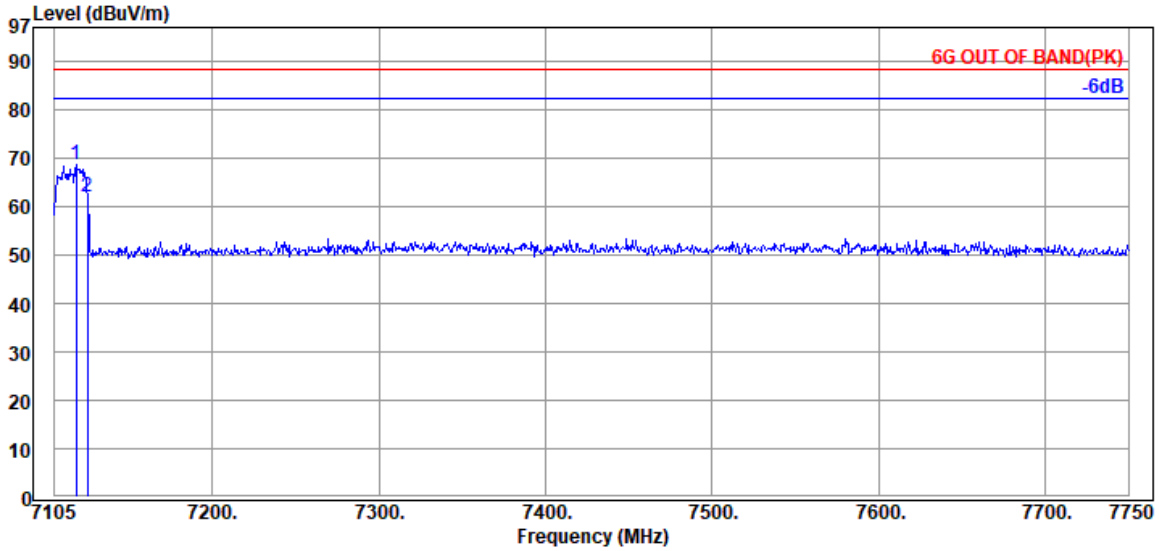

Antenna at Vertical Polarization

Emission Frequency (MHz)	Antenna Factor (dB/m)	Cable Loss (dB)	Preamplifier Gain (dB)	Read Level (dBμV)	Emission Level (dBμV/m)	Limits (dBμV/m)	Margin (dB)	Detector
7117.900	35.87	9.82	39.50	62.50	68.69	---	---	Peak
@ 7124.995	35.87	9.82	39.50	55.78	61.97	88.20	26.23	Peak

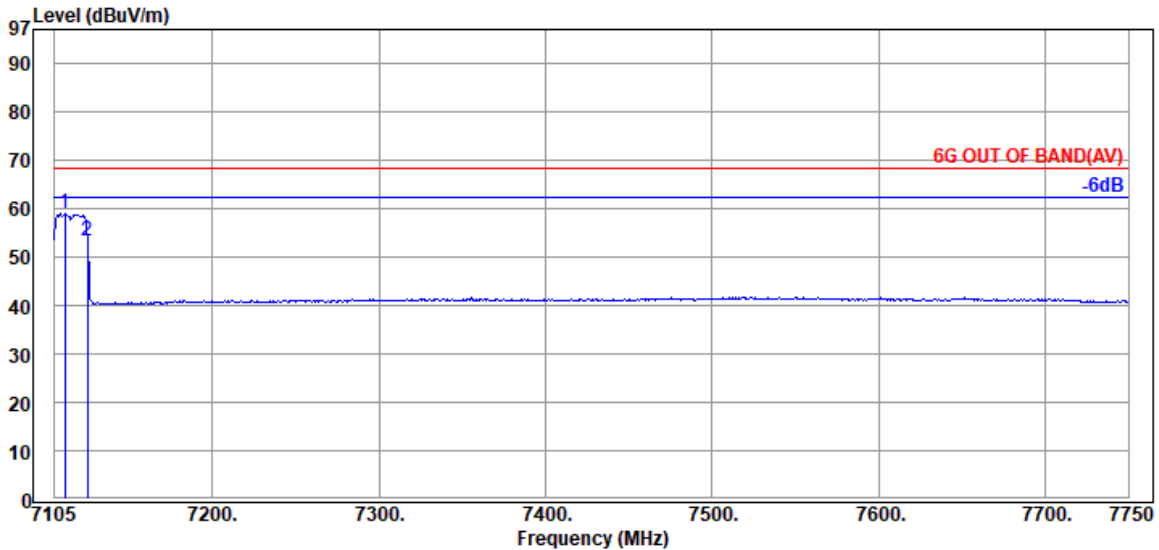

Antenna at Vertical Polarization

Emission Frequency (MHz)	Antenna Factor (dB/m)	Cable Loss (dB)	Preamplifier Gain (dB)	Read Level (dBμV)	Emission Level (dBμV/m)	Limits (dBμV/m)	Margin (dB)	Detector
7111.450	35.87	9.82	39.50	52.68	58.87	---	---	Average
@ 7124.995	35.87	9.82	39.50	47.04	53.23	68.20	14.97	Average

Remark: The “@” means fundamental frequency, it is ignored in this section.

Mode	802.11ax-HE40	U-NII Band	5
		Frequency	TX 5965MHz

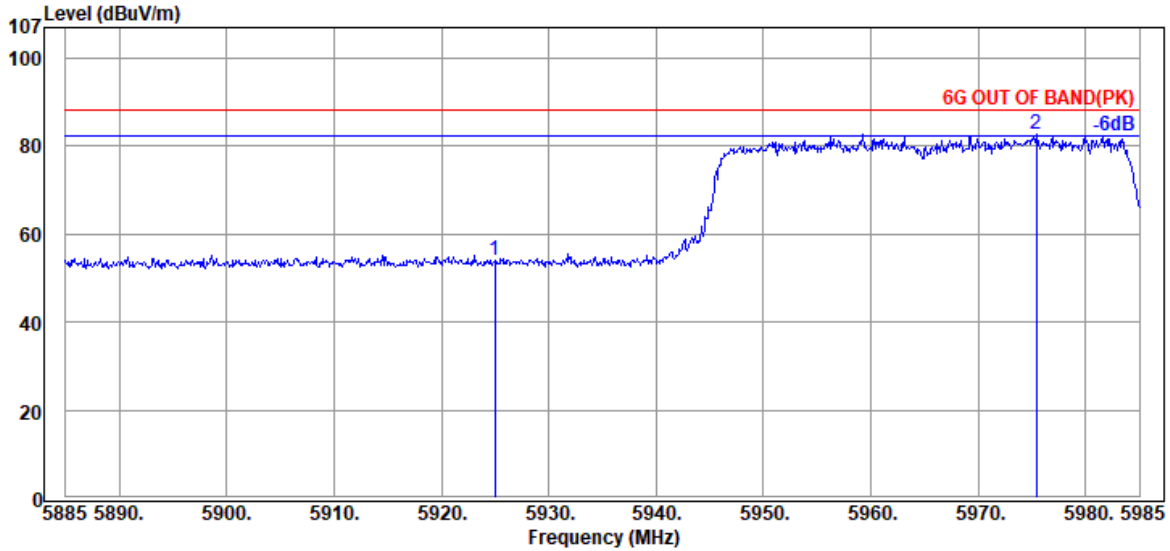

Antenna at Horizontal Polarization

Emission Frequency (MHz)	Antenna Factor (dB/m)	Cable Loss (dB)	Preamp Gain (dB)	Read Level (dBμV)	Emission Level (dBμV/m)	Limits (dBμV/m)	Margin (dB)	Detector
5925.000	34.23	9.30	39.35	49.78	53.96	88.20	34.24	Peak
@ 5975.400	34.27	9.31	39.35	78.43	82.66	---	---	Peak

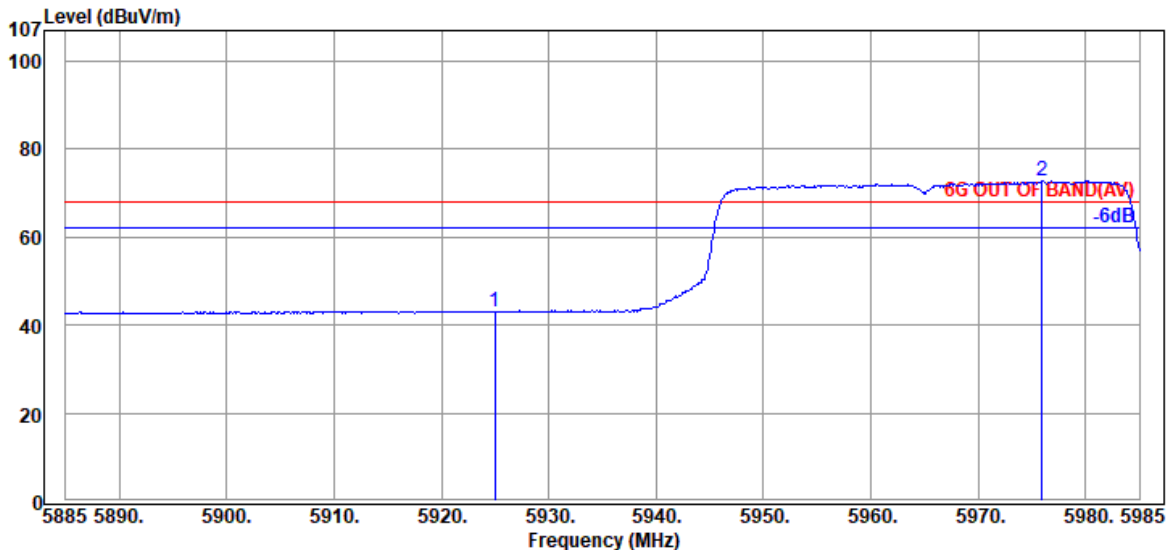

Antenna at Horizontal Polarization

Emission Frequency (MHz)	Antenna Factor (dB/m)	Cable Loss (dB)	Preamp Gain (dB)	Read Level (dBμV)	Emission Level (dBμV/m)	Limits (dBμV/m)	Margin (dB)	Detector
5925.000	34.23	9.30	39.35	38.83	43.01	68.20	25.19	Average
@ 5975.900	34.23	9.32	39.36	68.53	72.72	---	---	Average

Remark: The “@” means fundamental frequency, it is ignored in this section.

Mode	802.11ax-HE40	U-NII Band	5
		Frequency	TX 5965MHz

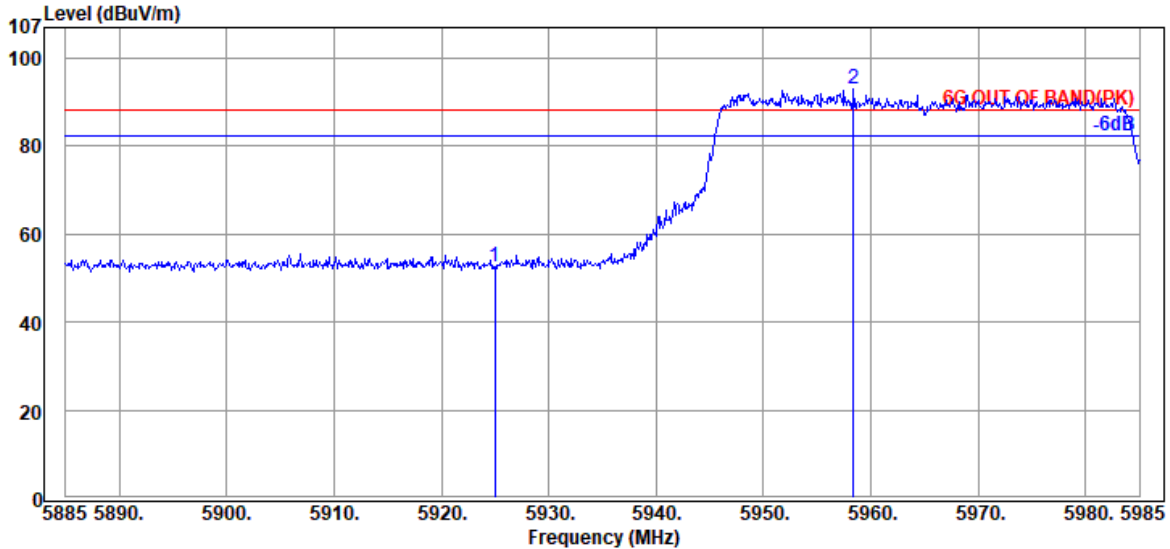

Antenna at Vertical Polarization

Emission Frequency (MHz)	Antenna Factor (dB/m)	Cable Loss (dB)	Preamp Gain (dB)	Read Level (dBμV)	Emission Level (dBμV/m)	Limits (dBμV/m)	Margin (dB)	Detector
5925.000	34.23	9.30	39.35	48.30	52.48	88.20	35.72	Peak
@ 5958.400	34.30	9.30	39.35	88.65	92.90	---	---	Peak

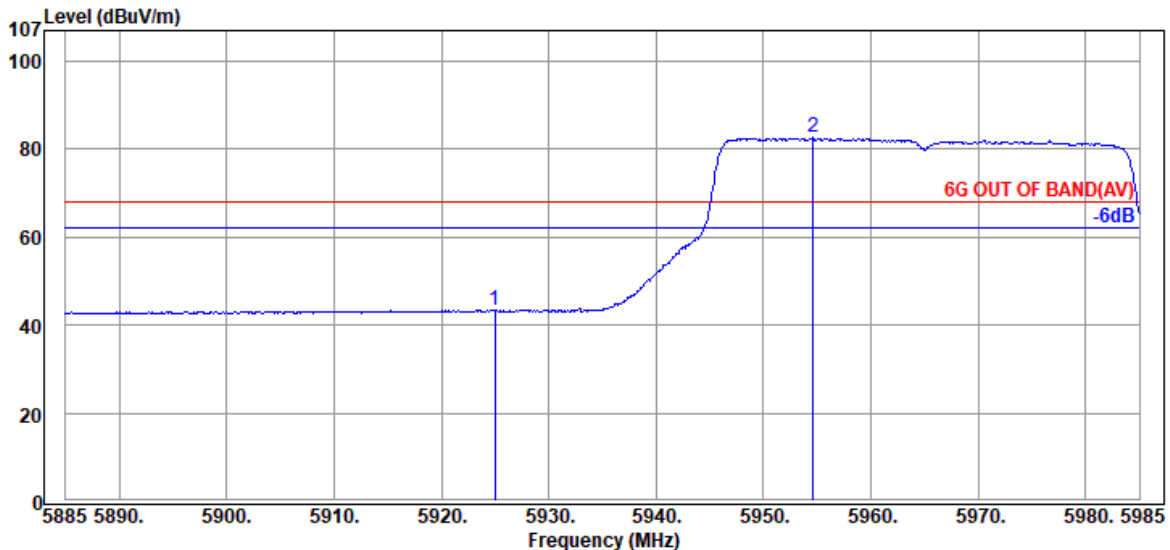

Antenna at Vertical Polarization

Emission Frequency (MHz)	Antenna Factor (dB/m)	Cable Loss (dB)	Preamp Gain (dB)	Read Level (dBμV)	Emission Level (dBμV/m)	Limits (dBμV/m)	Margin (dB)	Detector
5925.000	34.23	9.30	39.35	39.09	43.27	68.20	24.93	Average
@ 5954.600	34.30	9.30	39.35	78.35	82.60	---	---	Average

Remark: The “@” means fundamental frequency, it is ignored in this section.

Mode	802.11ax-HE40	U-NII Band	8
		Frequency	TX 7085MHz

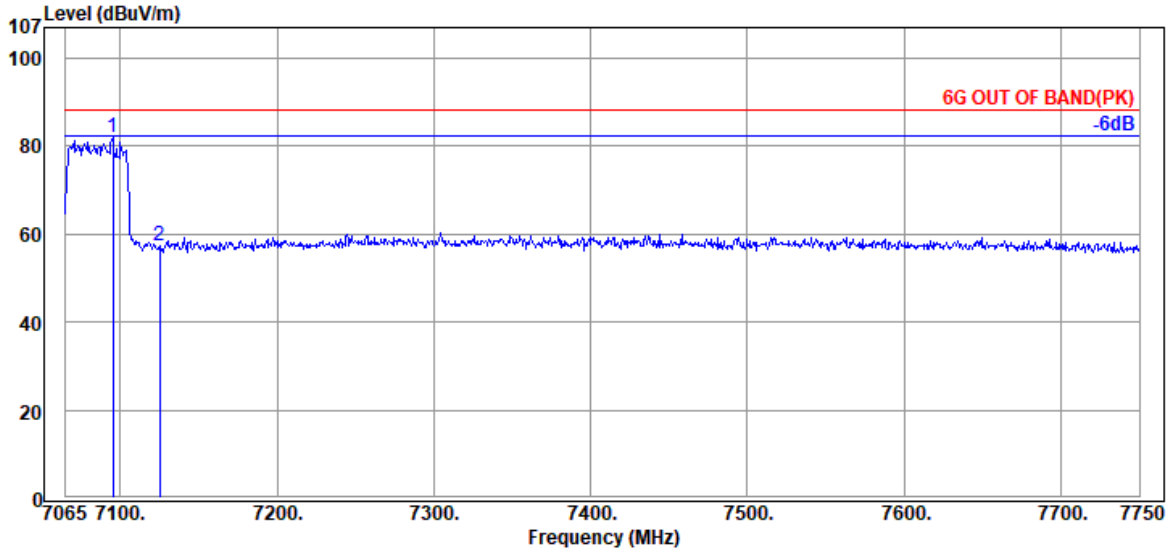

Antenna at Horizontal Polarization

Emission Frequency (MHz)	Antenna Factor (dB/m)	Cable Loss (dB)	Preamplifier Gain (dB)	Read Level (dBμV)	Emission Level (dBμV/m)	Limits (dBμV/m)	Margin (dB)	Detector
7095.140	35.80	9.80	39.49	75.71	81.82	---	---	Peak
@ 7125.280	35.87	9.82	39.50	51.21	57.40	88.20	30.80	Peak

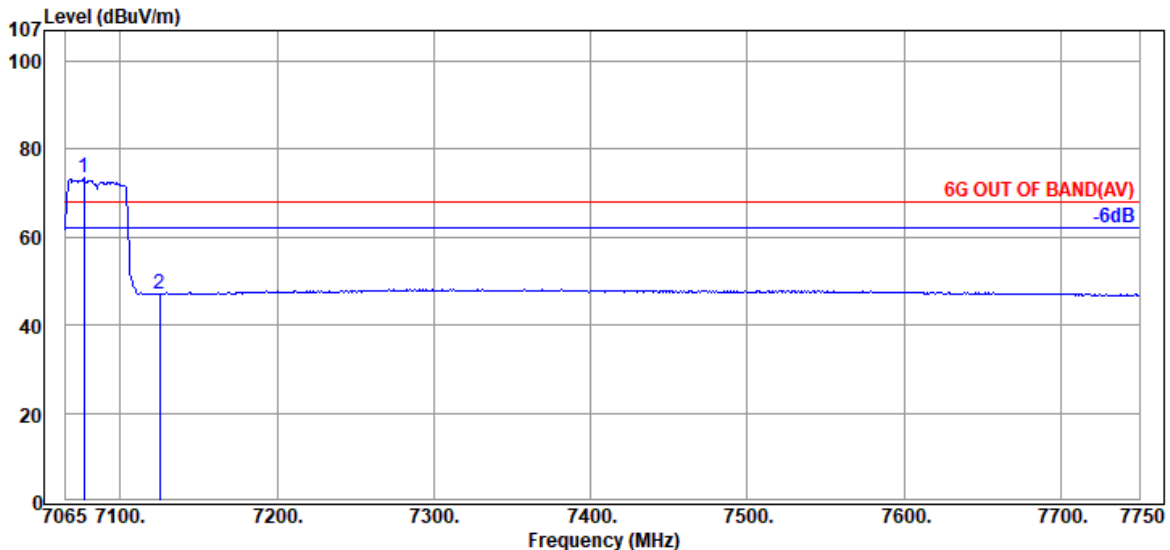

Antenna at Horizontal Polarization

Emission Frequency (MHz)	Antenna Factor (dB/m)	Cable Loss (dB)	Preamplifier Gain (dB)	Read Level (dBμV)	Emission Level (dBμV/m)	Limits (dBμV/m)	Margin (dB)	Detector
7076.645	35.70	9.78	39.49	67.54	73.53	---	---	Average
@ 7125.280	35.87	9.82	39.50	40.88	47.07	68.20	21.13	Average

Remark: The “@” means fundamental frequency, it is ignored in this section.

Mode	802.11ax-HE40	U-NII Band	8
		Frequency	TX 7085MHz

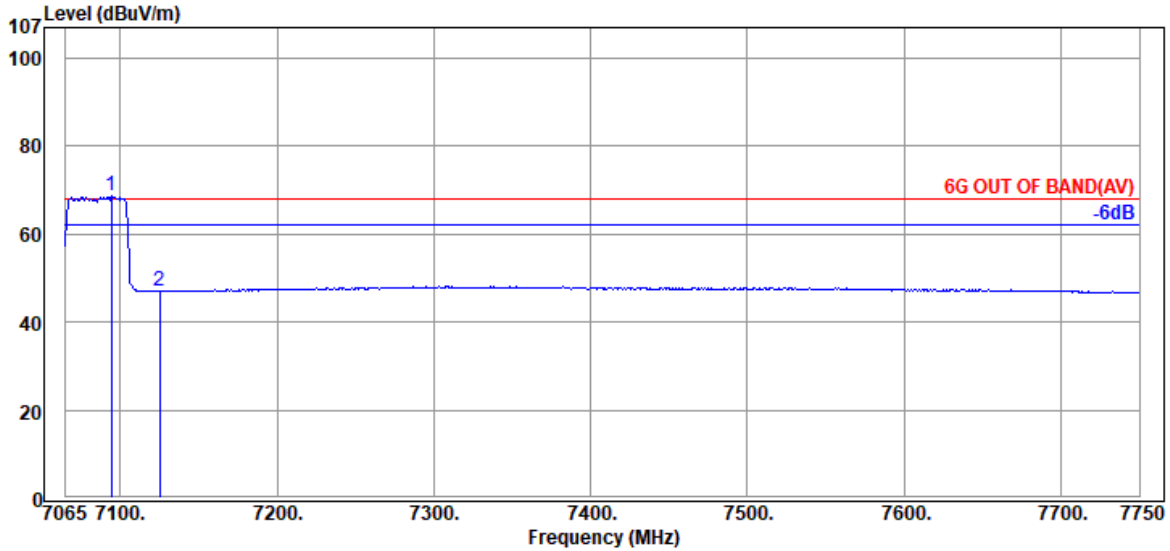

Antenna at Vertical Polarization

Emission Frequency (MHz)	Antenna Factor (dB/m)	Cable Loss (dB)	Preamplifier Gain (dB)	Read Level (dBμV)	Emission Level (dBμV/m)	Limits (dBμV/m)	Margin (dB)	Detector
7095.825	35.80	9.80	39.49	71.34	77.45	---	---	Peak
@ 7125.280	35.87	9.82	39.50	52.07	58.26	88.20	29.94	Peak

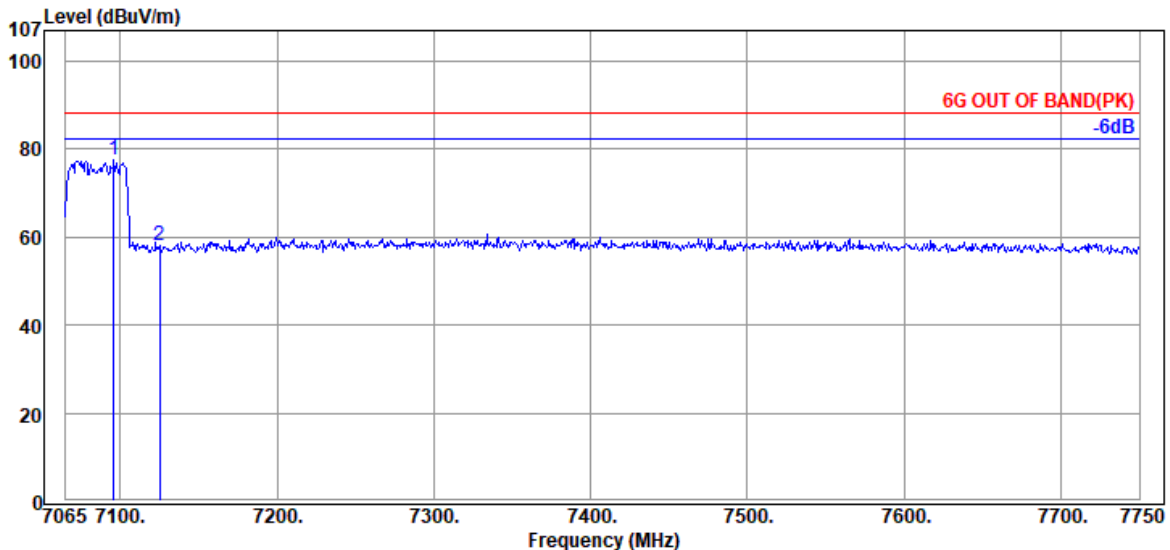

Antenna at Vertical Polarization

Emission Frequency (MHz)	Antenna Factor (dB/m)	Cable Loss (dB)	Preamplifier Gain (dB)	Read Level (dBμV)	Emission Level (dBμV/m)	Limits (dBμV/m)	Margin (dB)	Detector
7094.455	35.80	9.80	39.49	62.80	68.91	---	---	Average
@ 7125.280	35.87	9.82	39.50	40.94	47.13	68.20	21.07	Average

Remark: The “@” means fundamental frequency, it is ignored in this section.

Mode	802.11ax-HE80	U-NII Band	5
		Frequency	TX 5985MHz

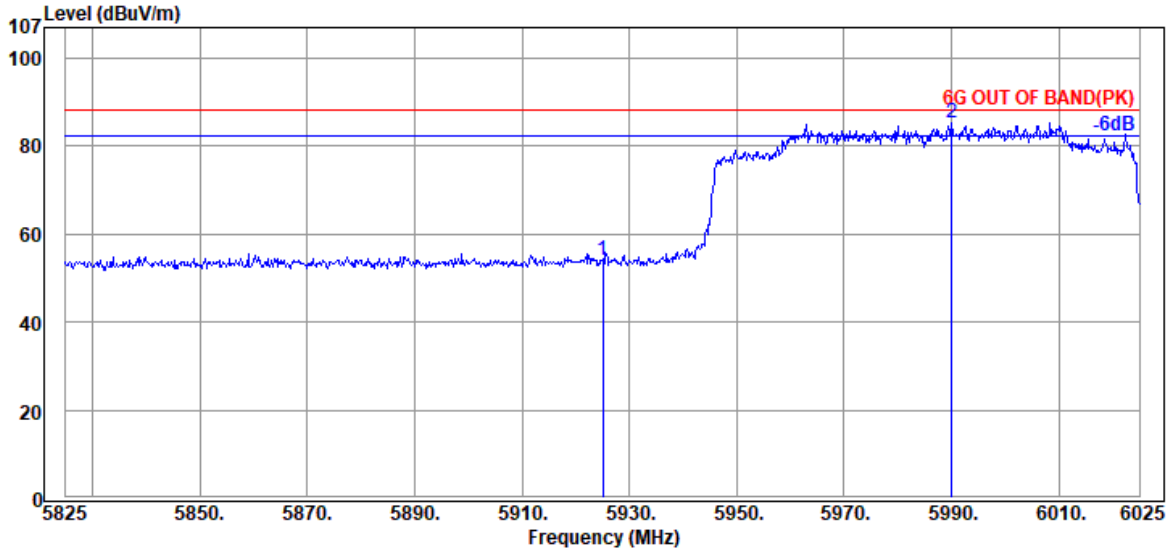

Antenna at Horizontal Polarization

Emission Frequency (MHz)	Antenna Factor (dB/m)	Cable Loss (dB)	Preamplifier Gain (dB)	Read Level (dBμV)	Emission Level (dBμV/m)	Limits (dBμV/m)	Margin (dB)	Detector
5925.000	34.23	9.30	39.35	50.01	54.19	88.20	34.01	Peak
@ 5990.000	34.23	9.32	39.36	81.26	85.45	---	---	Peak

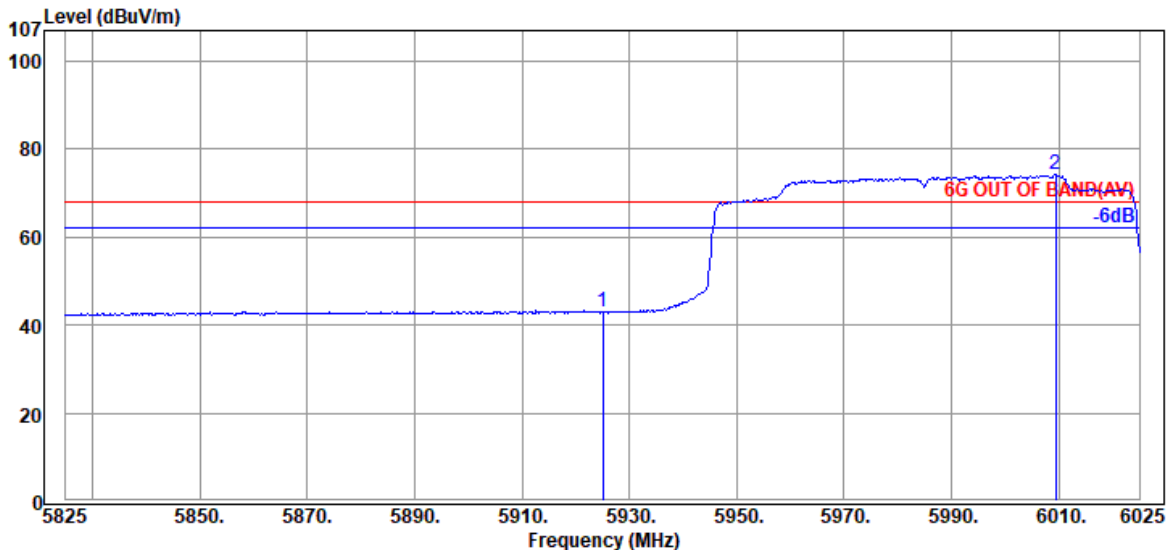

Antenna at Horizontal Polarization

Emission Frequency (MHz)	Antenna Factor (dB/m)	Cable Loss (dB)	Preamplifier Gain (dB)	Read Level (dBμV)	Emission Level (dBμV/m)	Limits (dBμV/m)	Margin (dB)	Detector
5925.000	34.23	9.30	39.35	38.95	43.13	68.20	25.07	Average
@ 6009.400	34.20	9.33	39.36	70.08	74.25	---	---	Average

Remark: The “@” means fundamental frequency, it is ignored in this section.

Mode	802.11ax-HE80	U-NII Band	5
		Frequency	TX 5985MHz

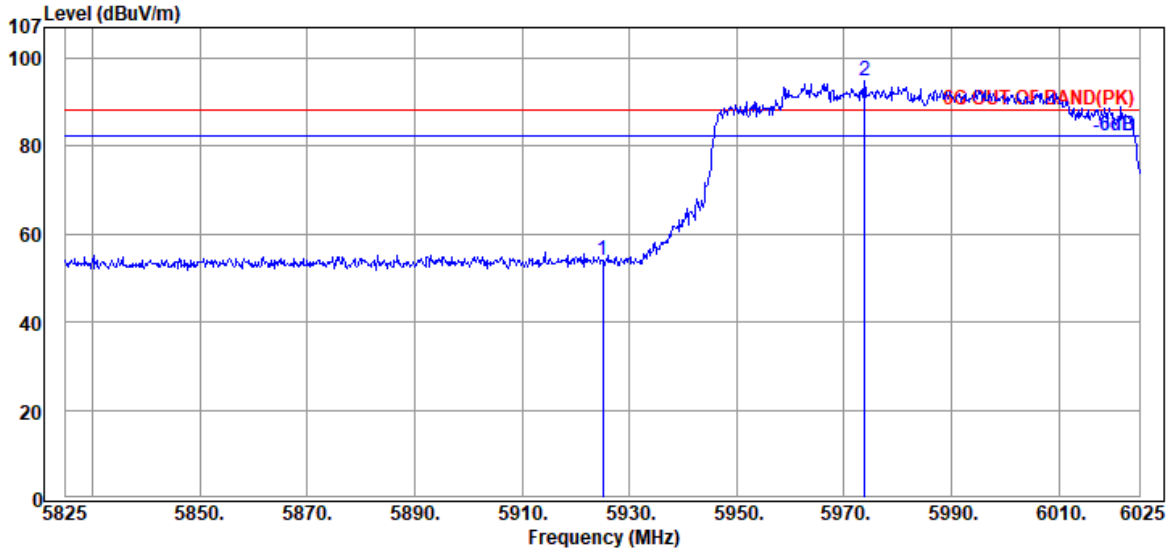

Antenna at Vertical Polarization

Emission Frequency (MHz)	Antenna Factor (dB/m)	Cable Loss (dB)	Preamplifier Gain (dB)	Read Level (dBμV)	Emission Level (dBμV/m)	Limits (dBμV/m)	Margin (dB)	Detector
5925.000	34.23	9.30	39.35	50.04	54.22	88.20	33.98	Peak
@ 5973.800	34.27	9.31	39.35	90.54	94.77	---	---	Peak

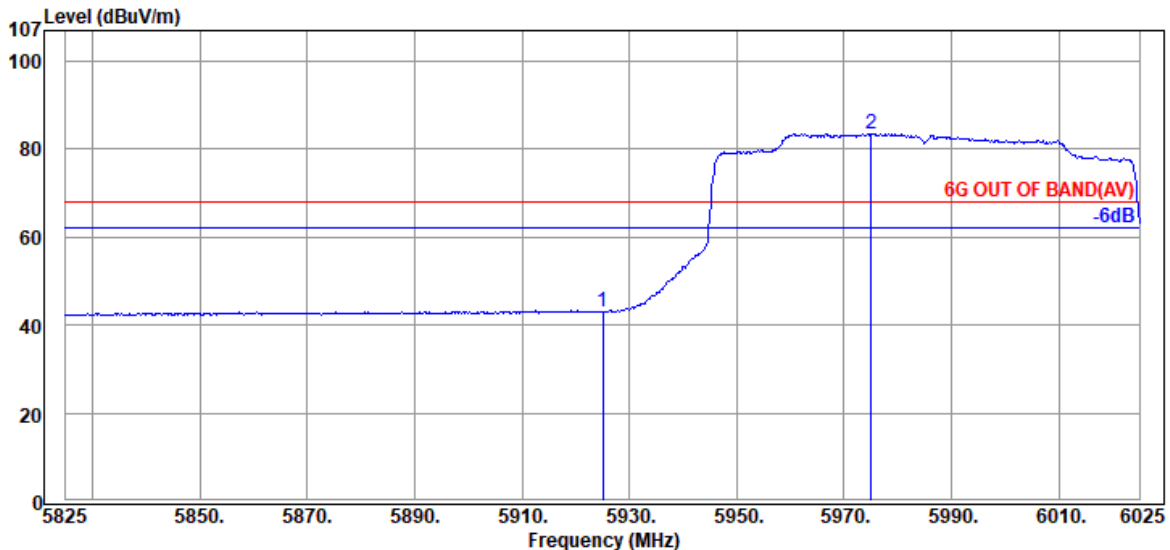

Antenna at Vertical Polarization

Emission Frequency (MHz)	Antenna Factor (dB/m)	Cable Loss (dB)	Preamplifier Gain (dB)	Read Level (dBμV)	Emission Level (dBμV/m)	Limits (dBμV/m)	Margin (dB)	Detector
5925.000	34.23	9.30	39.35	38.96	43.14	68.20	25.06	Average
@ 5975.000	34.27	9.31	39.35	79.23	83.46	---	---	Average

Remark: The “@” means fundamental frequency, it is ignored in this section.

Mode	802.11ax-HE80	U-NII Band	8
		Frequency	TX 7025MHz

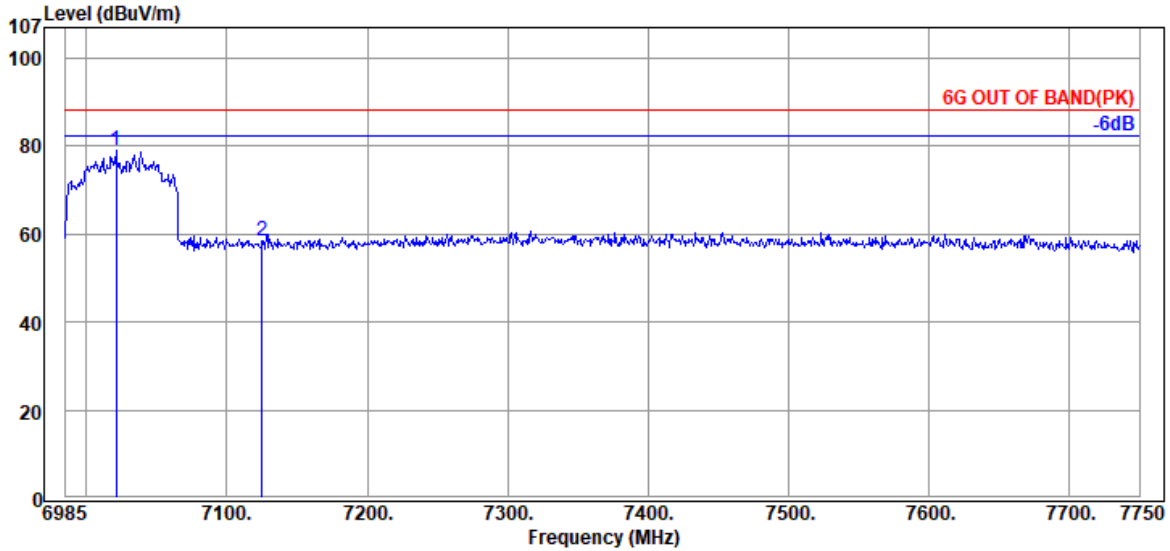

Antenna at Horizontal Polarization

Emission Frequency (MHz)	Antenna Factor (dB/m)	Cable Loss (dB)	Preamplifier Gain (dB)	Read Level (dBμV)	Emission Level (dBμV/m)	Limits (dBμV/m)	Margin (dB)	Detector
@ 7020.955	35.53	9.73	39.48	73.10	78.88	---	---	Peak
7125.000	35.87	9.82	39.50	52.44	58.63	88.20	29.57	Peak

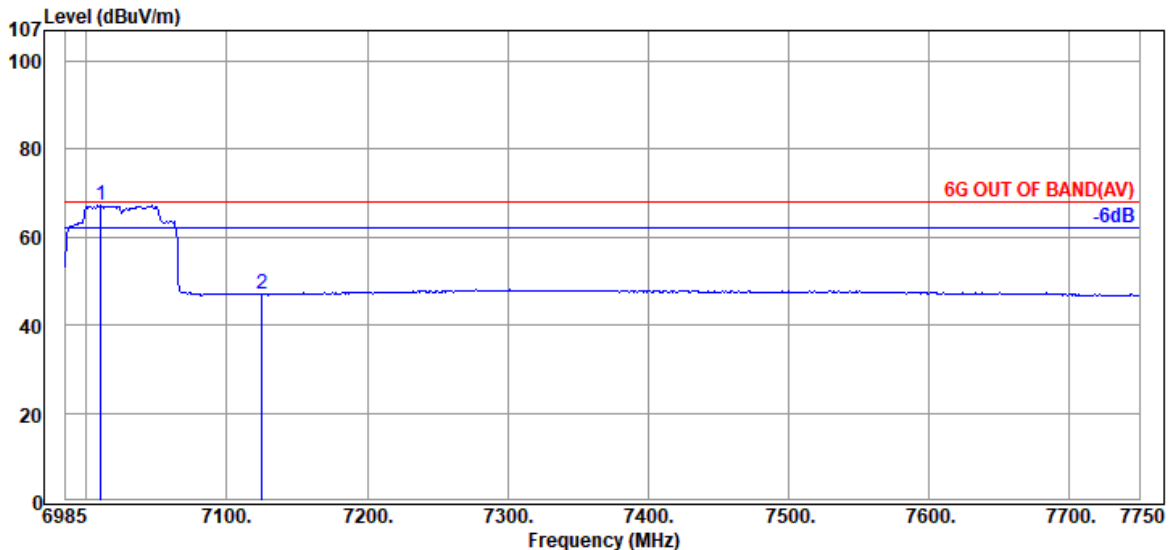

Antenna at Horizontal Polarization

Emission Frequency (MHz)	Antenna Factor (dB/m)	Cable Loss (dB)	Preamplifier Gain (dB)	Read Level (dBμV)	Emission Level (dBμV/m)	Limits (dBμV/m)	Margin (dB)	Detector
@ 7010.245	35.53	9.73	39.47	61.40	67.19	---	---	Average
7125.000	35.87	9.82	39.50	40.88	47.07	68.20	21.13	Average

Remark: The “@” means fundamental frequency, it is ignored in this section.

Mode	802.11ax-HE80	U-NII Band	8
		Frequency	TX 7025MHz

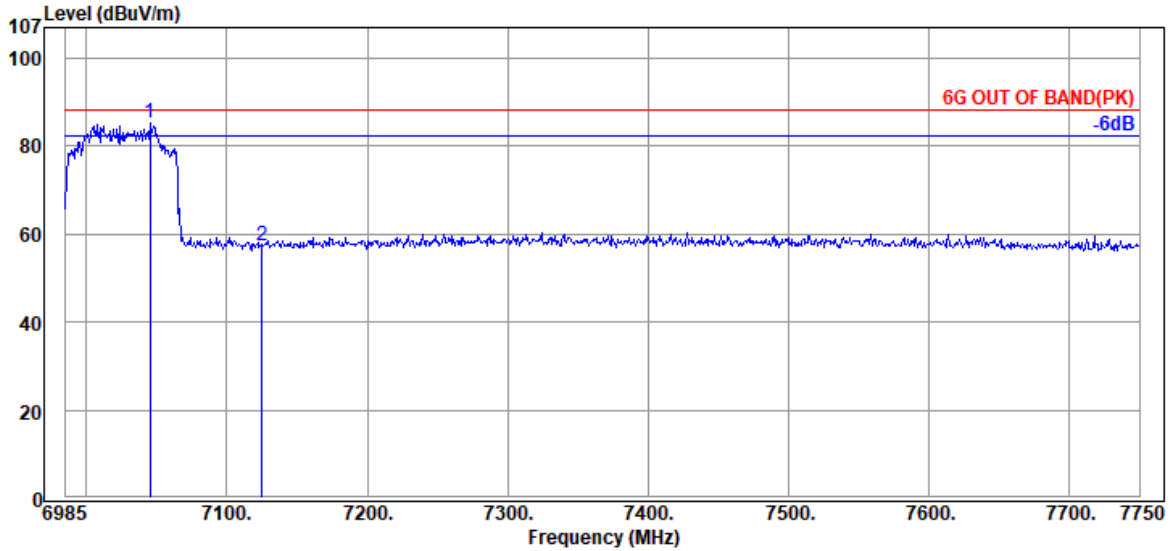

Antenna at Vertical Polarization

Emission Frequency (MHz)	Antenna Factor (dB/m)	Cable Loss (dB)	Preamplifier Gain (dB)	Read Level (dBμV)	Emission Level (dBμV/m)	Limits (dBμV/m)	Margin (dB)	Detector
@ 7045.435	35.57	9.75	39.48	79.40	85.24	---	---	Peak
7125.000	35.87	9.82	39.50	51.07	57.26	88.20	30.94	Peak

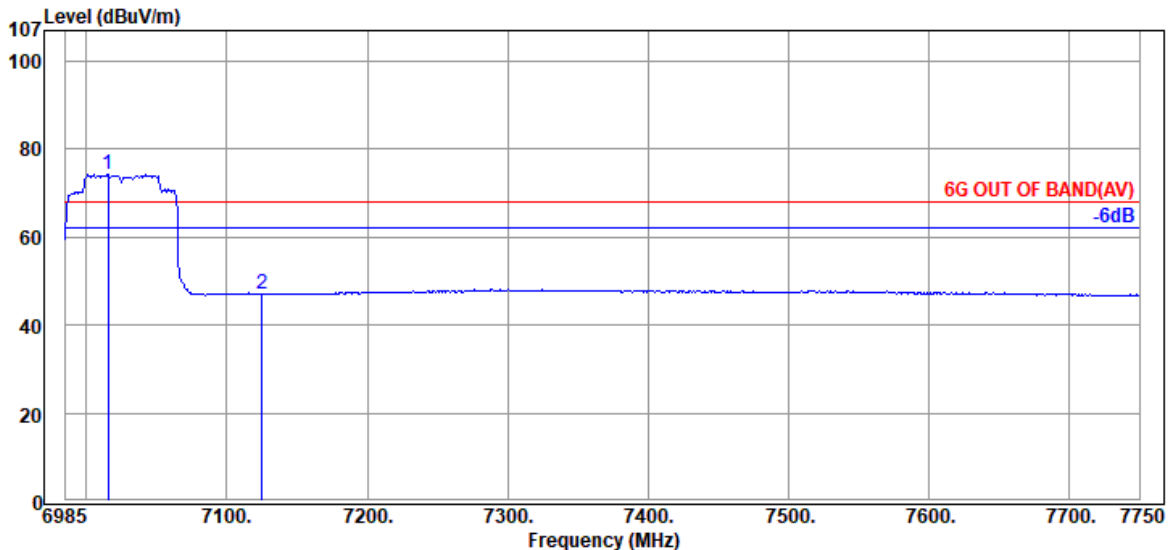

Antenna at Vertical Polarization

Emission Frequency (MHz)	Antenna Factor (dB/m)	Cable Loss (dB)	Preamplifier Gain (dB)	Read Level (dBμV)	Emission Level (dBμV/m)	Limits (dBμV/m)	Margin (dB)	Detector
@ 7015.600	35.53	9.73	39.47	68.49	74.28	---	---	Average
7125.000	35.87	9.82	39.50	40.78	46.97	68.20	21.23	Average

Remark: The “@” means fundamental frequency, it is ignored in this section.

Mode	802.11ax-HE160	U-NII Band	5
		Frequency	TX 6025MHz

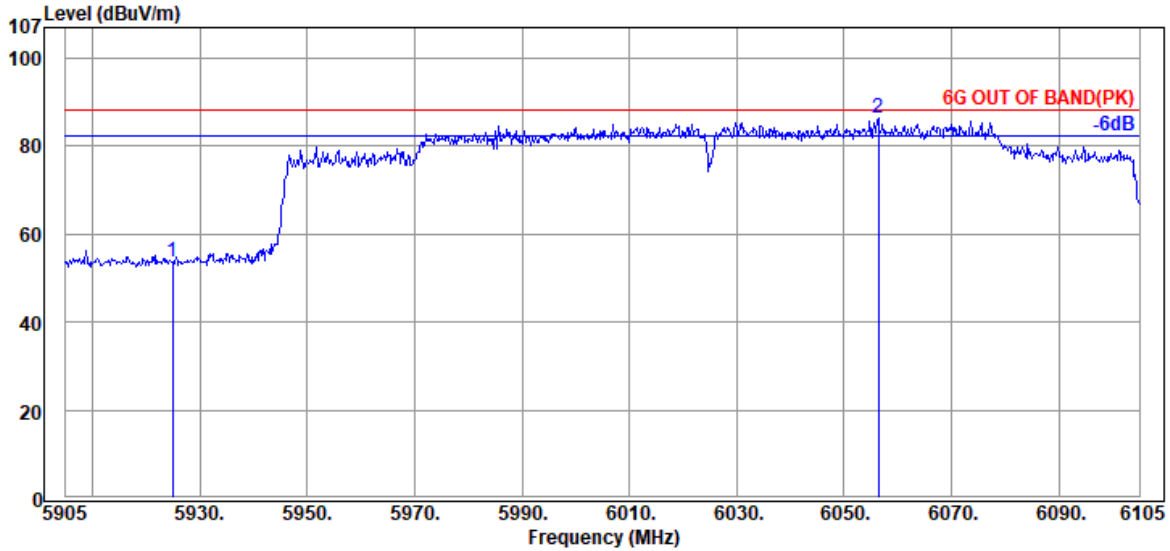

Antenna at Horizontal Polarization

Emission Frequency (MHz)	Antenna Factor (dB/m)	Cable Loss (dB)	Preamp Gain (dB)	Read Level (dBμV)	Emission Level (dBμV/m)	Limits (dBμV/m)	Margin (dB)	Detector
5925.000	34.23	9.30	39.35	49.38	53.56	88.20	34.64	Peak
@ 6056.400	34.20	9.35	39.37	82.19	86.37	---	---	Peak

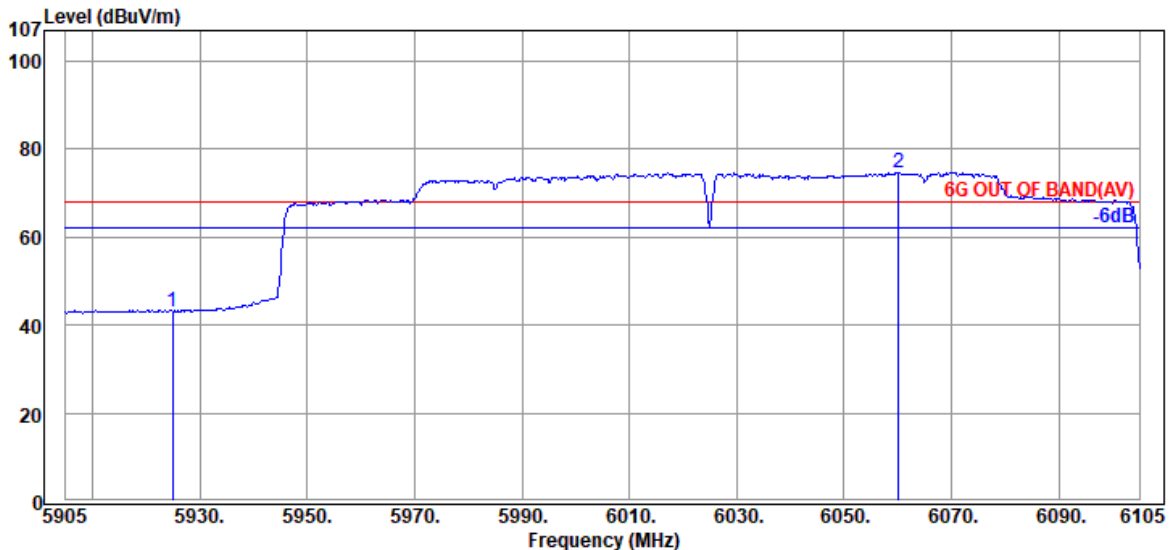

Antenna at Horizontal Polarization

Emission Frequency (MHz)	Antenna Factor (dB/m)	Cable Loss (dB)	Preamp Gain (dB)	Read Level (dBμV)	Emission Level (dBμV/m)	Limits (dBμV/m)	Margin (dB)	Detector
5925.000	34.23	9.30	39.35	38.99	43.17	68.20	25.03	Average
@ 6060.200	34.20	9.35	39.37	70.48	74.66	---	---	Average

Remark: The “@” means fundamental frequency, it is ignored in this section.

Mode	802.11ax-HE160	U-NII Band	5
		Frequency	TX 6025MHz

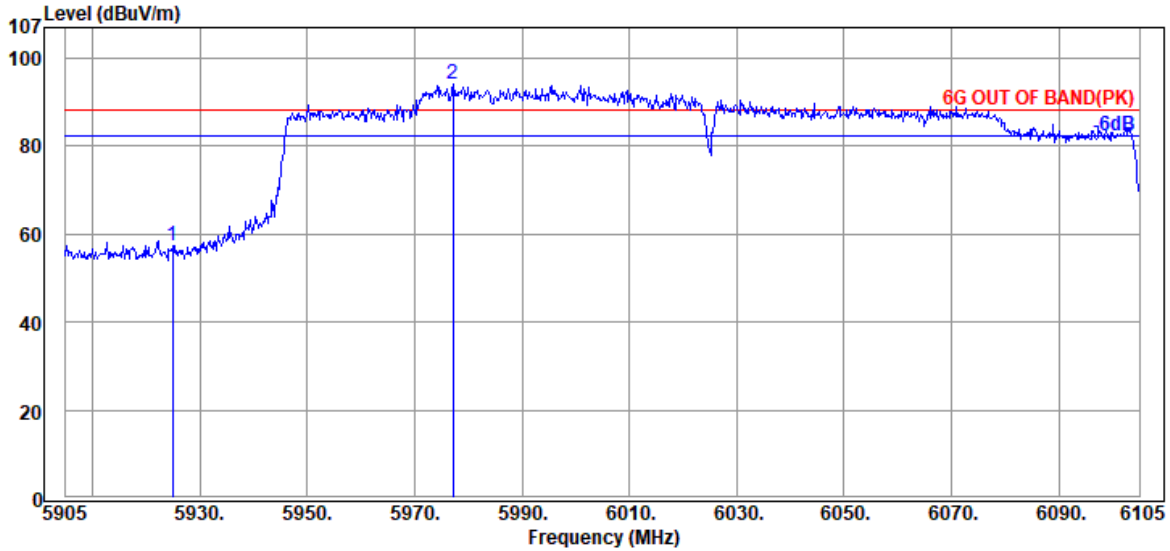

Antenna at Vertical Polarization

Emission Frequency (MHz)	Antenna Factor (dB/m)	Cable Loss (dB)	Preamplifier Gain (dB)	Read Level (dBμV)	Emission Level (dBμV/m)	Limits (dBμV/m)	Margin (dB)	Detector
5925.000	34.23	9.30	39.35	53.20	57.38	88.20	30.82	Peak
@ 5977.200	34.23	9.32	39.36	89.92	94.11	---	---	Peak

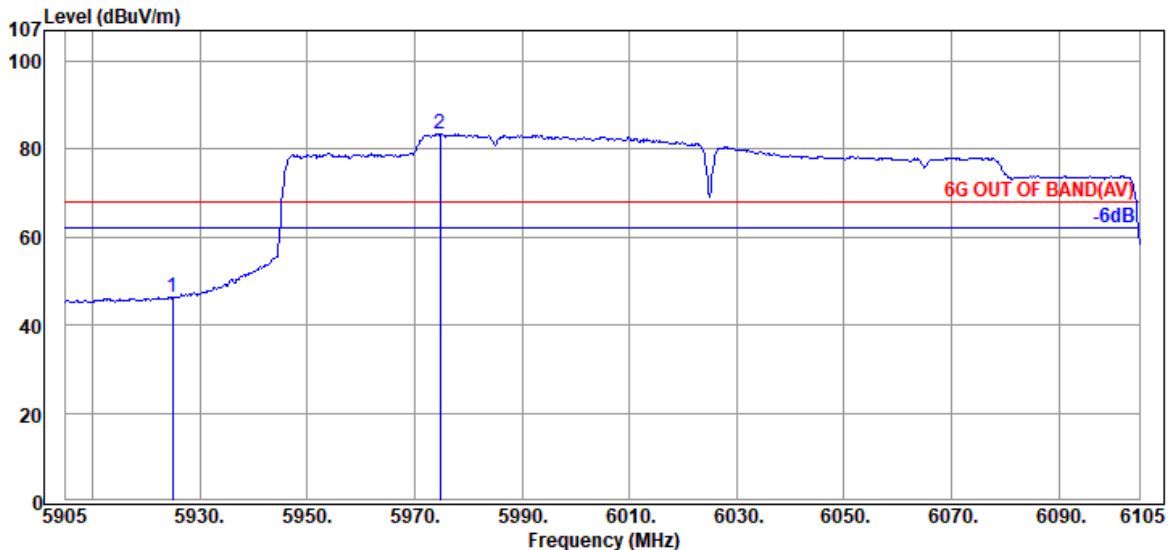

Antenna at Vertical Polarization

Emission Frequency (MHz)	Antenna Factor (dB/m)	Cable Loss (dB)	Preamplifier Gain (dB)	Read Level (dBμV)	Emission Level (dBμV/m)	Limits (dBμV/m)	Margin (dB)	Detector
5925.000	34.23	9.30	39.35	42.11	46.29	68.20	21.91	Average
@ 5974.800	34.27	9.31	39.35	79.17	83.40	---	---	Average

Remark: The “@” means fundamental frequency, it is ignored in this section.

Mode	802.11ax-HE160	U-NII Band	8
		Frequency	TX 6985MHz

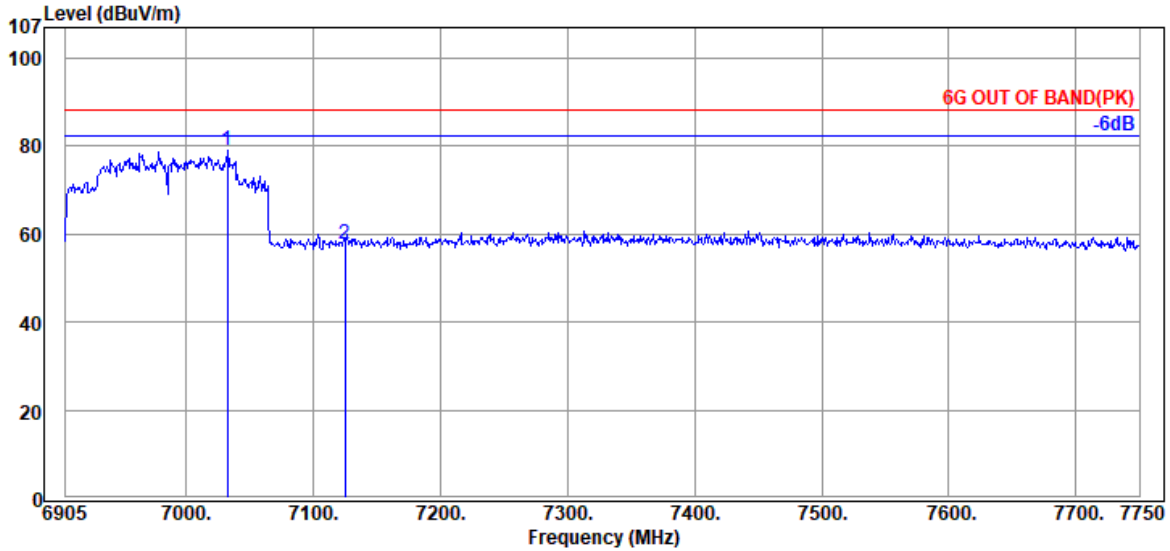

Antenna at Horizontal Polarization

Emission Frequency (MHz)	Antenna Factor (dB/m)	Cable Loss (dB)	Preamp Gain (dB)	Read Level (dBμV)	Emission Level (dBμV/m)	Limits (dBμV/m)	Margin (dB)	Detector
7032.595	35.57	9.75	39.48	73.09	78.93	---	---	Peak
@ 7124.700	35.87	9.82	39.50	51.44	57.63	88.20	30.57	Peak

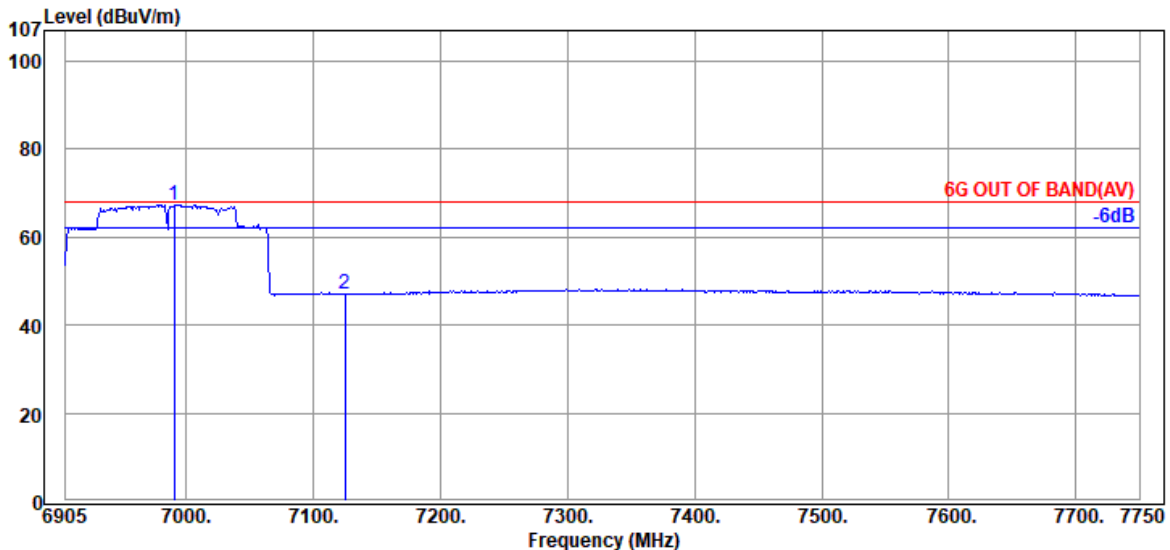

Antenna at Horizontal Polarization

Emission Frequency (MHz)	Antenna Factor (dB/m)	Cable Loss (dB)	Preamp Gain (dB)	Read Level (dBμV)	Emission Level (dBμV/m)	Limits (dBμV/m)	Margin (dB)	Detector
6990.345	35.50	9.71	39.47	61.64	67.38	---	---	Average
@ 7124.700	35.87	9.82	39.50	40.93	47.12	68.20	21.08	Average

Remark: The “@” means fundamental frequency, it is ignored in this section.

Mode	802.11ax-HE160	U-NII Band	8
		Frequency	TX 6985MHz

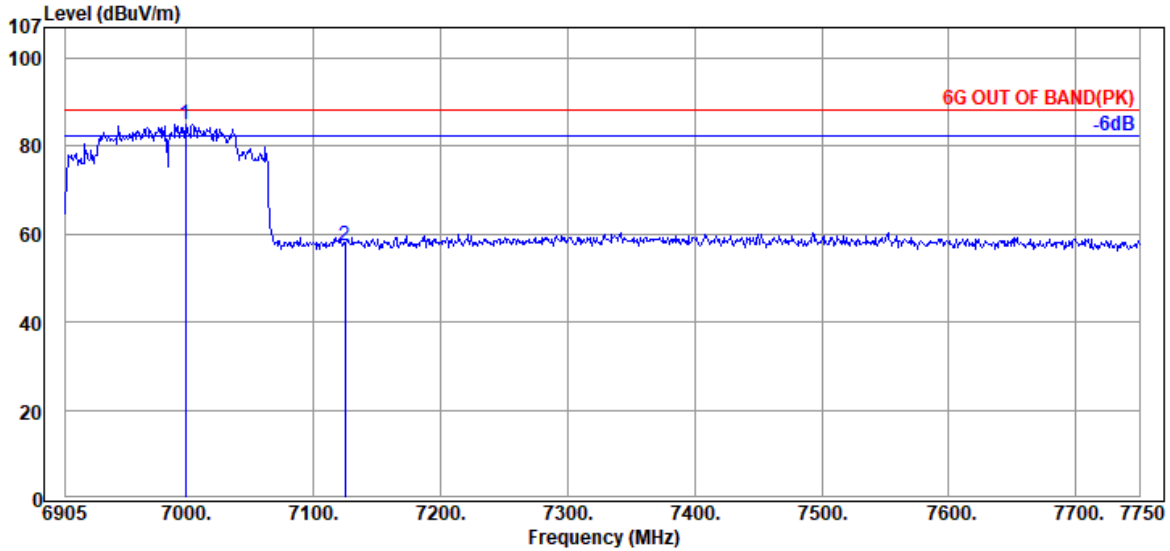

Antenna at Vertical Polarization

Emission Frequency (MHz)	Antenna Factor (dB/m)	Cable Loss (dB)	Preamplifier Gain (dB)	Read Level (dBμV)	Emission Level (dBμV/m)	Limits (dBμV/m)	Margin (dB)	Detector
6999.640	35.50	9.71	39.47	79.25	84.99	---	---	Peak
@ 7125.000	35.87	9.82	39.50	51.17	57.36	88.20	30.84	Peak

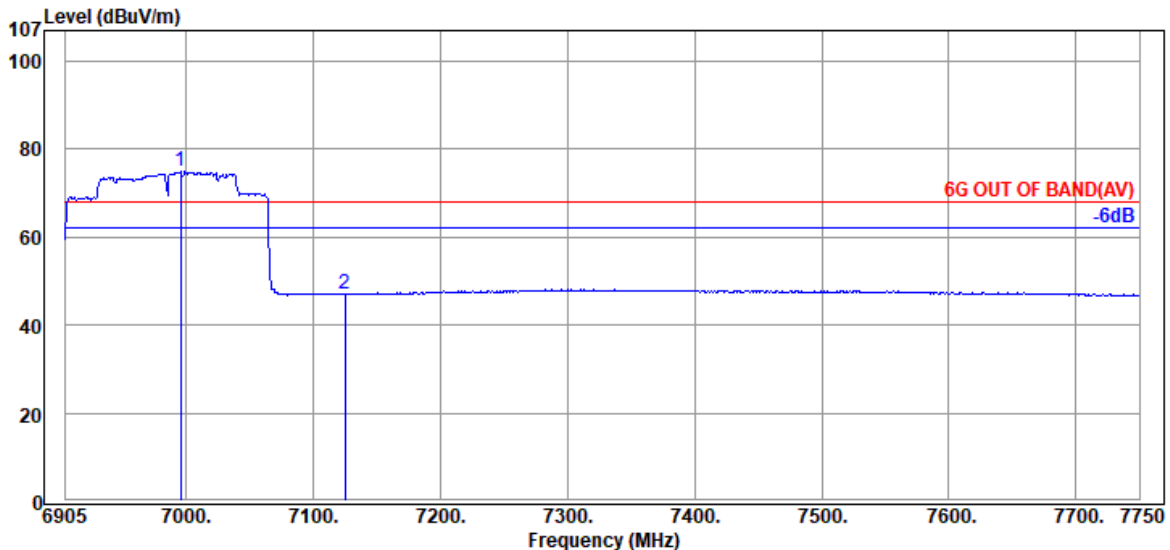

Antenna at Vertical Polarization

Emission Frequency (MHz)	Antenna Factor (dB/m)	Cable Loss (dB)	Preamplifier Gain (dB)	Read Level (dBμV)	Emission Level (dBμV/m)	Limits (dBμV/m)	Margin (dB)	Detector
6995.415	35.50	9.71	39.47	69.27	75.01	---	---	Average
@ 7125.000	35.87	9.82	39.50	40.85	47.04	68.20	21.16	Average

Remark: The “@” means fundamental frequency, it is ignored in this section.

● OFDMA Modulation

Tones	26T	RU Index	0
Mode	802.11ax-HE20	U-NII Band	5
		Frequency	TX 5955MHz

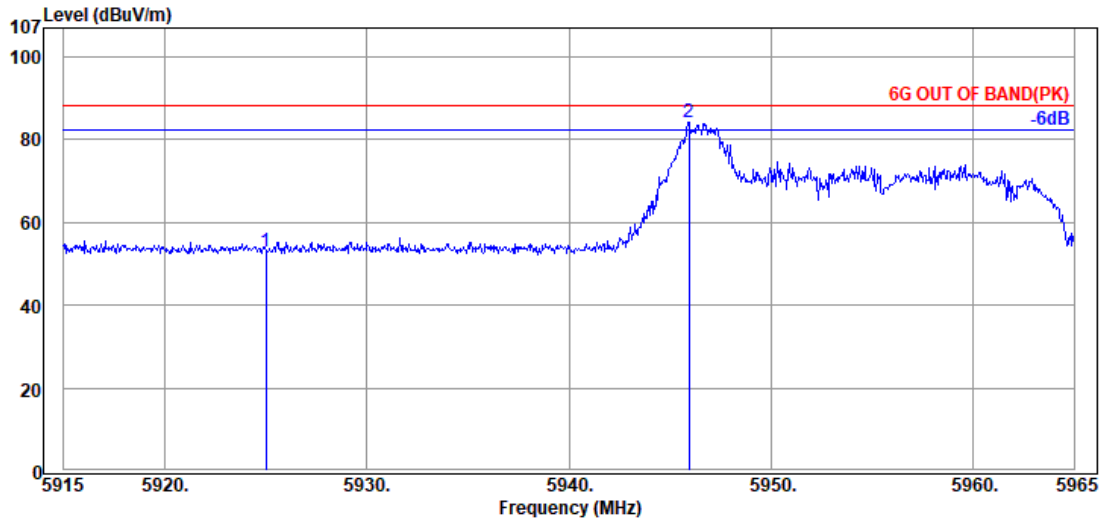

Antenna at Horizontal Polarization

Emission Frequency (MHz)	Antenna Factor (dB/m)	Cable Loss (dB)	Preamp Gain (dB)	Read Level (dBμV)	Emission Level (dBμV/m)	Limits (dBμV/m)	Margin (dB)	Detector
5925.000	34.23	9.30	39.35	48.87	53.05	88.20	35.15	Peak
@ 5945.950	34.30	9.30	39.35	79.89	84.14	---	---	Peak

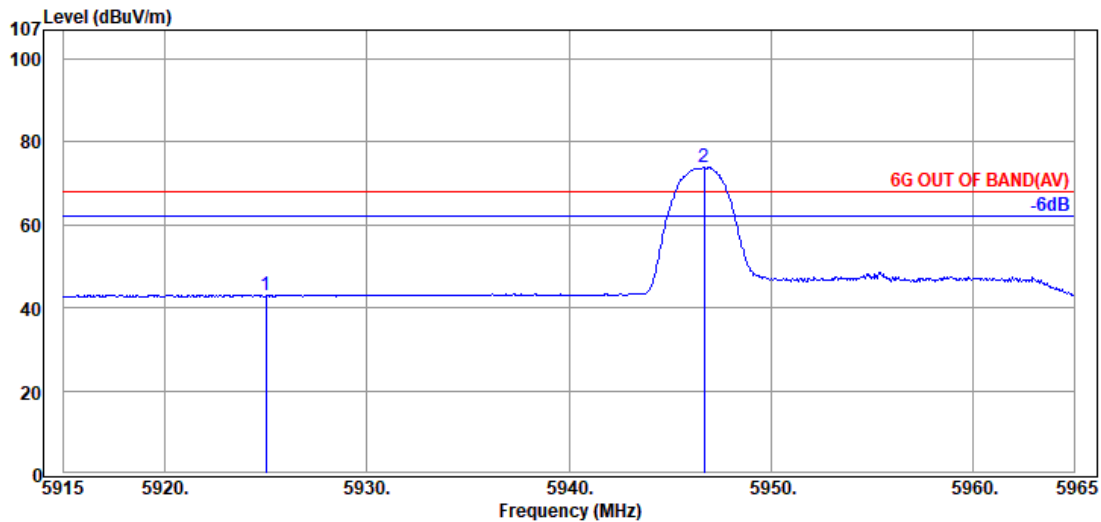

Antenna at Horizontal Polarization

Emission Frequency (MHz)	Antenna Factor (dB/m)	Cable Loss (dB)	Preamp Gain (dB)	Read Level (dBμV)	Emission Level (dBμV/m)	Limits (dBμV/m)	Margin (dB)	Detector
5925.000	34.23	9.30	39.35	38.73	42.91	68.20	25.29	Average
@ 5946.700	34.30	9.30	39.35	69.64	73.89	---	---	Average

Remark: The “@” means fundamental frequency, it is ignored in this section.

Tones	26T	RU Index	0
Mode	802.11ax-HE20	U-NII Band	5
		Frequency	TX 5955MHz

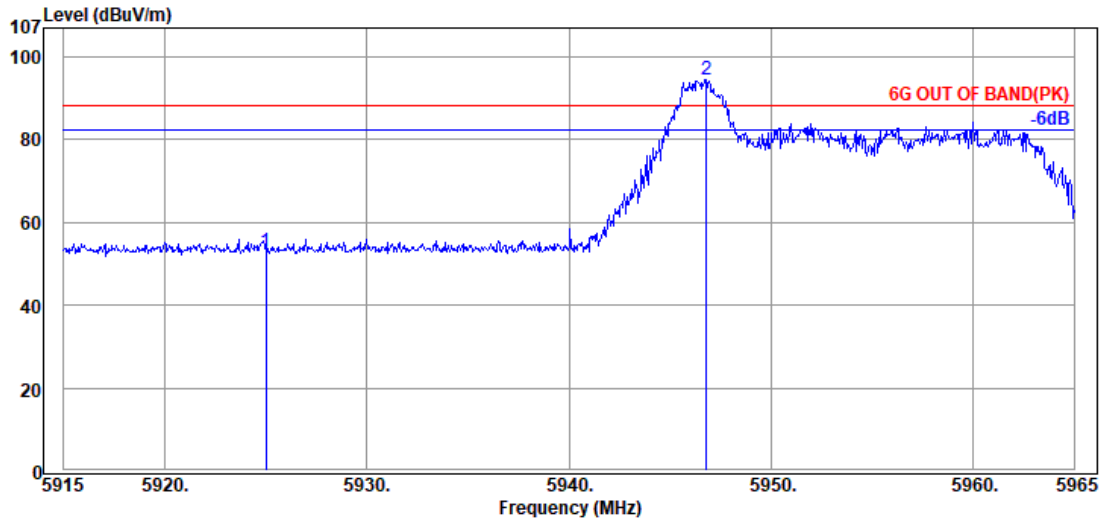

Antenna at Vertical Polarization

Emission Frequency (MHz)	Antenna Factor (dB/m)	Cable Loss (dB)	Preamplifier Gain (dB)	Read Level (dBμV)	Emission Level (dBμV/m)	Limits (dBμV/m)	Margin (dB)	Detector
5925.000	34.23	9.30	39.35	48.92	53.10	88.20	35.10	Peak
@ 5946.800	34.30	9.30	39.35	90.42	94.67	---	---	Peak

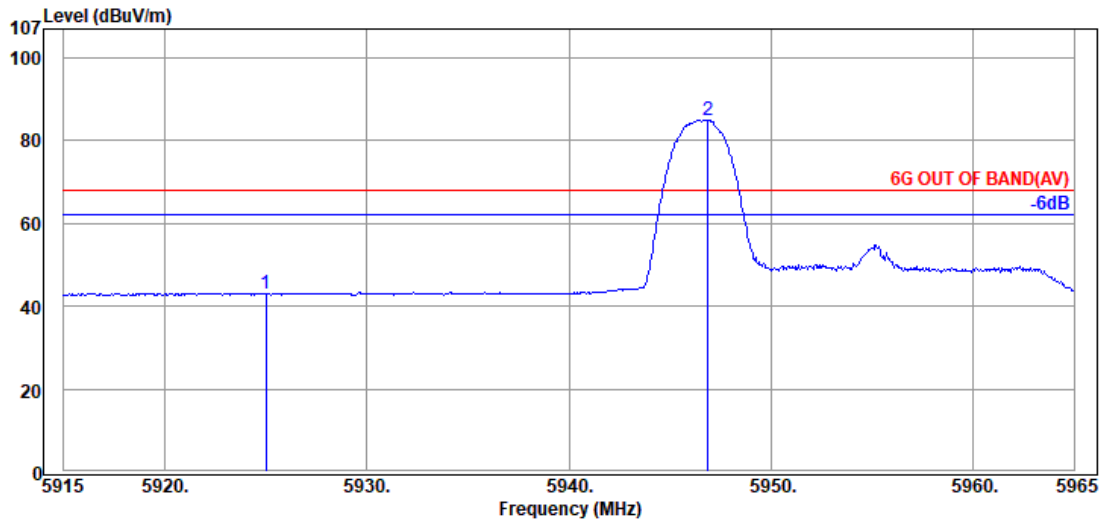

Antenna at Vertical Polarization

Emission Frequency (MHz)	Antenna Factor (dB/m)	Cable Loss (dB)	Preamplifier Gain (dB)	Read Level (dBμV)	Emission Level (dBμV/m)	Limits (dBμV/m)	Margin (dB)	Detector
5925.000	34.23	9.30	39.35	38.69	42.87	68.20	25.33	Average
@ 5946.900	34.30	9.30	39.35	80.77	85.02	---	---	Average

Remark: The “@” means fundamental frequency, it is ignored in this section.

Tones	26T	RU Index	8
Mode	802.11ax-HE20	U-NII Band	8
		Frequency	TX 7115MHz

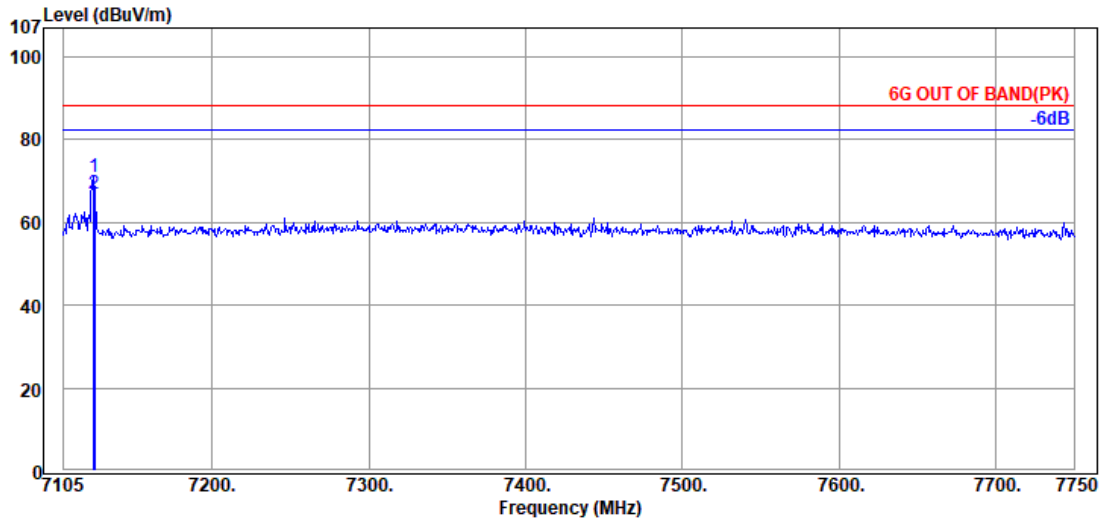

Antenna at Horizontal Polarization

Emission Frequency (MHz)	Antenna Factor (dB/m)	Cable Loss (dB)	Preamp Gain (dB)	Read Level (dBμV)	Emission Level (dBμV/m)	Limits (dBμV/m)	Margin (dB)	Detector
@ 7124.350	35.87	9.82	39.50	64.92	71.11	---	---	Peak
7125.000	35.87	9.82	39.50	60.65	66.84	88.20	21.36	Peak

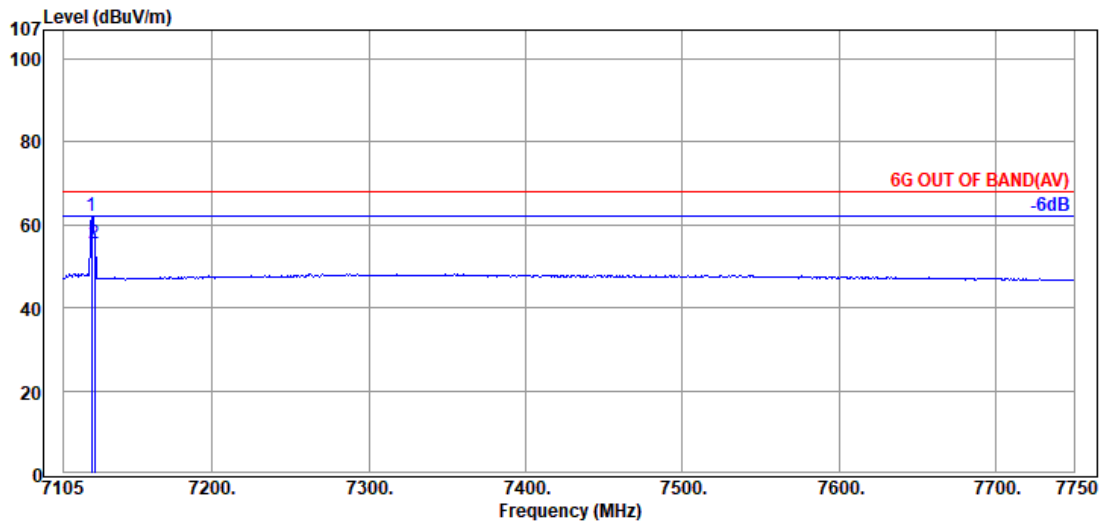

Antenna at Horizontal Polarization

Emission Frequency (MHz)	Antenna Factor (dB/m)	Cable Loss (dB)	Preamp Gain (dB)	Read Level (dBμV)	Emission Level (dBμV/m)	Limits (dBμV/m)	Margin (dB)	Detector
@ 7123.060	35.87	9.82	39.50	55.86	62.05	---	---	Average
7125.000	35.87	9.82	39.50	49.39	55.58	68.20	12.62	Average

Remark: The “@” means fundamental frequency, it is ignored in this section.

Tones	26T	RU Index	8
Mode	802.11ax-HE20	U-NII Band	8
		Frequency	TX 7115MHz

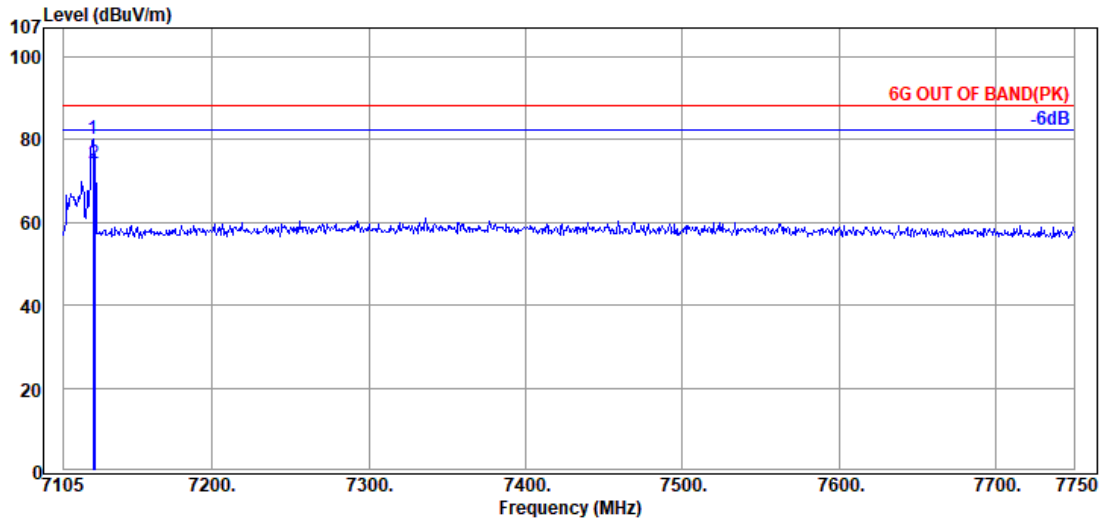

Antenna at Vertical Polarization

Emission Frequency (MHz)	Antenna Factor (dB/m)	Cable Loss (dB)	Preamplifier Gain (dB)	Read Level (dBμV)	Emission Level (dBμV/m)	Limits (dBμV/m)	Margin (dB)	Detector
@ 7123.705	35.87	9.82	39.50	74.10	80.29	---	---	Peak
7125.000	35.87	9.82	39.50	68.14	74.33	88.20	13.87	Peak

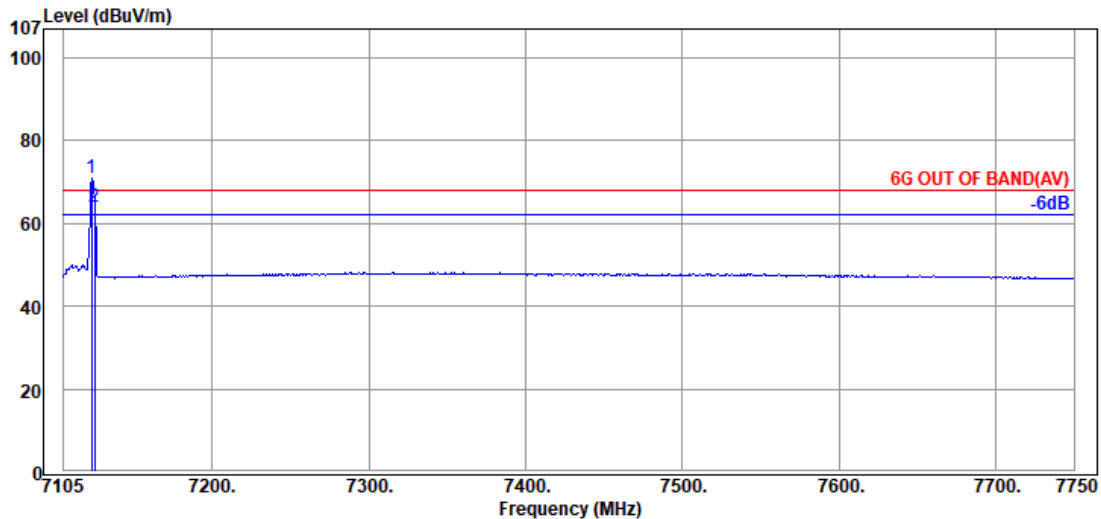

Antenna at Vertical Polarization

Emission Frequency (MHz)	Antenna Factor (dB/m)	Cable Loss (dB)	Preamplifier Gain (dB)	Read Level (dBμV)	Emission Level (dBμV/m)	Limits (dBμV/m)	Margin (dB)	Detector
@ 7123.060	35.87	9.82	39.50	64.61	70.80	---	---	Average
7125.000	35.87	9.82	39.50	57.94	64.13	68.20	4.07	Average

Remark: The “@” means fundamental frequency, it is ignored in this section.

Tones	52T	RU Index	37
Mode	802.11ax-HE20	U-NII Band	5
		Frequency	TX 5955MHz

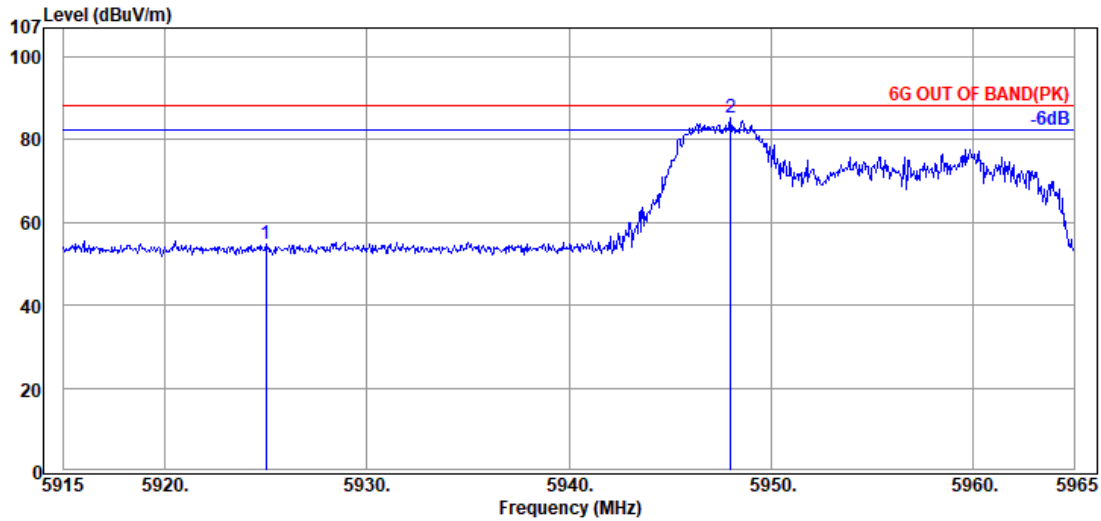

Antenna at Horizontal Polarization

Emission Frequency (MHz)	Antenna Factor (dB/m)	Cable Loss (dB)	Preamp Gain (dB)	Read Level (dBμV)	Emission Level (dBμV/m)	Limits (dBμV/m)	Margin (dB)	Detector
5925.000	34.23	9.30	39.35	50.65	54.83	88.20	33.37	Peak
@ 5948.000	34.30	9.30	39.35	81.05	85.30	---	---	Peak

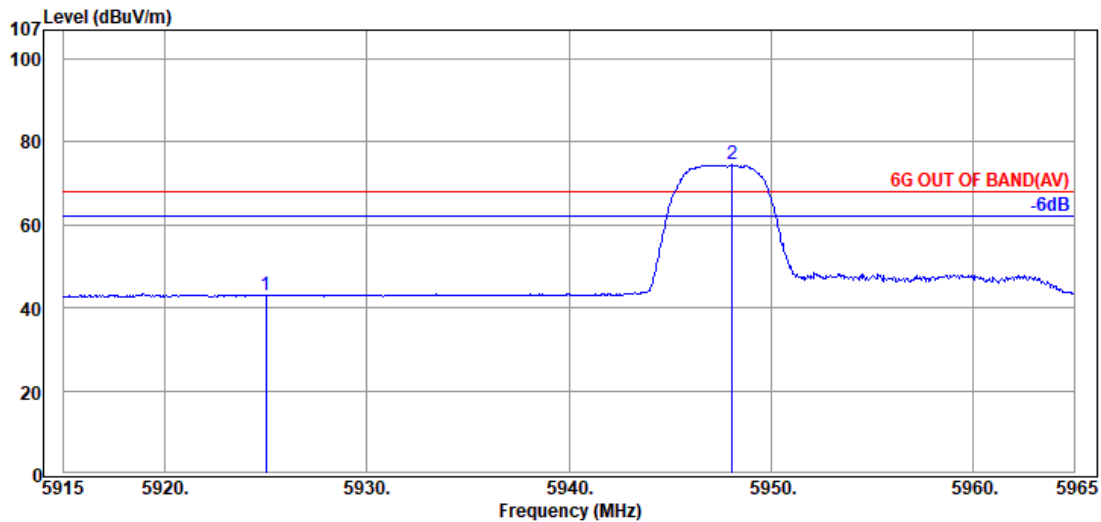

Antenna at Horizontal Polarization

Emission Frequency (MHz)	Antenna Factor (dB/m)	Cable Loss (dB)	Preamp Gain (dB)	Read Level (dBμV)	Emission Level (dBμV/m)	Limits (dBμV/m)	Margin (dB)	Detector
5925.000	34.23	9.30	39.35	38.76	42.94	68.20	25.26	Average
@ 5948.100	34.30	9.30	39.35	70.24	74.49	---	---	Average

Remark: The “@” means fundamental frequency, it is ignored in this section.

Tones	52T	RU Index	37
Mode	802.11ax-HE20	U-NII Band	5
		Frequency	TX 5955MHz

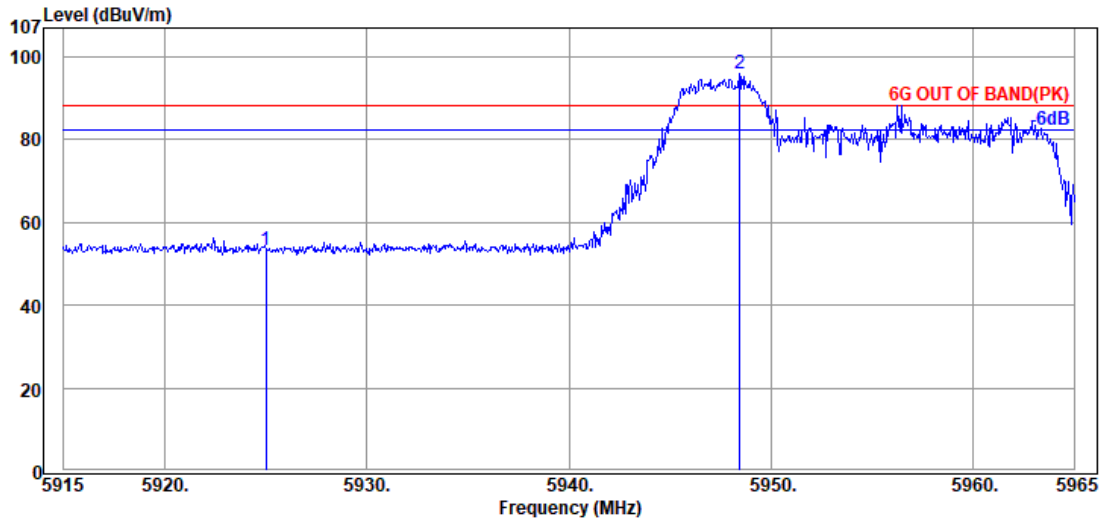

Antenna at Vertical Polarization

Emission Frequency (MHz)	Antenna Factor (dB/m)	Cable Loss (dB)	Preamplifier Gain (dB)	Read Level (dBμV)	Emission Level (dBμV/m)	Limits (dBμV/m)	Margin (dB)	Detector
5925.000	34.23	9.30	39.35	49.10	53.28	88.20	34.92	Peak
@ 5948.450	34.30	9.30	39.35	91.77	96.02	---	---	Peak

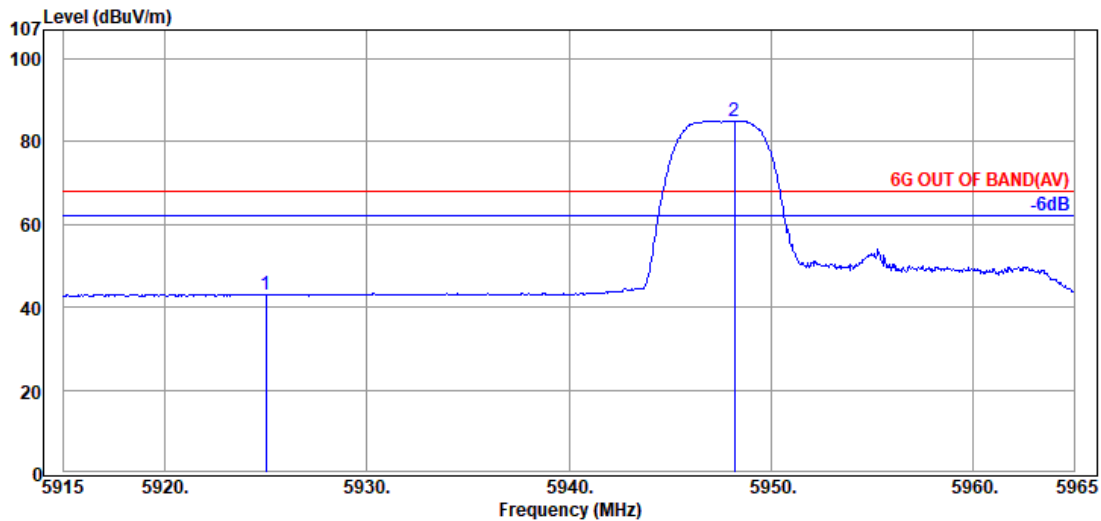

Antenna at Vertical Polarization

Emission Frequency (MHz)	Antenna Factor (dB/m)	Cable Loss (dB)	Preamplifier Gain (dB)	Read Level (dBμV)	Emission Level (dBμV/m)	Limits (dBμV/m)	Margin (dB)	Detector
5925.000	34.23	9.30	39.35	38.88	43.06	68.20	25.14	Average
@ 5948.200	34.30	9.30	39.35	80.84	85.09	---	---	Average

Remark: The “@” means fundamental frequency, it is ignored in this section.

Tones	52T	RU Index	40
Mode	802.11ax-HE20	U-NII Band	8
		Frequency	TX 7115MHz

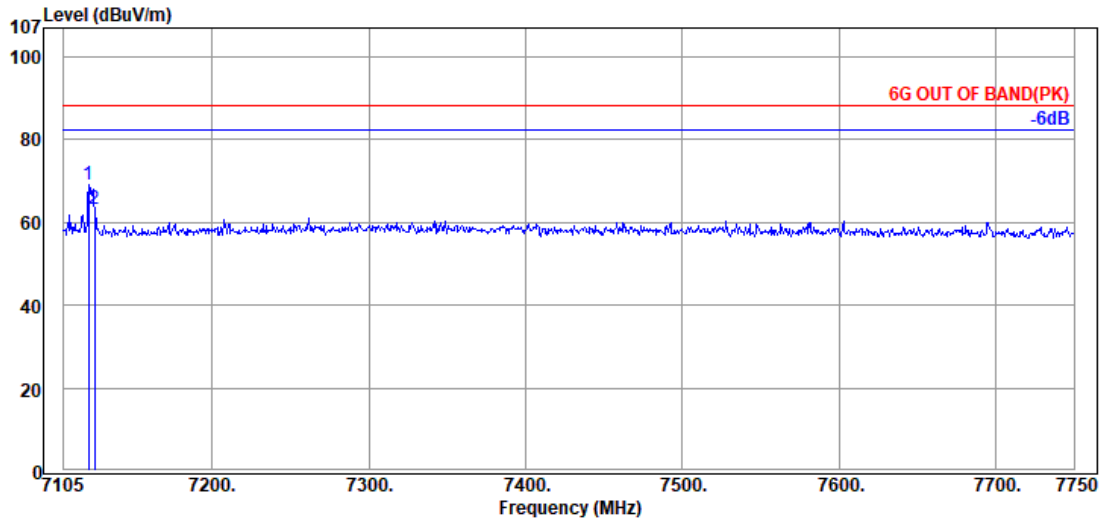

Antenna at Horizontal Polarization

Emission Frequency (MHz)	Antenna Factor (dB/m)	Cable Loss (dB)	Preamp Gain (dB)	Read Level (dBμV)	Emission Level (dBμV/m)	Limits (dBμV/m)	Margin (dB)	Detector
@ 7121.125	35.87	9.82	39.50	62.99	69.18	---	---	Peak
7125.000	35.87	9.82	39.50	57.22	63.41	88.20	24.79	Peak

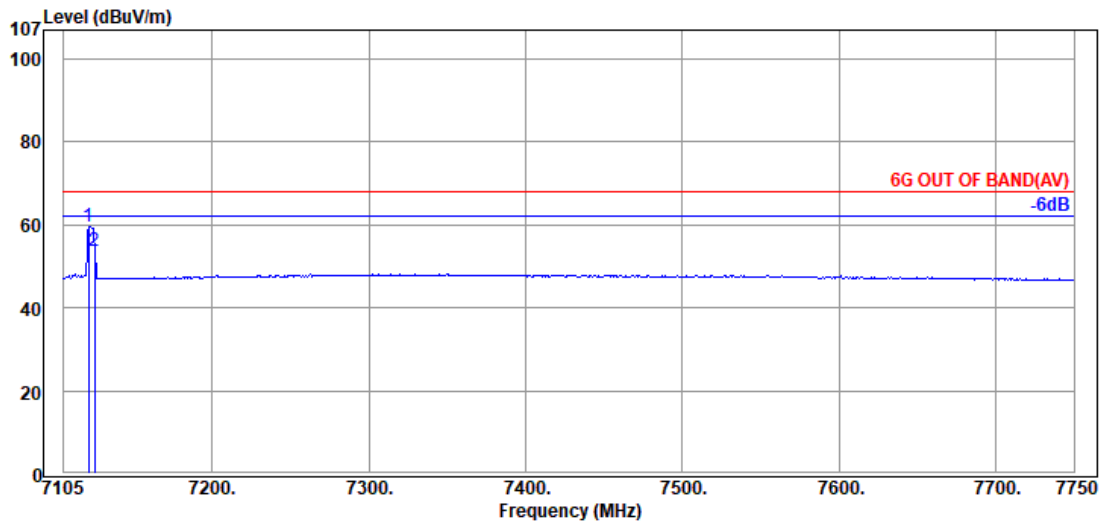

Antenna at Horizontal Polarization

Emission Frequency (MHz)	Antenna Factor (dB/m)	Cable Loss (dB)	Preamp Gain (dB)	Read Level (dBμV)	Emission Level (dBμV/m)	Limits (dBμV/m)	Margin (dB)	Detector
@ 7121.125	35.87	9.82	39.50	53.45	59.64	---	---	Average
7125.000	35.87	9.82	39.50	47.33	53.52	68.20	14.68	Average

Remark: The “@” means fundamental frequency, it is ignored in this section.

Tones	52T	RU Index	40
Mode	802.11ax-HE20	U-NII Band	8
		Frequency	TX 7115MHz

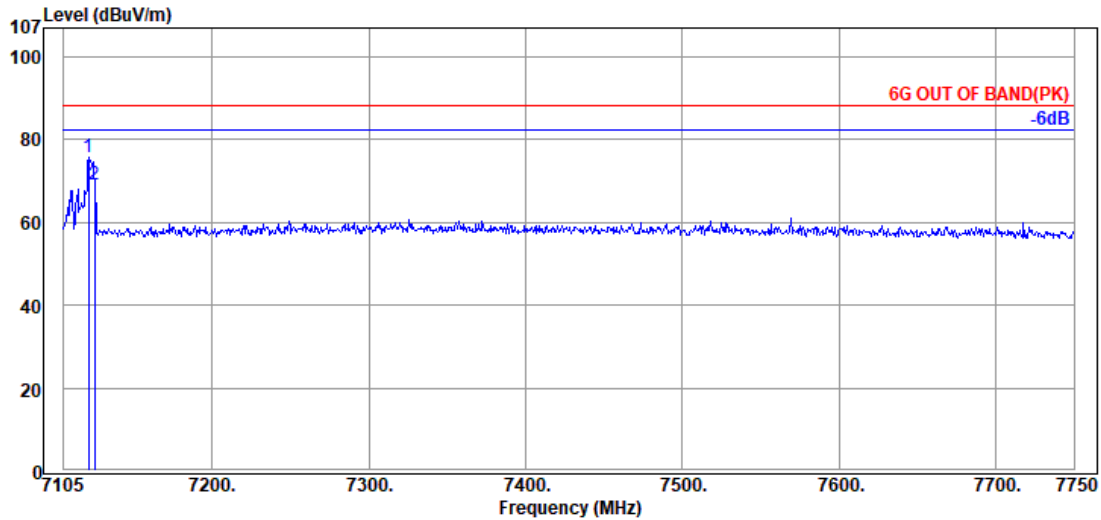

Antenna at Vertical Polarization

Emission Frequency (MHz)	Antenna Factor (dB/m)	Cable Loss (dB)	Preamplifier Gain (dB)	Read Level (dBμV)	Emission Level (dBμV/m)	Limits (dBμV/m)	Margin (dB)	Detector
@ 7121.125	35.87	9.82	39.50	69.69	75.88	---	---	Peak
7125.000	35.87	9.82	39.50	62.96	69.15	88.20	19.05	Peak

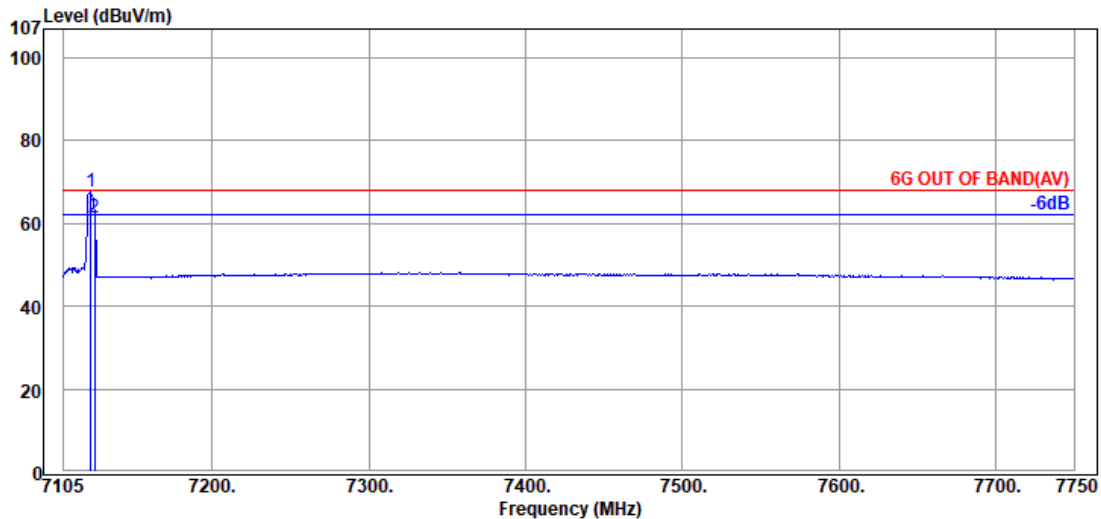

Antenna at Vertical Polarization

Emission Frequency (MHz)	Antenna Factor (dB/m)	Cable Loss (dB)	Preamplifier Gain (dB)	Read Level (dBμV)	Emission Level (dBμV/m)	Limits (dBμV/m)	Margin (dB)	Detector
@ 7122.415	35.87	9.82	39.50	61.51	67.70	---	---	Average
7125.000	35.87	9.82	39.50	55.36	61.55	68.20	6.65	Average

Remark: The “@” means fundamental frequency, it is ignored in this section.

Tones	106T	RU Index	53
Mode	802.11ax-HE20	U-NII Band	5
		Frequency	TX 5955MHz

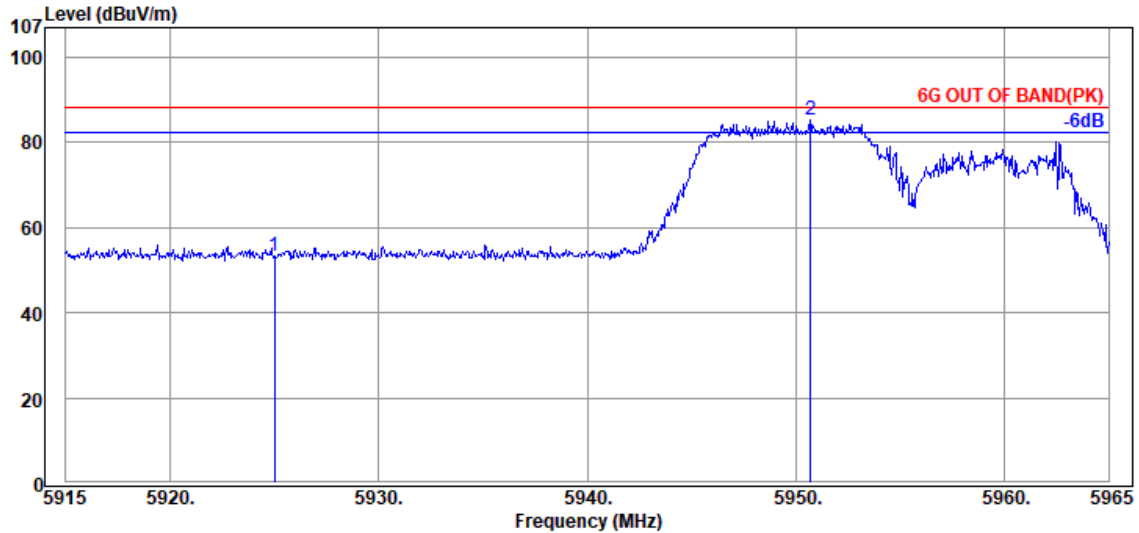

Antenna at Horizontal Polarization

Emission Frequency (MHz)	Antenna Factor (dB/m)	Cable Loss (dB)	Preamp Gain (dB)	Read Level (dBμV)	Emission Level (dBμV/m)	Limits (dBμV/m)	Margin (dB)	Detector
5925.000	34.23	9.30	39.35	49.26	53.44	88.20	34.76	Peak
@ 5950.700	34.30	9.30	39.35	81.02	85.27	---	---	Peak

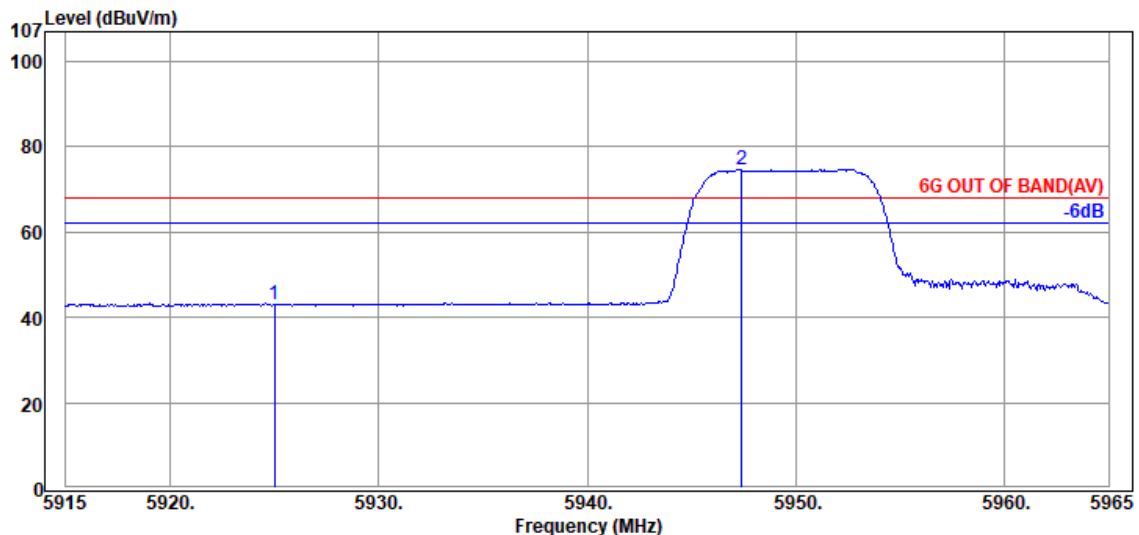

Antenna at Horizontal Polarization

Emission Frequency (MHz)	Antenna Factor (dB/m)	Cable Loss (dB)	Preamp Gain (dB)	Read Level (dBμV)	Emission Level (dBμV/m)	Limits (dBμV/m)	Margin (dB)	Detector
5925.000	34.23	9.30	39.35	38.75	42.93	68.20	25.27	Average
@ 5947.400	34.30	9.30	39.35	70.47	74.72	---	---	Average

Remark: The “@” means fundamental frequency, it is ignored in this section.

Tones	106T	RU Index	53
Mode	802.11ax-HE20	U-NII Band	5
		Frequency	TX 5955MHz

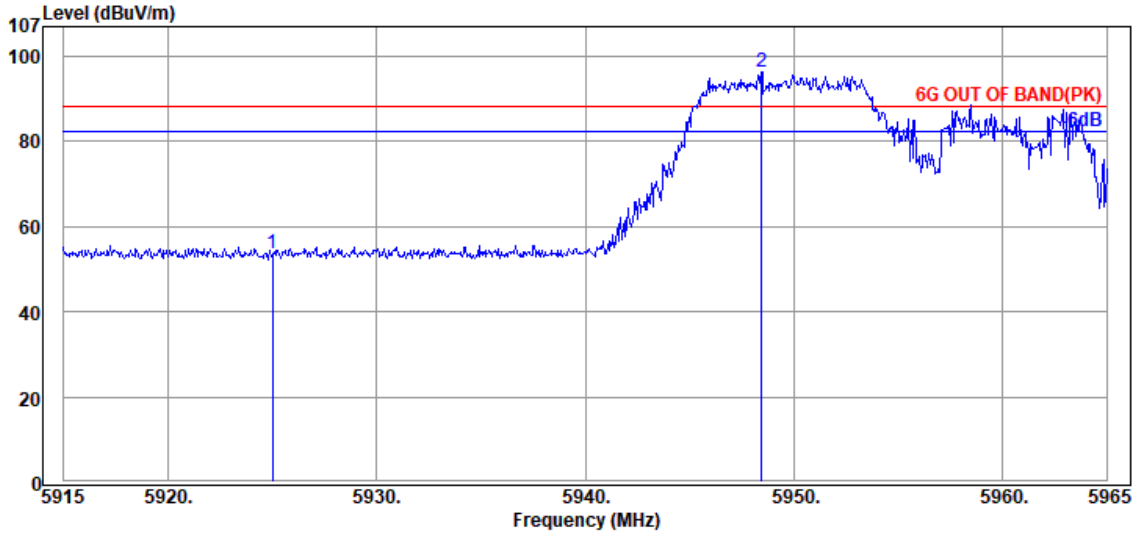

Antenna at Vertical Polarization

Emission Frequency (MHz)	Antenna Factor (dB/m)	Cable Loss (dB)	Preamp Gain (dB)	Read Level (dBμV)	Emission Level (dBμV/m)	Limits (dBμV/m)	Margin (dB)	Detector
5925.000	34.23	9.30	39.35	49.59	53.77	88.20	34.43	Peak
@ 5948.450	34.30	9.30	39.35	92.26	96.51	---	---	Peak

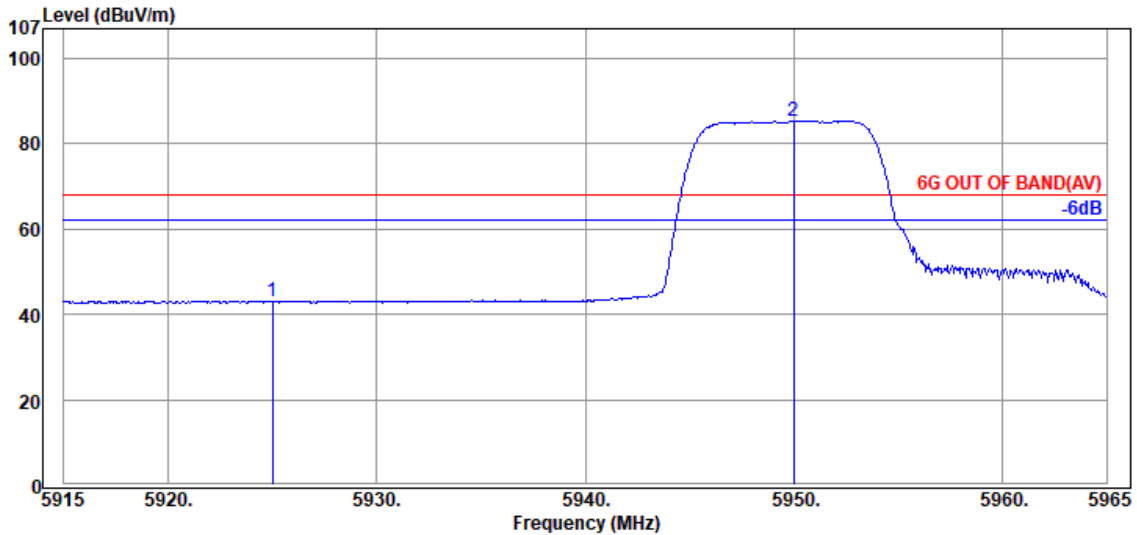

Antenna at Vertical Polarization

Emission Frequency (MHz)	Antenna Factor (dB/m)	Cable Loss (dB)	Preamp Gain (dB)	Read Level (dBμV)	Emission Level (dBμV/m)	Limits (dBμV/m)	Margin (dB)	Detector
5925.000	34.23	9.30	39.35	38.96	43.14	68.20	25.06	Average
@ 5950.000	34.30	9.30	39.35	81.17	85.42	---	---	Average

Remark: The “@” means fundamental frequency, it is ignored in this section.

Tones	106T	RU Index	54
Mode	802.11ax-HE20	U-NII Band	8
		Frequency	TX 7115MHz

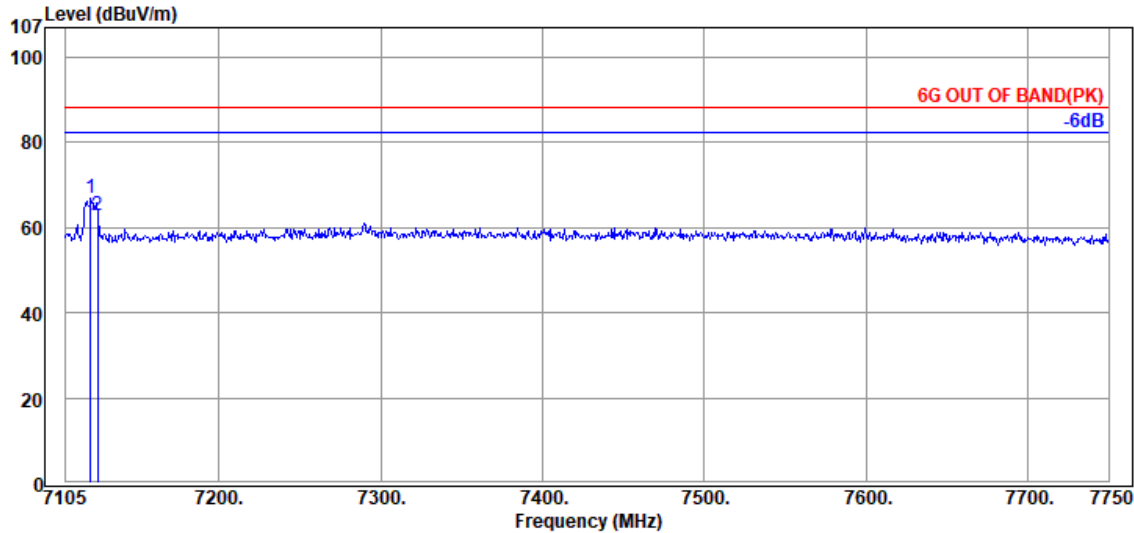

Antenna at Horizontal Polarization

Emission Frequency (MHz)	Antenna Factor (dB/m)	Cable Loss (dB)	Preamplifier Gain (dB)	Read Level (dBμV)	Emission Level (dBμV/m)	Limits (dBμV/m)	Margin (dB)	Detector
@ 7120.480	35.87	9.82	39.50	60.72	66.91	---	---	Peak
7125.000	35.87	9.82	39.50	56.68	62.87	88.20	25.33	Peak

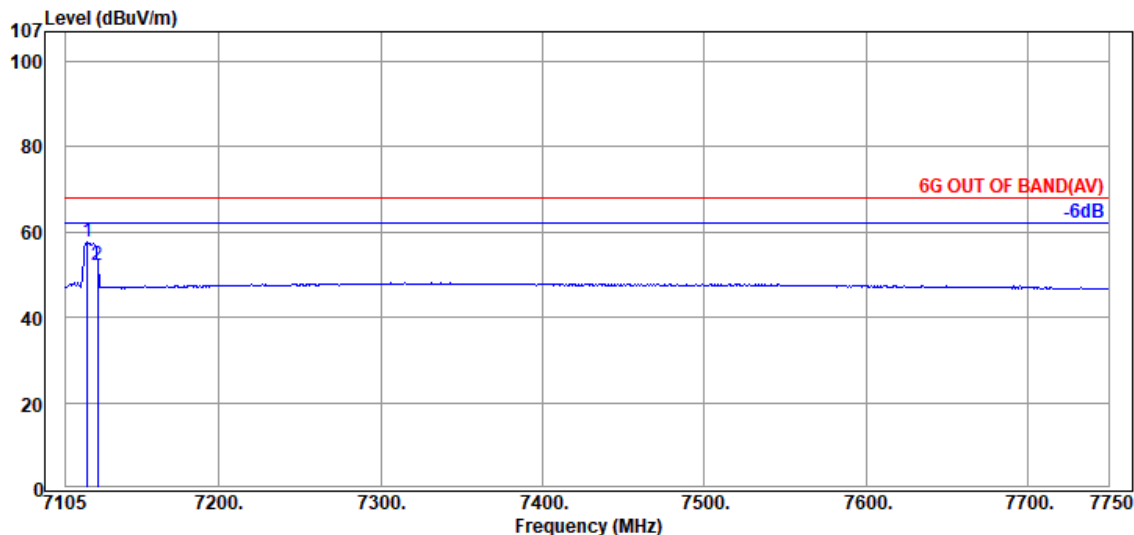

Antenna at Horizontal Polarization

Emission Frequency (MHz)	Antenna Factor (dB/m)	Cable Loss (dB)	Preamplifier Gain (dB)	Read Level (dBμV)	Emission Level (dBμV/m)	Limits (dBμV/m)	Margin (dB)	Detector
@ 7118.545	35.87	9.82	39.50	51.47	57.66	---	---	Average
7125.000	35.87	9.82	39.50	45.97	52.16	68.20	16.04	Average

Remark: The “@” means fundamental frequency, it is ignored in this section.

Tones	106T	RU Index	54
Mode	802.11ax-HE20	U-NII Band	8
		Frequency	TX 7115MHz

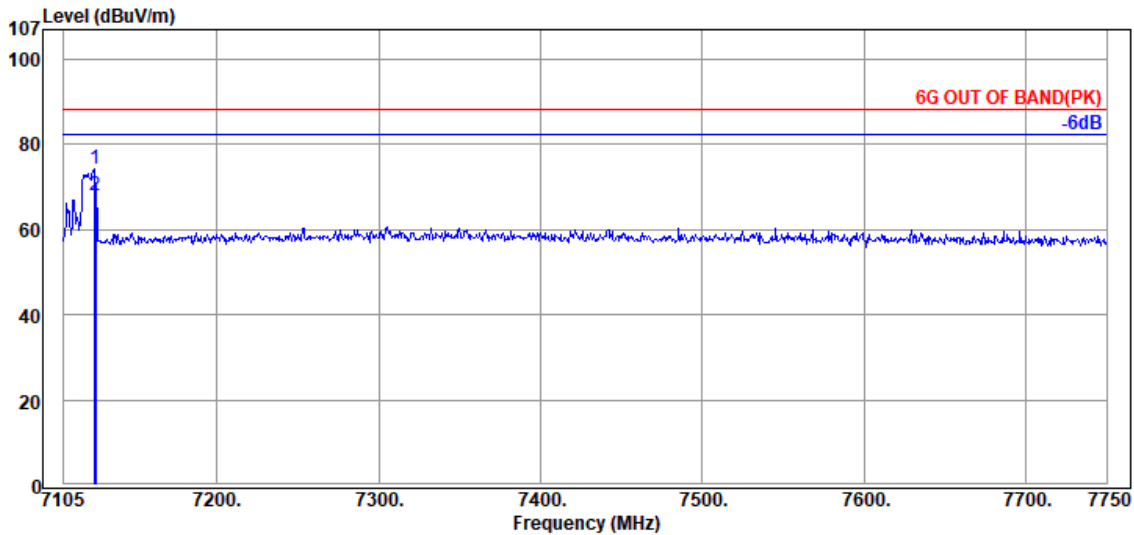

Antenna at Vertical Polarization

Emission Frequency (MHz)	Antenna Factor (dB/m)	Cable Loss (dB)	Preamplifier Gain (dB)	Read Level (dBμV)	Emission Level (dBμV/m)	Limits (dBμV/m)	Margin (dB)	Detector
@ 7124.350	35.87	9.82	39.50	68.03	74.22	---	---	Peak
7125.000	35.87	9.82	39.50	61.75	67.94	88.20	20.26	Peak

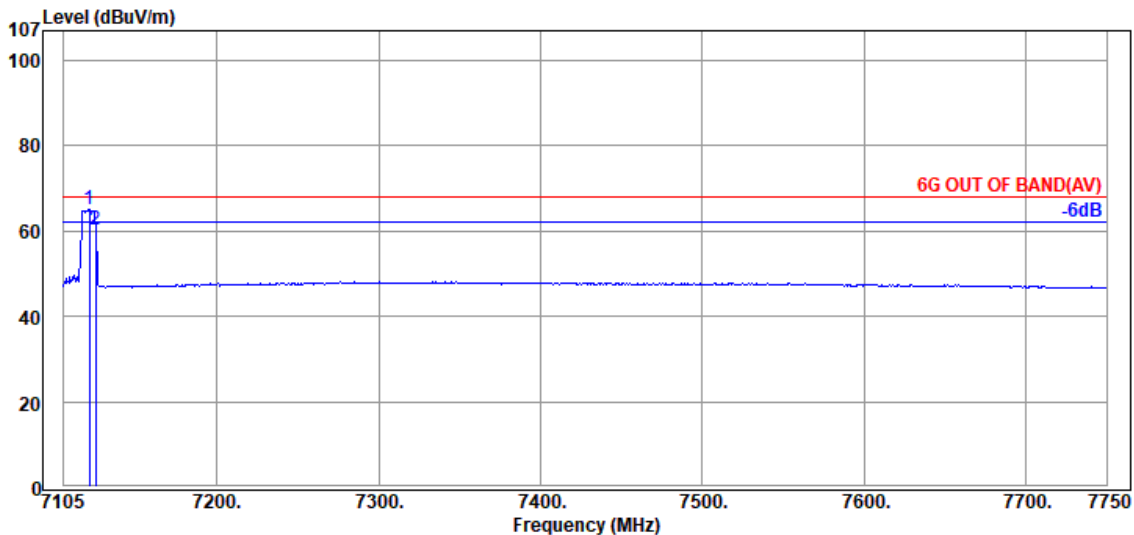

Antenna at Vertical Polarization

Emission Frequency (MHz)	Antenna Factor (dB/m)	Cable Loss (dB)	Preamplifier Gain (dB)	Read Level (dBμV)	Emission Level (dBμV/m)	Limits (dBμV/m)	Margin (dB)	Detector
@ 7121.125	35.87	9.82	39.50	58.89	65.08	---	---	Average
7125.000	35.87	9.82	39.50	53.95	60.14	68.20	8.06	Average

Remark: The “@” means fundamental frequency, it is ignored in this section.

Tones	106T	RU Index	56
Mode	802.11ax-HE40	U-NII Band	8
		Frequency	TX 7085MHz

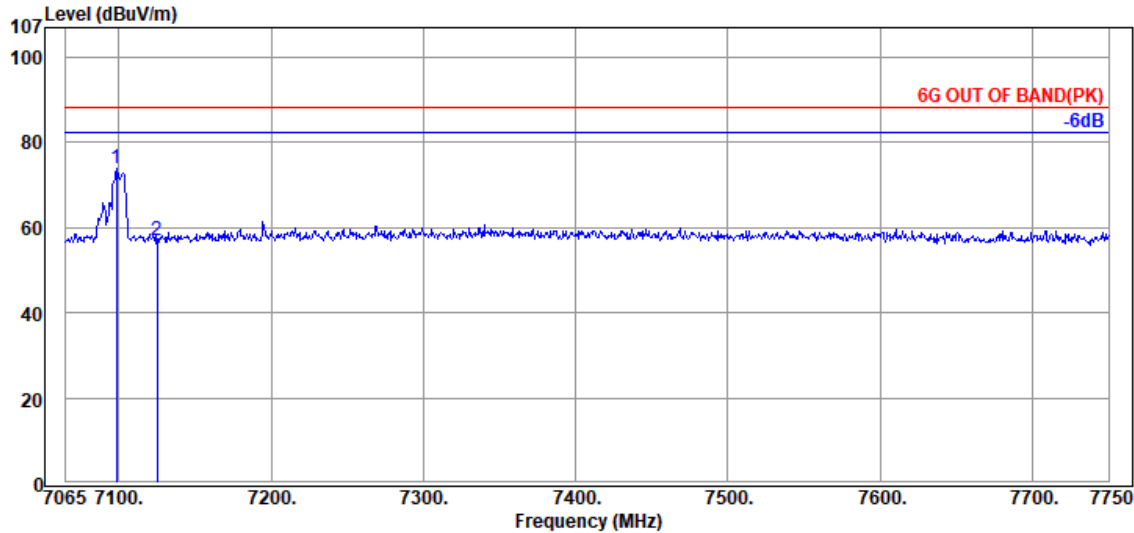

Antenna at Horizontal Polarization

Emission Frequency (MHz)	Antenna Factor (dB/m)	Cable Loss (dB)	Preamp Gain (dB)	Read Level (dBμV)	Emission Level (dBμV/m)	Limits (dBμV/m)	Margin (dB)	Detector
@ 7098.565	35.80	9.80	39.49	67.67	73.78	---	---	Peak
7125.000	35.87	9.82	39.50	50.97	57.16	88.20	31.04	Peak

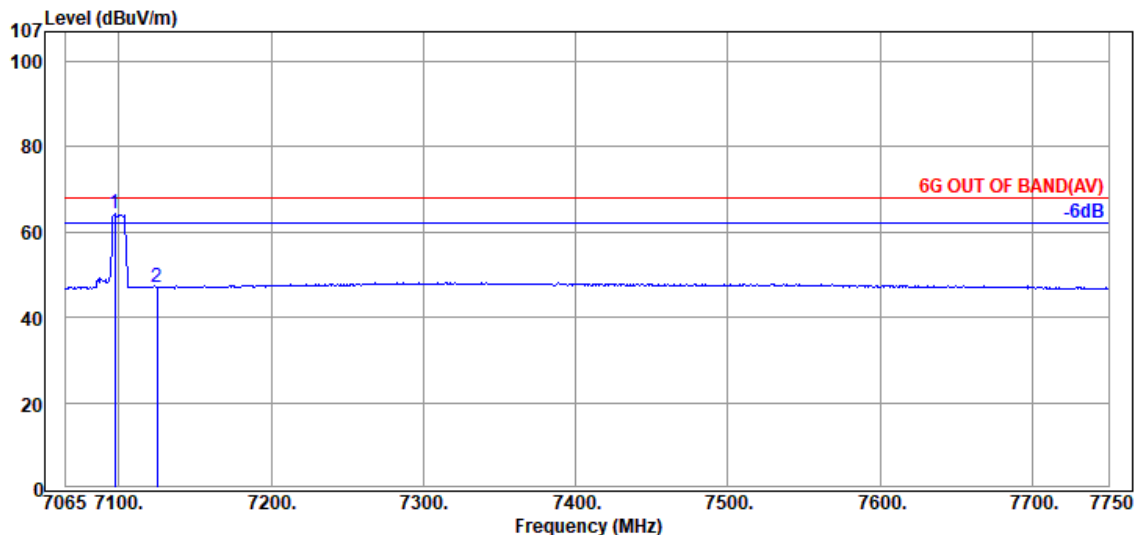

Antenna at Horizontal Polarization

Emission Frequency (MHz)	Antenna Factor (dB/m)	Cable Loss (dB)	Preamp Gain (dB)	Read Level (dBμV)	Emission Level (dBμV/m)	Limits (dBμV/m)	Margin (dB)	Detector
@ 7097.195	35.80	9.80	39.49	58.12	64.23	---	---	Average
7125.000	35.87	9.82	39.50	40.76	46.95	68.20	21.25	Average

Remark: The "@" means fundamental frequency, it is ignored in this section.

Tones	106T	RU Index	56
Mode	802.11ax-HE40	U-NII Band	8
		Frequency	TX 7085MHz

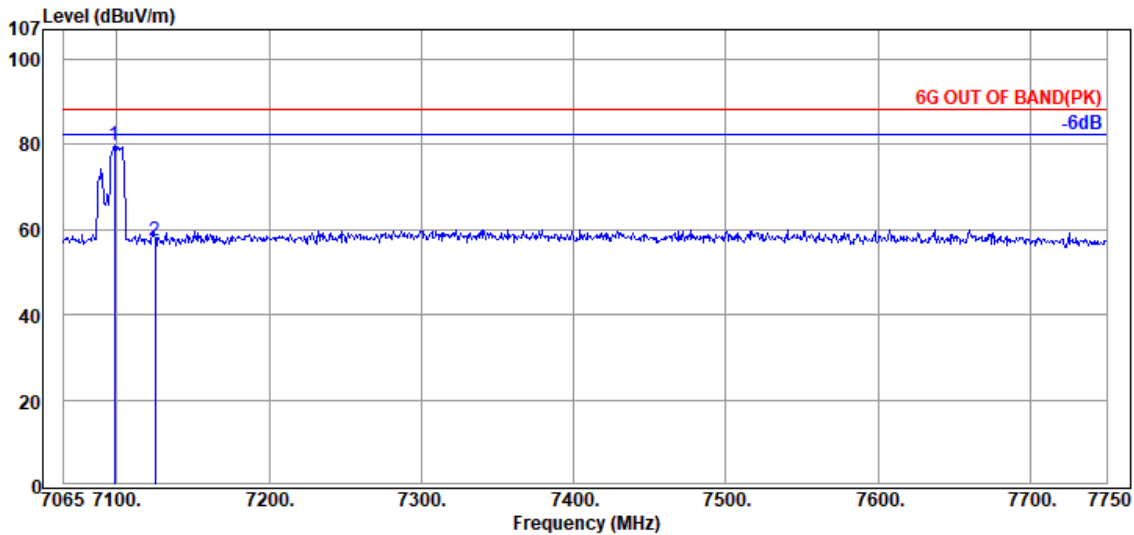

Antenna at Vertical Polarization

Emission Frequency (MHz)	Antenna Factor (dB/m)	Cable Loss (dB)	Preamplifier Gain (dB)	Read Level (dBμV)	Emission Level (dBμV/m)	Limits (dBμV/m)	Margin (dB)	Detector
@ 7098.565	35.80	9.80	39.49	73.53	79.64	---	---	Peak
7125.000	35.87	9.82	39.50	51.11	57.30	88.20	30.90	Peak

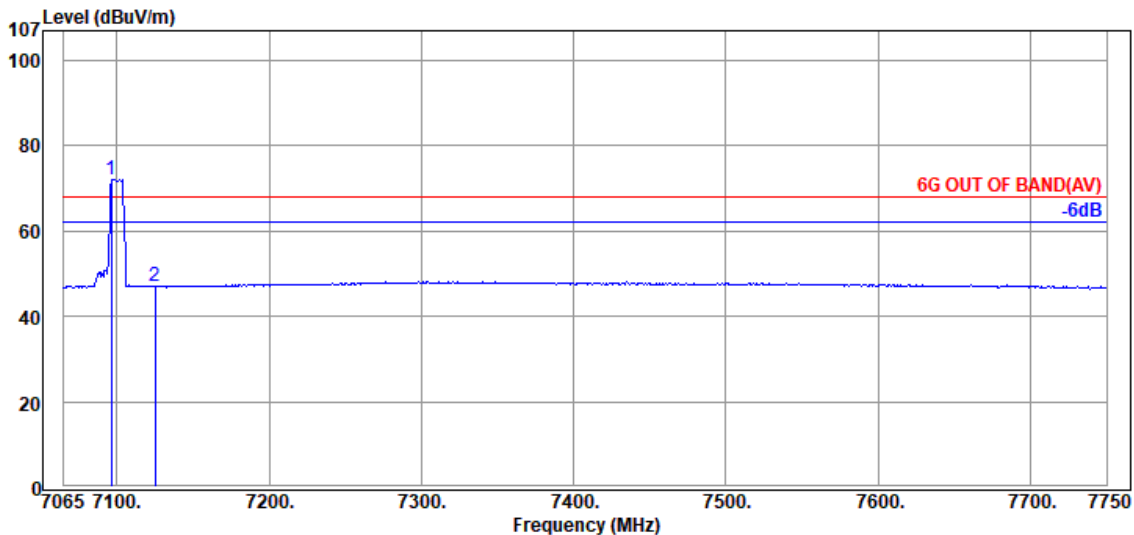

Antenna at Vertical Polarization

Emission Frequency (MHz)	Antenna Factor (dB/m)	Cable Loss (dB)	Preamplifier Gain (dB)	Read Level (dBμV)	Emission Level (dBμV/m)	Limits (dBμV/m)	Margin (dB)	Detector
@ 7096.510	35.80	9.80	39.49	66.12	72.23	---	---	Average
7125.000	35.87	9.82	39.50	41.05	47.24	68.20	20.96	Average

Remark: The “@” means fundamental frequency, it is ignored in this section.

Tones	242T	RU Index	61
Mode	802.11ax-HE20	U-NII Band	5
		Frequency	TX 7115MHz

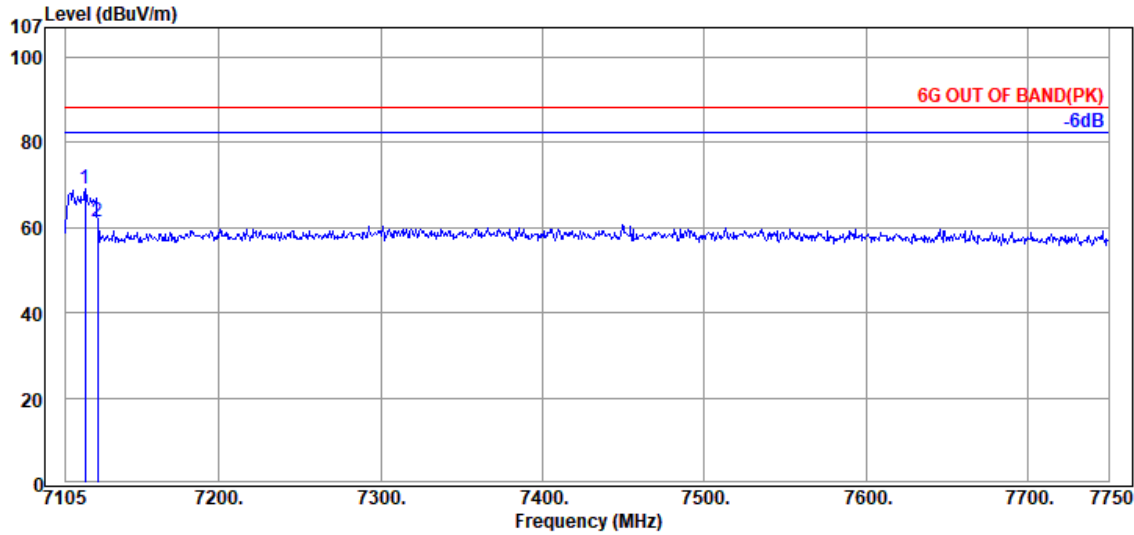

Antenna at Horizontal Polarization

Emission Frequency (MHz)	Antenna Factor (dB/m)	Cable Loss (dB)	Preamplifier Gain (dB)	Read Level (dBμV)	Emission Level (dBμV/m)	Limits (dBμV/m)	Margin (dB)	Detector
7117.255	35.87	9.82	39.50	62.87	69.06	88.20	19.14	Peak
@ 7125.000	35.87	9.82	39.50	55.27	61.46	---	---	Peak

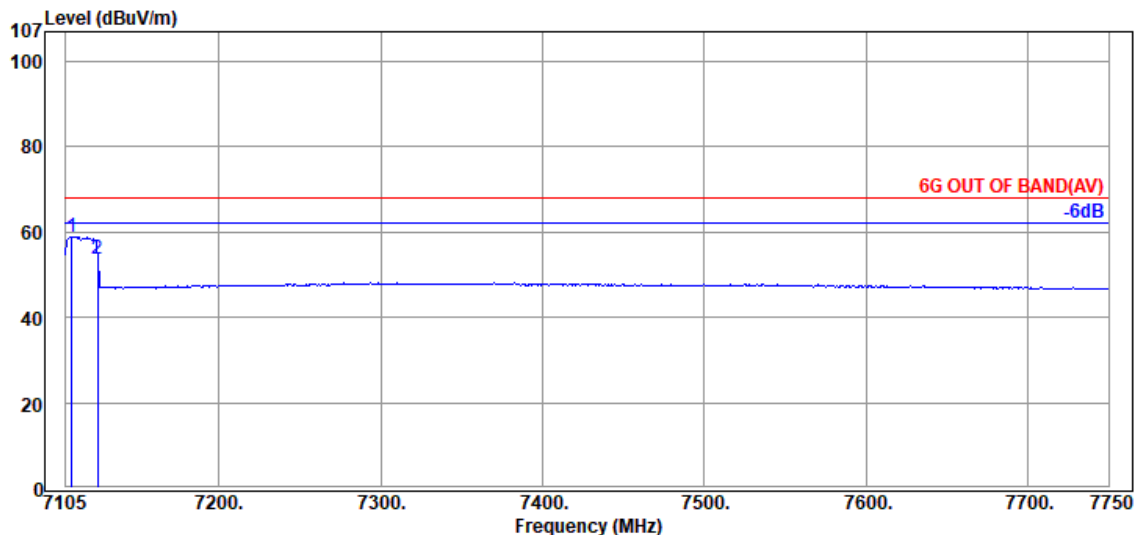

Antenna at Horizontal Polarization

Emission Frequency (MHz)	Antenna Factor (dB/m)	Cable Loss (dB)	Preamplifier Gain (dB)	Read Level (dBμV)	Emission Level (dBμV/m)	Limits (dBμV/m)	Margin (dB)	Detector
7108.870	35.87	9.82	39.49	52.62	58.82	68.20	9.38	Average
@ 7125.000	35.87	9.82	39.50	47.32	53.51	---	---	Average

Remark: The “@” means fundamental frequency, it is ignored in this section.

Tones	242T	RU Index	61
Mode	802.11ax-HE20	U-NII Band	5
		Frequency	TX 7115MHz

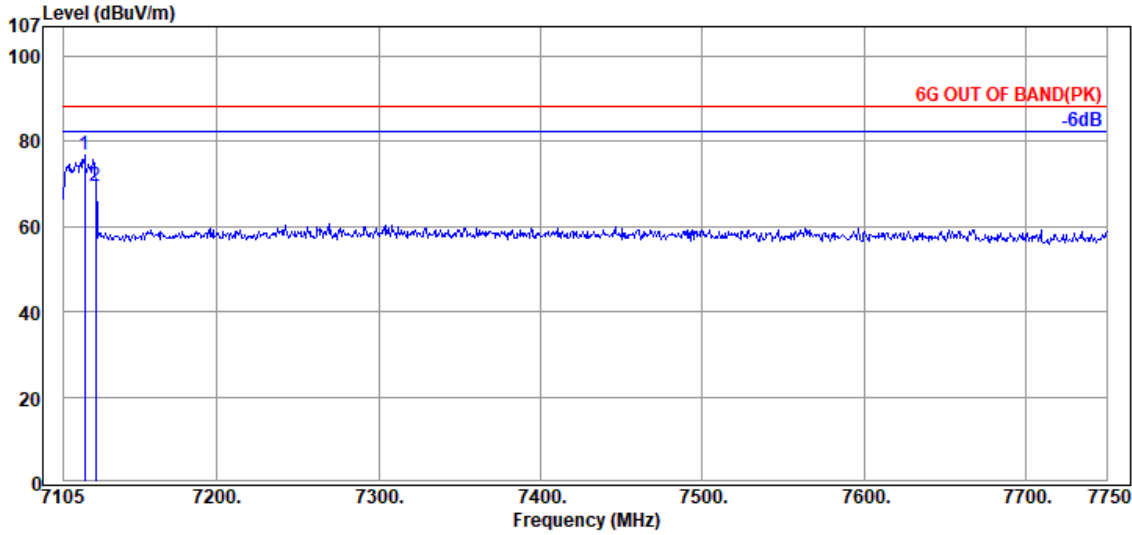

Antenna at Vertical Polarization

Emission Frequency (MHz)	Antenna Factor (dB/m)	Cable Loss (dB)	Preamplifier Gain (dB)	Read Level (dBμV)	Emission Level (dBμV/m)	Limits (dBμV/m)	Margin (dB)	Detector
7117.900	35.87	9.82	39.50	70.73	76.92	88.20	11.28	Peak
@ 7125.000	35.87	9.82	39.50	63.21	69.40	---	---	Peak

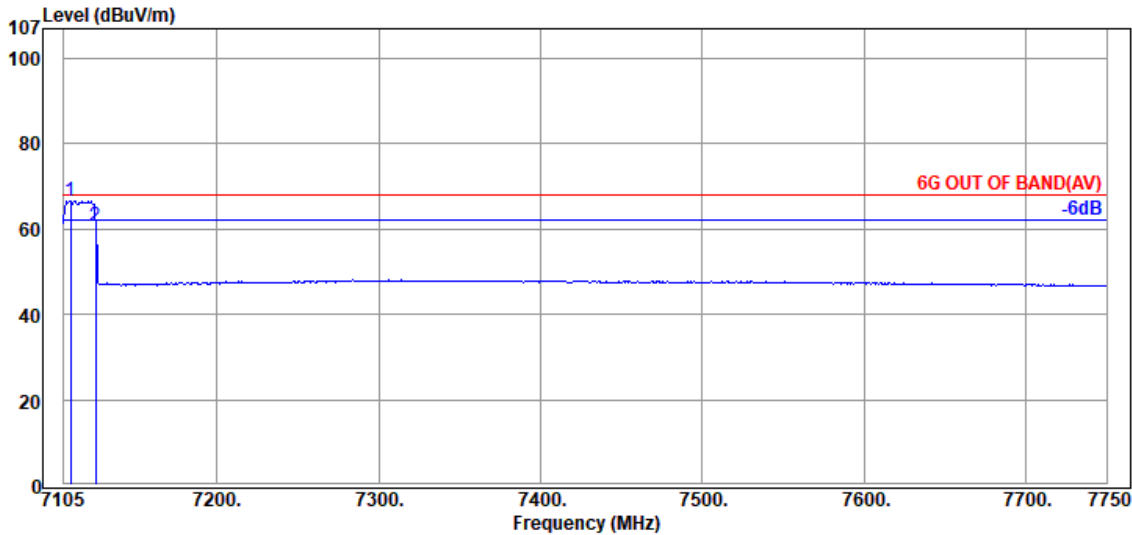

Antenna at Vertical Polarization

Emission Frequency (MHz)	Antenna Factor (dB/m)	Cable Loss (dB)	Preamplifier Gain (dB)	Read Level (dBμV)	Emission Level (dBμV/m)	Limits (dBμV/m)	Margin (dB)	Detector
7109.515	35.87	9.82	39.50	60.45	66.64	68.20	1.56	Average
@ 7125.000	35.87	9.82	39.50	54.49	60.68	---	---	Average

Remark: The “@” means fundamental frequency, it is ignored in this section.

Tones	242T	RU Index	62
Mode	802.11ax-HE40	U-NII Band	8
		Frequency	TX 7085MHz

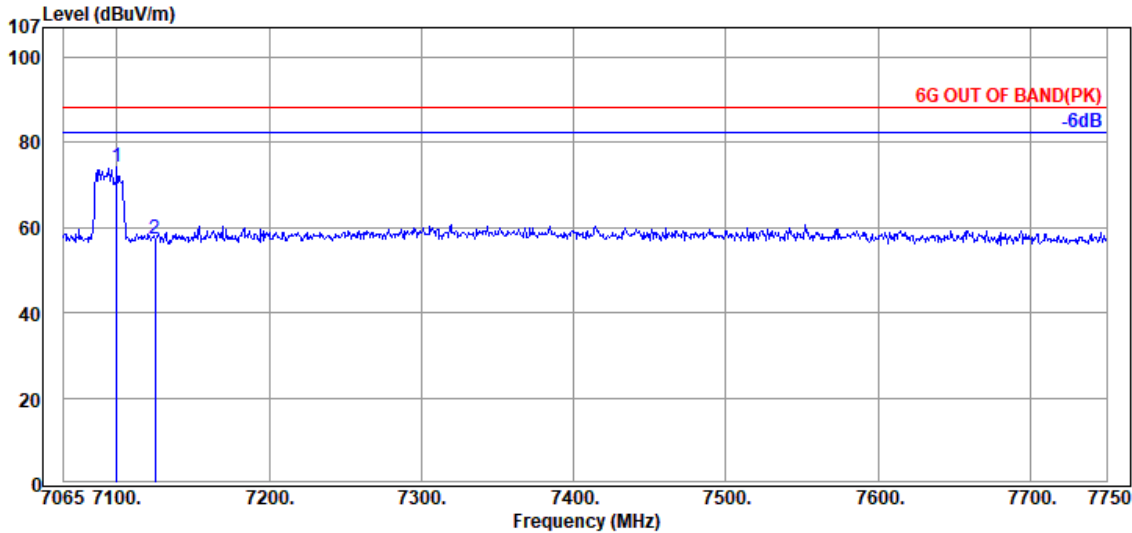

Antenna at Horizontal Polarization

Emission Frequency (MHz)	Antenna Factor (dB/m)	Cable Loss (dB)	Preamplifier Gain (dB)	Read Level (dBμV)	Emission Level (dBμV/m)	Limits (dBμV/m)	Margin (dB)	Detector
@ 7099.935	35.80	9.80	39.49	68.04	74.15	---	---	Peak
7125.000	35.87	9.82	39.50	51.14	57.33	88.20	30.87	Peak

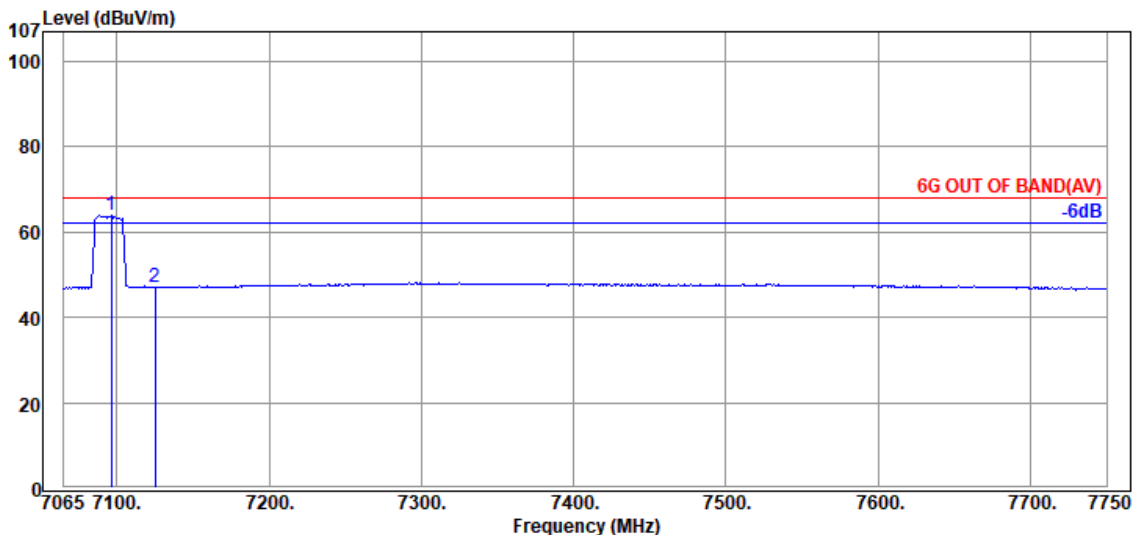

Antenna at Horizontal Polarization

Emission Frequency (MHz)	Antenna Factor (dB/m)	Cable Loss (dB)	Preamplifier Gain (dB)	Read Level (dBμV)	Emission Level (dBμV/m)	Limits (dBμV/m)	Margin (dB)	Detector
@ 7096.510	35.80	9.80	39.49	58.04	64.15	---	---	Average
7125.000	35.87	9.82	39.50	40.71	46.90	68.20	21.30	Average

Remark: The "@" means fundamental frequency, it is ignored in this section.

Tones	242T	RU Index	62
Mode	802.11ax-HE40	U-NII Band	8
		Frequency	TX 7085MHz

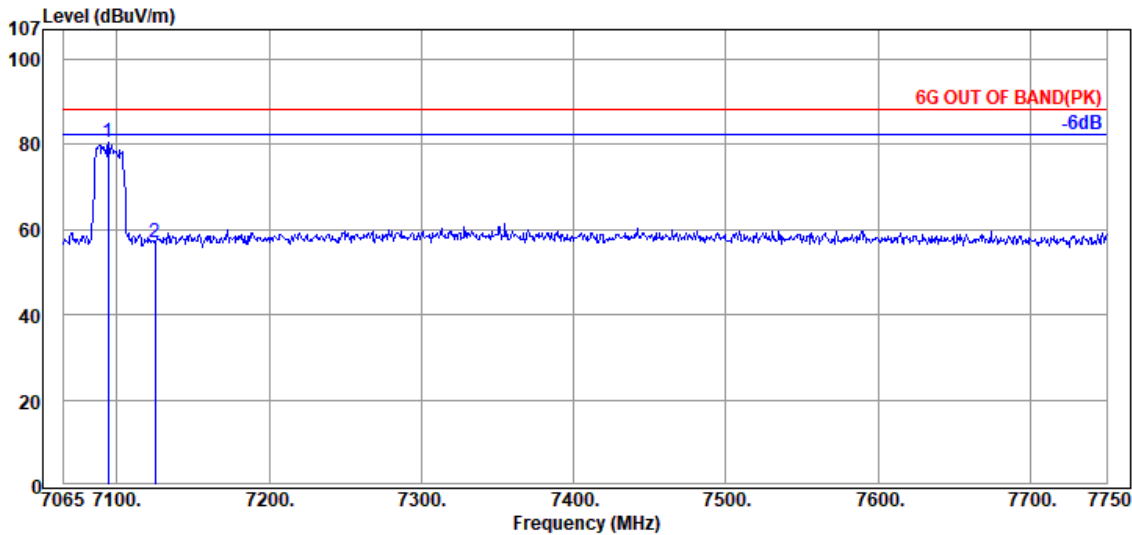

Antenna at Vertical Polarization

Emission Frequency (MHz)	Antenna Factor (dB/m)	Cable Loss (dB)	Preamplifier Gain (dB)	Read Level (dBμV)	Emission Level (dBμV/m)	Limits (dBμV/m)	Margin (dB)	Detector
@ 7094.455	35.80	9.80	39.49	74.40	80.51	---	---	Peak
7125.000	35.87	9.82	39.50	50.68	56.87	88.20	31.33	Peak

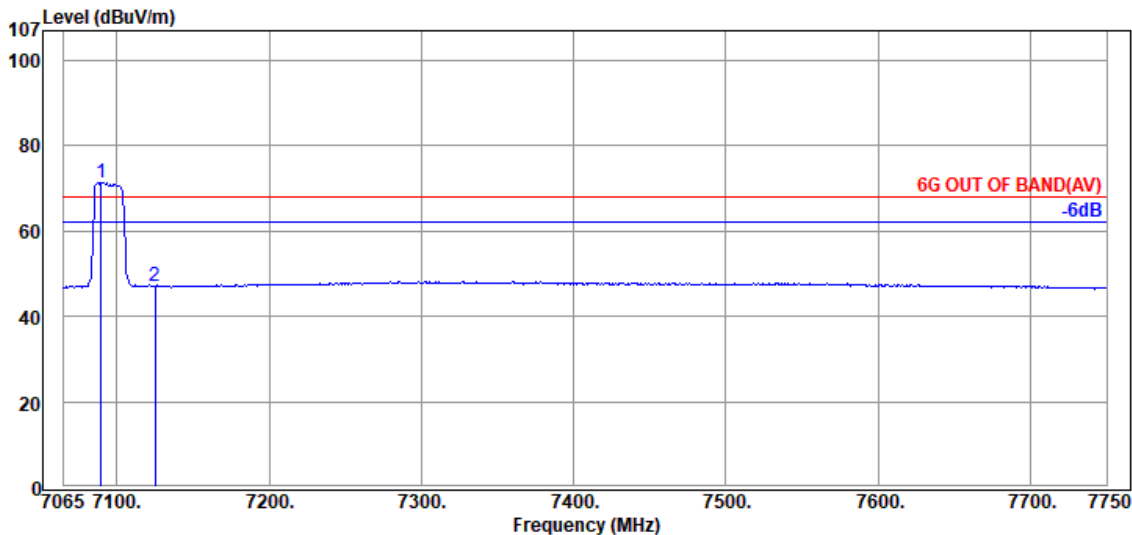

Antenna at Vertical Polarization

Emission Frequency (MHz)	Antenna Factor (dB/m)	Cable Loss (dB)	Preamplifier Gain (dB)	Read Level (dBμV)	Emission Level (dBμV/m)	Limits (dBμV/m)	Margin (dB)	Detector
@ 7089.660	35.80	9.80	39.49	65.31	71.42	---	---	Average
7125.000	35.87	9.82	39.50	40.85	47.04	68.20	21.16	Average

Remark: The “@” means fundamental frequency, it is ignored in this section.

Tones	242T	RU Index	61
Mode	802.11ax-HE160	U-NII Band	5
		Frequency	TX 6025MHz

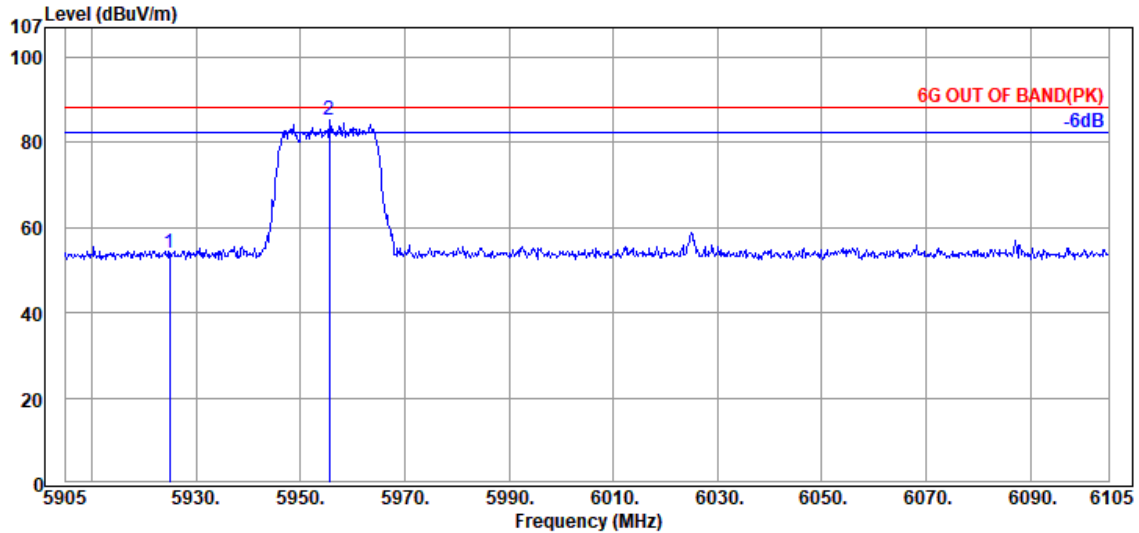

Antenna at Horizontal Polarization

Emission Frequency (MHz)	Antenna Factor (dB/m)	Cable Loss (dB)	Preamplifier Gain (dB)	Read Level (dBμV)	Emission Level (dBμV/m)	Limits (dBμV/m)	Margin (dB)	Detector
5925.000	34.23	9.30	39.35	49.86	54.04	88.20	34.16	Peak
@ 5955.600	34.30	9.30	39.35	80.88	85.13	---	---	Peak

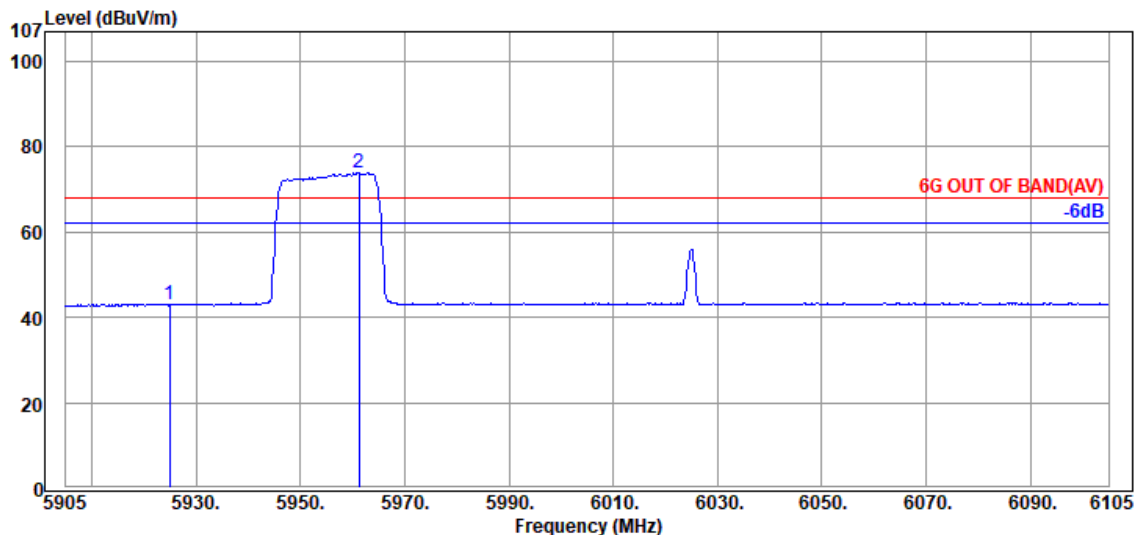

Antenna at Horizontal Polarization

Emission Frequency (MHz)	Antenna Factor (dB/m)	Cable Loss (dB)	Preamplifier Gain (dB)	Read Level (dBμV)	Emission Level (dBμV/m)	Limits (dBμV/m)	Margin (dB)	Detector
5925.000	34.23	9.30	39.35	38.87	43.05	68.20	25.15	Average
@ 5961.200	34.27	9.31	39.35	69.63	73.86	---	---	Average

Remark: The “@” means fundamental frequency, it is ignored in this section.

Tones	242T	RU Index	61
Mode	802.11ax-HE160	U-NII Band	5
		Frequency	TX 6025MHz

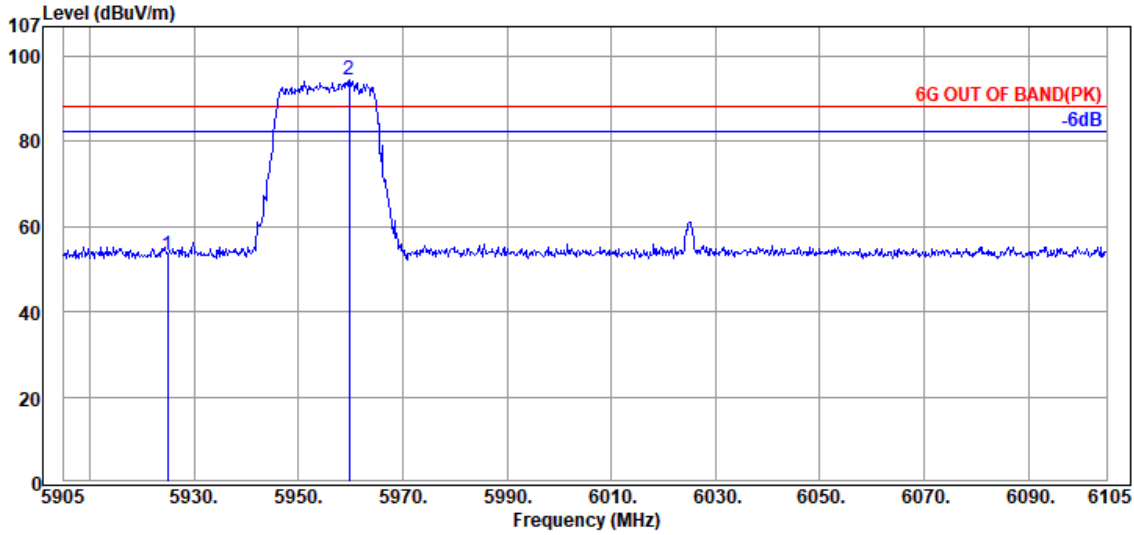

Antenna at Vertical Polarization

Emission Frequency (MHz)	Antenna Factor (dB/m)	Cable Loss (dB)	Preamp Gain (dB)	Read Level (dBμV)	Emission Level (dBμV/m)	Limits (dBμV/m)	Margin (dB)	Detector
5925.000	34.23	9.30	39.35	49.22	53.40	88.20	34.80	Peak
@ 5959.800	34.27	9.31	39.35	90.11	94.34	---	---	Peak

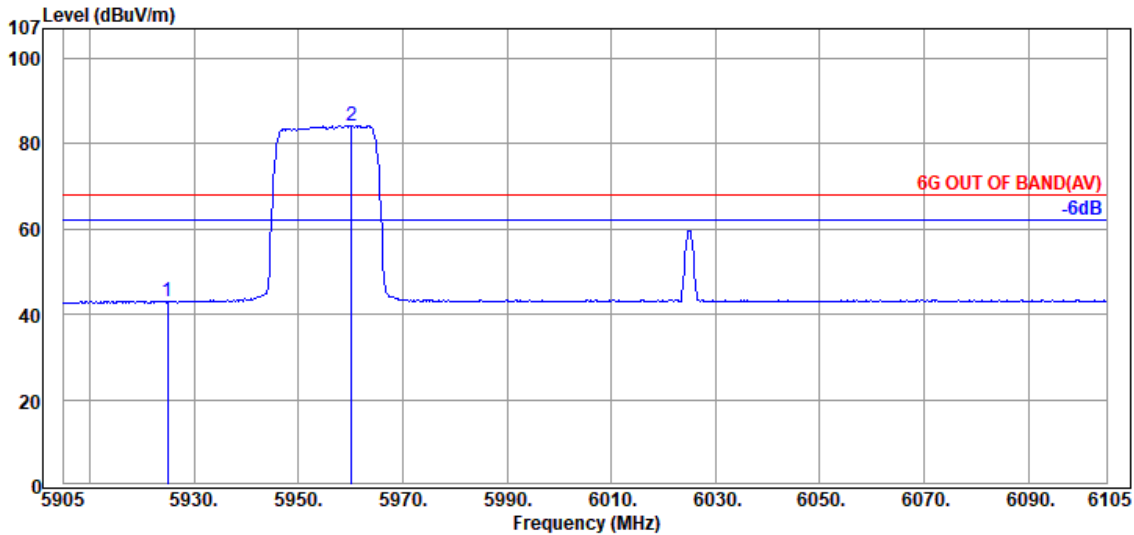

Antenna at Vertical Polarization

Emission Frequency (MHz)	Antenna Factor (dB/m)	Cable Loss (dB)	Preamp Gain (dB)	Read Level (dBμV)	Emission Level (dBμV/m)	Limits (dBμV/m)	Margin (dB)	Detector
5925.000	34.23	9.30	39.35	38.67	42.85	68.20	25.35	Average
@ 5960.200	34.27	9.31	39.35	80.05	84.28	---	---	Average

Remark: The “@” means fundamental frequency, it is ignored in this section.

Tones	484T	RU Index	65
Mode	802.11ax-HE160	U-NII Band	5
		Frequency	TX 6025MHz

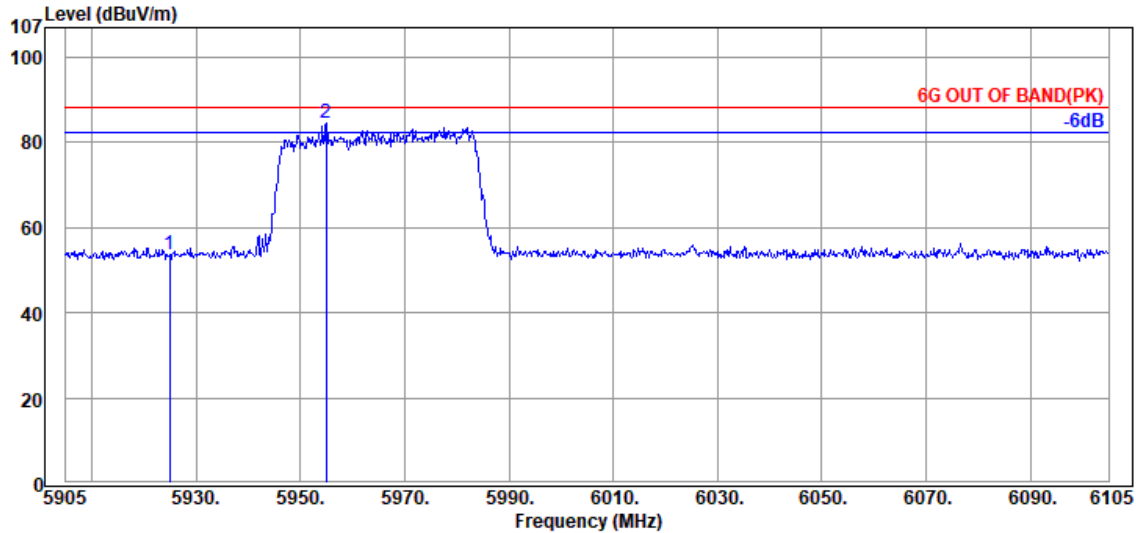

Antenna at Horizontal Polarization

Emission Frequency (MHz)	Antenna Factor (dB/m)	Cable Loss (dB)	Preamp Gain (dB)	Read Level (dBμV)	Emission Level (dBμV/m)	Limits (dBμV/m)	Margin (dB)	Detector
5925.000	34.23	9.30	39.35	49.47	53.65	88.20	34.55	Peak
@ 5955.000	34.30	9.30	39.35	80.27	84.52	---	---	Peak

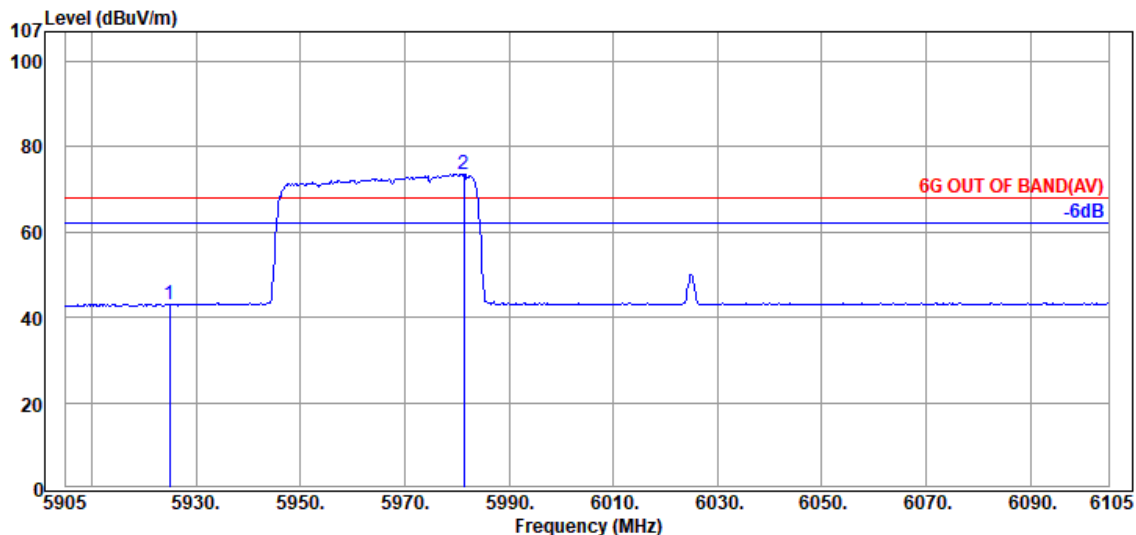

Antenna at Horizontal Polarization

Emission Frequency (MHz)	Antenna Factor (dB/m)	Cable Loss (dB)	Preamp Gain (dB)	Read Level (dBμV)	Emission Level (dBμV/m)	Limits (dBμV/m)	Margin (dB)	Detector
5925.000	34.23	9.30	39.35	38.84	43.02	68.20	25.18	Average
@ 5981.400	34.23	9.32	39.36	69.40	73.59	---	---	Average

Remark: The "@" means fundamental frequency, it is ignored in this section.

Tones	484T	RU Index	65
Mode	802.11ax-HE160	U-NII Band	5
		Frequency	TX 6025MHz

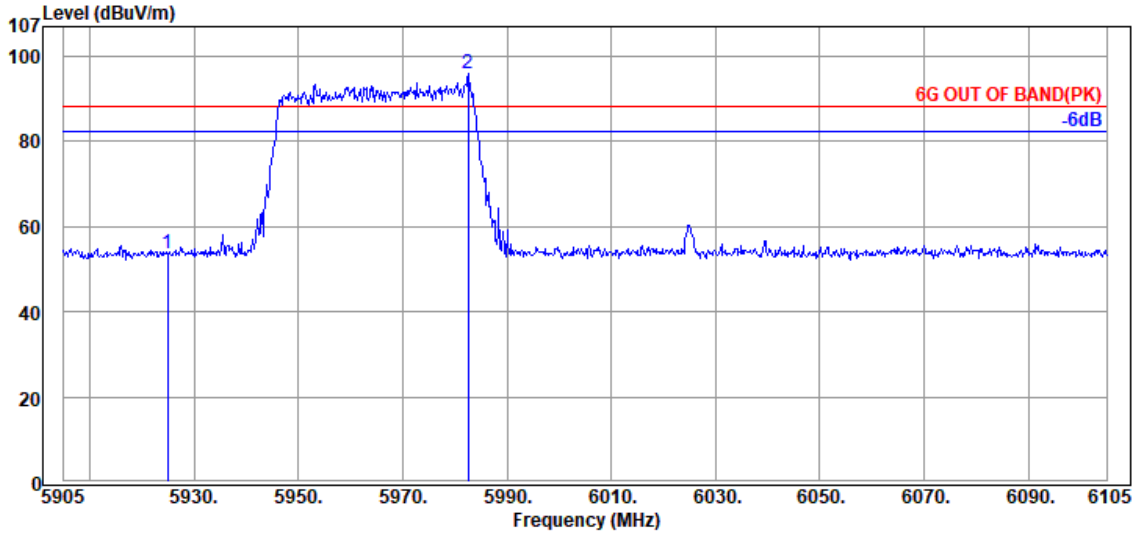

Antenna at Vertical Polarization

Emission Frequency (MHz)	Antenna Factor (dB/m)	Cable Loss (dB)	Preamp Gain (dB)	Read Level (dBμV)	Emission Level (dBμV/m)	Limits (dBμV/m)	Margin (dB)	Detector
5925.000	34.23	9.30	39.35	49.48	53.66	88.20	34.54	Peak
@ 5982.600	34.23	9.32	39.36	91.93	96.12	---	---	Peak

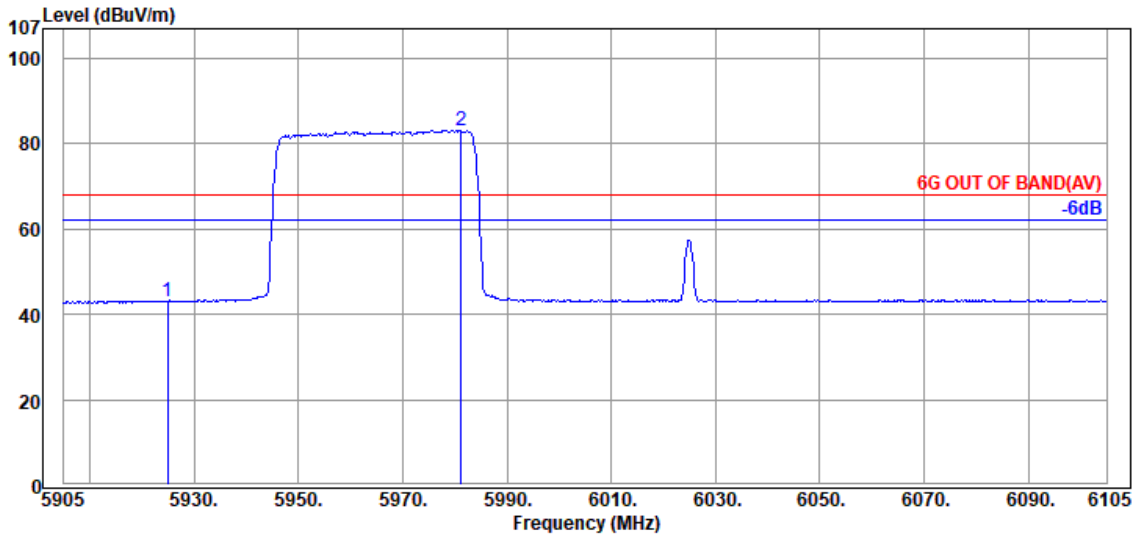

Antenna at Vertical Polarization

Emission Frequency (MHz)	Antenna Factor (dB/m)	Cable Loss (dB)	Preamp Gain (dB)	Read Level (dBμV)	Emission Level (dBμV/m)	Limits (dBμV/m)	Margin (dB)	Detector
5925.000	34.23	9.30	39.35	38.84	43.02	68.20	25.18	Average
@ 5981.200	34.23	9.32	39.36	78.86	83.05	---	---	Average

Remark: The “@” means fundamental frequency, it is ignored in this section.

Tones	484T	RU Index	65
Mode	802.11ax-HE40	U-NII Band	8
		Frequency	TX 7085MHz

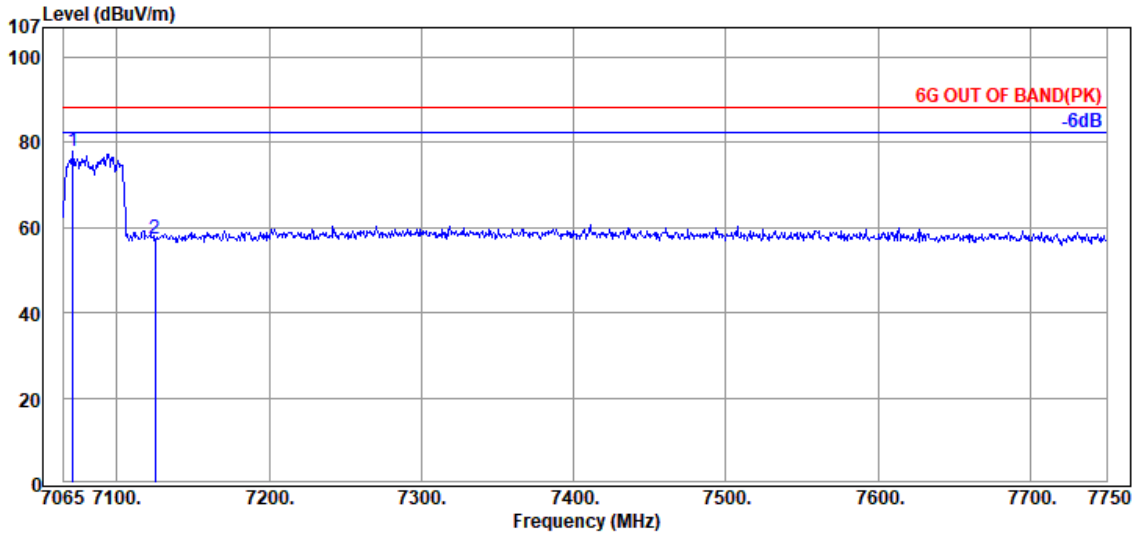

Antenna at Horizontal Polarization

Emission Frequency (MHz)	Antenna Factor (dB/m)	Cable Loss (dB)	Preamp Gain (dB)	Read Level (dBμV)	Emission Level (dBμV/m)	Limits (dBμV/m)	Margin (dB)	Detector
@ 7071.165	35.70	9.78	39.49	72.14	78.13	---	---	Peak
7125.000	35.87	9.82	39.50	51.18	57.37	88.20	30.83	Peak

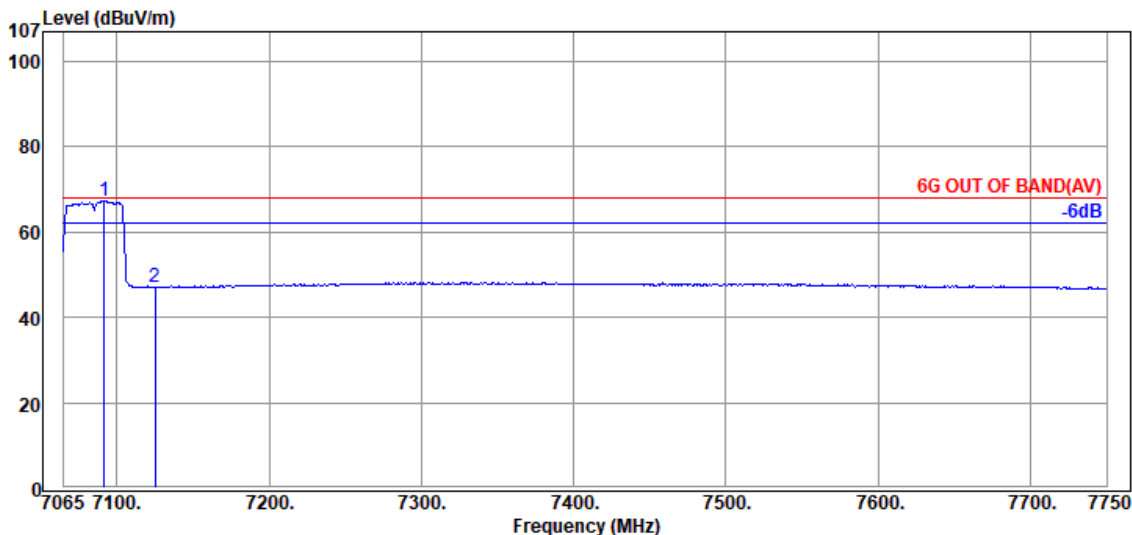

Antenna at Horizontal Polarization

Emission Frequency (MHz)	Antenna Factor (dB/m)	Cable Loss (dB)	Preamp Gain (dB)	Read Level (dBμV)	Emission Level (dBμV/m)	Limits (dBμV/m)	Margin (dB)	Detector
@ 7091.715	35.80	9.80	39.49	61.19	67.30	---	---	Average
7125.000	35.87	9.82	39.50	40.94	47.13	68.20	21.07	Average

Remark: The "@" means fundamental frequency, it is ignored in this section.

Tones	484T	RU Index	65
Mode	802.11ax-HE40	U-NII Band	8
		Frequency	TX 7085MHz

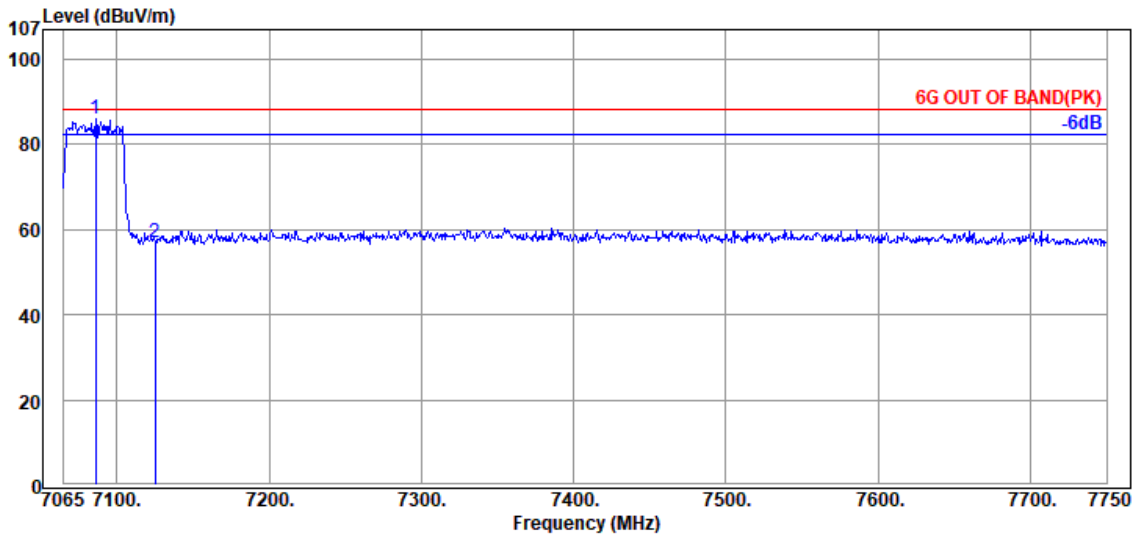

Antenna at Vertical Polarization

Emission Frequency (MHz)	Antenna Factor (dB/m)	Cable Loss (dB)	Preamplifier Gain (dB)	Read Level (dBμV)	Emission Level (dBμV/m)	Limits (dBμV/m)	Margin (dB)	Detector
@ 7086.235	35.70	9.78	39.49	79.99	85.98	---	---	Peak
7125.000	35.87	9.82	39.50	50.76	56.95	88.20	31.25	Peak

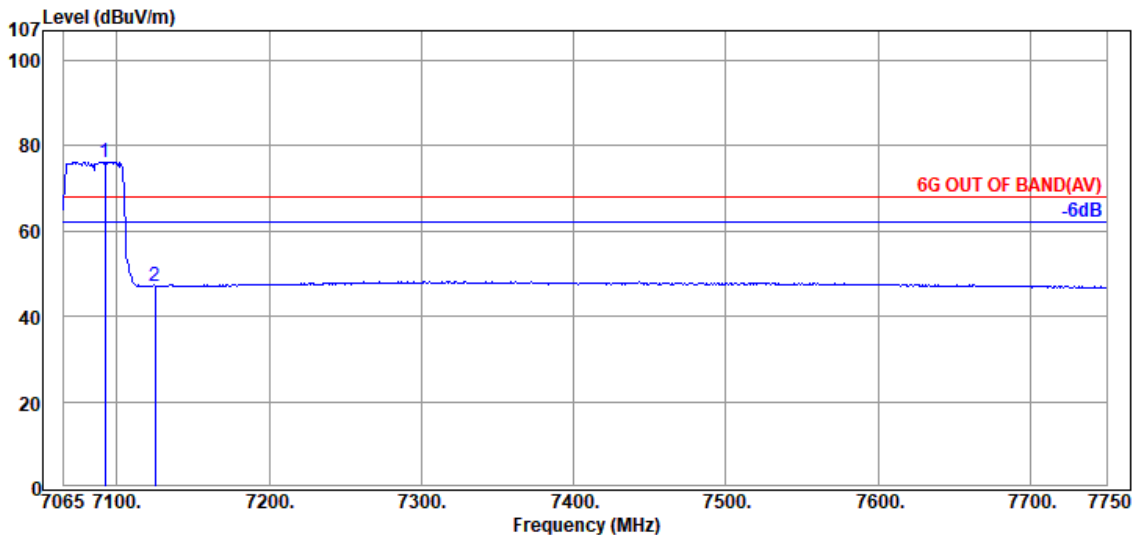

Antenna at Vertical Polarization

Emission Frequency (MHz)	Antenna Factor (dB/m)	Cable Loss (dB)	Preamplifier Gain (dB)	Read Level (dBμV)	Emission Level (dBμV/m)	Limits (dBμV/m)	Margin (dB)	Detector
@ 7092.400	35.80	9.80	39.49	70.15	76.26	---	---	Average
7125.000	35.87	9.82	39.50	40.98	47.17	68.20	21.03	Average

Remark: The “@” means fundamental frequency, it is ignored in this section.

Tones	484T	RU Index	S66
Mode	802.11ax-HE160	U-NII Band	8
		Frequency	TX 6985MHz

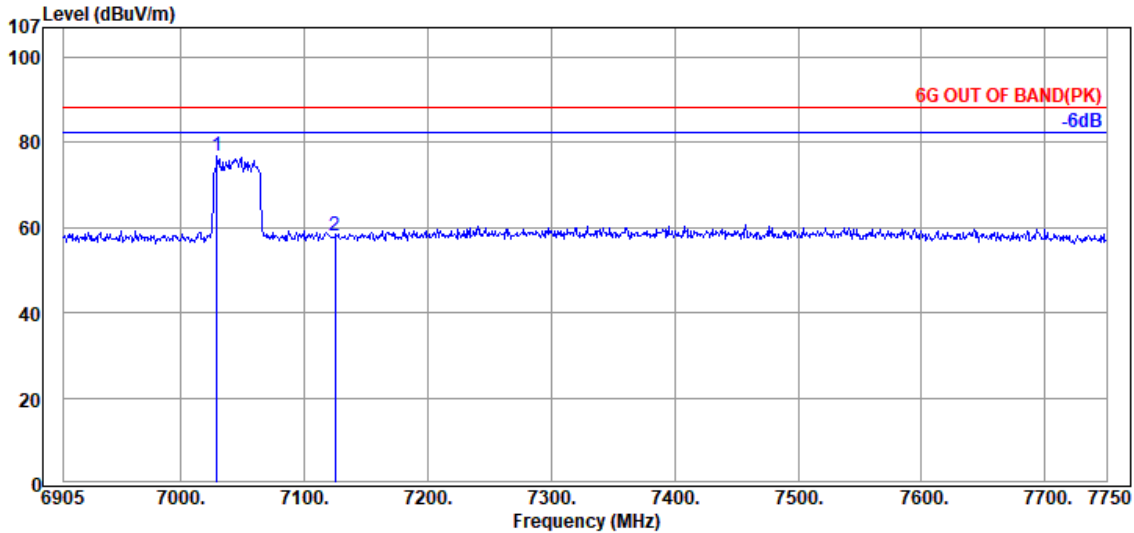

Antenna at Horizontal Polarization

Emission Frequency (MHz)	Antenna Factor (dB/m)	Cable Loss (dB)	Preamp Gain (dB)	Read Level (dBμV)	Emission Level (dBμV/m)	Limits (dBμV/m)	Margin (dB)	Detector
@ 7029.215	35.57	9.75	39.48	70.97	76.81	---	---	Peak
7125.000	35.87	9.82	39.50	51.77	57.96	88.20	30.24	Peak

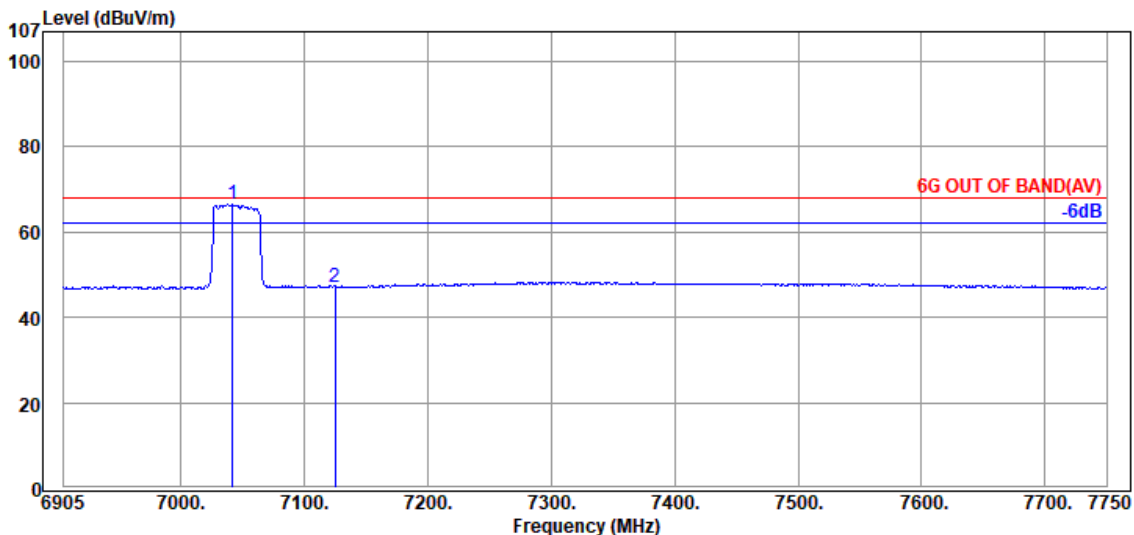

Antenna at Horizontal Polarization

Emission Frequency (MHz)	Antenna Factor (dB/m)	Cable Loss (dB)	Preamp Gain (dB)	Read Level (dBμV)	Emission Level (dBμV/m)	Limits (dBμV/m)	Margin (dB)	Detector
@ 7041.890	35.57	9.75	39.48	60.78	66.62	---	---	Average
7125.000	35.87	9.82	39.50	40.91	47.10	68.20	21.10	Average

Remark: The "@" means fundamental frequency, it is ignored in this section.

Tones	484T	RU Index	S66
Mode	802.11ax-HE160	U-NII Band	8
		Frequency	TX 6985MHz

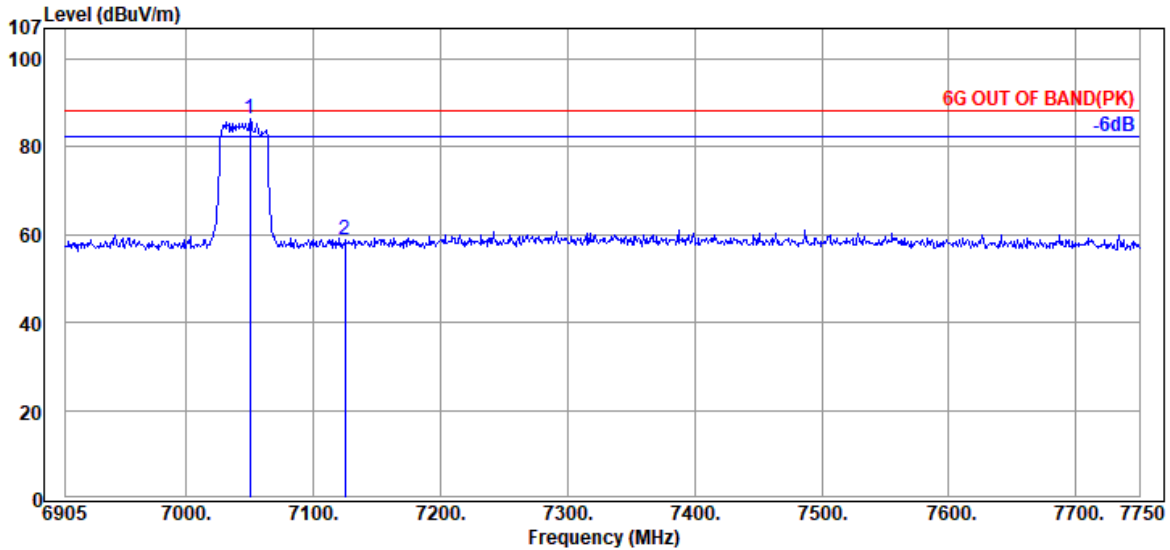

Antenna at Vertical Polarization

Emission Frequency (MHz)	Antenna Factor (dB/m)	Cable Loss (dB)	Preamplifier Gain (dB)	Read Level (dBμV)	Emission Level (dBμV/m)	Limits (dBμV/m)	Margin (dB)	Detector
@ 7050.340	35.60	9.77	39.48	80.35	86.24	---	---	Peak
7125.000	35.87	9.82	39.50	52.48	58.67	88.20	29.53	Peak

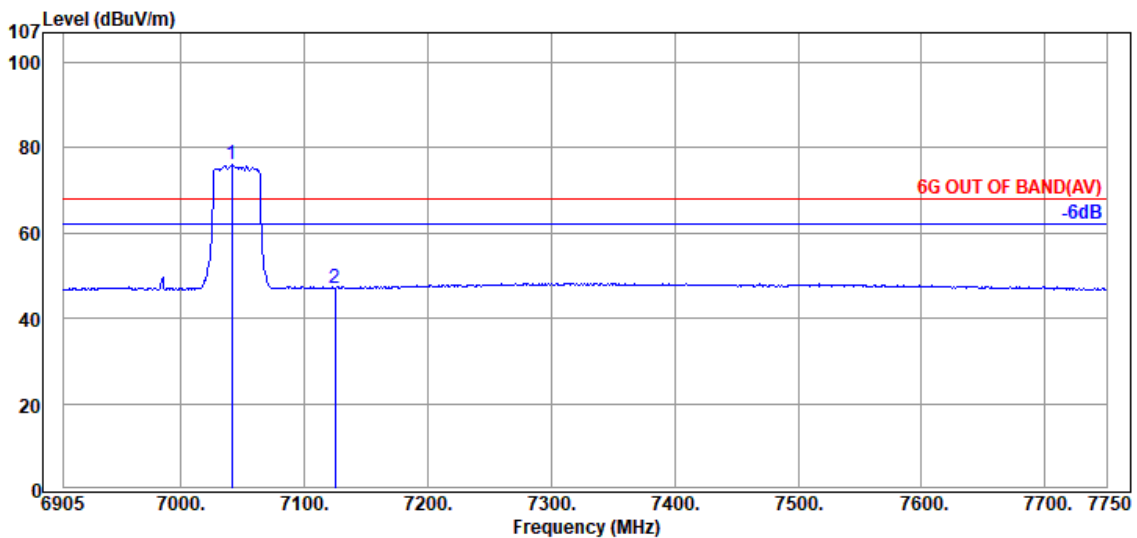

Antenna at Vertical Polarization

Emission Frequency (MHz)	Antenna Factor (dB/m)	Cable Loss (dB)	Preamplifier Gain (dB)	Read Level (dBμV)	Emission Level (dBμV/m)	Limits (dBμV/m)	Margin (dB)	Detector
@ 7041.045	35.57	9.75	39.48	70.09	75.93	---	---	Average
7125.000	35.87	9.82	39.50	41.02	47.21	68.20	20.99	Average

Remark: The “@” means fundamental frequency, it is ignored in this section.

Tones	996T	RU Index	67
Mode	802.11ax-HE160	U-NII Band	5
		Frequency	TX 6025MHz

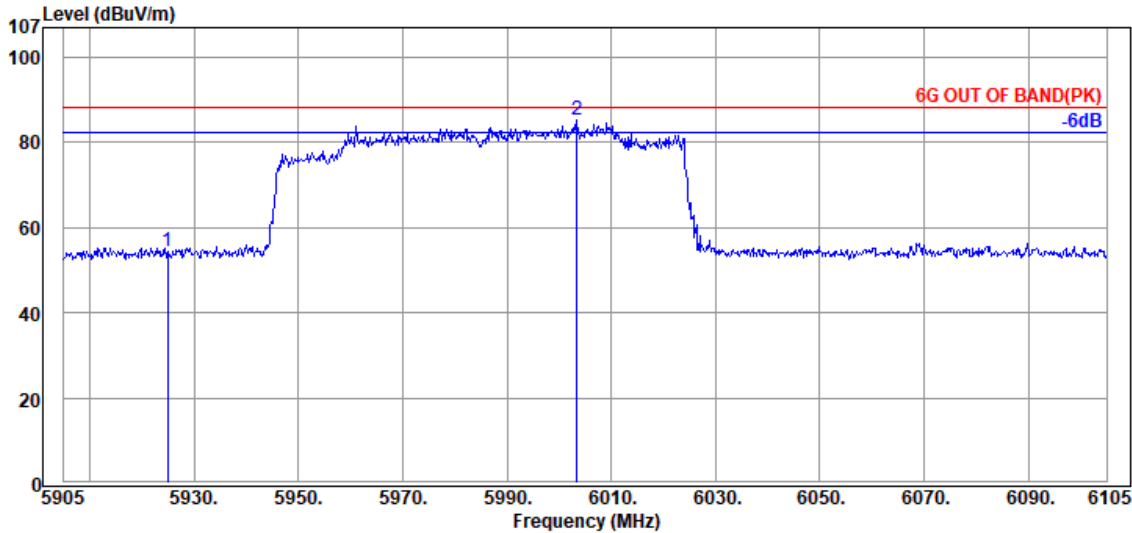

Antenna at Horizontal Polarization

Emission Frequency (MHz)	Antenna Factor (dB/m)	Cable Loss (dB)	Preamp Gain (dB)	Read Level (dBμV)	Emission Level (dBμV/m)	Limits (dBμV/m)	Margin (dB)	Detector
5925.000	34.23	9.30	39.35	50.28	54.46	88.20	33.74	Peak
@ 6003.400	34.20	9.33	39.36	81.15	85.32	---	---	Peak

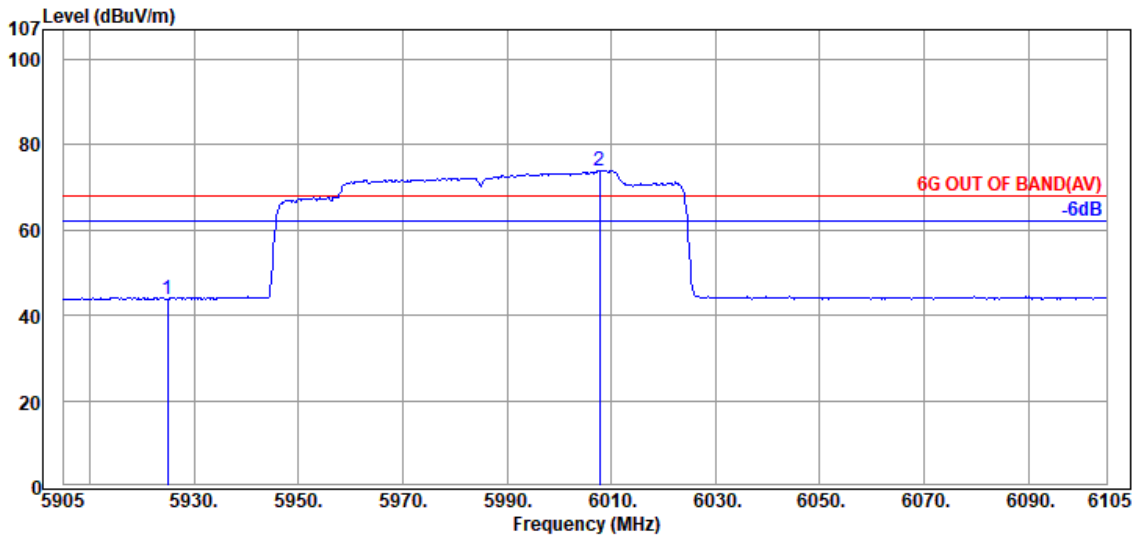

Antenna at Horizontal Polarization

Emission Frequency (MHz)	Antenna Factor (dB/m)	Cable Loss (dB)	Preamp Gain (dB)	Read Level (dBμV)	Emission Level (dBμV/m)	Limits (dBμV/m)	Margin (dB)	Detector
5925.000	34.23	9.30	39.35	39.67	43.85	68.20	24.35	Average
@ 6007.800	34.20	9.33	39.36	69.80	73.97	---	---	Average

Remark: The “@” means fundamental frequency, it is ignored in this section.

Tones	996T	RU Index	67
Mode	802.11ax-HE160	U-NII Band	5
		Frequency	TX 6025MHz

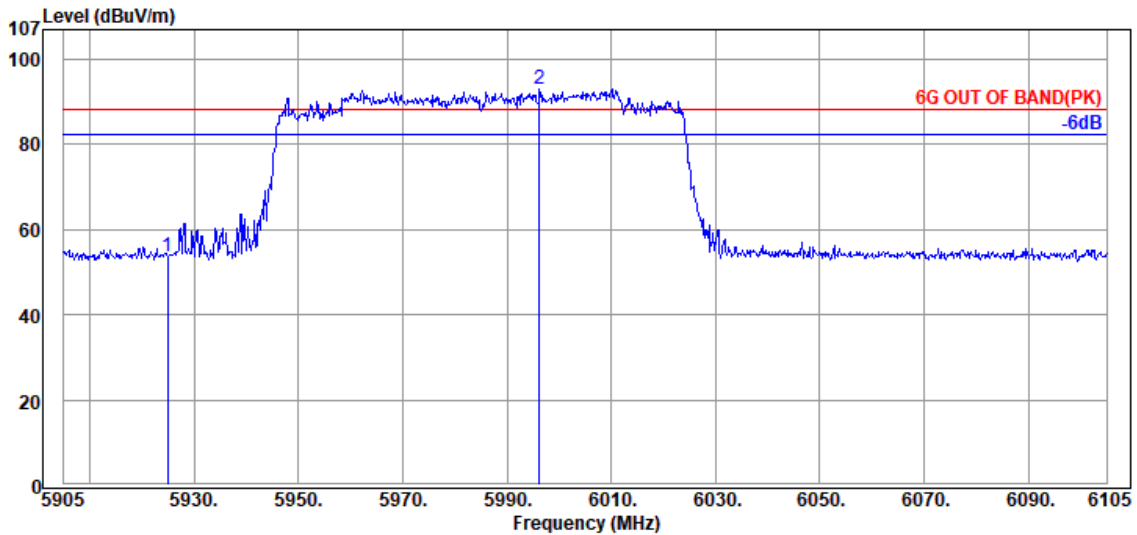

Antenna at Vertical Polarization

Emission Frequency (MHz)	Antenna Factor (dB/m)	Cable Loss (dB)	Preamp Gain (dB)	Read Level (dBμV)	Emission Level (dBμV/m)	Limits (dBμV/m)	Margin (dB)	Detector
5925.000	34.23	9.30	39.35	49.34	53.52	88.20	34.68	Peak
@ 5996.200	34.20	9.33	39.36	88.97	93.14	---	---	Peak

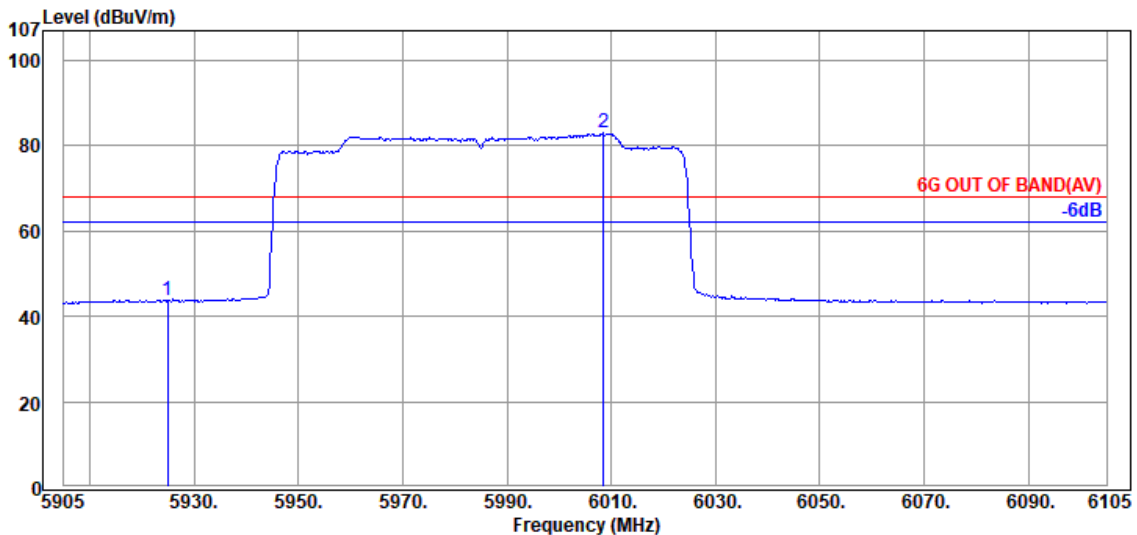

Antenna at Vertical Polarization

Emission Frequency (MHz)	Antenna Factor (dB/m)	Cable Loss (dB)	Preamp Gain (dB)	Read Level (dBμV)	Emission Level (dBμV/m)	Limits (dBμV/m)	Margin (dB)	Detector
5925.000	34.23	9.30	39.35	39.41	43.59	68.20	24.61	Average
@ 6008.600	34.20	9.33	39.36	78.76	82.93	---	---	Average

Remark: The “@” means fundamental frequency, it is ignored in this section.

Tones	996T	RU Index	67
Mode	802.11ax-HE80	U-NII Band	8
		Frequency	TX 7025MHz

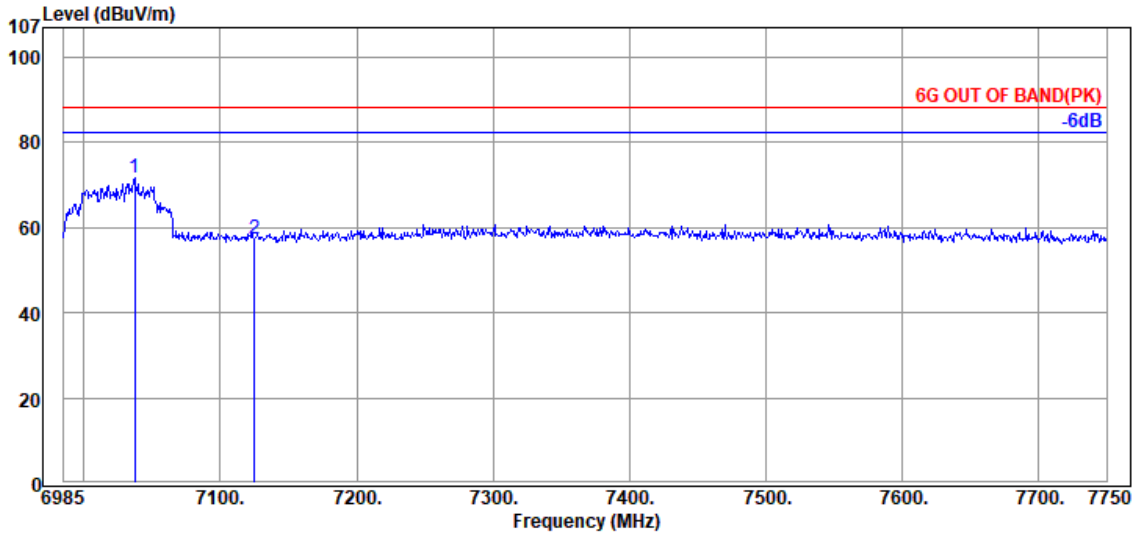

Antenna at Horizontal Polarization

Emission Frequency (MHz)	Antenna Factor (dB/m)	Cable Loss (dB)	Preamp Gain (dB)	Read Level (dBμV)	Emission Level (dBμV/m)	Limits (dBμV/m)	Margin (dB)	Detector
@ 7037.020	35.57	9.75	39.48	65.83	71.67	---	---	Peak
7125.000	35.87	9.82	39.50	51.21	57.40	88.20	30.80	Peak

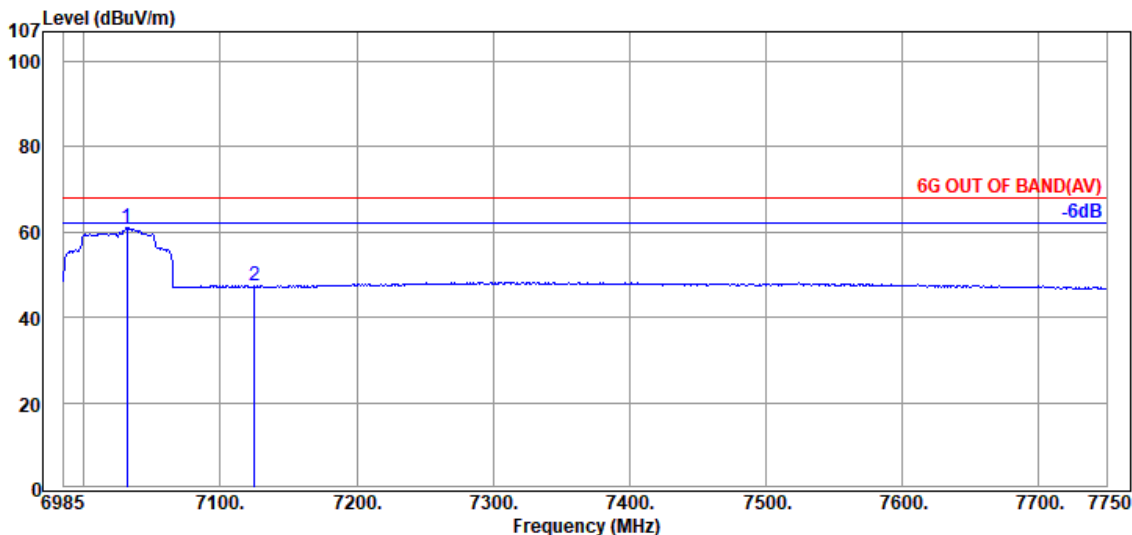

Antenna at Horizontal Polarization

Emission Frequency (MHz)	Antenna Factor (dB/m)	Cable Loss (dB)	Preamp Gain (dB)	Read Level (dBμV)	Emission Level (dBμV/m)	Limits (dBμV/m)	Margin (dB)	Detector
@ 7031.665	35.57	9.75	39.48	55.13	60.97	---	---	Average
7125.000	35.87	9.82	39.50	41.08	47.27	68.20	20.93	Average

Remark: The “@” means fundamental frequency, it is ignored in this section.

Tones	996T	RU Index	67
Mode	802.11ax-HE80	U-NII Band	8
		Frequency	TX 7025MHz

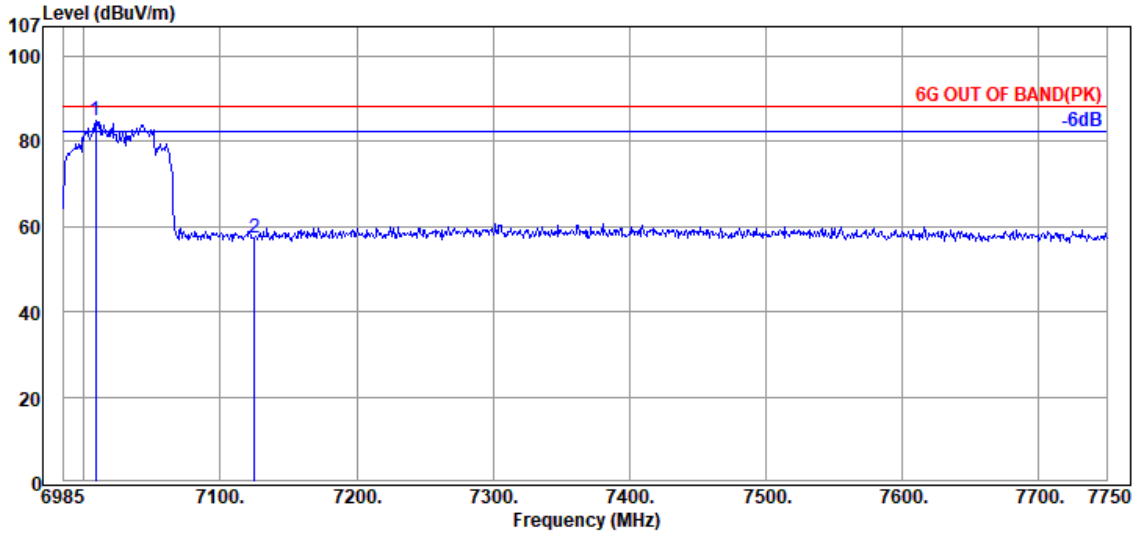

Antenna at Vertical Polarization

Emission Frequency (MHz)	Antenna Factor (dB/m)	Cable Loss (dB)	Preamplifier Gain (dB)	Read Level (dBμV)	Emission Level (dBμV/m)	Limits (dBμV/m)	Margin (dB)	Detector
@ 7008.715	35.53	9.73	39.47	79.04	84.83	---	---	Peak
7125.000	35.87	9.82	39.50	51.12	57.31	88.20	30.89	Peak

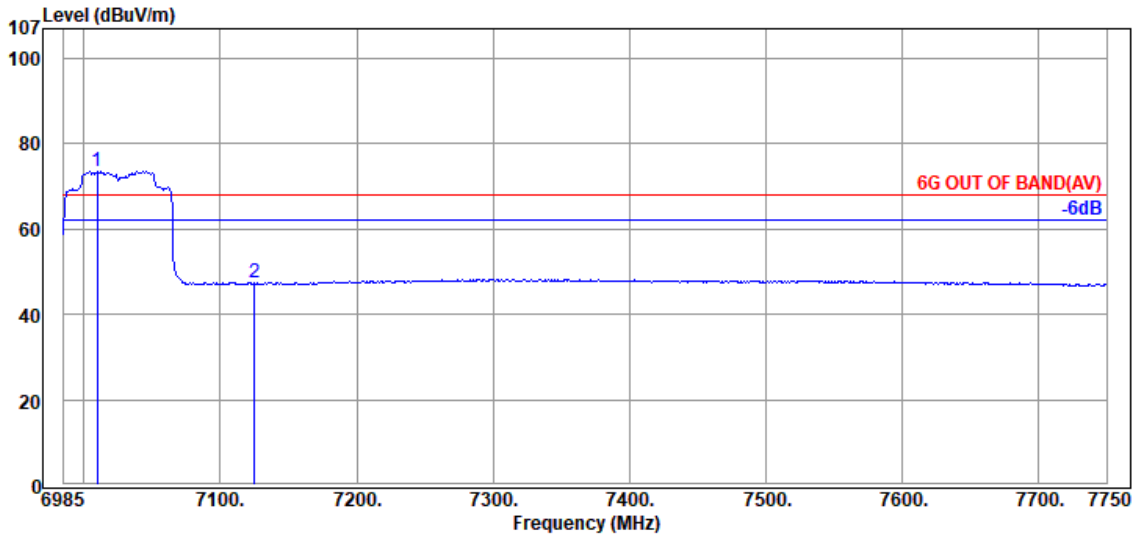

Antenna at Vertical Polarization

Emission Frequency (MHz)	Antenna Factor (dB/m)	Cable Loss (dB)	Preamplifier Gain (dB)	Read Level (dBμV)	Emission Level (dBμV/m)	Limits (dBμV/m)	Margin (dB)	Detector
@ 7009.480	35.53	9.73	39.47	67.83	73.62	---	---	Average
7125.000	35.87	9.82	39.50	41.08	47.27	68.20	20.93	Average

Remark: The “@” means fundamental frequency, it is ignored in this section.

A.2.2 Emissions outside the frequency band

The emissions (up to 40GHz) not reported for there is no emission be found.

- OFDM Modulation

Mode	802.11ax-HE20	U-NII Band	5
		Frequency	TX 6175MHz

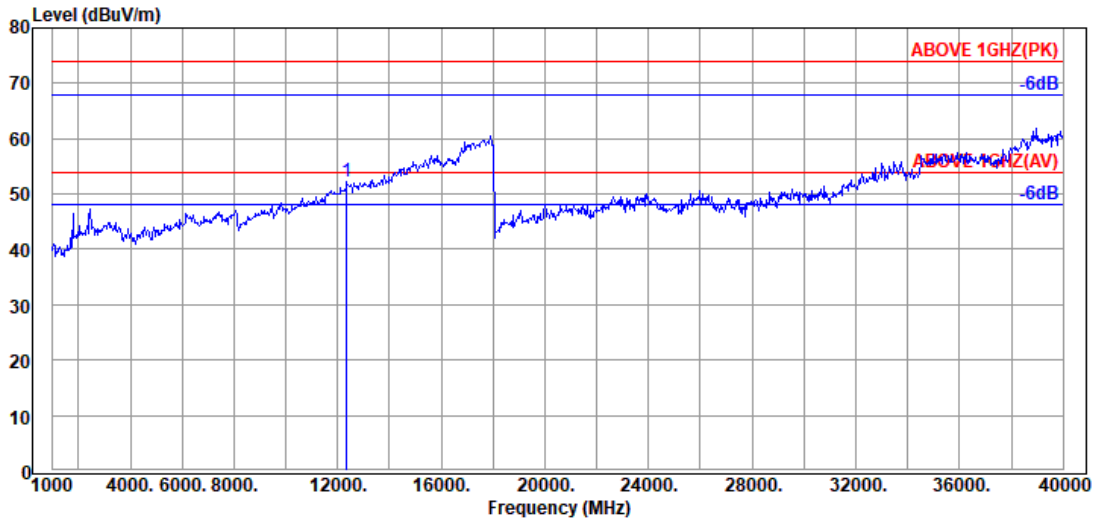

Antenna at Horizontal Polarization

Emission Frequency (MHz)	Antenna Factor (dB/m)	Cable Loss (dB)	Preamp Gain (dB)	Read Level (dBμV)	Emission Level (dBμV/m)	Limits (dBμV/m)	Margin (dB)	Detector
12350.000	38.93	16.38	34.32	31.25	52.24	54.00	1.76	Peak

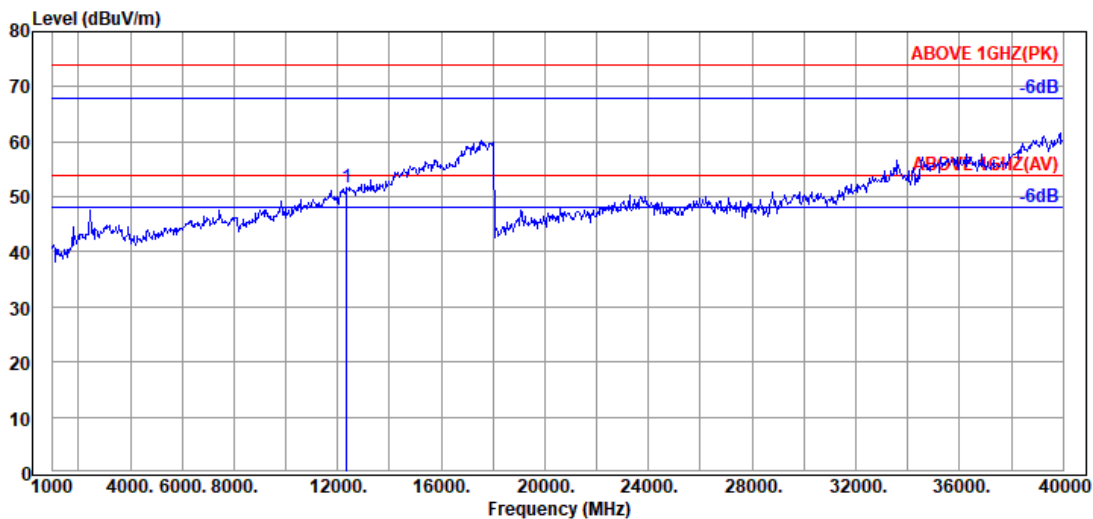

Antenna at Vertical Polarization

Emission Frequency (MHz)	Antenna Factor (dB/m)	Cable Loss (dB)	Preamp Gain (dB)	Read Level (dBμV)	Emission Level (dBμV/m)	Limits (dBμV/m)	Margin (dB)	Detector
12350.000	38.93	16.38	34.32	30.67	51.66	54.00	2.34	Peak

Mode	802.11ax-HE20	U-NII Band	6
		Frequency	TX 6435MHz

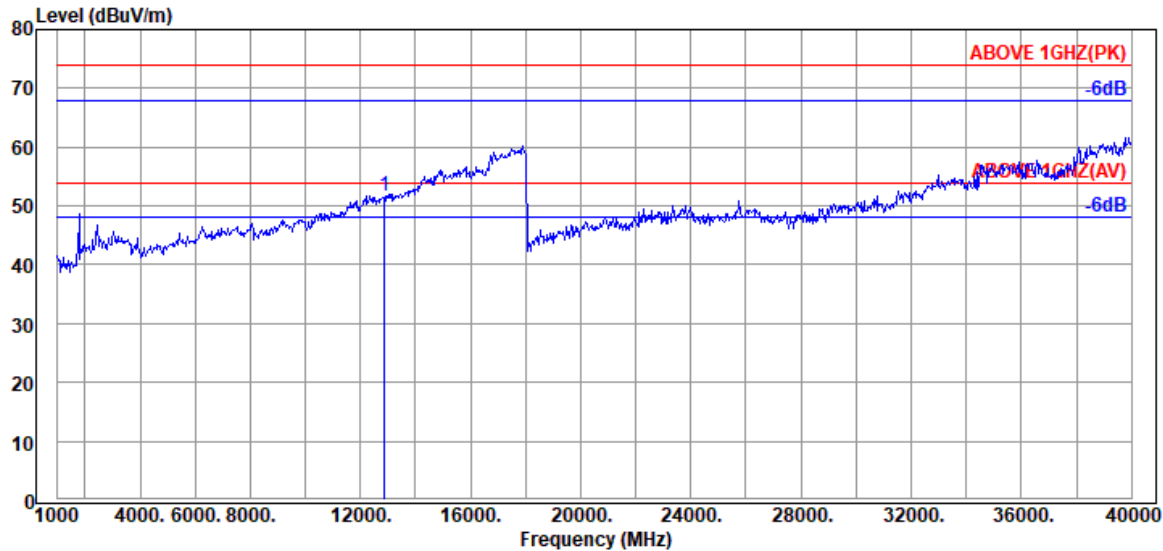

Antenna at Horizontal Polarization

Emission Frequency (MHz)	Antenna Factor (dB/m)	Cable Loss (dB)	Preamp Gain (dB)	Read Level (dBμV)	Emission Level (dBμV/m)	Limits (dBμV/m)	Margin (dB)	Detector
12870.000	39.13	16.60	33.53	29.43	51.63	54.00	2.37	Peak

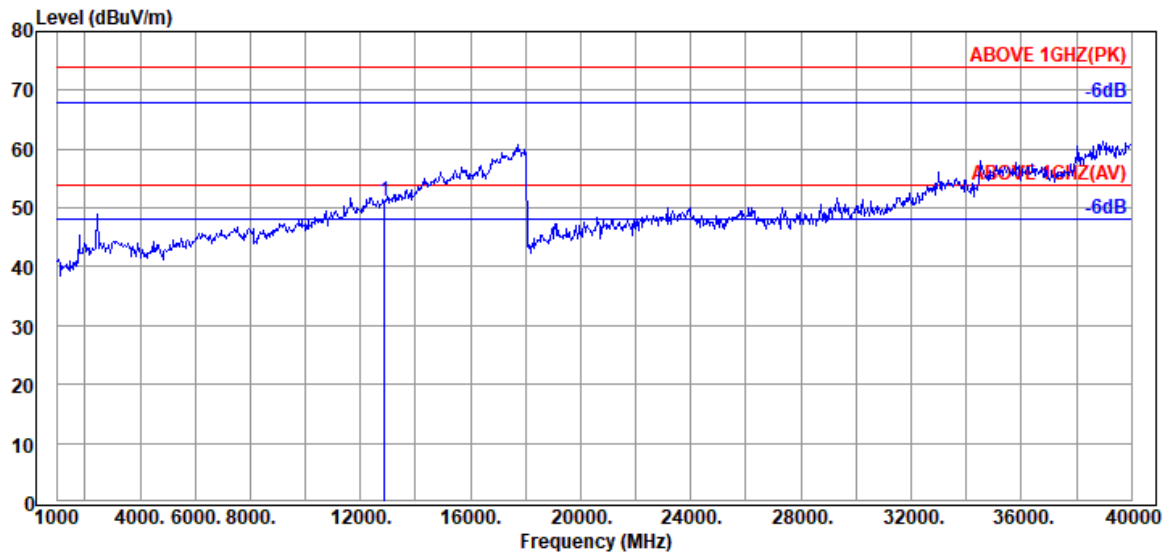

Antenna at Vertical Polarization

Emission Frequency (MHz)	Antenna Factor (dB/m)	Cable Loss (dB)	Preamp Gain (dB)	Read Level (dBμV)	Emission Level (dBμV/m)	Limits (dBμV/m)	Margin (dB)	Detector
12870.000	39.13	16.60	33.53	29.00	51.20	54.00	2.80	Peak

Mode	802.11ax-HE20	U-NII Band	7
		Frequency	TX 6855MHz

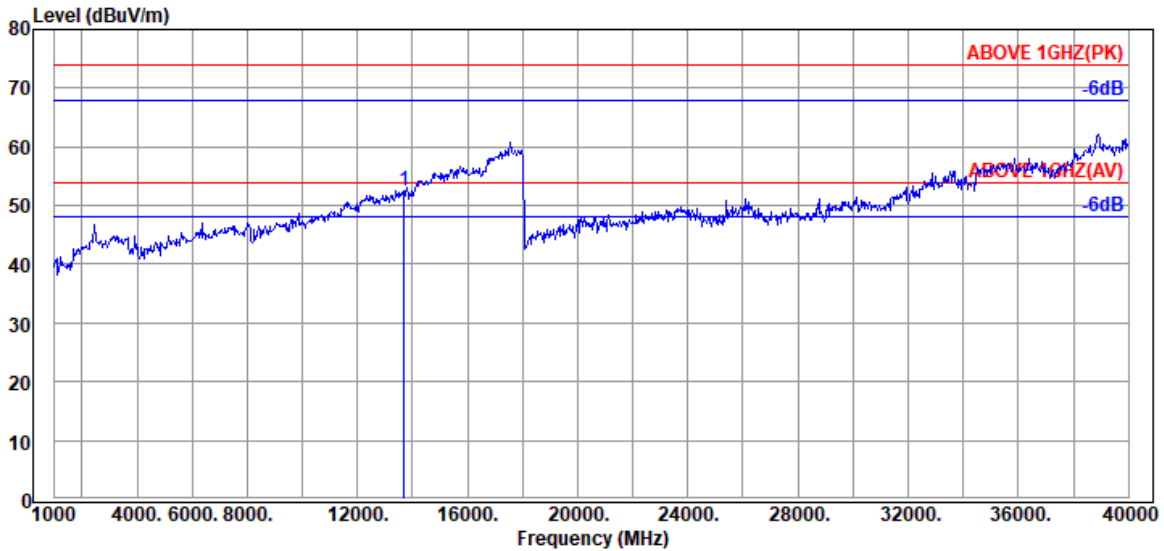

Antenna at Horizontal Polarization

Emission Frequency (MHz)	Antenna Factor (dB/m)	Cable Loss (dB)	Preamplifier Gain (dB)	Read Level (dBμV)	Emission Level (dBμV/m)	Limits (dBμV/m)	Margin (dB)	Detector
13710.000	38.80	16.81	32.93	29.93	52.61	54.00	1.39	Peak

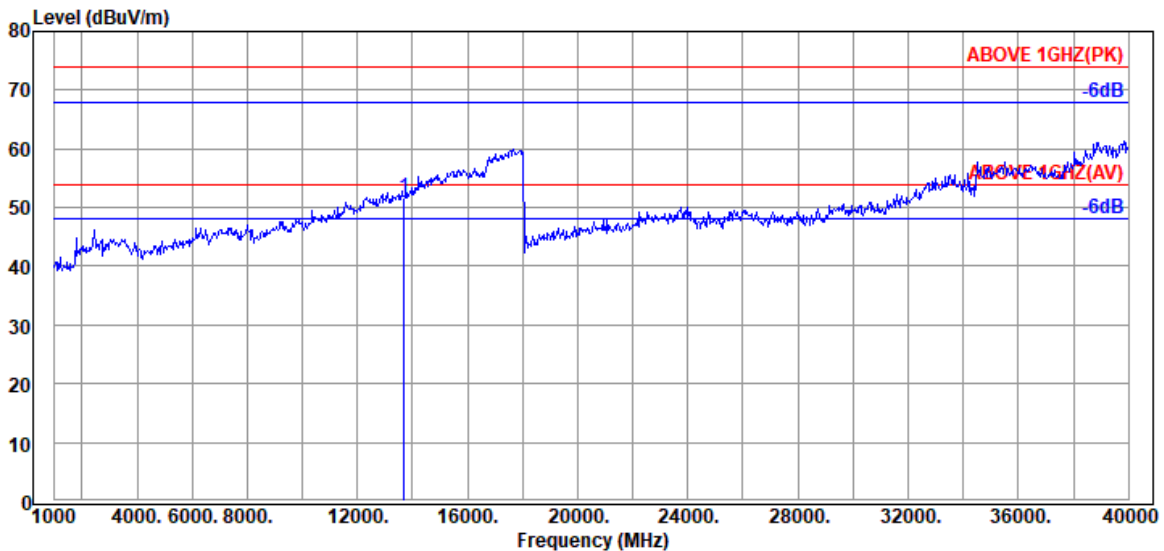

Antenna at Vertical Polarization

Emission Frequency (MHz)	Antenna Factor (dB/m)	Cable Loss (dB)	Preamplifier Gain (dB)	Read Level (dBμV)	Emission Level (dBμV/m)	Limits (dBμV/m)	Margin (dB)	Detector
13710.000	38.80	16.81	32.93	29.05	51.73	54.00	2.27	Peak

Mode	802.11ax-HE20	U-NII Band	8
		Frequency	TX 6995MHz

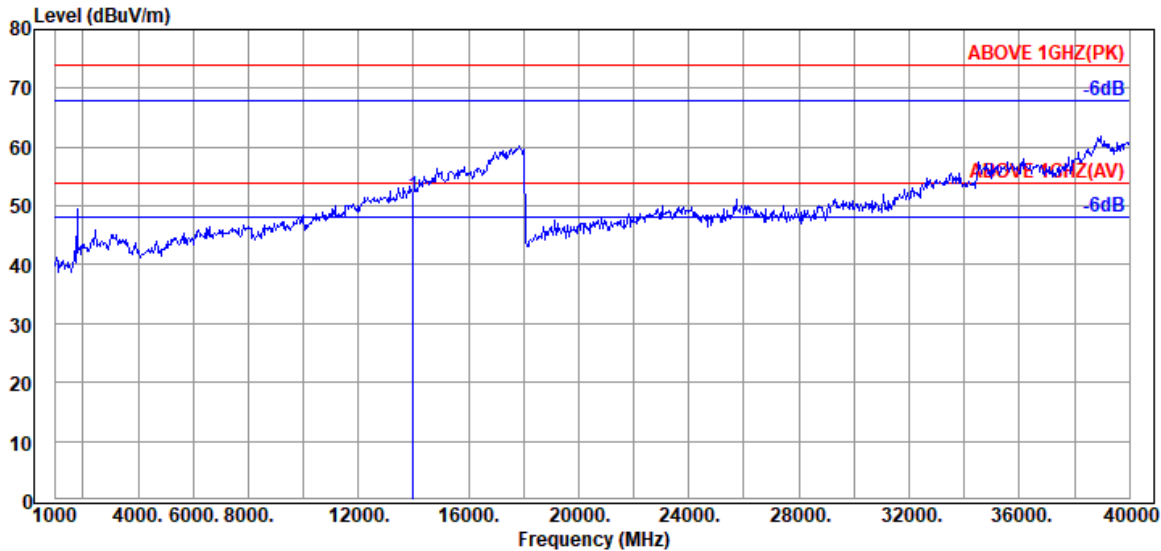

Antenna at Horizontal Polarization

Emission Frequency (MHz)	Antenna Factor (dB/m)	Cable Loss (dB)	Preamp Gain (dB)	Read Level (dBμV)	Emission Level (dBμV/m)	Limits (dBμV/m)	Margin (dB)	Detector
13990.000	39.00	16.90	32.94	28.75	51.71	54.00	2.29	Peak

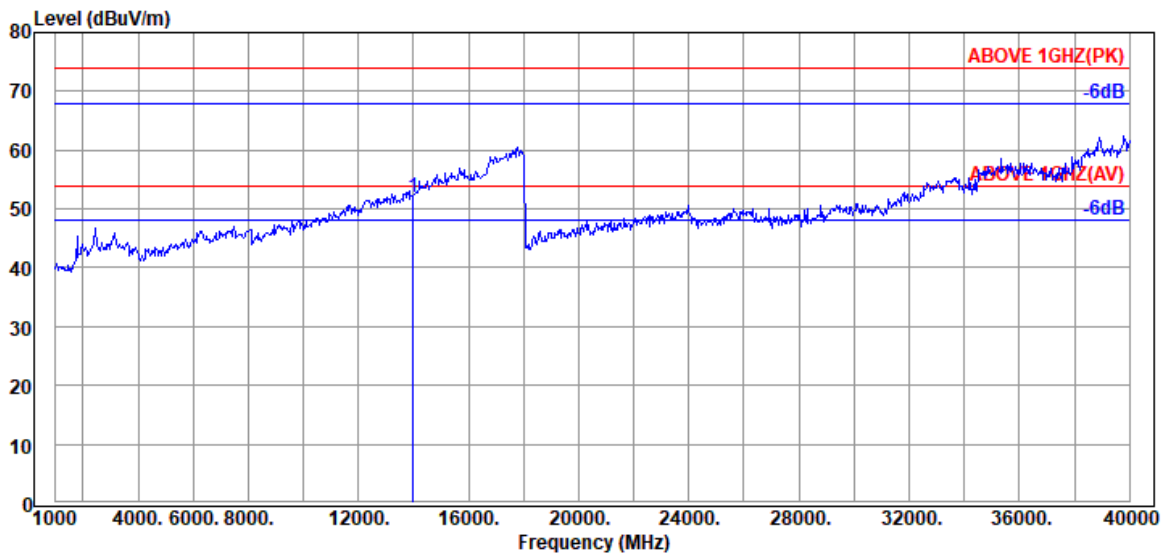

Antenna at Vertical Polarization

Emission Frequency (MHz)	Antenna Factor (dB/m)	Cable Loss (dB)	Preamp Gain (dB)	Read Level (dBμV)	Emission Level (dBμV/m)	Limits (dBμV/m)	Margin (dB)	Detector
13990.000	39.00	16.90	32.94	29.08	52.04	54.00	1.96	Peak

Mode	802.11ax-HE40	U-NII Band	5
		Frequency	TX 6405MHz

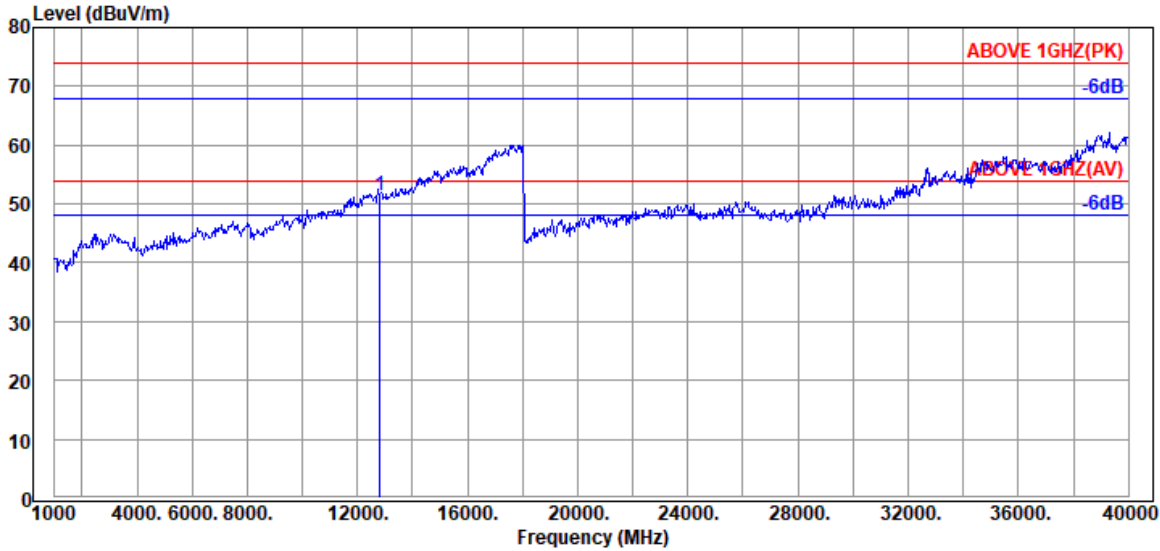

Antenna at Horizontal Polarization

Emission Frequency (MHz)	Antenna Factor (dB/m)	Cable Loss (dB)	Preamplifier Gain (dB)	Read Level (dBμV)	Emission Level (dBμV/m)	Limits (dBμV/m)	Margin (dB)	Detector
12810.000	39.17	16.57	33.68	29.21	51.27	54.00	2.73	Peak

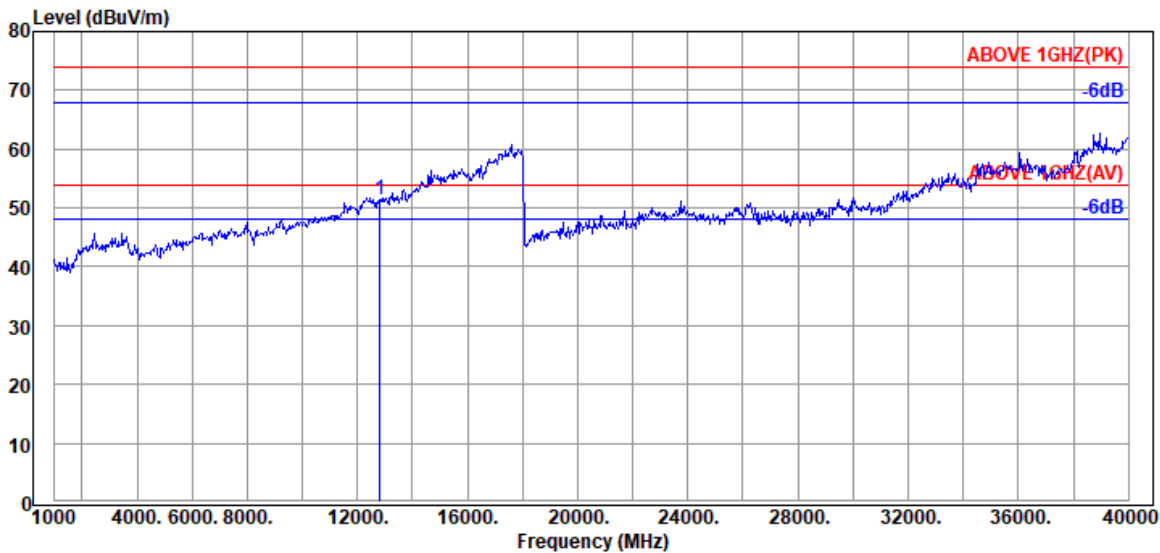

Antenna at Vertical Polarization

Emission Frequency (MHz)	Antenna Factor (dB/m)	Cable Loss (dB)	Preamplifier Gain (dB)	Read Level (dBμV)	Emission Level (dBμV/m)	Limits (dBμV/m)	Margin (dB)	Detector
12810.000	39.17	16.57	33.68	29.41	51.47	54.00	2.53	Peak

Mode	802.11ax-HE40	U-NII Band	6
		Frequency	TX 6445MHz

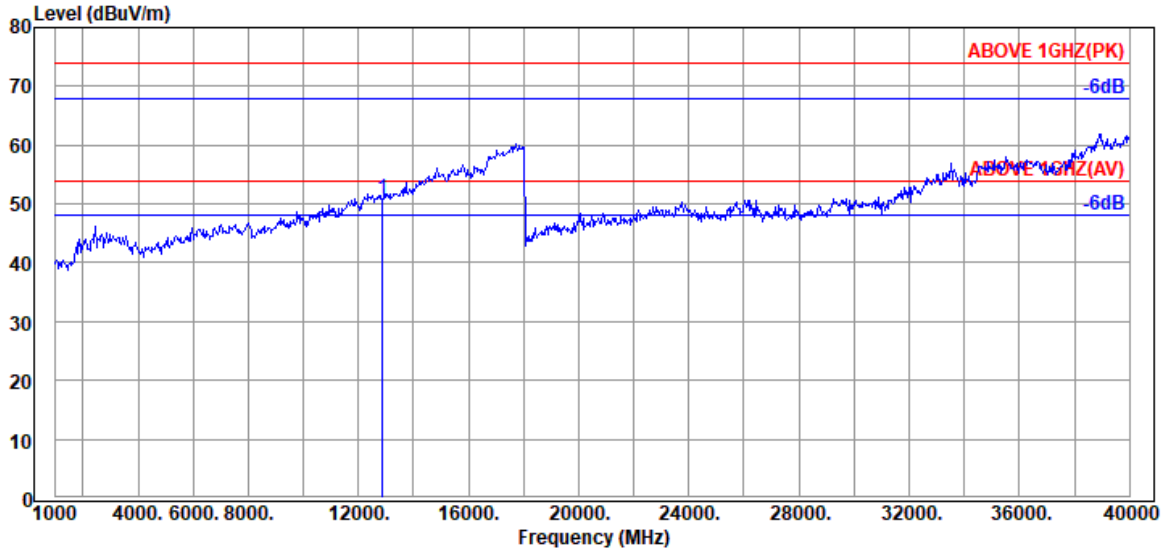

Antenna at Horizontal Polarization

Emission Frequency (MHz)	Antenna Factor (dB/m)	Cable Loss (dB)	Preamp Gain (dB)	Read Level (dBμV)	Emission Level (dBUV/m)	Limits (dBUV/m)	Margin (dB)	Detector
12890.000	39.10	16.60	33.53	28.80	50.97	54.00	3.03	Peak

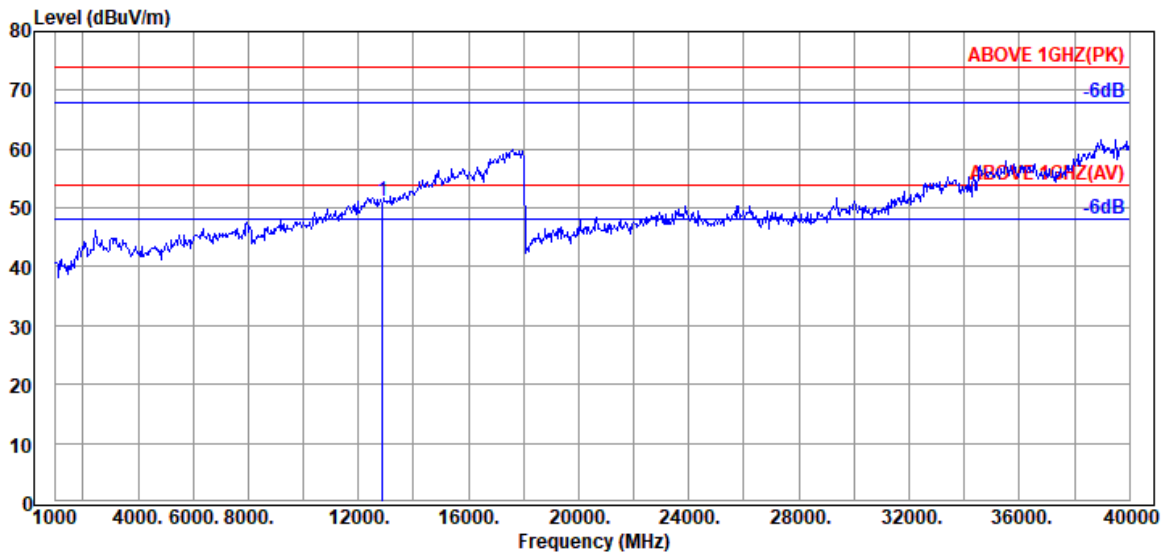

Antenna at Vertical Polarization

Emission Frequency (MHz)	Antenna Factor (dB/m)	Cable Loss (dB)	Preamp Gain (dB)	Read Level (dBμV)	Emission Level (dBUV/m)	Limits (dBUV/m)	Margin (dB)	Detector
12890.000	39.10	16.60	33.53	28.89	51.06	54.00	2.94	Peak

Mode	802.11ax-HE40	U-NII Band	7
		Frequency	TX 6525MHz

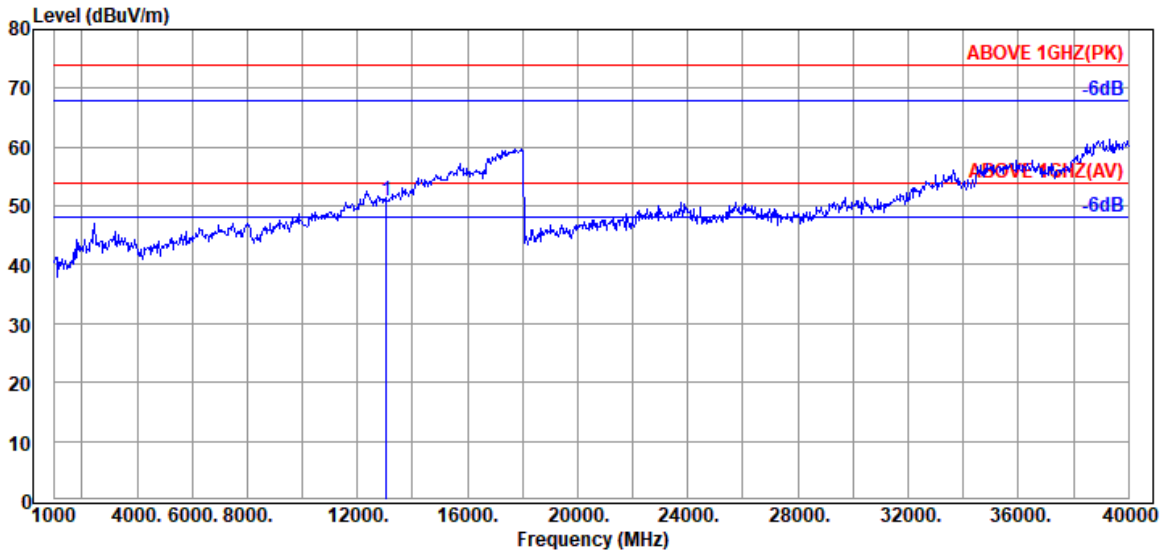

Antenna at Horizontal Polarization

Emission Frequency (MHz)	Antenna Factor (dB/m)	Cable Loss (dB)	Preamp Gain (dB)	Read Level (dBμV)	Emission Level (dBμV/m)	Limits (dBμV/m)	Margin (dB)	Detector
13050.000	39.07	16.65	33.28	28.41	50.85	54.00	3.15	Peak

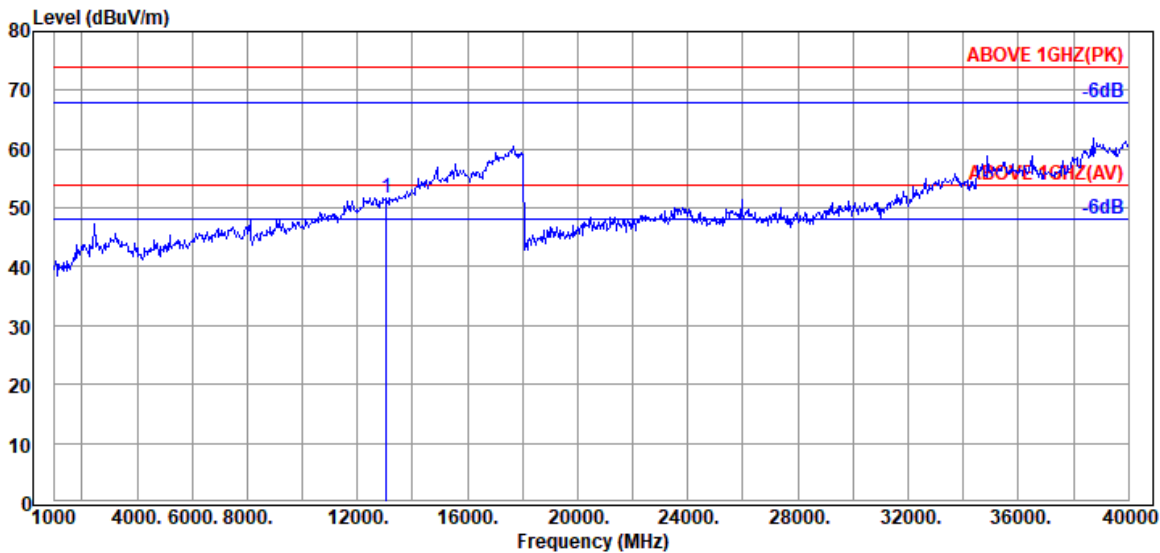

Antenna at Vertical Polarization

Emission Frequency (MHz)	Antenna Factor (dB/m)	Cable Loss (dB)	Preamp Gain (dB)	Read Level (dBμV)	Emission Level (dBμV/m)	Limits (dBμV/m)	Margin (dB)	Detector
13050.000	39.07	16.65	33.28	29.34	51.78	54.00	2.22	Peak

Mode	802.11ax-HE40	U-NII Band	8
		Frequency	TX 7005MHz

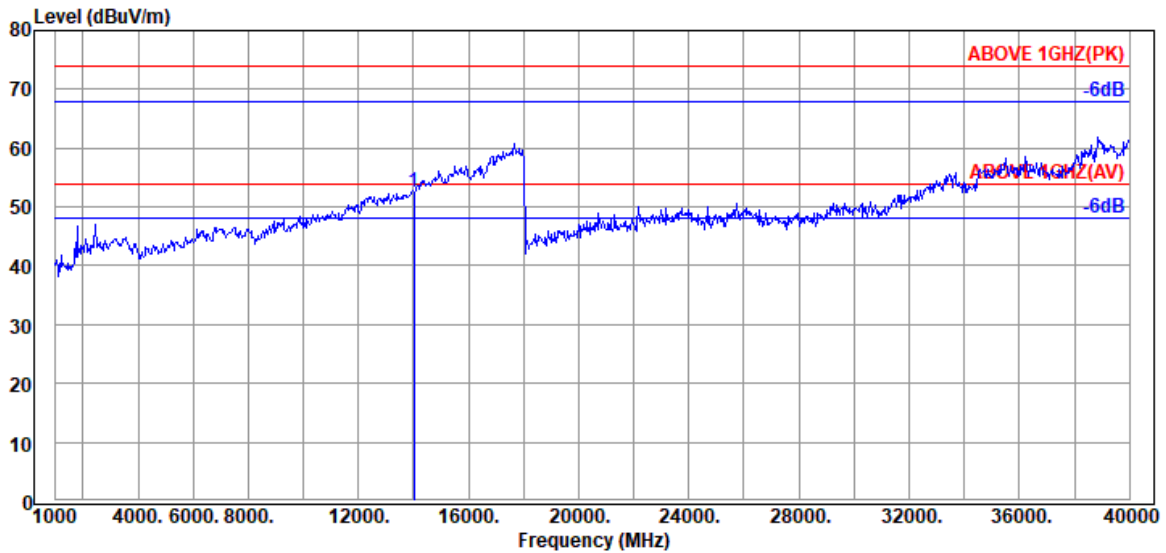

Antenna at Horizontal Polarization

Emission Frequency (MHz)	Antenna Factor (dB/m)	Cable Loss (dB)	Preamplifier Gain (dB)	Read Level (dBμV)	Emission Level (dBμV/m)	Limits (dBμV/m)	Margin (dB)	Detector
14010.000	39.07	16.90	32.99	29.39	52.37	54.00	1.63	Peak

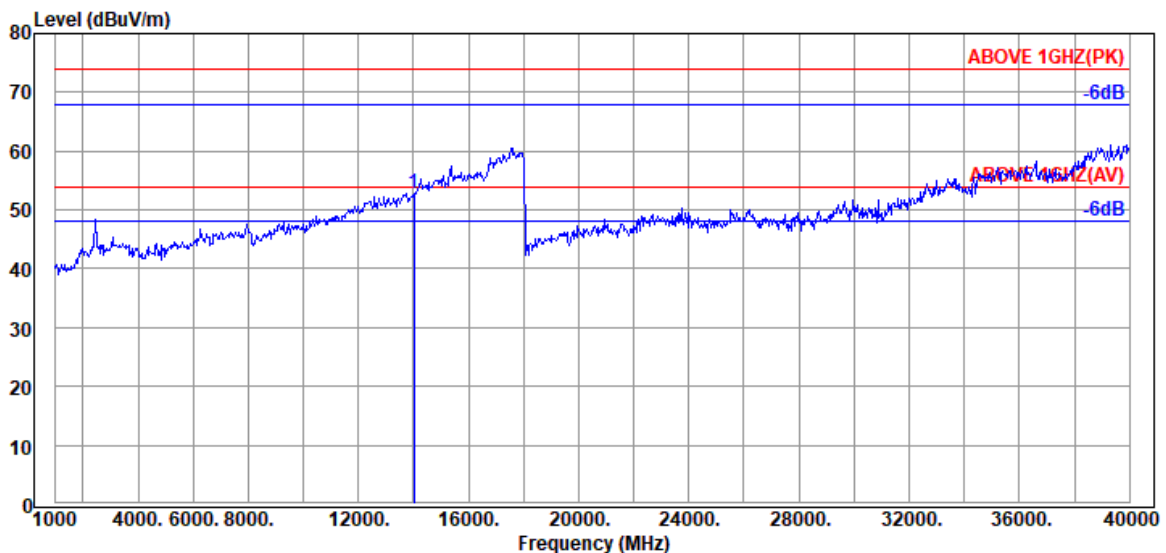

Antenna at Vertical Polarization

Emission Frequency (MHz)	Antenna Factor (dB/m)	Cable Loss (dB)	Preamplifier Gain (dB)	Read Level (dBμV)	Emission Level (dBμV/m)	Limits (dBμV/m)	Margin (dB)	Detector
14010.000	39.07	16.90	32.99	29.90	52.88	54.00	1.12	Peak

Mode	802.11ax-HE80	U-NII Band	5
		Frequency	TX 6145MHz

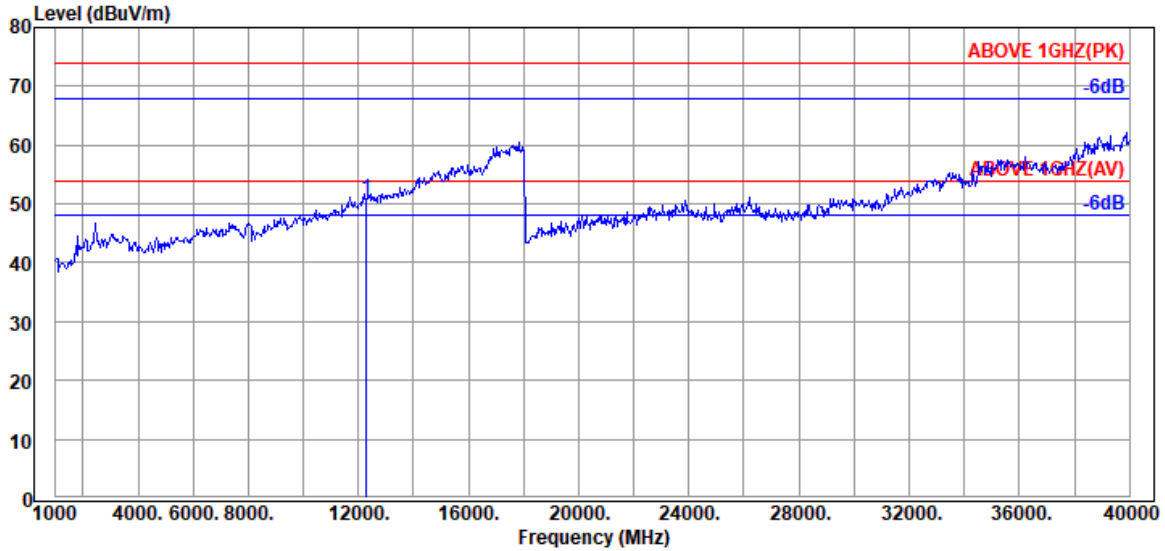

Antenna at Horizontal Polarization

Emission Frequency (MHz)	Antenna Factor (dB/m)	Cable Loss (dB)	Preamp Gain (dB)	Read Level (dBμV)	Emission Level (dBμV/m)	Limits (dBμV/m)	Margin (dB)	Detector
12290.000	39.00	16.35	34.40	29.93	50.88	54.00	3.12	Peak

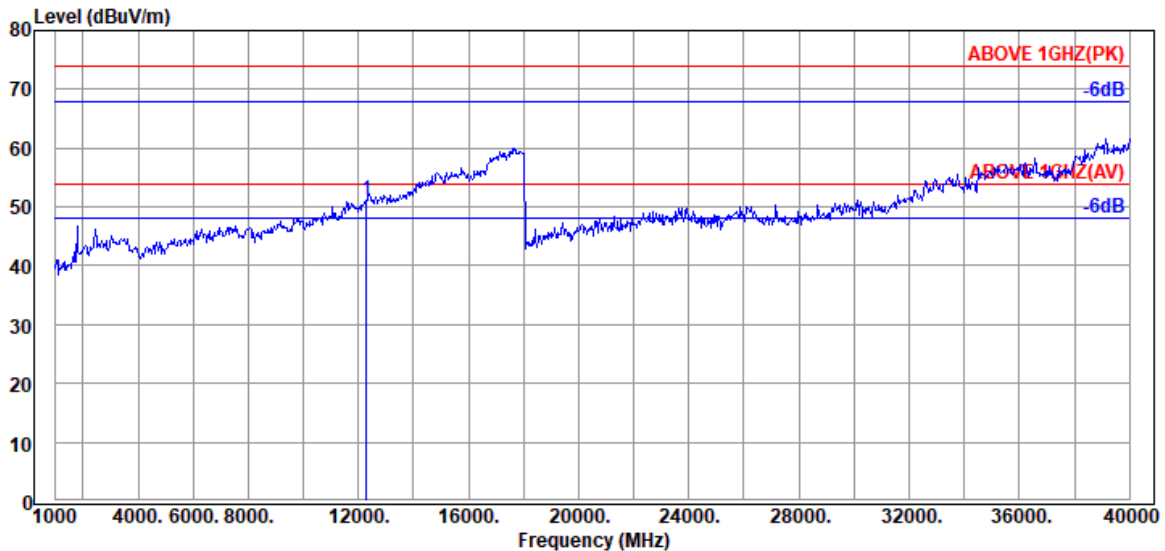

Antenna at Vertical Polarization

Emission Frequency (MHz)	Antenna Factor (dB/m)	Cable Loss (dB)	Preamp Gain (dB)	Read Level (dBμV)	Emission Level (dBμV/m)	Limits (dBμV/m)	Margin (dB)	Detector
12290.000	39.00	16.35	34.40	30.14	51.09	54.00	2.91	Peak

Mode	802.11ax-HE80	U-NII Band	6
		Frequency	TX 6465MHz

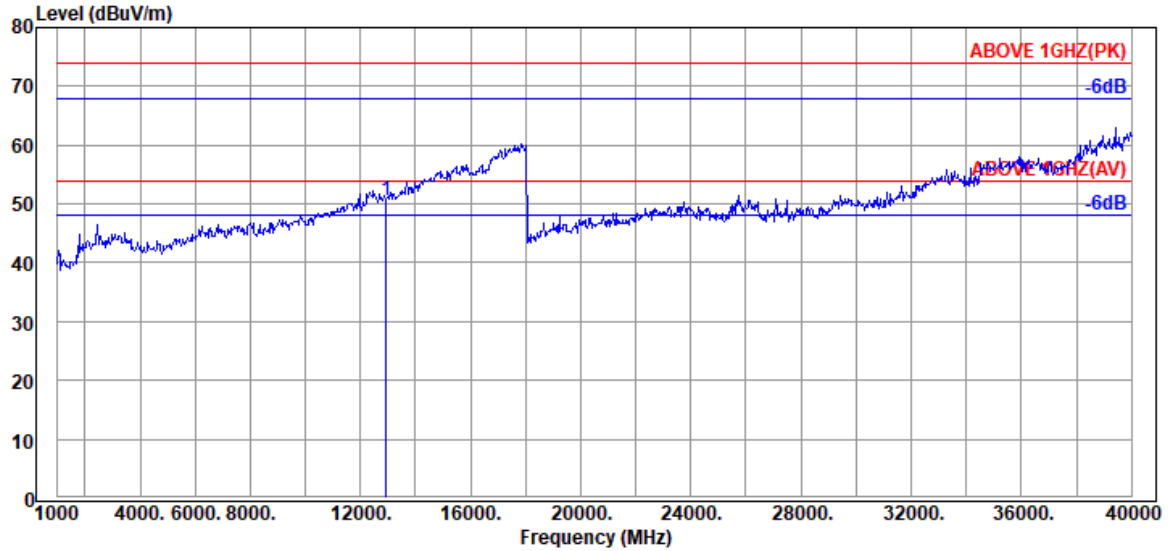

Antenna at Horizontal Polarization

Emission Frequency (MHz)	Antenna Factor (dB/m)	Cable Loss (dB)	Preamp Gain (dB)	Read Level (dBμV)	Emission Level (dBμV/m)	Limits (dBμV/m)	Margin (dB)	Detector
12930.000	39.15	16.60	33.46	28.39	50.68	54.00	3.32	Peak

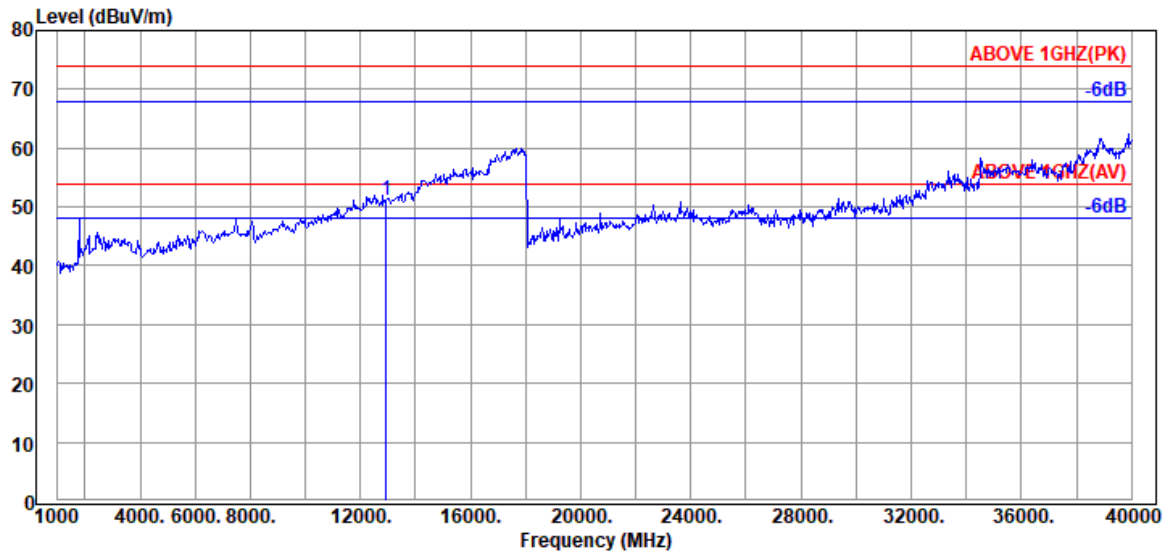

Antenna at Vertical Polarization

Emission Frequency (MHz)	Antenna Factor (dB/m)	Cable Loss (dB)	Preamp Gain (dB)	Read Level (dBμV)	Emission Level (dBμV/m)	Limits (dBμV/m)	Margin (dB)	Detector
12930.000	39.15	16.60	33.46	28.91	51.20	54.00	2.80	Peak

Mode	802.11ax-HE80	U-NII Band	7
		Frequency	TX 6785MHz

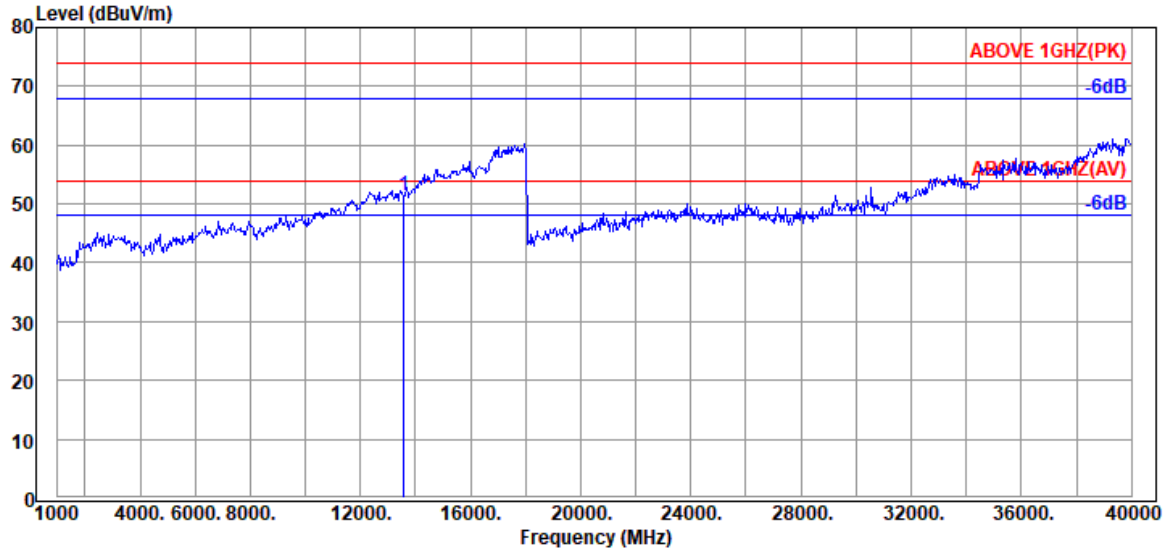

Antenna at Horizontal Polarization

Emission Frequency (MHz)	Antenna Factor (dB/m)	Cable Loss (dB)	Preamp Gain (dB)	Read Level (dBμV)	Emission Level (dBμV/m)	Limits (dBμV/m)	Margin (dB)	Detector
13570.000	39.00	16.79	32.93	28.67	51.53	54.00	2.47	Peak

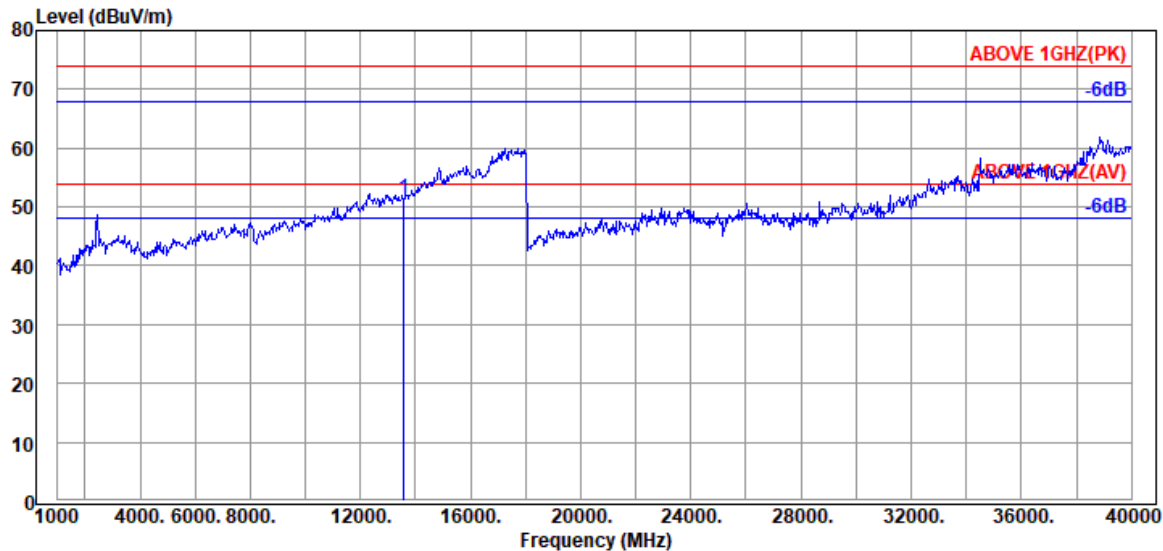

Antenna at Vertical Polarization

Emission Frequency (MHz)	Antenna Factor (dB/m)	Cable Loss (dB)	Preamp Gain (dB)	Read Level (dBμV)	Emission Level (dBμV/m)	Limits (dBμV/m)	Margin (dB)	Detector
13570.000	39.00	16.79	32.93	28.67	51.53	54.00	2.47	Peak

Mode	802.11ax-HE80	U-NII Band	8
		Frequency	TX 6865MHz

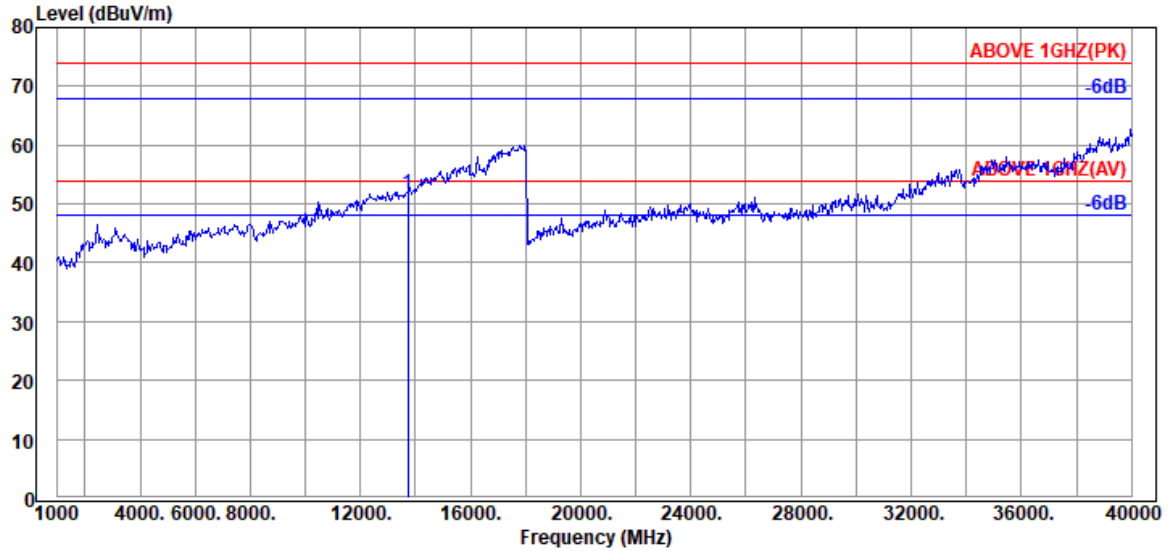

Antenna at Horizontal Polarization

Emission Frequency (MHz)	Antenna Factor (dB/m)	Cable Loss (dB)	Preamp Gain (dB)	Read Level (dBμV)	Emission Level (dBμV/m)	Limits (dBμV/m)	Margin (dB)	Detector
13730.000	38.80	16.81	32.93	28.95	51.63	54.00	2.37	Peak

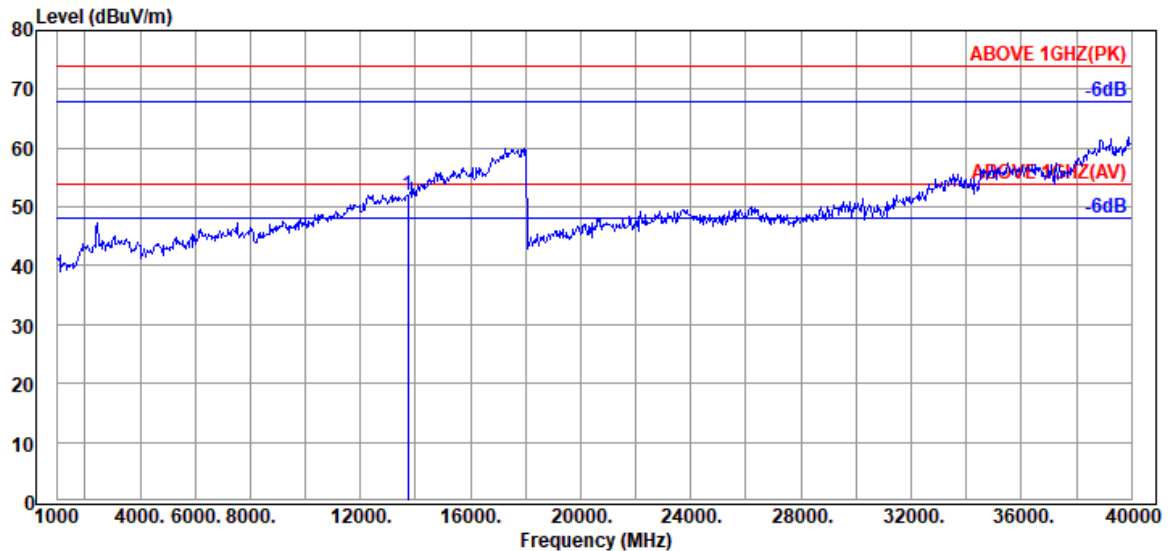

Antenna at Vertical Polarization

Emission Frequency (MHz)	Antenna Factor (dB/m)	Cable Loss (dB)	Preamp Gain (dB)	Read Level (dBμV)	Emission Level (dBμV/m)	Limits (dBμV/m)	Margin (dB)	Detector
13730.000	38.80	16.81	32.93	29.37	52.05	54.00	1.95	Peak

Mode	802.11ax-HE160	U-NII Band	5
		Frequency	TX 6345MHz

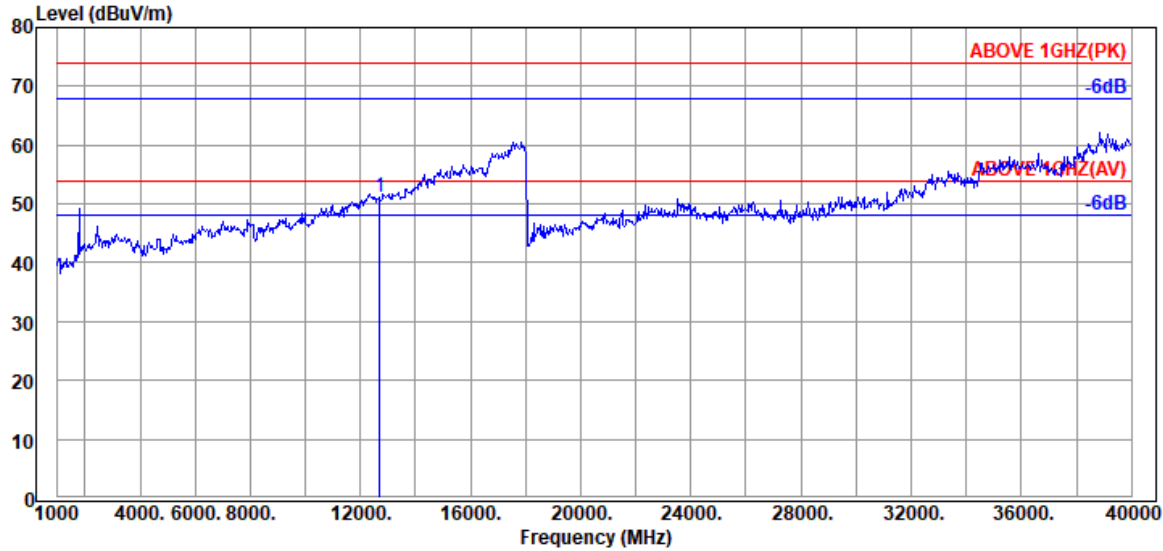

Antenna at Horizontal Polarization

Emission Frequency (MHz)	Antenna Factor (dB/m)	Cable Loss (dB)	Preamp Gain (dB)	Read Level (dBμV)	Emission Level (dBμV/m)	Limits (dBμV/m)	Margin (dB)	Detector
12690.000	39.10	16.51	33.82	29.46	51.25	54.00	2.75	Peak

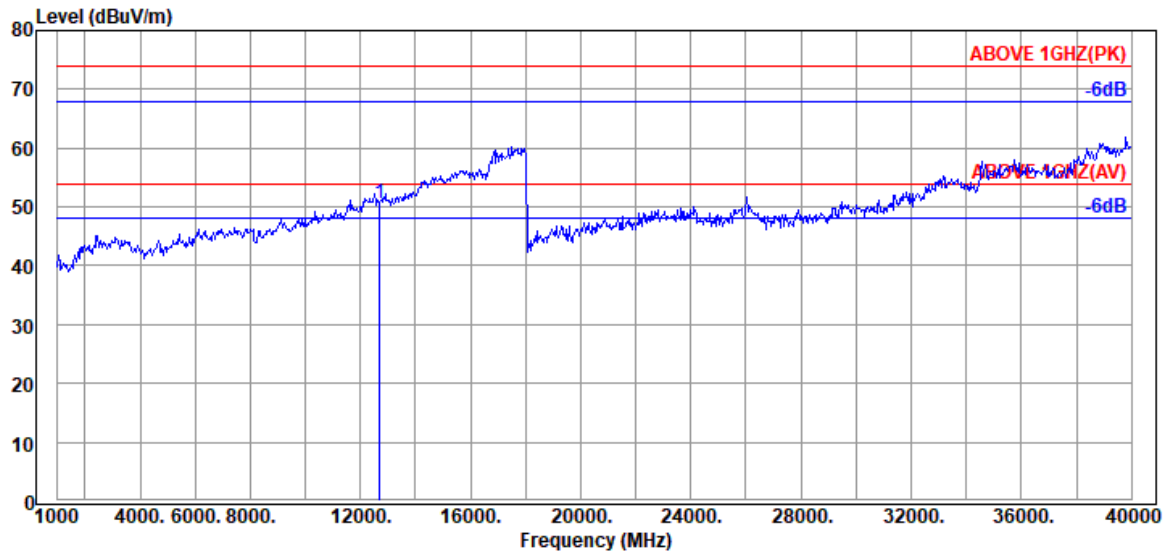

Antenna at Vertical Polarization

Emission Frequency (MHz)	Antenna Factor (dB/m)	Cable Loss (dB)	Preamp Gain (dB)	Read Level (dBμV)	Emission Level (dBμV/m)	Limits (dBμV/m)	Margin (dB)	Detector
12690.000	39.10	16.51	33.82	28.74	50.53	54.00	3.47	Peak

Mode	802.11ax-HE160	U-NII Band	6
		Frequency	TX 6505MHz

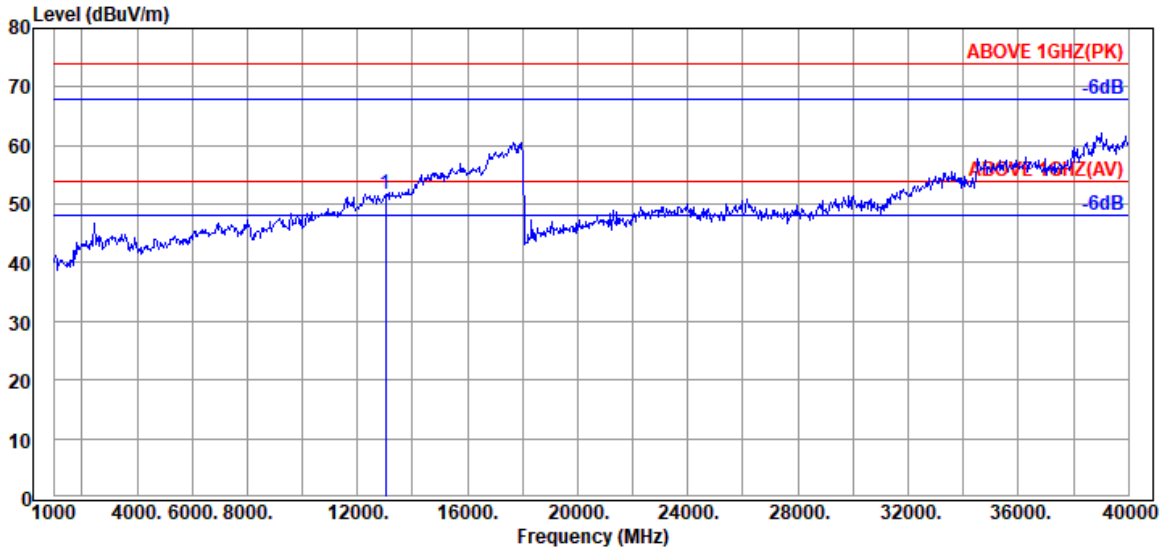

Antenna at Horizontal Polarization

Emission Frequency (MHz)	Antenna Factor (dB/m)	Cable Loss (dB)	Preamp Gain (dB)	Read Level (dBμV)	Emission Level (dBμV/m)	Limits (dBμV/m)	Margin (dB)	Detector
13010.000	39.13	16.63	33.32	29.15	51.59	54.00	2.41	Peak

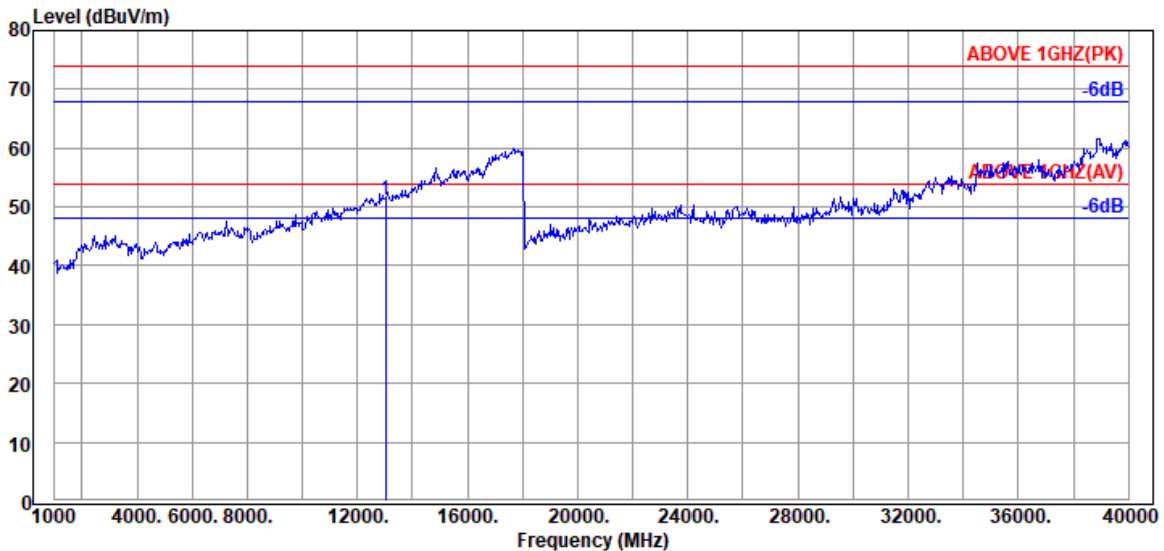

Antenna at Vertical Polarization

Emission Frequency (MHz)	Antenna Factor (dB/m)	Cable Loss (dB)	Preamp Gain (dB)	Read Level (dBμV)	Emission Level (dBμV/m)	Limits (dBμV/m)	Margin (dB)	Detector
13010.000	39.13	16.63	33.32	28.75	51.19	54.00	2.81	Peak

Mode	802.11ax-HE160	U-NII Band	7
		Frequency	TX 6825MHz

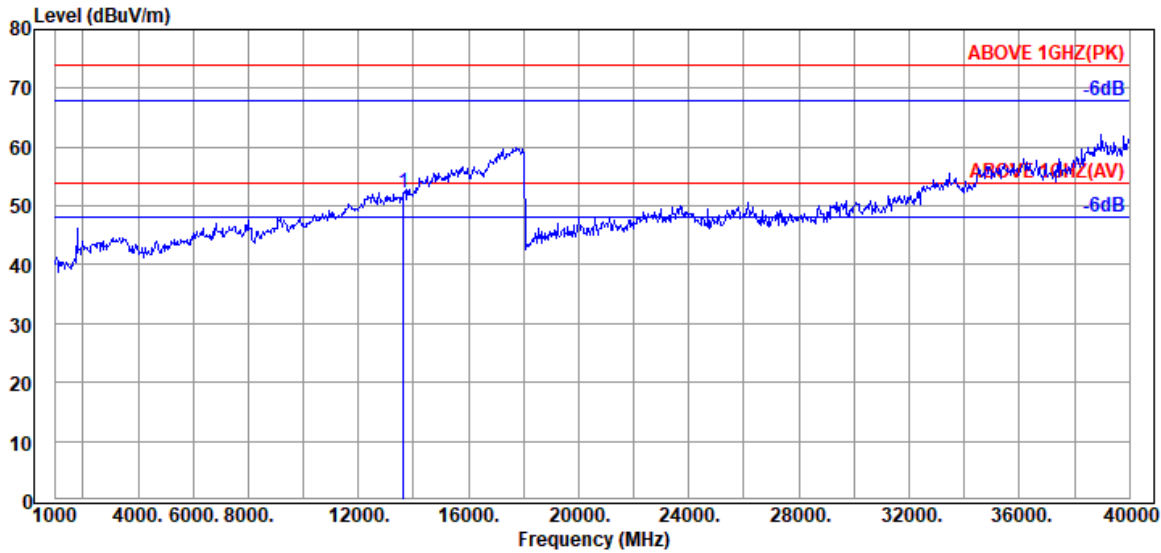

Antenna at Horizontal Polarization

Emission Frequency (MHz)	Antenna Factor (dB/m)	Cable Loss (dB)	Preamp Gain (dB)	Read Level (dBμV)	Emission Level (dBμV/m)	Limits (dBμV/m)	Margin (dB)	Detector
13650.000	38.87	16.81	32.93	29.37	52.12	54.00	1.88	Peak

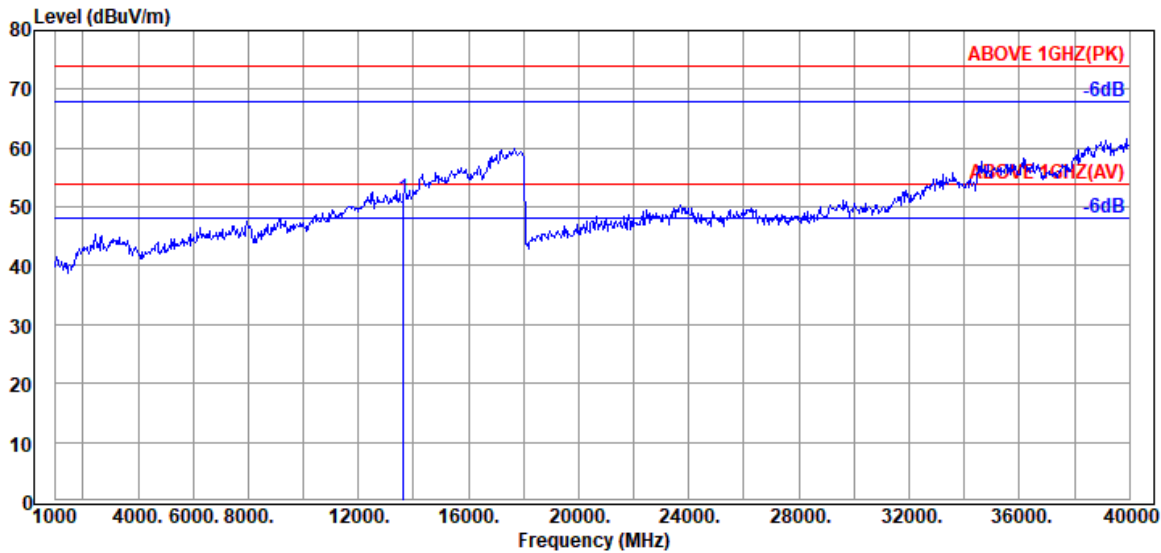

Antenna at Vertical Polarization

Emission Frequency (MHz)	Antenna Factor (dB/m)	Cable Loss (dB)	Preamp Gain (dB)	Read Level (dBμV)	Emission Level (dBμV/m)	Limits (dBμV/m)	Margin (dB)	Detector
13650.000	38.87	16.81	32.93	28.71	51.46	54.00	2.54	Peak

Mode	802.11ax-HE160	U-NII Band	8
		Frequency	TX 6985MHz

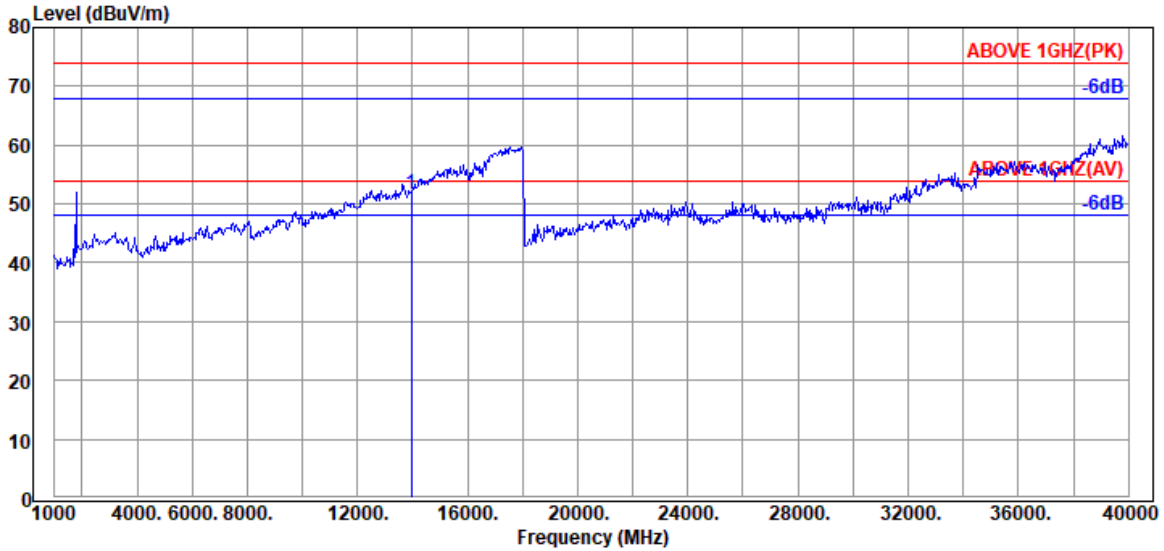

Antenna at Horizontal Polarization

Emission Frequency (MHz)	Antenna Factor (dB/m)	Cable Loss (dB)	Preamp Gain (dB)	Read Level (dBμV)	Emission Level (dBμV/m)	Limits (dBμV/m)	Margin (dB)	Detector
13970.000	39.00	16.88	32.94	28.80	51.74	54.00	2.26	Peak

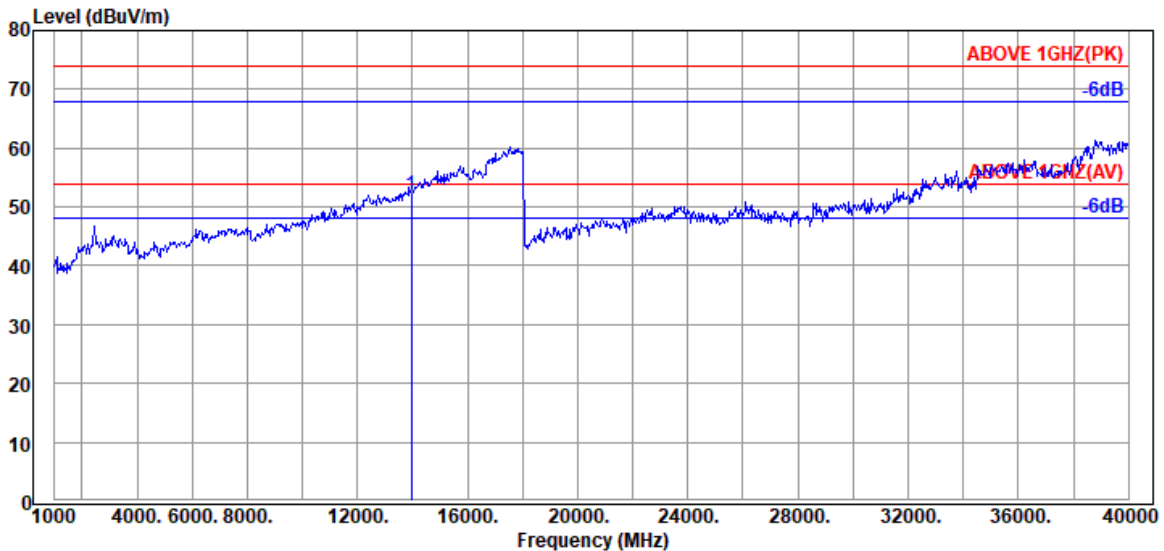

Antenna at Vertical Polarization

Emission Frequency (MHz)	Antenna Factor (dB/m)	Cable Loss (dB)	Preamp Gain (dB)	Read Level (dBμV)	Emission Level (dBμV/m)	Limits (dBμV/m)	Margin (dB)	Detector
13970.000	39.00	16.88	32.94	29.15	52.09	54.00	1.91	Peak

● OFDMA Modulation

Tones	26T	RU Index	18
Mode	802.11ax-HE80	U-NII Band	5
		Frequency	TX 5985MHz

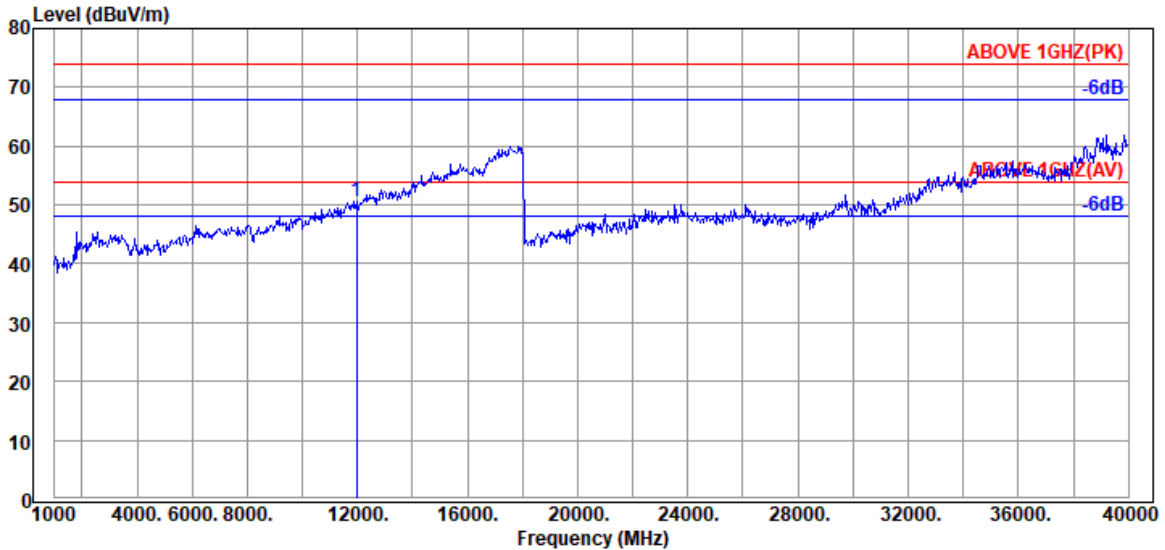

Antenna at Horizontal Polarization

Emission Frequency (MHz)	Antenna Factor (dB/m)	Cable Loss (dB)	Preamplifier Gain (dB)	Read Level (dBμV)	Emission Level (dBμV/m)	Limits (dBμV/m)	Margin (dB)	Detector
11970.000	38.80	16.19	34.64	30.12	50.47	54.00	3.53	Peak

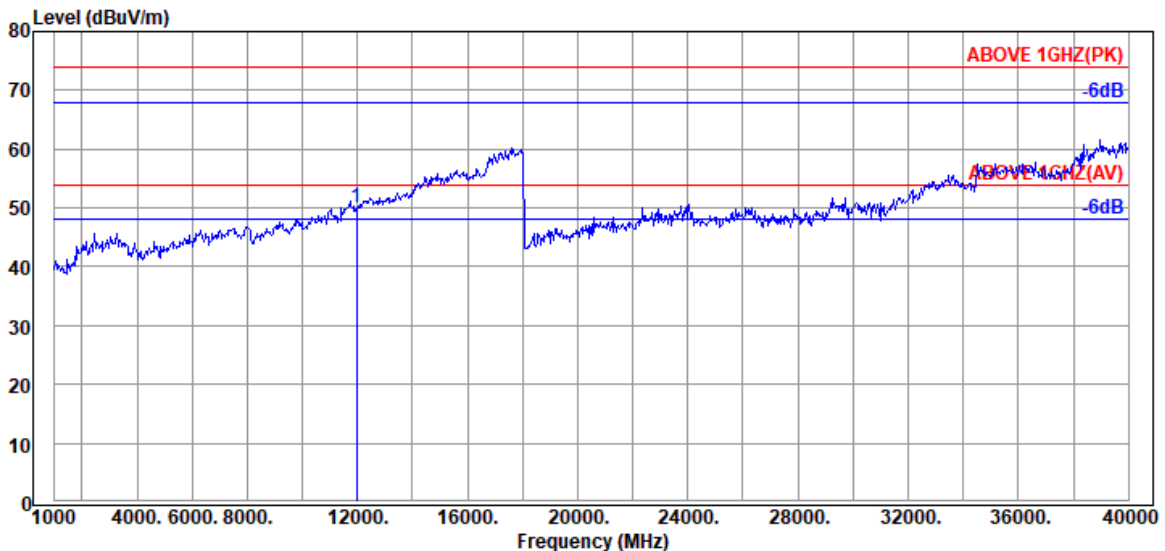

Antenna at Vertical Polarization

Emission Frequency (MHz)	Antenna Factor (dB/m)	Cable Loss (dB)	Preamplifier Gain (dB)	Read Level (dBμV)	Emission Level (dBμV/m)	Limits (dBμV/m)	Margin (dB)	Detector
11970.000	38.80	16.19	34.64	29.78	50.13	54.00	3.87	Peak

Tones	52T	RU Index	44
Mode	802.11ax-HE80	U-NII Band	5
		Frequency	TX 5985MHz

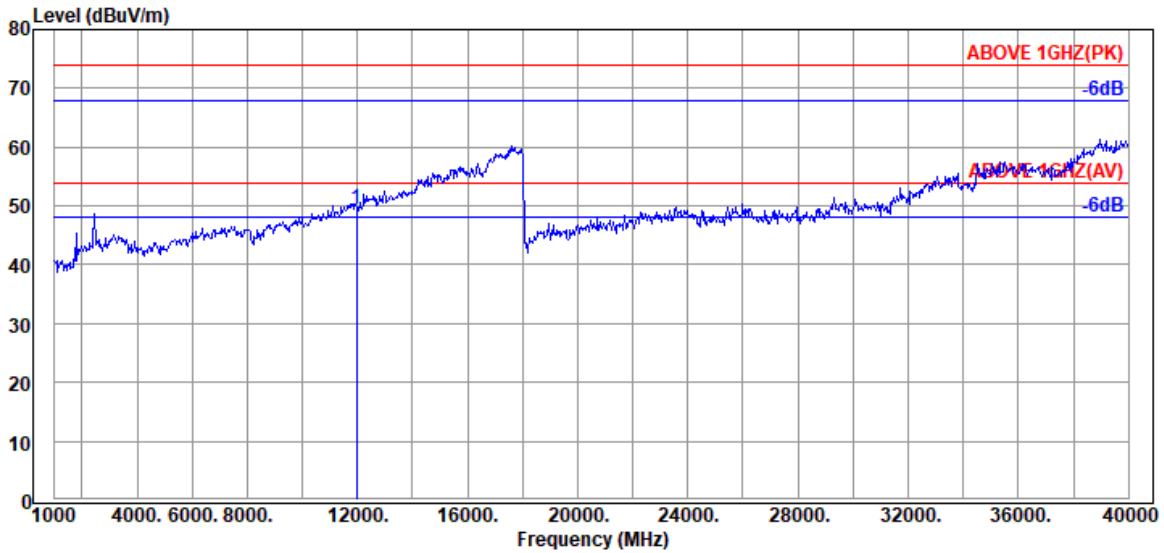

Antenna at Horizontal Polarization

Emission Frequency (MHz)	Antenna Factor (dB/m)	Cable Loss (dB)	Preamplifier Gain (dB)	Read Level (dBμV)	Emission Level (dBμV/m)	Limits (dBμV/m)	Margin (dB)	Detector
11970.000	38.80	16.19	34.64	29.13	49.48	54.00	4.52	Peak

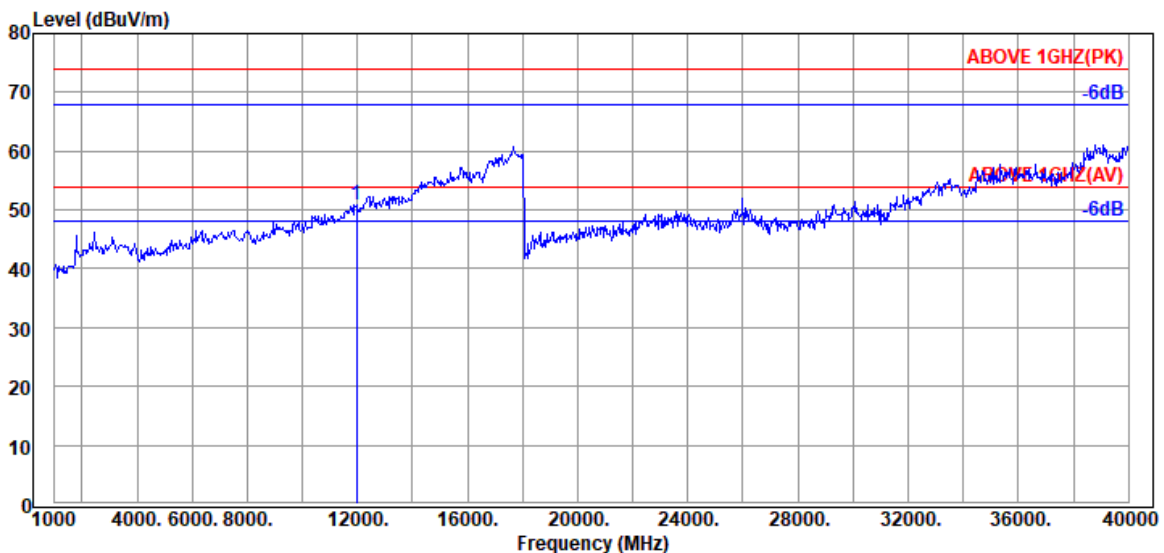

Antenna at Vertical Polarization

Emission Frequency (MHz)	Antenna Factor (dB/m)	Cable Loss (dB)	Preamplifier Gain (dB)	Read Level (dBμV)	Emission Level (dBμV/m)	Limits (dBμV/m)	Margin (dB)	Detector
11970.000	38.80	16.19	34.64	30.55	50.90	54.00	3.10	Peak

Tones	106T	RU Index	54
Mode	802.11ax-HE20	U-NII Band	5
		Frequency	TX 5955MHz

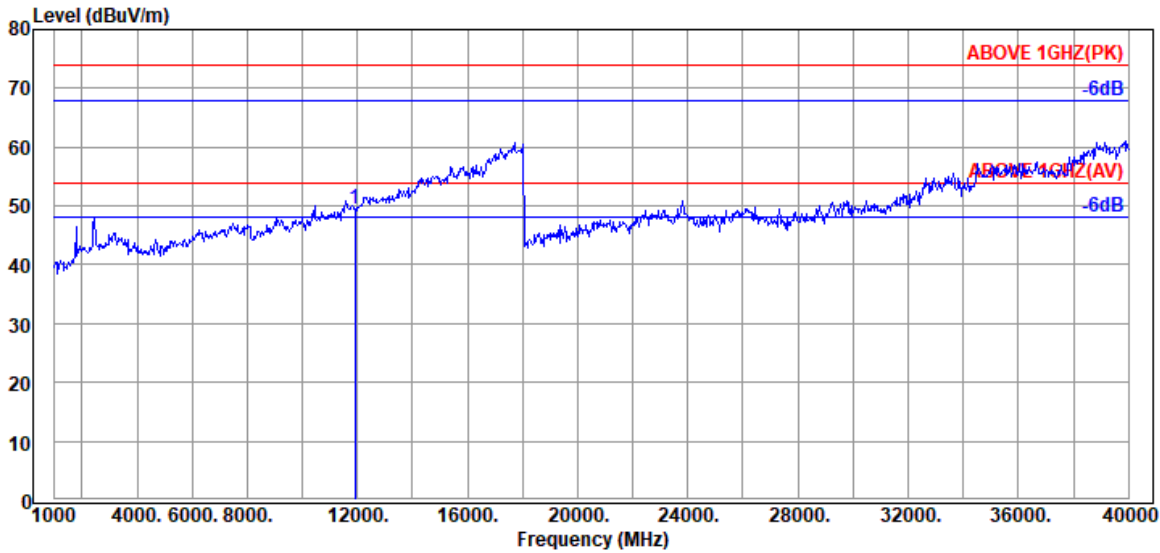

Antenna at Horizontal Polarization

Emission Frequency (MHz)	Antenna Factor (dB/m)	Cable Loss (dB)	Preamp Gain (dB)	Read Level (dBμV)	Emission Level (dBμV/m)	Limits (dBμV/m)	Margin (dB)	Detector
11910.000	38.80	16.11	34.63	29.22	49.50	54.00	4.50	Peak

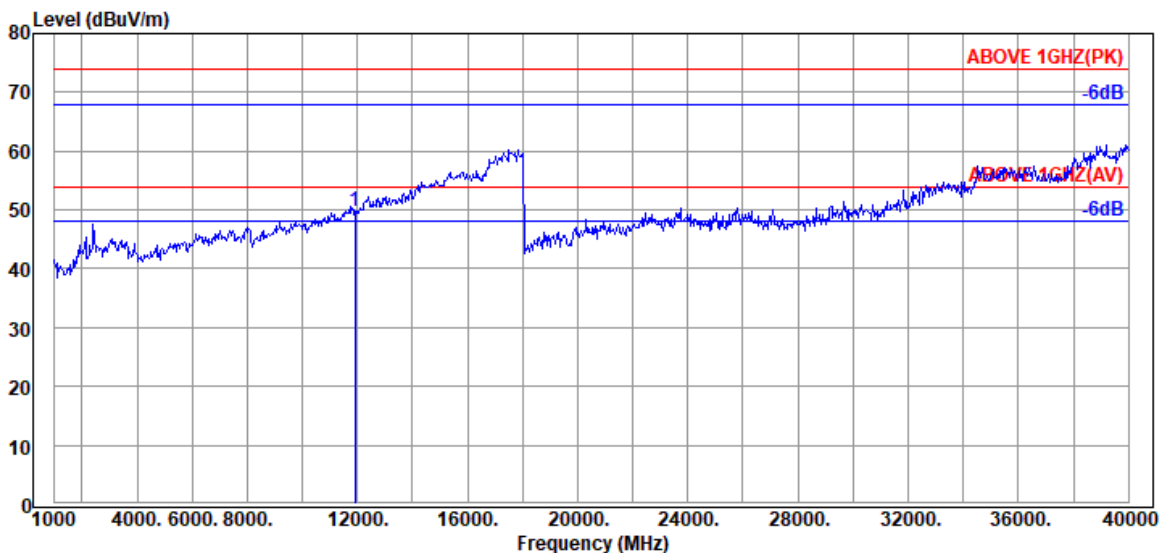

Antenna at Vertical Polarization

Emission Frequency (MHz)	Antenna Factor (dB/m)	Cable Loss (dB)	Preamp Gain (dB)	Read Level (dBμV)	Emission Level (dBμV/m)	Limits (dBμV/m)	Margin (dB)	Detector
11910.000	38.80	16.19	34.63	29.51	49.87	54.00	4.13	Peak

Tones	242T	RU Index	62
Mode	802.11ax-HE160	U-NII Band	5
		Frequency	TX 6185MHz

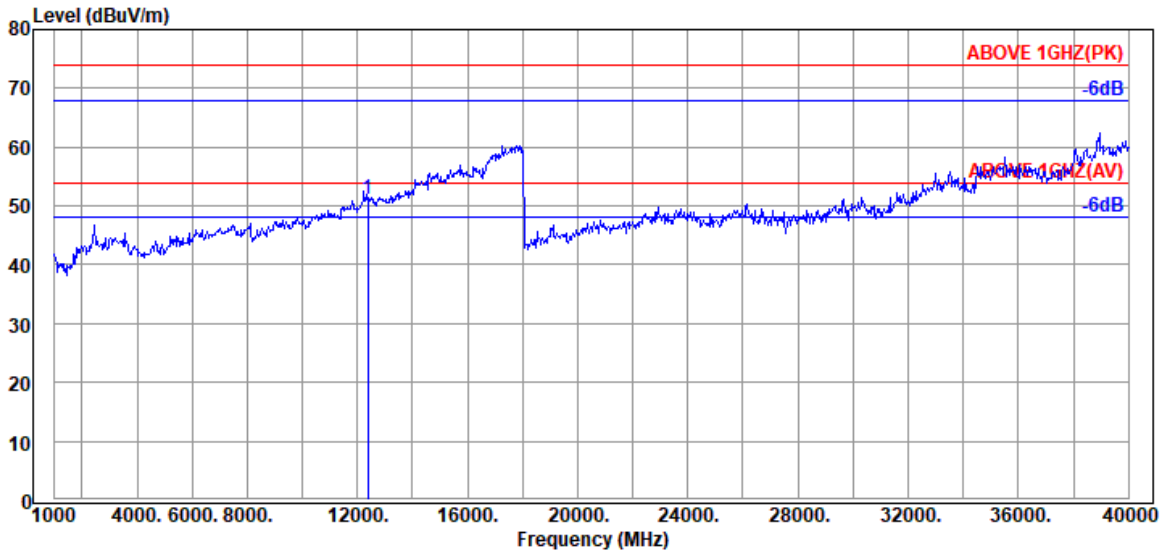

Antenna at Horizontal Polarization

Emission Frequency (MHz)	Antenna Factor (dB/m)	Cable Loss (dB)	Preamplifier Gain (dB)	Read Level (dBμV)	Emission Level (dBμV/m)	Limits (dBμV/m)	Margin (dB)	Detector
12370.000	38.93	16.38	34.29	30.00	51.02	54.00	2.98	Peak

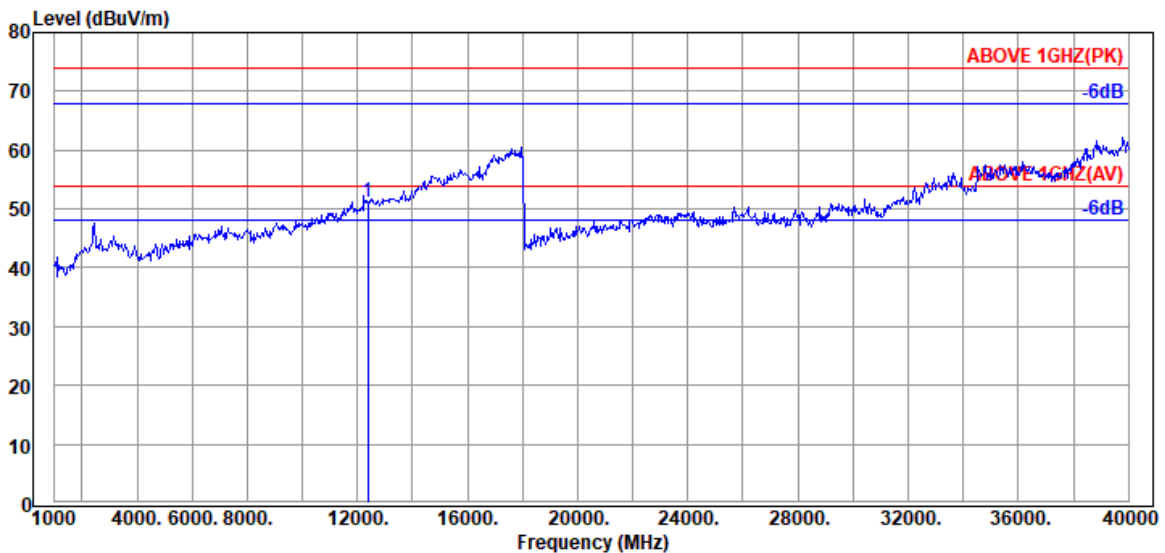

Antenna at Vertical Polarization

Emission Frequency (MHz)	Antenna Factor (dB/m)	Cable Loss (dB)	Preamplifier Gain (dB)	Read Level (dBμV)	Emission Level (dBμV/m)	Limits (dBμV/m)	Margin (dB)	Detector
12370.000	38.90	16.41	34.29	30.11	51.13	54.00	2.87	Peak

Tones	484T	RU Index	66
Mode	802.11ax-HE160	U-NII Band	5
		Frequency	TX 6185MHz

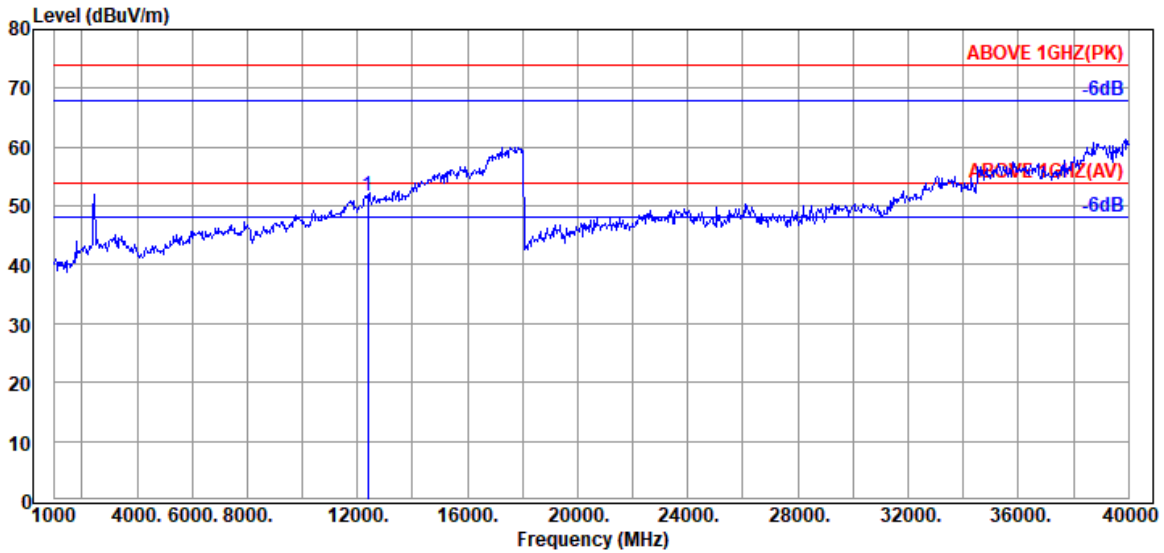

Antenna at Horizontal Polarization

Emission Frequency (MHz)	Antenna Factor (dB/m)	Cable Loss (dB)	Preamp Gain (dB)	Read Level (dBμV)	Emission Level (dBμV/m)	Limits (dBμV/m)	Margin (dB)	Detector
12370.000	38.93	16.38	34.29	30.73	51.75	54.00	2.25	Peak

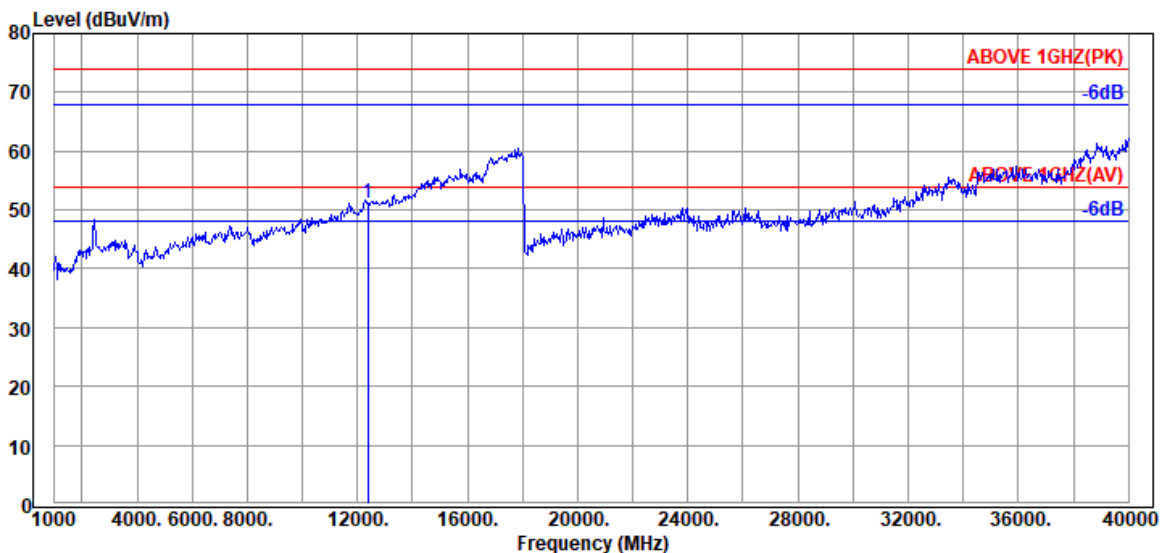

Antenna at Vertical Polarization

Emission Frequency (MHz)	Antenna Factor (dB/m)	Cable Loss (dB)	Preamp Gain (dB)	Read Level (dBμV)	Emission Level (dBμV/m)	Limits (dBμV/m)	Margin (dB)	Detector
12370.000	38.93	16.38	34.29	30.10	51.12	54.00	2.88	Peak

Tones	996T	RU Index	67
Mode	802.11ax-HE80	U-NII Band	5
		Frequency	TX 6145MHz

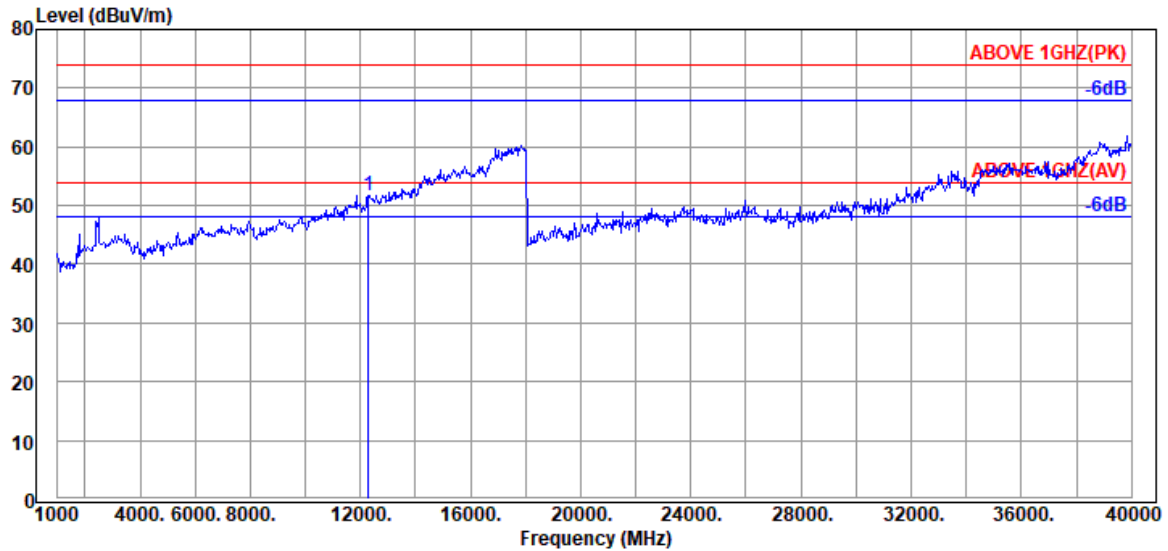

Antenna at Horizontal Polarization

Emission Frequency (MHz)	Antenna Factor (dB/m)	Cable Loss (dB)	Preamp Gain (dB)	Read Level (dBμV)	Emission Level (dBμV/m)	Limits (dBμV/m)	Margin (dB)	Detector
12290.000	39.00	16.35	34.36	30.79	51.78	54.00	2.22	Peak

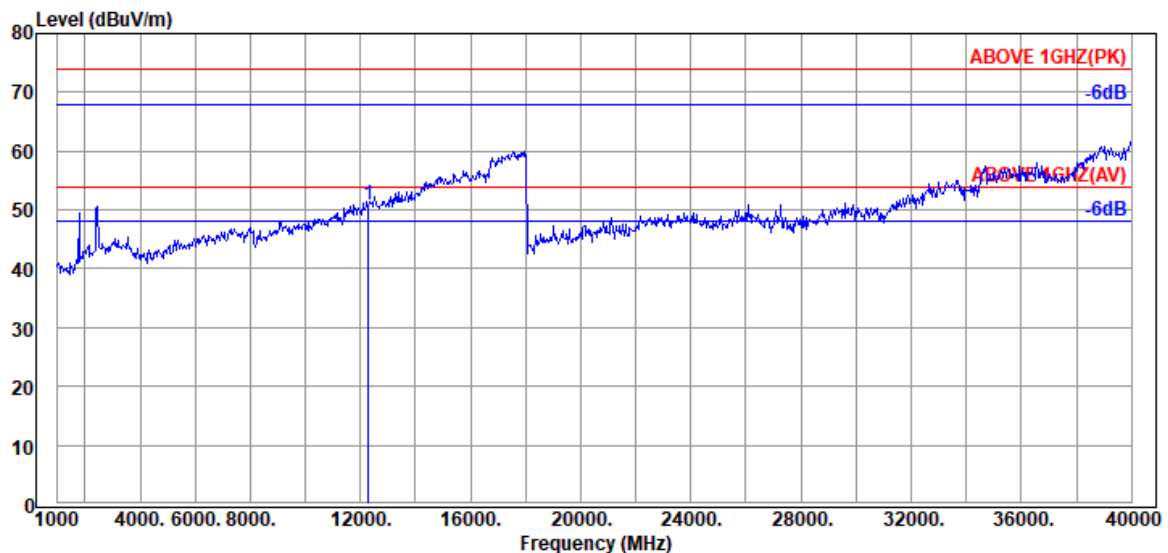

Antenna at Vertical Polarization

Emission Frequency (MHz)	Antenna Factor (dB/m)	Cable Loss (dB)	Preamp Gain (dB)	Read Level (dBμV)	Emission Level (dBμV/m)	Limits (dBμV/m)	Margin (dB)	Detector
12290.000	39.00	16.35	34.36	29.78	50.77	54.00	3.23	Peak

A.2.3 Emissions in Non-restricted Frequency Bands

Pursuant to KDB 789033 D02 General UNII Test Procedures New Rules v02r01 that emission levels below the 15.209 general radiated emissions limits is not required.