

FCC 15.247 & RSS-247 2.4GHz Test Report

for

LG Electronics Inc.

**222, LG-ro, Jinwi-myeon Pyeongtaek-Si, Gyeonggi-Do,
17709 Republic of Korea**

Product Name : Notebook Computer
Model Name : (1)15Z95P (2)15ZB95P
(3)15ZD95P (4)15ZG95P
(5)15ZC95P
Brand : LG
FCC ID : BEJNT-15Z95P
IC : 2703H-15Z95P

Prepared by: : AUDIX Technology Corporation,
EMC Department



The test report is based on a single evaluation of one sample of the above-mentioned products. It does not imply an assessment of the whole production and does not permit the use of the test lab logo.

TABLE OF CONTENTS

Description	Page
TEST REPORT	4
1. REVISION RECORD OF TEST REPORT	5
2. SUMMARY OF TEST RESULTS	6
3. GENERAL INFORMATION	7
3.1. Description of Application	7
3.2. Description of EUT	8
3.3. Antenna Information	9
3.4. EUT Specifications Assessed in Current Report	10
3.5. Descriptions of Key Components	12
3.6. Test Configuration	14
3.7. Output Power Setting	19
3.8. Tested Supporting System List	20
3.9. Setup Configuration	21
3.10. Operating Condition of EUT	21
3.11. Description of Test Facility	22
3.12. Measurement Uncertainty	23
4. MEASUREMENT EQUIPMENT LIST	24
4.1. Conducted Emission Measurement	24
4.2. Radiated Emission Measurement	25
4.3. RF Conducted Measurement	26
5. CONDUCTED EMISSION	27
5.1. Block Diagram of Test Setup	27
5.2. Conducted Emission Limit	27
5.3. Test Procedure	27
5.4. Test Results	27
6. RADIATED EMISSION	28
6.1. Block Diagram of Test Setup	28
6.2. Radiated Emission Limits	30
6.3. Test Procedure	31
6.4. Measurement Result Explanation	32
6.5. Test Results	32
7. 6dB OCCUPIED BANDWIDTH	33
7.1. Block Diagram of Test Setup	33
7.2. Specification Limits	33
7.3. Test Procedure	33
7.4. Test Results	33
8. MAXIMUM PEAK OUTPUT POWER	34
8.1. Block Diagram of Test Setup	34
8.2. Specification Limits	34
8.3. Test Procedure	35
8.4. Test Results	35
9. EMISSION LIMITATIONS	36
9.1. Block Diagram of Test Setup	36



Audix Technology Corp.
No. 491, Zhongfu Rd., Linkou Dist.,
New Taipei City 244, Taiwan

Tel: +886 2 26099301
Fax: +886 2 26099303

9.2. Specification Limits.....	36
9.3. Test Procedure.....	36
9.4. Test Results	37
10. POWER SPECTRAL DENSITY	38
10.1. Block Diagram of Test Setup	38
10.2. Specification Limits.....	38
10.3. Test Procedure	38
10.4. Test Results	38
11. DEVIATION TO TEST SPECIFICATIONS	39

APPENDIX A TEST DATA AND PLOTS

APPENDIX B TESTPHOTOGRAPHS

TEST REPORT

Applicant : LG Electronics Inc.
Manufacturer : LG Electronics Inc.
Factory #1 : LG Electronics Nanjing New Technology Co., Ltd.
Factory #2 : LG Electronics Do Brasil Ltda. (048130)
EUT Description
(1) Product : Notebook Computer
(2) Model : (1)15Z95P (2)15ZB95P (3)15ZD95P (4)15ZG95P (5)15ZC95P
(3) Brand : LG
(4) Power Supply: DC 20V, 3.25A

Applicable Standards:

Title 47 CFR FCC Part 15 Subpart C
RSS-Gen (Issue 5), Amendment 2, February 2021
RSS-247 (Issue 2), February 2017
ANSI C63.10:2013

Audix Technology Corp. tested the equipment mentioned in accordance with the requirements set forth in the above standards. Test results indicate that the equipment tested is capable of demonstrating compliance with the requirements as documented within this report.

Audix Technology Corp. does not assume responsibility for any conclusions and generalizations drawn from the test results with regard to other specimens and samples.

Date of Report: 2021. 08. 27

Reviewed by:



(Annie Yu/Administrator)

Approved by:

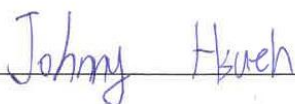

(Johnny Hsueh/Section Manager)

1. REVISION RECORD OF TEST REPORT

Edition No	Issued Data	Revision Summary	Report Number
0	2021. 08. 27	Original Report	EM-F210583

2. SUMMARY OF TEST RESULTS

Rule		Description	Data Reused	Results
FCC	IC			
15.207	RSS-Gen §8.8	Conducted Emission	No	PASS
15.247(d)/ 15.205	RSS-Gen §8.9 RSS-247 §5.5	Radiated Band Edge and Radiated Spurious Emission	No	PASS
15.247(a)(2)	RSS-247 §5.2(1)	6dB/Occupied Bandwidth	Yes	PASS
15.247(b)(3)	RSS-247 §5.4(4)	Maximum Peak Output Power	SPOT CHECK ^{Note 2}	PASS
15.247(d)	RSS-247 §5.5	Conducted Band Edges and Conducted Spurious Emission	Yes	PASS
15.247 (e)	RSS-247 §5.2(2)	Peak Power Spectral Density	Yes	PASS
15.203	---	Antenna Requirement	---	Compliance

Note: 1. The uncertainties value is not used in determining the result.
 2. This device embedded with same radio transmitter with FCC ID: BEJNT-15Z90N grant on 11/29 2019 and IC: 2703H-15Z90N (Report No.: EM-F190339) approved on 12/04/2019. According to KDB 484596 D01, we did spot check for output power and all output power values keep identical thus we reuse all results except to E.I.R.P. test items.

3. GENERAL INFORMATION

3.1. Description of Application

Applicant	LG Electronics Inc. 222, LG-ro, Jinwi-myeon Pyeongtaek-Si, Gyeonggi-Do, 17709 Republic of Korea
Manufacturer	LG Electronics Inc. 222, LG-ro, Jinwi-myeon Pyeongtaek-Si, Gyeonggi-Do, 17709 Republic of Korea
Factory #1	LG Electronics Nanjing New Technology Co., Ltd. No.346, Yaoxin Road, Economic & Technical Development Zone, Nanjing, China.
Factory #2	LG Electronics Do Brasil Ltda. (048130) Avenida Dom Pedro 1, W7777 12091-000 D.I.Piracangagua II, Taubate-SP BRAZIL
Product	Notebook Computer
Model	(1)15Z95P (2)15ZB95P (3)15ZD95P (4)15ZG95P (5)15ZC95P The difference between all models is different in the sales customers.
Brand	LG

3.2. Description of EUT

Test Model	15Z95P		
Serial Number	N/A		
Power Rating	DC 20V, 3.25A		
RF Features	WLAN:802.11 a/b/g/n/ac/ax Bluetooth: BT and BLE (BT 5.0)		
Transmit Type	2.4 GHz		
	802.11b		1T1R
	802.11g		1T1R
	802.11n-HT20		2T2R
	802.11n-HT40		2T2R
	802.11ax-HE20		2T2R
	802.11ax-HE40		2T2R
	BT/BLE		1T1R
	U-NII Bands		
	802.11a		1T1R
	802.11n-HT20/802.11ac-VHT20/802.11ax-HE20		2T2R
	802.11n-HT40/802.11ac-VHT40/802.11ax-HE40		2T2R
	802.11ac-VHT80/802.11ax-HE80		2T2R
	802.11ac-VHT160/802.11ax-HE160		2T2R
	The MIMO is uncorrelated and supported SDM mode only.		
Test Sample	Sample No.	Test Item	Firmware
	01	AC Conduction, RSE, Output Power	N/A
	02	AC Conduction, Output Power	N/A
Sample Status	Mass production		
Date of Receipt	2021. 08. 06		
Date of Test	2021. 08. 05 ~ 19		
Interface Ports of EUT	<ul style="list-style-type: none"> • One Micro SD Card Slot • One Earphone Port • Two USB 3.0 Ports • Two USB Type C Ports • One HDMI Port 		
Accessories Supplied	<ul style="list-style-type: none"> • AC Adapter • LAN Gender 		

3.3. Antenna Information

No.	Antenna Part Number	Manufacture	Antenna Type	Frequency (MHz)	Max Gain(dBi)
1.	WA-P-LELE-04-002 (Main)	INPAQ	Mono-Pole	2400~2500	5.0
				5100-5250	3.8
				5250-5350	3.8
				5350-5750	2.4
				5750~5850	2.7
	WA-P-LELE-04-002 (AUX)	INPAQ	Mono-Pole	2400~2500	5.7
				5100-5250	3.8
				5250-5350	3.8
				5350-5750	2.4
				5750~5850	2.7
2	L1LRF004-CS-H (Main)	LUXSHARE- ICT	Mono-Pole	2400~2500	1.8
				5150-5250	2.0
				5250-5350	2.2
				5350-5725	2.8
				5725~5850	2.2
	L1LRF004-CS-H (AUX)	LUXSHARE- ICT	Mono-Pole	2400~2500	1.6
				5150-5250	2.0
				5250-5350	2.0
				5350-5725	2.6
				5725~5850	2.7

3.4. EUT Specifications Assessed in Current Report

Mode	Fundamental Range (MHz)	Channel Number	Modulation	Data Rate (Mbps)
802.11b	2412-2472	13	DSSS (DBPSK/DQPSK/CCK)	Up to 11
802.11g		13	OFDM (BPSK/QPSK/16QAM/64QAM)	Up to 54
802.11n-HT20				Up to 144.4
802.11n-HT40	2422-2462	9	OFDM (BPSK/QPSK/16QAM/64QAM)	Up to 300
802.11ax-HE20	2412-2472	13	OFDMA (BPSK/ QPSK/ 16QAM/ 64QAM/ 256QAM/1024QAM)	Up to 287
802.11ax-HE40	2422-2462	9		Up to 574
BLE	2402-2480	40	GFSK (1M, 2M, PHY Coded S8, PHY Coded S2)	Up to 2

Channel List			
802.11 b/g/n-HT20/ax-HE20		802.11n-HT40/ax-HE40	
Channel Number	Frequency (MHz)	Channel Number	Frequency (MHz)
1	2412	3	2422
2	2417	4	2427
3	2422	5	2432
4	2427	6	2437
5	2432	7	2442
6	2437	8	2447
7	2442	9	2452
8	2447	10	2457
9	2452	11	2462
10	2457	---	
11	2462		
12	2467		
13	2472		

Channel List							
BLE							
Channel Number	Frequency (MHz)	Channel Number	Frequency (MHz)	Channel Number	Frequency (MHz)	Channel Number	Frequency (MHz)
37	2402	09	2422	18	2442	28	2462
00	2404	10	2424	19	2444	29	2464
01	2406	38	2426	20	2446	30	2466
02	2408	11	2428	21	2448	31	2468
03	2410	12	2430	22	2450	32	2470
04	2412	13	2432	23	2452	33	2472
05	2414	14	2434	24	2454	34	2474
06	2416	15	2436	25	2456	35	2476
07	2418	16	2438	26	2458	36	2478
08	2420	17	2440	27	2460	39	2480

3.5. Descriptions of Key Components

3.5.1. For the All Component Lists

Item	Supplier	Model / Type	Character
System	Microsoft	Win10 Home	---
		Win10 Pro	---
		Win11 Home	---
Main Board	LG	Blanc MAIN B/D PCB	Manufacturer: #1 Hannstar Board Tech(Jiang Yin) Corp.,Ltd. #2 Elec & Eltek Company (MCO) Limited.
		1xZ90P MAIN B/D PCB	
WLAN SUB Board	LG	15/16Z90P SUB B/D	Manufacturer: #1 Hannstar Board Tech(Jiang Yin) Corp.,Ltd. #2 Elec & Eltek Company (MCO) Limited. #3 JiangSu HuaShen Electronic co.,ltd (HXF)
CPU (Socket: FCBGA1449)	Intel	i7-1195G7	2.9GHz
	Intel	i5-1155G7	2.5GHz
15" LCD Panel	LG Display	LP156WFD(SP)(Y1)	Resolution: 1920 x 1080, 60Hz WQXGA IPS (Touch)
	LG Display	LP156WFC(SP)(Y1)	Resolution: 1920 x 1080, 60Hz WQXGA IPS (Non Touch)
Storage (SSD)	SK hynix	HFM256GD3JX013N	256GB (M.2)
		HFM512GD3JX013N	512GB (M.2)
		HFM001TD3JX013N	1TB (M.2)
Memory (RAM)	Samsung	---	16GB LPDDR4x(On Board)
	Samsung	---	8GB LPDDR4x(On Board)
	SK Hynix	---	16GB LPDDR4x(On Board)
	SK Hynix	---	8GB LPDDR4x(On Board)
	SK Hynix	---	32GB LPDDR4x(On Board)
Battery Pack	LG	LBV7227E	80Wh, DC 7.74V, 80Wh Typ 10336mAh
WLAN Combo Card	Intel	AX201D2W	WLAN and BT, 2x2 CNVi 1216 FCC ID: PD9AX201NG IC: 1000M-AX201NG NCC ID: CCAH18LP3410T5
WLAN Combo Antenna	LG (INPAQ)	WA-P-LELE-04-002	PCB, Mono-pole Type Main: Black, Aux: Gray
	LG (LUXSHARE-ICT)	L1LRF004-CS-H	PCB, Mono-pole Typ Main: Black, Aux: Gray

Item	Supplier	Model / Type	Character
Keyboard	TIC	KT0120B9	---
	LITE ON	SN8002	---
Web Camera	Chicony	CKFKH33-0	---
	Luxvisions	0BF108N3	---
LAN Gender (Type C to LAN)	SUZHOU MEC ELECTRONICS	80-5946-111	(White) 10/100 Megabit Ethernet
		80-5946-101	(Black) 10/100 Megabit Ethernet
	Type C to LAN: Shielded, Undetached, 0.12m		
	ARIN TECH CO. LTD	GD-08MF-36-WH-LP10	(White) 10/100 Megabit Ethernet
		GD-08MF-36-BK-LP11	(Black) 10/100 Megabit Ethernet
	Type C to LAN: Shielded, Undetached, 0.12m		
	SUZHOU MEC ELECTRONICS	80-5946-200	(White) 10/100/1000 Megabit Ethernet
		80-5946-210	(Black) 10/100/1000 Megabit Ethernet
Type C to LAN: Shielded, Undetached, 0.13m			
AC Adapter (65W)	LG (HONOR)	ADT-65DSU-D03-2	I/P: AC 100-240V, 1.6A, 50-60Hz O/P: DC 20V, 3.25A
	DC Power Cord: Non-Shielded, Undetached, 1.5m		
	AC Power Cord: Non-Shielded, Detached, 1.0m (2C) (For Other Countries) AC Power Cord: Non-Shielded, Detached, 1.55m (2C) (For US, Canada, Mexico)		

Remark: For more detailed features description, please refer to the manufacturer's specifications or the user manual.

3.5.2. The EUT collocates with following worst components, which are used to establish a basic configuration of system during test:

SKU		#1	#2
Main Board	LG, Blanc MAIN B/D PCB	V	V
WLAN SUB Board	LG, 15/16Z90P SUB B/D	V	V
CPU	Intel, i7-1195G7	V	V
15" LCD Panel	LG Display, LP156WFD(SP)(Y1)(Touch)	V	V
Storage (SSD)	SK Hynix, 1TB *2	V	V
Memory (RAM)	SK Hynix, 32GB	V	V
Battery Pack	LG, LBV7227E	V	V
WLAN Combo Card	Intel, AX201D2W	V	V
WLAN Combo Antenna	LG (INPAQ), WA-P-LELE-04-002	V	
	LG (LUXSHARE-ICT), L1LRF004-CS-H		V
Keyboard	TIC, KT0120B9	V	V
Web Camera	Chicony, CKFKH33-0	V	V
Type C Link to LAN Gender	SUZHOU MEC ELECTRONICS, 80-5946-111 (White)	V	
	ARIN TECH CO. LTD, GD-08MF-36-BK-LP11 (Black)		V
AC Adapter	LG (HONOR), ADT-65DSU-D03-2	V	V

3.6. Test Configuration

Mode	TX _{on} (ms)	1/ TX _{on} (kHz)	Duty Cycle (x)	Duty Cycle Factor [10log(1/x)] (dB)
802.11b	8.355	0.120	0.996	N/A
802.11g	2.080	0.481	0.981	N/A
802.11n-HT20	3.980	0.251	0.993	N/A
802.11n-HT40	3.950	0.253	0.992	N/A
802.11ax-HE20	3.960	0.253	0.992	N/A
802.11ax-HE40	3.930	0.254	0.992	N/A

Note: When duty cycle is less than 98% (0.98) that duty cycle factor 10log(1/x) is needed to add in conducted test items measured in average detector.

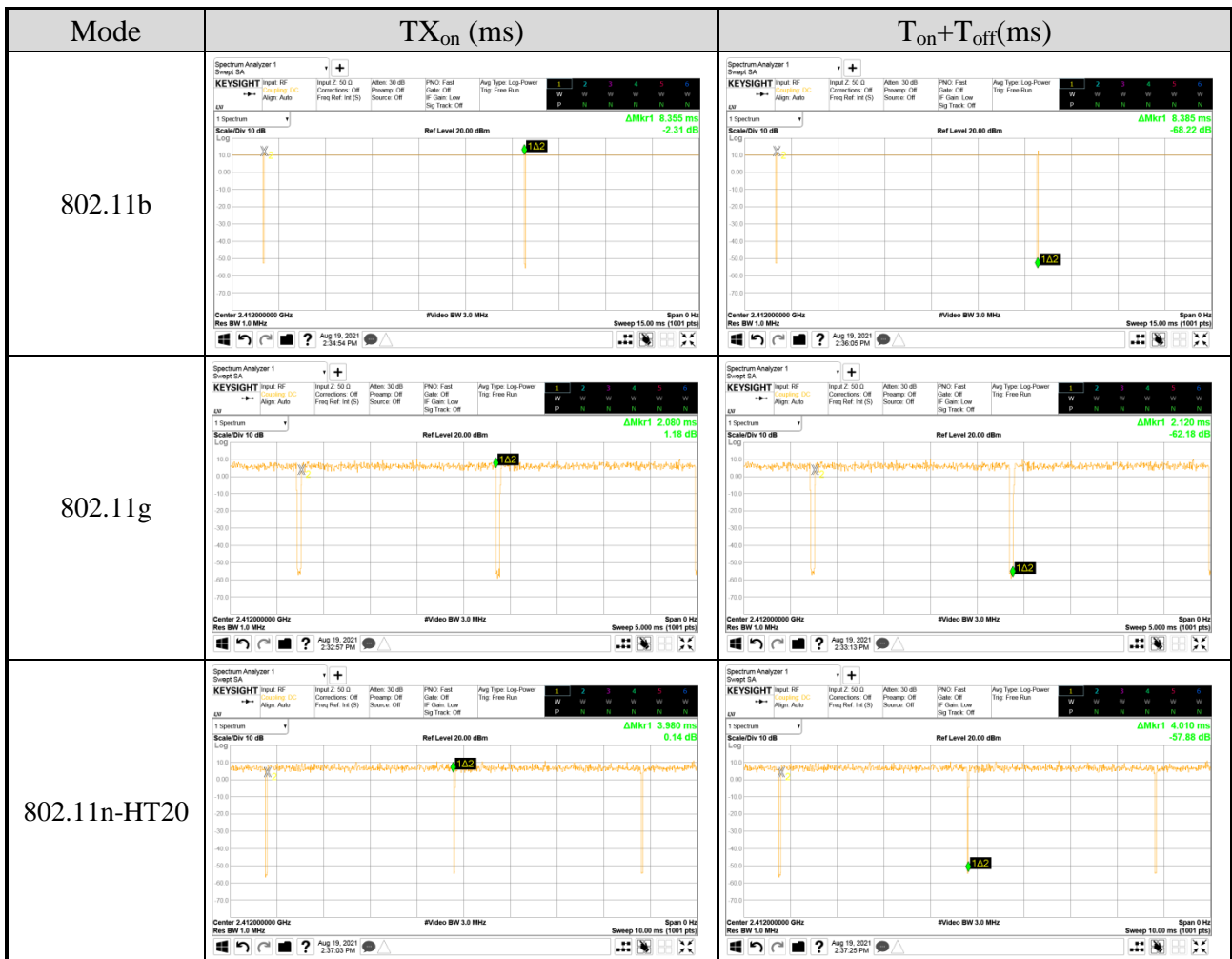



Mode	TX _{on} (ms)	1/ TX _{on} (kHz)	Duty Cycle (x)	Duty Cycle Factor [10log(1/x)] (dB)
BLE (2Mbps)	1.070	0.935	0.594	2.26

Note: When duty cycle is less than 98% (0.98) that duty cycle factor 10log(1/x) is needed to add in conducted test items measured in average detector.

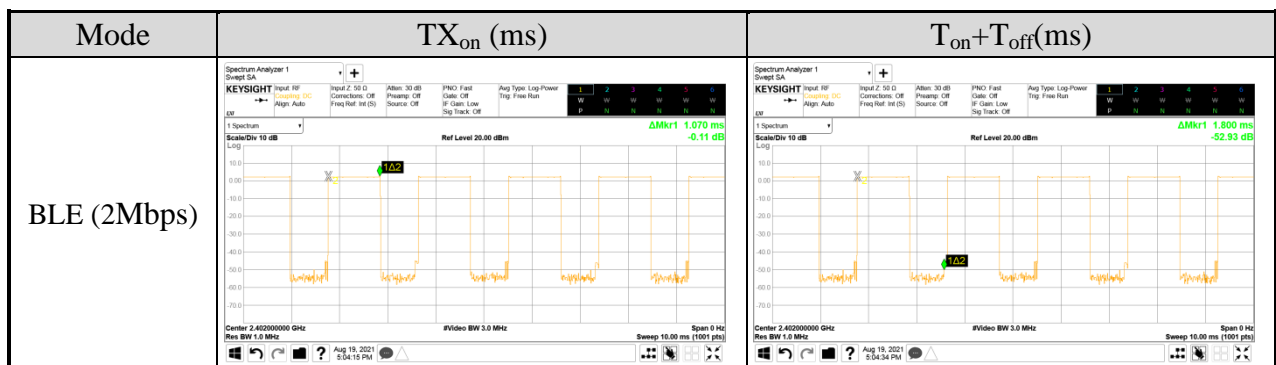

AC Conduction	
SKU #1	Normal operation (with INPAQ Antenna)
SKU #2	Normal operation (with LUXSHARE-ICT Antenna)

Item		Mode	Data Rate	Test Channel	
Radiated Test Case	SKU #1	Radiated Band Edge <small>Note 1 & 3</small>	802.11b	1Mbps	1/2/10/11/12/13
			802.11g	6Mbps	1/2/10/11/12/13
			802.11n-HT20	MCS8	1/2/10/11/12/13
			802.11n-HT40	MCS8	3/4/8/9/10/11
			802.11ax-HE20	HE0	1/2/10/11/12/13
			802.11ax-HE40	HE0	3/4/8/9/10/11
			BLE	2Mbps	37/39
		Radiated Spurious Emission <small>Note 1 & 2 & 3</small>	802.11b	1Mbps	7
			802.11g	6Mbps	7
			802.11n-HT20	MCS8	7
			802.11n-HT40	MCS8	7
			802.11ax-HE20	HE0	7
			802.11ax-HE40	HE0	7
			BLE	2Mbps	37/17/39

Item		Mode	RU Config	Test Channel	
Radiated Test Case	SKU #1	Radiated Band Edge <small>Note 1 & 3</small>	802.11ax-HE20	26/0	1
				52/37	
				106/53	
				26/8	13
				52/40	
				106/54	
			802.11ax-HE40	242/61	3
				242/62	11

Item		Mode	Data Rate	Test Channel
Conducted Test Case	6dB/Occupied Bandwidth (Data Reused)	802.11b	1Mbps	1/7/11/13
		802.11g	6Mbps	1/7/11/13
		802.11n-HT20	MCS8	1/7/11/13
		802.11n-HT40	MCS8	3/7/9/11
		802.11ax-HE20	HE0	1/7/11/13
		802.11ax-HE40	HE0	3/7/9/11
		BLE	1Mbps	37/17/39
	Peak Output Power (SPOT Check)	802.11b	1Mbps	1/2/7/10/11/12/13
		802.11g	6Mbps	1/2/7/10/11/12/13
		802.11n-HT20	MCS8	1/2/7/10/11/12/13
		802.11n-HT40	MCS8	3/4/7/8/9/10/11
		802.11ax-HE20	HE0	1/2/7/10/11/12/13
		802.11ax-HE40	HE0	3/4/7/8/9/10/11
		BLE	1Mbps	37/17/39
			2Mbps	37/17/39
			PHY Coded S2	37/17/39
	Band Edge (Data Reused)	802.11b	1Mbps	1/11/13
		802.11g	6Mbps	1/11/13
		802.11n-HT20	MCS8	1/11/13
		802.11n-HT40	MCS8	3/9/11
		802.11ax-HE20	HE0	1/11/13
		802.11ax-HE40	HE0	3/9/11
		BLE	1Mbps	37/39
	Spurious Emission (Data Reused)	802.11b	1Mbps	1/7/11/13
		802.11g	6Mbps	1/7/11/13
		802.11n-HT20	MCS8	1/7/11/13
		802.11n-HT40	MCS8	3/7/9/11
		802.11ax-HE20	HE0	1/7/11/13
		802.11ax-HE40	HE0	3/7/9/11
		BLE	1Mbps	37/17/39
Peak Power Spectral Density (Data Reused)	802.11b	1Mbps	1/7/11/13	
	802.11g	6Mbps	1/7/11/13	
	802.11n-HT20	MCS8	1/7/11/13	
	802.11n-HT40	MCS8	3/7/9/11	
	802.11ax-HE20	HE0	1/7/11/13	
	802.11ax-HE40	HE0	3/7/9/11	
	BLE	1Mbps	37/17/39	

Item		Mode	Data Rate	RU Configuration	Test Channel
Conducted Test Case	6dB/Occupied Bandwidth (Data Reused)	802.11ax-HE20	HE0	26/0	1
				52/37	
				106/53	
		802.11ax-HE40	HE0	26/8	13
				52/40	
				106/54	
	Peak Output Power (SPOT Check)	802.11ax-HE20	HE0	26/0	1
				52/37	
				106/53	
		802.11ax-HE40	HE0	26/8	13
				52/40	
				106/5	
	Peak Power Spectral Density (Data Reused)	802.11ax-HE20	HE0	26/0	1
				52/37	
				106/53	
		802.11ax-HE40	HE0	26/8	13
				52/40	
				106/54	
802.11ax-HE40	HE0	242/61	3		
	HE0	242/62	11		

Note 1: Mobile Device

Portable Device, and 3 axis were assessed. The worst scenario for Radiated Spurious Emission as follow: Lie Side Stand

Note 2: Low, mid, and high channels were measured, only the worst channel of each modulation was presented in this report.

Note 3: Both of the antennas are the same type, and we presented the worst case in the report. The max-gain condition with SISO (main port) and MIMO is SKU 1. The MIMO is uncorrelated and supported SDM mode only.

Note 4: The modulation and bandwidth are similar for 802.11n mode for HT20/HT40 and 802.11ac mode for VHT20/VHT40, therefore investigated worst case to representative mode in the test report.

Note 5: The data rates were selected based on preliminary testing that identified rate as the worst case for output power.

3.7. Output Power Setting

SPOT CHECK

Mode	Centre Frequency (MHz)	Power Setting		Mode	Centre Frequency (MHz)	Power Setting	
		Chain 0 (AUX)	Chain 1 (Main)			Chain 0 (AUX)	Chain 1 (Main)
802.11b	2412	19.00	19.00	802.11g	2412	16.50	16.50
	2417	20.00	20.00		2417	18.00	18.00
	2442	20.00	20.00		2442	20.00	20.00
	2457	20.00	20.00		2457	18.25	18.25
	2462	19.00	19.00		2462	17.50	17.50
	2467	18.00	18.00		2467	14.50	14.50
	2472	12.25	12.25		2472	1.00	1.00

Mode	Centre Frequency (MHz)	Power Setting	Mode	Centre Frequency (MHz)	Power Setting
802.11n-HT20	2412	13.50	802.11n-HT40	2422	13.00
	2417	15.00		2427	12.00
	2442	17.00		2442	14.00
	2457	15.25		2447	14.25
	2462	14.50		2452	12.50
	2467	11.50		2457	9.00
	2472	-2.00		2462	1.50

Mode	Centre Frequency (MHz)	Power Setting	Mode	Centre Frequency (MHz)	Power Setting
802.11ax-HE20	2412	13.50	802.11ax-HE40	2422	13.00
	2417	15.00		2427	12.00
	2442	17.00		2442	14.00
	2457	15.25		2447	14.25
	2462	14.50		2452	12.50
	2467	11.50		2457	9.00
	2472	-2.00		2462	1.50

Mode	RU Configuration	Centre Frequency (MHz)	Power Setting
802.11ax-HE20	26/0	2412	13.5
	52/37		13.5
	106/53		13.5
	26/0	2472	-3.5
	52/37		-3.5
	106/53		-3.5
802.11ax-HE40	242/61	2422	13.0
	242/62	2467	1.0

Mode	Centre Frequency (MHz)	Power Setting			
		1M	2M	PHY Coded S2	PHY Coded S8
BLE	2402	4	4	4	4
	2440	4	4	4	4
	2480	4	4	4	4

3.8. Tested Supporting System List

3.8.1. Support Peripheral Unit

No.	Product	Brand	Model No.	Serial No.	Approval
1.	TV	LG	22LK330-DB	N/A	N/A
2.	USB Mouse	Beauty	A11	N/A	FCC By DoC
3.	Earphone	APPLE	N/A	N/A	N/A
4.	SD Card	ADATA	MicroSDHC Card	N/A	N/A
Partner System					
5.	AP Server	ASUS	RT-AX88U	N/A	FCC ID: MSQ-RTAXHP00 IC: 3568A-RTAXHP00

3.8.2. Cable Lists

No.	Cable Description Of The Above Support Units
1.	HDMI Cable: Shielded, Detachable, 1.8m AC Power Cord: Unshielded, Detachable, 1.8m
2.	USB Cable: Unshielded, Undetachable, 1.8m
3.	Earphone Cable: Unshielded, Undetachable, 0.9m
4.	N/A
5.	AC adapter: M/N:WA-30B12, Cable: Unshielded, Detachable, 1.2m LAN cable: Unshielded, Detachable, 3.0m
6.	LAN cable: Unshielded, Detachable, 1.8m

3.9. Setup Configuration

3.9.1. EUT Configuration for Power Line & Radiated Emission

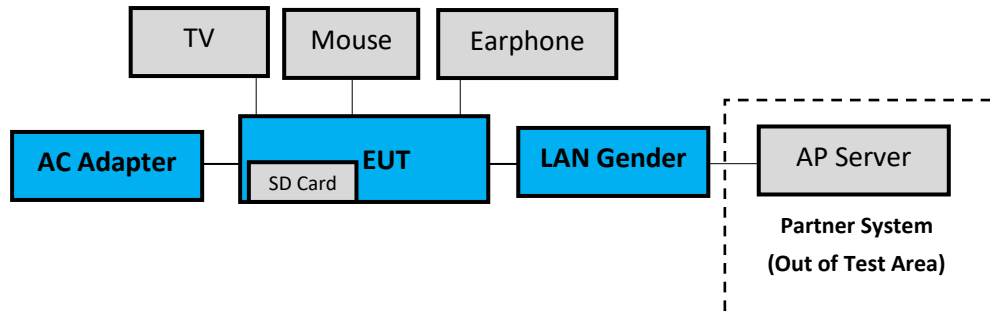

3.9.2. EUT Configuration for RF Conducted Test Items

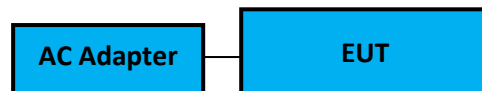

3.10. Operating Condition of EUT

Test program “DRTU” is used for enabling EUT BT or WLAN function under continues transmitting and choosing data rate/ channel.

[Chain 0 is aux port (A Button in DRTU) Chain 1 is main port (B Button in DRTU)].

3.11. Description of Test Facility

Name of Test Firm	Audix Technology Corporation / EMC Department No. 491, Zhongfu Rd., Linkou Dist., New Taipei City 244, Taiwan Tel: +886-2-26092133 Fax: +886-2-26099303 Website : www.audixtech.com Contact e-mail: attemc_report@audixtech.com
Accreditations	The laboratory is accredited by following organizations under ISO/IEC 17025:2017 (1) NVLAP(USA) NVLAP Lab Code 200077-0 (2) TAF(Taiwan) No. 1724
Test Facilities	FCC OET Designation Number under APEC MRA by NCC is : TW1724 ISED CAB Identifier Number under APEC TEL MRA by NCC is TW1724 (1) No.8 Shielded Room (2) No.3 3m Semi Anechoic Chamber (3) Fully Anechoic Chamber

3.12.Measurement Uncertainty

Test Items/Facilities		Frequency Range	Uncertainty		
Conduction Test		9kHz-150kHz	±3.7dB		
		150kHz-30MHz	±3.4dB		
Radiation Test	<input type="checkbox"/>	No.1 3m Semi Anechoic Chamber	30MHz-200MHz, 3m, Horizontal	±3.8dB	
			200MHz-1000MHz, 3m, Horizontal	±4.1dB	
			30MHz-200MHz, 3m, Vertical	±4.5dB	
			200MHz-1000MHz, 3m, Vertical	±4.5dB	
			1GHz-6GHz, 3m	±4.7dB	
			6GHz-18GHz, 3m	±4.1dB	
		<input checked="" type="checkbox"/>	No.3 3m Semi Anechoic Chamber	30MHz-200MHz, 3m, Horizontal	±3.9dB
			200MHz-1000MHz, 3m, Horizontal	±4.2dB	
			30MHz-200MHz, 3m, Vertical	±4.3dB	
			200MHz-1000MHz, 3m, Vertical	±4.5dB	
		<input type="checkbox"/>	No.4 3m Semi Anechoic Chamber	30MHz-200MHz, 3m, Horizontal	±4.1dB
			200MHz-1000MHz, 3m, Horizontal	±4.5dB	
			30MHz-200MHz, 3m, Vertical	±4.4dB	
			200MHz-1000MHz, 3m, Vertical	±4.8dB	
			1GHz-6GHz, 3m	±5.0dB	
			6GHz-18GHz, 3m	±4.7dB	
		<input type="checkbox"/>	No.5 3m Semi Anechoic Chamber	30MHz-200MHz, 3m, Horizontal	±4.2dB
			200MHz-1000MHz, 3m, Horizontal	±4.3dB	
			30MHz-200MHz, 3m, Vertical	±4.3dB	
			200MHz-1000MHz, 3m, Vertical	±4.7dB	
	1GHz-6GHz, 3m		±4.8dB		
	6GHz-18GHz, 3m		±4.5dB		
	<input checked="" type="checkbox"/>	Fully Anechoic Chamber	30MHz~1000MHz	±4.6dB	
			1GHz~18GHz	±5.4dB	
			18GHz~40GHz	±3.52dB	
			40GHz~260GHz	±3.56dB	

Remark : Uncertainty = $ku_c(y)$

Test Item	Uncertainty
6dB Bandwidth	± 0.05kHz
Maximum peak output power	± 0.33dB
Power spectral density	± 0.13dB
Conducted Emission Limitations	± 0.13dB

4. MEASUREMENT EQUIPMENT LIST

4.1. Conducted Emission Measurement

Item	Type	Manufacturer	Model No.	Serial No.	Cal. Date	Cal. Interval
1.	Test Receiver	R&S	ESR3	101774	2021. 02. 02	1 Year
2.	A.M.N.	R&S	ENV432	101567	2021. 04. 21	1 Year
3.	L.I.S.N.	Kyoritsu	KNW-407	8-855-9	2020. 12. 10	1 Year
4.	Pulse Limiter	R&S	ESH3-Z2	100354	2021. 01. 04	1 Year
5.	Digital Thermo-Hygro Meter	iMax	HTC-1	No.8 S/R	2021. 04. 15	1 Year
6.	Coaxial Cable	Yeida	RG/58AU	CE-08	2020. 09. 19	1 Year
7.	Test Software	Audix	e3	V6.120619c	N.C.R.	N.C.R.

4.2. Radiated Emission Measurement

Item	Type	Manufacturer	Model No.	Serial No.	Cal. Date	Cal. Interval
1.	Spectrum Analyzer	Agilent	N9010A-526	MY52220368	2020. 11. 19	1 Year
2.	Spectrum Analyzer	Agilent	N9030A-526	MY53310269	2021. 01. 14	1 Year
3.	Spectrum Analyzer	Keysight	N9010B-544	MY55460198	2021. 04. 14	1 Year
4.	Test Receiver	R&S	ESCI7	100923	2021. 03. 09	1 Year
5.	Amplifier	HP	8447D	2944A06669	2021. 04. 28	1 Year
6.	Microwave Preamplifier	Agilent	8449B	3008A02678	2021. 02. 19	1 Year
7.	Microwave Amplifier	Keysight	83051A	MY53010042	2021. 07. 30	1 Year
8.	Microwave Amplifier	Agilent	8449B	3008A02678	2021. 02. 27	1 Year
9.	Loop Antenna	R&S	HFH2-Z2	891847/27	2019. 12. 26	2 Years
10.	Bilog Antenna	TESEQ	CBL6112D	33820	2021. 07. 16	1 Year
11.	Horn Antenna	EMCO	3115	9609-4927	2021. 07. 02	1 Year
12.	Double-Ridged Waveguide Horn	ETS-Lindgren	3117	00135902	2021. 03. 19	1 Year
13.	Horn Antenna	COM-POWER	AH-840	101092	2021. 01. 05	1 Year
14.	2.4GHz Notch Filter	K&L Microwave	7NSL10-244 1.5/E130.5- O/O	2	2021 .07. 24	1 Year
15.	3GHz Notch Filter	Microwave	H3G018G1	484796	2021 .07. 24	1 Year
16.	Coaxial Cable	HUBER+SUHNER	S07212BD	RE-16	2021. 05. 17	1 Year
17.	Coaxial Cable	HUBER+SUHNER	SUCOFLEX 104	RE-29	2020. 09. 19	1 Year
18.	Coaxial Cable	HUBER+SUHNER	SUCOFLEX 102	RE-30	2020. 09. 19	1 Year
19.	Digital Thermo-Hygro Meter	iMax	HTC-1	No.3 3m A/C	2021. 04. 15	1 Year
20.	Digital Thermo-Hygro Meter	Shenzhen Datronn Electronics	KT-905	RF	2021. 04. 15	1 Year
21.	Test Software	Audix	e3	V6.120619c	N.C.R.	N.C.R.
22.	Test Software	Audix	e3	V6.110601	N.C.R.	N.C.R.

4.3. RF Conducted Measurement

Item	Type	Manufacturer	Model No.	Serial No.	Cal. Date	Cal. Interval
1.	Spectrum Analyzer	Keysight	N9020B-544	MY57120357	2021. 01. 06	1 Year
2.	Power Meter	Anritsu	ML2487A	6K00005406	2021. 04. 28	1 Year
3.	Power Sensor	Anritsu	MA2491A	030873	2021. 04. 28	1 Year
4.	Digital Thermo-Hygro Meter	iMax	HTC-1	RF-03	2021. 04. 15	1 Year

5. CONDUCTED EMISSION

5.1. Block Diagram of Test Setup

5.1.1. Block Diagram of EUT

Indicated as section 3.9

5.1.2. Shielded Room Setup Diagram

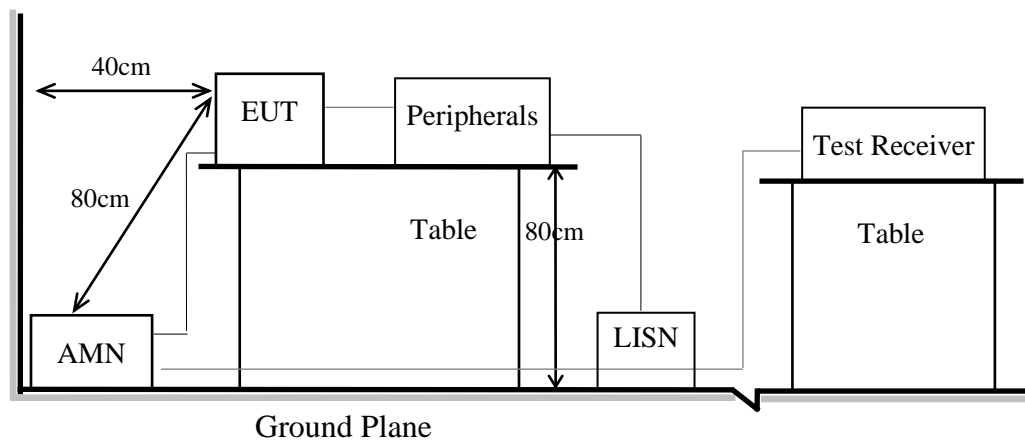

5.2. Conducted Emission Limit

Frequency	Conducted Limit	
	Quasi-Peak Level	Average Level
150kHz ~ 500kHz	66 ~ 56 dB μ V	56 ~ 46 dB μ V
500kHz ~ 5MHz	56 dB μ V	46 dB μ V
5MHz ~ 30MHz	60 dB μ V	50 dB μ V

Remark1.: If the average limit is met when using a Quasi-Peak detector, the measurement using the average detector is not required.

2.: The lower limit applies to the band edges.

5.3. Test Procedure

- 5.3.1. To set up the EUT as indicated in ANSI C63.10. The EUT was placed on the table which has 80 cm height to the ground and 40 cm distance to the conducting wall.
- 5.3.2. Power supplier of the EUT was connected to the AC mains through an Artificial Mains Network (A.M.N.).
- 5.3.3. The AC power supplies to all peripheral devices must be provided through line impedance stabilization network (L.I.S.N.)
- 5.3.4. Checking frequency range from 150kHz to 30 MHz and record the emission which does not have 20 dB below limit.

5.4. Test Results

Please refer to Appendix A.

6. RADIATED EMISSION

6.1. Block Diagram of Test Setup

6.1.1. Block Diagram of EUT

Indicated as section 3.9

6.1.2. Setup Diagram for 9kHz-30MHz

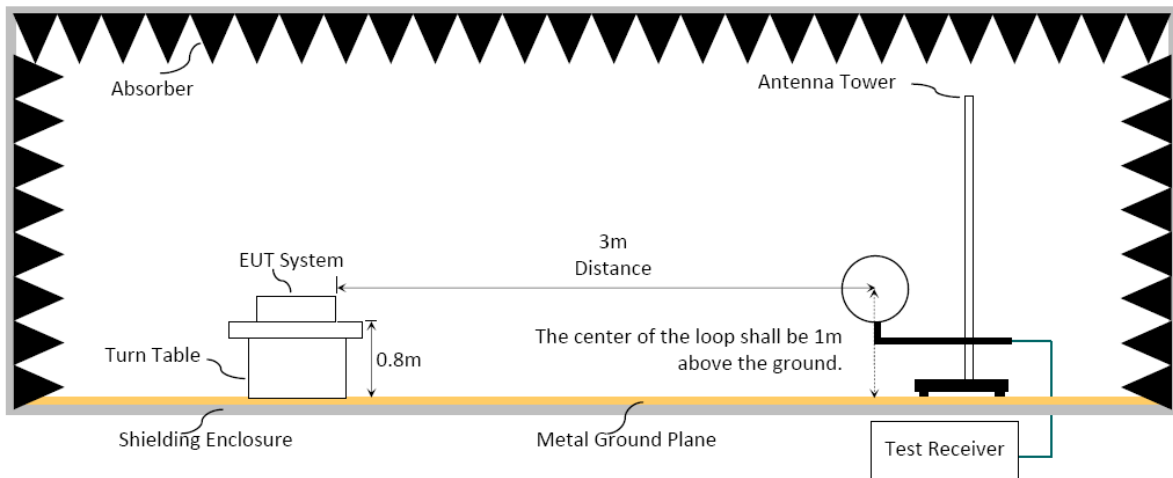

6.1.3. Setup Diagram for 30-1000MHz

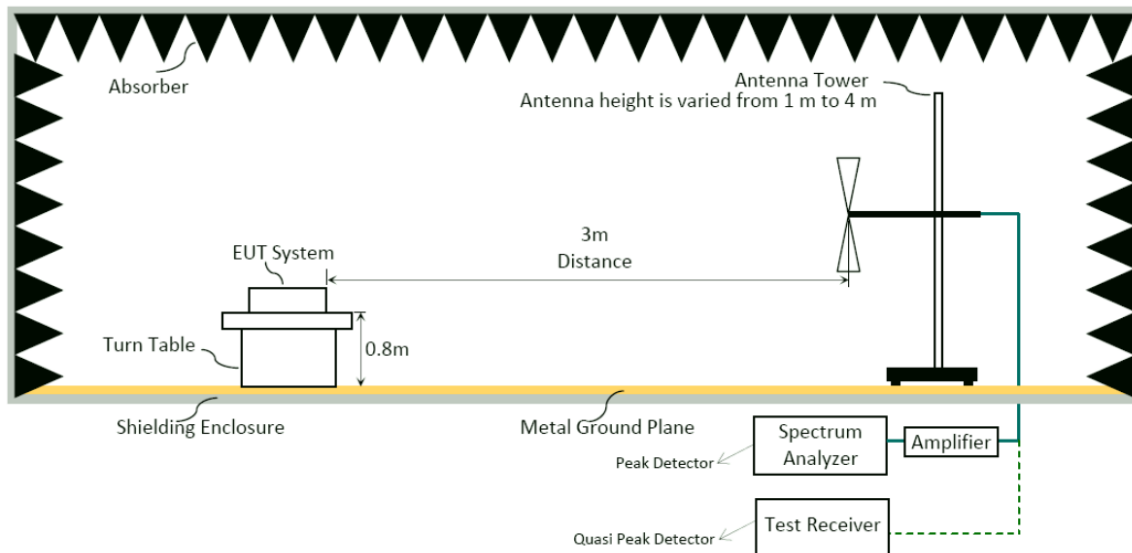

6.1.4. Setup Diagram for above 1GHz

Fully Anechoic Chamber

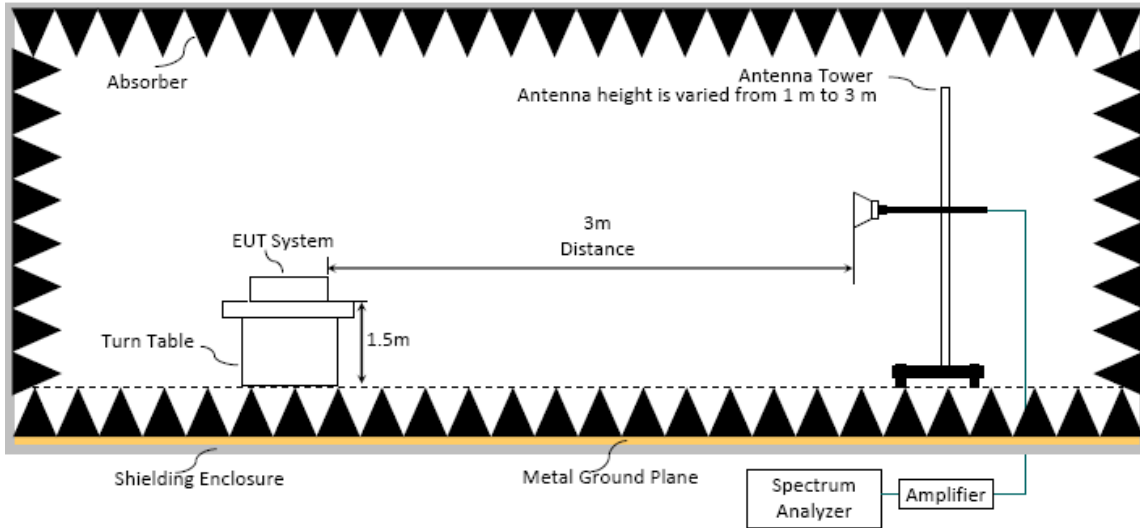

Semi Anechoic Chamber

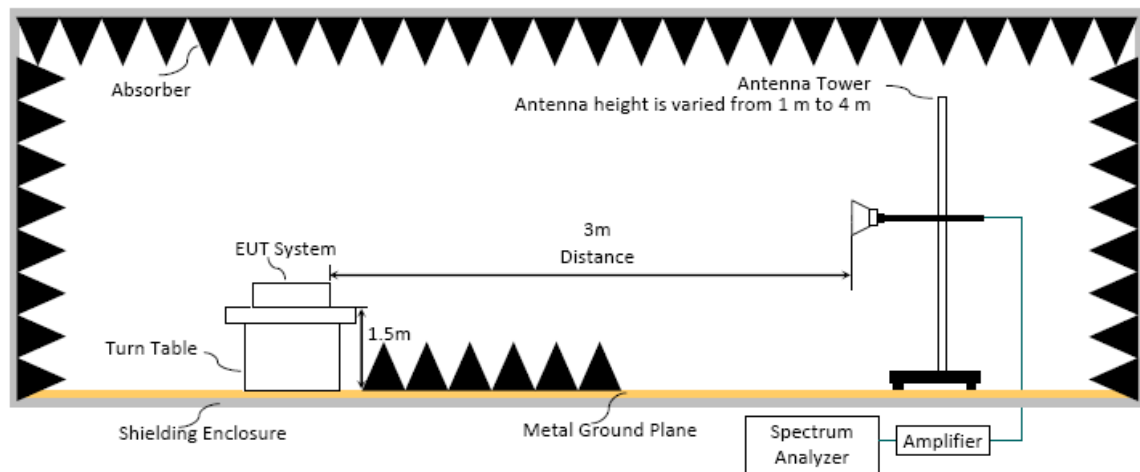

6.2. Radiated Emission Limits

In any 100kHz bandwidth outside the frequency band, the radio frequency power produced by the intentional radiator shall be at least 20dB below that in the 100kHz bandwidth within the band that contains the highest level. In addition, radiated emissions which fall in restricted bands, as defined in Section 15.205/RSS-Gen Section 8.10 table 6, must also comply with the radiated emission limits specified as below.

Frequency (MHz)	Distance(m)	Limits	
		dB μ V/m	μ V/m
0.009 - 0.490	300	67.6-20 log f(kHz)	2400/f kHz
0.490 - 1.705	30	87.6-20 log f(kHz)	24000/f kHz
1.705 - 30	30	29.5	30
30 - 88	3	40.0	100
88- 216	3	43.5	150
216- 960	3	46.0	200
Above 960	3	54.0	500
Above 1000	3	74.0 dB μ V/m (Peak) 54.0 dB μ V/m (Average)	

Remark : (1) dB μ V/m = 20 log (μ V/m)

- (2) The tighter limit applies to the edge between two frequency bands.
- (3) Distance refers to the distance in meters between the measuring instrument antenna and the closed point of any part of the device or system.
- (4) Fundamental and emission fall within operation band are exempted from this section.
- (5) Pursuant to ANSI C63.10: 6.6.4.3, if the maximized peak measured value complies with the average limit, then it is unnecessary to perform an average measurement.

6.3. Test Procedure

Frequency Range 9kHz~30MHz:

The EUT setup on the turntable which has 0.8 m height to the ground. The turn table rotated 360 degrees and antenna fixed to 1 m to find the maximum emission level. In order to find the maximum emission, all of the interface cables were manipulated according to ANSI C63.10-2013 regulation.

- (1) RBW = 9kHz with peak and average detector.
- (2) Detector: average and peak (9kHz-490kHz)
Q.P. (490kHz-30MHz)

Frequency Range 30MHz ~ 25GHz:

The EUT setup on the turn table which has 80cm (for 30-1000MHz) and 1.5m (for above 1GHz) height to the ground. The turn table rotated 360 degrees and antenna varied from 1 m to 4 m (for 30-1000MHz) and from 1m to 3m (for above 1GHz at fully Anechoic Chamber) or from 1 m to 4 m (for above 1GHz at Semi Anechoic Chamber) to find the maximum emission level. Both horizontal and vertical polarization are required. In order to find the maximum emission, all of the interface cables were manipulated according to ANSI C63.10-2013 regulation.

Frequency below 1GHz:

Spectrum Analyzer is used for pre-testing with following setting:

- (1) RBW = 120KHz
- (2) VBW $\geq 3 \times$ RBW.
- (3) Detector = Peak.
- (4) Sweep time = auto.
- (5) Trace mode = max hold.
- (6) Allow sweeps to continue until the trace stabilizes.

Note 1: When peak-detected value is lower than limit that the measurement using the Q.P. detector is not required, otherwise using Q.P. for final measurement.

Note 2: When the radiated emissions limits are expressed in terms of the average value of the emissions, and pulsed operation is employed, the measurement field strength shall be determined by averaging over one complete pulse train, including blanking intervals, as long as the pulse train does not exceed 0.1 seconds.

Frequency above 1GHz to 10th harmonic (up to 25 GHz):

Peak Detector:

- (1) RBW = 1MHz
- (2) VBW $\geq 3 \times$ RBW.
- (3) Detector = Peak.
- (4) Sweep time = auto.
- (5) Trace mode = max hold.
- (6) Allow sweeps to continue until the trace stabilizes.

Note: When peak-detected value is lower than limit that the measurement using the average detector is not required, otherwise using average detector for final measurement.

Average Detector:

Option 1:

- (1) RBW = 1MHz
- (2) VBW \geq 1/ T.

Modulation Type	T (ms)	1/ T (kHz)	VBW Setting(Hz)
BLE (2Mbps)	1.070	0.935	1kHz
802.11b	8.355	0.120	10Hz
802.11g	2.080	0.481	10Hz
802.11n-HT20	3.980	0.251	10Hz
802.11n-HT40	3.950	0.253	10Hz
802.11ax-HE20	3.960	0.253	10Hz
802.11ax-HE40	3.930	0.254	10Hz

N/A: 1/ T is not implemented when duty cycle presented in section 3.6 is \geq 98%.

- (1) Detector = Peak.
- (2) Sweep time = auto.
- (3) Trace mode = max hold.
- (4) Allow sweeps to continue until the trace stabilizes.

Option 2:

Average Emission Level = Peak Emission Level + D.C.C.F.

6.4. Measurement Result Explanation

- Peak Emission Level = Antenna Factor + Cable Loss + Meter Reading (including Preamp factor if test used)
- Average Emission Level = Antenna Factor + Cable Loss + Meter Reading (including Preamp factor if test used)
- Average Emission Level = Peak Emission Level + DCCF
Duty Cycle Correction Factor (DCCF) = $20\log(TX_{on}/TX_{on+off})$ presented in section 3.6
- ERP = Peak Emission Level - 95.2dB - 2.14dB

6.5. Test Results

Please refer to Appendix A.

7. 6dB OCCUPIED BANDWIDTH

7.1. Block Diagram of Test Setup

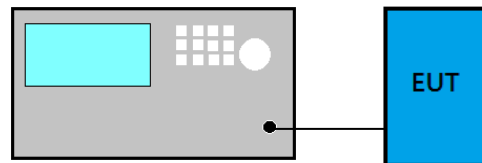

7.2. Specification Limits

The minimum 6dB bandwidth shall be at least 500kHz.

7.3. Test Procedure

Following measurement procedure is reference to ANSI C63.10:2013:

For 6dB Bandwidth

- (1) Set RBW = 100 kHz.
- (2) Set the video bandwidth (VBW) $\geq 3 \times$ RBW.
- (3) Detector = Peak.
- (4) Trace mode = max hold.
- (5) Sweep = auto couple.
- (6) Allow the trace to stabilize.
- (7) Setting channel bandwidth function x to -6dB power to record the final bandwidth..

For 99% Occupied Bandwidth

- (1) Set Span range 1.5~5 times the OBW
- (2) Set RBW close to 1% to 5% of OBW.
- (3) Set $VBW \geq 3 \times RBW$.
- (4) Detector = Peak.
- (5) Trace mode = Max hold
- (6) Sweep = Auto couple.
- (7) Allow the trace to stabilize.

7.4. Test Results

Please refer to Appendix A

8. MAXIMUM PEAK OUTPUT POWER

8.1. Block Diagram of Test Setup

- For WLAN Function

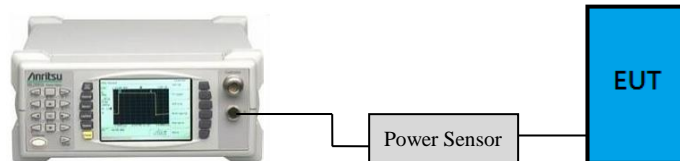

- For BLE Function

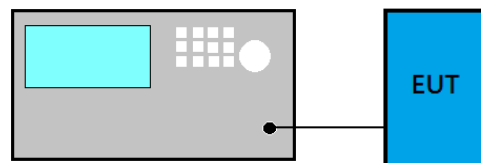

8.2. Specification Limits

The Limits of maximum Peak Output Power for digital modulation in 2400-2483.5MHz is : 1Watt. (30dBm), and E.I.R.P.: 4Watt (36dBm)

8.3. Test Procedure

Following measurement procedure is reference to ANSI C63.10:2013:

■ PKPM1 Peak power meter method:

EUT is connected to power sensor and record the maximum output power.

■ Maximum peak conducted output power method:

- (1) Set the RBW \geq DTS bandwidth
- (2) Set VBW $\geq 3 \times$ RBW
- (3) Set span $\geq 3 \times$ RBW.
- (4) Sweep time = auto couple
- (5) Detector = peak.
- (6) Trace mode = max hold.
- (7) Allow trace to fully stabilize.
- (8) Use peak marker function to determine the peak amplitude level.

■ Method AVGPM (Measurement using an RF average power meter):

EUT is connected to power sensor and record the maximum average output power and duty cycle factor is added when duty cycle presented in section 3.7 is $< 98\%$.

Method AVGSA-2 (Spectrum channel power)

- (1) Set span to at least 1.5 times the OBW
- (2) Set RBW = 1 -5% of OBW
- (3) Set the video bandwidth (VBW) $\geq 3 \times$ RBW.
- (4) Detector = RMS.
- (5) Trace mode = trace average at least 100 traces
- (6) Sweep = auto couple.
- (7) Compute power by integrating the spectrum across the OBW of the signal using the instrument's band power measurement function with band limits set equal to the OBW band edges.
- (8) Duty cycle factor is added when duty cycle presented in section 3.7 is $< 98\%$.

8.4. Test Results

Please refer to Appendix A

9. EMISSION LIMITATIONS

9.1. Block Diagram of Test Setup

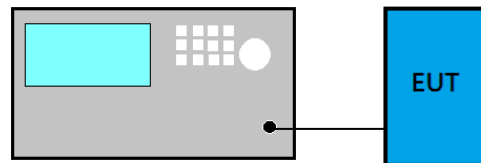

9.2. Specification Limits

In any 100kHz bandwidth outside the frequency band in which the spread spectrum or digitally modulated intentional radiator is operating, the radio frequency power that is produced by the intentional radiator shall be at least 20dB below that in the 100kHz bandwidth within the band that contains the highest level of the desired power, based on either an RF conducted or a radiated measurement. If the transmitter complies with the conducted power limits based on the use of RMS averaging over a time interval, that the required attenuation shall be 30 dB instead of 20 dB.

Attenuation below the general limits specified in Section 15.209(a)/RSS-Gen Section 8.9 table 4 is not required. In addition, radiated emissions which fall in restricted bands, as defined in Section 15.205(a)/RSS-Gen Section 8.10 table 6, must also comply with the radiated emission limits specified in Section 15.209(a)/RSS-Gen Section 8.9 table 4 (See Section 15.205(c)).

9.3. Test Procedure

Following measurement procedure is reference to ANSI C63.10:2013:

■ Reference Level

- (1) Set analyzer center frequency to DTS channel center frequency.
- (2) Set the span to 1.5 times the DTS bandwidth.
- (3) Set the RBW to: 100 kHz.
- (4) Set the VBW $\geq 3 \times$ RBW.
- (5) Detector = peak.
- (6) Sweep time = auto couple.
- (7) Trace mode = max hold.
- (8) Allow trace to fully stabilize to find the max PSD as reference level.

■ Emission Level Measurement

- (1) Set analyzer center frequency to DTS channel center frequency.
- (2) Set the span to 1.5 times the DTS bandwidth.
- (3) Set the RBW to: 100 kHz.
- (4) Set the VBW $\geq 3 \times$ RBW.
- (5) Detector = peak.
- (6) Sweep time = auto couple.
- (7) Trace mode = max hold.
- (8) Allow trace to fully stabilize to find the max level.

9.4. Test Results

Please refer to Appendix A

10. POWER SPECTRAL DENSITY

10.1. Block Diagram of Test Setup

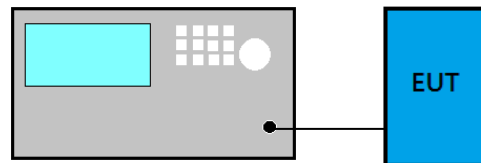

10.2. Specification Limits

The peak power spectral density conducted from the intentional radiator to the antenna shall not be greater than 8dBm in any 3kHz band.

10.3. Test Procedure

Following measurement procedure is reference to ANSI C63.10:2013:

■ Method PKPSD (peak PSD)

- (1) Set analyzer center frequency to DTS channel center frequency.
- (2) Set the span to 1.5 times the DTS bandwidth.
- (3) Set the RBW to: $3 \text{ kHz} \leq \text{RBW} \leq 100 \text{ kHz}$.
- (4) Set the VBW $\geq 3 \times \text{RBW}$.
- (5) Detector = peak.
- (6) Sweep time = auto couple.
- (7) Trace mode = max hold.
- (8) Allow trace to fully stabilize.
- (9) Use the peak marker function to determine the maximum amplitude level.
- (10) If measured value exceeds limit, reduce RBW (no less than 3 kHz) and repeat.

□ Method AVGPSD-2

- (1) Using peak PSD procedure step 1 to step 4.
- (2) Detector = RMS detector
- (3) Sweep time = auto couple
- (4) Trace mode = trace averaging over a minimum of 100 traces
- (5) Use the peak marker function to determine the maximum amplitude level.
- (6) Duty cycle factor is added when duty cycle presented in section 3.7 < 98%.
- (7) If measured value exceeds limit, reduce RBW (no less than 3 kHz) and repeat.

10.4. Test Results

Please refer to Appendix A

11.DEVIATION TO TEST SPECIFICATIONS

【NONE】



APPDNDIX A

TEST DATA AND PLOTS

(Model: 15Z95P)



*Audix Technology Corp.
No. 491, Zhongfu Rd., Linkou Dist.,
New Taipei City 244, Taiwan*

*Tel: +886 2 26099301
Fax: +886 2 26099303*

APPDNDIX B

TEST PHOTOGRAPHS

(Model: 15Z95P)