



Test report No.: 2380300R-RFUSV18S-A

TEST REPORT

Product Name	Notebook Computer
Trademark	LG
Model and /or type reference	15Z90S,15ZD90S,15ZG90S,15ZB90S,15ZW90S,15ZN90S * (* can be 0 to 9 or A to Z or blank denoting buyer request)
FCC ID	BEJNT-15Z90S
Applicant's name / address	LG Electronics USA, Inc. 111 Sylvan Avenue North Building Englewood Cliffs, NJ 07632 United States
Manufacturer's name	LG ELECTRONICS INC.
Test method requested, standard	FCC CFR Title 47 Part 15 Subpart E 15.407 (h) KDB 905462
Verdict Summary	IN COMPLIANCE
Documented By (Senior Project Specialist / Genie Chang)	<i>Genie Chang</i>
Tested By (Senior Engineer / Benjamin Pan)	<i>Benjamin Pan</i>
Approved By (Senior Engineer / Alan Chen)	<i>Alan Chen</i>
Date of Receipt	2023/08/10
Date of Issue	2023/09/25
Report Version	V1.0

INDEX

	Page
1. General Information	5
1.1. EUT Description	5
1.2. Standard Requirement	8
1.3. UNII Device Description	8
1.4. Test Facility	9
1.5. Test Equipment.....	10
1.6. Uncertainty	10
1.7. Test Setup	11
1.8. DFS Requirements Prior to Use of a Channel.....	11
1.9. DFS requirements during normal operation	12
1.10. DFS Detection Thresholds	12
1.11. Radar Test Waveforms.....	13
1.12. Radar Waveform Calibration.....	18
1.13. Radar Waveform Calibration Result.....	19
1.14. Slave Data Traffic Plot Result	19
2. In-Service Monitoring for Channel Move Time and Channel Closing Transmission Time and Non-Occupancy Period.....	20
2.1. Test Procedure.....	20
2.2. Test Requirement.....	20
2.3. Test Result of Channel Move Time and Channel Closing Transmission Time and Non-Occupancy Period	21

Appendix 1: EUT Test Photographs

Appendix 2: Product Photos-Please refer to the file: 2380300R-Product Photos

Competences and Guarantees

DEKRA is a testing laboratory competent to carry out the tests described in this report.

In order to assure the traceability to other national and international laboratories, DEKRA has a calibration and maintenance program for its measurement equipment.

DEKRA guarantees the reliability of the data presented in this report, which is the result of the measurements and the tests performed to the item under test on the date and under the conditions stated in the report and it is based on the knowledge and technical facilities available at DEKRA at the time of performance of the test.

DEKRA is liable to the client for the maintenance of the confidentiality of all information related to the item under test and the results of the test.

The results presented in this Test Report apply only to the particular item under test established in this document.

IMPORTANT: No parts of this report may be reproduced or quoted out of context, in any form or by any means, except in full, without the previous written permission of DEKRA.

General conditions

1. The test results relate only to the samples tested.
2. The test results shown in the test report are traceable to the national/international standard through the calibration report of the equipment and evaluated measurement uncertainty herein.
3. This report must not be used to claim product endorsement by TAF or any agency of the government.
4. The test report shall not be reproduced without the written approval of DEKRA Testing and Certification Co., Ltd.
5. Measurement uncertainties evaluated for each testing system and associated connections are given here to provide the system information for reference. Compliance determinations do not take into account measurement uncertainties for each testing system, but are based on the results of the compliance measurement.

Revision History

Report No.	Version	Description	Issued Date
2380300R-RFUSV18S-A	V1.0	Initial issue of report.	2023/09/25

1. General Information

1.1. EUT Description

Product Name	Notebook Computer
Trademark	LG
Model and /or type reference	15Z90S,15ZD90S,15ZG90S,15ZB90S,15ZW90S,15ZN90S * (* can be 0 to 9 or A to Z or blank denoting buyer request)
EUT Rated Voltage	AC 100-240V, 50-60Hz
EUT Test Voltage	AC 120V/60Hz
Frequency Range	802.11a/n/ac/ax-20 MHz: 5180-5320 MHz, 5500-5720 MHz, 5745-5825 MHz 802.11n/ac/ax-40 MHz: 5190-5310 MHz, 5510-5710 MHz, 5755-5795 MHz 802.11ac/ax-80 MHz: 5210-5290 MHz, 5530-5690 MHz, 5775 MHz 802.11ac/ax-160 MHz: 5250 MHz, 5570 MHz
Number of Channels	802.11a/n/ac/ax-20 MHz: 25CH 802.11n/ac/ax-40 MHz: 12CH 802.11ac/ax-80 MHz: 6CH 802.11ac/ax-160 MHz: 2CH
Data Rate	802.11a: 6-54Mbps 802.11n: up to 300Mbps 802.11ac: up to 1733.3Mbps 802.11ax: up to 2402Mbps
Type of Modulation	802.11a/n/ac: OFDM (BPSK, QPSK, 16QAM, 64QAM, 256QAM) 802.11ax: OFDMA (BPSK, QPSK, 16QAM, 64QAM, 256QAM, 1024QAM)
DFS Function	<input type="checkbox"/> Master <input checked="" type="checkbox"/> Slave (Without Radar Detection)
TPC Function	<input checked="" type="checkbox"/> <500mW not required <input type="checkbox"/> \geq 500mW employ a TPC
Communication Mode	<input checked="" type="checkbox"/> IP Based Systems <input type="checkbox"/> Frame Based System <input type="checkbox"/> Other System
Channel Control	Auto
Type C to Type C Cable	Shielded, 2m
Power Adapter	Bao Hui / LP65WFC20P-NJ W Input: AC 100-240 V~1.6A, 50-60 Hz Output: 5.0V=3A, 15W or 9V=3A, 27W or 15V=3A, 45W or 20V=3.25A, 65W

Antenna List

No.	Manufacturer	Part No.	Antenna Type	Peak Gain
1	INPAQ	DQ6WAPLEL33 (WA-P-LELE-02-018) (Main)	PIFA	2.91 dBi for 5150~5250 MHz 2.74 dBi for 5250~5350 MHz 3.39 dBi for 5470~5725 MHz 3.87 dBi for 5725~5850 MHz
		DQ6WAPLEL33 (WA-P-LELE-02-018) (Aux)	PIFA	2.93 dBi for 5150~5250 MHz 3.12 dBi for 5250~5350 MHz 3.61 dBi for 5470~5725 MHz 3.94 dBi for 5725~5850 MHz
2	Pulse	DQ602701000 (TQ27010) (Main)	PIFA	2.80 dBi for 5150~5250 MHz 2.63 dBi for 5250~5350 MHz 3.11 dBi for 5470~5725 MHz 3.64 dBi for 5725~5850 MHz
		DQ602701000 (TQ27010) (Aux)	PIFA	2.87 dBi for 5150~5250 MHz 2.83 dBi for 5250~5350 MHz 3.53 dBi for 5470~5725 MHz 3.76 dBi for 5725~5850 MHz

Note:

1. The antenna of EUT is conforming to FCC 15.203.
2. The antenna gain as by the manufacturer provided.
3. Each antenna has been evaluated and only the worst case (higher gain antenna) is presented in the report.
4. The device uses Space Time Block Codes (STBC) technical, not support CDD and Beamforming modes. STBC mode signals are completely uncorrelated, the Directional gain = GANT (According to KDB 662911 D01F)2)a)ii)).

802.11a/n/ac/ax-20 MHz Center Working Frequency of Each Channel:

Channel	Frequency (MHz)	Channel	Frequency (MHz)	Channel	Frequency (MHz)	Channel	Frequency (MHz)
36	5180	40	5200	44	5220	48	5240
52	5260	56	5280	60	5300	64	5320
100	5500	104	5520	108	5540	112	5560
116	5580	120	5600	124	5620	128	5640
132	5660	136	5680	140	5700	144	5720
149	5745	153	5765	157	5785	161	5805
165	5825	--	--	--	--	--	--

802.11n/ac/ax-40 MHz Center Working Frequency of Each Channel:

Channel	Frequency (MHz)	Channel	Frequency (MHz)	Channel	Frequency (MHz)	Channel	Frequency (MHz)
38	5190	46	5230	54	5270	62	5310
102	5510	110	5550	118	5590	126	5630
134	5670	142	5710	151	5755	159	5795

802.11ac/ax-80 MHz Center Working Frequency of Each Channel:

Channel	Frequency (MHz)	Channel	Frequency (MHz)	Channel	Frequency (MHz)	Channel	Frequency (MHz)
42	5210	58	5290	106	5530	122	5610
138	5690	155	5775	--	--	--	--

802.11ac/ax-160 MHz Center Working Frequency of Each Channel:

Channel	Frequency (MHz)	Channel	Frequency (MHz)	--	--	--	--
50	5250	114	5570	--	--	--	--

Test Mode	Mode 1	Transmit
-----------	--------	----------

1.2. Standard Requirement

FCC Part 15.407:

U-NII devices operating in the 5.25-5.35 GHz band and the 5.47-5.725 GHz band shall employ a TPC mechanism. The U-NII device is required to have the capability to operate at least 6 dB below the mean EIRP value of 30dBm. A TPC mechanism is not required for systems with an E.I.R.P. of less than 500mW.

U-NII devices operating in the 5.25-5.35 GHz and 5.47-5.725 GHz bands shall employ a DFS radar detection mechanism to detect the presence of radar systems and to avoid co-channel operation with radar systems.

1.3. UNII Device Description

(1) The EUT operates in the following DFS band:

1. 5250-5350 MHz
2. 5470-5725 MHz

(2) The maximum EIRP of the 5GHz equipment is 23.59dBm.

Below are the available 50 ohm antenna assemblies and their corresponding gains.

0dBi gain was used to set the -63 dBm threshold level (-64dBm +1 dB) during calibration of the test setup.

(3) DFS operation description:

WLAN traffic is generated by the data packet from the Master device to the Slave Device.

(4) This device does not exceed 27dBm eirp, so no transmit power control is implemented.

(5) The master device is an Access Point and FCC ID: MSQ-RTAXHP00

1.4. Test Facility

Ambient conditions in the laboratory:

Performed Item	Items	Required	Actual
Conductive	Temperature (°C)	10~40 °C	24.8 °C
	Humidity (%RH)	10~90 %	56.1 %

USA	FCC Registration Number: TW0033
Canada	CAB Identifier Number: TW3023 / Company Number: 26930

Site Description	Accredited by TAF
	Accredited Number: 3023

Test Laboratory	DEKRA Testing and Certification Co., Ltd.
	Linkou Laboratory
Address	No.5-22, Ruishukeng Linkou District, New Taipei City, 24451, Taiwan, R.O.C.
Performed Location	No. 26, Huaya 1st Rd., Guishan Dist., Taoyuan City 333411, Taiwan, R.O.C.
Phone Number	+886-3-275-7255
Fax Number	+886-3-327-8031

1.5. Test Equipment

Dynamic Frequency Selection (DFS) / HY-SR05

Instrument	Manufacturer	Type No.	Serial No	Cal. Date	Cue Date
Spectrum Analyzer	Agilent	N9020A	MY48010570	2022/10/25	2023/10/24
Vector Signal Generator	KEYSIGHT	N5182B	MY59100310	2023/07/28	2024/07/27

Instrument	Manufacturer	Type No.	Serial No
Splitter/Combiner (Qty: 2)	Mini-Circuits	ZFRSC-123-S+	SN331000910
Notebook PC	Dell	N/A	N/A
ATT	Mini-Circuits	15542	30912
ATT	Mini-Circuits	15542	30909
4 WAY Divider	WOKEN	0120A04056002D	151101
Rotary ATT (Qty: 2)	WOKEN	00801A1GGAM02Y	SMA 0-121dB
Access Point	ASUS	RT-AX88U	JCITHP000040

Software	Manufacturer	Function
R&S Pulse Sequencer DFS V2.4	R&S	Radar Signal Generation Software
N7607C Signal Studio for DFS Radar Profile 2022 Update 1.0 V 2.4.0.0	KEYSIGHT	Radar Signal Generation Software
Iperf v2.0.8	iperf/fr	Streaming Date

Note: All equipments are calibrated every one year.

1.6. Uncertainty

Uncertainties have been calculated according to the DEKRA internal document.

The reported expanded uncertainties are based on a standard uncertainty multiplied by a coverage factor of k=2, providing a level of confidence of approximately 95%.

Measurement uncertainties evaluated for each testing system and associated connections are given here to provide the system information for reference. Compliance determinations do not take into account measurement uncertainties for each testing system, but are based on the results of the compliance measurement.

Test item	Uncertainty
Dynamic Frequency Selection (DFS)	±0.53 %

1.7. Test Setup

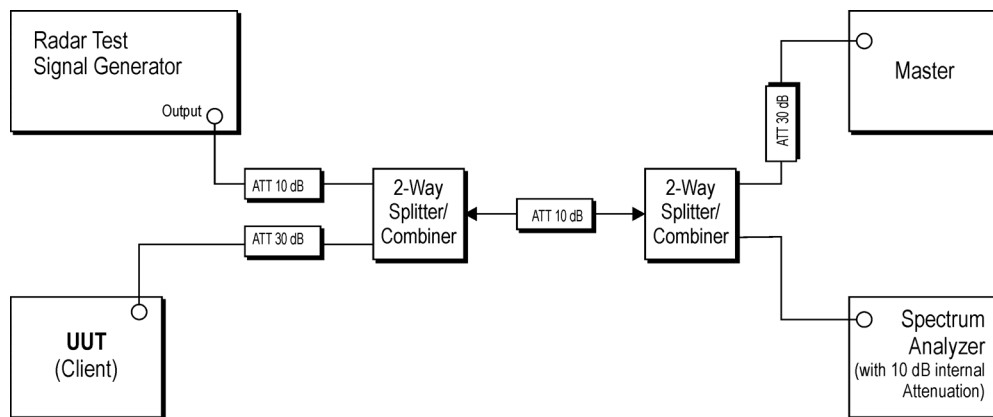

1.8. DFS Requirements Prior to Use of a Channel

Requirement	Operational Mode		
	Master	Client Without Radar Detection	Client With Radar Detection
Non-Occupancy Period	Yes	Not required	Yes
DFS Detection Threshold	Yes	Not required	Yes
Channel Availability Check Time	Yes	Not required	Not required
U-NII Detection Bandwidth	Yes	Not required	Yes

1.9. DFS requirements during normal operation

Requirement	Operational Mode		
	Master	Client Without Radar Detection	Client With Radar Detection
DFS Detection Threshold	Yes	Not required	Yes
Channel Closing Transmission Time	Yes	Yes	Yes
Channel Move Time	Yes	Yes	Yes
U-NII Detection Bandwidth	Yes	Not required	Yes

1.10. DFS Detection Thresholds

(1) Interference Threshold value, Master or Client incorporating In-Service Monitoring

Maximum Transmit Power	Value (see note)
≥ 200 milliwatt	-64 dBm
EIRP < 200 milliwatt and power spectral density < 10 dBm/MHz	-62 dBm
EIRP < 200 milliwatt that do not meet the power spectral density requirement	-64 dBm
<p>Note 1: This is the level at the input of the receiver assuming a 0 dBi receive antenna.</p> <p>Note 2: Throughout these test procedures an additional 1 dB has been added to the amplitude of the test transmission waveforms to account for variations in measurement equipment. This will ensure that the test signal is at or above the detection threshold level to trigger a DFS response.</p> <p>Note3: EIRP is based on the highest antenna gain. For MIMO devices refer to KDB Publication 662911 D01.</p>	

(2) DFS Response requirement values

Parameter	Value
Non-Occupancy Period	30 Minutes
Channel Availability Check Time	60 Seconds
Channel Move Time	10 seconds See Note 1.
Channel Closing Transmission Time	200 milliseconds + an aggregate of 60 milliseconds over remaining 10 second period. See Notes 1 and 2.
U-NII Detection Bandwidth	Minimum 100% of the U-NII 99% transmission power bandwidth. See Note 3.
<p>Note 1: Channel Move Time and the Channel Closing Transmission Time should be performed with Radar Type 0. The measurement timing begins at the end of the Radar Type 0 burst.</p> <p>Note 2: The Channel Closing Transmission Time is comprised of 200 milliseconds starting at the beginning of the Channel Move Time plus any additional intermittent control signals required to facilitate a Channel move (an aggregate of 60 milliseconds) during the remainder of the 10 second period. The aggregate duration of control signals will not count quiet periods in between transmissions.</p> <p>Note 3: During the U-NII Detection Bandwidth detection test, radar type 0 should be used. For each frequency step the minimum percentage of detection is 90 percent. Measurements are performed with no data traffic.</p>	

1.11. Radar Test Waveforms

This section provides the parameters for required test waveforms, minimum percentage of successful detections, and the minimum number of trials that must be used for determining DFS conformance. Step intervals of 0.1 microsecond for Pulse Width, 1 microsecond for PRI, 1 MHz for chirp width and 1 for the number of pulses will be utilized for the random determination of specific test waveforms.

(1) Short Pulse Radar Test Waveforms

Radar Type	Pulse Width (μsec)	PRI (μsec)	Number of Pulses	Minimum Percentage of Successful Detection	Minimum Number of Trials
0	1	1428	18	See Note 1	See Note 1
1	1	Test A: 15 unique PRI values randomly selected from the list of 23 PRI values in Table 5a	Roundup $\left\{ \left(\frac{1}{360} \right) \cdot \left(\frac{19 \cdot 10^6}{\text{PRI}_{\mu\text{sec}}} \right) \right\}$	60%	30
		Test B: 15 unique PRI values randomly selected within the range of 518-3066 μ sec, with a minimum increment of 1 μ sec, excluding PRI values selected in Test A			
2	1-5	150-230	23-29	60%	30
3	6-10	200-500	16-18	60%	30
4	11-20	200-500	12-16	60%	30
Aggregate (Radar Types 1-4)				80%	120
Note 1: Short Pulse Radar Type 0 should be used for the detection bandwidth test, channel move time, and channel closing time tests.					

A minimum of 30 unique waveforms are required for each of the Short Pulse Radar Types 2 through 4. If more than 30 waveforms are used for Short Pulse Radar Types 2 through 4, then each additional waveform must also be unique and not repeated from the previous waveforms. If more than 30 waveforms are used for Short Pulse Radar Type 1, then each additional waveform is 905462 D02 UNII DFS Compliance Procedures v01 Page 10 generated with Test B and must also be unique and not repeated from the previous waveforms in Tests A or B.

(2) Long Pulse Radar Test Signal

Radar Waveform	Bursts	Pulses Per Burst	Pulse Width (usec)	Chirp Width (MHz)	PRI (usec)	Minimum Percentage of Successful Detection	Minimum Trials
5	8-20	1-3	50-100	5-20	1000-2000	80%	30

The parameters for this waveform are randomly chosen. Thirty unique waveforms are required for the long pulse radar test signal. If more than 30 waveforms are used for the long pulse radar test signal, then each additional waveform must also be unique and not repeated from the previous waveforms.

Each waveform is defined as follows:

- 1) The transmission period for the Long Pulse Radar test signal is 12 seconds.
- 2) There are a total of 8 to 20 Bursts in the 12 second period, with the number of Bursts being randomly chosen. This number is Burst Count.
- 3) Each Burst consists of 1 to 3 pulses, with the number of pulses being randomly chosen. Each Burst within the 12 second sequence may have a different number of pulses.
- 4) The pulse width is between 50 and 100 microseconds, with the pulse width being randomly chosen. Each pulse within a Burst will have the same pulse width. Pulses in different Bursts may have different pulse widths.
- 5) Each pulse has a linear frequency modulated chirp between 5 and 20 MHz, with the chirp width being randomly chosen. Each pulse within a transmission period will have the same chirp width. The chirp is centered on the pulse. For example, with a radar frequency of 5300 MHz and a 20 MHz chirped signal, the chirp starts at 5290 MHz and ends at 5310 MHz.
- 6) If more than one pulse is present in a Burst, the time between the pulses will be between 1000 and 2000 microseconds, with the time being randomly chosen. If three pulses are present in a Burst, the random time interval between the first and second pulses is chosen independently of the random time interval between the second and third pulses.
- 7) The 12 second transmission period is divided into even intervals. The number of intervals is equal to Burst Count. Each interval is of length $(12,000,000 / \text{Burst Count})$ microseconds. Each interval contains one Burst. The start time for the Burst, relative to the beginning of the interval, is between 1 and $[(12,000,000 / \text{Burst Count}) - (\text{Total Burst Length}) + (\text{One Random PRI Interval})]$ microseconds, with the start time being randomly chosen. The step interval for the start time is 1 microsecond. The start time for each Burst is chosen randomly.

A representative example of a Long Pulse radar test waveform:

- 1) The total test waveform length is 12 seconds.
- 2) Eight (8) Bursts are randomly generated for the Burst Count.
- 3) Burst 1 has 2 randomly generated pulses.
- 4) The pulse width (for both pulses) is randomly selected to be 75 microseconds.
- 5) The PRI is randomly selected to be at 1213 microseconds.
- 6) Bursts 2 through 8 are generated using steps 3 – 5.
- 7) Each Burst is contained in even intervals of 1,500,000 microseconds. The starting location for Pulse 1, Burst 1 is randomly generated (1 to 1,500,000 minus the total Burst 1 length + 1 random PRI interval) at the 325,001 microsecond step. Bursts 2 through 8 randomly fall in successive 1,500,000 microsecond intervals (i.e. Burst 2 falls in the 1,500,001 – 3,000,000 microsecond range).

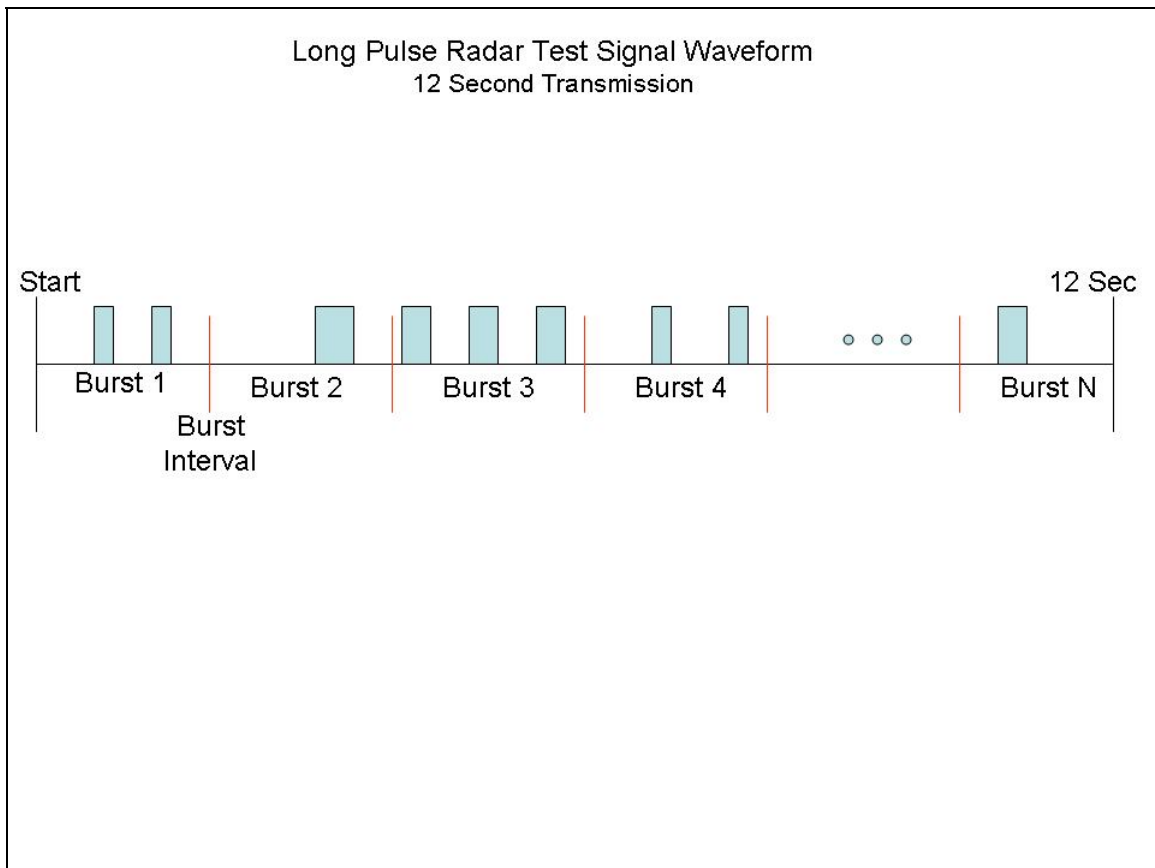
Graphical Representation of a Long Pulse radar Test Waveform

(3) Frequency Hopping Radar Test Signal

Radar Waveform	Pulse Width (μ sec)	PRI (μ sec)	Hopping Sequence Length (msec)	Pulses Per Hop	Hopping Rate (kHz)	Minimum Percentage of Successful Detection	Minimum Trials
6	1	333	300	9	0.333	70%	30

For the Frequency Hopping Radar Type, the same Burst parameters are used for each waveform. The hopping sequence is different for each waveform and a 100-length segment is selected¹ from the hopping sequence defined by the following algorithm:

The first frequency in a hopping sequence is selected randomly from the group of 475 integer frequencies from 5250 – 5724 MHz. Next, the frequency that was just chosen is removed from the group and a frequency is randomly selected from the remaining 474 frequencies in the group. This process continues until all 475 frequencies are chosen for the set. For selection of a random frequency, the frequencies remaining within the group are always treated as equally likely.

1.12. Radar Waveform Calibration

The following equipment setup was used to calibrate the conducted radar waveform. A spectrum analyzer was used to establish the test signal level for each radar type. During this process there were replace 50ohm terminal from master and client device and no transmissions by either the master or client device. The spectrum analyzer was switched to the zero span (time domain) at the frequency of the radar waveform generator. Peak detection was utilized. The spectrum analyzer resolution bandwidth (RBW) and video bandwidth (VBW) were set to 3 MHz and 3 MHz.

The signal generator amplitude was set so that the power level measured at the spectrum analyzer was -64dBm due to the interference threshold level is not required.

Conducted Calibration Setup

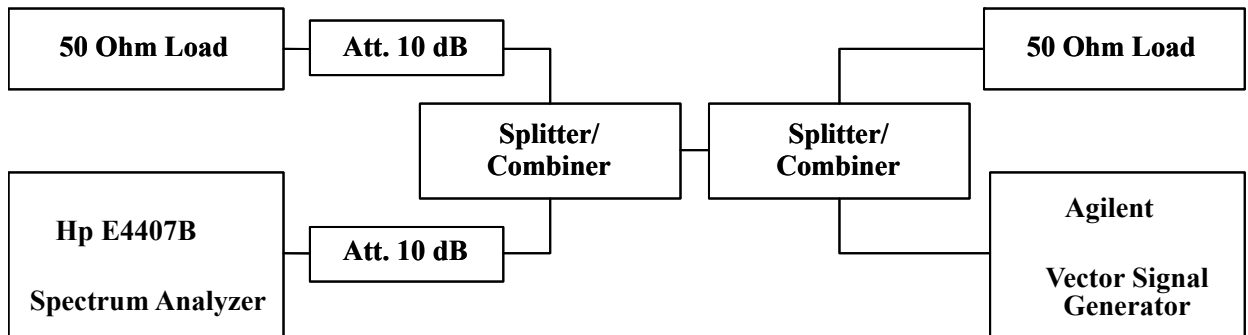

1.13. Radar Waveform Calibration Result

Radar Type 0 Calibration Plot (5570 MHz)

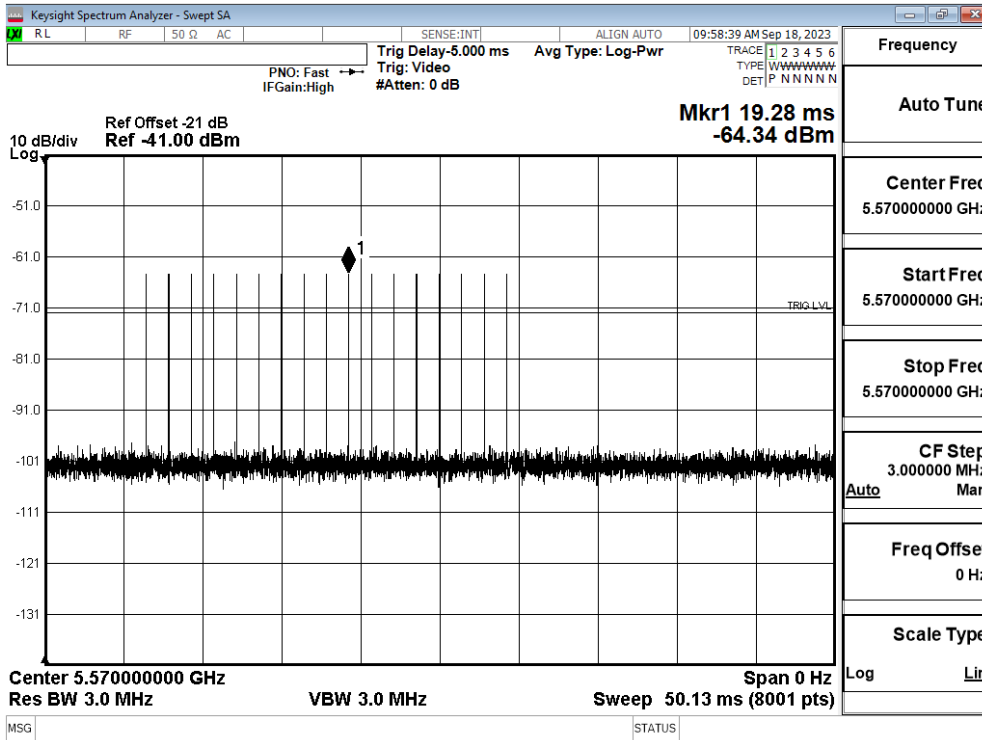

1.14. Slave Data Traffic Plot Result

Plot of Slave Traffic at 5570 MHz

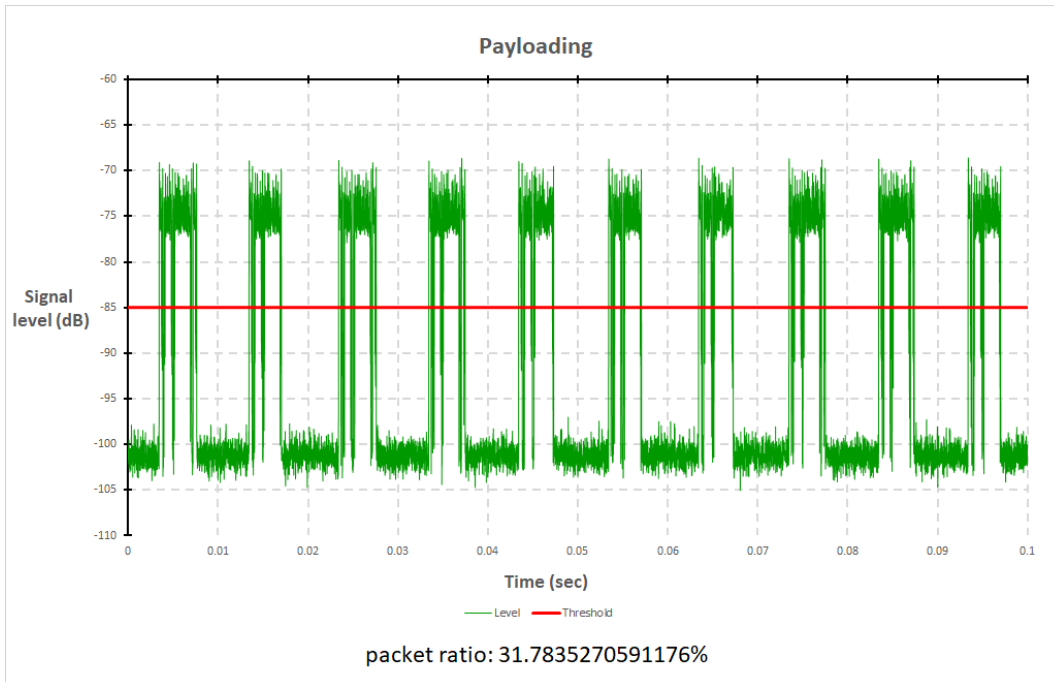

2. In-Service Monitoring for Channel Move Time and Channel Closing Transmission Time and Non-Occupancy Period

2.1. Test Procedure

These tests define how the following DFS parameters are verified during In-Service Monitoring;

Channel Closing Transmission Time, Channel Move Time, and Non-Occupancy Period.. The steps below define the procedure to determine the above mentioned parameters when a radar Burst with a level equal to the DFS Detection Threshold + 1dB (-63dBm) is generated on the Operating Channel of the U-NII device.

A U-NII device operating as a Master Device will associate with the UUT (Client) at 5300 MHz and 5500MHz.

Stream the MPEG test file from the Client (TX) Device to the Master (RX) Device on the selected Channel for the entire period of the test.

At time T_0 the Radar Waveform generator sends a Burst of pulses for each of the radar types at -63dBm.

Observe the transmissions of the UUT at the end of the radar Burst on the Operating Channel for duration greater than 10 seconds. Measure and record the transmissions from the UUT during the observation time (Channel Move Time). Compare the Channel Move Time and Channel Closing

Transmission Time results to the limits defined in the DFS Response requirement values table.

Measure the UUT for more than 30 minutes following the channel close/move time to verify that the UUT does not resume any transmissions on this Channel.

2.2. Test Requirement

Parameter	Value
Channel Move Time	10 Seconds
Channel Closing Transmission Time	200 milliseconds + an aggregate of 60 milliseconds over remaining 10 seconds period
Non-Occupancy Period	Minimum 30 minutes

2.3. Test Result of Channel Move Time and Channel Closing Transmission Time and Non-Occupancy Period

Product : Notebook Computer
 Test Item : Channel Move Time Test & Channel Closing Transmission Time Test
 Radar Type : Type 0
 Test Mode : Transmit

Channel Move Time for Radar Test Type 0 at 5570 MHz

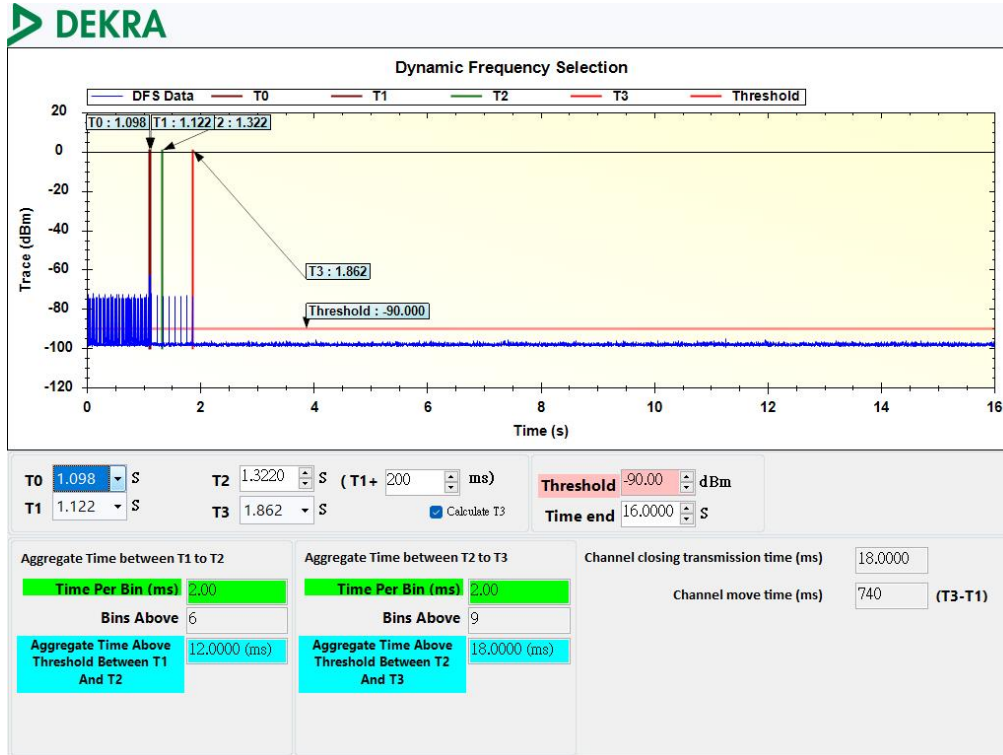

Test Item	Test Result (Sec)	Limit (Sec)
Channel Move Time	0.74	10

The results showed that after radar signal injected the channel move time was less than 10 seconds.

Test Item	Test Result (ms)	Limit (ms)
Channel Closing Transmission	18	200 milliseconds + approx. 60 milliseconds over remaining 10 seconds period

The results showed that after radar signal injected the channel transmission closing time less than 200 milliseconds and an aggregate of no more than 60 milliseconds.

Product : Notebook Computer
 Test Item : Non-Occupancy Period Test
 Radar Type : Type 0
 Test Mode : Transmit

Non-Occupancy Period for Radar Test Type 0 at 5570 MHz

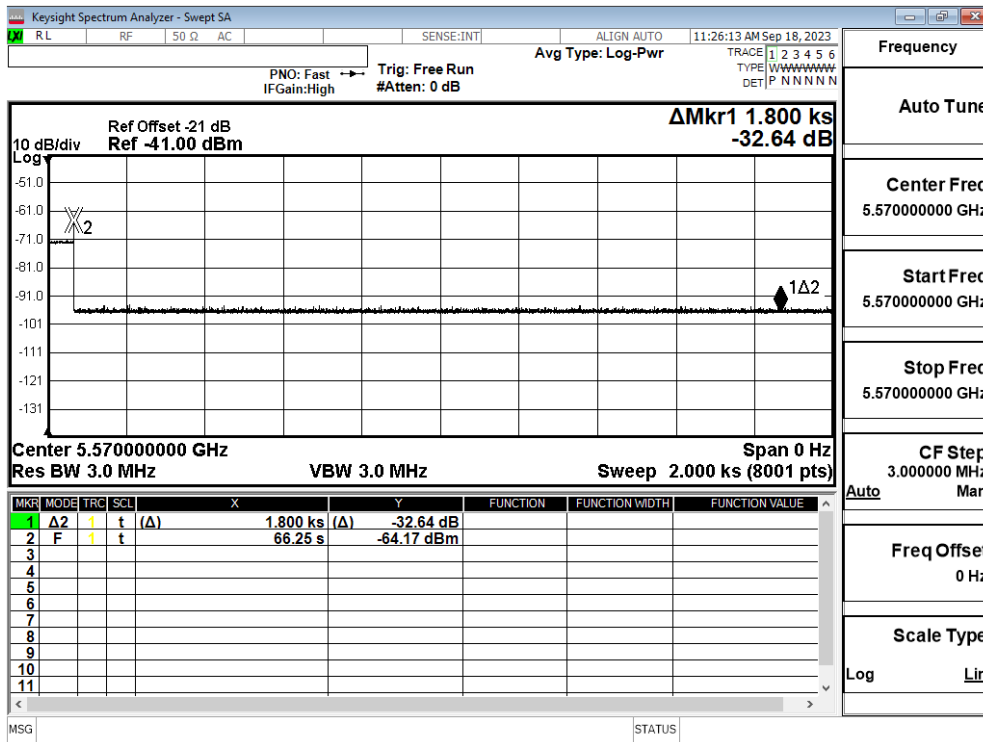

Test Item	Test Result (minute)	Limit (minute)
Non-Occupancy Period	>30	30