

## FCC 15.247 & RSS-247 2.4GHz Test Report

for

**LG Electronics Inc.**

**222, LG-ro, Jinwi-myeon Pyeongtaek-Si, Gyeonggi-Do,  
17709 Republic of Korea**

**Product Name** : Notebook Computer  
**Model Name** : (1)15Z90RT (2)15ZB90RT  
(3)15ZD90RT  
(4)15ZG90RT  
**Brand** : LG  
**FCC ID** : BEJNT-15Z90RT  
**IC** : 2703H-15Z90RT

**Prepared by:** : AUDIX Technology Corporation,  
EMC Department



The test report is based on a single evaluation of one sample of the above-mentioned products. It does not imply an assessment of the whole production and does not permit the use of the test lab logo.

## TABLE OF CONTENTS

Description	Page
TEST REPORT .....	4
<b>1. REVISION RECORD OF TEST REPORT .....</b>	<b>5</b>
<b>2. SUMMARY OF TEST RESULTS .....</b>	<b>6</b>
<b>3. GENERAL INFORMATION .....</b>	<b>7</b>
3.1. Description of Application .....	7
3.2. Description of EUT .....	8
3.3. Reference Test Guidance.....	9
3.4. Antenna Information .....	9
3.5. EUT Specifications Assessed in Current Report .....	10
3.6. Descriptions of Key Components.....	12
3.7. Test Configuration.....	14
3.8. Output Power Setting .....	21
3.9. Tested Supporting System List.....	22
3.10. Setup Configuration.....	23
3.11. Operating Condition of EUT .....	23
3.12. Description of Test Facility .....	24
3.13. Measurement Uncertainty .....	25
<b>4. MEASUREMENT EQUIPMENTLIST.....</b>	<b>27</b>
4.1. Conducted Emission Measurement .....	27
4.2. Radiated Emission Measurement .....	28
4.3. RF Conducted Measurement .....	28
<b>5. CONDUCTED EMISSION.....</b>	<b>29</b>
5.1. Block Diagram of Test Setup .....	29
5.2. Conducted Emission Limit .....	29
5.3. Test Procedure .....	29
5.4. Test Results .....	29
<b>6. RADIATED EMISSION .....</b>	<b>30</b>
6.1. Block Diagram of Test Setup .....	30
6.2. Radiated Emission Limits.....	32
6.3. Test Procedure .....	33
6.4. Measurement Result Explanation.....	34
6.5. Test Results .....	34
<b>7. DTS/OCCUPIED BANDWIDTH.....</b>	<b>35</b>
7.1. Block Diagram of Test Setup .....	35
7.2. Specification Limits.....	35
7.3. Test Procedure .....	35
7.4. Test Results .....	35
<b>8. MAXIMUM PEAK OUTPUT POWER.....</b>	<b>36</b>
8.1. Block Diagram of Test Setup .....	36
8.2. Specification Limits.....	36
8.3. Test Procedure .....	37
8.4. Test Results .....	37
<b>9. EMISSION LIMITATIONS .....</b>	<b>38</b>



**Audix Technology Corp.**  
No. 491, Zhongfu Rd., Linkou Dist.,  
New Taipei City 244, Taiwan

**Tel: +886 2 26099301**  
**Fax: +886 2 26099303**

---

9.1. Block Diagram of Test Setup .....	38
9.2. Specification Limits.....	38
9.3. Test Procedure .....	38
9.4. Test Results .....	39
<b>10. POWER SPECTRAL DENSITY .....</b>	<b>40</b>
10.1. Block Diagram of Test Setup .....	40
10.2. Specification Limits.....	40
10.3. Test Procedure .....	40
10.4. Test Results .....	40
<b>11. DEVIATION TO TEST SPECIFICATIONS .....</b>	<b>41</b>

APPENDIX A TEST DATA AND PLOTS  
APPENDIX B TESTPHOTOGRAPHS

## TEST REPORT

Applicant : LG Electronics Inc.  
Manufacturer : LG Electronics Inc.  
Factory : LG Electronics Nanjing New Technology Co., Ltd.  
EUT Description  
(1) Product : Notebook Computer  
(2) Model : (1)15Z90RT (2)15ZB90RT (3)15ZD90RT (4)15ZG90RT  
(3) Brand : LG  
(4) Power Supply: DC 20V, 3.25A

### Applicable Standards:

Title 47 CFR FCC Part 15 Subpart C  
RSS-Gen (Issue 5), Amendment 2, February 2021  
RSS-247 (Issue 2), February 2017  
ANSI C63.10:2013

**Audix Technology Corp.** tested the equipment mentioned in accordance with the requirements set forth in the above standards. Test results indicate that the equipment tested is capable of demonstrating compliance with the requirements as documented within this report.

**Audix Technology Corp.** does not assume responsibility for any conclusions and generalizations drawn from the test results with regard to other specimens and samples.

Date of Report: 2023. 02. 10

Reviewed by:



(Annie Yu/Administrator)

Approved by:

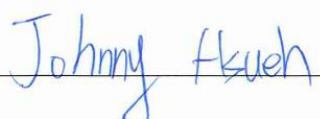

(Johnny Hsueh/Section Manager)

## 1. REVISION RECORD OF TEST REPORT

Edition No	Issued Data	Revision Summary	Report Number
0	2023. 02. 10	Original Report	EM-F230111

## 2. SUMMARY OF TEST RESULTS

Rule		Description	Results
FCC	IC		
15.207	RSS-Gen §8.8	Conducted Emission	<b>PASS</b>
15.247(d)/ 15.205	RSS-Gen §8.9 RSS-247 §5.5	Radiated Band Edge and Radiated Spurious Emission	<b>PASS</b>
15.247(a)(2)	RSS-247 §5.2(1)	DTS/Occupied Bandwidth	<b>PASS</b>
15.247(b)(3)	RSS-247 §5.4(4)	Maximum Peak Output Power	<b>PASS</b>
15.247(d)	RSS-247 §5.5	Conducted Band Edges and Conducted Spurious Emission	<b>PASS</b>
15.247 (e)	RSS-247 §5.2(2)	Peak Power Spectral Density	<b>PASS</b>
15.203	---	Antenna Requirement	<b>Compliance</b>

Note: The uncertainties value is not used in determining the result.

### 3. GENERAL INFORMATION

#### 3.1. Description of Application

Applicant	LG Electronics Inc. 222, LG-ro, Jinwi-myeon Pyeongtaek-Si, Gyeonggi-Do, 17709 Republic of Korea
Manufacturer	LG Electronics Inc. 222, LG-ro, Jinwi-myeon Pyeongtaek-Si, Gyeonggi-Do, 17709 Republic of Korea
Factory	LG Electronics Nanjing New Technology Co., Ltd. No.346, Yaoxin Road, Economic & Technical Development Zone, Nanjing, China.
Product	Notebook Computer
Model	(1)15Z90RT (2)15ZB90RT (3)15ZD90RT (4)15ZG90RT The difference between all models is different in the sales customers and color difference.
Brand	LG

### 3.2. Description of EUT

Test Model	15Z90RT		
Serial Number	N/A		
Power Rating	DC 20V, 3.25A		
Software Version	XY (X, Y can be 0 to 9 for different SW version not influence RF parameter)		
RF Features	WLAN:802.11 a/b/g/n/ac/ax Bluetooth: BT and BLE (BT 5.1)		
Transmit Type	2.4 GHz		
	802.11b	1T1R	
	802.11g	1T1R	
	802.11n-HT20	2T2R	
	802.11n-HT40	2T2R	
	802.11ax-HE20	2T2R	
	802.11ax-HE40	2T2R	
	BT/BLE	1T1R	
	U-NII Bands		
	802.11a	1T1R	
	802.11n-HT20/802.11ac-VHT20/802.11ax-HE20	2T2R	
	802.11n-HT40/802.11ac-VHT40/802.11ax-HE40	2T2R	
	802.11ac-VHT80/802.11ax-HE80	2T2R	
	802.11ac-VHT160/802.11ax-HE160	2T2R	
	The MIMO is uncorrelated and supported SDM(Spatial Division Multiplexing) mode only. This radio device doesn't support beamforming and Cyclic Delay Diversity (CDD).		
	Sample Status	Trial sample	
Test Sample	Sample No.	Test Item	Firmware
	02	AC Conduction, RSE, Output Power	N/A
Date of Receipt	2023. 01. 05		
Date of Test	2023. 01. 10 ~ 02. 08		
Interface Ports of EUT	<ul style="list-style-type: none"> <li>• Three USB Type C Port</li> <li>• One Earphone Port</li> </ul>		
Accessories Supplied	<ul style="list-style-type: none"> <li>• AC Adapter</li> <li>• USB C Cable</li> <li>• LAN Gender</li> </ul>		



### 3.3. Reference Test Guidance

KDB 662911 D01 Multiple Transmitter Output v02r01  
 ANSI C63.10:2013

### 3.4. Antenna Information

No.	Antenna Part Number	Manufacture	Antenna Type	Frequency (MHz)	Gain(dBi)		Directional Gain <sup>Note1 &amp; 2</sup>
					Main	AUX	
1.	WA-P-LELE-04-044	INPAQ	Mono-Pole	2400	3.20	3.70	3.46
				2450	3.60	3.90	3.75
				2500	3.30	4.20	3.77
				5150	1.90	2.40	2.16
				5470	2.70	1.10	1.97
				5850	1.30	1.10	1.20
				5925	1.60	1.60	1.60
				6525	-0.50	0.30	-0.08
			7125	3.90	3.00	3.47	

According to KDB 662911 D01 d) ii), transmit signals are completely uncorrelated, then

$$\text{Directional gain} = 10 \log[(10^{G1/10} + 10^{G2/10} + \dots + 10^{GN/10})/N_{\text{ANT}}] \text{ dBi}$$

Note 1. WLAN 2.4GHz: Directional gain =

$$2400\text{MHz: Directional gain} = 10 \log[(10^{3.2/10} + 10^{3.7/10})/2] = 3.46\text{dBi}$$

$$2450\text{MHz: Directional gain} = 10 \log[(10^{3.6/10} + 10^{3.9/10})/2] = 3.75\text{dBi}$$

$$2500\text{MHz: Directional gain} = 10 \log[(10^{3.3/10} + 10^{4.2/10})/2] = 3.77\text{dBi}$$

Note 2. WLAN 5G/6GHz: Directional gain =

$$5150\text{MHz: Directional gain} = 10 \log[(10^{1.9/10} + 10^{2.4/10})/2] = 2.16\text{dBi}$$

$$5470\text{MHz: Directional gain} = 10 \log[(10^{2.7/10} + 10^{1.1/10})/2] = 1.97\text{dBi}$$

$$5850\text{MHz: Directional gain} = 10 \log[(10^{1.3/10} + 10^{1.1/10})/2] = 1.20\text{dBi}$$

$$5925\text{MHz: Directional gain} = 10 \log[(10^{1.6/10} + 10^{1.6/10})/2] = 1.60\text{dBi}$$

$$6525\text{MHz: Directional gain} = 10 \log[(10^{-0.5/10} + 10^{0.3/10})/2] = -0.08\text{dBi}$$

$$7125\text{MHz: Directional gain} = 10 \log[(10^{3.9/10} + 10^{3.0/10})/2] = 3.47\text{dBi}$$

We chose the antenna gain corresponding to the frequency listed on the table which is closer to center frequency of WLAN/BT.

### 3.5. EUT Specifications Assessed in Current Report

Mode	Fundamental Range (MHz)	Channel Number	Modulation	Data Rate (Mbps)
802.11b	2412-2472	13	DSSS (DBPSK/DQPSK/CCK)	Up to 11
802.11g		13	OFDM (BPSK/QPSK/16QAM/64QAM)	Up to 54
802.11n-HT20				Up to 144.4
802.11n-HT40	2422-2462	9	OFDM (BPSK/QPSK/16QAM/64QAM)	Up to 300
802.11ax-HE20	2412-2472	13	OFDMA (BPSK/ QPSK/ 16QAM/ 64QAM/ 256QAM/1024QAM)	Up to 287
802.11ax-HE40	2422-2462	9		Up to 574
BLE	2402-2480	40	GFSK (1Mbps, 2Mbps, PHY Coded S8, PHY Coded S2)	Up to 2

Channel List			
802.11 b/g/n-HT20/ax-HE20		802.11n-HT40/ax-HE40	
Channel Number	Frequency (MHz)	Channel Number	Frequency (MHz)
1	2412	3	2422
2	2417	4	2427
3	2422	5	2432
4	2427	6	2437
5	2432	7	2442
6	2437	8	2447
7	2442	9	2452
8	2447	10	2457
9	2452	11	2462
10	2457		
11	2462		
12	2467		
13	2472		

Channel List							
BLE							
Channel Number	Frequency (MHz)	Channel Number	Frequency (MHz)	Channel Number	Frequency (MHz)	Channel Number	Frequency (MHz)
37	2402	09	2422	18	2442	28	2462
00	2404	10	2424	19	2444	29	2464
01	2406	38	2426	20	2446	30	2466
02	2408	11	2428	21	2448	31	2468
03	2410	12	2430	22	2450	32	2470
04	2412	13	2432	23	2452	33	2472
05	2414	14	2434	24	2454	34	2474
06	2416	15	2436	25	2456	35	2476
07	2418	16	2438	26	2458	36	2478
08	2420	17	2440	27	2460	39	2480

### 3.6. Descriptions of Key Components

#### 3.6.1. For the All Component Lists

Item	Supplier	Model / Type	Character
System	Microsoft	Win 11	---
	---	Non-OS	---
Main Board	LG	15Z90RT MAIN B/D PCB	Manufacturer: #1 Hannstar Board Tech (Jiang Yin) Corp.,Ltd. #2 Elec&Eltek Company (MCO) Limited.
WLAN SUB Board	LG	15Z90RT SUB B/D	Manufacturer: #1 Hannstar Board Tech (Jiang Yin)Corp.,Ltd. #2 Elec&Eltek Company (MCO) Limited.
CPU (Socket: BGA1744)	Intel	i7-1360P	2.2GHz
	Intel	i5-1340P	1.9GHz
	Intel	i3-1315U	1.2GHz
15.6" LCD Panel	Samsung	ATNA56YX08-0	Resolution: 1920x1080@60Hz (OLED,FHD)
Storage (SSD) TW USE	SK hynix	HFS256GEJ9X101N	256GB
		HFS512GEJ9X101N	512GB
		HFS001TEJ9X101N	1TB
		HFS002TEJ9X101N	2TB
	Samsung	MZ-VL22560	256GB
		MZ-VLQ256B	256GB
		MZ-VL25120	512GB
		MZ-VL21T00	1TB
		MZ-VL22T00	2TB
Memory (RAM)	Samsung	---	32GB LPDDR5 6000 MHz (On Board)
		---	16GBLPDDR5 6000 MHz (On Board)
		---	8GB LPDDR5 6000 MHz (On Board)
	SK Hynix	---	32GBLPDDR5 6000 MHz (On Board)
		---	16GBLPDDR5 6000 MHz (On Board)
		---	8GB LPDDR5 6000 MHz (On Board)
Battery Pack	LG	LB2122LM	DC15.52V, 60Wh Typ 3866 mAh
WLAN Combo Card	Intel	AX211D2W	WLAN and BT, 2x2 PCIe M.2 1216 SD adapter card FCC ID: PD9AX211D2 IC: 1000M-AX211D2
WLAN Combo Antenna	LG (INPAQ)	WA-P-LELE-04-044	PCB, Mono-pole Type Main: Black, Aux: Gray
Touch Pad	Lite on	SP8000(SG-A0620-00A)	---
	Elan	SB068D-26H0	---
Keyboard	TIC	KT0122L2	---
Web Camera	Luxvisions	2BG204N3(2Mic)	---

Item	Supplier	Model / Type	Character
LAN Gender (Type C to LAN)	SUZHOU MEC ELECTRONICS	80-5946-111	(White) 10/100Megabit Ethernet
		80-5946-101	(Black) 10/100 Megabit Ethernet
	ARIN TECH CO. LTD	GD-08MF-36-WH-LP10	(White) 10/100Megabit Ethernet
		GD-08MF-36-BK-LP11	(Black) 10/100 Megabit Ethernet
	HUIZHOU DEHONG TECHNOLOGY CO.,LTD.	370-50713	(White) 10/100Megabit Ethernet
		370-50714	(Black) 10/100 Megabit Ethernet
Type C to LAN: Shielded, Undetached, 0.12m			
AC Adapter	LG (PI ELECTRONICS)	LP65WFC20P-NJ W	(White) I/P: AC 100-240V, 1.6A, 50-60Hz O/P: (PDO) DC5V, 3A (15W) or DC9V, 3A (27W) or DC 15V,3A (45W) or DC 20V, 3.25A (65W) O/P: (PPS) DC5V- 20V, 3.25A, Max 65W Wall-Mounted: (2C)
			(Black) I/P: AC 100-240V, 1.6A, 50-60Hz O/P: (PDO) DC5V, 3A (15W) or DC9V, 3A (27W) or DC 15V,3A (45W) or DC 20V, 3.25A (65W) O/P: (PPS) DC5V- 20V, 3.25A, Max 65W Wall-Mounted: (2C)
	Type C Cable: Shielded, Detached, 2.0m		

Remark: For more detailed features description, please refer to the manufacturer’s specifications or the user manual.

3.6.2. The EUT collocates with following worst components, which are used to establish a basic configuration of system during test:

SKU (Mode)		1	
Main Board	LG, 15Z90RT MAIN B/D PCB	V	
WLAN SUB Board	LG, 15Z90RT SUB B/D	V	
CPU	Intel, i7-1360P	V	
Memory (RAM)	32GB	V	
15.6” LCD Panel	Samsung, ATNA56YX08-0	V	
Storage (SSD)	SK hynix, 256GB	V	
	Samsung, 2TB	V	
Battery Pack	LG, LB2122LM, 60Wh	V	
Touch Pad	Lite on, SP8000(SG-A0620-00A)	V	
WLAN Combo Card	Intel, AX211D2W	V	
WLAN Combo Antenna	LG (INPAQ), WA-P-LELE-04-044	V	
Type C	AC Adapter	LG(PI ELECTRONICS), LP65WFC20P-NJ W	V
	Link to LAN Gender	10/100Mbps	V
	Link to USB HUB	---	V

### 3.7. Test Configuration

Mode	TX <sub>on</sub> (ms)	TX <sub>on+off</sub> (ms)	Duty Cycle (x)	Duty Cycle Factor [10log(1/x)] (dB)
802.11b	8.340	8.400	0.993	N/A
802.11g	2.087	2.139	0.976	0.106
802.11n-HT20	4.000	4.050	0.988	N/A
802.11n-HT40	3.990	4.040	0.988	N/A
802.11ax-HE20	3.980	4.030	0.988	N/A
802.11ax-HE40	3.970	4.020	0.988	N/A
802.11ax-HE20 (RU Config 26)	0.7533	0.8061	0.934	0.297
802.11ax-HE20 (RU Config 52)	1.454	1.507	0.965	0.155
802.11ax-HE20 (RU Config 106)	3.036	3.089	0.983	N/A
802.11ax-HE40 (RU Config 242)	1.410	1.470	0.959	0.182

Note: When duty cycle is less than 98% (0.98) that duty cycle factor  $10\log(1/x)$  is needed to add in conducted test items measured in average detector.

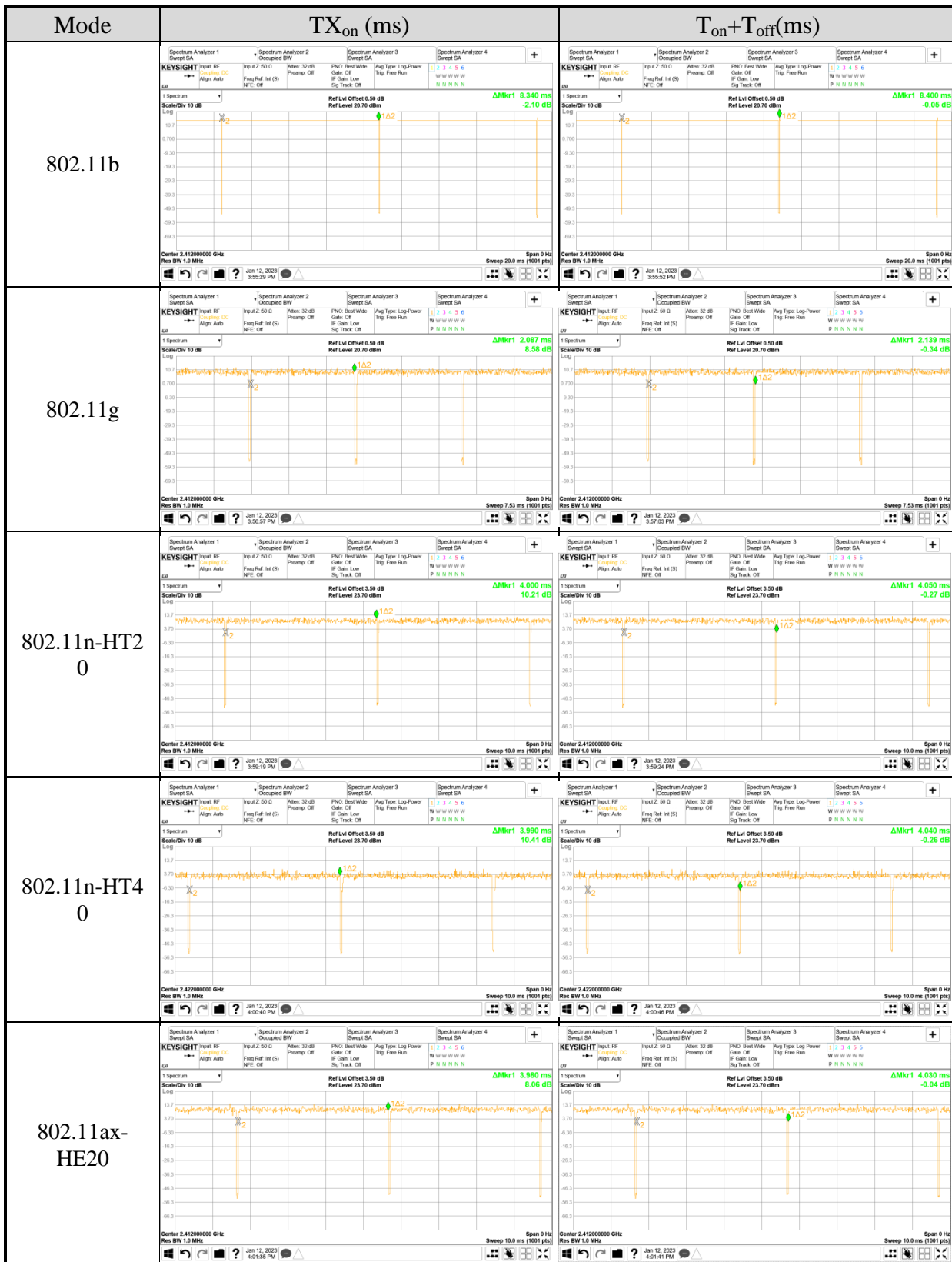

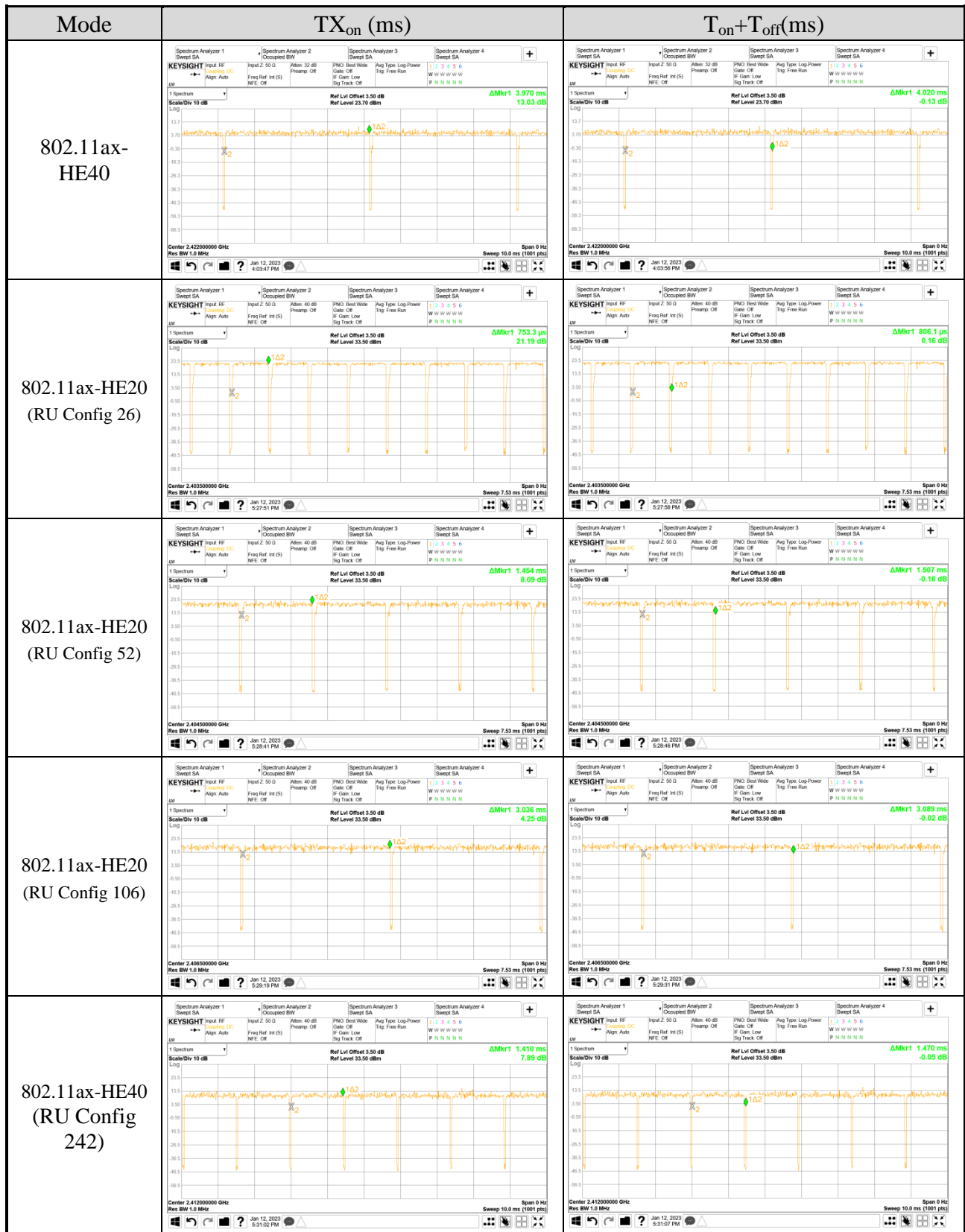



Mode	TX <sub>on</sub> (ms)	TX <sub>on+off</sub> (ms)	Duty Cycle (x)	Duty Cycle Factor [10log(1/x)] (dB)
BLE (2Mbps)	0.207	0.627	0.330	4.815

Note: When duty cycle is less than 98% (0.98) that duty cycle factor 10log(1/x) is needed to add in conducted test items measured in average detector.

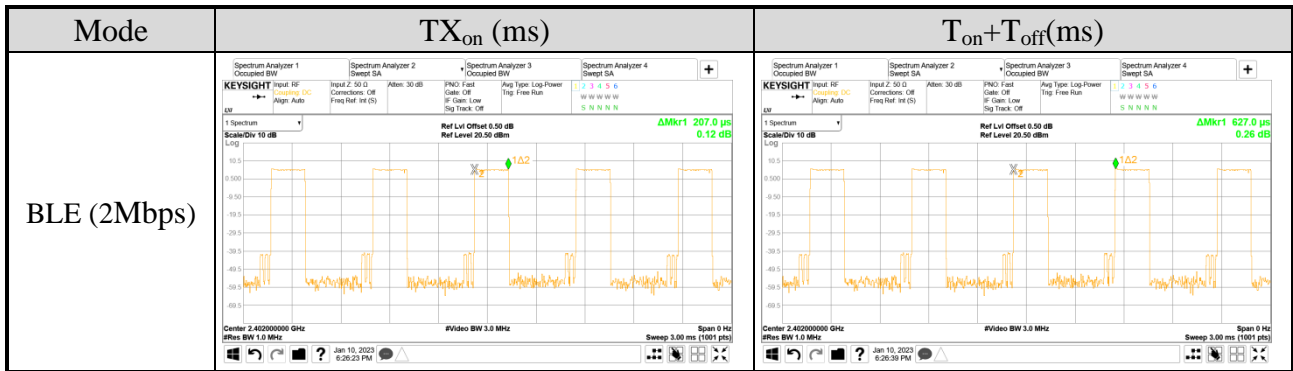

<b>AC Conduction</b>
Normal operation

Item	Mode	Data Rate	Test Channel
Radiated Test Case	Radiated Spurious Emission (30MHz~1GHz)	802.11ax-HE20	HE0 7

Item	Mode	Data Rate	Test Channel
Radiated Test Case	Radiated Band Edge <sup>Note1</sup>	802.11b	1Mbps 1/11/12/13
		802.11g	6Mbps 1/2/10/11/12/13
		802.11n-HT20	MCS8 1/2/3/10/11/12/13
		802.11n-HT40	MCS8 3/9/10/11
		802.11ax-HE20	HE0 1/2/3/10/11/12/13
		802.11ax-HE40	HE0 3/9/10/11
		BLE	2Mbps 37/39
	Radiated Spurious Emission <sup>Note1 &amp; 2</sup>	802.11b	1Mbps 7
		802.11g	6Mbps 7
		802.11n-HT20	MCS8 7
		802.11n-HT40	MCS8 7
		802.11ax-HE20	HE0 7
		802.11ax-HE40	HE0 7
		BLE	1Mbps 37/17/39

Item	Mode	RU Config	Test Channel
Radiated Test Case	Radiated Band Edge <sup>Note 1</sup>	802.11ax-HE20	26/0 52/37 106/53 26/8 52/40 106/54 1
		802.11ax-HE40	242/61 242/62 3 11

Item		Mode	Data Rate	Test Channel
Conducted Test Case	DTS/Occupied Bandwidth	802.11b	1Mbps	1/7/11/13
		802.11g	6Mbps	1/7/11/13
		802.11n-HT20	MCS8	1/7/11/13
		802.11n-HT40	MCS8	3/7/9/11
		802.11ax-HE20	HE0	1/7/11/13
		802.11ax-HE40	HE0	3/7/9/11
		BLE	1Mbps	37/17/39
	Peak Output Power	802.11b	1Mbps	1/7/11/12/13
		802.11g	6Mbps	1/2/7/10/11/12/13
		802.11n-HT20	MCS8	1/2/3/7/10/11/12/13
		802.11n-HT40	MCS8	3/7/9/10/11
		802.11ax-HE20	HE0	1/2/3/7/10/11/12/13
		802.11ax-HE40	HE0	3/7/9/10/11
		BLE	1Mbps	37/17/39
			2Mbps	37/17/39
			PHY Coded S2	37/17/39
			PHY Coded S8	37/17/39
	Band Edge	802.11b	1Mbps	1/11/13
		802.11g	6Mbps	1/11/13
		802.11n-HT20	MCS8	1/11/13
		802.11n-HT40	MCS8	3/9/11
		802.11ax-HE20	HE0	1/11/13
		802.11ax-HE40	HE0	3/9/11
		BLE	1Mbps	37/39
	Spurious Emission	802.11b	1Mbps	1/7/11/13
		802.11g	6Mbps	1/7/11/13
		802.11n-HT20	MCS8	1/7/11/13
		802.11n-HT40	MCS8	3/7/9/11
		802.11ax-HE20	HE0	1/7/11/13
		802.11ax-HE40	HE0	3/7/9/11
		BLE	1Mbps	37/17/39
	Peak Power Spectral Density	802.11b	1Mbps	1/7/11/13
		802.11g	6Mbps	1/7/11/13
802.11n-HT20		MCS8	1/7/11/13	
802.11n-HT40		MCS8	3/7/9/11	
802.11ax-HE20		HE0	1/7/11/13	
802.11ax-HE40		HE0	3/7/9/11	
BLE		1Mbps	37/17/39	

Item		Mode	Data Rate	RU Configuration	Test Channel
Conduct ed Test Case	Peak Output Power	802.11ax-HE20	HE0	26/0	1
				52/37	
				106/53	
		802.11ax-HE40	HE0	26/8	13
				52/40	
				106/5	
	Peak Power Spectral Density	802.11ax-HE20	HE0	242/61	3
				242/62	11
		802.11ax-HE40	HE0	26/0	1
				52/37	
				106/53	
				26/8	13
52/40					
106/54	3				
242/61		11			
242/62	11				

Note 1:  Mobile Device       Portable Device

and 3 axis were assessed. The worst scenario for Radiated Spurious Emission as follow:

Lie     Side     Stand

Note 2: Low, mid, and high channels were measured, only the worst channel of each modulation was presented in this report.

Note 3: The modulation and bandwidth are similar for 802.11n mode for HT20/HT40 and 802.11ac mode for VHT20/VHT40, therefore investigated worst case to representative mode in the test report.

Note 4: The data rates were selected based on preliminary testing that identified rate as the worst case for output power.

### 3.8. Output Power Setting

Mode	Centre Frequency (MHz)	Power Setting		Mode	Centre Frequency (MHz)	Power Setting	
		AUX	Main			AUX	Main
802.11b	2412	20.000	20.000	802.11g	2412	17.000	17.000
	2442	20.000	20.000		2417	19.000	19.250
	2462	20.000	20.000		2442	20.000	20.000
	2467	19.000	18.750		2457	18.750	18.500
	2472	16.500	15.500		2462	16.750	16.750
						2467	14.500
				2472	11.500	11.500	

Mode	Centre Frequency (MHz)	Power Setting		Mode	Centre Frequency (MHz)	Power Setting	
		AUX	Main			AUX	Main
802.11n- HT20	2412	14.750	14.750	802.11n- HT40	2422	13.750	13.750
	2417	17.250	17.250		2442	14.750	14.750
	2422	18.250	18.250		2452	13.750	13.750
	2442	20.000	20.000		2457	7.250	7.250
	2457	18.250	18.250		2462	5.500	5.500
	2462	15.000	15.000				
	2467	11.000	11.000				
	2472	6.000	6.000				

Mode	Centre Frequency (MHz)	Power Setting		Mode	Centre Frequency (MHz)	Power Setting	
		AUX	Main			AUX	Main
802.11ax- HE20	2412	14.750	14.750	802.11ax- HE40	2422	13.750	13.750
	2417	17.250	17.250		2442	14.750	14.750
	2422	18.250	18.250		2452	13.750	13.750
	2442	20.000	20.000		2457	7.250	7.250
	2457	18.250	18.250		2462	5.500	5.500
	2462	15.000	15.000				
	2467	11.000	11.000				
	2472	6.000	6.000				

Mode	RU Configuration	Centre Frequency (MHz)	Power Setting	
			ANT (AUX)	ANT (Main)
802.11ax-HE20	26/0	2412	17.125	17.125
	52/37		16.750	16.750
	106/53		18.250	18.250
	26/0	2472	5.500	5.500
	52/37		6.000	6.000
	106/53		6.000	6.000
802.11ax-HE40	242/61	2422	15.000	15.000
	242/62	2462	6.000	6.000

Mode	Centre Frequency (MHz)	Power Setting			
		1M	2M	PHY Coded S2	PHY Coded S8
BLE	2402	Default	Default	Default	Default
	2440	Default	Default	Default	Default
	2480	Default	Default	Default	Default

### 3.9. Tested Supporting System List

#### 3.9.1. Support Peripheral Unit

No.	Product	Brand	Model No.	Serial No.	Approval
1.	Earphone	APPLE	N/A	N/A	N/A
Partner System					
2.	AP Server	ASUS	RT-AX88U	N/A	FCC ID: MSQ-RTAXHP00 IC: 3568A-RTAXHP00

#### 3.9.2. Cable Lists

No.	Cable Description Of The Above Support Units
1.	Earphone Cable: Unshielded, Undetachable, 1.2m
2.	AC adapter: M/N:WA-30B12, Cable: Unshielded, Detachable, 1.2m LAN cable: Unshielded, Detachable, 3.0m
3.	LAN cable: Unshielded, Detachable, 1.8m

### 3.10. Setup Configuration

#### 3.10.1. EUT Configuration for Power Line & Radiated Emission

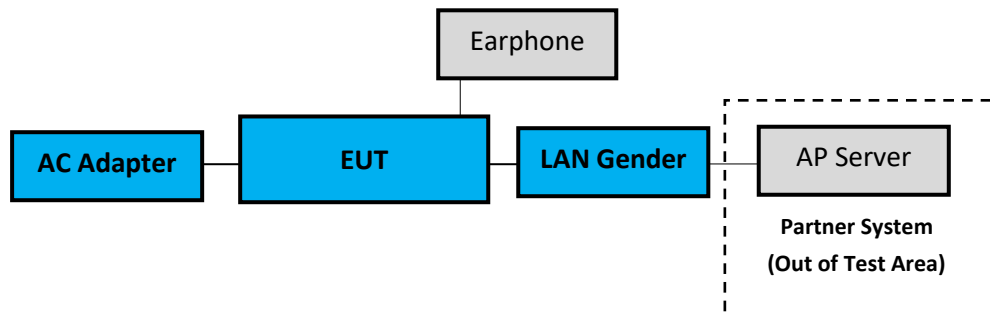

#### 3.10.2. EUT Configuration for RF Conducted Test Items

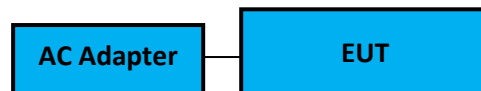

### 3.11. Operating Condition of EUT

Test program “DRTU” is used for enabling EUT BT or WLAN function under continues transmitting and choosing data rate/ channel.

[ANT AUX port (A Button in DRTU), ANT Main port (B Button in DRTU)].

### 3.12. Description of Test Facility

Name of Test Firm	Audix Technology Corporation / EMC Department No. 491, Zhongfu Rd., Linkou Dist., New Taipei City 244, Taiwan Tel: +886-2-26092133 Fax: +886-2-26099303 Website : www.audixtech.com Contact e-mail: attemc_report@audixtech.com
Accreditations	The laboratory is accredited by following organizations under ISO/IEC 17025:2017 (1) NVLAP(USA) NVLAP Lab Code 200077-0 (2) TAF(Taiwan) No. 1724
Test Facilities	FCC OET Designation Number under APEC MRA by NCC is : TW1724 ISED CAB Identifier Number under APEC TEL MRA by NCC is TW1724 (1) No.8 Shielded Room (2) No.1 3m Semi Anechoic Chamber



### 3.13.Measurement Uncertainty

Test Items/Facilities		Frequency Range	Uncertainty	
Conduction Test	<input type="checkbox"/>	No. 7 Shielded Room	9kHz-150kHz	±3.7dB
			150kHz-30MHz	±3.4dB
	<input checked="" type="checkbox"/>	No. 8 Shielded Room	9kHz-150kHz	±3.7dB
			150kHz-30MHz	±3.5dB
Radiation Test	<input checked="" type="checkbox"/>	No.1 3m Semi Anechoic Chamber	30MHz-200MHz, 3m, Horizontal	±3.8dB
			200MHz-1000MHz, 3m, Horizontal	±4.4dB
			30MHz-200MHz, 3m, Vertical	±4.5dB
			200MHz-1000MHz, 3m, Vertical	±4.7dB
			1GHz-6GHz, 3m	±4.9dB
			6GHz-18GHz, 3m	±4.5dB
	<input type="checkbox"/>	No.3 3m Semi Anechoic Chamber	30MHz-200MHz, 3m, Horizontal	±4.0dB
			200MHz-1000MHz, 3m, Horizontal	±4.3dB
			30MHz-200MHz, 3m, Vertical	±4.6dB
			200MHz-1000MHz, 3m, Vertical	±4.7dB
			1GHz-6GHz, 3m	±4.8dB
			6GHz-18GHz, 3m	±4.5dB
	<input type="checkbox"/>	No.4 3m Semi Anechoic Chamber	30MHz-200MHz, 3m, Horizontal	±4.3dB
			200MHz-1000MHz, 3m, Horizontal	±4.3dB
			30MHz-200MHz, 3m, Vertical	±4.6dB
			200MHz-1000MHz, 3m, Vertical	±4.7dB
			1GHz-6GHz, 3m	±4.8dB
			6GHz-18GHz, 3m	±4.4dB
	<input type="checkbox"/>	No.5 3m Semi Anechoic Chamber	30MHz-200MHz, 3m, Horizontal	±4.3dB
			200MHz-1000MHz, 3m, Horizontal	±4.3dB
			30MHz-200MHz, 3m, Vertical	±4.5dB
			200MHz-1000MHz, 3m, Vertical	±4.6dB
			1GHz-6GHz, 3m	±4.9dB
			6GHz-18GHz, 3m	±4.1dB
	Radiated emissions (18GHz-40GHz)		18GHz-40GHz, 3m	±3.4dB

Remark : Uncertainty =  $ku_c(y)$

Test Item	Uncertainty
6dB Bandwidth	$\pm 0.05\text{kHz}$
Maximum peak output power	$\pm 0.33\text{dB}$
Power spectral density	$\pm 0.13\text{dB}$
Conducted Emission Limitations	$\pm 0.13\text{dB}$

## 4. MEASUREMENT EQUIPMENT LIST

### 4.1. Conducted Emission Measurement

Item	Type	Manufacturer	Model No.	Serial No.	Cal. Date	Cal. Interval
1.	Test Receiver	R&S	ESR3	101774	2023. 01. 11	1 Year
2.	A.M.N.	R&S	ENV432	101567	2022. 05. 26	1 Year
3.	L.I.S.N.	Kyoritsu	KNW-407	8-855-9	2022. 12. 19	1 Year
4.	Pulse Limiter	R&S	ESH3-Z2	100354	2022. 12. 14	1 Year
5.	Digital Thermo-Hygro Meter	iMax	HTC-1	No.8 S/R	2022. 04. 14	1 Year
6.	Coaxial Cable	Yeida	RG/58AU	CE-08	2022. 09. 07	1 Year
7.	Test Software	Audix	e3	V9 18621a	N.C.R.	N.C.R.

### 4.2. Radiated Emission Measurement

Item	Type	Manufacturer	Model No.	Serial No.	Cal. Date	Cal. Interval
1.	Spectrum Analyzer	Agilent	N9010A-526	MY53400071	2022. 08. 24	1 Year
2.	Test Receiver	R&S	ESCS30	100039	2022. 06. 01	1 Year
3.	Amplifier	HP	8447D	2944A06305	2022. 12. 29	1 Year
4.	Microwave Amplifier	Keysight	83051A	MY56480113	2022. 09. 07	1 Year
5.	Microwave Amplifier	Agilent	8449B	3008A02678	2022. 02. 22	1 Year
6.	Loop Antenna	TESEQ	HLA 6121	60478	2022. 02. 17	1 Year
7.	Bilog Antenna	TESEQ	CBL6112D	33821	2022. 07. 01	1 Year
8.	Double-Ridged Waveguide Horn	ETS-Lindgren	3117	00135902	2022. 03. 21	1 Year
9.	Horn Antenna	COM-POWER	AH-840	101092	2022. 12. 30	1 Year
10.	2.4GHz Notch Filter	K&L Microwave	7NSL10-2441 .5/E130.5-O/O	2	2022 .07. 23	1 Year
11.	3GHz Notch Filter	Microwave	H3G018G1	484796	2022 .07. 23	1 Year
12.	Coaxial Cable	MIYAZAKI	5D2W	RE-11	2023. 01. 07	1 Year
13.	Coaxial Cable	HUBER+SUHNER	SUCOFLEX 106	RE-14	2023. 01. 07	1 Year
14.	Coaxial Cable	HUBER+SUHNER	SUCOFLEX 102	RE-30	2022. 08. 22	1 Year
15.	Digital Thermo-Hygro Meter	iMax	HTC-1	No.1 3m A/C	2022. 04. 14	1 Year
16.	Test Software	Audix	e3	V9 18621a	N.C.R.	N.C.R.

### 4.3.RF Conducted Measurement

Item	Type	Manufacturer	Model No.	Serial No.	Cal. Date	Cal. Interval
1.	Spectrum Analyzer	Keysight	N9020B-544	MY57120357	2022. 03. 02	1 Year
2.	Power Meter	Anritsu	ML2495A	2127005	2022. 12. 01	1 Year
3.	Power Meter	Anritsu	ML2495A	2127004	2022. 12. 07	1 Year
4.	Power Sensor	Anritsu	MA2411B	1911360	2022. 12. 07	1 Year
5.	Power Sensor	Anritsu	MA2411B	1911356	2022. 12. 01	1 Year
6.	Digital Thermo-Hygro Meter	iMax	HTC-1	RF-03	2022. 04. 14	1 Year

## 5. CONDUCTED EMISSION

### 5.1. Block Diagram of Test Setup

#### 5.1.1. Block Diagram of EUT

Indicated as section 3.10

#### 5.1.2. Shielded Room Setup Diagram

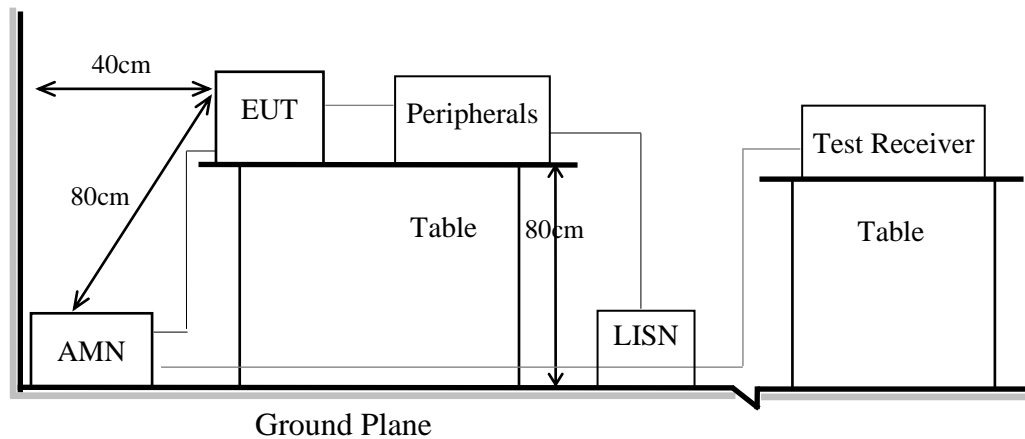

### 5.2. Conducted Emission Limit

Frequency	Conducted Limit	
	Quasi-Peak Level	Average Level
150kHz ~ 500kHz	66 ~ 56 dB $\mu$ V	56 ~ 46 dB $\mu$ V
500kHz ~ 5MHz	56 dB $\mu$ V	46 dB $\mu$ V
5MHz ~ 30MHz	60 dB $\mu$ V	50 dB $\mu$ V

Remark1.: If the average limit is met when using a Quasi-Peak detector, the measurement using the average detector is not required.

2.: The lower limit applies to the band edges.

### 5.3. Test Procedure

- 5.3.1. To set up the EUT as indicated in ANSI C63.10. The EUT was placed on the table which has 80 cm height to the ground and 40 cm distance to the conducting wall.
- 5.3.2. Power supplier of the EUT was connected to the AC mains through an Artificial Mains Network (A.M.N.).
- 5.3.3. The AC power supplies to all peripheral devices must be provided through line impedance stabilization network (L.I.S.N.)
- 5.3.4. Checking frequency range from 150kHz to 30 MHz and record the emission which does not have 20 dB below limit.

### 5.4. Test Results

Please refer to Appendix A.

## 6. RADIATED EMISSION

### 6.1. Block Diagram of Test Setup

#### 6.1.1. Block Diagram of EUT

Indicated as section 3.10

#### 6.1.2. Setup Diagram for 9kHz-30MHz

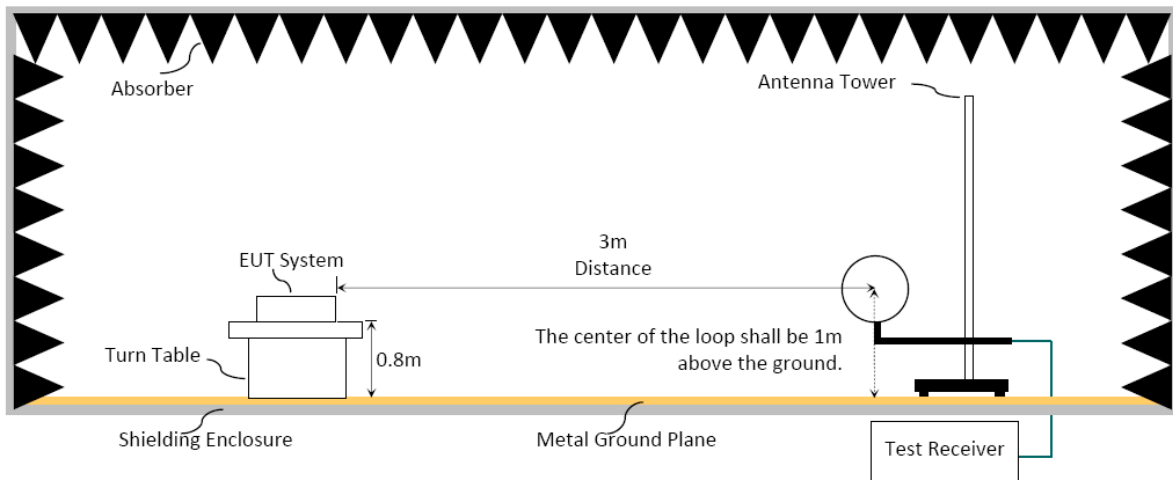

#### 6.1.3. Setup Diagram for 30-1000MHz

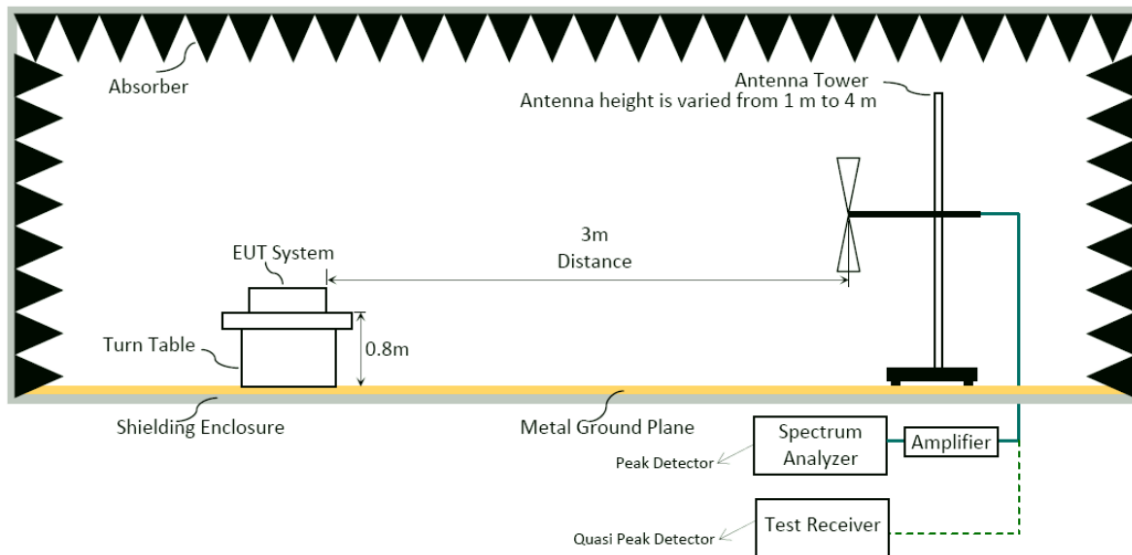

6.1.4. Setup Diagram for above 1GHz

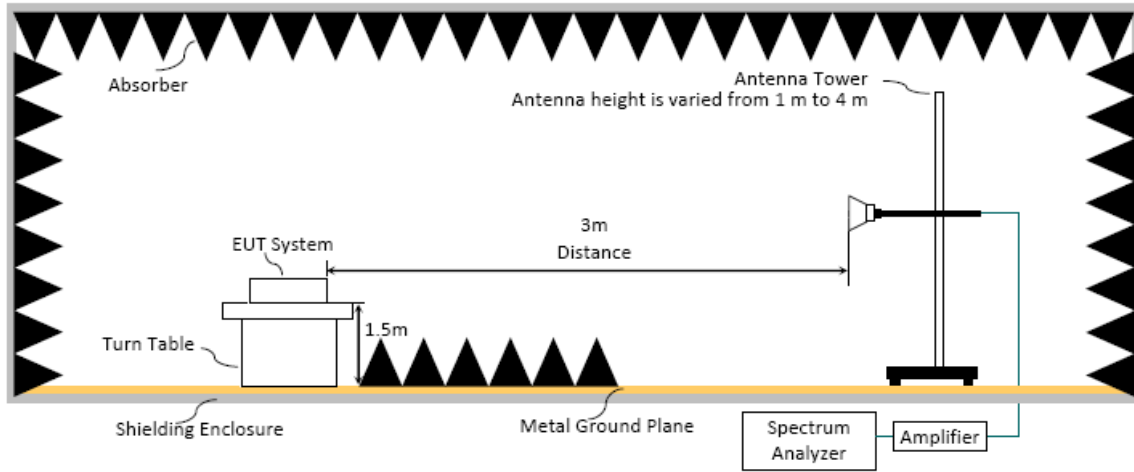

## 6.2. Radiated Emission Limits

In any 100kHz bandwidth outside the frequency band, the radio frequency power produced by the intentional radiator shall be at least 20dB below that in the 100kHz bandwidth within the band that contains the highest level. In addition, radiated emissions which fall in restricted bands, as defined in Section 15.205/RSS-Gen Section 8.10 table 6, must also comply with the radiated emission limits specified as below.

Frequency (MHz)	Distance(m)	Limits	
		dB $\mu$ V/m	$\mu$ V/m
0.009 - 0.490	300	67.6-20 log f(kHz)	2400/f kHz
0.490 - 1.705	30	87.6-20 log f(kHz)	24000/f kHz
1.705 - 30	30	29.5	30
30 - 88	3	40.0	100
88- 216	3	43.5	150
216- 960	3	46.0	200
Above 960	3	54.0	500
Above 1000	3	74.0 dB $\mu$ V/m (Peak) 54.0 dB $\mu$ V/m (Average)	

Remark : (1) dB $\mu$ V/m = 20 log ( $\mu$ V/m)

- (2) The tighter limit applies to the edge between two frequency bands.
- (3) Distance refers to the distance in meters between the measuring instrument antenna and the closed point of any part of the device or system.
- (4) Fundamental and emission fall within operation band are exempted from this section.
- (5) Pursuant to ANSI C63.10: 6.6.4.3, if the maximized peak measured value complies with the average limit, then it is unnecessary to perform an average measurement.



### 6.3. Test Procedure

#### Frequency Range 9kHz~30MHz:

The EUT setup on the turntable which has 0.8 m height to the ground. The turn table rotated 360 degrees and antenna fixed to 1 m to find the maximum emission level. In order to find the maximum emission, all of the interface cables were manipulated according to ANSI C63.10-2013 regulation.

- (1) RBW = 9kHz with peak and average detector.
- (2) Detector: average and peak (9kHz-490kHz)  
Q.P. (490kHz-30MHz)

#### Frequency Range 30MHz ~ 25GHz:

The EUT setup on the turn table which has 80cm (for 30-1000MHz) and 1.5m (for above 1GHz) height to the ground. The turn table rotated 360 degrees and antenna varied from 1 m to 4 m to find the maximum emission level. Both horizontal and vertical polarization are required. In order to find the maximum emission, all of the interface cables were manipulated according to ANSI C63.10-2013 regulation.

#### Frequency below 1GHz:

Spectrum Analyzer is used for pre-testing with following setting:

- (1)RBW = 120KHz
- (2)VBW  $\geq$  3 x RBW.
- (3)Detector = Peak.
- (4)Sweep time = auto.
- (5)Trace mode = max hold.
- (6)Allow sweeps to continue until the trace stabilizes.

Note 1: When peak-detected value is lower than limit that the measurement using the Q.P. detector is not required, otherwise using Q.P. for final measurement.

Note 2: When the radiated emissions limits are expressed in terms of the average value of the emissions, and pulsed operation is employed, the measurement field strength shall be determined by averaging over one complete pulse train, including blanking intervals, as long as the pulse train does not exceed 0.1 seconds.

#### Frequency above 1GHz to 10th harmonic (up to 25 GHz):

##### Peak Detector:

- (1)RBW = 1MHz
- (2)VBW  $\geq$  3 x RBW.
- (3)Detector = Peak.
- (4)Sweep time = auto.
- (5)Trace mode = max hold.
- (6)Allow sweeps to continue until the trace stabilizes.

Note: When peak-detected value is lower than limit that the measurement using the average detector is not required, otherwise using average detector for final measurement.

**Average Detector:**

**Option 1:**

(1) RBW = 1MHz

(2) VBW  $\geq 1/T$ . (Duty Cycle < 98%, when duty cycle presented in section 3.7)

Modulation Type	VBW Setting (VBW $\geq 1/T$ )
802.11g	510Hz
802.11ax-HE20 (RU Config 26)	1.5kHz
802.11ax-HE20 (RU Config 52)	750Hz
802.11ax-HE40 (RU Config 242)	750Hz
BLE (2Mbps)	5.1kHz

(3) VBW = 10Hz (Duty Cycle  $\geq 98\%$ , when duty cycle presented in section 3.7)

Modulation Type	VBW Setting
802.11b	10Hz
802.11n-HT20	10Hz
802.11n-HT40	10Hz
802.11ax-HE20	10Hz
802.11ax-HE40	10Hz
802.11ax-HE20 (RU Config 106)	10Hz

(4) Detector = Peak.

(5) Sweep time = auto.

(6) Trace mode = max hold.

(7) Allow sweeps to continue until the trace stabilizes.

**Option 2:**

Average Emission Level = Peak Emission Level + D.C.C.F.

**6.4. Measurement Result Explanation**

Peak Emission Level (dB $\mu$ V/m) = Antenna Factor (dB/m) + Cable Loss (dB) – Preamp Gain (dB) + Reading (dB $\mu$ V).

Average Emission Level (dB $\mu$ V/m) = Antenna Factor (dB/m) + Cable Loss (dB) – Preamp Gain (dB) + Reading (dB $\mu$ V).

Average Emission Level (dB $\mu$ V/m) = Peak Emission Level (dB $\mu$ V/m) + DCCF (dB)  
 Duty Cycle Correction Factor (DCCF) (dB) =  $20\log(TX_{on}/TX_{on+off})$  presented in section 3.7.

ERP (dBm) = Peak Emission Level (dB $\mu$ V/m) - 95.2dB - 2.14dB

**6.5. Test Results**

Please refer to Appendix A.

## 7. DTS/OCCUPIED BANDWIDTH

### 7.1. Block Diagram of Test Setup

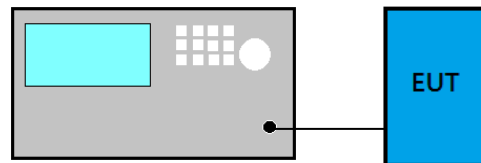

### 7.2. Specification Limits

The minimum 6dB bandwidth shall be at least 500kHz.

### 7.3. Test Procedure

Following measurement procedure is reference to ANSI C63.10:2013:

#### For DTS Bandwidth

- (1) Set RBW = 100 kHz.
- (2) Set the video bandwidth (VBW)  $\geq 3 \times$  RBW.
- (3) Detector = Peak.
- (4) Trace mode = max hold.
- (5) Sweep = auto couple.
- (6) Allow the trace to stabilize.
- (7) Setting channel bandwidth function x to -6dB power to record the final bandwidth..

#### For 99% Occupied Bandwidth

- (1) Set Span range 1.5~5 times the OBW
- (2) Set RBW close to 1% to 5% of OBW.
- (3) Set  $VBW \geq 3 \times RBW$ .
- (4) Detector = Peak.
- (5) Trace mode = Max hold
- (6) Sweep = Auto couple.
- (7) Allow the trace to stabilize.

### 7.4. Test Results

Please refer to Appendix A

## 8. MAXIMUM PEAK OUTPUT POWER

### 8.1. Block Diagram of Test Setup

- For WLAN Function

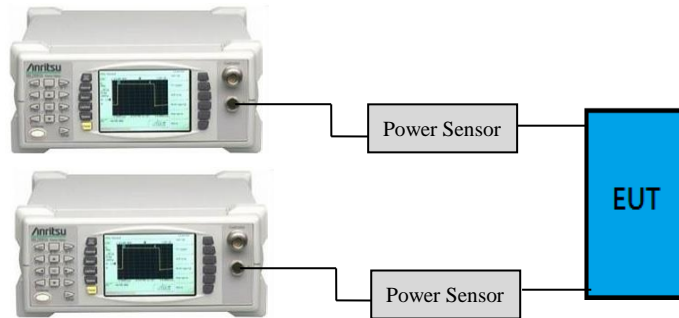

- For BLE Function

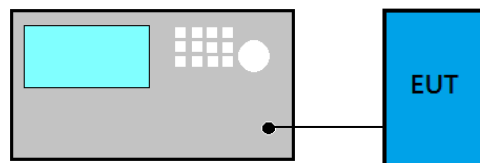

### 8.2. Specification Limits

The Limits of maximum Peak Output Power for digital modulation in 2400-2483.5MHz is : 1Watt. (30dBm), and E.I.R.P.: 4Watt (36dBm)

### 8.3. Test Procedure

Following measurement procedure is reference to ANSI C63.10:2013:

**■ PKPM1 Peak power meter method:**

EUT is connected to power sensor and record the maximum output power.

**■ Maximum peak conducted output power method:**

- (1) Set the RBW  $\geq$  DTS bandwidth
- (2) Set VBW  $\geq 3 \times$  RBW
- (3) Set span  $\geq 3 \times$  RBW.
- (4) Sweep time = auto couple
- (5) Detector = peak.
- (6) Trace mode = max hold.
- (7) Allow trace to fully stabilize.
- (8) Use peak marker function to determine the peak amplitude level.

**■ Method AVGPM (Measurement using an RF average power meter):**

EUT is connected to power sensor and record the maximum average output power and duty cycle factor is added when duty cycle presented in section 3.7 is  $< 98\%$ .

**Method AVGSA-2 (Spectrum channel power)**

- (1) Set span to at least 1.5 times the OBW
- (2) Set RBW = 1 -5% of OBW
- (3) Set the video bandwidth (VBW)  $\geq 3 \times$  RBW.
- (4) Detector = RMS.
- (5) Trace mode = trace average at least 100 traces
- (6) Sweep = auto couple.
- (7) Compute power by integrating the spectrum across the OBW of the signal using the instrument's band power measurement function with band limits set equal to the OBW band edges.
- (8) Duty cycle factor is added when duty cycle presented in section 3.7 is  $< 98\%$ .

### 8.4. Test Results

Please refer to Appendix A

## 9. EMISSION LIMITATIONS

### 9.1. Block Diagram of Test Setup

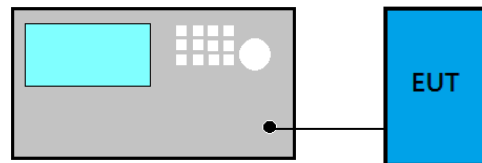

### 9.2. Specification Limits

In any 100kHz bandwidth outside the frequency band in which the spread spectrum or digitally modulated intentional radiator is operating, the radio frequency power that is produced by the intentional radiator shall be at least 20dB below that in the 100kHz bandwidth within the band that contains the highest level of the desired power, based on either an RF conducted or a radiated measurement. If the transmitter complies with the conducted power limits based on the use of RMS averaging over a time interval, that the required attenuation shall be 30 dB instead of 20 dB.

Attenuation below the general limits specified in Section 15.209(a)/RSS-Gen Section 8.9 table 4 is not required. In addition, radiated emissions which fall in restricted bands, as defined in Section 15.205(a)/RSS-Gen Section 8.10 table 6, must also comply with the radiated emission limits specified in Section 15.209(a)/RSS-Gen Section 8.9 table 4 (See Section 15.205(c)).

### 9.3. Test Procedure

Following measurement procedure is reference to ANSI C63.10:2013:

#### ■ Reference Level

- (1) Set analyzer center frequency to DTS channel center frequency.
- (2) Set the span to 1.5 times the DTS bandwidth.
- (3) Set the RBW to: 100 kHz.
- (4) Set the VBW  $\geq 3 \times$  RBW.
- (5) Detector = peak.
- (6) Sweep time = auto couple.
- (7) Trace mode = max hold.
- (8) Allow trace to fully stabilize to find the max PSD as reference level.

#### ■ Emission Level Measurement

- (1) Set analyzer center frequency to DTS channel center frequency.
- (2) Set the span to 1.5 times the DTS bandwidth.
- (3) Set the RBW to: 100 kHz.
- (4) Set the VBW  $\geq 3 \times$  RBW.
- (5) Detector = peak.
- (6) Sweep time = auto couple.
- (7) Trace mode = max hold.
- (8) Allow trace to fully stabilize to find the max level.

### 9.4. Test Results

Please refer to Appendix A

## 10. POWER SPECTRAL DENSITY

### 10.1. Block Diagram of Test Setup

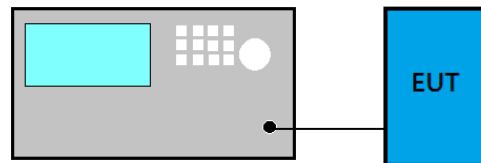

### 10.2. Specification Limits

The peak power spectral density conducted from the intentional radiator to the antenna shall not be greater than 8dBm in any 3kHz band.

### 10.3. Test Procedure

Following measurement procedure is reference to ANSI C63.10:2013:

#### ■ Method PKPSD (peak PSD)

- (1) Set analyzer center frequency to DTS channel center frequency.
- (2) Set the span to 1.5 times the DTS bandwidth.
- (3) Set the RBW to:  $3 \text{ kHz} \leq \text{RBW} \leq 100 \text{ kHz}$ .
- (4) Set the VBW  $\geq 3 \times \text{RBW}$ .
- (5) Detector = peak.
- (6) Sweep time = auto couple.
- (7) Trace mode = max hold.
- (8) Allow trace to fully stabilize.
- (9) Use the peak marker function to determine the maximum amplitude level.
- (10) If measured value exceeds limit, reduce RBW (no less than 3 kHz) and repeat.

#### □ Method AVGPSD-2

- (1) Using peak PSD procedure step 1 to step 4.
- (2) Detector = RMS detector
- (3) Sweep time = auto couple
- (4) Trace mode = trace averaging over a minimum of 100 traces
- (5) Use the peak marker function to determine the maximum amplitude level.
- (6) Duty cycle factor is added when duty cycle presented in section 3.7 < 98%.
- (7) If measured value exceeds limit, reduce RBW (no less than 3 kHz) and repeat.

### 10.4. Test Results

Please refer to Appendix A





## **11.DEVIATION TO TEST SPECIFICATIONS**

**【NONE】**



*Audix Technology Corp.*  
*No. 491, Zhongfu Rd., Linkou Dist.,*  
*New Taipei City 244, Taiwan*

*Tel: +886 2 26099301*  
*Fax: +886 2 26099303*

---

# APPDNDIX A

## TEST DATA AND PLOTS

(Model: 15Z90RT)



# APPDNDIX B

## TEST PHOTOGRAPHS

(Model: 15Z90RT)