

## FCC 15.407 U-NII 5GHz Test Report

for

**LG Electronics Inc.**

**222, LG-ro, Jinwi-myeon Pyeongtaek-Si, Gyeonggi-Do,  
17709 Republic of Korea**

**Product Name** : Notebook Computer  
**Model Name** : (1)15Z90RT (2)15ZB90RT  
(3)15ZD90RT  
(4)15ZG90RT  
**Brand** : LG  
**FCC ID** : BEJNT-15Z90RT

**Prepared by:** : AUDIX Technology Corporation,  
EMC Department



The test report is based on a single evaluation of one sample of the above-mentioned products. It does not imply an assessment of the whole production and does not permit the use of the test lab logo.

## TABLE OF CONTENTS

Description	Page
TEST REPORT.....	4
<b>1. REVISION RECORD OF TEST REPORT .....</b>	<b>5</b>
<b>2. SUMMARY OF TEST RESULTS .....</b>	<b>6</b>
<b>3. GENERAL INFORMATION .....</b>	<b>7</b>
3.1. Description of Application .....	7
3.2. Description of EUT .....	8
3.3. Reference Test Guidance.....	9
3.4. Antenna Information .....	9
3.5. EUT Specifications Assessed in Current Report .....	10
3.6. Description of Key Components .....	13
3.7. Test Configuration.....	15
3.8. Output Power Setting .....	23
3.9. Tested Supporting System List.....	26
3.10. Setup Configuration.....	26
3.11. Operating Condition of EUT .....	27
3.12. Description of Test Facility .....	27
3.13. Measurement Uncertainty .....	28
<b>4. MEASUREMENT EQUIPMENTLIST.....</b>	<b>29</b>
4.1. Conducted Emission Measurement .....	29
4.2. Radiated Emission Measurement .....	30
4.3. RF Conducted Measurement .....	30
<b>5. CONDUCTED EMISSION.....</b>	<b>31</b>
5.1. Block Diagram of Test Setup .....	31
5.2. Conducted Emission Limit .....	31
5.3. Test Procedure .....	31
5.4. Test Results .....	31
<b>6. RADIATED EMISSION .....</b>	<b>32</b>
6.1. Block Diagram of Test Setup .....	32
6.2. Radiated Emission Limits.....	33
6.3. Test Procedure .....	35
6.4. Measurement Result Explanation.....	36
6.5. Test Results .....	36
<b>7. EMISSION/OCCUPIED BANDWIDTH.....</b>	<b>37</b>
7.1. Block Diagram of Test Setup .....	37
7.2. Specification Limits.....	37
7.3. Test Procedure .....	37
7.4. Test Results .....	38
<b>8. MAXIMUM OUTPUT POWER .....</b>	<b>39</b>
8.1. Block Diagram of Test Setup .....	39
8.2. Specification Limits.....	39
8.3. Test Procedure .....	40
8.4. Test Results .....	40
<b>9. POWER SPECTRAL DENSITY .....</b>	<b>41</b>
9.1. Block Diagram of Test Setup .....	41

---

9.2. Specification Limits.....	41
9.3. Test Procedure .....	41
9.4. Test Results .....	41
<b>10. FREQUENCY STABILITY .....</b>	<b>42</b>
10.1. Block Diagram of Test Setup .....	42
10.2. Specification Limits.....	42
10.3. Test Procedure .....	42
10.4. Test Results .....	42
<b>11. DEVIATION TO TEST SPECIFICATIONS .....</b>	<b>43</b>

APPENDIX A TEST DATA AND PLOTS  
APPENDIX B TESTPHOTOGRAPHS

## TEST REPORT

Applicant : LG Electronics Inc.  
Manufacturer : LG Electronics Inc.  
Factory : LG Electronics Nanjing New Technology Co., Ltd.  
EUT Description  
(1) Product : Notebook Computer  
(2) Model : (1)15Z90RT (2)15ZB90RT (3)15ZD90RT (4)15ZG90RT  
(3) Brand : LG  
(4) Power Supply: DC 20V, 3.25A

Applicable Standards:

Title 47 FCC CFR Part 15 Subpart E

**Audix Technology Corp.** tested the equipment mentioned in accordance with the requirements set forth in the above standards. Test results indicate that the equipment tested is capable of demonstrating compliance with the requirements as documented within this report.

**Audix Technology Corp.** does not assume responsibility for any conclusions and generalizations drawn from the test results with regard to other specimens and samples.

Date of Report: 2023. 02. 10

Reviewed by:  (Annie Yu/Administrator)

Approved by:  (Johnny Hsueh/Section Manager)

## 1. REVISION RECORD OF TEST REPORT

Edition No	Issued Date	Revision Summary	Report Number
0	2023. 02. 10	Original Report	EM-F230113

## 2. SUMMARY OF TEST RESULTS

Rule	Description	Results
15.207	Conducted Emission	PASS
15.205/15.209	Undesirable Emissions Limits: Radiated Band Edge and Radiated Spurious Emission	PASS
15.407(a)(5)/15.407(e)	Emission/Occupied Bandwidth	PASS
15.407(a)	Maximum Output Power	PASS
15.407(b)	Conducted Band Edges	N/A
15.407(a)	Power Spectral Density	PASS
15.407	Frequency Stability	PASS
15.407(h)(2)	Dynamic Frequency Selection(DFS)	PASS, Please refer to test report No. EM-F230114
15.203	Antenna Requirement	Compliance

Note: The uncertainties value is not used in determining the result.

### 3. GENERAL INFORMATION

#### 3.1. Description of Application

Applicant	LG Electronics Inc. 222, LG-ro, Jinwi-myeon Pyeongtaek-Si, Gyeonggi-Do, 17709 Republic of Korea
Manufacturer	LG Electronics Inc. 222, LG-ro, Jinwi-myeon Pyeongtaek-Si, Gyeonggi-Do, 17709 Republic of Korea
Factory	LG Electronics Nanjing New Technology Co., Ltd. No.346, Yaoxin Road, Economic & Technical Development Zone, Nanjing, China.
Product	Notebook Computer
Model	(1)15Z90RT (2)15ZB90RT (3)15ZD90RT (4)15ZG90RT The difference between all models is different in the sales customers and color difference.
Brand	LG

### 3.2. Description of EUT

Test Model	15Z90RT		
Serial Number	N/A		
Power Rating	DC 20V, 3.25A		
Software Version	XY (X, Y can be 0 to 9 for different SW version not influence RF parameter)		
RF Features	WLAN:802.11 a/b/g/n/ac/ax Bluetooth: BT and BLE (BT 5.1)		
Transmit Type	2.4 GHz		
	802.11b	1T1R	
	802.11g	1T1R	
	802.11n-HT20	2T2R	
	802.11n-HT40	2T2R	
	802.11ax-HE20	2T2R	
	802.11ax-HE40	2T2R	
	BT/BLE	1T1R	
	U-NII Bands		
	802.11a	1T1R	
	802.11n-HT20/802.11ac-VHT20/802.11ax-HE20	2T2R	
	802.11n-HT40/802.11ac-VHT40/802.11ax-HE40	2T2R	
	802.11ac-VHT80/802.11ax-HE80	2T2R	
	802.11ac-VHT160/802.11ax-HE160	2T2R	
	The MIMO is uncorrelated and supported SDM (Spatial Division Multiplexing) mode only. This radio device doesn't support beamforming and Cyclic Delay Diversity (CDD).		
Device Category	<input type="checkbox"/> Outdoor Access Point <input type="checkbox"/> Fixed point-to-point Access Point <input type="checkbox"/> Indoor Access Point <input checked="" type="checkbox"/> Mobile and Portable client device		
Test Sample	Sample No.	Test Item	Firmware
	02	AC Conduction, RSE, RF Conducted	N/A
Sample Status	Trial sample		
Date of Receipt	2023. 01. 05		
Date of Test	2023. 01. 12 ~ 02. 08		
Interface Ports of EUT	<ul style="list-style-type: none"> <li>• Three USB Type C Port</li> <li>• One Earphone Port</li> </ul>		
Accessories Supplied	<ul style="list-style-type: none"> <li>• AC Adapter</li> <li>• USB C Cable</li> <li>• LAN Gender</li> </ul>		



### 3.3. Reference Test Guidance

KDB 789033 D02 General UNII Test Procedures New Rules v02r01  
 KDB 662911 D01 Multiple Transmitter Output v02r01  
 ANSI C63.10:2013

### 3.4. Antenna Information

No.	Antenna Part Number	Manufacture	Antenna Type	Frequency (MHz)	Gain(dBi)		Directional Gain <sup>Note1 &amp; 2</sup>
					Main	AUX	
1.	WA-P-LELE-04-044	INPAQ	Mono-Pole	2400	3.20	3.70	3.46
				2450	3.60	3.90	3.75
				2500	3.30	4.20	3.77
				5150	1.90	2.40	2.16
				5470	2.70	1.10	1.97
				5850	1.30	1.10	1.20
				5925	1.60	1.60	1.60
				6525	-0.50	0.30	-0.08
				7125	3.90	3.00	3.47

According to KDB 662911 D01 d) ii), transmit signals are completely uncorrelated, then

$$\text{Directional gain} = 10 \log[(10^{G1/10} + 10^{G2/10} + \dots + 10^{GN/10})/N_{ANT}] \text{ dBi}$$

Note 1. WLAN 2.4GHz: Directional gain =

$$2400\text{MHz: Directional gain} = 10 \log[(10^{3.2/10} + 10^{3.7/10})/2] = 3.46\text{dBi}$$

$$2450\text{MHz: Directional gain} = 10 \log[(10^{3.6/10} + 10^{3.9/10})/2] = 3.75\text{dBi}$$

$$2500\text{MHz: Directional gain} = 10 \log[(10^{3.3/10} + 10^{4.2/10})/2] = 3.77\text{dBi}$$

Note 2. WLAN 5G/6GHz: Directional gain =

$$5150\text{MHz: Directional gain} = 10 \log[(10^{1.9/10} + 10^{2.4/10})/2] = 2.16\text{dBi}$$

$$5470\text{MHz: Directional gain} = 10 \log[(10^{2.7/10} + 10^{1.1/10})/2] = 1.97\text{dBi}$$

$$5850\text{MHz: Directional gain} = 10 \log[(10^{1.3/10} + 10^{1.1/10})/2] = 1.20\text{dBi}$$

$$5925\text{MHz: Directional gain} = 10 \log[(10^{1.6/10} + 10^{1.6/10})/2] = 1.60\text{dBi}$$

$$6525\text{MHz: Directional gain} = 10 \log[(10^{-0.5/10} + 10^{0.3/10})/2] = -0.08\text{dBi}$$

$$7125\text{MHz: Directional gain} = 10 \log[(10^{3.9/10} + 10^{3.0/10})/2] = 3.47\text{dBi}$$

We chose the antenna gain corresponding to the frequency listed on the table which is closer to center frequency of WLAN/BT.

### 3.5. EUT Specifications Assessed in Current Report

Mode	U-NII Band	Fundamental Range (MHz)	Channel Number
802.11a	1	5180-5240	4
	2A	5260-5320	4
	2C	5500-5720	12
	3	5745-5825	5
802.11n-HT20/ 802.11ac-VHT20 802.11ax-HE20	1	5180-5240	4
	2A	5260-5320	4
	2C	5500-5720	12
	3	5745-5825	5
802.11n-HT40/ 802.11ac-VHT40 802.11ax-HE40	1	5190-5230	2
	2A	5270-5310	2
	2C	5510-5710	6
	3	5755-5795	2
802.11ac-VHT80 802.11ax-HE80	1	5210	1
	2A	5290	1
	2C	5530-5690	3
	3	5775	1
802.11ac-VHT160 802.11ax-HE160	1	5250	1
	2A		
	2C	5570	1

Remark: U-NII Band 2A and 2C (DFS Function, Slave/no In service monitor, no Ad-Hoc mode)

Mode	Modulation	Data Rate (Mbps)
802.11a	OFDM (BPSK/QPSK/16QAM/64QAM)	Up to 54
802.11n-HT20	OFDM (BPSK/QPSK/16QAM/64QAM)	Up to 144.4
802.11n-HT40		Up to 300
802.11ac-VHT20	OFDM (BPSK/QPSK/16QAM/64QAM/256QAM)	Up to 173.3
802.11ac-VHT40		Up to 400
802.11ac-VHT80		Up to 866.7
802.11ac-VHT160		Up to 1733.3
802.11ax-HE20	OFDMA (BPSK/ QPSK/ 16QAM/ 64QAM/ 256QAM/1024QAM)	Up to 287
802.11ax-HE40		Up to 574
802.11ax-HE80		Up to 1201
802.11ax-HE160		Up to 2402

Channel List					
802.11a/802.11n-HT20/802.11ac-VHT20/802.11ax-HE20					
U-NII Band	Channel Number	Frequency (MHz)	U-NII Band	Channel Number	Frequency (MHz)
1	36	5180	2C	120	5600
	40	5200		124	5620
	44	5220		128	5640
	48	5240		132	5660
2A	52	5260		136	5680
	56	5280		140	5700
	60	5300		144	5720
	64	5320		3	149
2C	100	5500	153		5765
	104	5520	157		5785
	108	5540	161		5805
	112	5560	165		5825
	116	5580			

Channel List					
802.11n-HT40/802.11ac-VHT40/802.11ax-HE40					
U-NII Band	Channel Number	Frequency (MHz)	U-NII Band	Channel Number	Frequency (MHz)
1	38	5190	2C	118	5590
	46	5230		126	5630
2A	54	5270		134	5670
	62	5310		142	5710
2C	102	5510	3	151	5755
	110	5550		159	5795

Channel List					
802.11ac-VHT80/802.11ax-HE80					
U-NII Band	Channel Number	Frequency (MHz)	U-NII Band	Channel Number	Frequency (MHz)
1	42	5210	2C	138	5690
2A	58	5290	3	155	5775
2C	106	5530			
	122	5610			

Channel List					
802.11ac-VHT160/802.11ax-HE160					
U-NII Band	Channel Number	Frequency (MHz)	U-NII Band	Channel Number	Frequency (MHz)
1	50	5250	2C	114	5570
2A					

Note: Test modes are presented at section 3.7.

### 3.6. Description of Key Components

#### 3.6.1. For the All Component Lists

Item	Supplier	Model / Type	Character
System	Microsoft	Win 11	---
	---	Non-OS	---
Main Board	LG	15Z90RT MAIN B/D PCB	Manufacturer: #1 Hannstar Board Tech (Jiang Yin) Corp.,Ltd. #2 Elec&Eltek Company (MCO) Limited.
WLAN SUB Board	LG	15Z90RT SUB B/D	Manufacturer: #1 Hannstar Board Tech (Jiang Yin)Corp.,Ltd. #2 Elec&Eltek Company (MCO) Limited.
CPU (Socket: BGA1744)	Intel	i7-1360P	2.2GHz
	Intel	i5-1340P	1.9GHz
	Intel	i3-1315U	1.2GHz
15.6" LCD Panel	Samsung	ATNA56YX08-0	Resolution: 1920x1080@60Hz (OLED,FHD)
Storage (SSD) TW USE	SK hynix	HFS256GEJ9X101N	256GB
		HFS512GEJ9X101N	512GB
		HFS001TEJ9X101N	1TB
		HFS002TEJ9X101N	2TB
	Samsung	MZ-VL22560	256GB
		MZ-VLQ256B	256GB
		MZ-VL25120	512GB
		MZ-VL21T00	1TB
		MZ-VL22T00	2TB
Memory (RAM)	Samsung	---	32GB LPDDR5 6000 MHz (On Board)
		---	16GBLPDDR5 6000 MHz (On Board)
		---	8GB LPDDR5 6000 MHz (On Board)
	SK Hynix	---	32GBLPDDR5 6000 MHz (On Board)
		---	16GBLPDDR5 6000 MHz (On Board)
		---	8GB LPDDR5 6000 MHz (On Board)
Battery Pack	LG	LB2122LM	DC15.52V, 60Wh Typ 3866 mAh
WLAN Combo Card	Intel	AX211D2W	WLAN and BT, 2x2 PCIe M.2 1216 SD adapter card FCC ID: PD9AX211D2 IC: 1000M-AX211D2
WLAN Combo Antenna	LG (INPAQ)	WA-P-LELE-04-044	PCB, Mono-pole Type Main: Black, Aux: Gray
Touch Pad	Lite on	SP8000(SG-A0620-00A)	---
	Elan	SB068D-26H0	---
Keyboard	TIC	KT0122L2	---
Web Camera	Luxvisions	2BG204N3(2Mic)	---

Item	Supplier	Model / Type	Character
LAN Gender (Type C to LAN)	SUZHOU MEC ELECTRONICS	80-5946-111	(White) 10/100Megabit Ethernet
		80-5946-101	(Black) 10/100 Megabit Ethernet
	ARIN TECH CO. LTD	GD-08MF-36-WH-LP10	(White) 10/100Megabit Ethernet
		GD-08MF-36-BK-LP11	(Black) 10/100 Megabit Ethernet
	HUIZHOU DEHONG TECHNOLOGY CO.,LTD.	370-50713	(White) 10/100Megabit Ethernet
		370-50714	(Black) 10/100 Megabit Ethernet
Type C to LAN: Shielded, Undetached, 0.12m			
AC Adapter	LG (PI ELECTRONICS)	LP65WFC20P-NJ W	(White) I/P: AC 100-240V, 1.6A, 50-60Hz O/P: (PDO) DC5V, 3A (15W) or DC9V, 3A (27W) or DC 15V,3A (45W) or DC 20V, 3.25A (65W) O/P: (PPS) DC5V- 20V, 3.25A, Max 65W Wall-Mounted: (2C)
			(Black) I/P: AC 100-240V, 1.6A, 50-60Hz O/P: (PDO) DC5V, 3A (15W) or DC9V, 3A (27W) or DC 15V,3A (45W) or DC 20V, 3.25A (65W) O/P: (PPS) DC5V- 20V, 3.25A, Max 65W Wall-Mounted: (2C)
	Type C Cable: Shielded, Detached, 2.0m		

Remark: For more detailed features description, please refer to the manufacturer’s specifications or the user manual.

3.6.2. The EUT collocates with following worst components, which are used to establish a basic configuration of system during test:

SKU (Mode)		1	
Main Board	LG, 15Z90RT MAIN B/D PCB	V	
WLAN SUB Board	LG, 15Z90RT SUB B/D	V	
CPU	Intel, i7-1360P	V	
Memory (RAM)	32GB	V	
15.6” LCD Panel	Samsung, ATNA56YX08-0	V	
Storage (SSD)	SK hynix, 256GB	V	
	Samsung, 2TB	V	
Battery Pack	LG, LB2122LM, 60Wh	V	
Touch Pad	Lite on, SP8000(SG-A0620-00A)	V	
WLAN Combo Card	Intel, AX211D2W	V	
WLAN Combo Antenna	LG (INPAQ), WA-P-LELE-04-044	V	
Type C	AC Adapter	LG(PI ELECTRONICS), LP65WFC20P-NJ W	V
	Link to LAN Gender	10/100Mbps	V
	Link to USB HUB	---	V

### 3.7. Test Configuration

Mode	TX <sub>on</sub> (ms)	TX <sub>on+off</sub> (ms)	Duty Cycle (x)	Duty Cycle Factor [10log(1/x)] (dB)
802.11a	2.094	2.132	0.982	N/A
802.11n-HT20	4.005	4.050	0.989	N/A
802.11n-HT40	3.990	4.050	0.985	N/A
802.11ac-VHT80	3.975	4.035	0.985	N/A
802.11ac-VHT160	2.780	2.830	0.982	N/A
802.11ax-HE20	3.975	4.020	0.989	N/A
802.11ax-HE40	3.975	4.020	0.989	N/A
802.11ax-HE80	3.975	4.035	0.985	N/A
802.11ax-HE160	2.280	2.330	0.979	0.092
802.11ax-HE20 (RU Config 26)	0.756	0.804	0.940	0.269
802.11ax-HE20 (RU Config 52)	1.460	1.505	0.970	0.132
802.11ax-HE20 (RU Config 106)	3.030	3.080	0.984	N/A
802.11ax-HE40 (RU Config 242)	1.410	1.460	0.966	0.150
802.11ax-HE80 (RU Config 484)	2.780	2.840	0.979	0.092
802.11ax-HE160 (RU Config 996)	1.330	1.390	0.957	0.191

Note: When duty cycle is less than 98% (0.98) that duty cycle factor 10log(1/x) is needed to add in conducted test items measured in average detector.

Mode	TX <sub>on</sub> (ms)	T <sub>on</sub> +T <sub>off</sub> (ms)
802.11a		
802.11n-HT20		
802.11n-HT40		
802.11ac-VHT80		
802.11ac-VHT160		



Mode	TX <sub>on</sub> (ms)	T <sub>on</sub> +T <sub>off</sub> (ms)
802.11ax-HE20		
802.11ax-HE40		
802.11ax-HE80		
802.11ax-HE160		

Mode	TX <sub>on</sub> (ms)	T <sub>on</sub> +T <sub>off</sub> (ms)
802.11ax-HE20 (RU Config 26)		
802.11ax-HE20 (RU Config 52)		
802.11ax-HE20 (RU Config 106)		
802.11ax-HE40 (RU Config 242)		

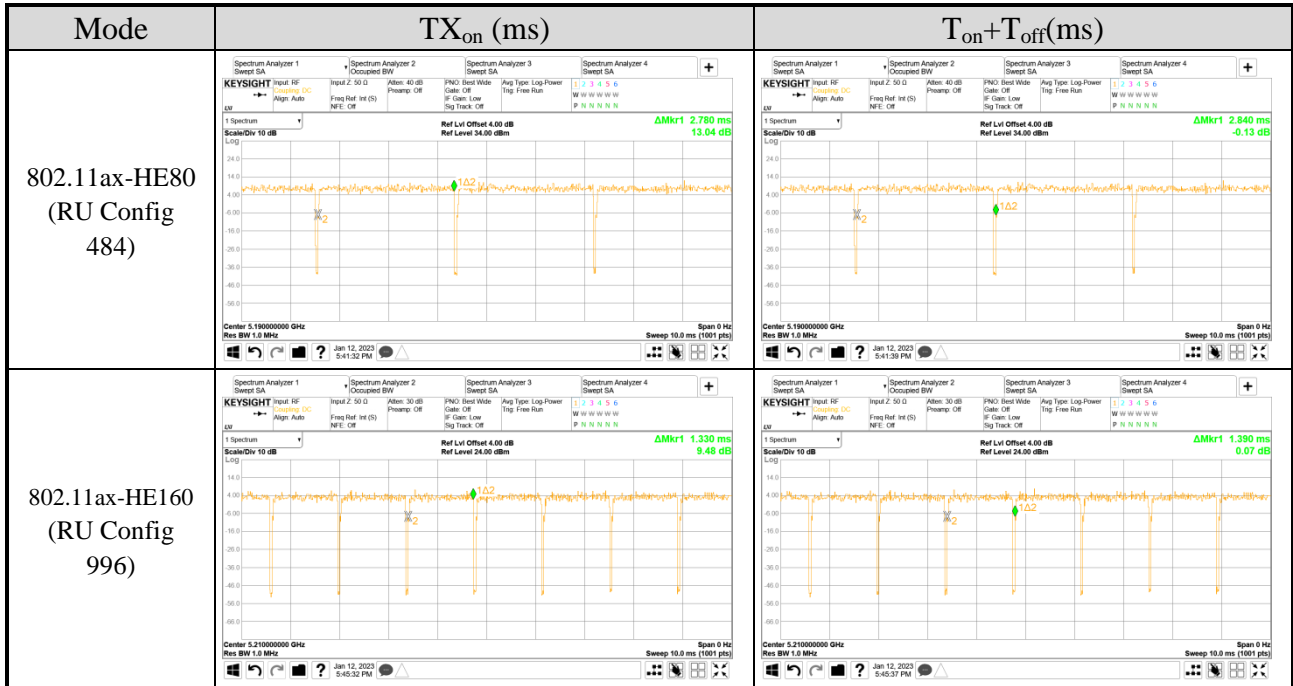

AC Conduction	
Normal operation	

Item	Mode	Data Rate	Test Channel	
Radiated Test Case	Radiated Spurious Emission (30MHz~1GHz)	802.11n-HT40	MCS0	46

Item	Mode	Data Rate	Test Channel	
Radiated Test Case	Radiated Band Edge Note1	802.11a	6 Mbps	36/64/100/140/144/149/165
		802.11n-HT20	MCS8	36/64/100/140/144/149/165
		802.11n-HT40	MCS8	38/62/102/134/142/151/159
		802.11ac-VHT80	MCS0	42/58/106/122/138/155
		802.11ac-VHT160	MCS0	50/114
		802.11ax-HE20	HE0	36/64/100/140/144/149/165
		802.11ax-HE40	HE0	38/62/102/134/142/151/159
		802.11ax-HE80	HE0	42/58/106/122/138/155
	802.11ax-HE160	HE0	50/114	
	Radiated Spurious Emission Note1 & 2	802.11a	6 Mbps	40/64/116/144/157
		802.11n-HT20	MCS8	40/60/116/144/157
		802.11n-HT40	MCS8	46/54/110/142/159
		802.11ac-VHT80	MCS0	42/58/122/138/155
		802.11ac-VHT160	MCS0	50/114
		802.11ax-HE20	HE0	48/52/100/144/165
		802.11ax-HE40	HE0	46/54/110/142/159
802.11ax-HE80		HE0	42/58/122/138/155	
802.11ax-HE160	HE0	50/114		

Item	Mode	Data Rate	RU Configuration	Test Channel	
Radiated Test Case	Radiated Band Edge Note1	802.11ax-HE20	HE0	26/0	36/100/149
			HE0	52/37	
			HE0	106/53	
		802.11ax-HE40	HE0	26/8	64/140/165
			HE0	52/40	
			HE0	106/54	
	802.11ax-HE80	HE0	242/61	38/102/151	
		HE0	242/62	62/134/159	
		HE0	484/65	42/106/155	
	802.11ax-HE160	HE0	484/66	58/122/155	
		HE0	996/67	50/114	
		HE0	996/S67	50/114	
			996/S67	50/114	

Item		Mode	Data Rate	Test Channel
Conducted Test Case	Emission/Occupied Bandwidth	802.11a	6 Mbps	36/40/48/52/60/64/100/116/140/144/149/157/165
		802.11n-HT20	MCS8	36/40/48/52/60/64/100/116/140/144/149/157/165
		802.11n-HT40	MCS8	38/46/54/62/102/110/134/142/151/159
		802.11ac-VHT80	MCS0	42/58/106/122/138/155
		802.11ac-VHT160	MCS0	50/114
		802.11ax-HE20	HE0	36/40/48/52/60/64/100/116/140/144/149/157/165
		802.11ax-HE40	HE0	38/46/54/62/102/110/134/142/151/159
		802.11ax-HE80	HE0	42/58/106/122/138/155
	802.11ax-HE160	HE0	50/114	
	Maximum output power	802.11a	6 Mbps	36/40/48/52/60/64/100/116/140/144/149/157/165
		802.11n-HT20	MCS8	36/40/48/52/60/64/100/116/140/144/149/157/165
		802.11n-HT40	MCS8	38/46/54/62/102/110/134/142/151/159
		802.11ac-VHT80	MCS0	42/58/106/122/138/155
		802.11ac-VHT160	MCS0	50/114
		802.11ax-HE20	HE0	36/40/48/52/60/64/100/116/140/144/149/157/165
		802.11ax-HE40	HE0	38/46/54/62/102/110/134/142/151/159
		802.11ax-HE80	HE0	42/58/106/122/138/155
	802.11ax-HE160	HE0	50/114	
	Power spectral density	802.11a	6 Mbps	36/40/48/52/60/64/100/116/140/144/149/157/165
		802.11n-HT20	MCS8	36/40/48/52/60/64/100/116/140/144/149/157/165
		802.11n-HT40	MCS8	38/46/54/62/102/110/134/142/151/159
		802.11ac-VHT80	MCS0	42/58/106/122/138/155
		802.11ac-VHT160	MCS0	50/114
		802.11ax-HE20	HE0	36/40/48/52/60/64/100/116/140/144/149/157/165
802.11ax-HE40		HE0	38/46/54/62/102/110/134/142/151/159	
802.11ax-HE80		HE0	42/58/106/122/138/155	
802.11ax-HE160	HE0	50/114		

Item		Mode	Data Rate	RU Configuration	Test Channel
Conducted Test Case	Maximum output power	802.11ax-HE20	HE0	26/0	36/100/149
				52/37	
				106/53	
			HE0	26/8	64/140/165
				52/40	
				106/5	
		802.11ax-HE40	HE0	242/61	38/102/151
			HE0	242/62	62/134/159
		802.11ax-HE80	HE0	484/65	42/106/155
			HE0	484/66	58/122/155
		802.11ax-HE160	HE0	996/67	50/114
			HE0	996/S67	50/114
Conducted Test Case	Power spectral density	802.11ax-HE20	HE0	26/0	36/100/149
				52/37	
				106/53	
			HE0	26/8	64/140/165
				52/40	
				106/54	
		802.11ax-HE40	HE0	242/61	38/102/151
			HE0	242/62	62/134/159
		802.11ax-HE80	HE0	484/65	42/106/155
			HE0	484/66	58/122/155
		802.11ax-HE160	HE0	996/67	50/114
			HE0	996/S67	50/114

Note 1:  Mobile Device  Portable Device  
 and 3 axis were assessed. The worst scenario for Radiated Spurious Emission as follow:  
 Lie  Side  Stand

Note 2: Low, mid, and high channels were measured, only the worst channel of each modulation was presented in this report.

Note 3: The modulation and bandwidth are similar for 802.11n mode for HT20/HT40 and 802.11ac mode for VHT20/VHT40, therefore investigated worst case to representative mode in the test report.

Note 4: The data rates were selected based on preliminary testing that identified rate as the worst case for output power.

### 3.8. Output Power Setting

Mode	U-NII Band	Centre Frequency (MHz)	Power Setting	
			AUX	Main
802.11a	1	5180	19.000	19.000
		5200	20.000	19.750
		5240	20.000	20.000
	2A	5260	20.000	20.000
		5300	20.000	20.000
		5320	19.500	19.250
	2C	5500	19.500	19.250
		5580	20.000	20.000
		5700	19.500	19.500
		5720	20.000	20.000
	3	5745	20.000	20.000
		5785	20.000	20.000
5825		20.000	20.000	

Mode	U-NII Band	Centre Frequency (MHz)	Power		Mode	U-NII Band	Centre Frequency (MHz)	Power Setting	
			AUX	Main				AUX	Main
802.11n-HT20	1	5180	17.000	17.000	802.11ax-HE20	1	5180	17.000	17.000
		5200	18.000	18.000			5200	18.000	18.000
		5240	18.000	18.000			5240	18.000	18.000
	2A	5260	18.000	18.000		2A	5260	18.000	18.000
		5300	18.000	18.000			5300	18.000	18.000
		5320	17.500	17.500			5320	17.500	17.500
	2C	5500	18.000	18.000		2C	5500	18.000	18.000
		5580	18.000	18.000			5580	18.000	18.000
		5700	17.500	17.500			5700	17.500	17.500
		5720	18.750	18.750			5720	18.750	18.750
	3	5745	20.000	20.000		3	5745	20.000	20.000
		5785	20.000	20.000			5785	20.000	20.000
5825		20.000	20.000	5825	20.000		20.000		

Mode	U-NII Band	Centre Frequency (MHz)	Power Setting		Mode	U-NII Band	Centre Frequency (MHz)	Power Setting	
			AUX	Main				AUX	Main
802.11n-HT40	1	5190	15.000	15.000	802.11ax-HE40	1	5190	15.000	15.000
		5230	20.000	20.000			5230	20.000	20.000
	2A	5270	20.000	20.000		2A	5270	20.000	20.000
		5310	15.250	15.250			5310	15.250	15.250
	2C	5510	17.000	17.000		2C	5510	17.000	17.000
		5550	20.000	20.000			5550	20.000	20.000
		5670	18.750	18.750			5670	18.750	18.750
		5710	17.500	17.500			5710	17.500	17.500
	3	5755	20.000	20.000		3	5755	20.000	20.000
		5795	20.000	20.000			5795	20.000	20.000

Mode	U-NII Band	Centre Frequency (MHz)	Power Setting		Mode	U-NII Band	Centre Frequency (MHz)	Power Setting	
			AUX	Main				AUX	Main
802.11ac-VT80	1	5210	14.000	14.000	802.11ax-HE80	1	5210	14.000	14.000
	2A	5290	15.250	15.250		2A	5290	15.250	15.250
	2C	5530	15.000	15.000		2C	5530	15.000	15.000
		5610	20.000	20.000			5610	20.000	20.000
		5690	20.000	20.000			5690	20.000	20.000
	3	5775	19.000	19.000		3	5775	19.000	19.000

Mode	U-NII Band	Centre Frequency (MHz)	Power Setting		Mode	U-NII Band	Centre Frequency (MHz)	Power Setting	
			AUX	Main				AUX	Main
802.11ac-VT160	1 / 2A	5250	14.000	14.000	802.11ax-HE160	1 / 2A	5250	11.000	11.000
	2C	5570	15.250	15.250		2C	5570	13.750	13.750



Mode	U-NII Band	Centre Frequency (MHz)	RU Configuration	Power Setting	
				AUX	Main
802.11ax-HE20	1	5180	26/0	10.000	10.000
			52/37	13.000	13.000
			106/53	16.000	16.000
	2A	5320	26/8	10.000	10.000
			52/40	13.000	13.000
			106/54	15.750	15.750
	2C	5500	26/0	10.000	10.000
			52/37	13.000	13.000
			106/53	15.250	15.250
		5700	26/8	10.000	10.000
			52/40	13.000	13.000
			106/54	16.000	16.000
	3	5745	26/0	16.000	16.000
			52/37	13.000	13.000
			106/53	17.500	17.500
5825		26/8	16.000	16.000	
		52/40	13.000	13.000	
		106/54	17.000	17.000	
802.11ax-HE40	1	5190	242/61	16.750	16.750
	2A	5310	242/62	16.250	16.250
	2C	5510	242/61	18.000	18.000
		5670	242/62	18.000	18.000
	3	5755	242/61	20.000	20.000
		5795	242/62	20.000	20.000
802.11ax-HE80	1	5210	484/65	14.000	14.000
	2A	5290	484/66	12.000	12.000
	2C	5530	484/65	15.250	15.250
		5610	484/66	19.250	19.250
	3	5775	484/65	19.500	19.500
			484/66	20.000	20.000
802.11ax-HE160	1/ 2A	5250	996/67	14.000	14.000
			996/S67	12.500	12.500
	2C	5570	996/67	14.000	14.000
			996/S67	17.750	17.750

### 3.9. Tested Supporting System List

#### 3.9.1. Support Peripheral Unit

No.	Product	Brand	Model No.	Serial No.	Approval
1.	Earphone	APPLE	N/A	N/A	N/A
Partner System					
2.	AP Server	ASUS	RT-AX88U	N/A	FCC ID: MSQ-RTAXHP00 IC: 3568A-RTAXHP00

#### 3.9.2. Cable Lists

No.	Cable Description Of The Above Support Units
1.	Earphone Cable: Unshielded, Undetachable, 1.2m
2.	AC adapter: M/N:WA-30B12, Cable: Unshielded, Detachable, 1.2m LAN cable: Unshielded, Detachable, 3.0m
3.	LAN cable: Unshielded, Detachable, 1.8m

### 3.10. Setup Configuration

#### 3.10.1. EUT Configuration for Power Line & Radiated Emission

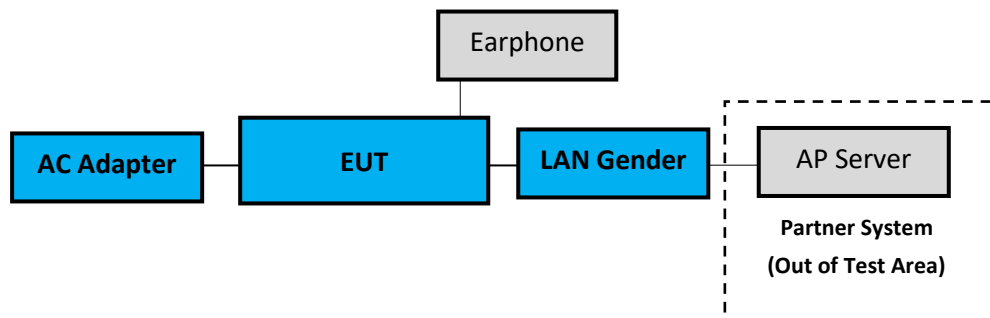

#### 3.10.2. EUT Configuration for RF Conducted Test Items

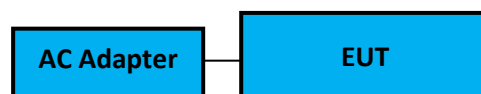

### 3.11. Operating Condition of EUT

Test program “DRTU” is used for enabling EUT WLAN function under continues transmitting and choosing data rate/ channel.

[ANT AUX port (A Button in DRTU) and ANT Main port (B Button in DRTU)].

### 3.12. Description of Test Facility

Name of Test Firm	Audix Technology Corporation / EMC Department No. 491, Zhongfu Rd., Linkou Dist., New Taipei City 244, Taiwan Tel: +886-2-26092133 Fax: +886-2-26099303 Website : www.audixtech.com Contact e-mail: attemc_report@audixtech.com
Accreditations	The laboratory is accredited by following organizations under ISO/IEC 17025:2017 (1) NVLAP(USA) NVLAP Lab Code 200077-0 (2) TAF(Taiwan) No. 1724
Test Facilities	FCC OET Designation Number under APEC MRA by NCC is : TW1724 ISED CAB Identifier Number under APEC TEL MRA by NCC is TW1724 (1) No.8 Shielded Room (2) No.1 3m Semi Anechoic Chamber

### 3.13.Measurement Uncertainty

Test Items/Facilities		Frequency Range	Uncertainty	
Conduction Test	<input type="checkbox"/>	No. 7 Shielded Room	9kHz-150kHz	±3.7dB
			150kHz-30MHz	±3.4dB
	<input checked="" type="checkbox"/>	No. 8 Shielded Room	9kHz-150kHz	±3.7dB
			150kHz-30MHz	±3.5dB
Radiation Test	<input checked="" type="checkbox"/>	No.1 3m Semi Anechoic Chamber	30MHz-200MHz, 3m, Horizontal	±3.8dB
			200MHz-1000MHz, 3m, Horizontal	±4.4dB
			30MHz-200MHz, 3m, Vertical	±4.5dB
			200MHz-1000MHz, 3m, Vertical	±4.7dB
			1GHz-6GHz, 3m	±4.9dB
			6GHz-18GHz, 3m	±4.5dB
	<input type="checkbox"/>	No.3 3m Semi Anechoic Chamber	30MHz-200MHz, 3m, Horizontal	±4.0dB
			200MHz-1000MHz, 3m, Horizontal	±4.3dB
			30MHz-200MHz, 3m, Vertical	±4.6dB
			200MHz-1000MHz, 3m, Vertical	±4.7dB
			1GHz-6GHz, 3m	±4.8dB
			6GHz-18GHz, 3m	±4.5dB
	<input type="checkbox"/>	No.4 3m Semi Anechoic Chamber	30MHz-200MHz, 3m, Horizontal	±4.3dB
			200MHz-1000MHz, 3m, Horizontal	±4.3dB
			30MHz-200MHz, 3m, Vertical	±4.6dB
			200MHz-1000MHz, 3m, Vertical	±4.7dB
			1GHz-6GHz, 3m	±4.8dB
			6GHz-18GHz, 3m	±4.4dB
	<input type="checkbox"/>	No.5 3m Semi Anechoic Chamber	30MHz-200MHz, 3m, Horizontal	±4.3dB
			200MHz-1000MHz, 3m, Horizontal	±4.3dB
			30MHz-200MHz, 3m, Vertical	±4.5dB
			200MHz-1000MHz, 3m, Vertical	±4.6dB
			1GHz-6GHz, 3m	±4.9dB
			6GHz-18GHz, 3m	±4.1dB
	Radiated emissions (18GHz-40GHz)		18GHz-40GHz, 3m	±3.4dB

Remark : Uncertainty =  $ku_c(y)$

Test Items	Uncertainty
Bandwidth	± 0.2kHz
Maximum output power	± 0.33dB
Power spectral density	± 0.13dB

## 4. MEASUREMENT EQUIPMENT LIST

### 4.1. Conducted Emission Measurement

Item	Type	Manufacturer	Model No.	Serial No.	Cal. Date	Cal. Interval
1.	Test Receiver	R&S	ESR3	101774	2023. 01. 11	1 Year
2.	A.M.N.	R&S	ENV432	101567	2022. 05. 26	1 Year
3.	L.I.S.N.	Kyoritsu	KNW-407	8-855-9	2022. 12. 19	1 Year
4.	Pulse Limiter	R&S	ESH3-Z2	100354	2022. 12. 14	1 Year
5.	Digital Thermo-Hygro Meter	iMax	HTC-1	No.8 S/R	2022. 04. 14	1 Year
6.	Coaxial Cable	Yeida	RG/58AU	CE-08	2022. 09. 07	1 Year
7.	Test Software	Audix	e3	V9 18621a	N.C.R.	N.C.R.

## 4.2. Radiated Emission Measurement

Item	Type	Manufacturer	Model No.	Serial No.	Cal. Date	Cal. Interval
1.	Spectrum Analyzer	Agilent	N9010A-526	MY53400071	2022. 08. 24	1 Year
2.	Test Receiver	R&S	ESCS30	100039	2022. 06. 01	1 Year
3.	Amplifier	HP	8447D	2944A06305	2022. 12. 29	1 Year
4.	Microwave Amplifier	Keysight	83051A	MY56480113	2022. 09. 07	1 Year
5.	Microwave Amplifier	Agilent	8449B	3008A02678	2022. 02. 22	1 Year
6.	Loop Antenna	TESEQ	HLA 6121	60478	2022. 02. 17	1 Year
7.	Bilog Antenna	TESEQ	CBL6112D	33821	2022. 07. 01	1 Year
8.	Double-Ridged Waveguide Horn	ETS-Lindgren	3117	00135902	2022. 03. 21	1 Year
9.	Horn Antenna	COM-POWER	AH-840	101092	2022. 12. 30	1 Year
10.	5G Notch Filter	Microwave Circuits	N0452502	459775	2022. 05. 04	1 Year
11.	5G Notch Filter	Microwave Circuits	N0555983	504921	2022. 08. 03	1 Year
12.	5G Notch Filter	Microwave Circuits	N0257881	459776	2022. 08. 10	1 Year
13.	Coaxial Cable	MIYAZAKI	5D2W	RE-11	2023. 01. 07	1 Year
14.	Coaxial Cable	HUBER+SUHNER	SUCOFLEX 106	RE-14	2023. 01. 07	1 Year
15.	Coaxial Cable	HUBER+SUHNER	SUCOFLEX 102	RE-30	2022. 08. 22	1 Year
16.	Digital Thermo-Hygro Meter	iMax	HTC-1	No.1 3m A/C	2022. 04. 14	1 Year
17.	Test Software	Audix	e3	V9 18621a	N.C.R.	N.C.R.

## 4.3. RF Conducted Measurement

Item	Type	Manufacturer	Model No.	Serial No.	Cal. Date	Cal. Interval
1.	Spectrum Analyzer	Keysight	N9020B-544	MY57120357	2022. 03. 02	1 Year
2.	Power Meter	Anritsu	ML2495A	2127005	2022. 12. 01	1 Year
3.	Power Meter	Anritsu	ML2495A	2127004	2022. 12. 07	1 Year
4.	Power Sensor	Anritsu	MA2411B	1911360	2022. 12. 07	1 Year
5.	Power Sensor	Anritsu	MA2411B	1911356	2022. 12. 01	1 Year
6.	Digital Thermo-Hygro Meter	iMax	HTC-1	RF-03	2022. 04. 14	1 Year

## 5. CONDUCTED EMISSION

### 5.1. Block Diagram of Test Setup

#### 5.1.1. Block Diagram of EUT

Indicated as section 3.10

#### 5.1.2. Shielded Room Setup Diagram

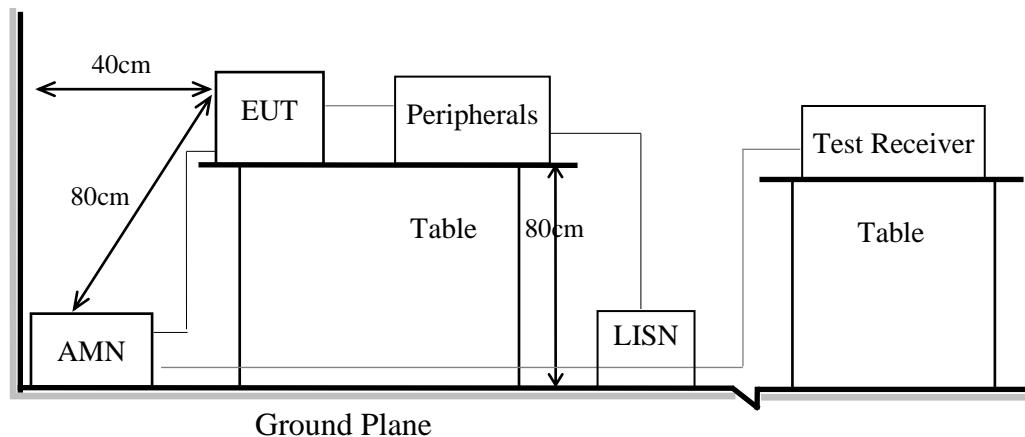

### 5.2. Conducted Emission Limit

Frequency	Conducted Limit	
	Quasi-Peak Level	Average Level
150kHz ~ 500kHz	66 ~ 56 dB $\mu$ V	56 ~ 46 dB $\mu$ V
500kHz ~ 5MHz	56 dB $\mu$ V	46 dB $\mu$ V
5MHz ~ 30MHz	60 dB $\mu$ V	50 dB $\mu$ V

Remark1.: If the average limit is met when using a Quasi-Peak detector, the measurement using the average detector is not required.

2.: The lower limit applies to the band edges.

### 5.3. Test Procedure

- 5.3.1. To set up the EUT as indicated in ANSI C63.10. The EUT was placed on the table which has 80 cm height to the ground and 40 cm distance to the conducting wall.
- 5.3.2. Power supplier of the EUT was connected to the AC mains through an Artificial Mains Network (A.M.N.).
- 5.3.3. The AC power supplies to all peripheral devices must be provided through line impedance stabilization network (L.I.S.N.)
- 5.3.4. Checking frequency range from 150kHz to 30 MHz and record the emission which does not have 20 dB below limit.

### 5.4. Test Results

Please refer to Appendix A.

## 6. RADIATED EMISSION

### 6.1. Block Diagram of Test Setup

#### 6.1.1. Block Diagram of EUT

Indicated as section 3.10

#### 6.1.2. Setup Diagram for 9kHz-30MHz

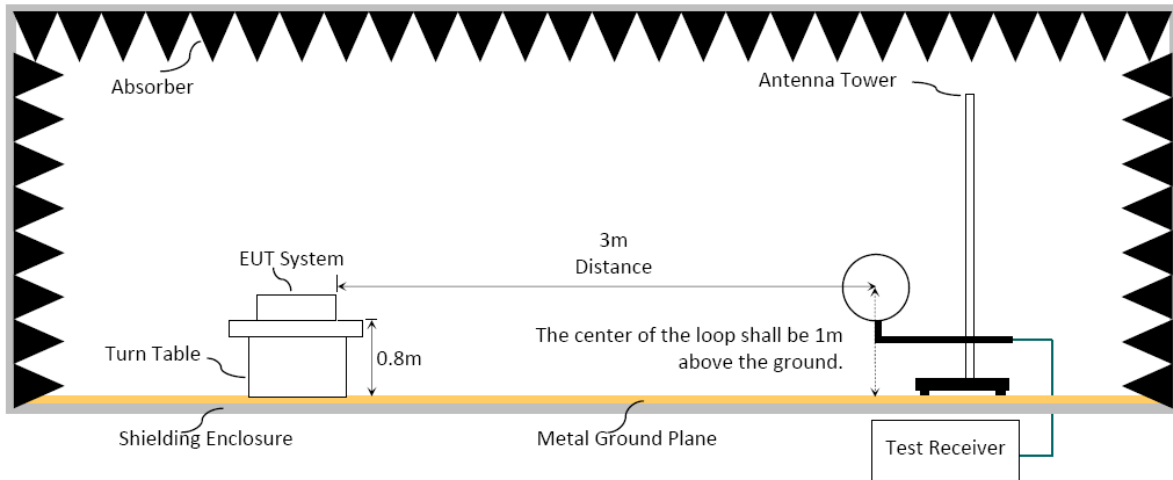

#### 6.1.3. Setup Diagram for 30-1000MHz

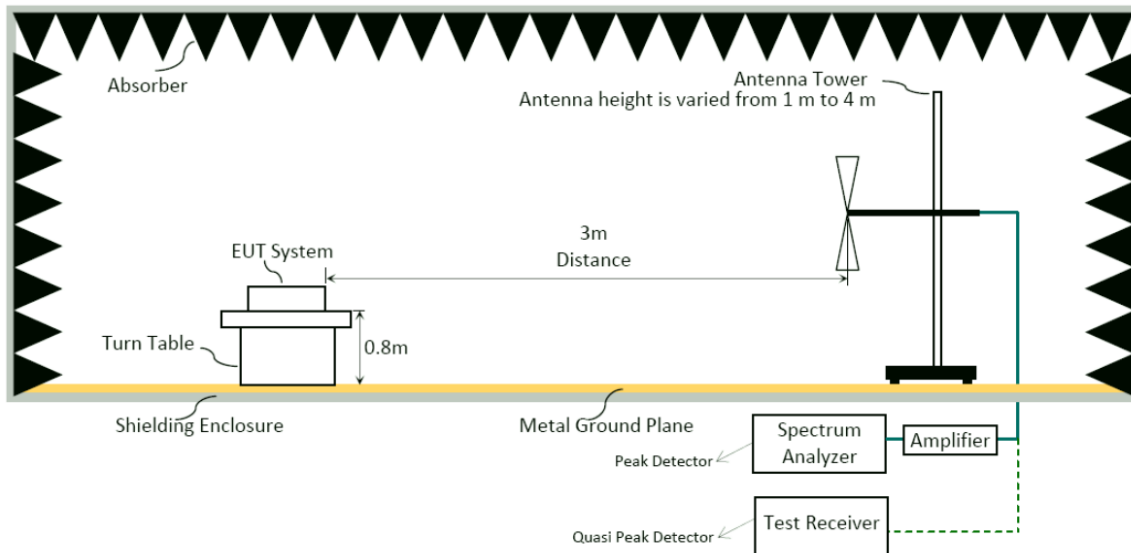



### 6.1.4. Setup Diagram for above 1GHz

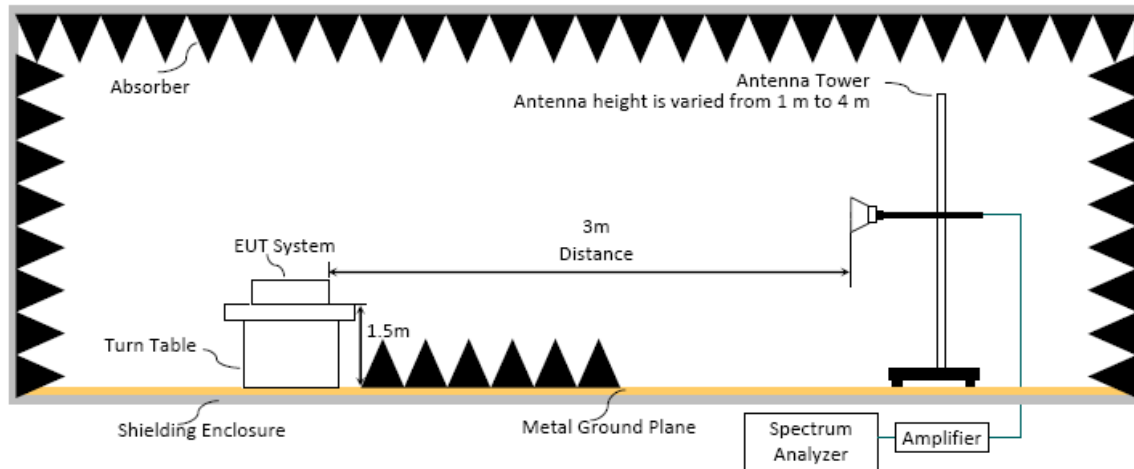

## 6.2. Radiated Emission Limits

Radiated emissions fall in restricted bands, as defined in Section 15.205 must be in compliance with the radiated emission limits specified in 15.209 as below.

### 6.2.1. General Limit

Frequency (MHz)	Distance(m)	Limits	
		dB $\mu$ V/m	$\mu$ V/m
0.009 - 0.490	300	67.6-20 log f(kHz)	2400/f kHz
0.490 - 1.705	30	87.6-20 log f(kHz)	24000/f kHz
1.705 - 30	30	29.5	30
30 - 88	3	40.0	100
88- 216	3	43.5	150
216- 960	3	46.0	200
Above 960	3	54.0	500
Above 1000	3	74.0 dB $\mu$ V/m (Peak) 54.0 dB $\mu$ V/m (Average)	

Remark : (1) dB $\mu$ V/m = 20 log ( $\mu$ V/m)

- (2) The tighter limit applies to the edge between two frequency bands.
- (3) Distance refers to the distance in meters between the measuring instrument antenna and the closed point of any part of the device or system.
- (4) Fundamental and emission fall within operation band are exempted from this section.
- (5) Pursuant to ANSI C63.10: 6.6.4.3, if the maximized peak measured value complies with the average limit, then it is unnecessary to perform an average measurement.

6.2.2. Limit for non-restricted frequency above 1 GHz

Frequency Band (MHz)	E.I.R.P. Limit	Field Strength Limit at 3 m
5150 to 5250	-27 dBm	68.2 dB $\mu$ V/m
5250 to 5350		68.2 dB $\mu$ V/m
5470 to 5725		68.2 dB $\mu$ V/m

Note: Field Strength at 3 m = E.I.R.P. + 95.2 dB

Frequency Band (MHz)	Field Strength Limit at 3 m	
5725 to 5850	<input checked="" type="checkbox"/>	15.407(b)(4)(i) All emissions shall be limited to a level of 68.2 dB $\mu$ V/m at 75 MHz or more above or below the band edge increasing linearly to 105.2 dB $\mu$ V/m at 25 MHz above or below the band edge increasing linearly to a level of 110.8 dB $\mu$ V/m at 5 MHz above or below the band edge increasing linearly to a level of 122.2 dB $\mu$ V/m at the band edge.
	<input type="checkbox"/>	15.407(b)(4)(ii), compliance with the emission limits in § 15.247(d) shall be at least 30dB below that in the 100 kHz bandwidth within the band that contains the highest level of the desired power. Attenuation below the general limits specified in § 15.209(a) is not required. In addition, radiated emissions which fall in the restricted bands, as defined in § 15.205(a), must also comply with the radiated emission limits specified in § 15.209(a) (see § 15.205(c))

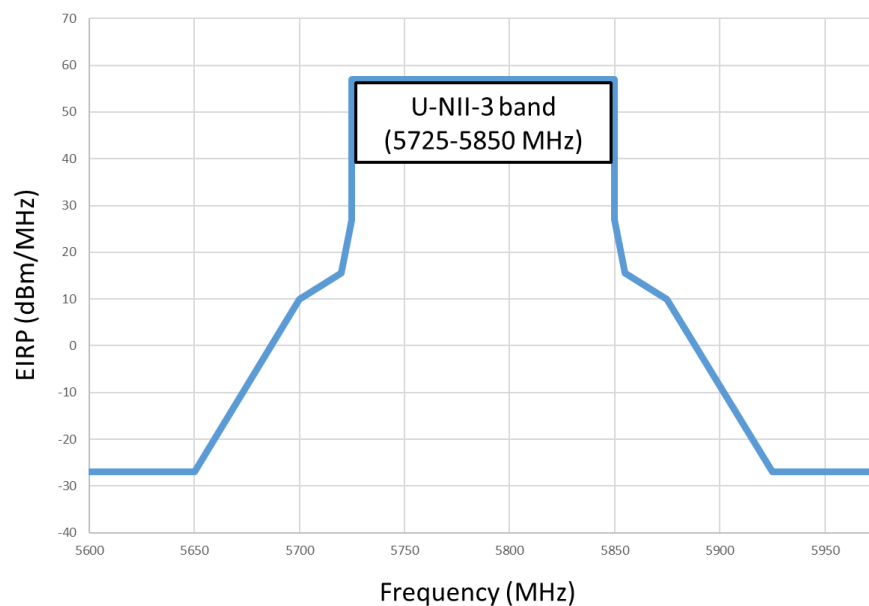

### 6.3. Test Procedure

#### Frequency Range 9kHz~30MHz:

The EUT setup on the turntable which has 0.8 m height to the ground. The turn table rotated 360 degrees and antenna fixed to 1 m to find the maximum emission level. In order to find the maximum emission, all of the interface cables were manipulated according to ANSI C63.10-2013 regulation.

- (1) RBW = 9kHz with peak and average detector.
- (2) Detector: average and peak (9kHz-490kHz)  
Q.P. (490kHz-30MHz)

#### Frequency Range 30MHz ~ 40GHz:

The EUT setup on the turn table which has 80cm (for 30-1000MHz) and 1.5m (for above 1GHz) height to the ground. The turn table rotated 360 degrees and antenna varied from 1 m to 4 m to find the maximum emission level. Both horizontal and vertical polarization are required. In order to find the maximum emission, all of the interface cables were manipulated according to ANSI C63.10-2013 regulation.

#### Frequency below 1GHz:

Spectrum Analyzer is used for pre-testing with following setting:

- (1)RBW = 120kHz
- (2)VBW  $\geq 3 \times$  RBW.
- (3)Detector = Peak.
- (4)Sweep time = auto.
- (5)Trace mode = max hold.
- (6)Allow sweeps to continue until the trace stabilizes.

Note 1: When peak-detected value is lower than limit that the measurement using the Q.P. detector is not required, otherwise using Q.P. for final measurement.

Note 2: When the radiated emissions limits are expressed in terms of the average value of the emissions, and pulsed operation is employed, the measurement field strength shall be determined by averaging over one complete pulse train, including blanking intervals, as long as the pulse train does not exceed 0.1 seconds.

#### Frequency above 1GHz to 10th harmonic(up to 40 GHz):

##### Peak Detector:

- (1)RBW = 1MHz
- (2)VBW  $\geq 3 \times$  RBW.
- (3)Detector = Peak.
- (4)Sweep time = auto.
- (5)Trace mode = max hold.
- (6)Allow sweeps to continue until the trace stabilizes.

Note: When peak-detected value is lower than limit that the measurement using the average detector is not required, otherwise using average detector for final measurement.

**Average Detector:**

**Option 1:**

(1) RBW = 1MHz

(2) VBW  $\geq 1/T$ . (Duty Cycle < 98%, when duty cycle presented in section 3.7)

Mode	VBW Setting (VBW $\geq 1/T$ )
802.11ac-VHT160	470Hz
802.11ax-HE20 (RU Config 26)	1.5kHz
802.11ax-HE20 (RU Config 52)	750Hz
802.11ax-HE40 (RU Config 242)	750Hz
802.11ax-HE80 (RU Config 484)	360Hz
802.11ax-HE160 (RU Config 996)	820Hz

(3) VBW = set VBW  $\leq$  RBW / 100, but not less than 10Hz (Duty Cycle  $\geq$  98%, when duty cycle presented in section 3.7)

Mode	VBW Setting
802.11a	10Hz
802.11n-HT20	10Hz
802.11n-HT40	10Hz
802.11ac-VHT80	10Hz
802.11ac-VHT160	10Hz
802.11ax-HE20	10Hz
802.11ax-HE40	10Hz
802.11ax-HE80	10Hz
802.11ax-HE20 (RU Config 106)	10Hz

(4) Detector = Peak.

(5) Sweep time = auto.

(6) Trace mode = max hold.

(7) Allow sweeps to continue until the trace stabilizes.

**Option 2:**

Average Emission Level(dB $\mu$ V/m)= Peak Emission Level(dB $\mu$ V/m)+ DCCF(dB).

**6.4. Measurement Result Explanation**

Peak Emission Level(dB $\mu$ V/m)=Antenna Factor(dB/m) + Cable Loss (dB)– Preamp Gain (dB)+ Reading(dB $\mu$ V).

Average Emission Level(dB $\mu$ V/m)= Antenna Factor(dB/m) + Cable Loss (dB)– Preamp Gain (dB)+ Reading(dB $\mu$ V).

Average Emission Level(dB $\mu$ V/m)= Peak Emission Level(dB $\mu$ V/m)+ DCCF(dB)  
 Duty Cycle Correction Factor (DCCF)(dB)= 20log(TX<sub>on</sub>/TX<sub>on+off</sub>) presented in section 3.7.

ERP(dBm)= Peak Emission Level(dB $\mu$ V/m) -95.2dB-2.14dB

**6.5. Test Results**

Please refer to Appendix A.

## 7. EMISSION/OCCUPIED BANDWIDTH

### 7.1. Block Diagram of Test Setup

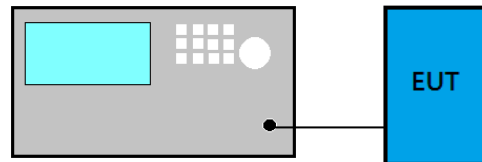

### 7.2. Specification Limits

Frequency Band (MHz)	Limit
5150 to 5250	Reference only
5250 to 5350	
5470 to 5725	
5725 to 5850	≥ 500kHz

### 7.3. Test Procedure

Following measurement procedure is reference to KDB 789033 D02 General UNII Test Procedures New Rules v02r01:

#### For Emission Bandwidth

- Applicable to all bands except to 5725 MHz- 5850 MHz
  - (1) Set RBW= 1% of the emission bandwidth
  - (2) Set VBW > RBW
  - (3) Detector = Peak
  - (4) Trace mode = max hold
  - (5) Setting channel bandwidth function x dB to -26 dB to record the final bandwidth.
- 5725 MHz- 5850 MHz
  - (1) Set RBW = 100 kHz.
  - (2) Set the video bandwidth (VBW) ≥ 3 × RBW.
  - (3) Detector = Peak.
  - (4) Trace mode = max hold.
  - (5) Sweep = auto couple.
  - (6) Allow the trace to stabilize.
  - (7) Setting channel bandwidth function x dB to -6 dB to record the final bandwidth.

#### **For 99% Occupied Bandwidth**

- (1) Set Span range 1.5~5 times the OBW
- (2) Set RBW close to 1% to 5% of OBW.
- (3) Set  $VBW \geq 3 \times RBW$ .
- (4) Detector = Peak.
- (5) Trace mode = Max hold
- (6) Sweep = Auto couple.
- (7) Allow the trace to stabilize.

#### **7.4. Test Results**

Please refer to Appendix A

## 8. MAXIMUM OUTPUT POWER

### 8.1. Block Diagram of Test Setup

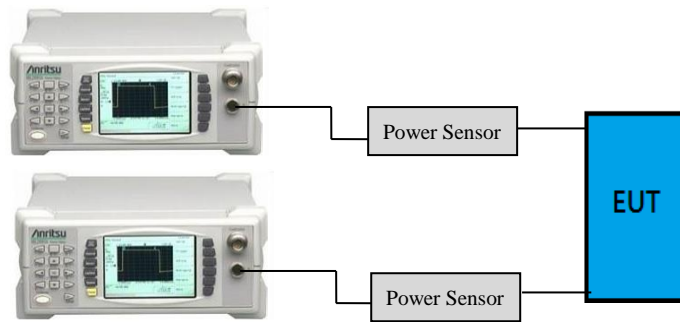

- For 802.11ac-VHT80/160, 802.11ax-HE160 modes only

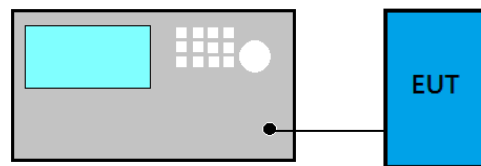

### 8.2. Specification Limits

Frequency Band (MHz)	Category	Limit
5150 to 5250	Outdoor Access Point	1 W(30 dBm)/ Max e.i.r.p. ≤125 mW(21 dBm) at any elevation angle above 30 degrees as measured from the horizon
	Fixed point-to-point Access Point	1 W(30 dBm)
	Indoor Access Point	1 W(30 dBm)
	Mobile and Portable client device	250 mW(24 dBm)
5250 to 5350	N/A	250 mW or 11 dBm + 10 log B <sup>Note1</sup>
5470 to 5725		250 mW or 11 dBm + 10 log B <sup>Note1</sup>
5725 to 5850		1 W(30 dBm)

Note 1: B is the 26 dB emission bandwidth, which presented in section 7 and appendix A.1.

### 8.3. Test Procedure

Following measurement procedure is reference to KDB 789033 D02 General UNII Test Procedures New Rules v02r01:

■ **Method AVGPM (Measurement using an RF average power meter):**

EUT is connected to power sensor and record the maximum average output power and duty cycle factor is added when duty cycle presented in section 3.7 is < 98%.

■ **Method AVGSA-2 (Spectrum channel power) for 802.11ac-VHT80/160, 802.11ax-HE80/160 modes only**

- (1) Set span to at least 1.5 times the OBW
- (2) Set RBW = 1 MHz
- (3) Set the video bandwidth (VBW)  $\geq$  3 MHz.
- (4) Detector = RMS.
- (5) Trace mode = trace average at least 100 traces
- (6) Sweep = auto couple.
- (7) Compute power by integrating the spectrum across the OBW of the signal using the instrument's band power measurement function with band limits set equal to the OBW band edges.
- (8) Duty cycle factor is added when duty cycle presented in section 3.7 is < 98%.

### 8.4. Test Results

Please refer to Appendix A



## 9. POWER SPECTRAL DENSITY

### 9.1. Block Diagram of Test Setup

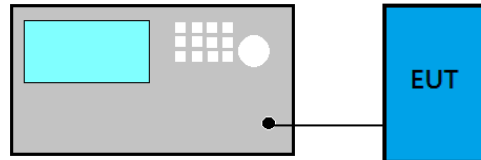

### 9.2. Specification Limits

Frequency Band (MHz)	Category	Limit
5150 to 5250	Outdoor Access Point	17dBm/MHz
	Fixed point-to-point Access Point	
	Indoor Access Point	
	Mobile and Portable client device	11 dBm/MHz
5250 to 5350	N/A	11 dBm/MHz
5470 to 5725		11 dBm/MHz
5725 to 5850		30dBm/500 kHz

### 9.3. Test Procedure

Following measurement procedure is reference to KDB 789033 D02 General UNII Test Procedures New Rules v02r01:

#### ■ Method AVGSA-2

- (1) Set span to encompass the EBW ( or 99% OBW) of the signal.
- (2) Set RBW = 1 MHz (Applicable to all bands except to 5725 MHz- 5850 MHz )/  
Set RBW=100 KHz(when EUT operate at 5725 MHz- 5850 MHz)
- (3) Set the video bandwidth (VBW)  $\geq 3$  RBW.
- (4) Detector = RMS.
- (5) Trace mode = trace average at least 100 traces
- (6) Sweep = auto couple.
- (7) Use peak search function to find out the maximum power density.
- (8) Duty cycle factor is added when duty cycle presented in section 3.7 is  $< 98\%$ .
- (9) Offset BWCF (7dB) when EUT operate at 5725 MHz – 5850 MHz.

### 9.4. Test Results

Please refer to Appendix A

## 10. FREQUENCY STABILITY

### 10.1. Block Diagram of Test Setup

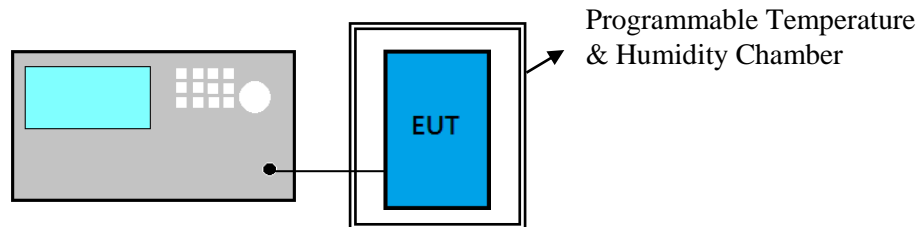

### 10.2. Specification Limits

NONE

### 10.3. Test Procedure

- (1) Frequency: Test frequency.
- (2) Span: enough to cover the complete power envelope
- (3) RBW: 1MHz(modulation ON) ; 10KHz(CW)
- (4) VBW: 1MHz(modulation ON) ; 10KHz(CW)
- (5) Detector Mode: Positive Peak
- (6) Indication mode: Max hold
- (7) Find the peak frequency and take calculate by the formula:  
(Measurement Value-declaration frequency)/ declaration frequency)

### 10.4. Test Results

Please refer to Appendix A

## 11. DEVIATION TO TEST SPECIFICATIONS

【NONE】



# APPDNDIX A

## TEST DATA AND PLOTS

(Model: 15Z90RT)



*Audix Technology Corp.*  
*No. 491, Zhongfu Rd., Linkou Dist.,*  
*New Taipei City 244, Taiwan*

*Tel: +886 2 26099301*  
*Fax: +886 2 26099303*

---

# APPDNDIX B

## TEST PHOTOGRAPHS

(Model: 15Z90RT)