

FCC 15.247 & RSS-247 2.4 GHz Test Report

for

LG Electronics Inc.

**222, LG-ro Jinwi-myeon, Pyeongtaek-Si, Gyeonggi-Do,
451-713, Korea**

Product Name : Notebook Computer
**Model Name : (1)15Z90P (2)15ZB90P (3)15ZD90P
(4)15ZG90P (5)15ZC90P**
Brand : LG
FCC ID : BEJNT-15Z90P
IC : 2703H-15Z90P

**Prepared by: : AUDIX Technology Corporation,
EMC Department**



The test report is based on a single evaluation of one sample of the above-mentioned products. It does not imply an assessment of the whole production and does not permit the use of the test lab logo.

TABLE OF CONTENTS

Description	Page
TEST REPORT	4
1. REVISION RECORD OF TEST REPORT	5
2. SUMMARY OF TEST RESULTS	6
3. GENERAL INFORMATION	7
3.1. Description of Application	7
3.2. Description of EUT	8
3.3. Antenna Information	9
3.4. EUT Specifications Assessed in Current Report	10
3.5. Description of Key Components	11
3.6. Test Configuration	14
3.7. Output Power Setting	15
3.8. Tested Supporting System List	15
3.9. Setup Configuration	16
3.10. Operating Condition of EUT	16
3.11. Description of Test Facility	17
3.12. Measurement Uncertainty	18
4. MEASUREMENT EQUIPMENT LIST	20
4.1. Conducted Emission Measurement	20
4.2. Radiated Emission Measurement	20
4.3. RF Conducted Measurement	22
5. CONDUCTED EMISSION	23
5.1. Block Diagram of Test Setup	23
5.2. Conducted Emission Limit	23
5.3. Test Procedure	23
5.4. Test Results	24
6. RADIATED EMISSION	25
6.1. Block Diagram of Test Setup	25
6.2. Radiated Emission Limits	27
6.3. Test Procedure	28
6.4. Measurement Result Explanation	29
6.5. Test Results	29
7. 20dB/OCCUPIED BANDWIDTH	30
7.1. Block Diagram of Test Setup	30
7.2. Specification Limits	30
7.3. Test Procedure	30
7.4. Test Results	30
8. CARRIER FREQUENCY SEPARATION	31
8.1. Block Diagram of Test Setup	31
8.2. Specification Limits	31
8.3. Test Procedure	31
8.4. Test Results	31
9. TIME OF OCCUPANCY	32
9.1. Block Diagram of Test Setup	32



Audix Technology Corp.
No. 491, Zhongfu Rd., Linkou Dist.,
New Taipei City 244, Taiwan

Tel: +886 2 26099301
Fax: +886 2 26099303

9.2. Specification Limits.....	32
9.3. Test Procedure.....	32
9.4. Test Results.....	32
10. NUMBER OF HOPPING CHANNELS.....	33
10.1. Block Diagram of Test Setup.....	33
10.2. Specification Limits.....	33
10.3. Test Procedure.....	33
10.4. Test Results.....	33
11. MAXIMUM PEAK OUTPUT POWER.....	34
11.1. Block Diagram of Test Setup.....	34
11.2. Specification Limits.....	34
11.3. Test Procedure.....	34
11.4. Test Results.....	34
12. EMISSION LIMITATIONS.....	35
12.1. Block Diagram of Test Setup.....	35
12.2. Specification Limits.....	35
12.3. Test Procedure.....	35
12.4. Test Results.....	35
13. DEVIATION TO TEST SPECIFICATIONS.....	36

APPENDIX A TEST DATA AND PLOTS
APPENDIX B TESTPHOTOGRAPHS

TEST REPORT

Applicant : LG Electronics Inc.
Manufacturer : LG Electronics Inc.
Factory : LG Electronics Nanjing New Technology Co., Ltd.
EUT Description
(1) Product : Notebook Computer
(2) Model : (1)15Z90P (2)15ZB90P (3)15ZD90P (4)15ZG90P (5)15ZC90P
(3) Brand : LG
(4) Power Supply: DC 20V, 3.25A

Applicable Standards:

Title 47 CFR FCC Part 15 Subpart C
RSS-Gen (Issue 5), April 2018
RSS-247 (Issue 2), February 2017
ANSI C63.10:2013

Audix Technology Corp. tested the equipment mentioned in accordance with the requirements set forth in the above standards. Test results indicate that the equipment tested is capable of demonstrating compliance with the requirements as documented within this report.

Audix Technology Corp. does not assume responsibility for any conclusions and generalizations drawn from the test results with regard to other specimens and samples.

Date of Report: 2021. 03. 05

Reviewed by:



(Annie Yu/Administrator)

Approved by:

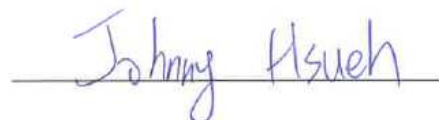

(Johnny Hsueh/Section Manager)



Audix Technology Corp.
No. 491, Zhongfu Rd., Linkou Dist.,
New Taipei City 244, Taiwan

Tel: +886 2 26099301
Fax: +886 2 26099303

1. REVISION RECORD OF TEST REPORT

Edition No	Issued Date	Revision Summary	Report Number
0	2021. 03. 05	Original Report	EM-F210114

2. SUMMARY OF TEST RESULTS

Rule		Description	Data Reused	Results
FCC	IC			
15.207	RSS-Gen §8.8	Conducted Emission	No	PASS
15.247(d)/15.205	RSS-Gen §8.9 RSS-247 §5.5	Radiated Band Edge and Radiated Spurious Emission	No	PASS
15.247(a)(1)	RSS-247 §5.1(2)	20dB/Occupied Bandwidth	Yes	PASS
15.247(a)(1)	RSS-247 §5.1(2)	Carrier Frequency Separation	Yes	PASS
15.247(a)(1)(iii)	RSS-247 §5.1(4)	Time of Occupancy	Yes	PASS
15.247(a)(1)(iii)	RSS-247 §5.1(4)	Number of Hopping Channels	Yes	PASS
15.247(b)(1)	RSS-247 §5.1(2)	Maximum Peak Output Power	SPOT CHECK Note 2	PASS
15.247(d)	RSS-247 §5.5	Conducted Band Edges and Conducted Spurious Emission	Yes	PASS
15.203	---	Antenna Requirement	---	Compliance

Note: 1. The uncertainties value is not used in determining the result.
 2. This device embedded with same radio transmitter with FCC ID: BEJNT-15Z90N, grant on 11/28 2019 and IC: 2703H-15Z90N (Report No.: EM-F190340) approved on 12/04/2019. According to KDB 484596 D01, we did spot check for output power and all output power values keep identical thus we reuse all results.

3. GENERAL INFORMATION

3.1. Description of Application

Applicant	LG Electronics Inc. 222, LG-ro Jinwi-myeon, Pyeongtaek-Si, Gyeonggi-Do, 451-713, Korea
Manufacturer	LG Electronics Inc. 222, LG-ro Jinwi-myeon, Pyeongtaek-Si, Gyeonggi-Do, 451-713, Korea
Factory	LG Electronics Nanjing New Technology Co., Ltd. No.346, Yaoxin Road, Economic & Technical Development Zone, Nanjing, China.
Product	Notebook Computer
Model	(1)15Z90P (2)15ZB90P (3)15ZD90P (4)15ZG90P (5)15ZC90P The difference between all models is different in the sales customers.
Brand	LG

3.2. Description of EUT

Test Model	15Z90P		
Serial Number	N/A		
Power Rating	DC 20V, 3.25A		
RF Features	WLAN: 802.11 a/b/g/n/ac/ax Bluetooth: BT and BLE (BT 5.0)		
Transmit Type	2.4 GHz		
	802.11b	1T1R	
	802.11g	1T1R	
	802.11n-HT20	2T2R	
	802.11n-HT40	2T2R	
	802.11ax-HE20	2T2R	
	802.11ax-HE40	2T2R	
	BT/BLE	1T1R	
	U-NII Bands		
	802.11a	1T1R	
	802.11n-HT20/802.11ac-VHT20/802.11ax-HE20	2T2R	
	802.11n-HT40/802.11ac-VHT40/802.11ax-HE40	2T2R	
	802.11ac-VHT80/802.11ax-HE80	2T2R	
	802.11ac-VHT160/802.11ax-HE160	2T2R	
	The MIMO is uncorrelated and supported SDM mode only.		
Sample Status	Mass production		
Test Sample	Sample No.	Test Item	Firmware
	03	AC Conduction, RSE, Output Power	N/A
	04	AC Conduction, Output Power	N/A
Date of Receipt	2021. 02. 09		
Date of Test	2021. 02. 10 ~ 03. 05		
Interface Ports of EUT	<ul style="list-style-type: none"> • One Micro SD Card Slot • One Earphone Port • Two USB 3.0 Ports • Two USB Type C Ports • One HDMI Port 		
Accessories Supplied	<ul style="list-style-type: none"> • AC Adapter • LAN Gender 		

3.3. Antenna Information

No.	Antenna Part Number	Manufacture	Antenna Type	Frequency (MHz)	Max Gain(dBi)
1.	WA-P-LELE-04-002 (Main)	INPAQ	Mono-Pole	2400~2500	5.0
				5100-5250	3.8
				5250-5350	3.8
				5350-5750	2.4
				5750~5850	2.7
	WA-P-LELE-04-002 (AUX)	INPAQ	Mono-Pole	2400~2500	5.7
				5100-5250	3.8
				5250-5350	3.8
				5350-5750	2.4
				5750~5850	2.7
2.	L1LRF004-CS-H (Main)	LUXSHARE- ICT	Mono-Pole	2400~2500	1.8
				5150-5250	2.0
				5250-5350	2.2
				5350-5725	2.8
				5725~5850	2.2
	L1LRF004-CS-H (AUX)	LUXSHARE- ICT	Mono-Pole	2400~2500	1.6
				5150-5250	2.0
				5250-5350	2.0
				5350-5725	2.6
				5725~5850	2.7

3.4. EUT Specifications Assessed in Current Report

Mode	Fundamental Range (MHz)	Channel Number	Modulation	Data Rate (Mbps)
Bluetooth	2402-2480	79	FHSS (GFSK, $\pi/4$ DQPSK, 8-DPSK)	1/2/3

Channel List							
Channel Number	Frequency (MHz)	Channel Number	Frequency (MHz)	Channel Number	Frequency (MHz)	Channel Number	Frequency (MHz)
00	2402	20	2422	40	2442	60	2462
01	2403	21	2423	41	2443	61	2463
02	2404	22	2424	42	2444	62	2464
03	2405	23	2425	43	2445	63	2465
04	2406	24	2426	44	2446	64	2466
05	2407	25	2427	45	2447	65	2467
06	2408	26	2428	46	2448	66	2468
07	2409	27	2429	47	2449	67	2469
08	2410	28	2430	48	2450	68	2470
09	2411	29	2431	49	2451	69	2471
10	2412	30	2432	50	2452	70	2472
11	2413	31	2433	51	2453	71	2473
12	2414	32	2434	52	2454	72	2474
13	2415	33	2435	53	2455	73	2475
14	2416	34	2436	54	2456	74	2476
15	2417	35	2437	55	2457	75	2477
16	2418	36	2438	56	2458	76	2478
17	2419	37	2439	57	2459	77	2479
18	2420	38	2440	58	2460	78	2480
19	2421	39	2441	59	2461		

3.5. Description of Key Components

3.5.1. For the All Component Lists

Item	Supplier	Model / Type	Character
System	Microsoft	Win10 Home	---
		Win10 Pro	---
Main Board	LG	Blanc MAIN B/D PCB (with TPM IC)	Manufacturer: #1 HannstarBoardTech(Jiang Yin)Corp.,Ltd. #2 Elec&Eltek Company (MCO) Limited.
		Blanc MAIN B/D PCB (without TPM IC)	
WLAN SUB Board	LG	15/16Z90P SUB B/D	Manufacturer: #1 HannstarBoardTech(Jiang Yin)Corp.,Ltd. #2 Elec&Eltek Company (MCO) Limited. #3 JiangSu HuaShen Electronic co.,ltd (HXF)
Intel CPU (Socket: FCBGA1449)	Intel	i7-1165G7	2.80GHz
	Intel	i5-1135G7	2.4GHz
	Intel	i3-1115G4	3.00GHz
15.6" LCD Panel	LG Display	LP156WFD	Resolution: 1920 x 1080, 60Hz FHDIPS (Touch)
15.6" LCD Panel	LG Display	LP156WFC	Resolution: 1920 x 1080, 60Hz FHDIPS (Normal Non Touch)
Storage (SSD)	SK hynix	HFS256GD9TNG-L2A0A	256GB (M.2)
		HFS512GD9TNG-L2A0A	512GB (M.2)
		HFS001TD9TNG-L2A0A	1TB (M.2)
	Samsung	MZ-VLB256B	256GB (M.2)
		MZ-VLB512B	512GB (M.2)
		MZ-VLB1T0B	1TB(M.2)
Memory (RAM)	SK Hynix	---	32GB LPDDR4x(On Board)
	SK Hynix	---	16GB LPDDR4x(On Board)
	SK Hynix	---	8GB LPDDR4x(On Board)
	Samsung	---	16GB LPDDR4x(On Board)
	Samsung	---	8GB LPDDR4x(On Board)
Battery Pack	LG	LBV7227E	80Wh, DC7.74V, 80Wh Typ 10336mAh
WLAN Combo Card	Intel	AX201D2W	WLAN and BT, 2x2 CNVi 1216 FCC ID: PD9AX201NG IC: 1000M-AX201NG NCC ID: CCAH18LP3410T5
WLAN Combo Antenna	LG (INPAQ)	WA-P-LELE-04-002	PCB, Mono-pole Type Main: Black, Aux: Gray
	LG (LUXSHARE-ICT)	L1LRF004-CS-H	PCB, Mono-pole Type Main: Black, Aux: Gray

Item	Supplier	Model / Type	Character
Keyboard	TIC	KT0120B8	---
	LITE ON	SN8002	---
Web Camera	Chicony	CKFKH33-0	---
	Luxvisions	0BF108N3	---
LAN Gender (Type C to LAN)	SUZHOU MEC ELECTRONICS	80-5946-111	(White) 10/100Megabit Ethernet
		80-5946-101	(Black) 10/100 Megabit Ethernet
	Type C to LAN: Shielded, Undetached, 0.12m		
	ARIN TECH CO. LTD	GD-08MF-36-WH-LP10	(White) 10/100Megabit Ethernet
		GD-08MF-36-BK-LP11	(Black) 10/100 Megabit Ethernet
	Type C to LAN: Shielded, Undetached, 0.12m		
	SUZHOU MEC ELECTRONICS	80-5946-200	(White) 10/100/1000 Megabit Ethernet
		80-5946-210	(Black) 10/100/1000 Megabit Ethernet
Type C to LAN: Shielded, Undetached, 0.13m			
AC Adapter (65W)	LG (HONOR)	ADT-65DSU-D03-2	I/P: AC 100-240V, 1.6A, 50-60Hz O/P: DC 20V, 3.25A
	DC Power Cord: Non-Shielded, Undetached, 1.5m		
	AC Power Cord: Non-Shielded, Detached, 1.0m (2C) (For Other Countries)		
	AC Power Cord: Non-Shielded, Detached, 1.55m (2C) (For US, Canada, Mexico)		

Remark: For more detailed features description, please refer to the manufacturer's specifications or the user manual.

3.5.2. The EUT collocates with following worst components, which are used to establish a basic configuration of system during test:

SKU (Mode)1 ~ 2		1	2
Main Board	LG, Blanc MAIN B/D PCB (with TPM IC)		V
	LG, Blanc MAIN B/D PCB (without TPM IC)	V	
WLAN SUB Board	LG, 15/16Z90P SUB B/D	V	V
CPU	Intel, i7-1165G7	V	
	Intel, i5-1135G7		V
15.6" LCD Panel	LG Display, LP156WFD (Touch)	V	
	LG Display, LP156WFC (Normal Non Touch)		V
Storage (SSD)	Samsun, 1TB *1	V	
	Samsung, 512GB *1		V
	SK Hynix, 1TB *1	V	
	SK Hynix, 512GB *1		V
Memory (RAM)	SAMSUNG, 16GB	V	V
Battery Pack	LG, LBV7227E	V	V
WLAN Combo Card	Intel, AX201D2W	V	V
WLAN Combo Antenna	LG (INPAQ), WA-P-LELE-04-002	V	
	LG (LUXSHARE-ICT), L1LRF004-CS-H		V
Keyboard	TIC, KT0120B8	V	V
Web Camera	Chicony, CKFKH33-0	V	V
Type C*2	Link to LAN Gender	SUZHOU MEC ELECTRONICS, 80-5946-111 (White)	V
		ARIN TECH CO. LTD, GD-08MF-36-WH-LP10 (White)	
	Link to Adapter	LG (HONOR),ADT-65DSU-D03-2	V
HDMI	1920 x 1080, 60Hz ("H" Pattern)	V	V

3.6. Test Configuration

Mode	Duty Cycle (x)	T (ms)	Duty Cycle Correction Factor (dB)
BT	N/A	2.890	N/A

AC Conduction	
SKU #1	Normal operation (with INPAQ Antenna)
SKU #2	Normal operation (with LUXSHARE-ICT Antenna)

Item		Modulation	Data Rate	Test Channel
Radiated Test Case	SKU #1	Radiated Band Edge ^{Note 1 & 2}		00/78
		GFSK	1Mbps	00/78
Radiated Spurious Emission ^{Note 1}		GFSK	1Mbps	00/39/78
Conducted Test Case	20dB/Occupied Bandwidth (Data Reused)	GFSK	1Mbps	00/39/78
		8-DPSK	3Mbps	00/39/78
	Carrier Frequency Separation (Data Reused)	GFSK	1Mbps	00/39/78
		8-DPSK	3Mbps	00/39/78
	Time of Occupancy (Data Reused)	GFSK	1Mbps	00/39/78
		8-DPSK	3Mbps	00/39/78
	Number of Hopping Channels (Data Reused)	GFSK	1Mbps	39
		8-DPSK	3Mbps	39
	Maximum Peak Output Power (SPOT Check)	GFSK	1Mbps	00/39/78
		8-DPSK	3Mbps	00/39/78
	Band Edges (Data Reused)	GFSK	1Mbps	00/78
		8-DPSK	3Mbps	00/78
Spurious Emission (Data Reused)	GFSK	1Mbps	00/39/78	
	8-DPSK	3Mbps	00/39/78	

Note 1: Mobile Device

Portable Device, and 3 axis were assessed. The worst scenario for Radiated Spurious Emission as follow: Lie Side Stand

Note 2: We performed testing of the highest and lowest data rate.

3.7. Output Power Setting

SPOT CHECK

Centre Frequency (MHz)	Power Setting	
	GFSK	8-DPSK
2402	12	12
2441	12	12
2480	12	12

3.8. Tested Supporting System List

3.8.1. Support Peripheral Unit

No.	Product	Brand	Model No.	Serial No.	Approval
1.	TV	LG	22LK330-DB	N/A	N/A
2.	USB Mouse	Lenovo	45J4886	N/A	FCC By DoC
3.	Earphone	APPLE	N/A	N/A	N/A
4.	SD Card	ADATA	MicroSDHC Card	N/A	N/A
Partner System					
5.	AP Server	ASUS	RT-AX88U	N/A	FCC ID: MSQ-RTAXHP00 IC: 3568A-RTAXHP00

3.8.2. Cable Lists

No.	Cable Description Of The Above Support Units
1.	HDMI Cable: Shielded, Detachable, 1.8m AC Power Cord: Unshielded, Detachable, 1.8m
2.	USB Cable: Unshielded, Undetachable, 1.8m
3.	Earphone Cable: Unshielded, Undetachable, 0.9m
4.	N/A
5.	AC adapter: M/N:WA-30B12, Cable: Unshielded, Detachable, 1.2m LAN cable: Unshielded, Detachable, 3.0m
6.	LAN cable: Unshielded, Detachable, 1.8m

3.9. Setup Configuration

3.9.1. EUT Configuration for Power Line & Radiated Emission

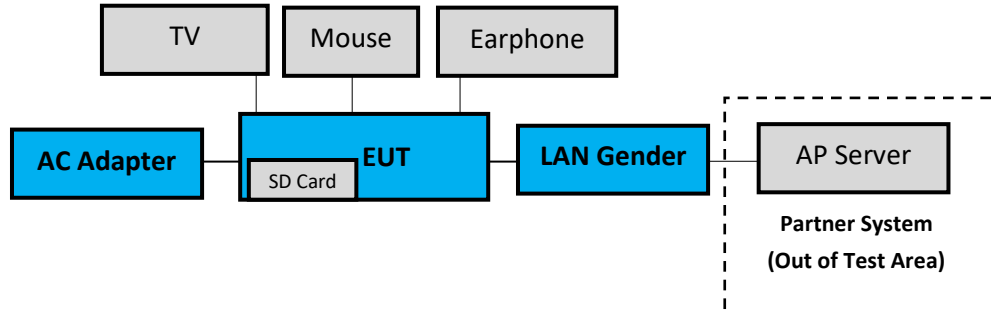

3.9.2. EUT Configuration for RF Conducted Test Items



3.10. Operating Condition of EUT

Test program “DRTU” is used for enabling EUT BT function under continues transmitting and choosing data rate/ channel.

3.11. Description of Test Facility

Name of Test Firm	Audix Technology Corporation / EMC Department No. 491, Zhongfu Rd., Linkou Dist., New Taipei City 244, Taiwan Tel: +886-2-26092133 Fax: +886-2-26099303 Website : www.audixtech.com Contact e-mail: attemc_report@audixtech.com
Accreditations	The laboratory is accredited by following organizations under ISO/IEC 17025:2017 (1) NVLAP(USA) NVLAP Lab Code 200077-0 (2) TAF(Taiwan) No. 1724
Test Facilities	FCC OET Designation Number under APEC MRA by NCC is : TW1724 ISED CAB Identifier Number under APEC TEL MRA by NCC is TW1724 (1) No.8 Shielded Room (2) No.7 Shielded Room (3) No.1 3m Semi Anechoic Chamber (4) Fully Anechoic Chamber

3.12.Measurement Uncertainty

Test Items/Facilities		Frequency Range	Uncertainty
Conduction Test		9kHz-150kHz	±3.7dB
		150kHz-30MHz	±3.4dB
Radiation Test	<input checked="" type="checkbox"/>	No.1 3m Semi Anechoic Chamber	
		30MHz-200MHz, 3m, Horizontal	±3.8dB
		200MHz-1000MHz, 3m, Horizontal	±4.1dB
		30MHz-200MHz, 3m, Vertical	±4.5dB
		200MHz-1000MHz, 3m, Vertical	±4.5dB
		1GHz-6GHz, 3m	±4.7dB
	<input type="checkbox"/>	No.3 3m Semi Anechoic Chamber	
		30MHz-200MHz, 3m, Horizontal	±3.9dB
	<input type="checkbox"/>	No.4 3m Semi Anechoic Chamber	
		200MHz-1000MHz, 3m, Horizontal	±4.2dB
		30MHz-200MHz, 3m, Vertical	±4.3dB
		200MHz-1000MHz, 3m, Vertical	±4.5dB
		30MHz-200MHz, 3m, Horizontal	±4.1dB
		200MHz-1000MHz, 3m, Horizontal	±4.5dB
		30MHz-200MHz, 3m, Vertical	±4.4dB
		200MHz-1000MHz, 3m, Vertical	±4.8dB
	<input type="checkbox"/>	No.5 3m Semi Anechoic Chamber	
		1GHz-6GHz, 3m	±5.0dB
		6GHz-18GHz, 3m	±4.7dB
		30MHz-200MHz, 3m, Horizontal	±4.2dB
200MHz-1000MHz, 3m, Horizontal		±4.3dB	
30MHz-200MHz, 3m, Vertical		±4.3dB	
<input checked="" type="checkbox"/>	Fully Anechoic Chamber		
	200MHz-1000MHz, 3m, Vertical	±4.7dB	
	1GHz-6GHz, 3m	±4.8dB	
	6GHz-18GHz, 3m	±4.5dB	
		30MHz~1000MHz	±4.6dB
		1GHz~18GHz	±5.4dB
		18GHz~40GHz	±3.52dB
		40GHz~260GHz	±3.56dB

Remark : Uncertainty = $ku_c(y)$



Audix Technology Corp.
No. 491, Zhongfu Rd., Linkou Dist.,
New Taipei City 244, Taiwan

Tel: +886 2 26099301
Fax: +886 2 26099303

Test Item	Uncertainty
20dB Bandwidth	$\pm 0.2\text{kHz}$
99% Occupied Bandwidth	$\pm 0.38\%$
Carrier Frequency Separation	$\pm 0.2\text{kHz}$
Time of Occupancy	$\pm 0.03\text{sec}$
Maximum peak Output power	$\pm 0.52\text{dB}$
Conducted Emission Limitations	$\pm 0.13\text{dB}$

4. MEASUREMENT EQUIPMENT LIST

4.1. Conducted Emission Measurement

Item	Type	Manufacturer	Model No.	Serial No.	Cal. Date	Cal. Interval
1.	Test Receiver	R&S	ESR3	101774	2021. 02. 02	1 Year
		R&S	ESCI	101276	2021. 03. 03	1 Year
2.	A.M.N.	R&S	ENV432	101567	2020. 04. 20	1 Year
		R&S	ESH2-Z5	100366	2020. 07. 10	1 Year
3.	L.I.S.N.	Kyoritsu	KNW-407	8-855-9	2020. 12. 10	1 Year
		Kyoritsu	KNW-407	8-1539-3	2021. 01. 10	1 Year
4.	Pulse Limiter	R&S	ESH3-Z2	100354	2021. 01. 04	1 Year
		R&S	ESH3-Z2	101495	2021. 01. 04	1 Year
5.	Digital Thermo-Hygro Meter	iMax	HTC-1	No.8 S/R	2020. 04. 17	1 Year
		iMax	HTC-1	No.7 S/R	2020. 04. 17	1 Year
6.	Coaxial Cable	Yeida	RG/58AU	CE-08	2020. 09. 19	1 Year
		Thermax/CD T	RG-142	CE-07	2020. 05. 18	1 Year
7.	Test Software	Audix	e3	V6.120619c	N.C.R.	N.C.R.
		Audix	e3	V6.120619c	N.C.R.	N.C.R.

4.2. Radiated Emission Measurement

Item	Type	Manufacturer	Model No.	Serial No.	Cal. Date	Cal. Interval
1.	Spectrum Analyzer	Agilent	N9010A-526	MY53400071	2020. 09. 16	1 Year
2.	Spectrum Analyzer	Keysight	N9010B-544	MY55460198	2020. 04. 29	1 Year
3.	Spectrum Analyzer	Agilent	N9030A-526	MY53310269	2021. 01. 14	1 Year
4.	Test Receiver	R&S	ESCS30	100338	2020. 06. 10	1 Year
5.	Amplifier	HP	8447D	2944A07178	2020. 04. 29	1 Year
6.	Microwave Preamplifier	HP	8449B	3008A01284	2020. 05. 26	1 Year
7.	Microwave Amplifier	Keysight	83051A	MY53010042	2020. 08. 05	1 Year
8.	Microwave Amplifier	Agilent	8449B	3008A02678	2021. 02. 27	1 Year
9.	Loop Antenna	R&S	HFH2-Z2	891847/27	2019. 12. 26	2 Years
10.	Bilog Antenna	TESEQ	CBL6112D	33821	2021. 01. 15	1 Year
11.	Horn Antenna	ETS-Lindgren	3117	00135902	2020. 03. 10	1 Year
12.	Horn Antenna	COM-POWER	AH-840	101092	2020 .05. 08	1 Year
13.	2.4GHz Notch Filter	K&L Microwave	7NSL10-2441 .5/E130.5-O/O	1	2020 .07. 24	1 Year
14.	3GHz Notch Filter	Microwave	H3G018G1	484796	2020. 08. 20	1 Year
15.	Coaxial Cable	MIYAZAKI	5D2W	RE-11	2021. 01. 29	1 Year
16.	Coaxial Cable	HUBER+SUHNER	SUCOFLEX 104	RE-29	2020. 09. 19	1 Year
17.	Coaxial Cable	HUBER+SUHNER	SUCOFLEX 102	RE-30	2020. 09. 19	1 Year
18.	Digital Thermo-Hygro Meter	iMax	HTC-1	No.1 3m A/C	2020. 04. 17	1 Year
19.	Digital Thermo-Hygro Meter	EVERY DAY	E-512	RF-02	2020. 04. 17	1 Year
20.	Test Software	Audix	e3	V6.120619c	N.C.R.	N.C.R.
21.	Test Software	Audix	e3	V6.110601	N.C.R.	N.C.R.

4.3. RF Conducted Measurement

Item	Type	Manufacturer	Model No.	Serial No.	Cal. Date	Cal. Interval
1.	Spectrum Analyzer	Keysight	N9020B-544	MY57120357	2021. 01. 06	1 Year
2.	Power Meter	Anritsu	ML2487A	6K00005406	2020. 04. 29	1 Year
3.	Power Sensor	Anritsu	MA2491A	030873	2020. 04. 29	1 Year
4.	Digital Thermo-Hygro Meter	Shenzhen Datronn Electronics	KT-905	RF	2020. 04. 17	1 Year

5. CONDUCTED EMISSION

5.1. Block Diagram of Test Setup

5.1.1. Block Diagram of EUT

Indicated as section 3.9

5.1.2. Shielded Room Setup Diagram

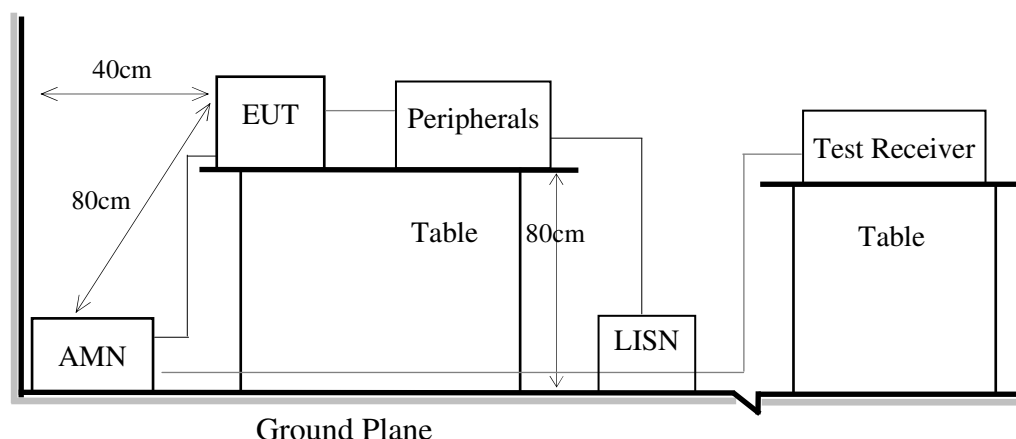

5.2. Conducted Emission Limit

Frequency	Conducted Limit	
	Quasi-Peak Level	Average Level
150kHz ~ 500kHz	66 ~ 56 dB μ V	56 ~ 46 dB μ V
500kHz ~ 5MHz	56 dB μ V	46 dB μ V
5MHz ~ 30MHz	60 dB μ V	50 dB μ V

Remark1.: If the average limit is met when using a Quasi-Peak detector, the measurement using the average detector is not required.

2.: The lower limit applies to the band edges.

5.3. Test Procedure

- 5.3.1. To set up the EUT as indicated in ANSI C63.10. The EUT was placed on the table which has 80 cm height to the ground and 40 cm distance to the conducting wall.
- 5.3.2. Power supplier of the EUT was connected to the AC mains through an Artificial Mains Network (A.M.N.).
- 5.3.3. The AC power supplies to all peripheral devices must be provided through line impedance stabilization network (L.I.S.N.)
- 5.3.4. Checking frequency range from 150kHz to 30 MHz and record the emission which does not have 20 dB below limit.



Audix Technology Corp.
No. 491, Zhongfu Rd., Linkou Dist.,
New Taipei City 244, Taiwan

Tel: +886 2 26099301
Fax: +886 2 26099303

5.4. Test Results

Please refer to Appendix A.

6. RADIATED EMISSION

6.1. Block Diagram of Test Setup

6.1.1. Block Diagram of EUT

Indicated as section 3.9

6.1.2. Setup Diagram for 9kHz-30MHz

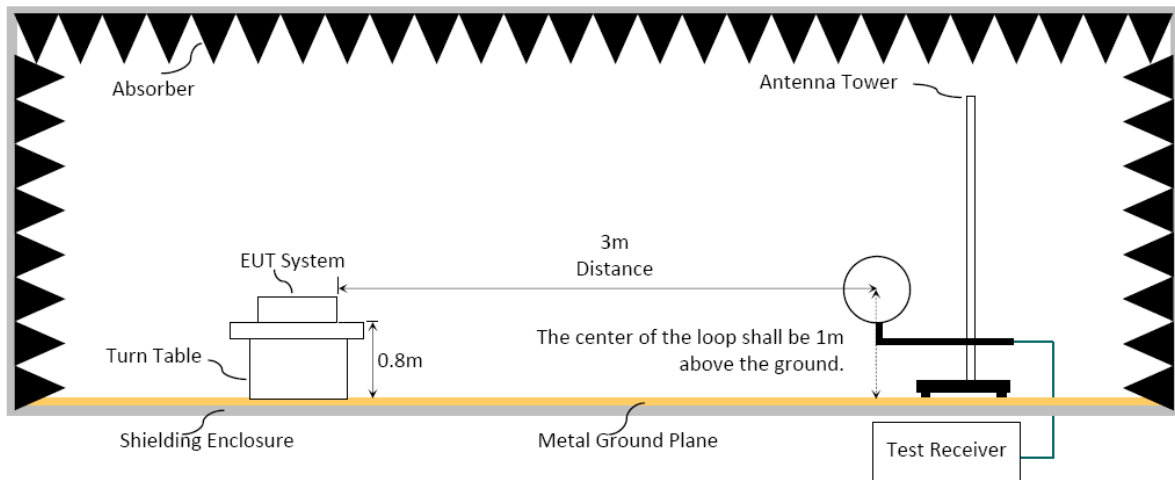

6.1.3. Setup Diagram for 30-1000MHz

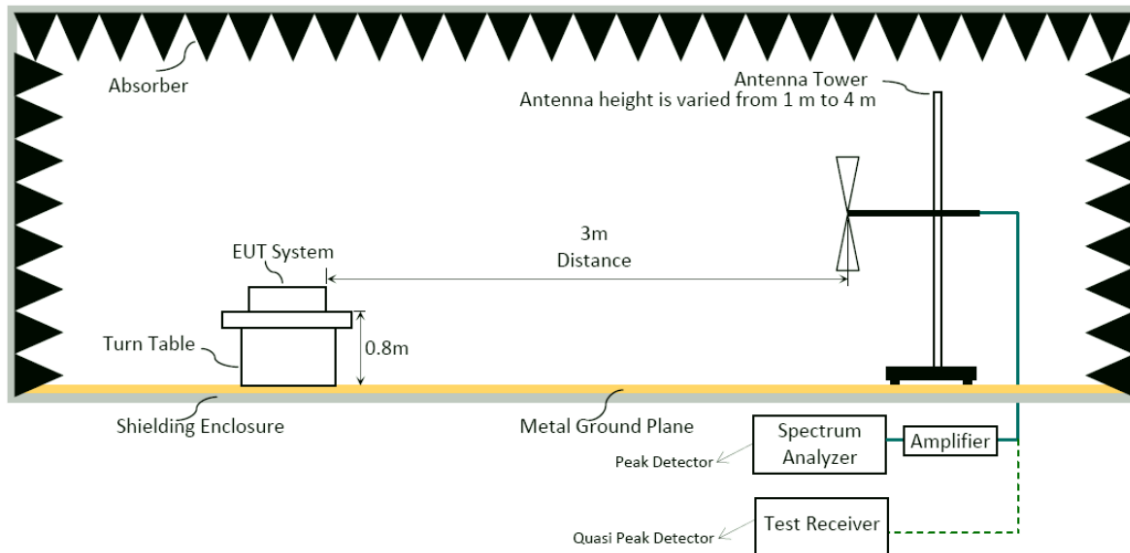

6.1.4. Setup Diagram for above 1GHz

Fully Anechoic Chamber

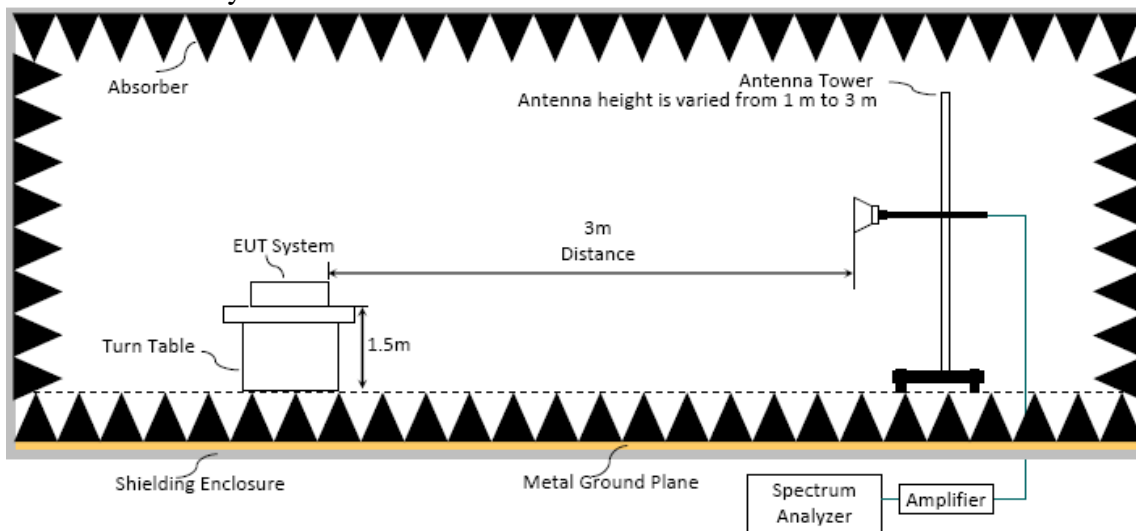

Semi Anechoic Chamber

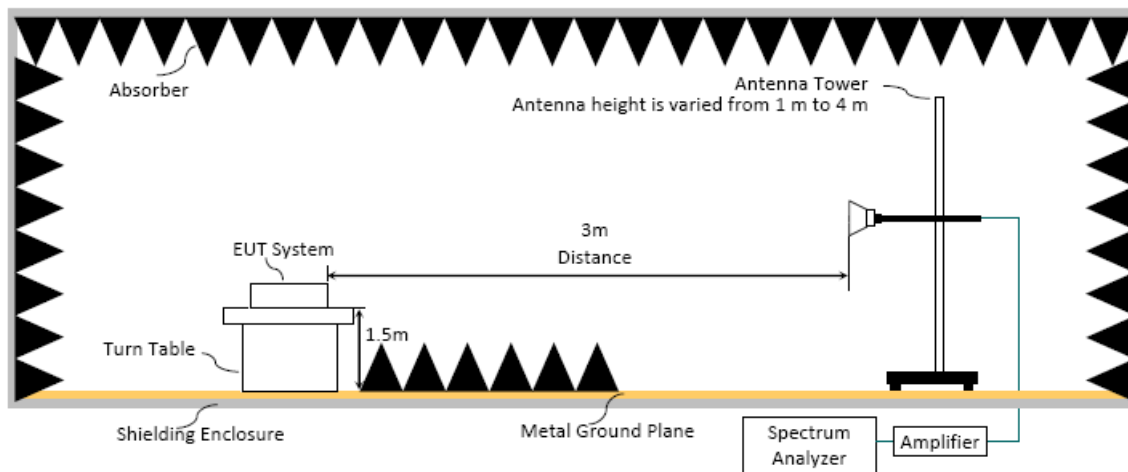

6.2. Radiated Emission Limits

In any 100kHz bandwidth outside the frequency band, the radio frequency power produced by the intentional radiator shall be at least 20dB below that in the 100kHz bandwidth within the band that contains the highest level. In addition, radiated emissions which fall in restricted bands, as defined in Section 15.205/RSS-Gen Section 8.10 table 6, must also comply with the radiated emission limits specified as below.

Frequency (MHz)	Distance(m)	Limits	
		dB μ V/m	μ V/m
0.009 - 0.490	300	67.6-20 log f(kHz)	2400/f kHz
0.490 - 1.705	30	87.6-20 log f(kHz)	24000/f kHz
1.705 - 30	30	29.5	30
30 - 88	3	40.0	100
88- 216	3	43.5	150
216- 960	3	46.0	200
Above 960	3	54.0	500
Above 1000	3	74.0 dB μ V/m (Peak) 54.0 dB μ V/m (Average)	

Remark : (1) dB μ V/m = 20 log (μ V/m)

- (2) The tighter limit applies to the edge between two frequency bands.
- (3) Distance refers to the distance in meters between the measuring instrument antenna and the closed point of any part of the device or system.
- (4) Fundamental and emission fall within operation band are exempted from this section.
- (5) Pursuant to ANSI C63.10: 6.6.4.3, if the maximized peak measured value complies with the average limit, then it is unnecessary to perform an average measurement.

6.3. Test Procedure

Frequency Range 9kHz~30MHz:

The EUT setup on the turntable which has 0.8 m height to the ground. The turn table rotated 360 degrees and antenna fixed to 1 m to find the maximum emission level. In order to find the maximum emission, all of the interface cables were manipulated according to ANSI C63.10-2013 regulation.

- (1) RBW = 9kHz with peak and average detector.
- (2) Detector: average and peak (9kHz-490kHz)
Q.P. (490kHz-30MHz)

Frequency Range 30MHz ~ 25GHz:

The EUT setup on the turn table which has 80cm (for 30-1000MHz) and 1.5m (for above 1GHz) height to the ground. The turn table rotated 360 degrees and antenna varied from 1 m to 4 m (for 30-1000MHz) and from 1m to 3m (for above 1GHz at fully Anechoic Chamber) or from 1 m to 4 m (for above 1GHz at Semi Anechoic Chamber) to find the maximum emission level. Both horizontal and vertical polarization are required. In order to find the maximum emission, all of the interface cables were manipulated according to ANSI C63.10-2013 regulation.

Frequency below 1GHz:

Spectrum Analyzer is used for pre-testing with following setting:

- (1) RBW = 120KHz
- (2) VBW $\geq 3 \times$ RBW.
- (3) Detector = Peak.
- (4) Sweep time = auto.
- (5) Trace mode = max hold.
- (6) Allow sweeps to continue until the trace stabilizes.

Note 1: When peak-detected value is lower than limit that the measurement using the Q.P. detector is not required, otherwise using Q.P. for final measurement.

Note 2: When the radiated emissions limits are expressed in terms of the average value of the emissions, and pulsed operation is employed, the measurement field strength shall be determined by averaging over one complete pulse train, including blanking intervals, as long as the pulse train does not exceed 0.1 seconds.

Frequency above 1GHz to 10th harmonic(up to 25 GHz):

Peak Detector:

- (1) RBW = 1MHz
- (2) VBW $\geq 3 \times$ RBW.
- (3) Detector = Peak.
- (4) Sweep time = auto.
- (5) Trace mode = max hold.
- (6) Allow sweeps to continue until the trace stabilizes.

Note: When peak-detected value is lower than limit that the measurement using the average detector is not required, otherwise using average detector for final measurement.

Average Detector: **Option 1:**

- (1) RBW = 1MHz
- (2) VBW $\geq 1/T$.
- (3) Detector = Peak.
- (4) Sweep time = auto.
- (5) Trace mode = max hold.
- (6) Allow sweeps to continue until the trace stabilizes.

 Option 2:

Average Emission Level = Peak Emission Level + D.C.C.F.

6.4. Measurement Result Explanation

Peak Emission Level = Antenna Factor + Cable Loss + Meter Reading (including Preamp factor if test used)

Average Emission Level = Antenna Factor + Cable Loss + Meter Reading (including Preamp factor if test used)

Average Emission Level = Peak Emission Level + DCCF

Duty Cycle Correction Factor (DCCF) = $20\log(TX_{on}/TX_{on+off})$ presented in section 3.6

ERP = Peak Emission Level - 95.2dB - 2.14dB

6.5. Test Results

Please refer to Appendix A.

7. 20dB/OCCUPIED BANDWIDTH

7.1. Block Diagram of Test Setup

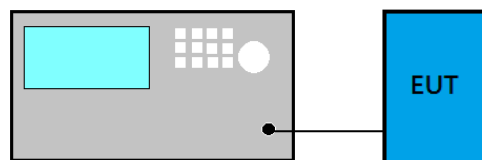

7.2. Specification Limits

Alternatively, frequency hopping systems operating in the 2400-2483.5MHz band may have hopping channel carrier frequencies that are separated by 25kHz or two-thirds of the 20dB bandwidth of the hopping channel, whichever is greater.

7.3. Test Procedure

Following measurement procedure is reference to ANSI C63.10:2013:

For 20dB Bandwidth

- (1) Set Span range 2~5 times the OBW
- (2) Set VBW $\geq 3 \times$ RBW.
- (3) Detector = Peak.
- (4) Trace mode = Max hold.
- (5) Sweep = Auto couple.
- (6) Allow the trace to stabilize.
- (7) Setting channel bandwidth function x dB to -20 dB to record the final bandwidth.

For 99% Occupied Bandwidth

- (8) Set Span range 1.5~5 times the OBW
- (9) Set RBW close to 1% to 5% of OBW.
- (10) Set VBW $\geq 3 \times$ RBW.
- (11) Detector = Peak.
- (12) Trace mode = Max hold
- (13) Sweep = Auto couple.
- (14) Allow the trace to stabilize.

7.4. Test Results

Please refer to Appendix A

8. CARRIER FREQUENCY SEPARATION

8.1. Block Diagram of Test Setup

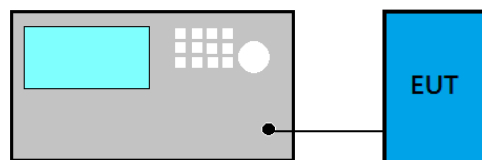

8.2. Specification Limits

Alternatively, frequency hopping systems operating in the 2400-2483.5MHz band may have hopping channel carrier frequencies that are separated by 25kHz or two-thirds of the 20dB bandwidth of the hopping channel, whichever is greater, provided the systems operate with an output no greater than 125mW.

8.3. Test Procedure

Following measurement procedure is reference to ANSI C63.10:2013:

- (1) Span = Wide enough to capture the peaks of two adjacent channels
- (2) RBW: Start with the RBW set to approximately 30% of the channel spacing; adjust as necessary to best identify the center of each individual channel.
- (3) $VBW \geq RBW$
- (4) Sweep = Auto
- (5) Detector function = Peak
- (6) Trace = Max hold
- (7) Allow the trace to stabilize.

8.4. Test Results

Please refer to Appendix A

9. TIME OF OCCUPANCY

9.1. Block Diagram of Test Setup

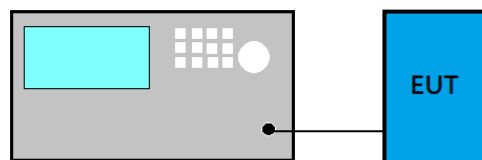

9.2. Specification Limits

Frequency hopping systems in the 2400-2483.5MHz shall use at least 15 non-overlapping channels. The average time of occupancy on any channel shall not be greater than 0.4 seconds within a period of 0.4 seconds multiplied by number of hopping channels employed.

9.3. Test Procedure

Following measurement procedure is reference to ANSI C63.10:2013:

- (1) Span: Zero span, centered on a hopping channel.
- (2) RBW shall be \leq channel spacing and where possible RBW should be set $\gg 1/T$, where T is the expected dwell time per channel.
- (3) Sweep: As necessary to capture the entire dwell time per hopping channel; where possible use a video trigger and trigger delay so that the transmitted signal starts a little to the right of the start of the plot. The trigger level might need slight adjustment to prevent triggering when the system hops on an adjacent channel; a second plot might be needed with a longer sweep time to show two successive hops on a channel.
- (4) Detector function = Peak
- (5) Trace = Max hold

9.4. Test Results

Please refer to Appendix A

10. NUMBER OF HOPPING CHANNELS

10.1. Block Diagram of Test Setup

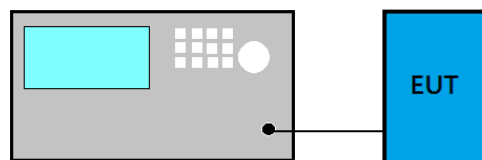

10.2. Specification Limits

Frequency hopping systems which use fewer than 20 hopping frequencies may employ intelligent hopping techniques to avoid interference to other transmissions. Frequency hopping systems may avoid or suppress transmissions on a particular hopping frequency provided that a minimum of 15 non-overlapping channels.

10.3. Test Procedure

Following measurement procedure is reference to ANSI C63.10:2013:

- (1) Span: The frequency band of operation. Depending on the number of channels the device supports, it may be necessary to divide the frequency range of operation across multiple spans, to allow the individual channels to be clearly seen.
- (2) RBW: To identify clearly the individual channels, set the RBW to less than 30% of the channel spacing or the 20 dB bandwidth, whichever is smaller.
- (3) VBW \geq RBW
- (4) Sweep = Auto
- (5) Detector function = Peak
- (6) Trace = m=Max hold
- (7) Allow the trace to stabilize.

10.4. Test Results

Please refer to Appendix A

11. MAXIMUM PEAK OUTPUT POWER

11.1. Block Diagram of Test Setup

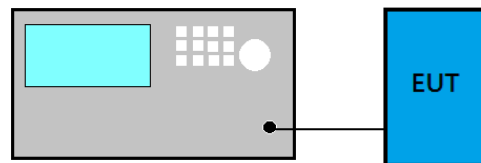

11.2. Specification Limits

The Limits of maximum Peak Output Power for frequency hopping systems in 2400-2483.5MHz is: 0.125Watt. (21dBm)

11.3. Test Procedure

Following measurement procedure is reference to ANSI C63.10:2013:

- (a) Use the following spectrum analyzer settings
 - (1) Span: Approximately five times the 20 dB bandwidth, centered on a hopping channel.
 - (2) RBW > 20 dB bandwidth of the emission being measured.
 - (3) VBW \geq RBW
 - (4) Sweep: Auto
 - (5) Detector function: Peak
 - (6) Trace: Max hold
- (b) Allow trace to stabilize.
- (c) Use the marker-to-peak function to set the marker to the peak of the emission.

11.4. Test Results

Please refer to Appendix A

12. EMISSION LIMITATIONS

12.1. Block Diagram of Test Setup

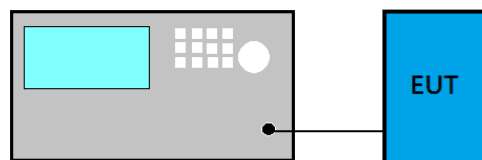

12.2. Specification Limits

In any 100kHz bandwidth outside the frequency band in which the spread spectrum or digitally modulated intentional radiator is operating, the radio frequency power that is produced by the intentional radiator shall be at least 20dB below that in the 100kHz bandwidth within the band that contains the highest level of the desired power, based on either an RF conducted or a radiated measurement. If the transmitter complies with the conducted power limits based on the use of RMS averaging over a time interval, that the required attenuation shall be 30 dB instead of 20 dB.

Attenuation below the general limits specified in Section 15.209(a)/RSS-Gen Section 8.9 table 4 is not required. In addition, radiated emissions which fall in restricted bands, as defined in Section 15.205(a)/RSS-Gen Section 8.10 table 6., must also comply with the radiated emission limits specified in Section 15.209(a)/RSS-Gen Section 8.9 table 4 (See Section 15.205(c)).

12.3. Test Procedure

Following measurement procedure is reference to ANSI C63.10:2013:

- (1) Set span wide enough to capture the peak level of the in-band emission and all spurious emissions; up to 10th harmonic.
- (2) RBW = 100 kHz
- (3) VBW \geq RBW
- (4) Sweep = Auto
- (5) Detector function = Peak
- (6) Trace = Max hold

12.4. Test Results

Please refer to Appendix A



13. DEVIATION TO TEST SPECIFICATIONS

【NONE】



Audix Technology Corp.
No. 491, Zhongfu Rd., Linkou Dist.,
New Taipei City 244, Taiwan

Tel: +886 2 26099301
Fax: +886 2 26099303

APPDNDIX A

TEST DATA AND PLOTS

(Model: 15Z90P)

TABLE OF CONTENTS

A.1 CONDUCTED EMISSION	2
A.2 RADIATED EMISSION	6
A.2.1 Emissions within Restricted Frequency Bands.....	6
A.2.2 Emissions outside the frequency band:.....	15
A.2.3 Emissions in Non-restricted Frequency Bands:.....	16
A.3 20dB BANDWIDTH	17
A.3.1 20dB Bandwidth Result.....	17
A.3.2 Measurement Plots	18
A.4 CARRIER FREQUENCY SEPARATION	19
A.5 TIME OF OCCUPANCY	21
A.5.1 Time of Occupancy	21
A.6 NUMBER OF HOPPING CHANNELS	31
A.7 MAXIMUM PEAK OUTPUT POWER	32
A.7.1 Maximum Peak Output Power.....	32
A.7.2 Measurement Plots	33
A.8 EMISSION LIMITATIONS MEASUREMENT	34
A.8.1 Band Edge.....	34
A.8.2 Spurious Emission	36

A.1 CONDUCTED EMISSION

Test Date	2021/02/22	Temp./Hum.	22°C/53%
Test Voltage	AC 120V 60Hz (Via AC Adapter)	Tested By	Chucky Chiu
Test SKU	SKU #1 (with INPAQ Antenna)		

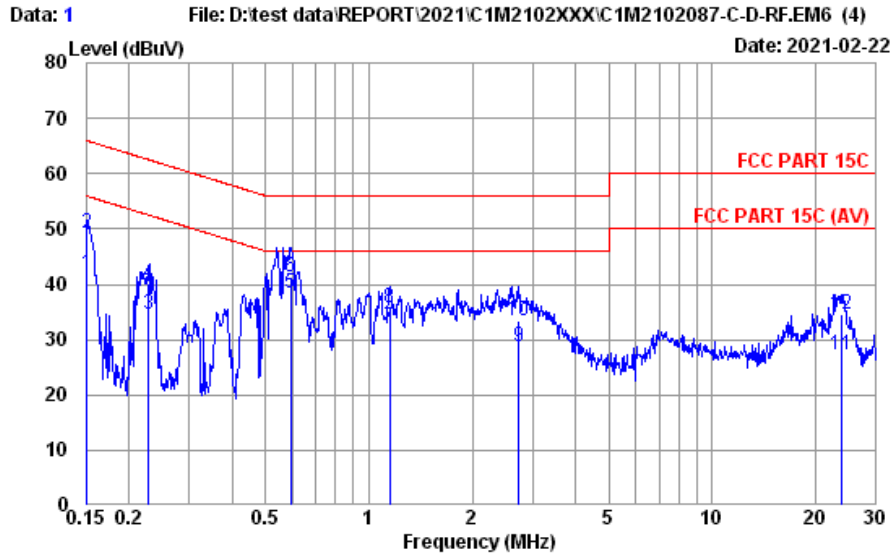

Site No. : No.8 Shielded Room Data No. : 1
 Instrument 1 : Receiver ESR3(774)
 Instrument 2 : ENH432 (567)(A)|CE-08|ESH3-Z2 (354)
 Limit : FCC PART 15C Phase : NEUTRAL
 Environment : 22°C / 53% Engineer : Chucky Chiu
 EUT Model : 15Z90P Test Rating : 120Vac/60Hz
 Test Mode : Operating

	Freq. (MHz)	AMI Factor (dB)	Cable Loss (dB)	Pulse Att. (dB)	Reading (dBμV)	Emission Level (dBμV)	Limits (dBμV)	Margin (dB)	Remark
1	0.151	10.20	0.03	9.85	21.89	41.97	55.96	13.99	Average
2	0.151	10.20	0.03	9.85	29.16	49.24	65.96	16.72	QP
3	0.228	10.20	0.03	9.85	14.36	34.44	52.52	18.08	Average
4	0.228	10.20	0.03	9.85	20.08	40.16	62.52	22.36	QP
5	0.592	10.20	0.03	9.85	18.22	38.30	46.00	7.70	Average
6	0.592	10.20	0.03	9.85	21.11	41.19	56.00	14.81	QP
7	1.147	10.20	0.04	9.85	12.03	32.12	46.00	13.88	Average
8	1.147	10.20	0.04	9.85	15.52	35.61	56.00	20.39	QP
9	2.736	10.30	0.07	9.86	8.46	28.69	46.00	17.31	Average
10	2.736	10.30	0.07	9.86	13.17	33.40	56.00	22.60	QP
11	23.762	10.98	0.22	9.96	6.23	27.39	50.00	22.61	Average
12	23.762	10.98	0.22	9.96	13.56	34.72	60.00	25.28	QP

Remarks: 1. Emission Level= AMI Factor + Cable Loss + Pulse Att. + Reading.
 2. If the average limit is met when using a quasi-peak detector, the EUT shall be deemed to meet both limits and measurement with average detector is unnecessary.

Test Date	2021/02/22	Temp./Hum.	22°C/53%
Test Voltage	AC 120V 60Hz (Via AC Adapter)	Tested By	Chucky Chiu
Test SKU	SKU #1 (with INPAQ Antenna)		

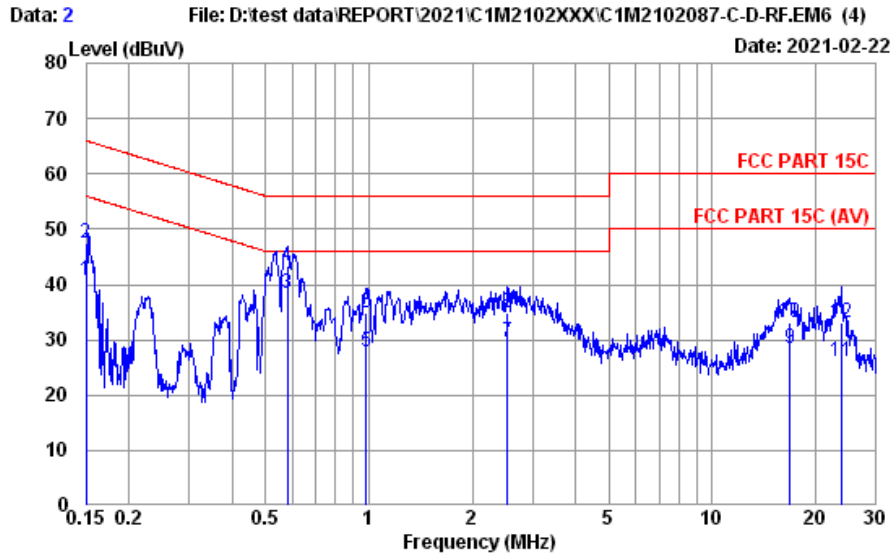

Site No.	: No.8 Shielded Room	Data No.	: 2
Instrument 1	: Receiver ESR3(774)		
Instrument 2	: EMI432 (567)(A) CE-08 ESH3-Z2 (354)		
Limit	: FCC PART 15C	Phase	: LINE
Environment	: 22°C / 53%	Engineer	: Chucky Chiu
EUT Model	: 15Z90P	Test Rating	: 120Vac/60Hz
Test Mode	: Operating		

	Freq. (MHz)	AMI Factor (dB)	Cable Loss (dB)	Pulse Att. (dB)	Reading (dBµV)	Emission Level (dBµV)	Limits (dBµV)	Margin (dB)	Remark
1	0.150	10.20	0.03	9.85	20.57	40.65	56.00	15.35	Average
2	0.150	10.20	0.03	9.85	27.36	47.44	66.00	18.56	QP
3	0.579	10.20	0.03	9.85	18.44	38.52	46.00	7.48	Average
4	0.579	10.20	0.03	9.85	23.34	43.42	56.00	12.58	QP
5	0.984	10.20	0.04	9.85	7.84	27.93	46.00	18.07	Average
6	0.984	10.20	0.04	9.85	14.91	35.00	56.00	21.00	QP
7	2.527	10.30	0.07	9.86	9.28	29.51	46.00	16.49	Average
8	2.527	10.30	0.07	9.86	14.53	34.76	56.00	21.24	QP
9	16.839	10.54	0.18	9.92	7.74	28.38	50.00	21.62	Average
10	16.839	10.54	0.18	9.92	12.58	33.22	60.00	26.78	QP
11	23.888	10.60	0.22	9.96	5.24	26.02	50.00	23.98	Average
12	23.888	10.60	0.22	9.96	12.32	33.10	60.00	26.90	QP

Remarks: 1. Emission Level= AMI Factor + Cable Loss + Pulse Att. + Reading.
 2. If the average limit is met when using a quasi-peak detector, the EUT shall be deemed to meet both limits and measurement with average detector is unnecessary.

Test Date	2021/03/05	Temp./Hum.	21°C/59%
Test Voltage	AC 120V 60Hz (Via AC Adapter)	Tested By	Bruce Tseng
Test SKU	SKU #2 (with LUXSHARE-ICT Antenna)		

Data: 4 File: D:\test data\REPORT\2021\1C1M2102XXX\1C1M2102087\1C1M2102087-C-D-RF.EM6 (4)

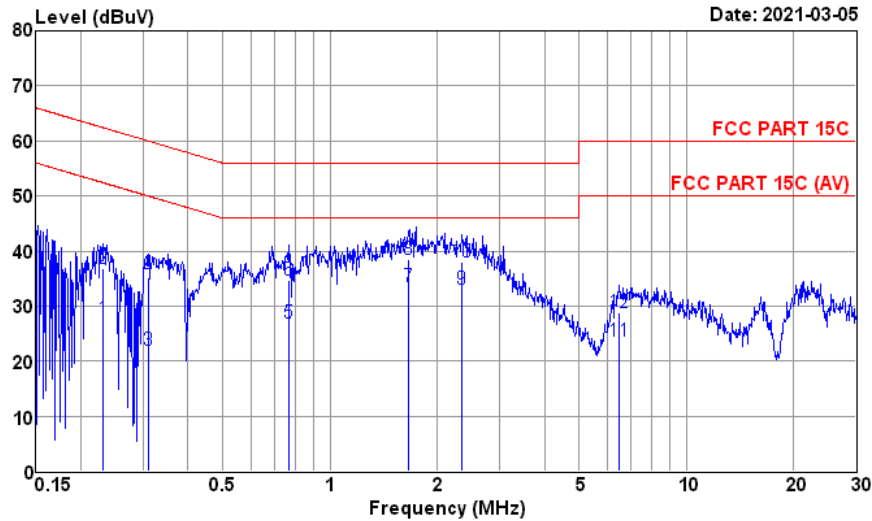

Site No. : No.7 Shielded Room Data No. : 4
 Instrument 1 : Receiver ESCI(746)
 Instrument 2 : ESH2-Z5 (366)(A)|CE-07|ESH3-Z2 (495)
 Limit : FCC PART 15C Phase : NEUTRAL
 Environment : 21°C / 59% Engineer : Bruce
 EUT Model : 15Z90P Test Rating : 120Vac/60Hz
 Test Mode : Operating

	Freq. (MHz)	AMN Factor (dB)	Cable Loss (dB)	Pulse Att. (dB)	Reading (dBμV)	Emission Level (dBμV)	Limits (dBμV)	Margin (dB)	Remark
1	0.232	0.06	0.04	9.86	17.66	27.62	52.40	24.78	Average
2	0.232	0.06	0.04	9.86	26.78	36.74	62.40	25.66	QP
3	0.310	0.07	0.04	9.86	11.88	21.85	49.97	28.12	Average
4	0.310	0.07	0.04	9.86	25.24	35.21	59.97	24.76	QP
5	0.767	0.09	0.05	9.86	17.03	27.03	46.00	18.97	Average
6	0.767	0.09	0.05	9.86	24.75	34.75	56.00	21.25	QP
7	1.669	0.12	0.06	9.86	23.48	33.52	46.00	12.48	Average
8	1.669	0.12	0.06	9.86	28.34	38.38	56.00	17.62	QP
9	2.348	0.15	0.08	9.86	22.94	33.03	46.00	12.97	Average
10	2.348	0.15	0.08	9.86	28.01	38.10	56.00	17.90	QP
11	6.490	0.28	0.14	9.88	13.22	23.52	50.00	26.48	Average
12	6.490	0.28	0.14	9.88	18.57	28.87	60.00	31.13	QP

Remarks: 1. Emission Level= AMN Factor + Cable Loss + Pulse Att. + Reading.
 2. If the average limit is met when using a quasi-peak detector, the EUT shall be deemed to meet both limits and measurement with average detector is unnecessary.

Test Date	2021/03/05	Temp./Hum.	21°C/59%
Test Voltage	AC 120V 60Hz (Via AC Adapter)	Tested By	Bruce Tseng
Test SKU	SKU #2 (with LUXSHARE-ICT Antenna)		

Data: 3 File: D:\test data\REPORT\2021\1C1M2102XXX\1C1M2102087\1C1M2102087-C-D-RF.EM6 (4)

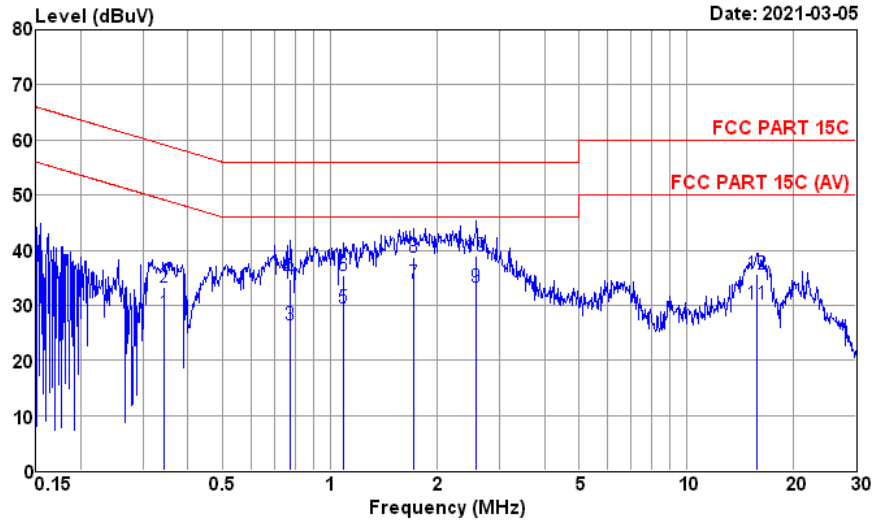

Site No. : No.7 Shielded Room Data No. : 3
 Instrument 1 : Receiver ESCI(746)
 Instrument 2 : ESH2-Z5 (366)(A)|CE-07|ESH3-Z2 (495)
 Limit : FCC PART 15C Phase : LINE
 Environment : 21°C / 59% Engineer : Bruce
 EUT Model : 15Z90P Test Rating : 120Vac/60Hz
 Test Mode : Operating

	AMI	Cable	Pulse	Emission					
Freq. (MHz)	Factor (dB)	Loss (dB)	Att. (dB)	Reading (dBμV)	Level (dBμV)	Limits (dBμV)	Margin (dB)	Remark	
1	0.341	0.06	0.04	9.86	18.63	28.59	49.17	20.58	Average
2	0.341	0.06	0.04	9.86	23.38	33.34	59.17	25.83	QP
3	0.775	0.07	0.05	9.86	16.40	26.38	46.00	19.62	Average
4	0.775	0.07	0.05	9.86	24.78	34.76	56.00	21.24	QP
5	1.093	0.08	0.05	9.86	19.58	29.57	46.00	16.43	Average
6	1.093	0.08	0.05	9.86	25.38	35.37	56.00	20.63	QP
7	1.726	0.10	0.06	9.86	24.00	34.02	46.00	11.98	Average
8	1.726	0.10	0.06	9.86	28.63	38.65	56.00	17.35	QP
9	2.582	0.13	0.08	9.86	23.33	33.40	46.00	12.60	Average
10	2.582	0.13	0.08	9.86	28.80	38.87	56.00	17.13	QP
11	15.820	0.57	0.23	9.93	19.42	30.15	50.00	19.85	Average
12	15.820	0.57	0.23	9.93	24.81	35.54	60.00	24.46	QP

Remarks: 1. Emission Level= AMN Factor + Cable Loss + Pulse Att. + Reading.
 2. If the average limit is met when using a quasi-peak detector, the EUT shall be deemed to meet both limits and measurement with average detector is unnecessary.

A.2 RADIATED EMISSION

Test Date	2021/02/10 ~ 22	Temp./Hum.	18 ~ 20°C/44 ~ 59%
Test Voltage	AC 120V 60Hz (Via AC Adapter)	Tested By	Kuper Hsu

A.2.1 Emissions within Restricted Frequency Bands

A.2.1.1 Frequency 9kHz~30MHz

The emissions (9kHz~30MHz) not reported for there is no emission be found.

A.2.1.2 Frequency Below 1GHz

Mode	GFSK	Frequency	TX 2441MHz
------	------	-----------	------------

Antenna at Horizontal Polarization

Emission Frequency (MHz)	Antenna Factor (dB/m)	Cable Loss (dB)	Preamplifier Gain (dB)	Read Level (dBμV)	Emission Level (dBμV/m)	Limits (dBμV/m)	Margin (dB)	Detector
33.880	16.85	1.32	28.13	47.49	37.53	40.00	2.47	Peak
121.180	11.87	2.69	27.94	53.70	40.32	43.50	3.18	Peak
240.490	11.69	3.93	27.62	52.46	40.46	46.00	5.54	Peak
593.570	18.35	7.02	29.39	43.82	39.80	46.00	6.20	Peak
884.570	20.33	8.63	28.91	43.52	43.57	46.00	2.43	Peak
963.140	20.98	9.00	28.69	39.01	40.30	54.00	13.70	Peak

Antenna at Vertical Polarization

Emission Frequency (MHz)	Antenna Factor (dB/m)	Cable Loss (dB)	Preamplifier Gain (dB)	Read Level (dBμV)	Emission Level (dBμV/m)	Limits (dBμV/m)	Margin (dB)	Detector
33.880	16.85	1.32	28.13	47.66	37.70	40.00	2.30	Peak
120.210	11.90	2.68	27.95	54.78	41.41	43.50	2.09	Peak
245.340	11.90	3.97	27.62	52.26	40.51	46.00	5.49	Peak
593.570	18.35	7.02	29.39	45.05	41.03	46.00	4.97	Peak
889.420	20.36	8.66	28.88	43.51	43.65	46.00	2.35	Peak
964.110	21.01	9.00	28.69	38.80	40.12	54.00	13.88	Peak

A.2.1.3 Frequency Above 1 GHz to 10th harmonics

Band Edge:

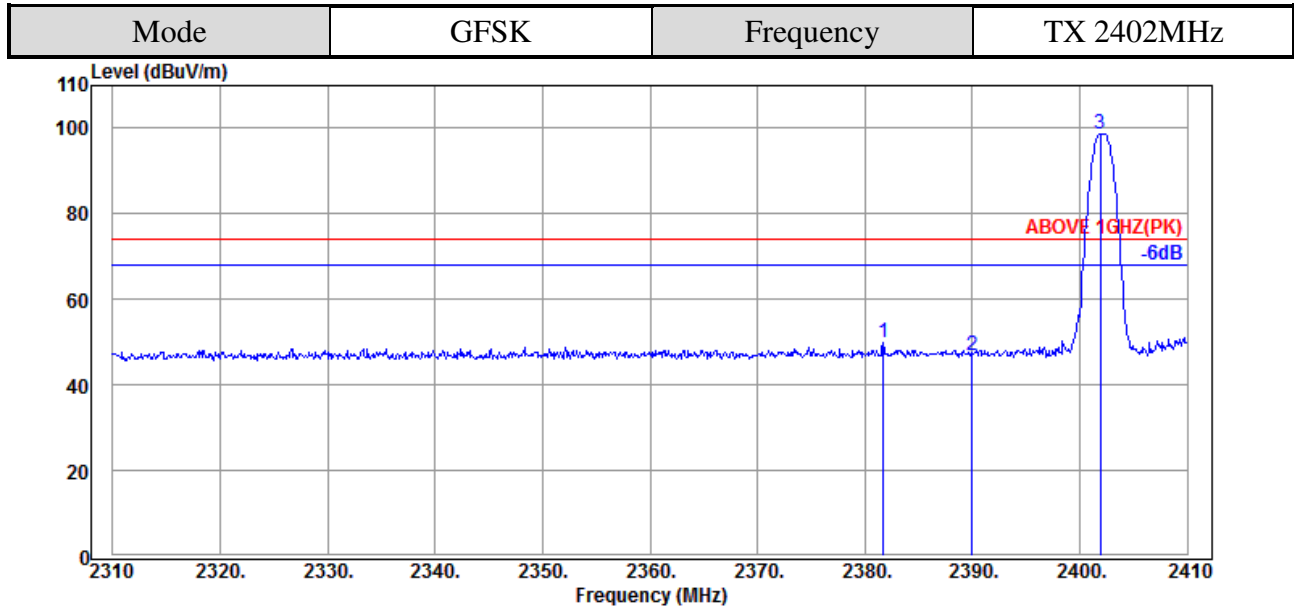

Antenna at Horizontal Polarization

Emission Frequency (MHz)	Antenna Factor (dB/m)	Cable Loss (dB)	Preamplifier Gain (dB)	Read Level (dBμV)	Emission Level (dBμV/m)	Limits (dBμV/m)	Margin (dB)	Detector
2381.700	32.41	7.95	34.58	44.14	49.92	74.00	24.08	Peak
2390.000	32.44	7.95	34.58	41.22	47.03	74.00	26.97	Peak
@ 2401.900	32.50	7.95	34.59	92.84	98.70	---	---	Peak

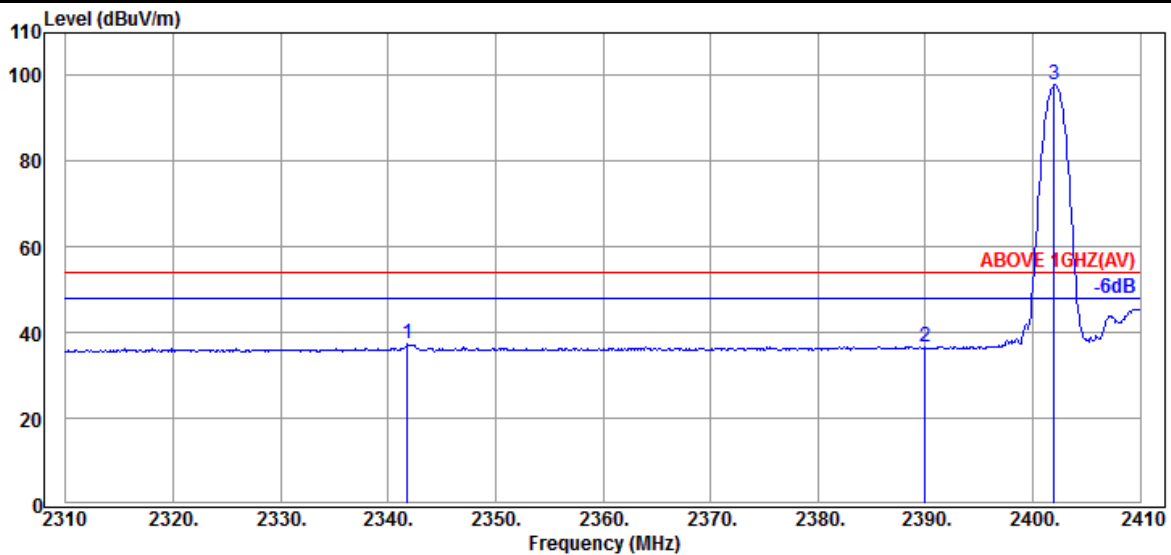

Antenna at Horizontal Polarization

Emission Frequency (MHz)	Antenna Factor (dB/m)	Cable Loss (dB)	Preamplifier Gain (dB)	Read Level (dBμV)	Emission Level (dBμV/m)	Limits (dBμV/m)	Margin (dB)	Detector
2341.800	32.17	7.92	34.57	31.75	37.27	54.00	16.73	Average
2390.000	32.44	7.95	34.58	30.73	36.54	54.00	17.46	Average
@ 2402.000	32.50	7.95	34.59	91.91	97.77	---	---	Average

Remark: The “@” means fundamental frequency, it is ignored in this section.

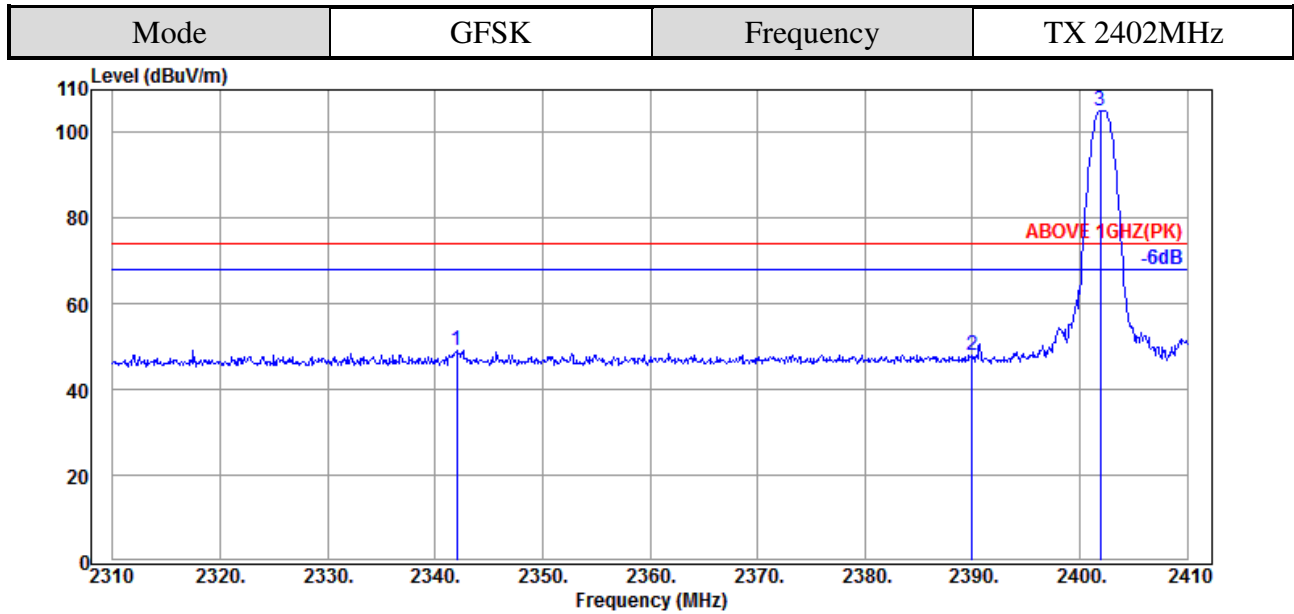

Antenna at Vertical Polarization

Emission Frequency (MHz)	Antenna Factor (dB/m)	Cable Loss (dB)	Preamp Gain (dB)	Read Level (dBμV)	Emission Level (dBμV/m)	Limits (dBμV/m)	Margin (dB)	Detector
2342.000	32.17	7.92	34.57	43.74	49.26	74.00	24.74	Peak
2390.000	32.44	7.95	34.58	42.32	48.13	74.00	25.87	Peak
@ 2401.900	32.50	7.95	34.59	99.32	105.18	---	---	Peak

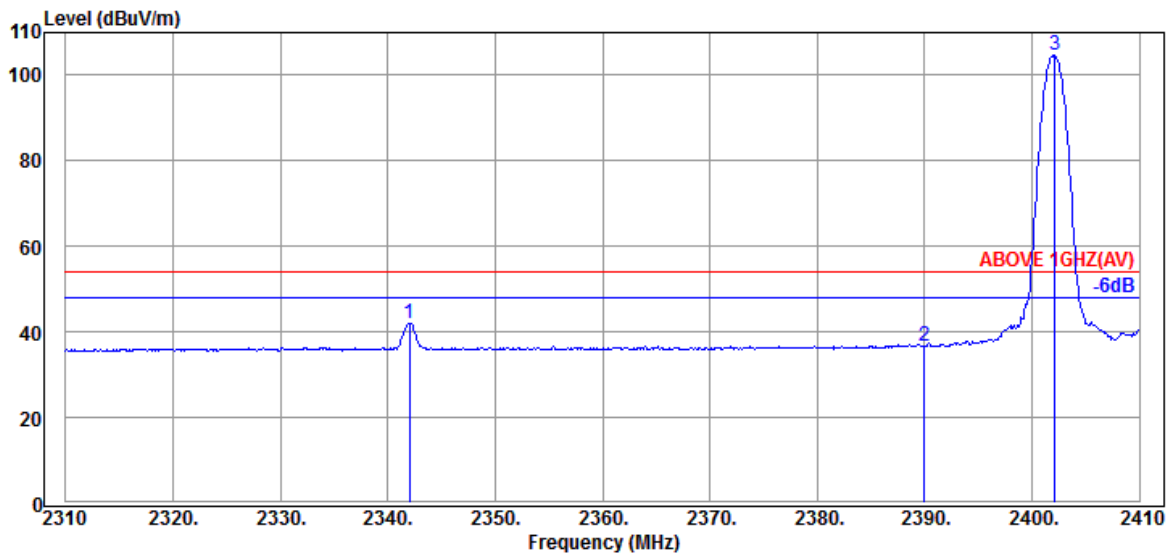

Antenna at Vertical Polarization

Emission Frequency (MHz)	Antenna Factor (dB/m)	Cable Loss (dB)	Preamp Gain (dB)	Read Level (dBμV)	Emission Level (dBμV/m)	Limits (dBμV/m)	Margin (dB)	Detector
2342.000	32.17	7.92	34.57	36.57	42.09	54.00	11.91	Average
2390.000	32.44	7.95	34.58	30.88	36.69	54.00	17.31	Average
@ 2402.100	32.50	7.95	34.59	98.69	104.55	---	---	Average

Remark: The “@” means fundamental frequency, it is ignored in this section.

Mode	GFSK	Frequency	TX 2480MHz
------	------	-----------	------------

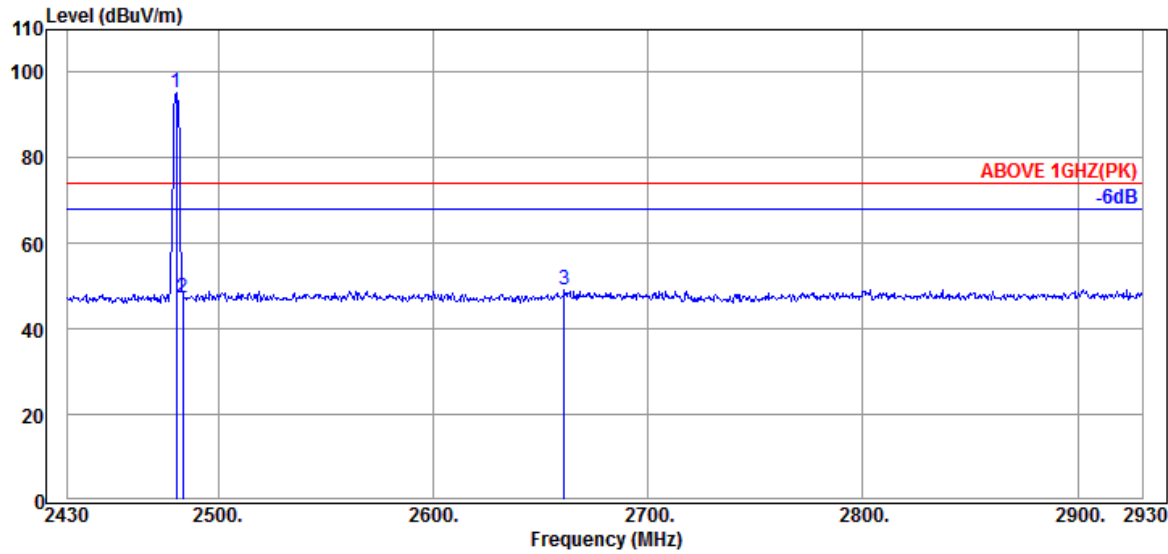

Antenna at Horizontal Polarization

Emission Frequency (MHz)	Antenna Factor (dB/m)	Cable Loss (dB)	Preamplifier Gain (dB)	Read Level (dBμV)	Emission Level (dBμV/m)	Limits (dBμV/m)	Margin (dB)	Detector
@ 2480.500	32.11	7.99	34.60	89.73	95.23	---	---	Peak
2483.500	32.14	7.99	34.61	41.73	47.25	74.00	26.75	Peak
2661.000	32.26	8.08	34.64	43.40	49.10	74.00	24.90	Peak

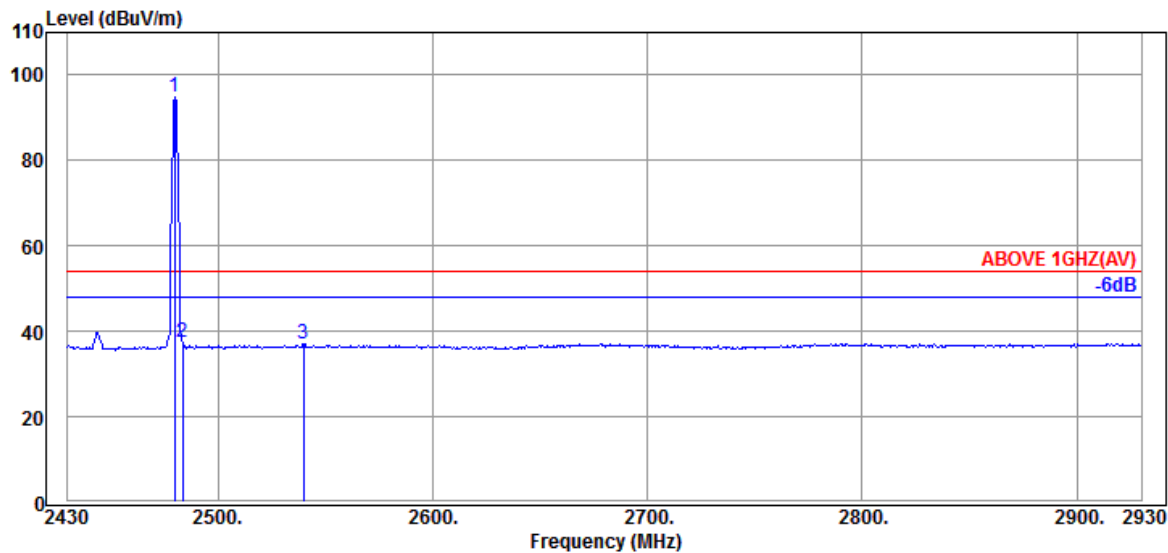

Antenna at Horizontal Polarization

Emission Frequency (MHz)	Antenna Factor (dB/m)	Cable Loss (dB)	Preamplifier Gain (dB)	Read Level (dBμV)	Emission Level (dBμV/m)	Limits (dBμV/m)	Margin (dB)	Detector
@ 2480.000	32.11	7.99	34.60	89.40	94.90	---	---	Average
2483.500	32.14	7.99	34.61	31.89	37.41	54.00	16.59	Average
2540.000	32.29	8.02	34.62	31.52	37.21	54.00	16.79	Average

Remark: The “@” means fundamental frequency, it is ignored in this section.

Mode	GFSK	Frequency	TX 2480MHz
------	------	-----------	------------

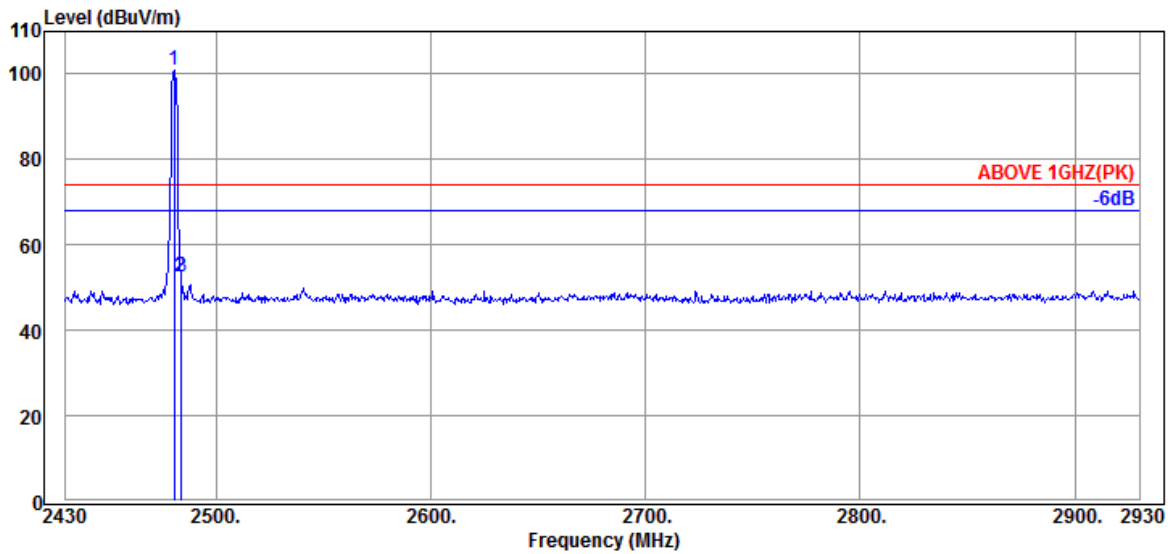

Antenna at Vertical Polarization

Emission Frequency (MHz)	Antenna Factor (dB/m)	Cable Loss (dB)	Preamplifier Gain (dB)	Read Level (dBμV)	Emission Level (dBμV/m)	Limits (dBμV/m)	Margin (dB)	Detector
@ 2480.500	32.11	7.99	34.60	95.39	100.89	---	---	Peak
2483.500	32.14	7.99	34.61	47.18	52.70	74.00	21.30	Peak
2484.000	32.14	7.99	34.61	46.97	52.49	74.00	21.51	Peak

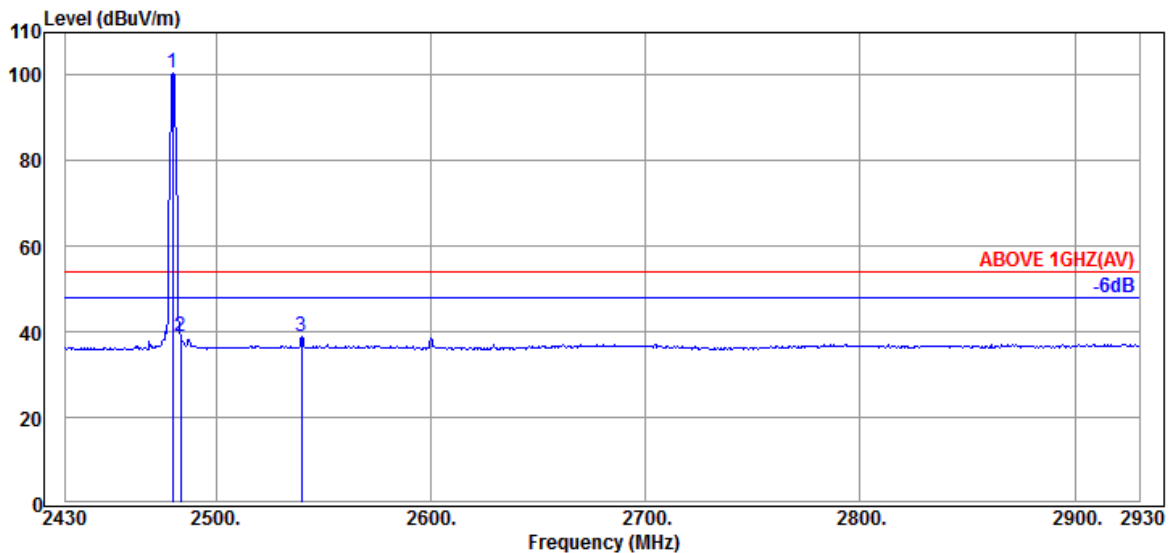

Antenna at Vertical Polarization

Emission Frequency (MHz)	Antenna Factor (dB/m)	Cable Loss (dB)	Preamplifier Gain (dB)	Read Level (dBμV)	Emission Level (dBμV/m)	Limits (dBμV/m)	Margin (dB)	Detector
@ 2480.000	32.11	7.99	34.60	95.22	100.72	---	---	Average
2483.500	32.14	7.99	34.61	33.32	38.84	54.00	15.16	Average
2540.000	32.29	8.02	34.62	33.37	39.06	54.00	14.94	Average

Remark: The “@” means fundamental frequency, it is ignored in this section.

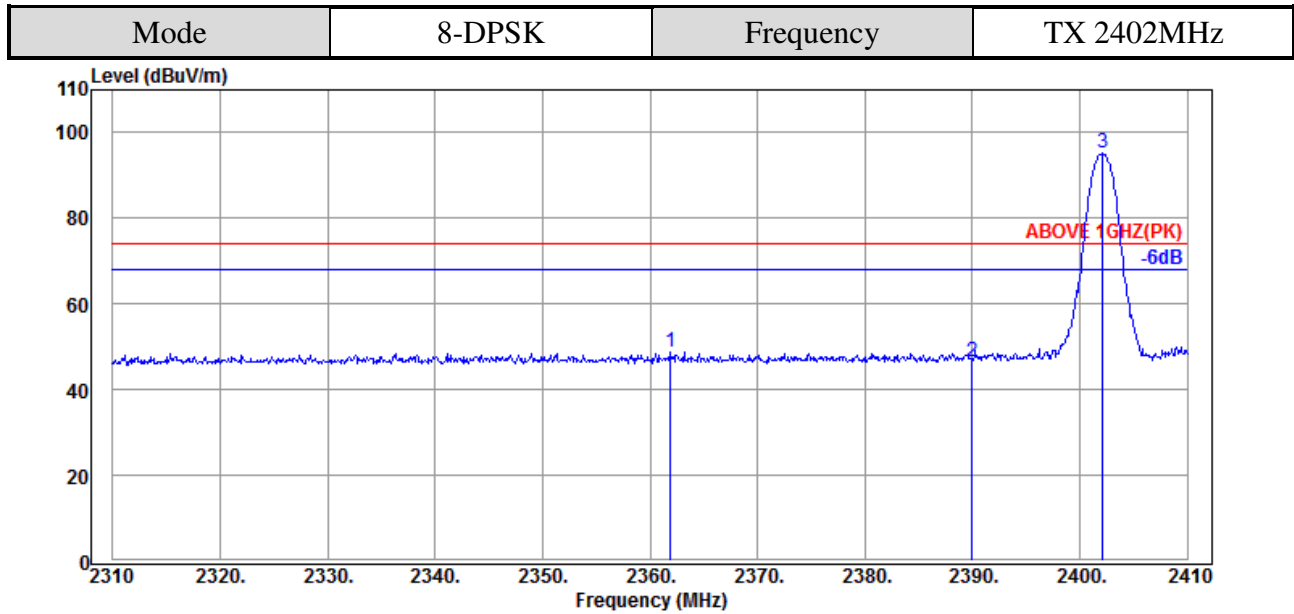

Antenna at Horizontal Polarization

Emission Frequency (MHz)	Antenna Factor (dB/m)	Cable Loss (dB)	Preamp Gain (dB)	Read Level (dBμV)	Emission Level (dBμV/m)	Limits (dBμV/m)	Margin (dB)	Detector
2361.900	32.33	7.94	34.58	42.99	48.68	74.00	25.32	Peak
2390.000	32.44	7.95	34.58	40.86	46.67	74.00	27.33	Peak
@ 2402.100	32.50	7.95	34.59	89.35	95.21	---	---	Peak

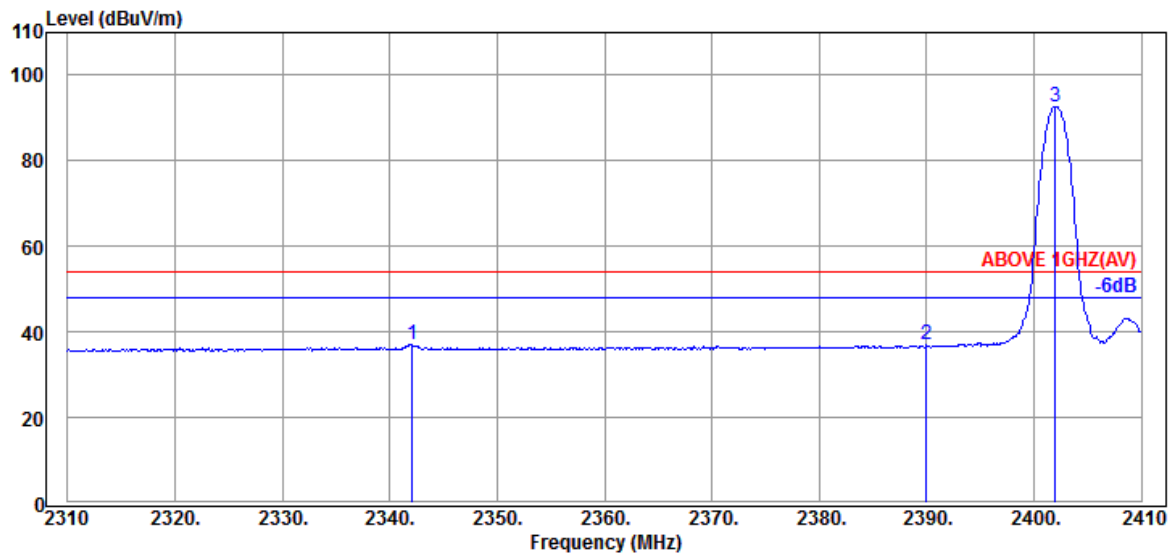

Antenna at Horizontal Polarization

Emission Frequency (MHz)	Antenna Factor (dB/m)	Cable Loss (dB)	Preamp Gain (dB)	Read Level (dBμV)	Emission Level (dBμV/m)	Limits (dBμV/m)	Margin (dB)	Detector
2342.100	32.17	7.92	34.57	31.62	37.14	54.00	16.86	Average
2390.000	32.44	7.95	34.58	31.07	36.88	54.00	17.12	Average
@ 2402.000	32.50	7.95	34.59	86.85	92.71	---	---	Average

Remark: The “@” means fundamental frequency, it is ignored in this section.

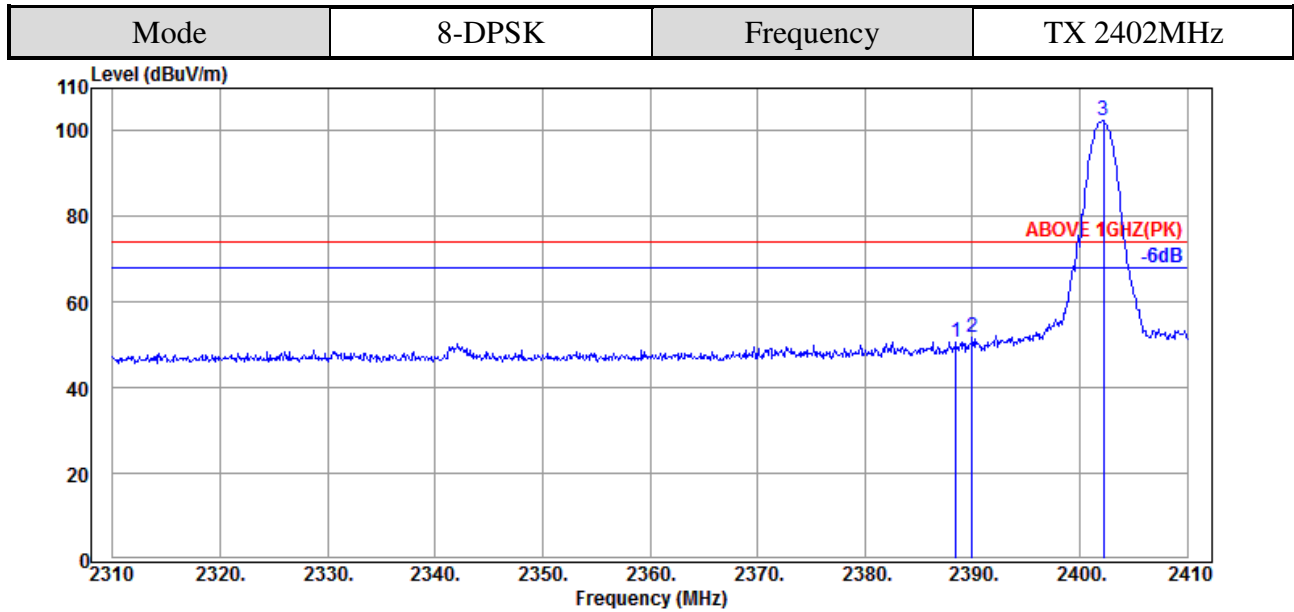

Antenna at Vertical Polarization

Emission Frequency (MHz)	Antenna Factor (dB/m)	Cable Loss (dB)	Preamplifier Gain (dB)	Read Level (dBμV)	Emission Level (dBμV/m)	Limits (dBμV/m)	Margin (dB)	Detector
2388.500	32.44	7.95	34.58	44.93	50.74	74.00	23.26	Peak
2390.000	32.44	7.95	34.58	45.85	51.66	74.00	22.34	Peak
@ 2402.200	32.50	7.95	34.59	96.47	102.33	---	---	Peak

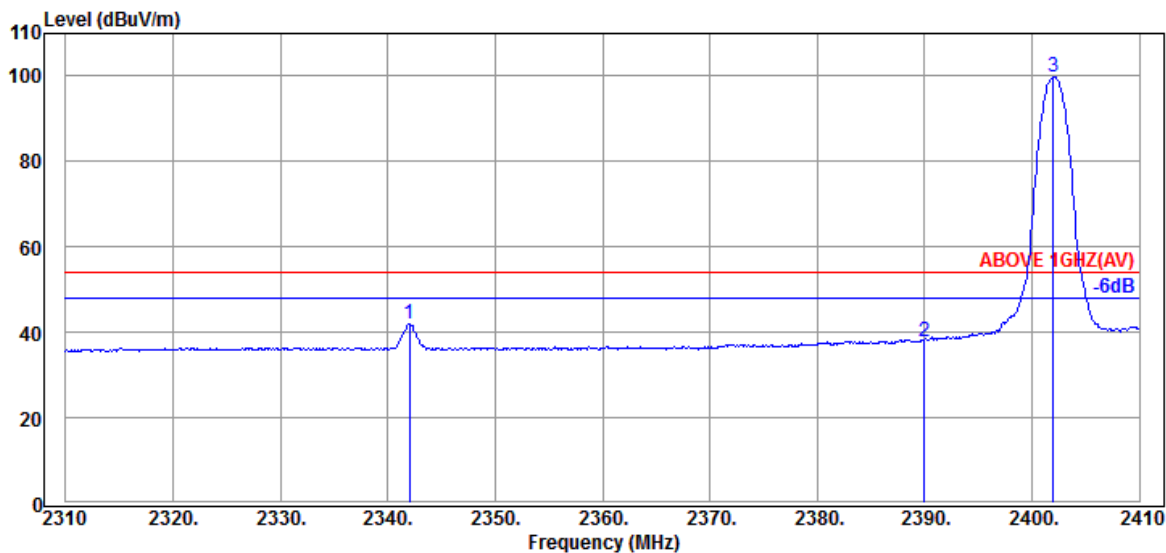

Antenna at Vertical Polarization

Emission Frequency (MHz)	Antenna Factor (dB/m)	Cable Loss (dB)	Preamplifier Gain (dB)	Read Level (dBμV)	Emission Level (dBμV/m)	Limits (dBμV/m)	Margin (dB)	Detector
2342.000	32.17	7.92	34.57	36.47	41.99	54.00	12.01	Average
2390.000	32.44	7.95	34.58	32.17	37.98	54.00	16.02	Average
@ 2402.000	32.50	7.95	34.59	93.96	99.82	---	---	Average

Remark: The “@” means fundamental frequency, it is ignored in this section.

Mode	8-DPSK	Frequency	TX 2480MHz
------	--------	-----------	------------

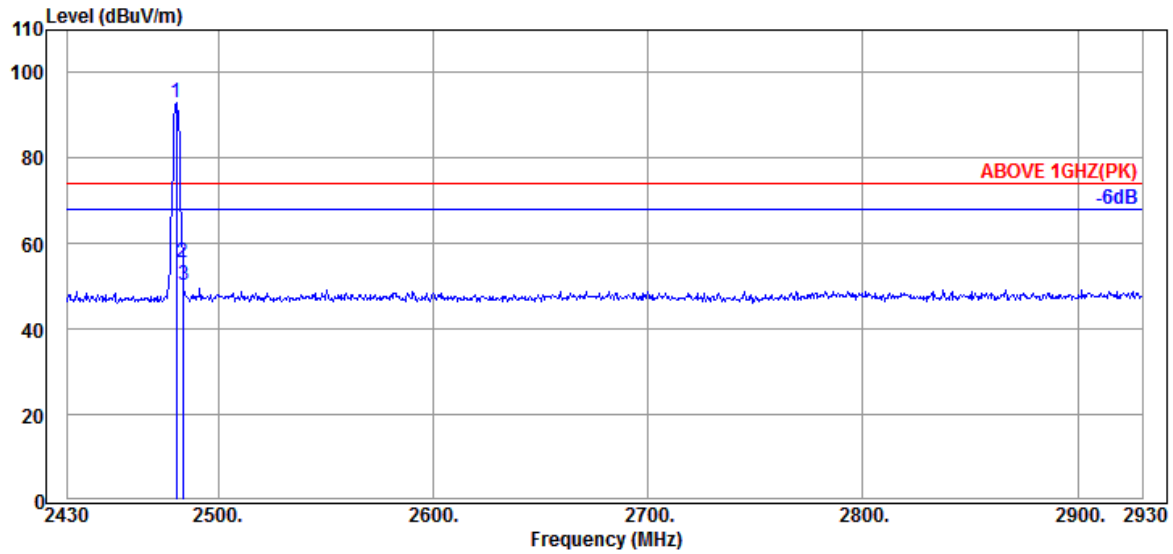

Antenna at Horizontal Polarization

Emission Frequency (MHz)	Antenna Factor (dB/m)	Cable Loss (dB)	Preamplifier Gain (dB)	Read Level (dBμV)	Emission Level (dBμV/m)	Limits (dBμV/m)	Margin (dB)	Detector
@ 2480.500	32.11	7.99	34.60	87.42	92.92	---	---	Peak
2483.500	32.14	7.99	34.61	50.06	55.58	74.00	18.42	Peak
2484.000	32.14	7.99	34.61	44.57	50.09	74.00	23.91	Peak

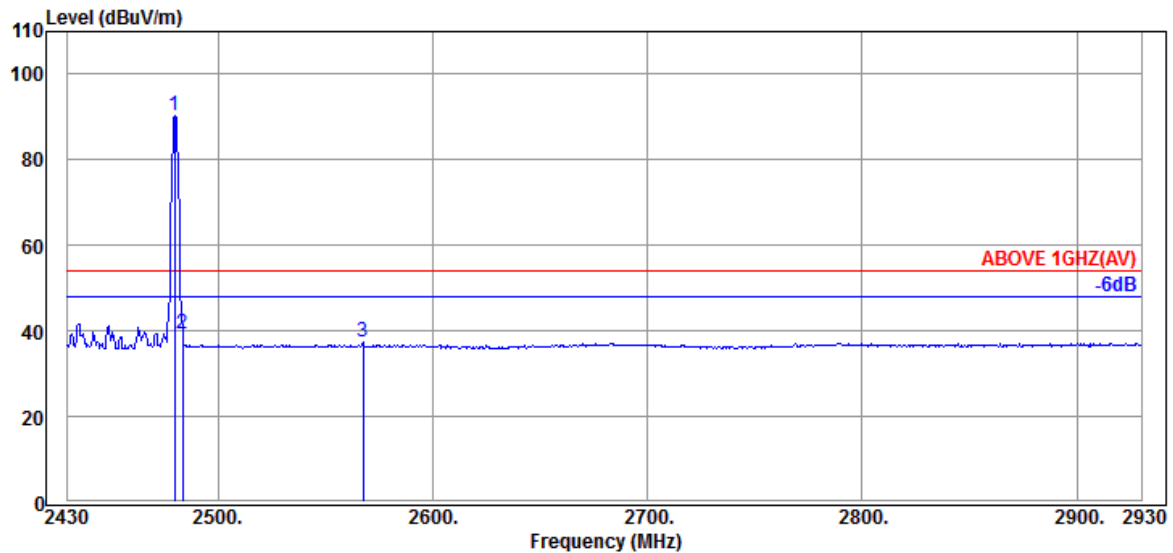

Antenna at Horizontal Polarization

Emission Frequency (MHz)	Antenna Factor (dB/m)	Cable Loss (dB)	Preamplifier Gain (dB)	Read Level (dBμV)	Emission Level (dBμV/m)	Limits (dBμV/m)	Margin (dB)	Detector
@ 2480.000	32.11	7.99	34.60	85.02	90.52	---	---	Average
2483.500	32.14	7.99	34.61	33.65	39.17	54.00	14.83	Average
2567.500	32.27	8.04	34.62	31.57	37.26	54.00	16.74	Average

Remark: The “@” means fundamental frequency, it is ignored in this section.

Mode	8-DPSK	Frequency	TX 2480MHz
------	--------	-----------	------------

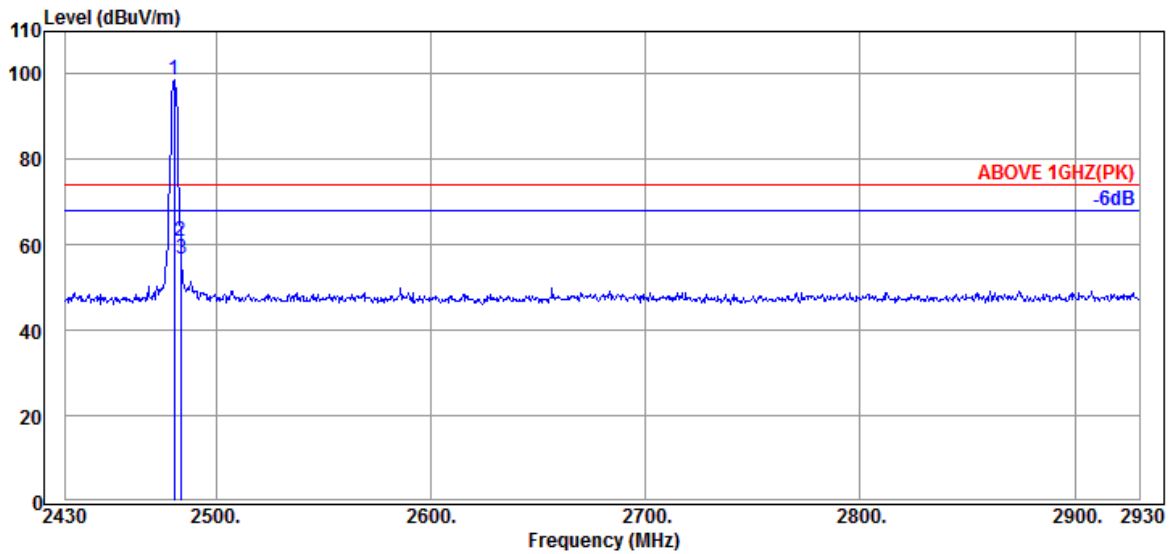

Antenna at Vertical Polarization

Emission Frequency (MHz)	Antenna Factor (dB/m)	Cable Loss (dB)	Preamplifier Gain (dB)	Read Level (dBμV)	Emission Level (dBμV/m)	Limits (dBμV/m)	Margin (dB)	Detector
@ 2480.500	32.11	7.99	34.60	93.15	98.65	---	---	Peak
2483.500	32.14	7.99	34.61	55.38	60.90	74.00	13.10	Peak
2484.000	32.14	7.99	34.61	51.33	56.85	74.00	17.15	Peak

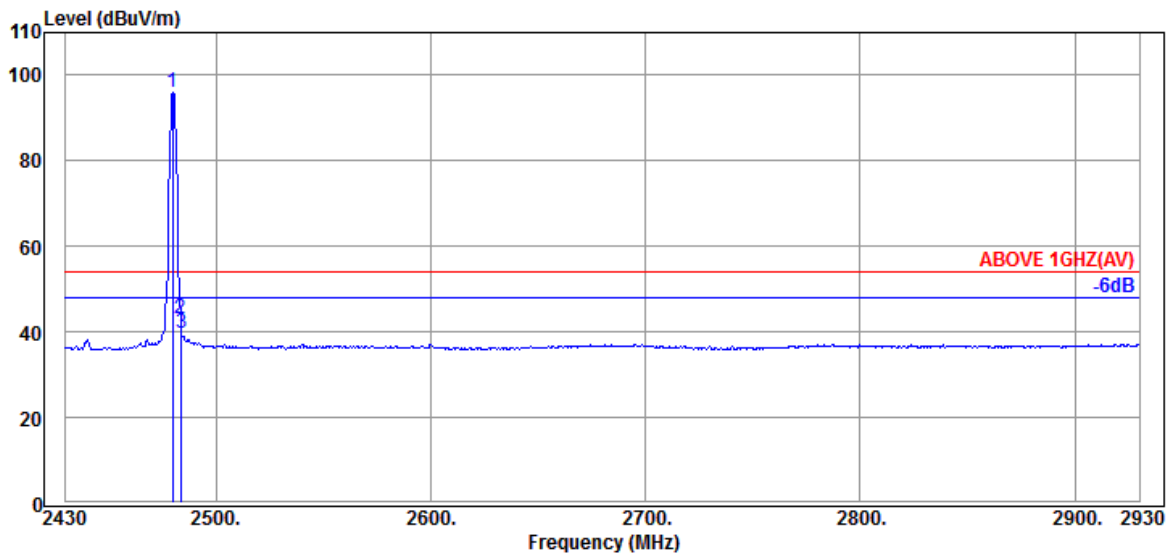

Antenna at Vertical Polarization

Emission Frequency (MHz)	Antenna Factor (dB/m)	Cable Loss (dB)	Preamplifier Gain (dB)	Read Level (dBμV)	Emission Level (dBμV/m)	Limits (dBμV/m)	Margin (dB)	Detector
@ 2480.000	32.11	7.99	34.60	90.51	96.01	---	---	Average
2483.500	32.14	7.99	34.61	37.72	43.24	54.00	10.76	Average
2484.000	32.14	7.99	34.61	34.33	39.85	54.00	14.15	Average

Remark: The “@” means fundamental frequency, it is ignored in this section.

A.2.2 Emissions outside the frequency band:

The emissions (up to 25GHz) not reported for there is no emission be found.

Mode	GFSK	Frequency	TX 2402MHz
------	------	-----------	------------

Antenna at Horizontal Polarization

Emission Frequency (MHz)	Antenna Factor (dB/m)	Cable Loss (dB)	Preamplifier Gain (dB)	Read Level (dBμV)	Emission Level (dBμV/m)	Limits (dBμV/m)	Margin (dB)	Detector
4804.000	34.10	10.49	39.33	36.50	41.76	54.00	12.24	Peak

Antenna at Vertical Polarization

Emission Frequency (MHz)	Antenna Factor (dB/m)	Cable Loss (dB)	Preamplifier Gain (dB)	Read Level (dBμV)	Emission Level (dBμV/m)	Limits (dBμV/m)	Margin (dB)	Detector
4804.000	34.10	10.49	39.33	37.90	43.16	54.00	10.84	Peak

Mode	GFSK	Frequency	TX 2441MHz
------	------	-----------	------------

Antenna at Horizontal Polarization

Emission Frequency (MHz)	Antenna Factor (dB/m)	Cable Loss (dB)	Preamplifier Gain (dB)	Read Level (dBμV)	Emission Level (dBμV/m)	Limits (dBμV/m)	Margin (dB)	Detector
4882.000	34.03	10.54	39.29	35.50	40.78	54.00	13.22	Peak

Antenna at Vertical Polarization

Emission Frequency (MHz)	Antenna Factor (dB/m)	Cable Loss (dB)	Preamplifier Gain (dB)	Read Level (dBμV)	Emission Level (dBμV/m)	Limits (dBμV/m)	Margin (dB)	Detector
4882.000	34.03	10.54	39.29	36.68	41.96	54.00	12.04	Peak

Mode	GFSK	Frequency	TX 2480MHz
------	------	-----------	------------

Antenna at Horizontal Polarization

Emission Frequency (MHz)	Antenna Factor (dB/m)	Cable Loss (dB)	Preamplifier Gain (dB)	Read Level (dBμV)	Emission Level (dBμV/m)	Limits (dBμV/m)	Margin (dB)	Detector
4960.000	34.10	10.60	39.25	35.39	40.84	54.00	13.16	Peak

Antenna at Vertical Polarization

Emission Frequency (MHz)	Antenna Factor (dB/m)	Cable Loss (dB)	Preamplifier Gain (dB)	Read Level (dBμV)	Emission Level (dBμV/m)	Limits (dBμV/m)	Margin (dB)	Detector
4960.000	34.10	10.60	39.25	36.25	41.70	54.00	12.30	Peak

A.2.3 Emissions in Non-restricted Frequency Bands:

All emission levels below the FCC 15.209(a)/RSS-Gen Section 8.9 table 4 general radiated emissions limits is not required.

A.3 20dB BANDWIDTH

Test Date	2019/09/18	Temp./Hum.	25°C /51%
Cable Loss	0.50dB	Tested By	Martin Chen
Test Voltage	AC 120V 60Hz (Via AC Adapter)		

A.3.1 20dB Bandwidth Result

Mode	Centre Frequency (MHz)	20dB Bandwidth (MHz)	99%Occupied Bandwidth (MHz) (Reference only)	2/3 (20dB Bandwidth)
GFSK	2402	0.9217	0.86410	0.614
	2441	0.9232	0.86892	0.615
	2480	0.9220	0.86466	0.615
8-DPSK	2402	1.386	1.3581	0.924
	2441	1.386	1.3566	0.924
	2480	1.389	1.3547	0.926

Remark: The maximum two-thirds of the 20dB bandwidth is the limit for carrier frequency separation presented.

A.3.2 Measurement Plots

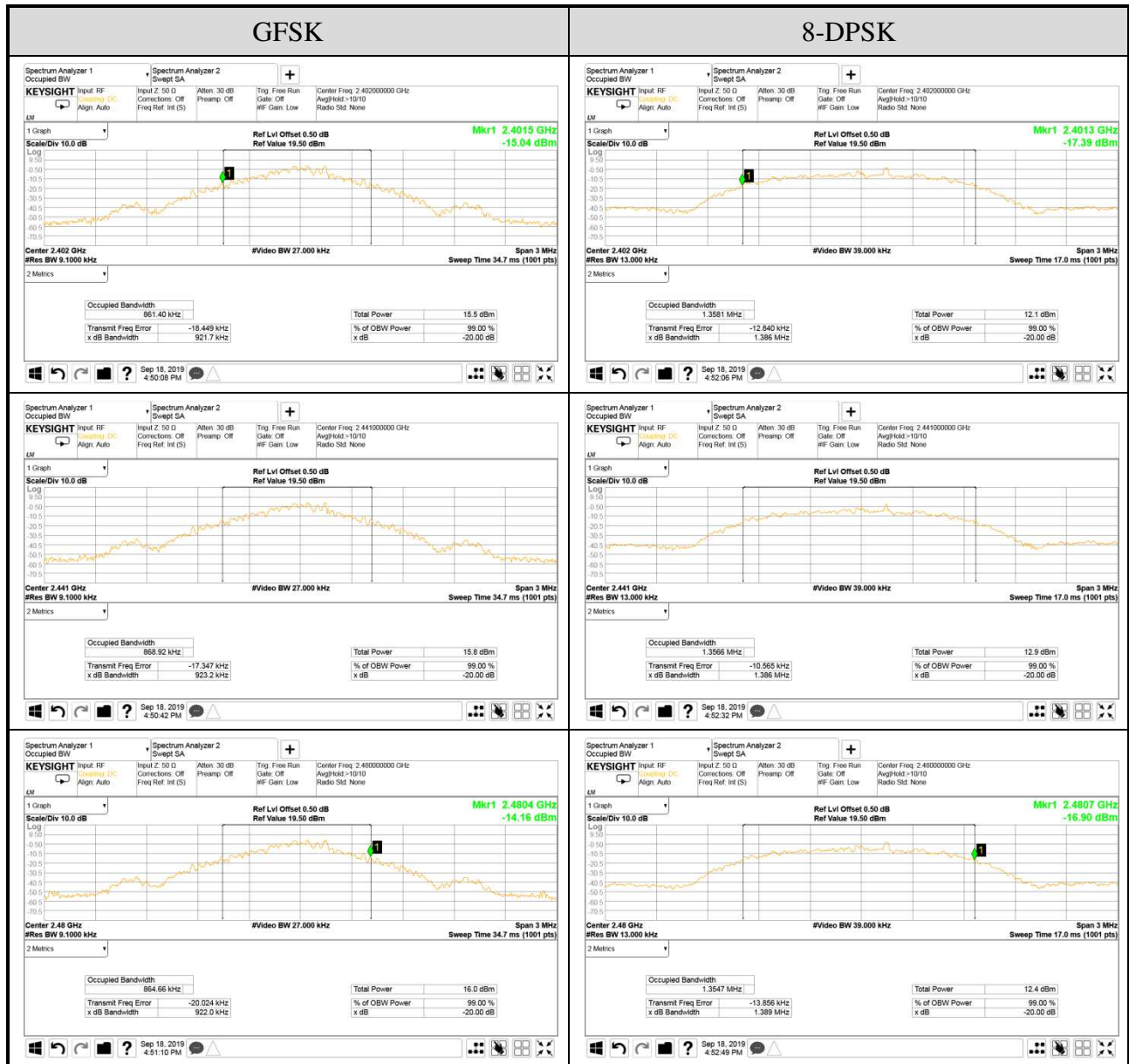

A.4 CARRIER FREQUENCY SEPARATION

Test Date	2019/09/19	Temp./Hum.	25°C /54%
Cable Loss	0.50dB	Tested By	Martin Chen
Test Voltage	AC 120V 60Hz (Via AC Adapter)		

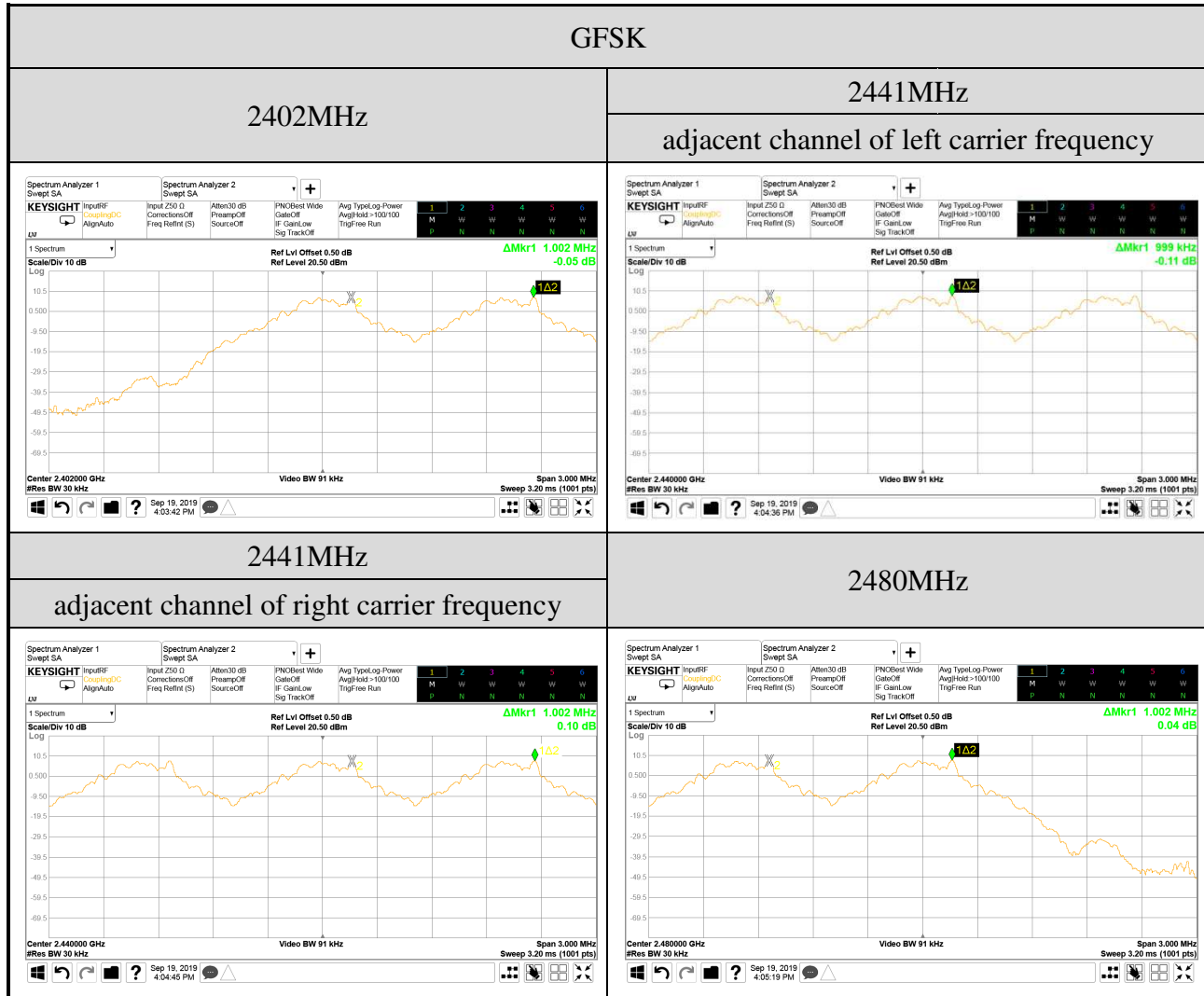

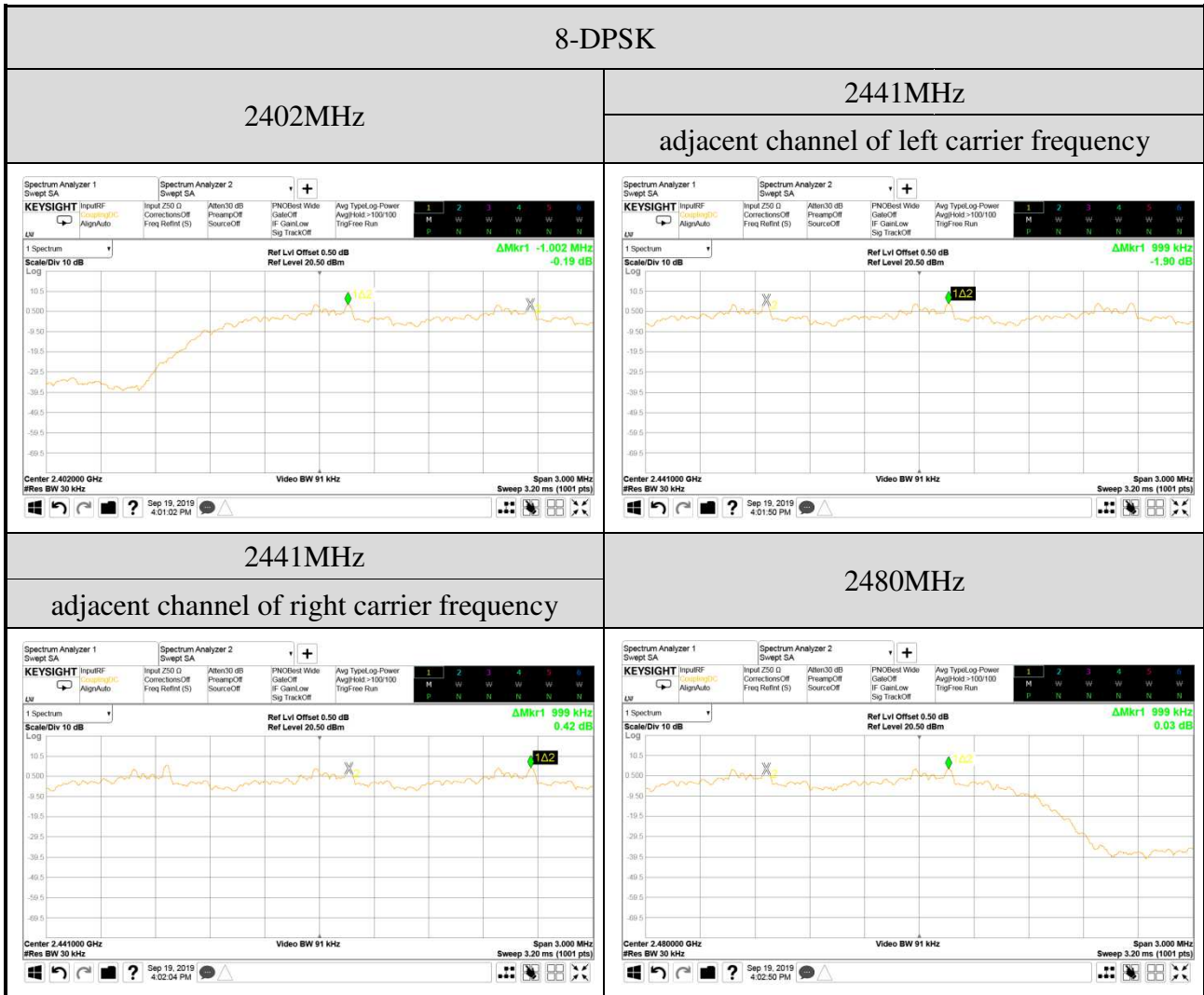

A.5 TIME OF OCCUPANCY

Test Date	2019/09/19	Temp./Hum.	25°C /54%
Cable Loss	0.50dB	Tested By	Martin Chen
Test Voltage	AC 120V 60Hz (Via AC Adapter)		

A.5.1 Time of Occupancy

Mode	Centre Frequency (MHz)	Mode	Each second appearance transmission	Time of Occupancy (ms)	Maximum accumulated Time of Occupancy (ms)	Limit (ms)
GFSK	2402	DH1	10	0.380	120.080	<400
		DH3	5	1.635	258.330	<400
		DH5	3	2.880	273.024	<400

Observation Period:

$$79 \text{ channels} * 0.4 \text{ seconds} = 31.6 \text{ seconds}$$

DH1 Mode

For each second of 10 transmission appearance, the longest time of occupancy is
 $10 \text{ transmission} * 31.6 \text{ seconds} * 0.380 \text{ ms} = 120.080 \text{ ms} (<400\text{ms})$

DH3 Mode

For each second of 5 transmission appearance, the longest time of occupancy is
 $5 \text{ transmission} * 31.6 \text{ seconds} * 1.635 \text{ ms} = 258.330 \text{ ms} (<400\text{ms})$

DH5 Mode

For each second of 3 transmission appearance, the longest time of occupancy is
 $3 \text{ transmission} * 31.6 \text{ seconds} * 2.880 \text{ ms} = 273.024 \text{ ms} (<400\text{ms})$

Mode	Centre Frequency (MHz)	Mode	Each second appearance transmission	Time of Occupancy (ms)	Maximum accumulated Time of Occupancy (ms)	Limit (ms)
GFSK	2440	DH1	10	0.380	120.080	<400
		DH3	5	1.635	258.330	<400
		DH5	3	2.880	273.024	<400

Observation Period:

$$79 \text{ channels} * 0.4 \text{ seconds} = 31.6 \text{ seconds}$$

DH1 Mode

For each second of 10 transmission appearance, the longest time of occupancy is
 $10 \text{ transmission} * 31.6 \text{ seconds} * 0.380 \text{ ms} = 120.080 \text{ ms} (<400\text{ms})$

DH3 Mode

For each second of 5 transmission appearance, the longest time of occupancy is
 $5 \text{ transmission} * 31.6 \text{ seconds} * 1.635 \text{ ms} = 258.330 \text{ ms} (<400\text{ms})$

DH5 Mode

For each second of 3 transmission appearance, the longest time of occupancy is
 $3 \text{ transmission} * 31.6 \text{ seconds} * 2.880 \text{ ms} = 273.024 \text{ ms} (<400\text{ms})$

Mode	Centre Frequency (MHz)	Mode	Each second appearance transmission	Time of Occupancy (ms)	Maximum accumulated Time of Occupancy (ms)	Limit (ms)
GFSK	2480	DH1	10	0.380	120.080	<400
		DH3	5	1.635	258.330	<400
		DH5	3	2.880	273.024	<400

Observation Period:

79 channels * **0.4** seconds = **31.6** seconds

DH1 Mode

For each second of **10** transmission appearance, the longest time of occupancy is
10 transmission * **31.6** seconds * **0.380** ms = **120.080** ms (<400ms)

DH3 Mode

For each second of **5** transmission appearance, the longest time of occupancy is
5 transmission * **31.6** seconds * **1.635** ms = **258.330** ms (<400ms)

DH5 Mode

For each second of **3** transmission appearance, the longest time of occupancy is
3 transmission * **31.6** seconds * **2.880** ms = **273.024** ms (<400ms)

● Measurement Plots

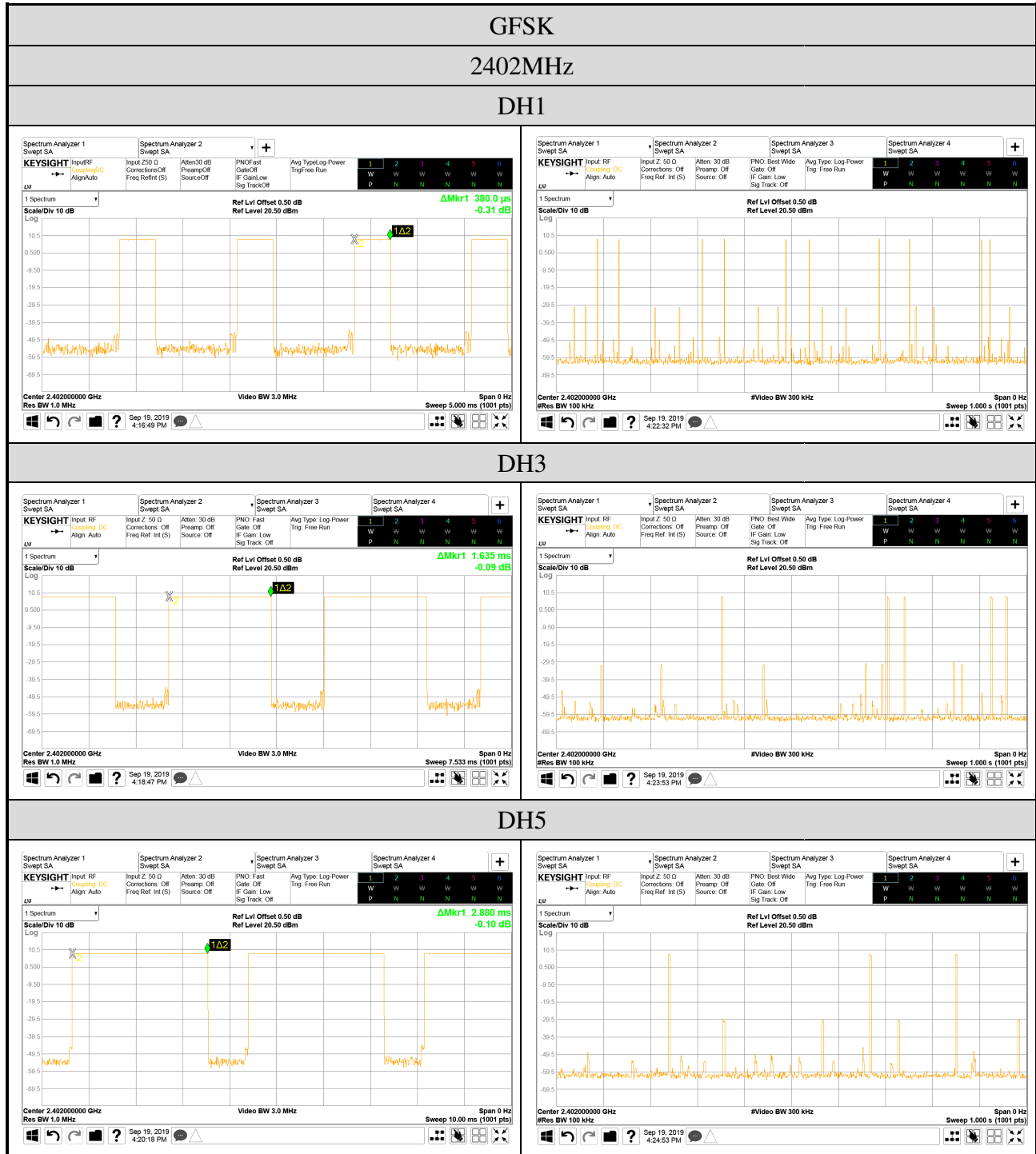

GFSK 2441MHz

DH1

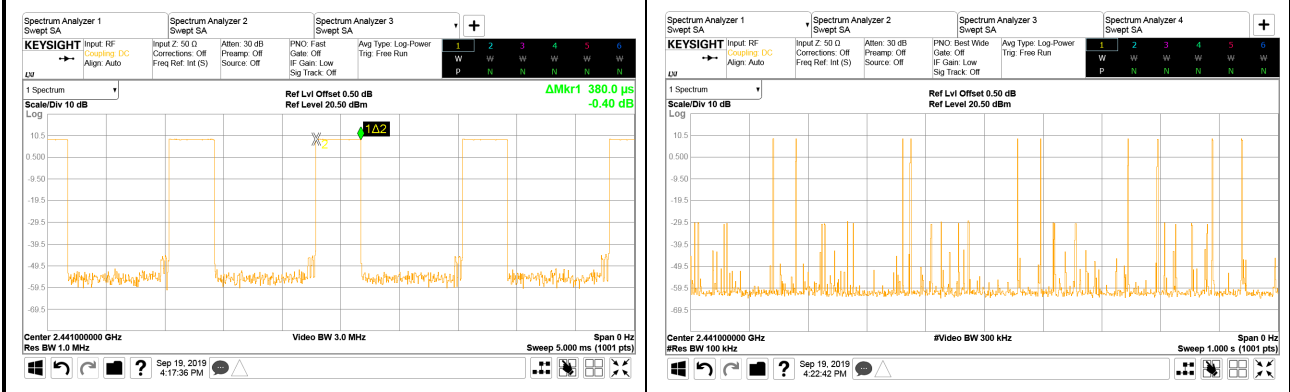

DH3

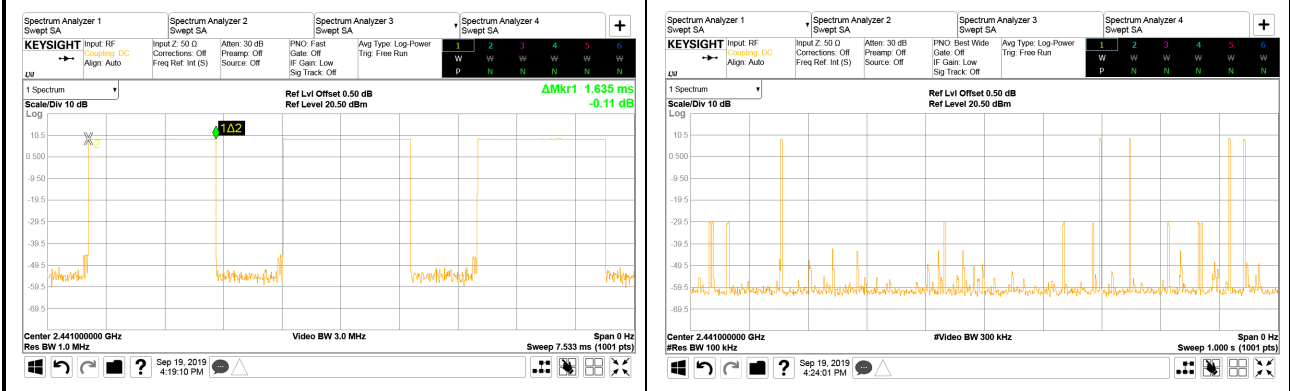

DH5

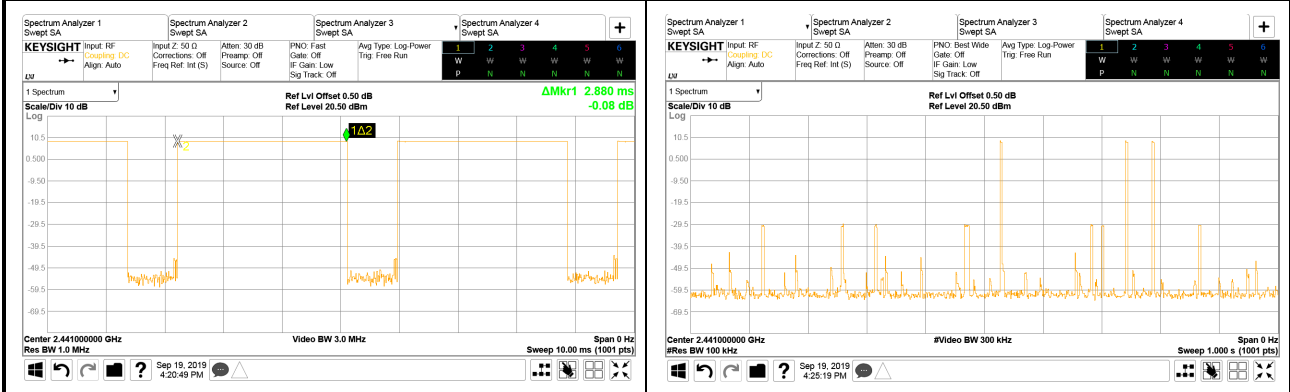

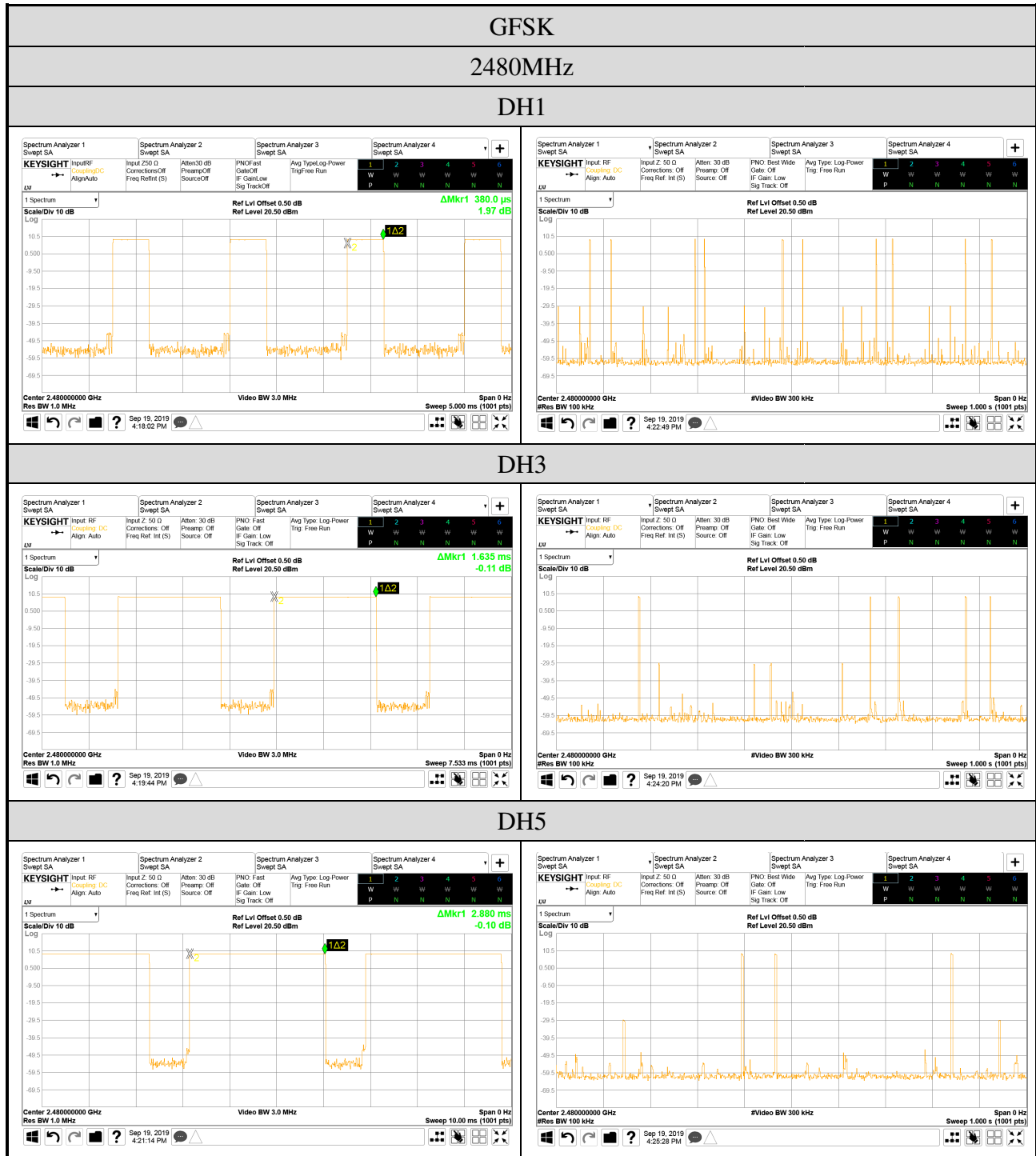

Mode	Centre Frequency (MHz)	Mode	Each second appearance transmission	Time of Occupancy (ms)	Maximum accumulated Time of Occupancy (ms)	Limit (ms)
8-DPSK	2402	3DH1	10	0.390	123.240	<400
		3DH3	5	1.635	258.330	<400
		3DH5	3	2.890	273.972	<400

Observation Period:

$79 \text{ channels} * 0.4 \text{ seconds} = 31.6 \text{ seconds}$

3DH1 Mode

For each second of **10** transmission appearance,the longest time of occupancy is
10 transmission* **31.6** seconds* **0.390** ms= **123.240** ms (<400ms)

3DH3 Mode

For each second of **5** transmission appearance,the longest time of occupancy is
5 transmission* **31.6** seconds* **1.635** ms= **258.330** ms (<400ms)

3DH5 Mode

For each second of **3** transmission appearance,the longest time of occupancy is
3 transmission* **31.6** seconds* **2.890** ms= **273.972** ms (<400ms)

Mode	Centre Frequency (MHz)	Mode	Each second appearance transmission	Time of Occupancy (ms)	Maximum accumulated Time of Occupancy (ms)	Limit (ms)
8-DPSK	2441	3DH1	10	0.390	123.240	<400
		3DH3	5	1.635	258.330	<400
		3DH5	3	2.890	273.972	<400

Observation Period:

$79 \text{ channels} * 0.4 \text{ seconds} = 31.6 \text{ seconds}$

3DH1 Mode

For each second of **10** transmission appearance,the longest time of occupancy is
10 transmission* **31.6** seconds* **0.390** ms= **123.240** ms (<400ms)

3DH3 Mode

For each second of **5** transmission appearance,the longest time of occupancy is
5 transmission* **31.6** seconds* **1.635** ms= **258.330** ms (<400ms)

3DH5 Mode

For each second of **3** transmission appearance,the longest time of occupancy is
3 transmission* **31.6** seconds* **2.890** ms= **273.972** ms (<400ms)

Mode	Centre Frequency (MHz)	Mode	Each second appearance transmission	Time of Occupancy (ms)	Maximum accumulated Time of Occupancy (ms)	Limit (ms)
8-DPSK	2480	3DH1	10	0.390	123.240	<400
		3DH3	5	1.635	258.330	<400
		3DH5	3	2.890	273.972	<400

Observation Period:

$$79 \text{ channels} * 0.4 \text{ seconds} = 31.6 \text{ seconds}$$

3DH1 Mode

For each second of **10** transmission appearance, the longest time of occupancy is
10 transmission * **31.6** seconds * **0.390** ms = **123.240** ms (<400ms)

3DH3 Mode

For each second of **5** transmission appearance, the longest time of occupancy is
5 transmission * **31.6** seconds * **1.635** ms = **258.330** ms (<400ms)

3DH5 Mode

For each second of **3** transmission appearance, the longest time of occupancy is
3 transmission * **31.6** seconds * **2.890** ms = **273.972** ms (<400ms)

● Measurement Plots



8-DPSK

2441MHz

3DH1

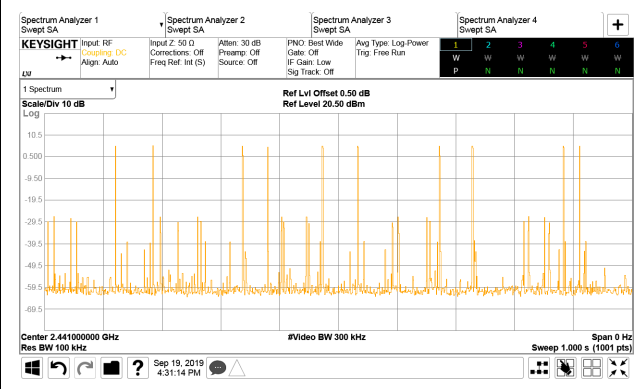
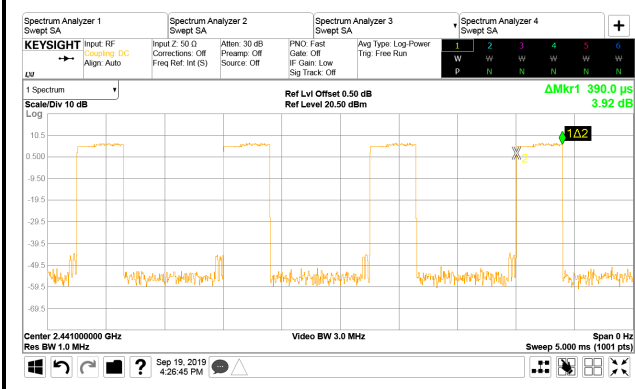

3DH3

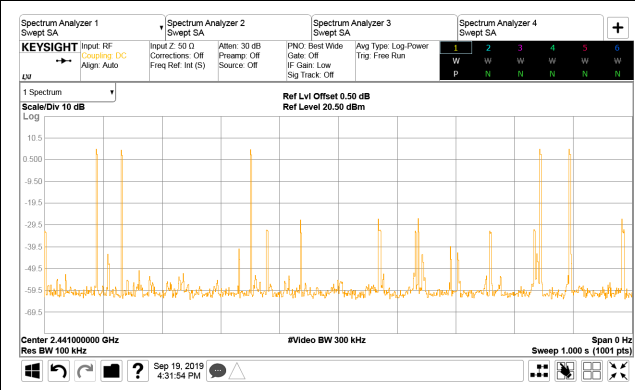
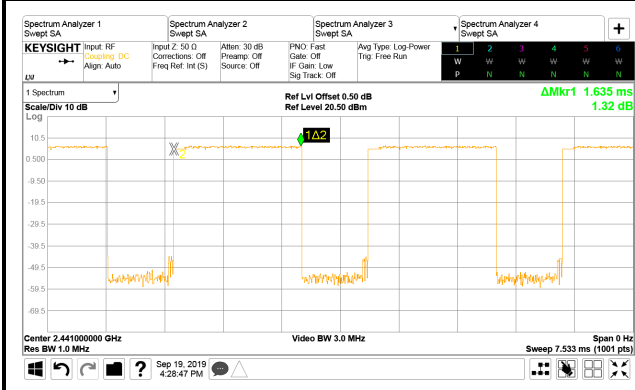

3DH5

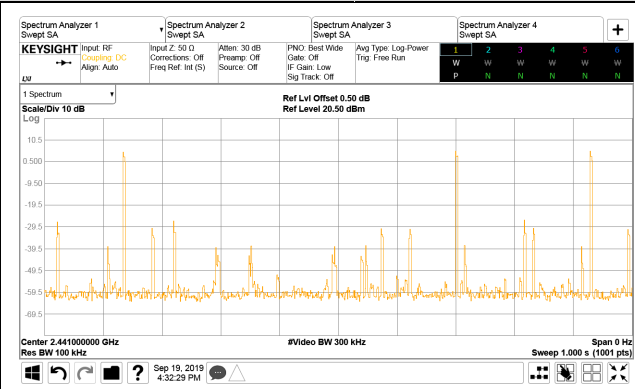
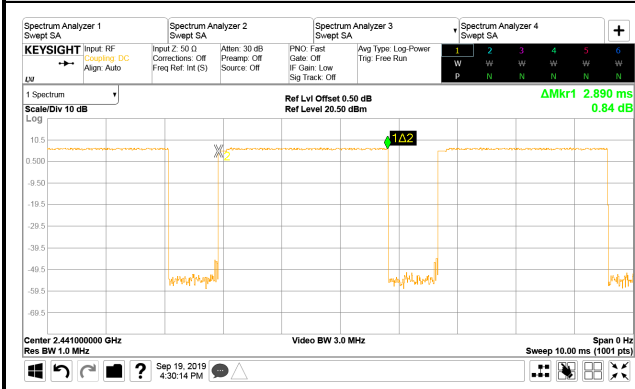

8-DPSK

2480MHz

3DH1

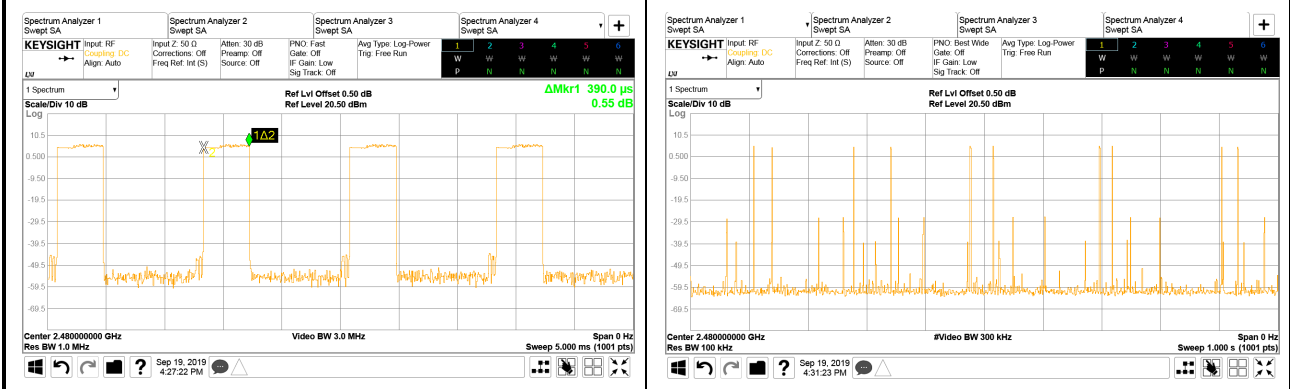

3DH3



3DH5

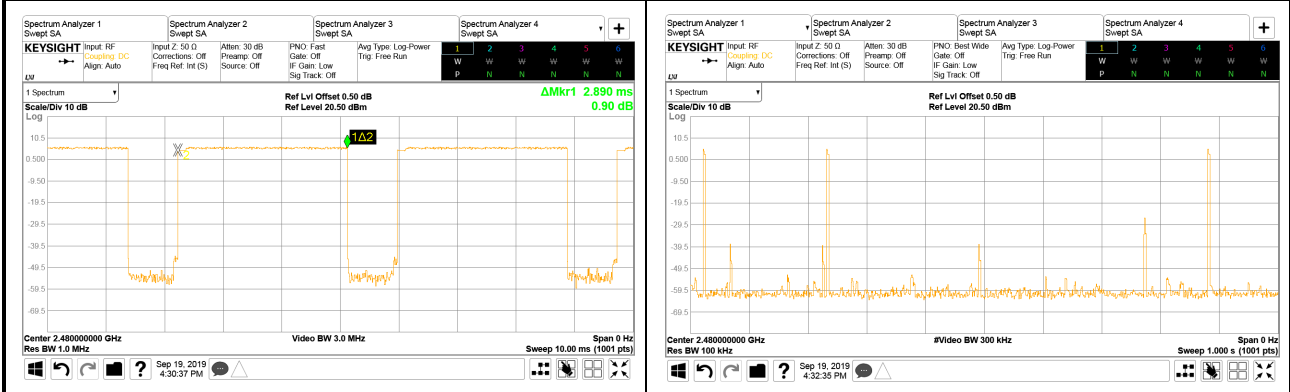

A.6 NUMBER OF HOPPING CHANNELS

Test Date	2019/09/19	Temp./Hum.	25°C/54%
Cable Loss	0.50dB	Tested By	Martin Chen
Test Voltage	AC 120V 60Hz (Via AC Adapter)		

Mode: GFSK	Mode: 8-DPSK
The number hopping channel is 79.	The number hopping channel is 79.

A.7 MAXIMUM PEAK OUTPUT POWER

Test Date	2019/09/18, 2021/02/17 ~ 20	Temp./Hum.	25°C/51%, 18 ~ 19°C/56 ~ 57%
Cable Loss	0.50dB	Tested By	Sean Wang/Kuper Hsu
Test Voltage	AC 120V 60Hz (Via AC Adapter)		

A.7.1 Maximum Peak Output Power

Mode	Centre Frequency (MHz)	Maximum Peak Output Power		Limit
		dBm	W	
GFSK	2402	9.14	0.008	21dBm (0.125W)
	2441	9.59	0.009	
	2480	9.48	0.009	
8-DPSK	2402	6.89	0.005	
	2441	7.55	0.006	
	2480	7.00	0.005	

SPOT CHECK

Mode	Centre Frequency (MHz)	Maximum Peak Output Power		Limit
		dBm	W	
GFSK	2402	9.05	0.008	21dBm (0.125W)
	2441	9.41	0.009	
	2480	9.30	0.009	
8-DPSK	2402	6.81	0.005	
	2441	7.41	0.006	
	2480	6.95	0.005	

A.7.2 Measurement Plots

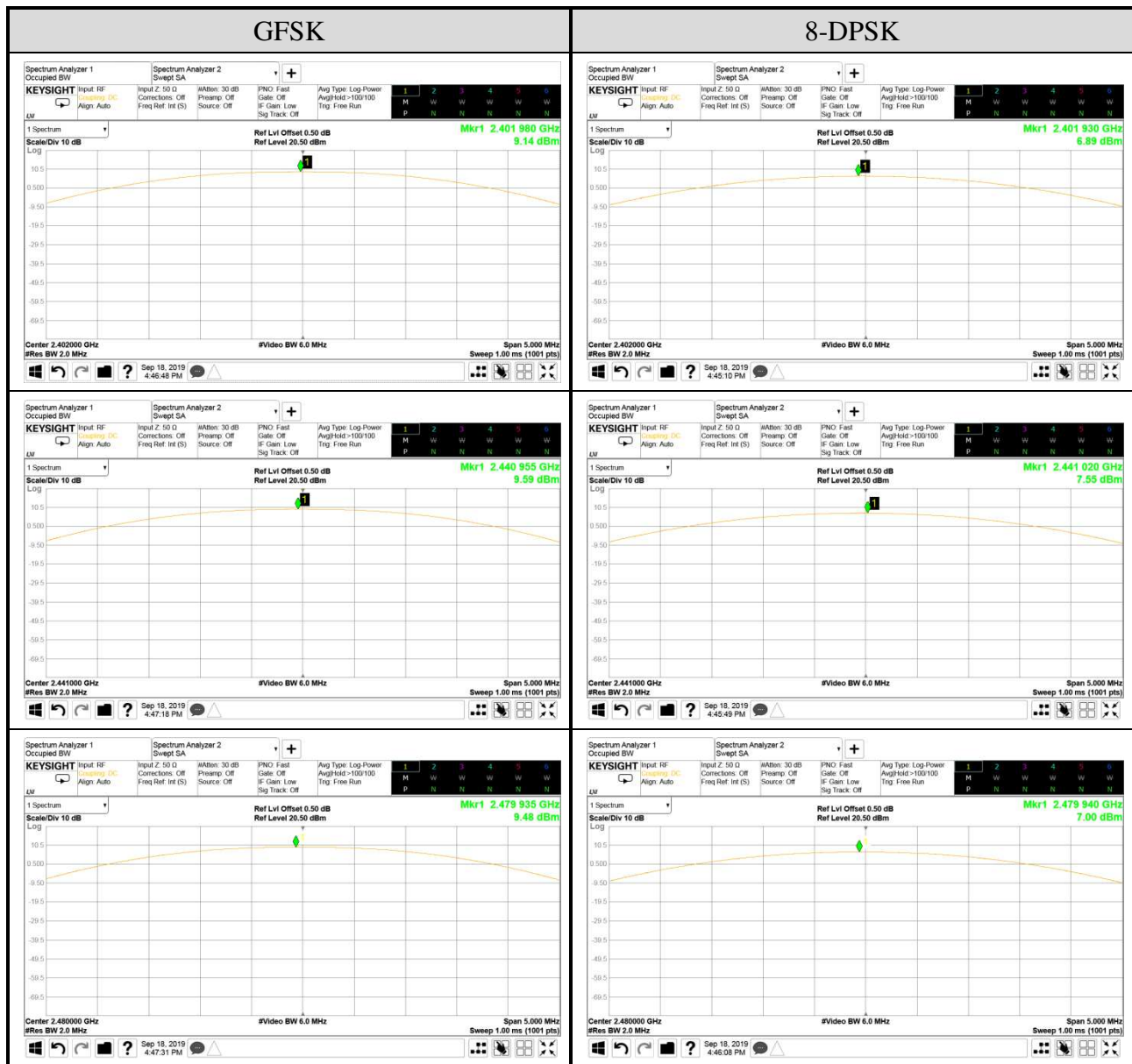

A.8 EMISSION LIMITATIONS MEASUREMENT

Test Date	2019/09/18 ~ 19	Temp./Hum.	25°C/51 ~ 54%
Cable Loss	0.50dB	Tested By	Martin Chen
Test Voltage	AC 120V 60Hz (Via AC Adapter)		

A.8.1 Band Edge



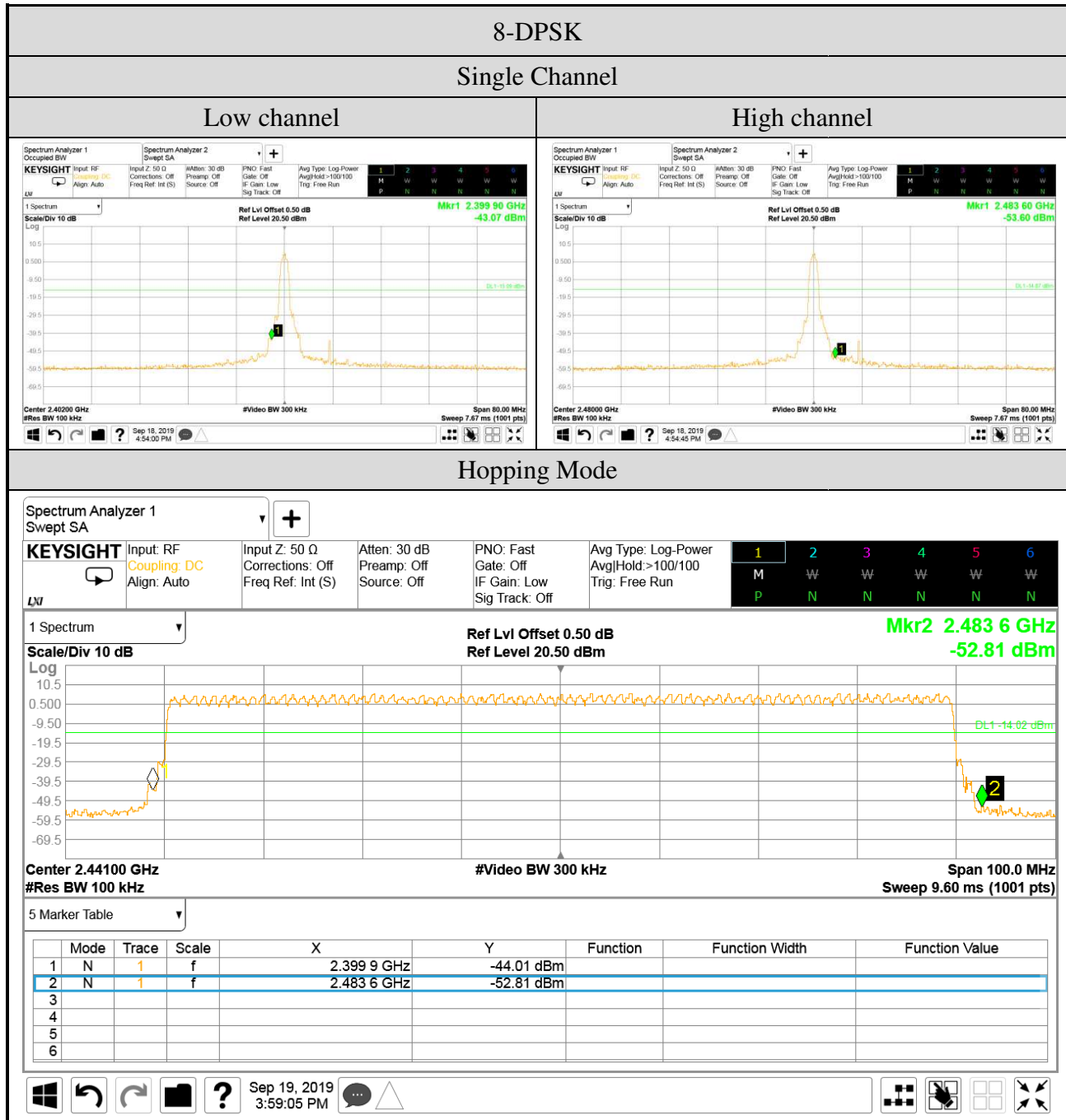

A.8.2 Spurious Emission



Note: All results have been included cable loss.

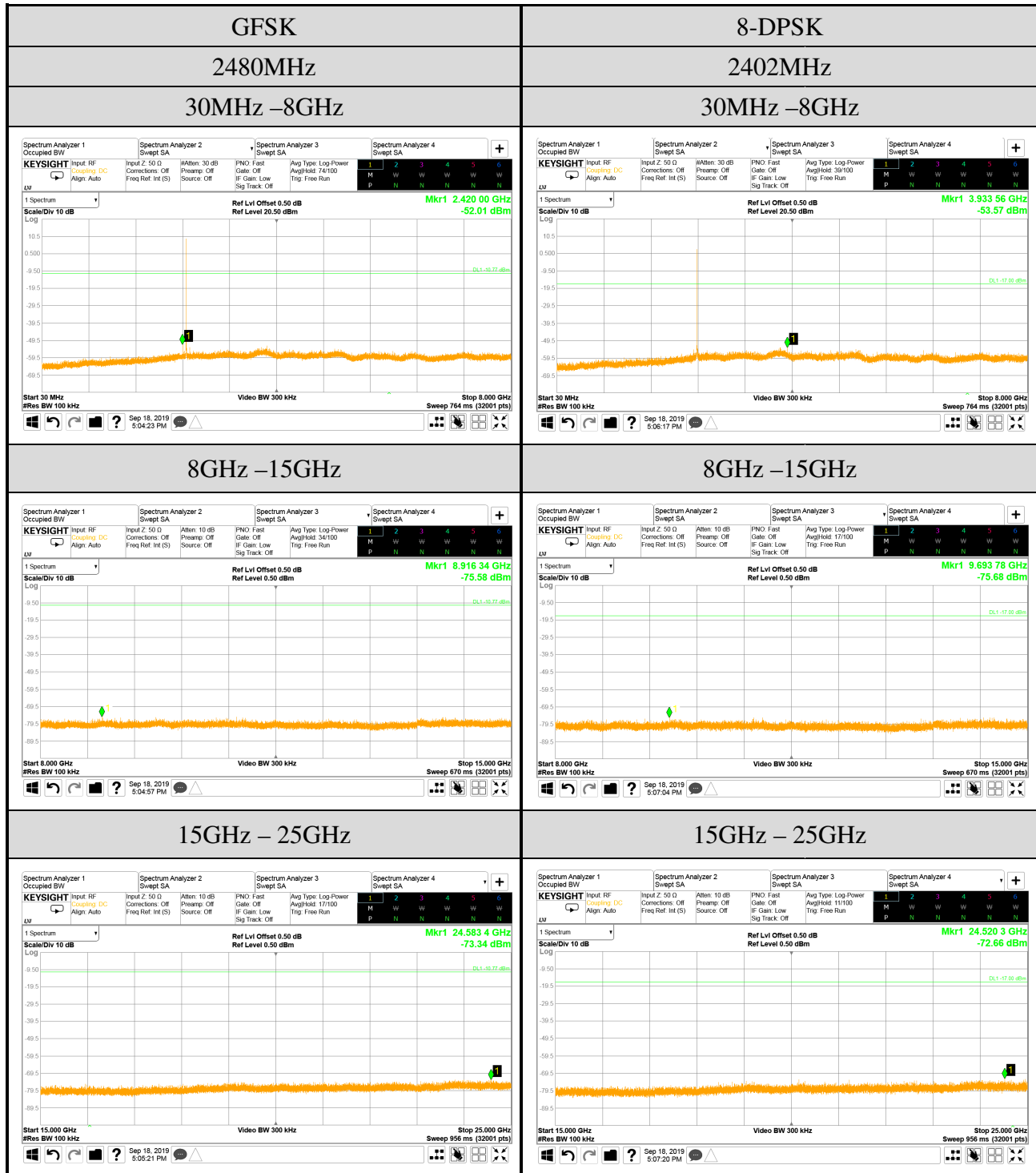

Note: All results have been included cable loss.



Audix Technology Corp.
No. 491, Zhongfu Rd., Linkou Dist.,
New Taipei City 244, Taiwan

Tel: +886 2 26099301
Fax: +886 2 26099303

APPDNDIX B

TEST PHOTOGRAPHS

(Model: 15Z90P)