

FCC 15.247 & RSS-247 2.4GHz Test Report

for

LG Electronics Inc.

**222, LG-ro Jinwi-myeon, Pyeongtaek-Si, Gyeonggi-Do,
451-713, Korea**

Product Name : Notebook Computer
Model Name : (1)15Z90P (2)15ZB90P
(3)15ZD90P (4)15ZG90P
(5)15ZC90P
Brand : LG
FCC ID : BEJNT-15Z90P
IC : 2703H-15Z90P

Prepared by: : AUDIX Technology Corporation,
EMC Department



The test report is based on a single evaluation of one sample of the above-mentioned products. It does not imply an assessment of the whole production and does not permit the use of the test lab logo.

TABLE OF CONTENTS

Description	Page
TEST REPORT	4
1. REVISION RECORD OF TEST REPORT	5
2. SUMMARY OF TEST RESULTS	6
3. GENERAL INFORMATION	7
3.1. Description of Application	7
3.2. Description of EUT	8
3.3. Antenna Information	9
3.4. EUT Specifications Assessed in Current Report	10
3.5. Descriptions of Key Components	12
3.6. Test Configuration	15
3.7. Output Power Setting	21
3.8. Tested Supporting System List	22
3.9. Setup Configuration	23
3.10. Operating Condition of EUT	23
3.11. Description of Test Facility	24
3.12. Measurement Uncertainty	25
4. MEASUREMENT EQUIPMENT LIST	26
4.1. Conducted Emission Measurement	26
4.2. Radiated Emission Measurement	27
4.3. RF Conducted Measurement	28
5. CONDUCTED EMISSION	29
5.1. Block Diagram of Test Setup	29
5.2. Conducted Emission Limit	29
5.3. Test Procedure	29
5.4. Test Results	29
6. RADIATED EMISSION	30
6.1. Block Diagram of Test Setup	30
6.2. Radiated Emission Limits	32
6.3. Test Procedure	33
6.4. Measurement Result Explanation	34
6.5. Test Results	34
7. 6dB/OCCUPIED BANDWIDTH	35
7.1. Block Diagram of Test Setup	35
7.2. Specification Limits	35
7.3. Test Procedure	35
7.4. Test Results	35
8. MAXIMUM PEAK OUTPUT POWER	36
8.1. Block Diagram of Test Setup	36
8.2. Specification Limits	36
8.3. Test Procedure	37
8.4. Test Results	37
9. EMISSION LIMITATIONS	38
9.1. Block Diagram of Test Setup	38



Audix Technology Corp.
No. 491, Zhongfu Rd., Linkou Dist.,
New Taipei City 244, Taiwan

Tel: +886 2 26099301
Fax: +886 2 26099303

9.2. Specification Limits.....	38
9.3. Test Procedure.....	38
9.4. Test Results	39
10. POWER SPECTRAL DENSITY	40
10.1. Block Diagram of Test Setup	40
10.2. Specification Limits.....	40
10.3. Test Procedure	40
10.4. Test Results	40
11. DEVIATION TO TEST SPECIFICATIONS	41

APPENDIX A TEST DATA AND PLOTS
APPENDIX B TESTPHOTOGRAPHS

TEST REPORT

Applicant : LG Electronics Inc.
Manufacturer : LG Electronics Inc.
Factory : LG Electronics Nanjing New Technology Co., Ltd.
EUT Description
(1) Product : Notebook Computer
(2) Model : (1)15Z90P (2)15ZB90P (3)15ZD90P (4)15ZG90P (5)15ZC90P
(3) Brand : LG
(4) Power Supply: DC 20V, 3.25A

Applicable Standards:

Title 47 CFR FCC Part 15 Subpart C
RSS-Gen (Issue 5), April 2018
RSS-247 (Issue 2), February 2017
ANSI C63.10:2013

Audix Technology Corp. tested the equipment mentioned in accordance with the requirements set forth in the above standards. Test results indicate that the equipment tested is capable of demonstrating compliance with the requirements as documented within this report.

Audix Technology Corp. does not assume responsibility for any conclusions and generalizations drawn from the test results with regard to other specimens and samples.

Date of Report: 2021. 03. 05

Reviewed by:



(Annie Yu/Administrator)

Approved by:



(Johnny Hsueh/Section Manager)

1. REVISION RECORD OF TEST REPORT

Edition No	Issued Data	Revision Summary	Report Number
0	2021. 03. 05	Original Report	EM-F210113

2. SUMMARY OF TEST RESULTS

Rule		Description	Data Reused	Results
FCC	IC			
15.207	RSS-Gen §8.8	Conducted Emission	No	PASS
15.247(d)/ 15.205	RSS-Gen §8.9 RSS-247 §5.5	Radiated Band Edge and Radiated Spurious Emission	No	PASS
15.247(a)(2)	RSS-247 §5.2(1)	6dB/Occupied Bandwidth	Yes	PASS
15.247(b)(3)	RSS-247 §5.4(4)	Maximum Peak Output Power	SPOT CHECK ^{Note 2}	PASS
15.247(d)	RSS-247 §5.5	Conducted Band Edges and Conducted Spurious Emission	Yes	PASS
15.247 (e)	RSS-247 §5.2(2)	Peak Power Spectral Density	Yes	PASS
15.203	---	Antenna Requirement	---	Compliance

Note: 1. The uncertainties value is not used in determining the result.
2. This device embedded with same radio transmitter with FCC ID: BEJNT-15Z90N grant on 11/29 2019 and IC: 2703H-15Z90N (Report No.: EM-F190339) approved on 12/04/2019. According to KDB 484596 D01, we did spot check for output power and all output power values keep identical thus we reuse all results except to E.I.R.P. test items.

3. GENERAL INFORMATION

3.1. Description of Application

Applicant	LG Electronics Inc. 222, LG-ro Jinwi-myeon, Pyeongtaek-Si, Gyeonggi-Do, 451-713, Korea
Manufacturer	LG Electronics Inc. 222, LG-ro Jinwi-myeon, Pyeongtaek-Si, Gyeonggi-Do, 451-713, Korea
Factory	LG Electronics Nanjing New Technology Co., Ltd. No.346, Yaoxin Road, Economic & Technical Development Zone, Nanjing, China.
Product	Notebook Computer
Model	(1)15Z90P (2)15ZB90P (3)15ZD90P (4)15ZG90P (5)15ZC90P The difference between all models is different in the sales customers.
Brand	LG

3.2. Description of EUT

Test Model	15Z90P		
Serial Number	N/A		
Power Rating	DC 20V, 3.25A		
RF Features	WLAN:802.11 a/b/g/n/ac/ax Bluetooth: BT and BLE (BT 5.0)		
Transmit Type	2.4 GHz		
	802.11b		1T1R
	802.11g		1T1R
	802.11n-HT20		2T2R
	802.11n-HT40		2T2R
	802.11ax-HE20		2T2R
	802.11ax-HE40		2T2R
	BT/BLE		1T1R
	U-NII Bands		
	802.11a		1T1R
	802.11n-HT20/802.11ac-VHT20/802.11ax-HE20		2T2R
	802.11n-HT40/802.11ac-VHT40/802.11ax-HE40		2T2R
	802.11ac-VHT80/802.11ax-HE80		2T2R
	802.11ac-VHT160/802.11ax-HE160		2T2R
	The MIMO is uncorrelated and supported SDM mode only.		
Test Sample	Sample No.	Test Item	Firmware
	03	AC Conduction, RSE, Output Power	N/A
	04	AC Conduction, Output Power	N/A
Sample Status	Mass production		
Date of Receipt	2021. 02. 09		
Date of Test	2021. 02. 10 ~ 03. 05		
Interface Ports of EUT	<ul style="list-style-type: none"> • One Micro SD Card Slot • One Earphone Port • Two USB 3.0 Ports • Two USB Type C Ports • One HDMI Port 		
Accessories Supplied	<ul style="list-style-type: none"> • AC Adapter • LAN Gender 		

3.3. Antenna Information

No.	Antenna Part Number	Manufacture	Antenna Type	Frequency (MHz)	Max Gain(dBi)
1.	WA-P-LELE-04-002 (Main)	INPAQ	Mono-Pole	2400~2500	5.0
				5100-5250	3.8
				5250-5350	3.8
				5350-5750	2.4
				5750~5850	2.7
	WA-P-LELE-04-002 (AUX)	INPAQ	Mono-Pole	2400~2500	5.7
				5100-5250	3.8
				5250-5350	3.8
				5350-5750	2.4
				5750~5850	2.7
2	L1LRF004-CS-H (Main)	LUXSHARE- ICT	Mono-Pole	2400~2500	1.8
				5150-5250	2.0
				5250-5350	2.2
				5350-5725	2.8
				5725~5850	2.2
	L1LRF004-CS-H (AUX)	LUXSHARE- ICT	Mono-Pole	2400~2500	1.6
				5150-5250	2.0
				5250-5350	2.0
				5350-5725	2.6
				5725~5850	2.7

3.4. EUT Specifications Assessed in Current Report

Mode	Fundamental Range (MHz)	Channel Number	Modulation	Data Rate (Mbps)
802.11b	2412-2472	13	DSSS (DBPSK/DQPSK/CCK)	Up to 11
802.11g		13	OFDM (BPSK/QPSK/16QAM/64QAM)	Up to 54
802.11n-HT20				Up to 144.4
802.11n-HT40	2422-2462	9	OFDM (BPSK/QPSK/16QAM/64QAM)	Up to 300
802.11ax-HE20	2412-2472	13	OFDMA (BPSK/ QPSK/ 16QAM/ 64QAM/ 256QAM/1024QAM)	Up to 287
802.11ax-HE40	2422-2462	9		Up to 574
BLE	2402-2480	40	GFSK (1M, 2M, PHY Coded S8, PHY Coded S2)	Up to 2

Channel List			
802.11 b/g/n-HT20/ax-HE20		802.11n-HT40/ax-HE40	
Channel Number	Frequency (MHz)	Channel Number	Frequency (MHz)
1	2412	3	2422
2	2417	4	2427
3	2422	5	2432
4	2427	6	2437
5	2432	7	2442
6	2437	8	2447
7	2442	9	2452
8	2447	10	2457
9	2452	11	2462
10	2457	---	
11	2462		
12	2467		
13	2472		

Channel List							
BLE							
Channel Number	Frequency (MHz)	Channel Number	Frequency (MHz)	Channel Number	Frequency (MHz)	Channel Number	Frequency (MHz)
37	2402	09	2422	18	2442	28	2462
00	2404	10	2424	19	2444	29	2464
01	2406	38	2426	20	2446	30	2466
02	2408	11	2428	21	2448	31	2468
03	2410	12	2430	22	2450	32	2470
04	2412	13	2432	23	2452	33	2472
05	2414	14	2434	24	2454	34	2474
06	2416	15	2436	25	2456	35	2476
07	2418	16	2438	26	2458	36	2478
08	2420	17	2440	27	2460	39	2480

3.5. Descriptions of Key Components

3.5.1. For the All Component Lists

Item	Supplier	Model / Type	Character
System	Microsoft	Win10 Home	---
		Win10 Pro	---
Main Board	LG	Blanc MAIN B/D PCB (with TPM IC)	Manufacturer: #1 HannstarBoardTech(Jiang Yin)Corp.,Ltd. #2 Elec&Eltek Company (MCO) Limited.
		Blanc MAIN B/D PCB (without TPM IC)	
WLAN SUB Board	LG	15/16Z90P SUB B/D	Manufacturer: #1 HannstarBoardTech(Jiang Yin)Corp.,Ltd. #2 Elec&Eltek Company (MCO) Limited. #3 JiangSu HuaShen Electronic co.,ltd (HXF)
Intel CPU (Socket: FCBGA1449)	Intel	i7-1165G7	2.80GHz
	Intel	i5-1135G7	2.4GHz
	Intel	i3-1115G4	3.00GHz
15.6" LCD Panel	LG Display	LP156WFD	Resolution: 1920 x 1080, 60Hz FHDIPS (Touch)
15.6" LCD Panel	LG Display	LP156WFC	Resolution: 1920 x 1080, 60Hz FHDIPS (Normal Non Touch)
Storage (SSD)	SK hynix	HFS256GD9TNG-L2A0A	256GB (M.2)
		HFS512GD9TNG-L2A0A	512GB (M.2)
		HFS001TD9TNG-L2A0A	1TB (M.2)
	Samsung	MZ-VLB256B	256GB (M.2)
		MZ-VLB512B	512GB (M.2)
		MZ-VLB1T0B	1TB(M.2)
Memory (RAM)	SK Hynix	---	32GB LPDDR4x(On Board)
	SK Hynix	---	16GB LPDDR4x(On Board)
	SK Hynix	---	8GB LPDDR4x(On Board)
	Samsung	---	16GB LPDDR4x(On Board)
	Samsung	---	8GB LPDDR4x(On Board)
Battery Pack	LG	LBV7227E	80Wh, DC7.74V, 80Wh Typ 10336mAh
WLAN Combo Card	Intel	AX201D2W	WLAN and BT, 2x2 CNVi 1216 FCC ID: PD9AX201NG IC: 1000M-AX201NG NCC ID: CCAH18LP3410T5
WLAN Combo Antenna	LG (INPAQ)	WA-P-LELE-04-002	PCB, Mono-pole Type Main: Black, Aux: Gray
	LG (LUXSHARE-ICT)	L1LRF004-CS-H	PCB, Mono-pole Type Main: Black, Aux: Gray

Item	Supplier	Model / Type	Character
Keyboard	TIC	KT0120B8	---
	LITE ON	SN8002	---
Web Camera	Chicony	CKFKH33-0	---
	Luxvisions	0BF108N3	---
LAN Gender (Type C to LAN)	SUZHOU MEC ELECTRONICS	80-5946-111	(White) 10/100Megabit Ethernet
		80-5946-101	(Black) 10/100 Megabit Ethernet
	Type C to LAN: Shielded, Undetached, 0.12m		
	ARIN TECH CO. LTD	GD-08MF-36-WH-LP10	(White) 10/100Megabit Ethernet
		GD-08MF-36-BK-LP11	(Black) 10/100 Megabit Ethernet
	Type C to LAN: Shielded, Undetached, 0.12m		
	SUZHOU MEC ELECTRONICS	80-5946-200	(White) 10/100/1000 Megabit Ethernet
		80-5946-210	(Black) 10/100/1000 Megabit Ethernet
Type C to LAN: Shielded, Undetached, 0.13m			
AC Adapter (65W)	LG (HONOR)	ADT-65DSU-D03-2	I/P: AC 100-240V, 1.6A, 50-60Hz O/P: DC 20V, 3.25A
	DC Power Cord: Non-Shielded, Undetached, 1.5m		
	AC Power Cord: Non-Shielded, Detached, 1.0m (2C) (For Other Countries)		
AC Power Cord: Non-Shielded, Detached, 1.55m (2C) (For US, Canada, Mexico)			

Remark: For more detailed features description, please refer to the manufacturer's specifications or the user manual.

3.5.2. The EUT collocates with following worst components, which are used to establish a basic configuration of system during test:

SKU (Mode)1 ~ 2		1	2
Main Board	LG, Blanc MAIN B/D PCB (with TPM IC)		V
	LG, Blanc MAIN B/D PCB (without TPM IC)	V	
WLAN SUB Board	LG, 15/16Z90P SUB B/D	V	V
CPU	Intel, i7-1165G7	V	
	Intel, i5-1135G7		V
15.6" LCD Panel	LG Display, LP156WFD (Touch)	V	
	LG Display, LP156WFC (Normal Non Touch)		V
Storage (SSD)	Samsun, 1TB *1	V	
	Samsung, 512GB *1		V
	SK Hynix, 1TB *1	V	
	SK Hynix, 512GB *1		V
Memory (RAM)	SAMSUNG, 16GB	V	V
Battery Pack	LG, LBV7227E	V	V
WLAN Combo Card	Intel, AX201D2W	V	V
WLAN Combo Antenna	LG (INPAQ), WA-P-LELE-04-002	V	
	LG (LUXSHARE-ICT), L1LRF004-CS-H		V
Keyboard	TIC, KT0120B8	V	V
Web Camera	Chicony, CKFKH33-0	V	V
Type C*2	Link to LAN Gender SUZHOU MEC ELECTRONICS, 80-5946-111 (White)	V	
	Link to Adapter ARIN TECH CO. LTD, GD-08MF-36-WH-LP10 (White)		V
	Link to Adapter LG (HONOR),ADT-65DSU-D03-2	V	V
HDMI	1920 x 1080, 60Hz ("H" Pattern)	V	V

3.6. Test Configuration

Mode	TX _{on} (ms)	1/ TX _{on} (kHz)	Duty Cycle (x)	Duty Cycle Factor [10log(1/x)] (dB)
802.11b	8.360	0.120	0.995	N/A
802.11g	2.087	0.479	0.979	0.09
802.11n-HT20	3.980	0.251	0.990	N/A
802.11n-HT40	3.980	0.251	0.988	N/A
802.11ax-HE20	3.960	0.253	0.988	N/A
802.11ax-HE40	3.960	0.253	0.988	N/A

Note: When duty cycle is less than 98% (0.98) that duty cycle factor 10log(1/x) is needed to add in conducted test items measured in average detector.



Mode	TX _{on} (ms)	T _{on} +T _{off} (ms)
802.11n-HT40		
802.11ax-HE20		
802.11ax-HE40		

Mode	TX _{on} (ms)	1/ TX _{on} (kHz)	Duty Cycle (x)	Duty Cycle Factor [10log(1/x)] (dB)
BLE (1Mbps)	0.210	4.762	0.335	4.75
BLE (2Mbps)	0.207	4.831	0.333	4.78
BLE (PHY Coded S2)	3.100	0.323	0.829	0.81
BLE (PHY Coded S8)	1.070	0.935	0.572	2.43

Note: When duty cycle is less than 98% (0.98) that duty cycle factor 10log(1/x) is needed to add in conducted test items measured in average detector.

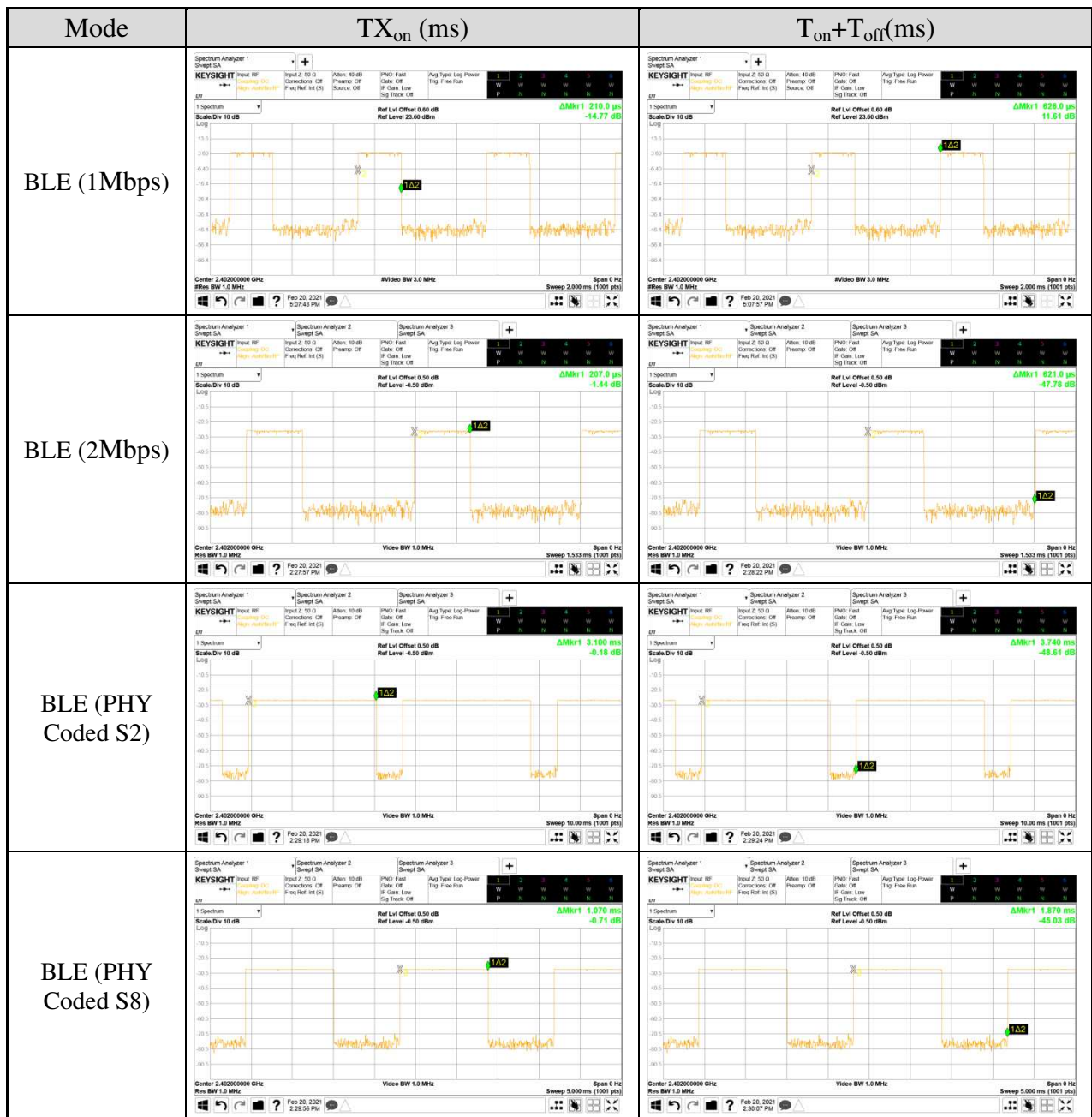

AC Conduction	
SKU #1	Normal operation (with INPAQ Antenna)
SKU #2	Normal operation (with LUXSHARE-ICT Antenna)

Item		Mode	Data Rate	Test Channel	
Radiated Test Case	SKU #1	Radiated Band Edge ^{Note 1 & 3}	802.11b	1Mbps	1/2/10/11/12/13
			802.11g	6Mbps	1/2/10/11/12/13
			802.11n-HT20	MCS8	1/2/10/11/12/13
			802.11n-HT40	MCS8	3/4/8/9/10/11
			802.11ax-HE20	HE0	1/2/10/11/12/13
			802.11ax-HE40	HE0	3/4/8/9/10/11
			BLE	PHY Coded S2	37/39
			2Mbps	37/39	
		Radiated Spurious Emission ^{Note 1 & 2 & 3}	802.11b	1Mbps	7
			802.11g	6Mbps	7
			802.11n-HT20	MCS8	7
			802.11n-HT40	MCS8	7
			802.11ax-HE20	HE0	7
			802.11ax-HE40	HE0	7
BLE	PHY Coded S2		37/17/39		

Item		Mode	RU Config	Test Channel	
Radiated Test Case	SKU #1	Radiated Band Edge ^{Note 1 & 3}	802.11ax-HE20	26/0	1
				52/37	
				106/53	
				26/8	13
				52/40	
				106/54	
			802.11ax-HE40	242/61	3
				242/62	11

Item		Mode	Data Rate	Test Channel
Conducted Test Case	6dB/Occupied Bandwidth (Data Reused)	802.11b	1Mbps	1/7/11/13
		802.11g	6Mbps	1/7/11/13
		802.11n-HT20	MCS8	1/7/11/13
		802.11n-HT40	MCS8	3/7/9/11
		802.11ax-HE20	HE0	1/7/11/13
		802.11ax-HE40	HE0	3/7/9/11
		BLE	1Mbps	37/17/39
	Peak Output Power (SPOT Check)	802.11b	1Mbps	1/2/7/10/11/12/13
		802.11g	6Mbps	1/2/7/10/11/12/13
		802.11n-HT20	MCS8	1/2/7/10/11/12/13
		802.11n-HT40	MCS8	3/4/7/8/9/10/11
		802.11ax-HE20	HE0	1/2/7/10/11/12/13
		802.11ax-HE40	HE0	3/4/7/8/9/10/11
		BLE	1Mbps	37/17/39
			2Mbps	37/17/39
			PHY Coded S2	37/17/39
	PHY Coded S8		37/17/39	
	Band Edge (Data Reused)	802.11b	1Mbps	1/11/13
		802.11g	6Mbps	1/11/13
		802.11n-HT20	MCS8	1/11/13
		802.11n-HT40	MCS8	3/9/11
		802.11ax-HE20	HE0	1/11/13
		802.11ax-HE40	HE0	3/9/11
		BLE	1Mbps	37/39
	Spurious Emission (Data Reused)	802.11b	1Mbps	1/7/11/13
		802.11g	6Mbps	1/7/11/13
		802.11n-HT20	MCS8	1/7/11/13
		802.11n-HT40	MCS8	3/7/9/11
		802.11ax-HE20	HE0	1/7/11/13
		802.11ax-HE40	HE0	3/7/9/11
BLE		1Mbps	37/17/39	
Peak Power Spectral Density (Data Reused)	802.11b	1Mbps	1/7/11/13	
	802.11g	6Mbps	1/7/11/13	
	802.11n-HT20	MCS8	1/7/11/13	
	802.11n-HT40	MCS8	3/7/9/11	
	802.11ax-HE20	HE0	1/7/11/13	
	802.11ax-HE40	HE0	3/7/9/11	
	BLE	1Mbps	37/17/39	

Item		Mode	Data Rate	RU Configuration	Test Channel
Conducted Test Case	6dB/Occupied Bandwidth (Data Reused)	802.11ax-HE20	HE0	26/0	1
				52/37	
				106/53	
		802.11ax-HE40	HE0	26/8	13
				52/40	
				106/54	
	Peak Output Power (SPOT Check)	802.11ax-HE20	HE0	26/0	1
				52/37	
				106/53	
		802.11ax-HE40	HE0	26/8	13
				52/40	
				106/5	
	Peak Power Spectral Density (Data Reused)	802.11ax-HE20	HE0	26/0	1
				52/37	
				106/53	
		802.11ax-HE40	HE0	26/8	13
				52/40	
				106/54	
802.11ax-HE40	HE0	242/61	3		
	HE0	242/62	11		

Note 1: Mobile Device
 Portable Device, and 3 axis were assessed. The worst scenario for Radiated Spurious Emission as follow: Lie Side Stand

Note 2: Low, mid, and high channels were measured, only the worst channel of each modulation was presented in this report.

Note 3: Both of the antennas are the same type, and we presented the worst case in the report. The max-gain condition with SISO (main port) and MIMO is SKU 1. The MIMO is uncorrelated and supported SDM mode only.

Note 4: The modulation and bandwidth are similar for 802.11n mode for HT20/HT40 and 802.11ac mode for VHT20/VHT40, therefore investigated worst case to representative mode in the test report.

Note 5: The data rates were selected based on preliminary testing that identified rate as the worst case for output power.

3.7. Output Power Setting

SPOT CHECK

Mode	Centre Frequency (MHz)	Power Setting		Mode	Centre Frequency (MHz)	Power Setting	
		Chain 0 (AUX)	Chain 1 (Main)			Chain 0 (AUX)	Chain 1 (Main)
802.11b	2412	19.125	19.125	802.11g	2412	16.75	16.75
	2417	19.875	19.875		2417	19.875	19.875
	2442	20	20		2442	19.625	19.625
	2457	19.875	19.875		2457	18	18
	2462	19	19		2462	17.375	17.375
	2467	18	18		2467	14.75	14.75
	2472	12.875	12.875		2472	1.375	1.375

Mode	Centre Frequency (MHz)	Power Setting	Mode	Centre Frequency (MHz)	Power Setting
802.11n-HT20	2412	14.125	802.11n-HT40	2422	13.675
	2417	15.375		2427	12.675
	2442	17.000		2442	14.500
	2457	15.500		2447	14.675
	2462	14.750		2452	13.125
	2467	11.750		2457	9.375
	2472	-0.250		2462	1.250

Mode	Centre Frequency (MHz)	Power Setting	Mode	Centre Frequency (MHz)	Power Setting
802.11ax-HE20	2412	14.000	802.11ax-HE40	2422	13.625
	2417	15.250		2427	12.375
	2442	17.000		2442	14.250
	2457	15.500		2447	14.500
	2462	14.500		2452	12.875
	2467	11.750		2457	9.000
	2472	-0.250		2462	1.000

Mode	RU Configuration	Centre Frequency (MHz)	Power Setting
802.11ax-HE20	26/0	2412	11.625
	52/37		11.750
	106/53		11.750
	26/0	2472	-1.375
	52/37		-1.125
	106/53		-1.125
802.11ax-HE40	242/61	2422	13.875
	242/62	2467	1.250

Mode	Centre Frequency (MHz)	Power Setting			
		1M	2M	PHY Coded S2	PHY Coded S8
BLE	2402	4	4	4	4
	2440	4	4	4	4
	2480	4	4	4	4

3.8. Tested Supporting System List

3.8.1. Support Peripheral Unit

No.	Product	Brand	Model No.	Serial No.	Approval
1.	TV	LG	22LK330-DB	N/A	N/A
2.	USB Mouse	Lenovo	45J4886	N/A	FCC By DoC
3.	Earphone	APPLE	N/A	N/A	N/A
4.	SD Card	ADATA	MicroSDHC Card	N/A	N/A
Partner System					
5.	AP Server	ASUS	RT-AX88U	N/A	FCC ID: MSQ-RTAXHP00 IC: 3568A-RTAXHP00

3.8.2. Cable Lists

No.	Cable Description Of The Above Support Units
1.	HDMI Cable: Shielded, Detachable, 1.8m AC Power Cord: Unshielded, Detachable, 1.8m
2.	USB Cable: Unshielded, Undetachable, 1.8m
3.	Earphone Cable: Unshielded, Undetachable, 0.9m
4.	N/A
5.	AC adapter: M/N:WA-30B12, Cable: Unshielded, Detachable, 1.2m LAN cable: Unshielded, Detachable, 3.0m
6.	LAN cable: Unshielded, Detachable, 1.8m

3.9. Setup Configuration

3.9.1. EUT Configuration for Power Line & Radiated Emission

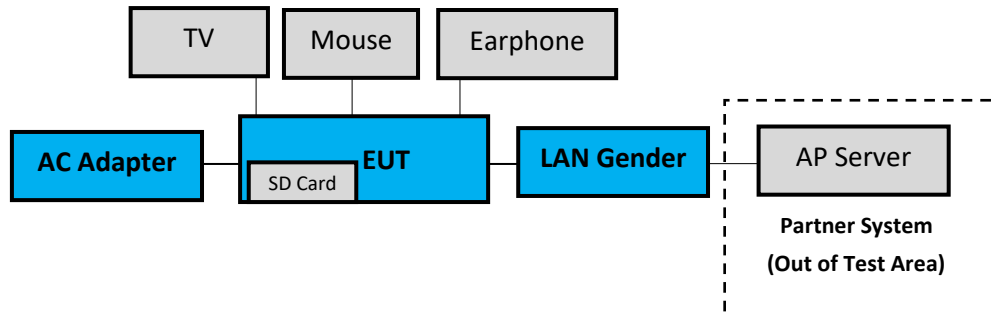

3.9.2. EUT Configuration for RF Conducted Test Items



3.10. Operating Condition of EUT

Test program “DRTU” is used for enabling EUT BT or WLAN function under continues transmitting and choosing data rate/ channel.

[Chain 0 is aux port (A Button in DRTU) Chain 1 is main port (B Button in DRTU)].

3.11. Description of Test Facility

Name of Test Firm	Audix Technology Corporation / EMC Department No. 491, Zhongfu Rd., Linkou Dist., New Taipei City 244, Taiwan Tel: +886-2-26092133 Fax: +886-2-26099303 Website : www.audixtech.com Contact e-mail: attemc_report@audixtech.com
Accreditations	The laboratory is accredited by following organizations under ISO/IEC 17025:2017 (1) NVLAP(USA) NVLAP Lab Code 200077-0 (2) TAF(Taiwan) No. 1724
Test Facilities	FCC OET Designation Number under APEC MRA by NCC is : TW1724 ISED CAB Identifier Number under APEC TEL MRA by NCC is TW1724 (1) No.8 Shielded Room (2) No.7 Shielded Room (3) No.1 3m Semi Anechoic Chamber (4) Fully Anechoic Chamber

3.12.Measurement Uncertainty

Test Items/Facilities		Frequency Range	Uncertainty	
Conduction Test		9kHz-150kHz	±3.7dB	
		150kHz-30MHz	±3.4dB	
Radiation Test	<input checked="" type="checkbox"/>	No.1 3m Semi Anechoic Chamber	30MHz-200MHz, 3m, Horizontal	±3.8dB
			200MHz-1000MHz, 3m, Horizontal	±4.1dB
			30MHz-200MHz, 3m, Vertical	±4.5dB
			200MHz-1000MHz, 3m, Vertical	±4.5dB
			1GHz-6GHz, 3m	±4.7dB
			6GHz-18GHz, 3m	±4.1dB
	<input type="checkbox"/>	No.3 3m Semi Anechoic Chamber	30MHz-200MHz, 3m, Horizontal	±3.9dB
			200MHz-1000MHz, 3m, Horizontal	±4.2dB
			30MHz-200MHz, 3m, Vertical	±4.3dB
			200MHz-1000MHz, 3m, Vertical	±4.5dB
	<input type="checkbox"/>	No.4 3m Semi Anechoic Chamber	30MHz-200MHz, 3m, Horizontal	±4.1dB
			200MHz-1000MHz, 3m, Horizontal	±4.5dB
			30MHz-200MHz, 3m, Vertical	±4.4dB
			200MHz-1000MHz, 3m, Vertical	±4.8dB
			1GHz-6GHz, 3m	±5.0dB
			6GHz-18GHz, 3m	±4.7dB
	<input type="checkbox"/>	No.5 3m Semi Anechoic Chamber	30MHz-200MHz, 3m, Horizontal	±4.2dB
			200MHz-1000MHz, 3m, Horizontal	±4.3dB
			30MHz-200MHz, 3m, Vertical	±4.3dB
			200MHz-1000MHz, 3m, Vertical	±4.7dB
1GHz-6GHz, 3m			±4.8dB	
6GHz-18GHz, 3m			±4.5dB	
<input checked="" type="checkbox"/>	Fully Anechoic Chamber	30MHz~1000MHz	±4.6dB	
		1GHz~18GHz	±5.4dB	
		18GHz~40GHz	±3.52dB	
		40GHz~260GHz	±3.56dB	

Remark : Uncertainty = $ku_c(y)$

Test Item	Uncertainty
6dB Bandwidth	± 0.05kHz
Maximum peak output power	± 0.33dB
Power spectral density	± 0.13dB
Conducted Emission Limitations	± 0.13dB

4. MEASUREMENT EQUIPMENT LIST

4.1. Conducted Emission Measurement

Item	Type	Manufacturer	Model No.	Serial No.	Cal. Date	Cal. Interval
1.	Test Receiver	R&S	ESR3	101774	2021. 02. 02	1 Year
		R&S	ESCI	101276	2021. 03. 03	1 Year
2.	A.M.N.	R&S	ENV432	101567	2020. 04. 20	1 Year
		R&S	ESH2-Z5	100366	2020. 07. 10	1 Year
3.	L.I.S.N.	Kyoritsu	KNW-407	8-855-9	2020. 12. 10	1 Year
		Kyoritsu	KNW-407	8-1539-3	2021. 01. 10	1 Year
4.	Pulse Limiter	R&S	ESH3-Z2	100354	2021. 01. 04	1 Year
		R&S	ESH3-Z2	101495	2021. 01. 04	1 Year
5.	Digital Thermo-Hygro Meter	iMax	HTC-1	No.8 S/R	2020. 04. 17	1 Year
		iMax	HTC-1	No.7 S/R	2020. 04. 17	1 Year
6.	Coaxial Cable	Yeida	RG/58AU	CE-08	2020. 09. 19	1 Year
		Thermax/CD T	RG-142	CE-07	2020. 05. 18	1 Year
7.	Test Software	Audix	e3	V6.120619c	N.C.R.	N.C.R.
		Audix	e3	V6.120619c	N.C.R.	N.C.R.

4.2. Radiated Emission Measurement

Item	Type	Manufacturer	Model No.	Serial No.	Cal. Date	Cal. Interval
1.	Spectrum Analyzer	Agilent	N9010A-526	MY53400071	2020. 09. 16	1 Year
2.	Spectrum Analyzer	Keysight	N9010B-544	MY55460198	2020. 04. 29	1 Year
3.	Spectrum Analyzer	Agilent	N9030A-526	MY53310269	2021. 01. 14	1 Year
4.	Test Receiver	R&S	ESCS30	100338	2020. 06. 10	1 Year
5.	Amplifier	HP	8447D	2944A07178	2020. 04. 29	1 Year
6.	Microwave Preamplifier	HP	8449B	3008A01284	2020. 05. 26	1 Year
7.	Microwave Amplifier	Keysight	83051A	MY53010042	2020. 08. 05	1 Year
8.	Microwave Amplifier	Agilent	8449B	3008A02678	2021. 02. 27	1 Year
9.	Loop Antenna	R&S	HFH2-Z2	891847/27	2019. 12. 26	2 Years
10.	Bilog Antenna	TESEQ	CBL6112D	33821	2021. 01. 15	1 Year
11.	Horn Antenna	ETS-Lindgren	3117	00135902	2020. 03. 10	1 Year
12.	Horn Antenna	COM-POWER	AH-840	101092	2020 .05. 08	1 Year
13.	2.4GHz Notch Filter	K&L Microwave	7NSL10-2441 .5/E130.5-O/O	1	2020 .07. 24	1 Year
14.	3GHz Notch Filter	Microwave	H3G018G1	484796	2020. 08. 20	1 Year
15.	Coaxial Cable	MIYAZAKI	5D2W	RE-11	2021. 01. 29	1 Year
16.	Coaxial Cable	HUBER+SUHNER	SUCOFLEX 104	RE-29	2020. 09. 19	1 Year
17.	Coaxial Cable	HUBER+SUHNER	SUCOFLEX 102	RE-30	2020. 09. 19	1 Year
18.	Digital Thermo-Hygro Meter	iMax	HTC-1	No.1 3m A/C	2020. 04. 17	1 Year
19.	Digital Thermo-Hygro Meter	EVERY DAY	E-512	RF-02	2020. 04. 17	1 Year
20.	Test Software	Audix	e3	V6.120619c	N.C.R.	N.C.R.
21.	Test Software	Audix	e3	V6.110601	N.C.R.	N.C.R.

4.3. RF Conducted Measurement

Item	Type	Manufacturer	Model No.	Serial No.	Cal. Date	Cal. Interval
1.	Spectrum Analyzer	Keysight	N9020B-544	MY57120357	2021. 01. 06	1 Year
2.	Power Meter	Anritsu	ML2487A	6K00005406	2020. 04. 29	1 Year
3.	Power Sensor	Anritsu	MA2491A	030873	2020. 04. 29	1 Year
4.	Digital Thermo-Hygro Meter	Shenzhen Datronn Electronics	KT-905	RF	2020. 04. 17	1 Year

5. CONDUCTED EMISSION

5.1. Block Diagram of Test Setup

5.1.1. Block Diagram of EUT

Indicated as section 3.9

5.1.2. Shielded Room Setup Diagram

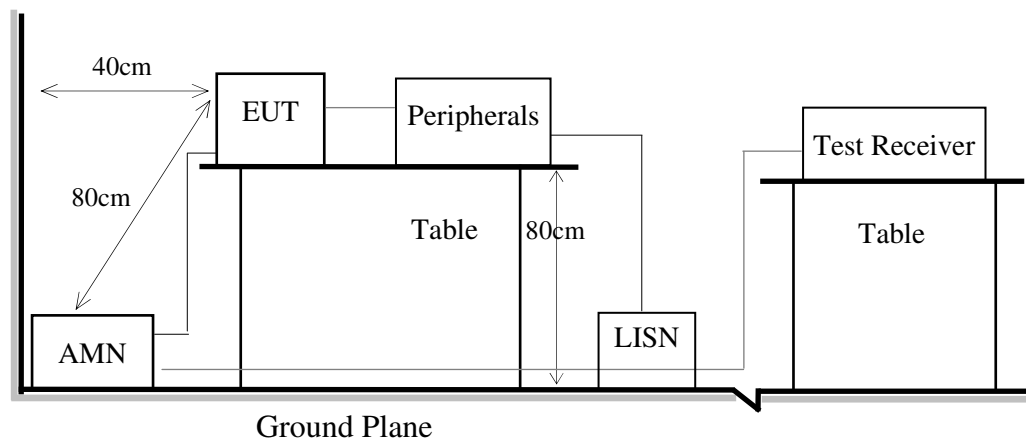

5.2. Conducted Emission Limit

Frequency	Conducted Limit	
	Quasi-Peak Level	Average Level
150kHz ~ 500kHz	66 ~ 56 dB μ V	56 ~ 46 dB μ V
500kHz ~ 5MHz	56 dB μ V	46 dB μ V
5MHz ~ 30MHz	60 dB μ V	50 dB μ V

Remark1.: If the average limit is met when using a Quasi-Peak detector, the measurement using the average detector is not required.

2.: The lower limit applies to the band edges.

5.3. Test Procedure

- 5.3.1. To set up the EUT as indicated in ANSI C63.10. The EUT was placed on the table which has 80 cm height to the ground and 40 cm distance to the conducting wall.
- 5.3.2. Power supplier of the EUT was connected to the AC mains through an Artificial Mains Network (A.M.N.).
- 5.3.3. The AC power supplies to all peripheral devices must be provided through line impedance stabilization network (L.I.S.N.)
- 5.3.4. Checking frequency range from 150kHz to 30 MHz and record the emission which does not have 20 dB below limit.

5.4. Test Results

Please refer to Appendix A.

6. RADIATED EMISSION

6.1. Block Diagram of Test Setup

6.1.1. Block Diagram of EUT

Indicated as section 3.9

6.1.2. Setup Diagram for 9kHz-30MHz

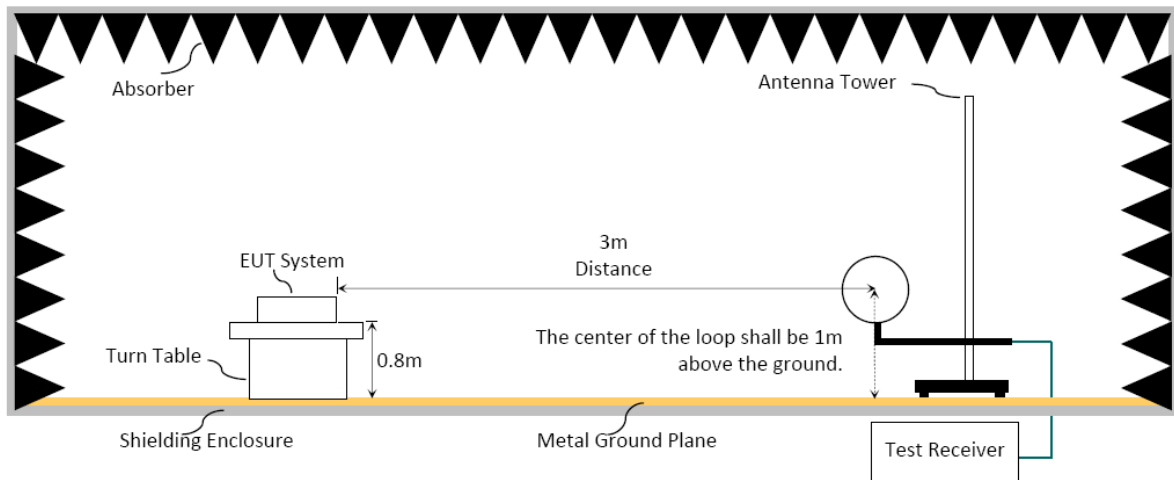

6.1.3. Setup Diagram for 30-1000MHz

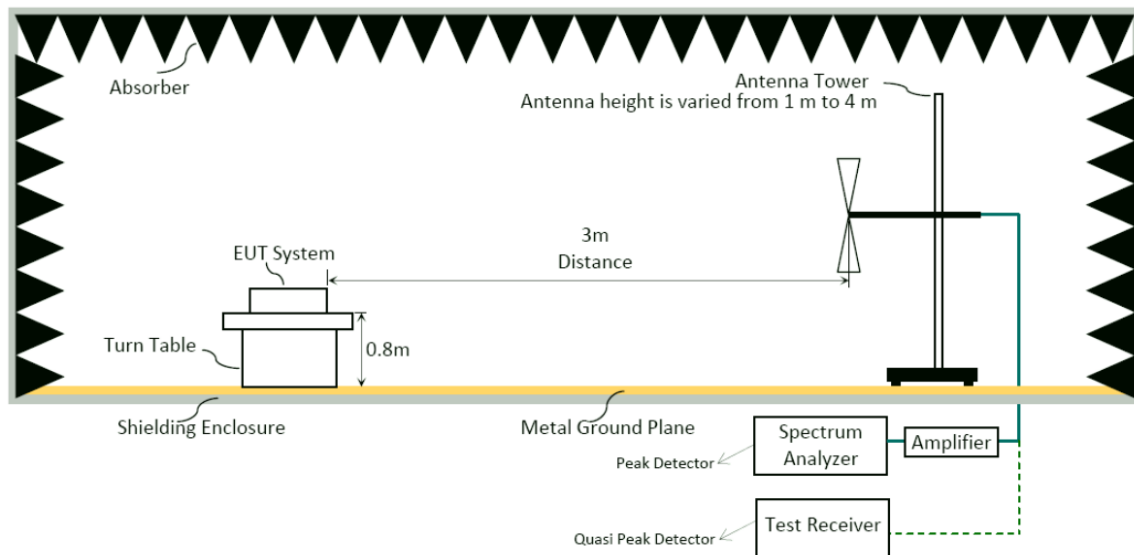

6.1.4. Setup Diagram for above 1GHz

Fully Anechoic Chamber

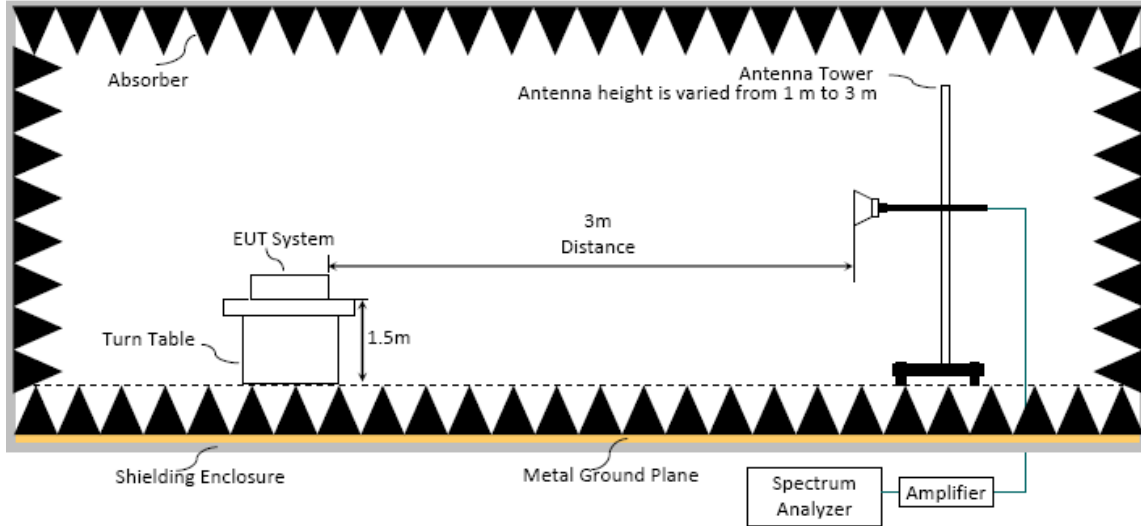

Semi Anechoic Chamber

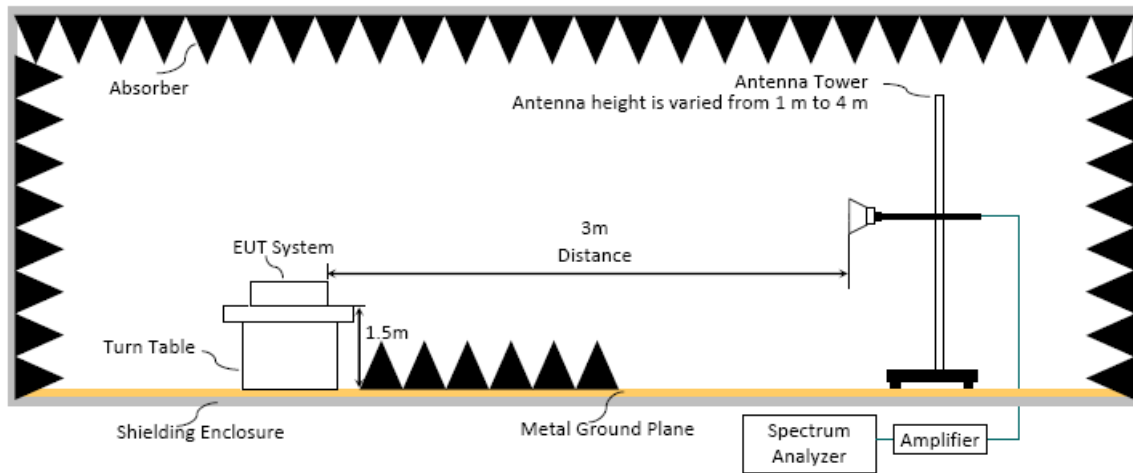

6.2. Radiated Emission Limits

In any 100kHz bandwidth outside the frequency band, the radio frequency power produced by the intentional radiator shall be at least 20dB below that in the 100kHz bandwidth within the band that contains the highest level. In addition, radiated emissions which fall in restricted bands, as defined in Section 15.205/RSS-Gen Section 8.10 table 6, must also comply with the radiated emission limits specified as below.

Frequency (MHz)	Distance(m)	Limits	
		dB μ V/m	μ V/m
0.009 - 0.490	300	67.6-20 log f(kHz)	2400/f kHz
0.490 - 1.705	30	87.6-20 log f(kHz)	24000/f kHz
1.705 - 30	30	29.5	30
30 - 88	3	40.0	100
88- 216	3	43.5	150
216- 960	3	46.0	200
Above 960	3	54.0	500
Above 1000	3	74.0 dB μ V/m (Peak) 54.0 dB μ V/m (Average)	

Remark : (1) dB μ V/m = 20 log (μ V/m)

- (2) The tighter limit applies to the edge between two frequency bands.
- (3) Distance refers to the distance in meters between the measuring instrument antenna and the closed point of any part of the device or system.
- (4) Fundamental and emission fall within operation band are exempted from this section.
- (5) Pursuant to ANSI C63.10: 6.6.4.3, if the maximized peak measured value complies with the average limit, then it is unnecessary to perform an average measurement.

6.3. Test Procedure

Frequency Range 9kHz~30MHz:

The EUT setup on the turntable which has 0.8 m height to the ground. The turn table rotated 360 degrees and antenna fixed to 1 m to find the maximum emission level. In order to find the maximum emission, all of the interface cables were manipulated according to ANSI C63.10-2013 regulation.

- (1) RBW = 9kHz with peak and average detector.
- (2) Detector: average and peak (9kHz-490kHz)
Q.P. (490kHz-30MHz)

Frequency Range 30MHz ~ 25GHz:

The EUT setup on the turn table which has 80cm (for 30-1000MHz) and 1.5m (for above 1GHz) height to the ground. The turn table rotated 360 degrees and antenna varied from 1 m to 4 m (for 30-1000MHz) and from 1m to 3m (for above 1GHz at fully Anechoic Chamber) or from 1 m to 4 m (for above 1GHz at Semi Anechoic Chamber) to find the maximum emission level. Both horizontal and vertical polarization are required. In order to find the maximum emission, all of the interface cables were manipulated according to ANSI C63.10-2013 regulation.

Frequency below 1GHz:

Spectrum Analyzer is used for pre-testing with following setting:

- (1) RBW = 120KHz
- (2) VBW $\geq 3 \times$ RBW.
- (3) Detector = Peak.
- (4) Sweep time = auto.
- (5) Trace mode = max hold.
- (6) Allow sweeps to continue until the trace stabilizes.

Note 1: When peak-detected value is lower than limit that the measurement using the Q.P. detector is not required, otherwise using Q.P. for final measurement.

Note 2: When the radiated emissions limits are expressed in terms of the average value of the emissions, and pulsed operation is employed, the measurement field strength shall be determined by averaging over one complete pulse train, including blanking intervals, as long as the pulse train does not exceed 0.1 seconds.

Frequency above 1GHz to 10th harmonic (up to 25 GHz):

Peak Detector:

- (1) RBW = 1MHz
- (2) VBW $\geq 3 \times$ RBW.
- (3) Detector = Peak.
- (4) Sweep time = auto.
- (5) Trace mode = max hold.
- (6) Allow sweeps to continue until the trace stabilizes.

Note: When peak-detected value is lower than limit that the measurement using the average detector is not required, otherwise using average detector for final measurement.

Average Detector:

Option 1:

- (1) RBW = 1MHz
- (2) VBW \geq 1/ T.

Modulation Type	T (ms)	1/ T (kHz)	VBW Setting(Hz)
BLE (1Mbps)	0.210	4.762	5.1kHz
BLE (2Mbps)	0.207	4.831	5.1kHz
BLE (PHY Coded S2)	3.100	0.323	330Hz
BLE (PHY Coded S8)	1.070	0.935	1.0Hz
802.11b	8.360	0.120	10Hz
802.11g	2.087	0.479	510Hz
802.11n-HT20	3.980	0.251	10Hz
802.11n-HT40	3.980	0.251	10Hz
802.11ax-HE20	3.960	0.253	10Hz
802.11ax-HE40	3.960	0.253	10Hz

N/A: 1/ T is not implemented when duty cycle presented in section 3.6 is \geq 98%.

- (1) Detector = Peak.
- (2) Sweep time = auto.
- (3) Trace mode = max hold.
- (4) Allow sweeps to continue until the trace stabilizes.

Option 2:

Average Emission Level= Peak Emission Level+ D.C.C.F.

6.4. Measurement Result Explanation

- Peak Emission Level=Antenna Factor + Cable Loss +Meter Reading (including Preamp factor if test used)
- Average Emission Level l=Antenna Factor + Cable Loss + Meter Reading (including Preamp factor if test used)
- Average Emission Level= Peak Emission Level+ DCCF
 Duty Cycle Correction Factor (DCCF)= $20\log(TX_{on}/TX_{on+off})$ presented in section 3.6
- ERP= Peak Emission Level-95.2dB-2.14dB

6.5. Test Results

Please refer to Appendix A.

7. 6dB/OCCUPIED BANDWIDTH

7.1. Block Diagram of Test Setup

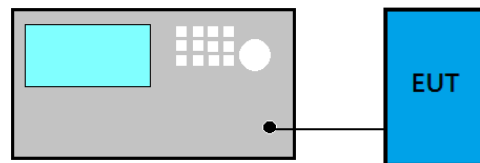

7.2. Specification Limits

The minimum 6dB bandwidth shall be at least 500kHz.

7.3. Test Procedure

Following measurement procedure is reference to ANSI C63.10:2013:

For 6dB Bandwidth

- (1) Set RBW = 100 kHz.
- (2) Set the video bandwidth (VBW) $\geq 3 \times$ RBW.
- (3) Detector = Peak.
- (4) Trace mode = max hold.
- (5) Sweep = auto couple.
- (6) Allow the trace to stabilize.
- (7) Setting channel bandwidth function x to -6dB power to record the final bandwidth..

For 99% Occupied Bandwidth

- (1) Set Span range 1.5~5 times the OBW
- (2) Set RBW close to 1% to 5% of OBW.
- (3) Set $VBW \geq 3 \times RBW$.
- (4) Detector = Peak.
- (5) Trace mode = Max hold
- (6) Sweep = Auto couple.
- (7) Allow the trace to stabilize.

7.4. Test Results

Please refer to Appendix A

8. MAXIMUM PEAK OUTPUT POWER

8.1. Block Diagram of Test Setup

- For WLAN Function

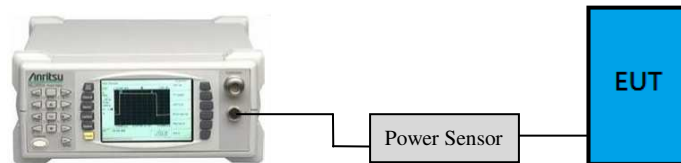

- For BLE Function

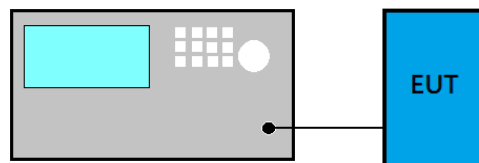

8.2. Specification Limits

The Limits of maximum Peak Output Power for digital modulation in 2400-2483.5MHz is : 1Watt. (30dBm), and E.I.R.P.: 4Watt (36dBm)

8.3. Test Procedure

Following measurement procedure is reference to ANSI C63.10:2013:

PKPM1 Peak power meter method:

EUT is connected to power sensor and record the maximum output power.

Maximum peak conducted output power method:

- (1) Set the RBW \geq DTS bandwidth
- (2) Set VBW $\geq 3 \times$ RBW
- (3) Set span $\geq 3 \times$ RBW.
- (4) Sweep time = auto couple
- (5) Detector = peak.
- (6) Trace mode = max hold.
- (7) Allow trace to fully stabilize.
- (8) Use peak marker function to determine the peak amplitude level.

Method AVGPM (Measurement using an RF average power meter):

EUT is connected to power sensor and record the maximum average output power and duty cycle factor is added when duty cycle presented in section 3.7 is $< 98\%$.

Method AVGSA-2 (Spectrum channel power)

- (1) Set span to at least 1.5 times the OBW
- (2) Set RBW = 1 -5% of OBW
- (3) Set the video bandwidth (VBW) $\geq 3 \times$ RBW.
- (4) Detector = RMS.
- (5) Trace mode = trace average at least 100 traces
- (6) Sweep = auto couple.
- (7) Compute power by integrating the spectrum across the OBW of the signal using the instrument's band power measurement function with band limits set equal to the OBW band edges.
- (8) Duty cycle factor is added when duty cycle presented in section 3.7 is $< 98\%$.

8.4. Test Results

Please refer to Appendix A

9. EMISSION LIMITATIONS

9.1. Block Diagram of Test Setup

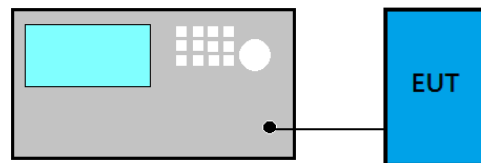

9.2. Specification Limits

In any 100kHz bandwidth outside the frequency band in which the spread spectrum or digitally modulated intentional radiator is operating, the radio frequency power that is produced by the intentional radiator shall be at least 20dB below that in the 100kHz bandwidth within the band that contains the highest level of the desired power, based on either an RF conducted or a radiated measurement. If the transmitter complies with the conducted power limits based on the use of RMS averaging over a time interval, that the required attenuation shall be 30 dB instead of 20 dB.

Attenuation below the general limits specified in Section 15.209(a)/RSS-Gen Section 8.9 table 4 is not required. In addition, radiated emissions which fall in restricted bands, as defined in Section 15.205(a)/RSS-Gen Section 8.10 table 6, must also comply with the radiated emission limits specified in Section 15.209(a)/RSS-Gen Section 8.9 table 4 (See Section 15.205(c)).

9.3. Test Procedure

Following measurement procedure is reference to ANSI C63.10:2013:

■ Reference Level

- (1) Set analyzer center frequency to DTS channel center frequency.
- (2) Set the span to 1.5 times the DTS bandwidth.
- (3) Set the RBW to: 100 kHz.
- (4) Set the VBW $\geq 3 \times$ RBW.
- (5) Detector = peak.
- (6) Sweep time = auto couple.
- (7) Trace mode = max hold.
- (8) Allow trace to fully stabilize to find the max PSD as reference level.

■ Emission Level Measurement

- (1) Set analyzer center frequency to DTS channel center frequency.
- (2) Set the span to 1.5 times the DTS bandwidth.
- (3) Set the RBW to: 100 kHz.
- (4) Set the VBW $\geq 3 \times$ RBW.
- (5) Detector = peak.
- (6) Sweep time = auto couple.
- (7) Trace mode = max hold.
- (8) Allow trace to fully stabilize to find the max level.

9.4. Test Results

Please refer to Appendix A

10. POWER SPECTRAL DENSITY

10.1. Block Diagram of Test Setup

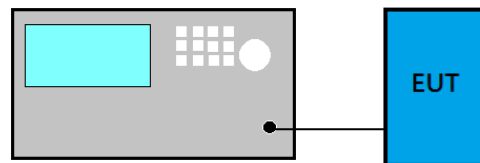

10.2. Specification Limits

The peak power spectral density conducted from the intentional radiator to the antenna shall not be greater than 8dBm in any 3kHz band.

10.3. Test Procedure

Following measurement procedure is reference to ANSI C63.10:2013:

■ Method PKPSD (peak PSD)

- (1) Set analyzer center frequency to DTS channel center frequency.
- (2) Set the span to 1.5 times the DTS bandwidth.
- (3) Set the RBW to: $3 \text{ kHz} \leq \text{RBW} \leq 100 \text{ kHz}$.
- (4) Set the VBW $\geq 3 \times \text{RBW}$.
- (5) Detector = peak.
- (6) Sweep time = auto couple.
- (7) Trace mode = max hold.
- (8) Allow trace to fully stabilize.
- (9) Use the peak marker function to determine the maximum amplitude level.
- (10) If measured value exceeds limit, reduce RBW (no less than 3 kHz) and repeat.

□ Method AVGPSD-2

- (1) Using peak PSD procedure step 1 to step 4.
- (2) Detector = RMS detector
- (3) Sweep time = auto couple
- (4) Trace mode = trace averaging over a minimum of 100 traces
- (5) Use the peak marker function to determine the maximum amplitude level.
- (6) Duty cycle factor is added when duty cycle presented in section 3.7 < 98%.
- (7) If measured value exceeds limit, reduce RBW (no less than 3 kHz) and repeat.

10.4. Test Results

Please refer to Appendix A

11.DEVIATION TO TEST SPECIFICATIONS

【NONE】



APPDNDIX A

TEST DATA AND PLOTS

(Model: 15Z90P)

TABLE OF CONTENTS

A.1 CONDUCTED EMISSION	2
A.2 RADIATED EMISSION	6
A.2.1 Emissions within Restricted Frequency Bands.....	6
A.2.2 Emissions outside the frequency band:.....	104
A.2.3 Emissions in Non-restricted Frequency Bands:.....	107
A.3 6dB/OCCUPIED BANDWIDTH	108
A.3.1 Emission Bandwidth Result.....	108
A.3.2 Measurement Plots	110
A.4 MAXIMUM PEAK OUTPUT POWER	116
A.4.1 Peak Output Power	116
A.4.2 Average Output Power (Reporting only).....	128
A.4.3 Measurement Plots	137
A.5 EMISSION LIMITATIONS	139
A.6 POWER SPECTRAL DENSITY	166
A.6.1 Power Spectral Density Result	166
A.6.2 Measurement Plots	168

A.1 CONDUCTED EMISSION

Test Date	2021/02/22	Temp./Hum.	22°C/53%
Test Voltage	AC 120V 60Hz (Via AC Adapter)	Tested By	Chucky Chiu
Test SKU	SKU #1 (with INPAQ Antenna)		

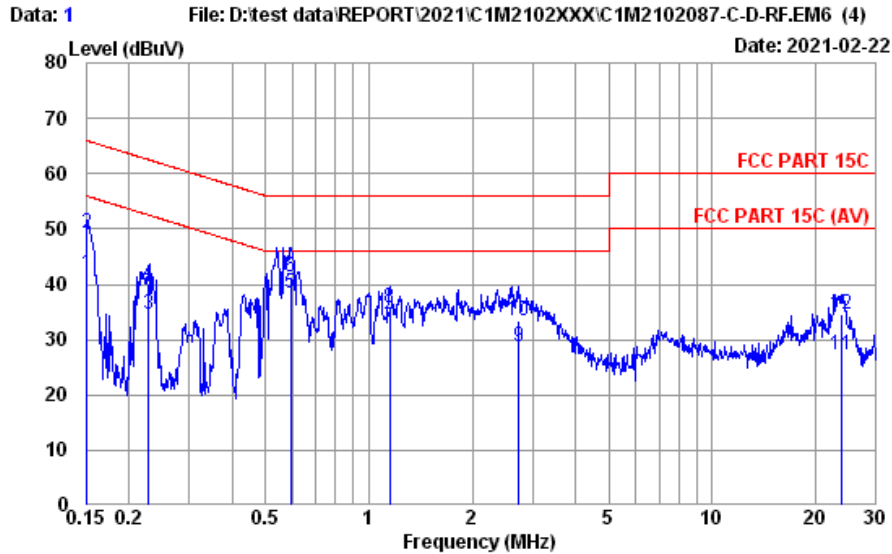

Site No. : No.8 Shielded Room Data No. : 1
 Instrument 1 : Receiver ESR3(774)
 Instrument 2 : ENH432 (567)(A)|CE-08|ESH3-Z2 (354)
 Limit : FCC PART 15C Phase : NEUTRAL
 Environment : 22°C / 53% Engineer : Chucky Chiu
 EUT Model : 15Z90P Test Rating : 120Vac/60Hz
 Test Mode : Operating

	Freq. (MHz)	AMI Factor (dB)	Cable Loss (dB)	Pulse Att. (dB)	Reading (dBμV)	Emission Level (dBμV)	Limits (dBμV)	Margin (dB)	Remark
1	0.151	10.20	0.03	9.85	21.89	41.97	55.96	13.99	Average
2	0.151	10.20	0.03	9.85	29.16	49.24	65.96	16.72	QP
3	0.228	10.20	0.03	9.85	14.36	34.44	52.52	18.08	Average
4	0.228	10.20	0.03	9.85	20.08	40.16	62.52	22.36	QP
5	0.592	10.20	0.03	9.85	18.22	38.30	46.00	7.70	Average
6	0.592	10.20	0.03	9.85	21.11	41.19	56.00	14.81	QP
7	1.147	10.20	0.04	9.85	12.03	32.12	46.00	13.88	Average
8	1.147	10.20	0.04	9.85	15.52	35.61	56.00	20.39	QP
9	2.736	10.30	0.07	9.86	8.46	28.69	46.00	17.31	Average
10	2.736	10.30	0.07	9.86	13.17	33.40	56.00	22.60	QP
11	23.762	10.98	0.22	9.96	6.23	27.39	50.00	22.61	Average
12	23.762	10.98	0.22	9.96	13.56	34.72	60.00	25.28	QP

Remarks: 1. Emission Level= AMI Factor + Cable Loss + Pulse Att. + Reading.
 2. If the average limit is met when using a quasi-peak detector, the EUT shall be deemed to meet both limits and measurement with average detector is unnecessary.

Test Date	2021/02/22	Temp./Hum.	22°C/53%
Test Voltage	AC 120V 60Hz (Via AC Adapter)	Tested By	Chucky Chiu
Test SKU	SKU #1 (with INPAQ Antenna)		

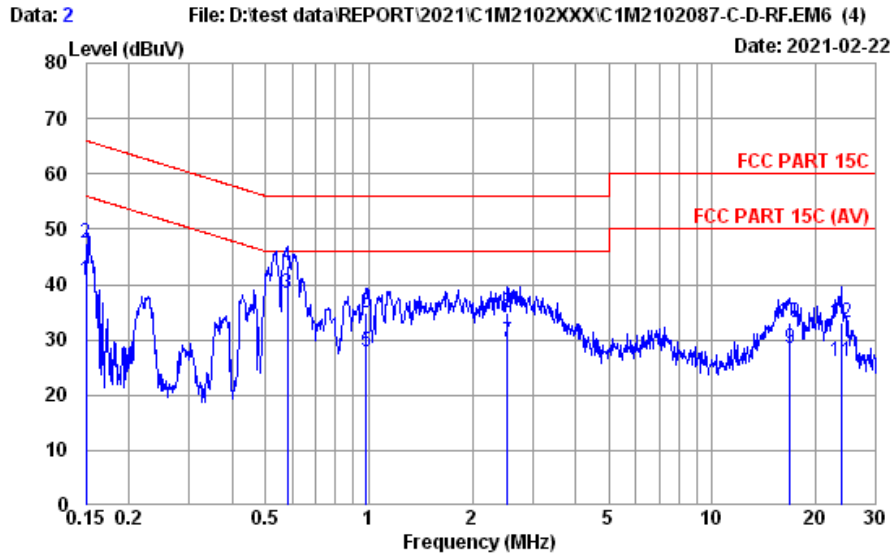

Site No.	: No.8 Shielded Room	Data No.	: 2
Instrument 1	: Receiver ESR3(774)		
Instrument 2	: EMI432 (567)(A) CE-08 ESH3-Z2 (354)		
Limit	: FCC PART 15C	Phase	: LINE
Environment	: 22°C / 53%	Engineer	: Chucky Chiu
EUT Model	: 15Z90P	Test Rating	: 120Vac/60Hz
Test Mode	: Operating		

	Freq. (MHz)	AMI Factor (dB)	Cable Loss (dB)	Pulse Att. (dB)	Reading (dBµV)	Emission Level (dBµV)	Limits (dBµV)	Margin (dB)	Remark
1	0.150	10.20	0.03	9.85	20.57	40.65	56.00	15.35	Average
2	0.150	10.20	0.03	9.85	27.36	47.44	66.00	18.56	QP
3	0.579	10.20	0.03	9.85	18.44	38.52	46.00	7.48	Average
4	0.579	10.20	0.03	9.85	23.34	43.42	56.00	12.58	QP
5	0.984	10.20	0.04	9.85	7.84	27.93	46.00	18.07	Average
6	0.984	10.20	0.04	9.85	14.91	35.00	56.00	21.00	QP
7	2.527	10.30	0.07	9.86	9.28	29.51	46.00	16.49	Average
8	2.527	10.30	0.07	9.86	14.53	34.76	56.00	21.24	QP
9	16.839	10.54	0.18	9.92	7.74	28.38	50.00	21.62	Average
10	16.839	10.54	0.18	9.92	12.58	33.22	60.00	26.78	QP
11	23.888	10.60	0.22	9.96	5.24	26.02	50.00	23.98	Average
12	23.888	10.60	0.22	9.96	12.32	33.10	60.00	26.90	QP

Remarks: 1. Emission Level= AMI Factor + Cable Loss + Pulse Att. + Reading.
 2. If the average limit is met when using a quasi-peak detector, the EUT shall be deemed to meet both limits and measurement with average detector is unnecessary.

Test Date	2021/03/05	Temp./Hum.	21°C/59%
Test Voltage	AC 120V 60Hz (Via AC Adapter)	Tested By	Bruce Tseng
Test SKU	SKU #2 (with LUXSHARE-ICT Antenna)		

Data: 4 File: D:\test data\REPORT\2021\C1M2102XXX\C1M2102087\C1M2102087-C-D-RF.EM6 (4)

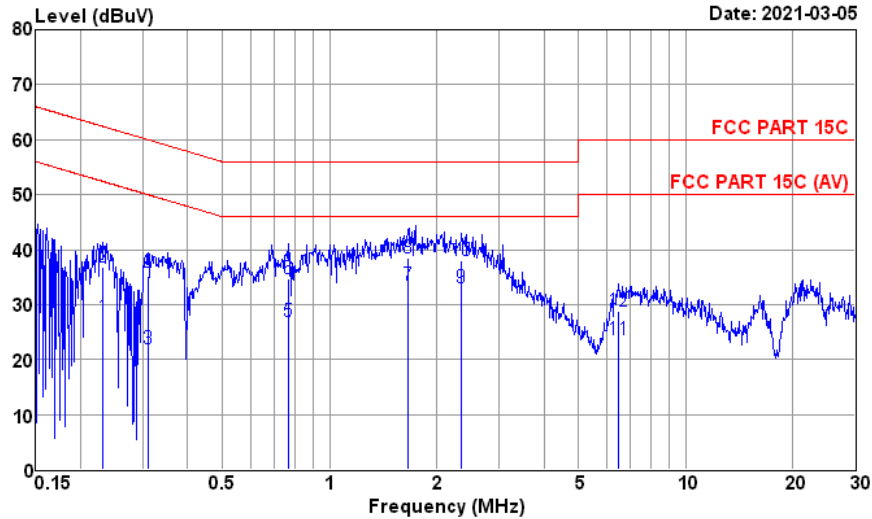

Site No. : No.7 Shielded Room Data No. : 4
 Instrument 1 : Receiver ESCI(746)
 Instrument 2 : ESH2-Z5 (366)(A)|CE-07|ESH3-Z2 (495)
 Limit : FCC PART 15C Phase : NEUTRAL
 Environment : 21°C / 59% Engineer : Bruce
 EUT Model : 15Z90P Test Rating : 120Vac/60Hz
 Test Mode : Operating

	Freq. (MHz)	AMN Factor (dB)	Cable Loss (dB)	Pulse Att. (dB)	Reading (dBµV)	Emission Level (dBµV)	Limits (dBµV)	Margin (dB)	Remark
1	0.232	0.06	0.04	9.86	17.66	27.62	52.40	24.78	Average
2	0.232	0.06	0.04	9.86	26.78	36.74	62.40	25.66	QP
3	0.310	0.07	0.04	9.86	11.88	21.85	49.97	28.12	Average
4	0.310	0.07	0.04	9.86	25.24	35.21	59.97	24.76	QP
5	0.767	0.09	0.05	9.86	17.03	27.03	46.00	18.97	Average
6	0.767	0.09	0.05	9.86	24.75	34.75	56.00	21.25	QP
7	1.669	0.12	0.06	9.86	23.48	33.52	46.00	12.48	Average
8	1.669	0.12	0.06	9.86	28.34	38.38	56.00	17.62	QP
9	2.348	0.15	0.08	9.86	22.94	33.03	46.00	12.97	Average
10	2.348	0.15	0.08	9.86	28.01	38.10	56.00	17.90	QP
11	6.490	0.28	0.14	9.88	13.22	23.52	50.00	26.48	Average
12	6.490	0.28	0.14	9.88	18.57	28.87	60.00	31.13	QP

Remarks: 1. Emission Level= AMN Factor + Cable Loss + Pulse Att. + Reading.
 2. If the average limit is met when using a quasi-peak detector,
 the EUT shall be deemed to meet both limits and measurement
 with average detector is unnecessary.

Test Date	2021/03/05	Temp./Hum.	21°C/59%
Test Voltage	AC 120V 60Hz (Via AC Adapter)	Tested By	Bruce Tseng
Test SKU	SKU #2 (with LUXSHARE-ICT Antenna)		

Data: 3 File: D:\test data\REPORT\2021\1C1M2102XX\1C1M2102087\1C1M2102087-C-D-RF.EM6 (4)

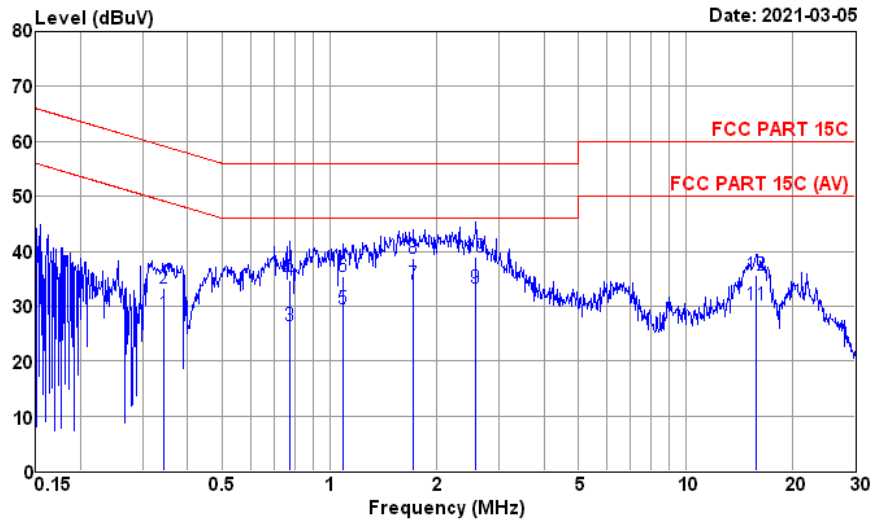

Site No. : No.7 Shielded Room Data No. : 3
 Instrument 1 : Receiver ESCI(746)
 Instrument 2 : ESH2-Z5 (366)(A)|CE-07|ESH3-Z2 (495)
 Limit : FCC PART 15C Phase : LINE
 Environment : 21°C / 59% Engineer : Bruce
 EUT Model : 15Z90P Test Rating : 120Vac/60Hz
 Test Mode : Operating

	Freq. (MHz)	AMN Factor (dB)	Cable Loss (dB)	Pulse Att. (dB)	Reading (dBμV)	Emission Level (dBμV)	Limits (dBμV)	Margin (dB)	Remark
1	0.341	0.06	0.04	9.86	18.63	28.59	49.17	20.58	Average
2	0.341	0.06	0.04	9.86	23.38	33.34	59.17	25.83	QP
3	0.775	0.07	0.05	9.86	16.40	26.38	46.00	19.62	Average
4	0.775	0.07	0.05	9.86	24.78	34.76	56.00	21.24	QP
5	1.093	0.08	0.05	9.86	19.58	29.57	46.00	16.43	Average
6	1.093	0.08	0.05	9.86	25.38	35.37	56.00	20.63	QP
7	1.726	0.10	0.06	9.86	24.00	34.02	46.00	11.98	Average
8	1.726	0.10	0.06	9.86	28.63	38.65	56.00	17.35	QP
9	2.582	0.13	0.08	9.86	23.33	33.40	46.00	12.60	Average
10	2.582	0.13	0.08	9.86	28.80	38.87	56.00	17.13	QP
11	15.820	0.57	0.23	9.93	19.42	30.15	50.00	19.85	Average
12	15.820	0.57	0.23	9.93	24.81	35.54	60.00	24.46	QP

Remarks: 1. Emission Level= AMN Factor + Cable Loss + Pulse Att. + Reading.
 2. If the average limit is met when using a quasi-peak detector,
 the EUT shall be deemed to meet both limits and measurement
 with average detector is unnecessary.

A.2 RADIATED EMISSION

Test Date	2021/02/17 ~ 22	Temp./Hum.	18 ~ 20°C/44 ~ 58%
Test Voltage	AC 120V 60Hz (Via AC Adapter)	Tested By	Kuper Hsu

A.2.1 Emissions within Restricted Frequency Bands

A.2.1.1 Frequency 9kHz~30MHz

The emissions (9kHz~30MHz) not reported for there is no emission be found.

A.2.1.2 Frequency Below 1GHz

Mode	802.11n-HT20	Frequency	TX 2442MHz
------	--------------	-----------	------------

Antenna at Horizontal Polarization

Emission Frequency (MHz)	Antenna Factor (dB/m)	Cable Loss (dB)	Preamp Gain (dB)	Read Level (dBμV)	Emission Level (dBμV/m)	Limits (dBμV/m)	Margin (dB)	Detector
33.880	16.85	1.32	28.13	47.55	37.59	40.00	2.41	Peak
120.210	11.90	2.68	27.95	54.04	40.67	43.50	2.83	Peak
445.160	16.33	6.43	28.82	43.85	37.79	46.00	8.21	Peak
593.570	18.35	7.02	29.39	43.47	39.45	46.00	6.55	Peak
889.420	20.36	8.66	28.88	42.67	42.81	46.00	3.19	Peak
967.020	21.01	9.01	28.66	39.08	40.44	54.00	13.56	Peak

Antenna at Vertical Polarization

Emission Frequency (MHz)	Antenna Factor (dB/m)	Cable Loss (dB)	Preamp Gain (dB)	Read Level (dBμV)	Emission Level (dBμV/m)	Limits (dBμV/m)	Margin (dB)	Detector
32.910	17.47	1.29	28.14	47.17	37.79	40.00	2.21	Peak
120.210	11.90	2.68	27.95	54.30	40.93	43.50	2.57	Peak
238.550	11.56	3.91	27.63	52.95	40.79	46.00	5.21	Peak
593.570	18.35	7.02	29.39	44.41	40.39	46.00	5.61	Peak
875.840	20.30	8.58	28.93	43.83	43.78	46.00	2.22	Peak
965.080	21.01	9.01	28.66	38.86	40.22	54.00	13.78	Peak

Mode	BLE	Frequency	TX 2440MHz
------	-----	-----------	------------

Antenna at Horizontal Polarization

Emission Frequency (MHz)	Antenna Factor (dB/m)	Cable Loss (dB)	Preamp Gain (dB)	Read Level (dBμV)	Emission Level (dBμV/m)	Limits (dBμV/m)	Margin (dB)	Detector
33.880	16.85	1.32	28.13	47.62	37.66	40.00	2.34	Peak
119.240	11.90	2.67	27.95	54.88	41.50	43.50	2.00	Peak
445.160	16.33	6.43	28.82	43.48	37.42	46.00	8.58	Peak
668.260	18.72	7.43	29.35	40.45	37.25	46.00	8.75	Peak
885.540	20.33	8.63	28.91	42.85	42.90	46.00	3.10	Peak
965.080	21.01	9.01	28.66	37.13	38.49	54.00	15.51	Peak

Antenna at Vertical Polarization

Emission Frequency (MHz)	Antenna Factor (dB/m)	Cable Loss (dB)	Preamp Gain (dB)	Read Level (dBμV)	Emission Level (dBμV/m)	Limits (dBμV/m)	Margin (dB)	Detector
33.880	16.85	1.32	28.13	47.13	37.17	40.00	2.83	Peak
119.240	11.90	2.67	27.95	54.65	41.27	43.50	2.23	Peak
240.490	11.69	3.93	27.62	52.38	40.38	46.00	5.62	Peak
593.570	18.35	7.02	29.39	46.09	42.07	46.00	3.93	Peak
896.210	20.38	8.70	28.86	44.16	44.38	46.00	1.62	Peak
969.930	21.04	9.03	28.66	37.31	38.72	54.00	15.28	Peak

A.2.1.3 Frequency Above 1 GHz to 10th harmonics

Band Edge:

Mode	802.11b	Frequency	TX 2412MHz
------	---------	-----------	------------

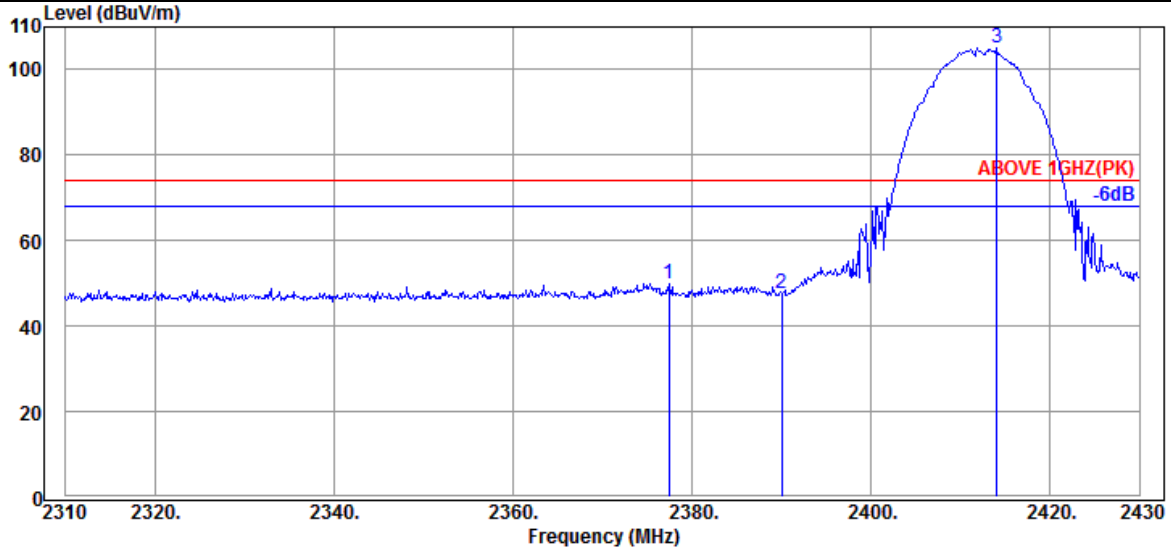

Antenna at Horizontal Polarization

Emission Frequency (MHz)	Antenna Factor (dB/m)	Cable Loss (dB)	Preamplifier Gain (dB)	Read Level (dBμV)	Emission Level (dBμV/m)	Limits (dBμV/m)	Margin (dB)	Detector
2377.440	32.41	7.95	34.58	44.28	50.06	74.00	23.94	Peak
2390.040	32.44	7.95	34.58	41.95	47.76	74.00	26.24	Peak
@ 2414.040	32.36	7.96	34.59	99.27	105.00	---	---	Peak

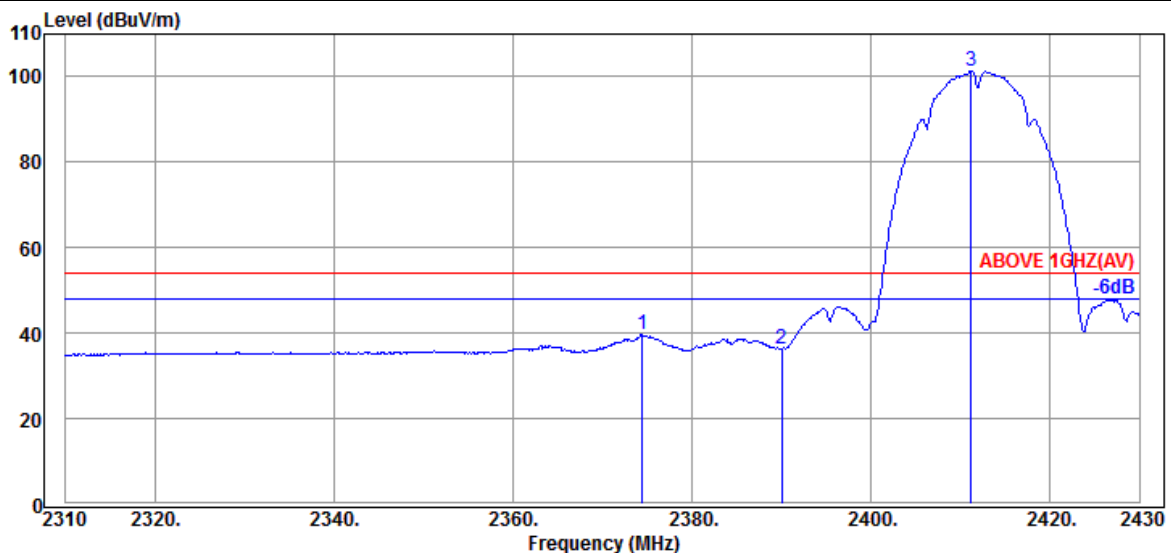

Antenna at Horizontal Polarization

Emission Frequency (MHz)	Antenna Factor (dB/m)	Cable Loss (dB)	Preamplifier Gain (dB)	Read Level (dBμV)	Emission Level (dBμV/m)	Limits (dBμV/m)	Margin (dB)	Detector
2374.440	32.39	7.94	34.58	33.81	39.56	54.00	14.44	Average
2390.040	32.44	7.95	34.58	30.34	36.15	54.00	17.85	Average
@ 2411.160	32.43	7.96	34.59	95.52	101.32	---	---	Average

Remark: The “@” means fundamental frequency, it is ignored in this section.

Mode	802.11b	Frequency	TX 2412MHz
------	---------	-----------	------------

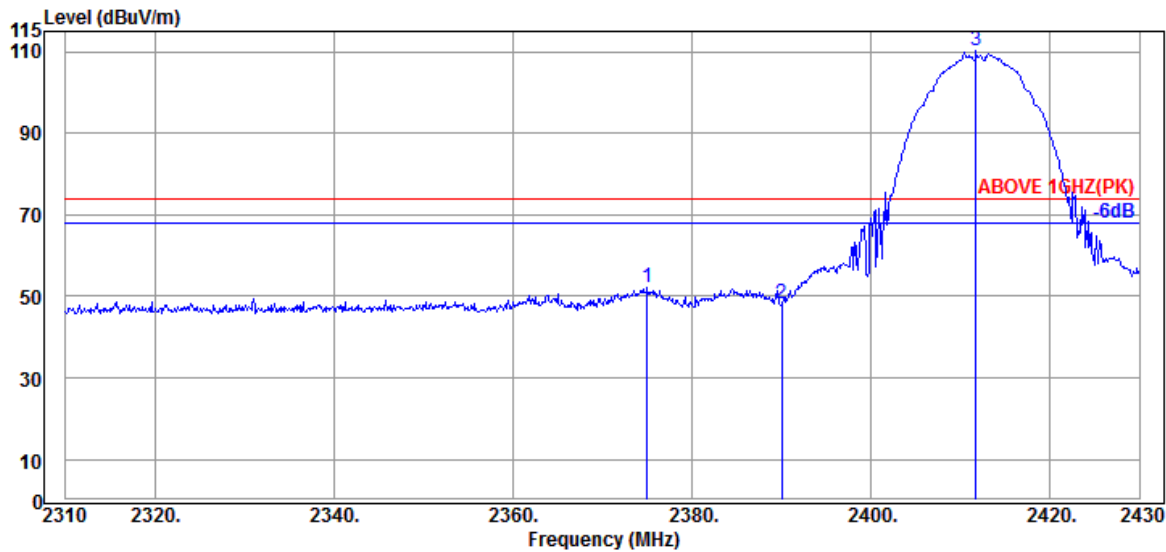

Antenna at Vertical Polarization

Emission Frequency (MHz)	Antenna Factor (dB/m)	Cable Loss (dB)	Preamplifier Gain (dB)	Read Level (dBμV)	Emission Level (dBμV/m)	Limits (dBμV/m)	Margin (dB)	Detector
2375.040	32.39	7.94	34.58	46.42	52.17	74.00	21.83	Peak
2390.040	32.44	7.95	34.58	42.33	48.14	74.00	25.86	Peak
@ 2411.760	32.36	7.96	34.59	104.70	110.43	---	---	Peak

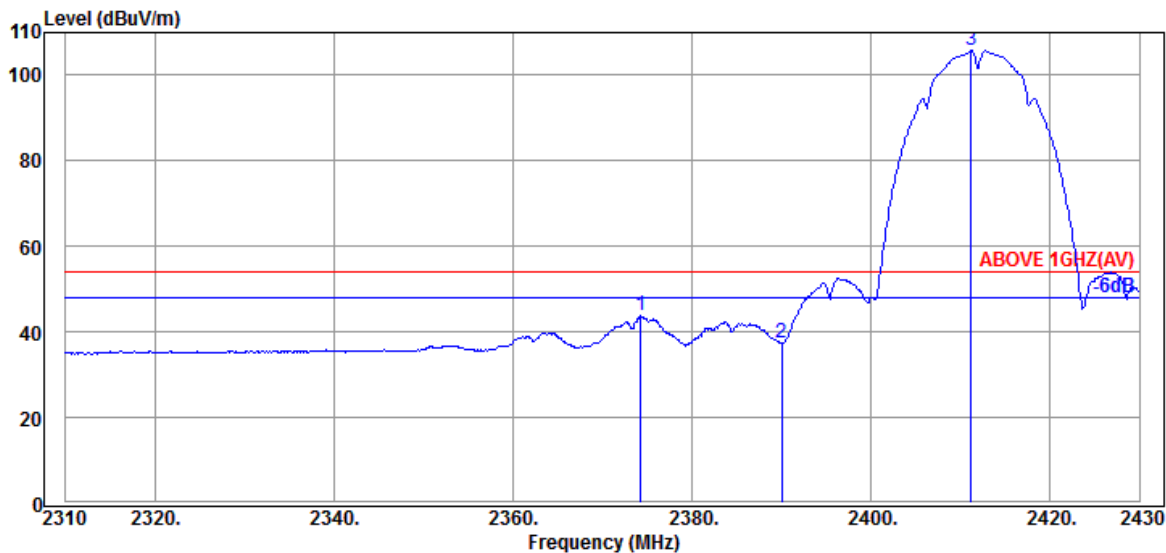

Antenna at Vertical Polarization

Emission Frequency (MHz)	Antenna Factor (dB/m)	Cable Loss (dB)	Preamplifier Gain (dB)	Read Level (dBμV)	Emission Level (dBμV/m)	Limits (dBμV/m)	Margin (dB)	Detector
2374.320	32.39	7.94	34.58	37.94	43.69	54.00	10.31	Average
2390.040	32.44	7.95	34.58	31.67	37.48	54.00	16.52	Average
@ 2411.160	32.43	7.96	34.59	99.97	105.77	---	---	Average

Remark: The "@" means fundamental frequency, it is ignored in this section.

Mode	802.11b	Frequency	TX 2417MHz
------	---------	-----------	------------

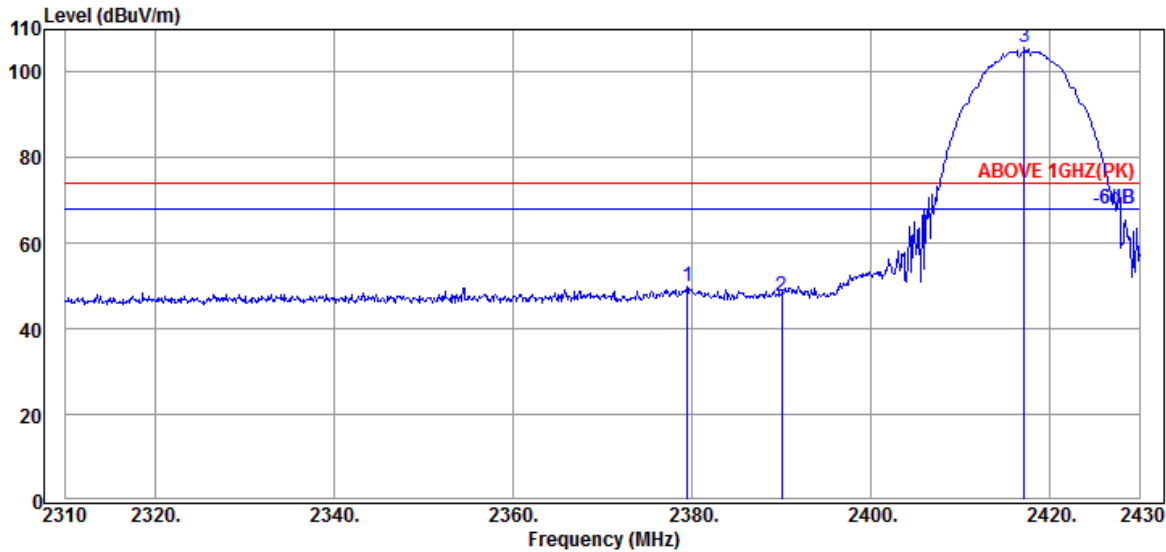

Antenna at Horizontal Polarization

Emission Frequency (MHz)	Antenna Factor (dB/m)	Cable Loss (dB)	Preamplifier Gain (dB)	Read Level (dBμV)	Emission Level (dBμV/m)	Limits (dBμV/m)	Margin (dB)	Detector
2379.480	32.41	7.95	34.58	44.06	49.84	74.00	24.16	Peak
2390.040	32.44	7.95	34.58	41.74	47.55	74.00	26.45	Peak
@ 2417.160	32.36	7.96	34.59	100.15	105.88	---	---	Peak

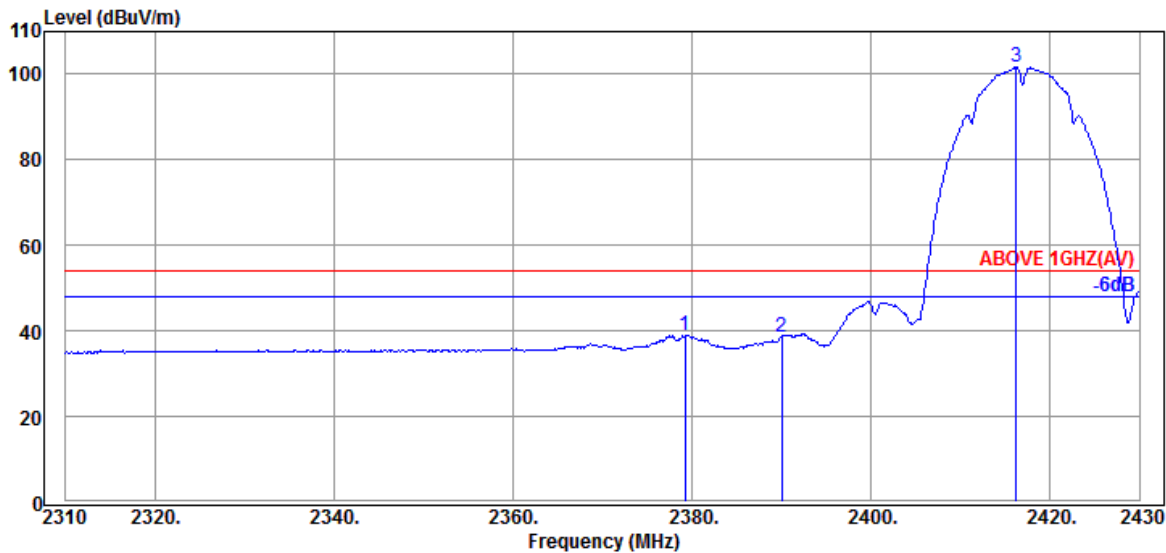

Antenna at Horizontal Polarization

Emission Frequency (MHz)	Antenna Factor (dB/m)	Cable Loss (dB)	Preamplifier Gain (dB)	Read Level (dBμV)	Emission Level (dBμV/m)	Limits (dBμV/m)	Margin (dB)	Detector
2379.240	32.41	7.95	34.58	33.31	39.09	54.00	14.91	Average
2390.040	32.44	7.95	34.58	32.74	38.55	54.00	15.45	Average
@ 2416.200	32.36	7.96	34.59	95.90	101.63	---	---	Average

Remark: The "@" means fundamental frequency, it is ignored in this section.

Mode	802.11b	Frequency	TX 2417MHz
------	---------	-----------	------------

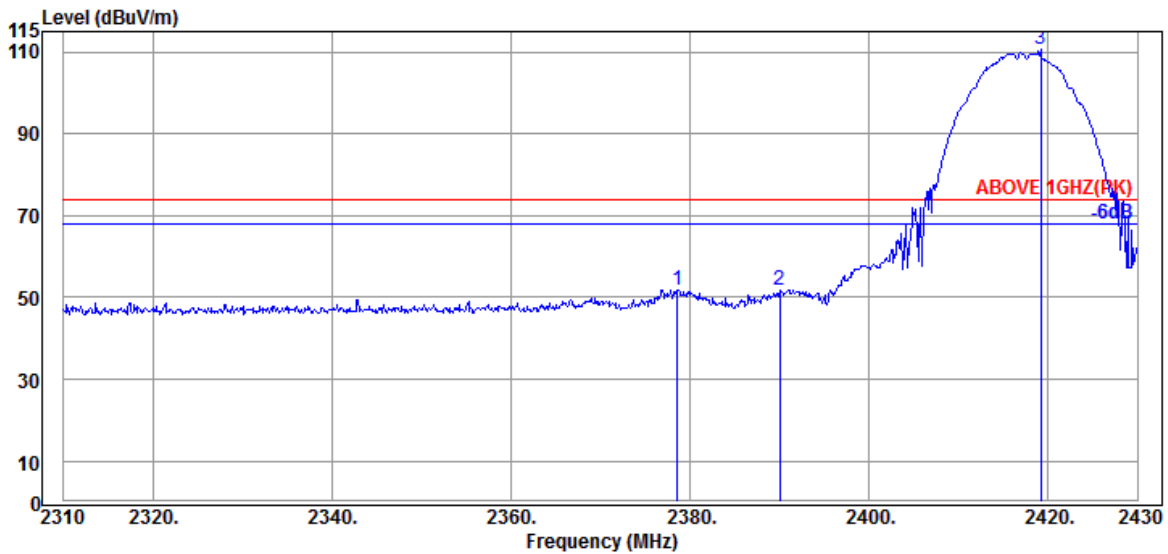

Antenna at Vertical Polarization

Emission Frequency (MHz)	Antenna Factor (dB/m)	Cable Loss (dB)	Preamplifier Gain (dB)	Read Level (dBμV)	Emission Level (dBμV/m)	Limits (dBμV/m)	Margin (dB)	Detector
2378.640	32.41	7.95	34.58	46.05	51.83	74.00	22.17	Peak
2390.040	32.44	7.95	34.58	45.90	51.71	74.00	22.29	Peak
@ 2419.200	32.29	7.96	34.59	104.93	110.59	---	---	Peak

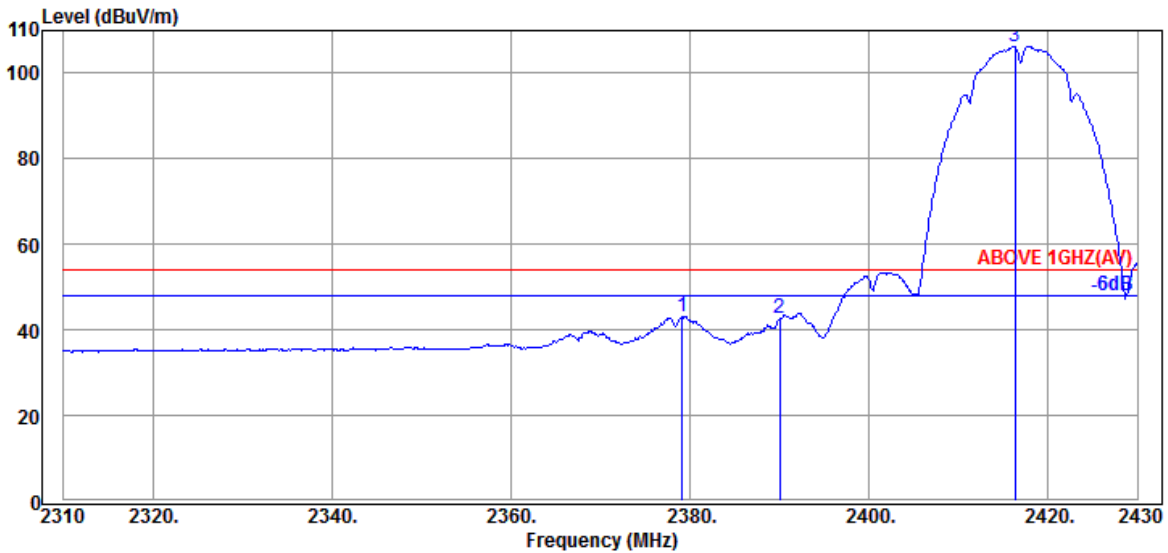

Antenna at Vertical Polarization

Emission Frequency (MHz)	Antenna Factor (dB/m)	Cable Loss (dB)	Preamplifier Gain (dB)	Read Level (dBμV)	Emission Level (dBμV/m)	Limits (dBμV/m)	Margin (dB)	Detector
2379.120	32.41	7.95	34.58	37.29	43.07	54.00	10.93	Average
2390.040	32.44	7.95	34.58	36.88	42.69	54.00	11.31	Average
@ 2416.320	32.36	7.96	34.59	100.65	106.38	---	---	Average

Remark: The “@” means fundamental frequency, it is ignored in this section.

Mode	802.11b	Frequency	TX 2457MHz
------	---------	-----------	------------

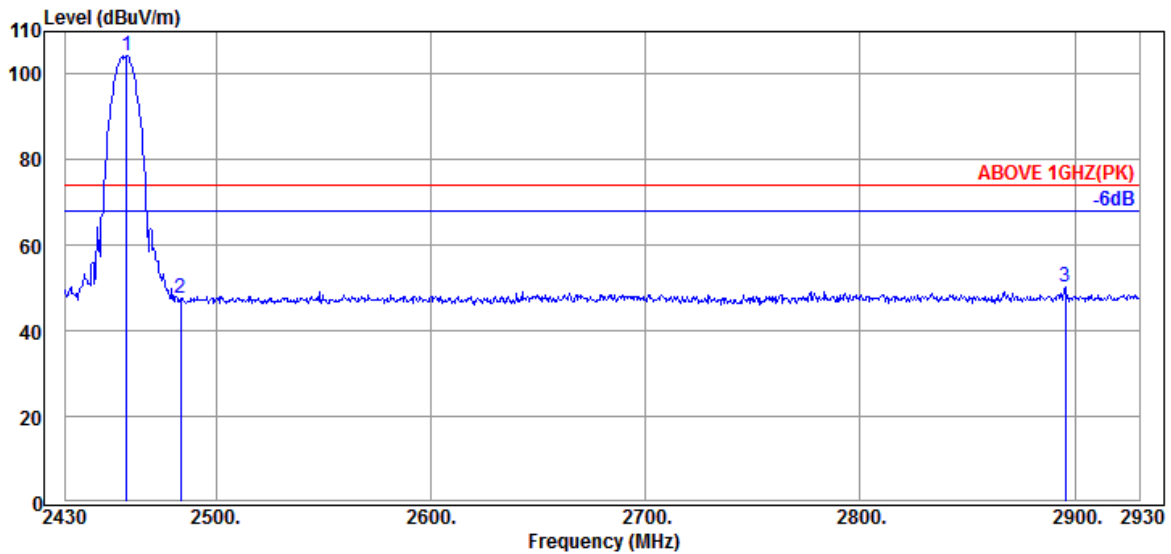

Antenna at Horizontal Polarization

Emission Frequency (MHz)	Antenna Factor (dB/m)	Cable Loss (dB)	Preamplifier Gain (dB)	Read Level (dBμV)	Emission Level (dBμV/m)	Limits (dBμV/m)	Margin (dB)	Detector
@ 2458.500	32.03	7.98	34.60	98.82	104.23	---	---	Peak
2483.500	32.14	7.99	34.61	42.12	47.64	74.00	26.36	Peak
2895.500	32.80	8.17	34.68	43.80	50.09	74.00	23.91	Peak

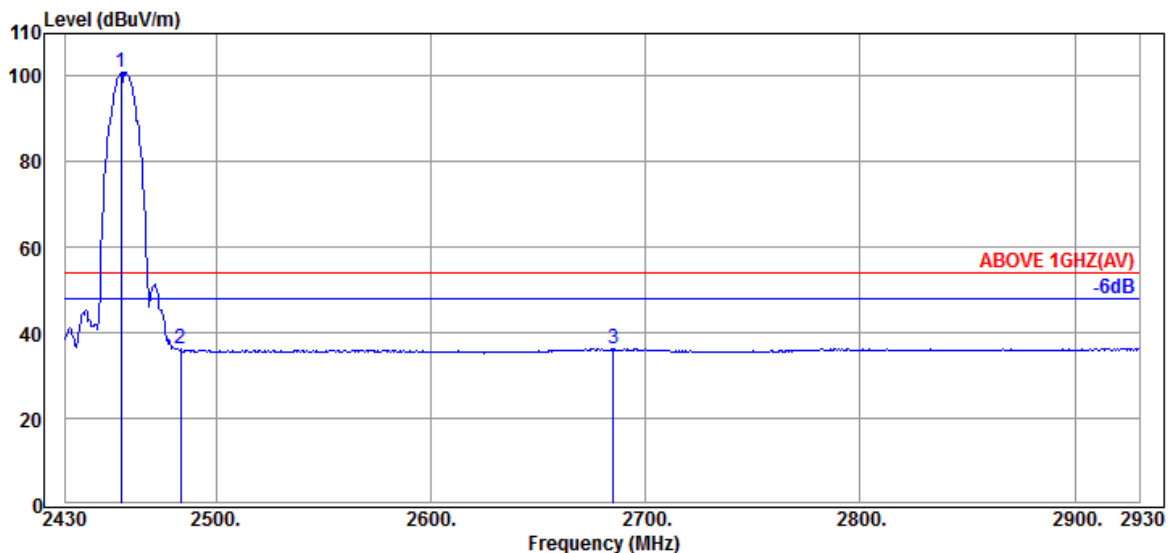

Antenna at Horizontal Polarization

Emission Frequency (MHz)	Antenna Factor (dB/m)	Cable Loss (dB)	Preamplifier Gain (dB)	Read Level (dBμV)	Emission Level (dBμV/m)	Limits (dBμV/m)	Margin (dB)	Detector
@ 2456.000	32.03	7.98	34.60	95.69	101.10	---	---	Average
2483.500	32.14	7.99	34.61	30.64	36.16	54.00	17.84	Average
2685.000	32.34	8.09	34.64	30.56	36.35	54.00	17.65	Average

Remark: The "@" means fundamental frequency, it is ignored in this section.

Mode	802.11b	Frequency	TX 2457MHz
------	---------	-----------	------------

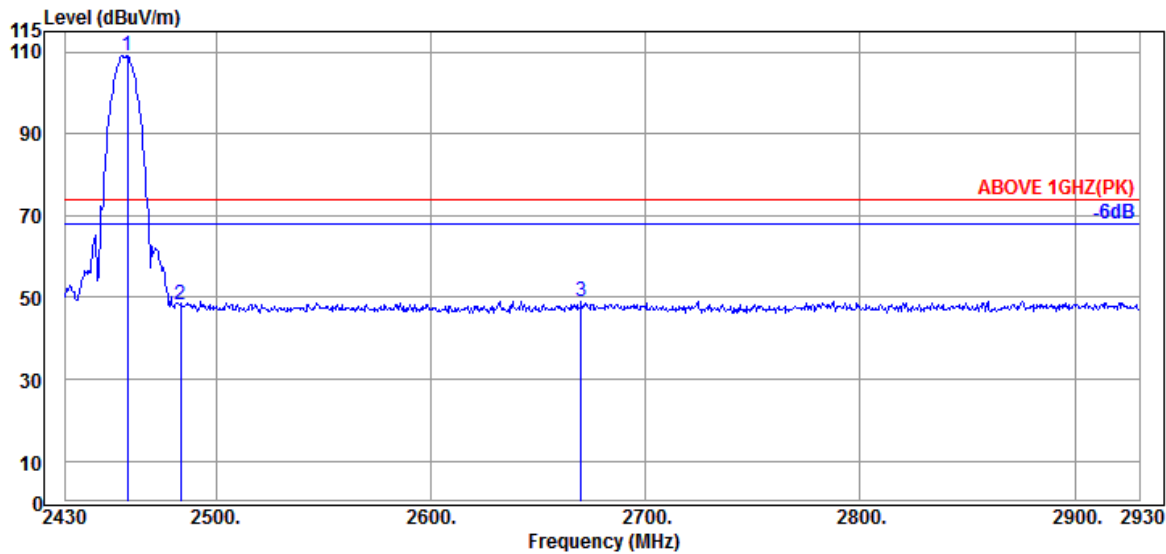

Antenna at Vertical Polarization

Emission Frequency (MHz)	Antenna Factor (dB/m)	Cable Loss (dB)	Preamplifier Gain (dB)	Read Level (dBμV)	Emission Level (dBμV/m)	Limits (dBμV/m)	Margin (dB)	Detector
@ 2459.000	32.03	7.98	34.60	103.59	109.00	---	---	Peak
2483.500	32.14	7.99	34.61	42.79	48.31	74.00	25.69	Peak
2670.000	32.29	8.08	34.64	43.42	49.15	74.00	24.85	Peak

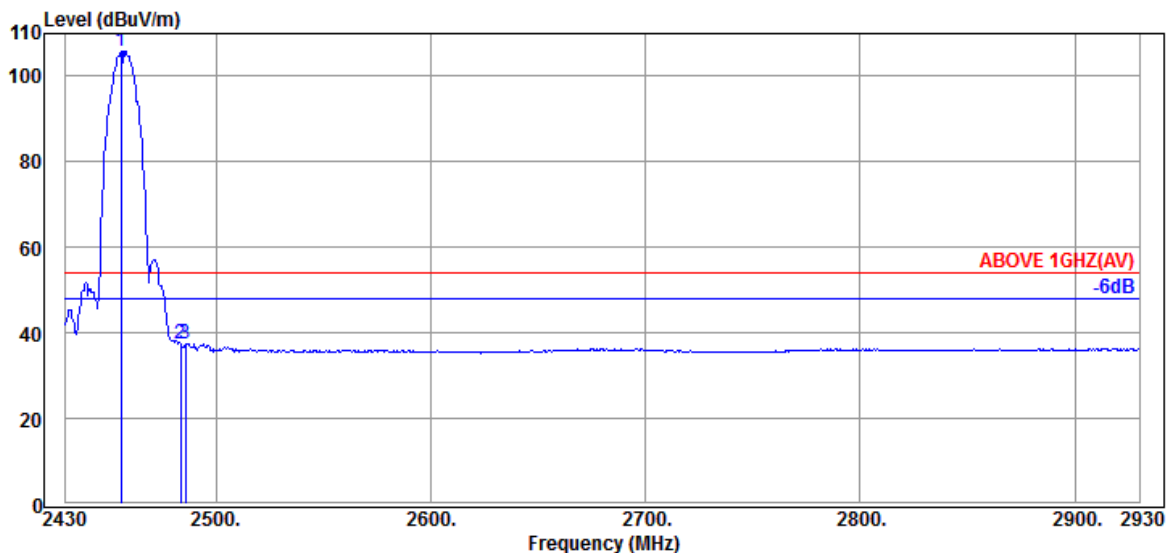

Antenna at Vertical Polarization

Emission Frequency (MHz)	Antenna Factor (dB/m)	Cable Loss (dB)	Preamplifier Gain (dB)	Read Level (dBμV)	Emission Level (dBμV/m)	Limits (dBμV/m)	Margin (dB)	Detector
@ 2456.000	32.03	7.98	34.60	100.44	105.85	---	---	Average
2483.500	32.14	7.99	34.61	31.94	37.46	54.00	16.54	Average
2486.000	32.14	8.00	34.61	32.01	37.54	54.00	16.46	Average

Remark: The "@" means fundamental frequency, it is ignored in this section.

Mode	802.11b	Frequency	TX 2462MHz
------	---------	-----------	------------

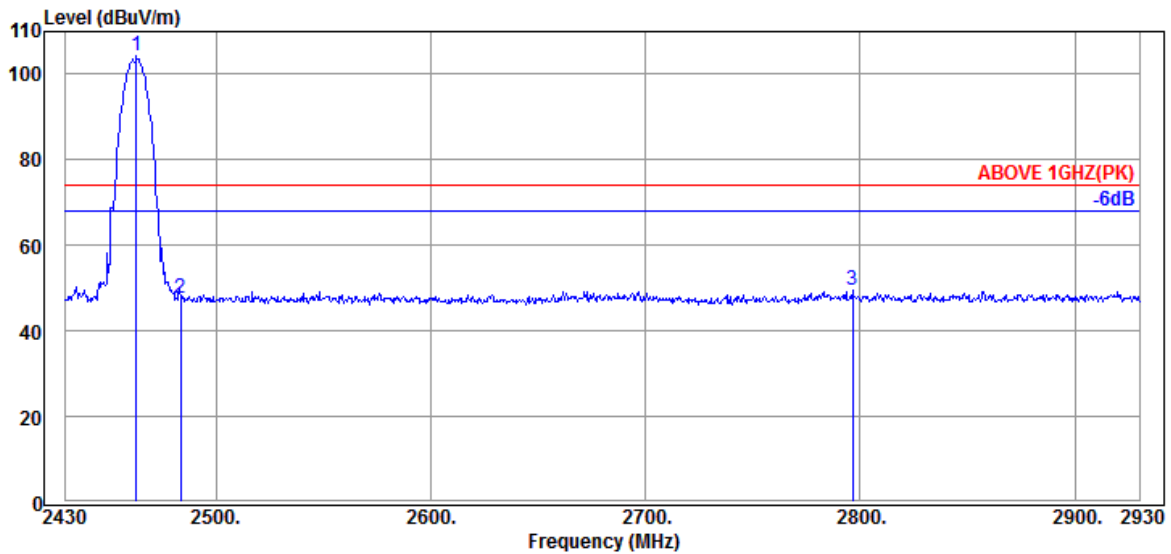

Antenna at Horizontal Polarization

Emission Frequency (MHz)	Antenna Factor (dB/m)	Cable Loss (dB)	Preamplifier Gain (dB)	Read Level (dBμV)	Emission Level (dBμV/m)	Limits (dBμV/m)	Margin (dB)	Detector
@ 2463.000	32.06	7.98	34.60	98.95	104.39	---	---	Peak
2483.500	32.14	7.99	34.61	41.95	47.47	74.00	26.53	Peak
2796.500	32.60	8.14	34.67	43.43	49.50	74.00	24.50	Peak

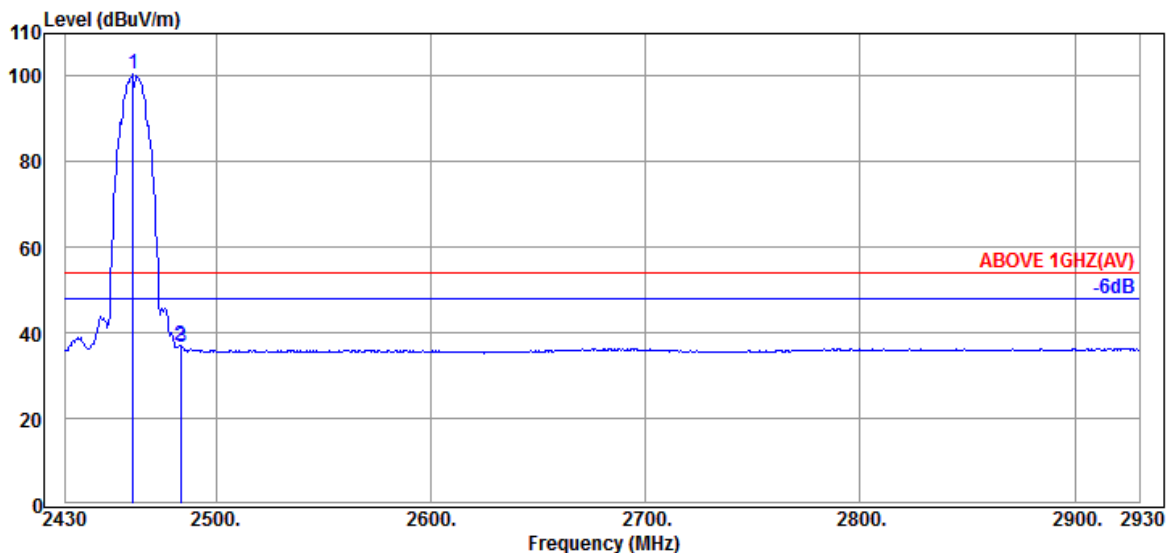

Antenna at Horizontal Polarization

Emission Frequency (MHz)	Antenna Factor (dB/m)	Cable Loss (dB)	Preamplifier Gain (dB)	Read Level (dBμV)	Emission Level (dBμV/m)	Limits (dBμV/m)	Margin (dB)	Detector
@ 2461.500	32.06	7.98	34.60	94.94	100.38	---	---	Average
2483.500	32.14	7.99	34.61	31.58	37.10	54.00	16.90	Average
2484.000	32.14	7.99	34.61	31.16	36.68	54.00	17.32	Average

Remark: The “@” means fundamental frequency, it is ignored in this section.

Mode	802.11b	Frequency	TX 2462MHz
------	---------	-----------	------------

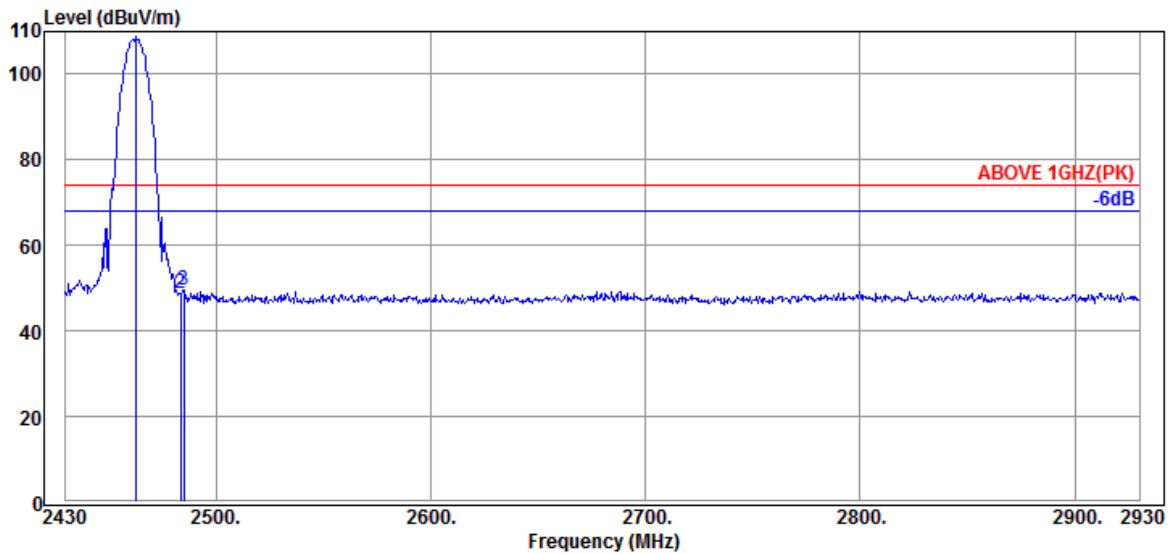

Antenna at Vertical Polarization

Emission Frequency (MHz)	Antenna Factor (dB/m)	Cable Loss (dB)	Preamplifier Gain (dB)	Read Level (dBμV)	Emission Level (dBμV/m)	Limits (dBμV/m)	Margin (dB)	Detector
@ 2462.500	32.06	7.98	34.60	103.52	108.96	---	---	Peak
2483.500	32.14	7.99	34.61	43.18	48.70	74.00	25.30	Peak
2485.000	32.14	7.99	34.61	44.05	49.57	74.00	24.43	Peak

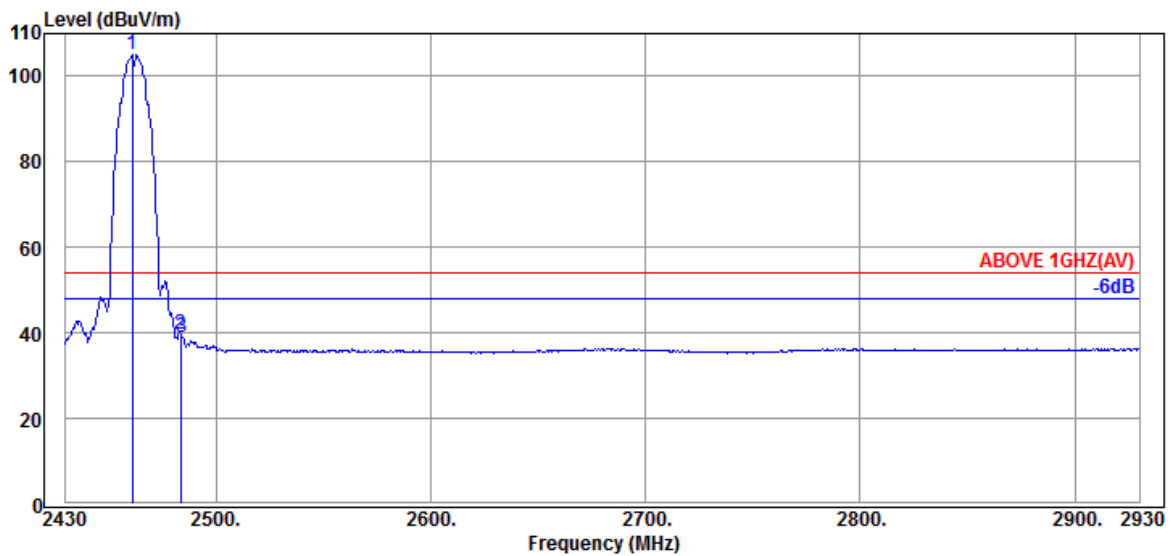

Antenna at Vertical Polarization

Emission Frequency (MHz)	Antenna Factor (dB/m)	Cable Loss (dB)	Preamplifier Gain (dB)	Read Level (dBμV)	Emission Level (dBμV/m)	Limits (dBμV/m)	Margin (dB)	Detector
@ 2461.000	32.06	7.98	34.60	99.63	105.07	---	---	Average
2483.500	32.14	7.99	34.61	34.13	39.65	54.00	14.35	Average
2484.000	32.14	7.99	34.61	33.52	39.04	54.00	14.96	Average

Remark: The "@" means fundamental frequency, it is ignored in this section.

Mode	802.11b	Frequency	TX 2467MHz
------	---------	-----------	------------

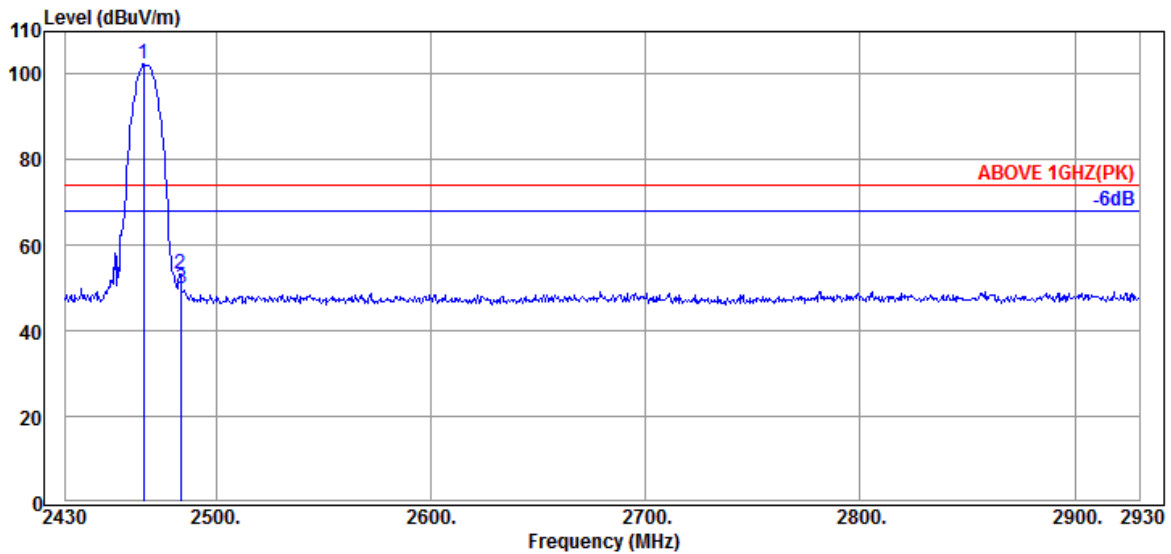

Antenna at Horizontal Polarization

Emission Frequency (MHz)	Antenna Factor (dB/m)	Cable Loss (dB)	Preamplifier Gain (dB)	Read Level (dBμV)	Emission Level (dBμV/m)	Limits (dBμV/m)	Margin (dB)	Detector
@ 2466.500	32.06	7.98	34.60	96.97	102.41	---	---	Peak
2483.500	32.14	7.99	34.61	47.96	53.48	74.00	20.52	Peak
2484.000	32.14	7.99	34.61	44.54	50.06	74.00	23.94	Peak

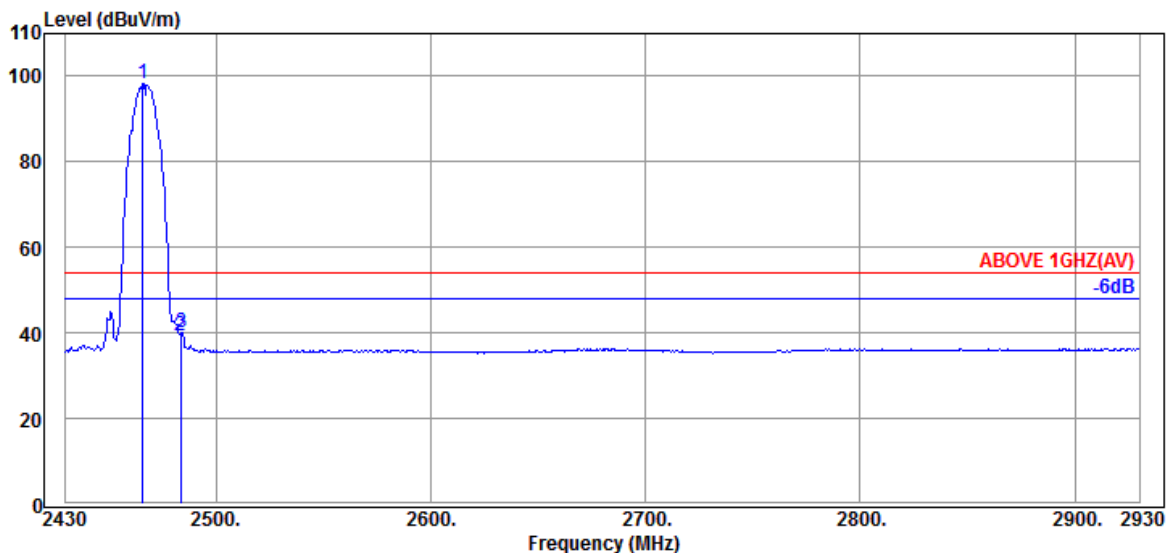

Antenna at Horizontal Polarization

Emission Frequency (MHz)	Antenna Factor (dB/m)	Cable Loss (dB)	Preamplifier Gain (dB)	Read Level (dBμV)	Emission Level (dBμV/m)	Limits (dBμV/m)	Margin (dB)	Detector
@ 2466.000	32.06	7.98	34.60	92.83	98.27	---	---	Average
2483.500	32.14	7.99	34.61	33.79	39.31	54.00	14.69	Average
2484.000	32.14	7.99	34.61	34.61	40.13	54.00	13.87	Average

Remark: The "@" means fundamental frequency, it is ignored in this section.

Mode	802.11b	Frequency	TX 2467MHz
------	---------	-----------	------------

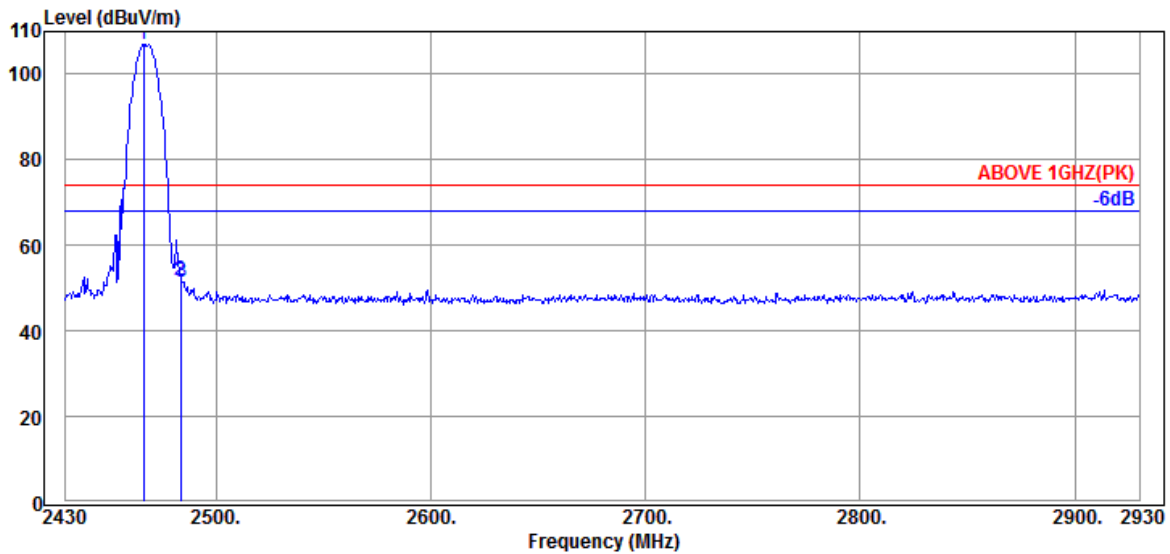

Antenna at Vertical Polarization

Emission Frequency (MHz)	Antenna Factor (dB/m)	Cable Loss (dB)	Preamplifier Gain (dB)	Read Level (dBμV)	Emission Level (dBμV/m)	Limits (dBμV/m)	Margin (dB)	Detector
@ 2466.500	32.06	7.98	34.60	101.62	107.06	---	---	Peak
2483.500	32.14	7.99	34.61	46.28	51.80	74.00	22.20	Peak
2484.000	32.14	7.99	34.61	46.03	51.55	74.00	22.45	Peak

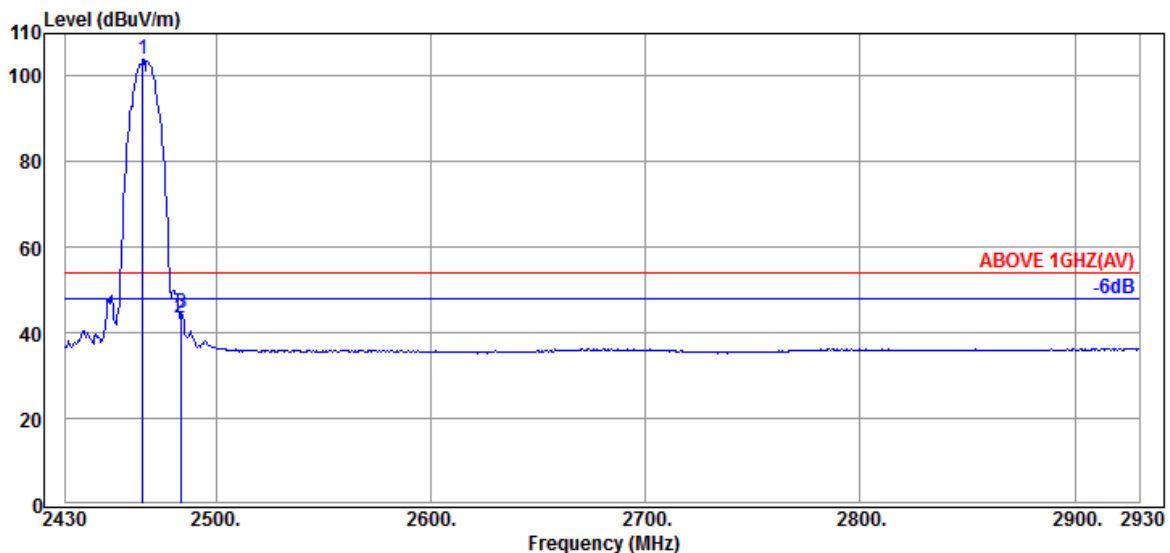

Antenna at Vertical Polarization

Emission Frequency (MHz)	Antenna Factor (dB/m)	Cable Loss (dB)	Preamplifier Gain (dB)	Read Level (dBμV)	Emission Level (dBμV/m)	Limits (dBμV/m)	Margin (dB)	Detector
@ 2466.000	32.06	7.98	34.60	98.54	103.98	---	---	Average
2483.500	32.14	7.99	34.61	37.85	43.37	54.00	10.63	Average
2484.000	32.14	7.99	34.61	39.00	44.52	54.00	9.48	Average

Remark: The "@" means fundamental frequency, it is ignored in this section.

Mode	802.11b	Frequency	TX 2472MHz
------	---------	-----------	------------

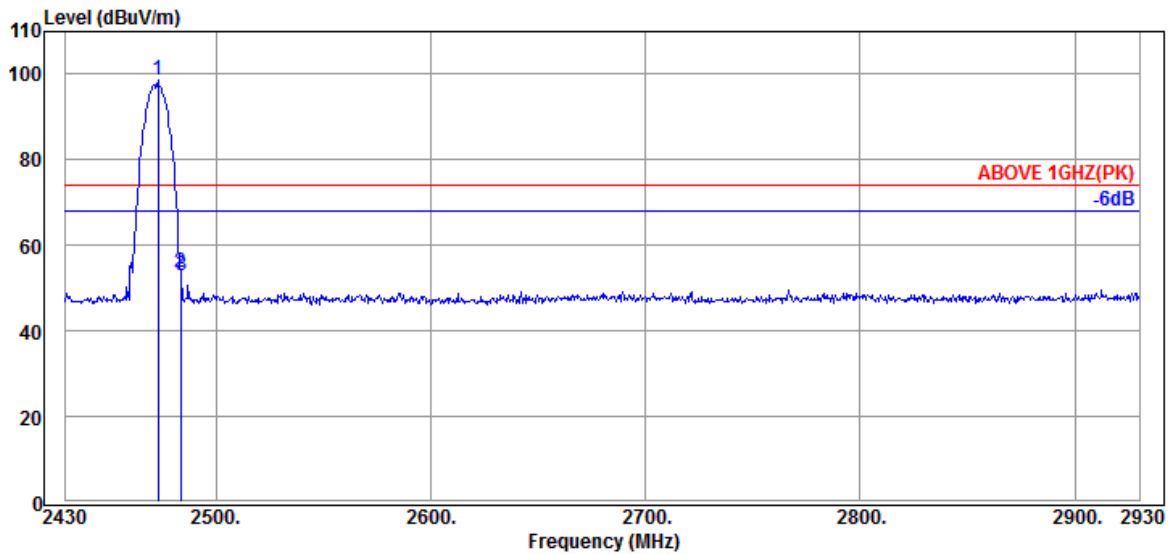

Antenna at Horizontal Polarization

Emission Frequency (MHz)	Antenna Factor (dB/m)	Cable Loss (dB)	Preamplifier Gain (dB)	Read Level (dBμV)	Emission Level (dBμV/m)	Limits (dBμV/m)	Margin (dB)	Detector
@ 2473.000	32.09	7.99	34.60	93.08	98.56	---	---	Peak
2483.500	32.14	7.99	34.61	48.09	53.61	74.00	20.39	Peak
2484.000	32.14	7.99	34.61	47.27	52.79	74.00	21.21	Peak

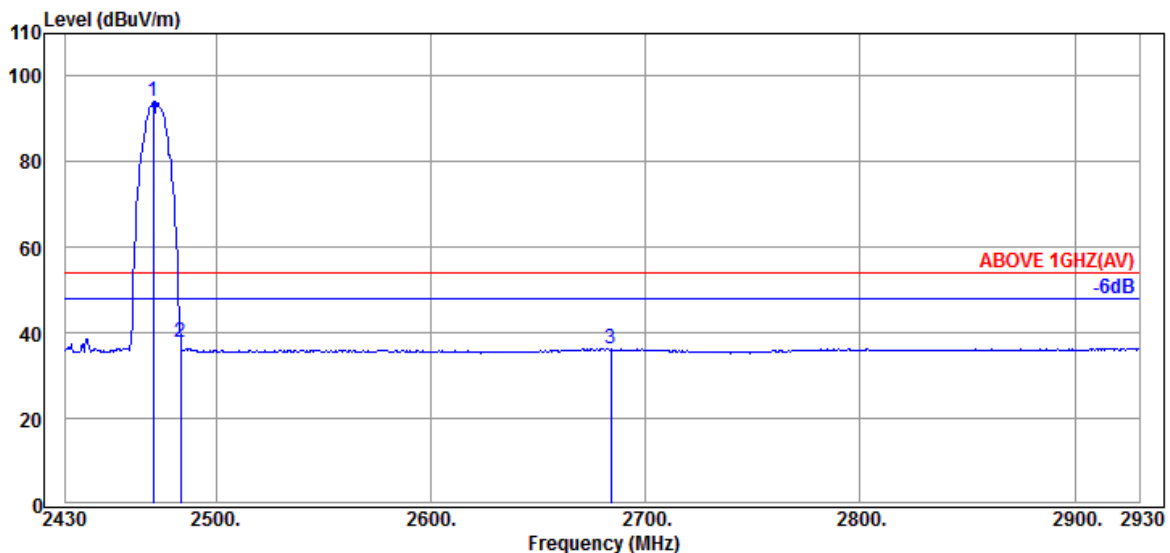

Antenna at Horizontal Polarization

Emission Frequency (MHz)	Antenna Factor (dB/m)	Cable Loss (dB)	Preamplifier Gain (dB)	Read Level (dBμV)	Emission Level (dBμV/m)	Limits (dBμV/m)	Margin (dB)	Detector
@ 2471.000	32.09	7.99	34.60	88.66	94.14	---	---	Average
2483.500	32.14	7.99	34.61	32.15	37.67	54.00	16.33	Average
2684.000	32.34	8.09	34.64	30.63	36.42	54.00	17.58	Average

Remark: The "@" means fundamental frequency, it is ignored in this section.

Mode	802.11b	Frequency	TX 2472MHz
------	---------	-----------	------------

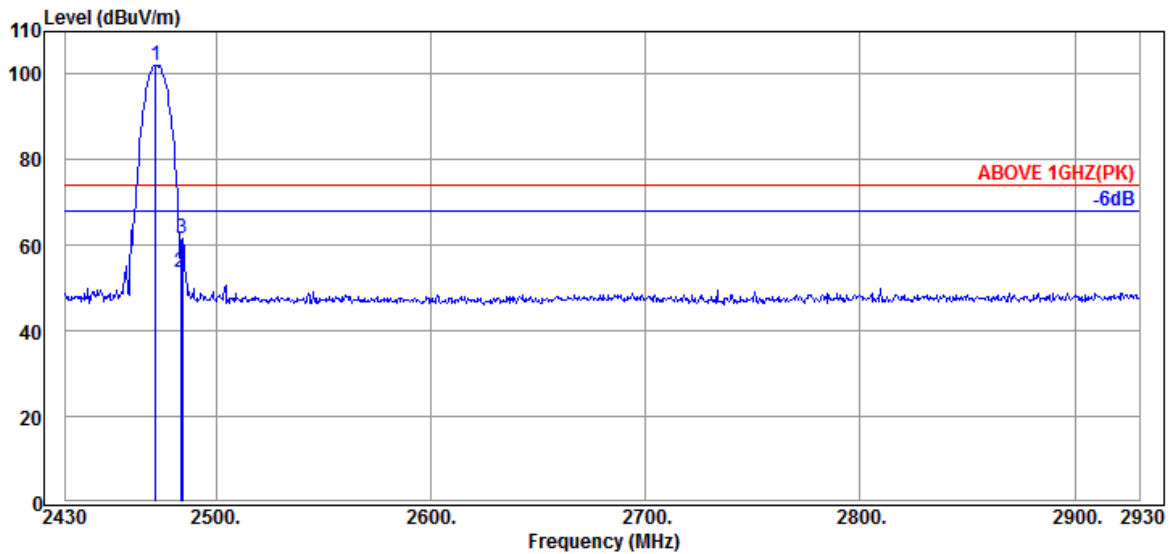

Antenna at Vertical Polarization

Emission Frequency (MHz)	Antenna Factor (dB/m)	Cable Loss (dB)	Preamplifier Gain (dB)	Read Level (dBμV)	Emission Level (dBμV/m)	Limits (dBμV/m)	Margin (dB)	Detector
@ 2472.000	32.09	7.99	34.60	96.63	102.11	---	---	Peak
2483.500	32.14	7.99	34.61	48.26	53.78	74.00	20.22	Peak
2484.500	32.14	7.99	34.61	56.13	61.65	74.00	12.35	Peak

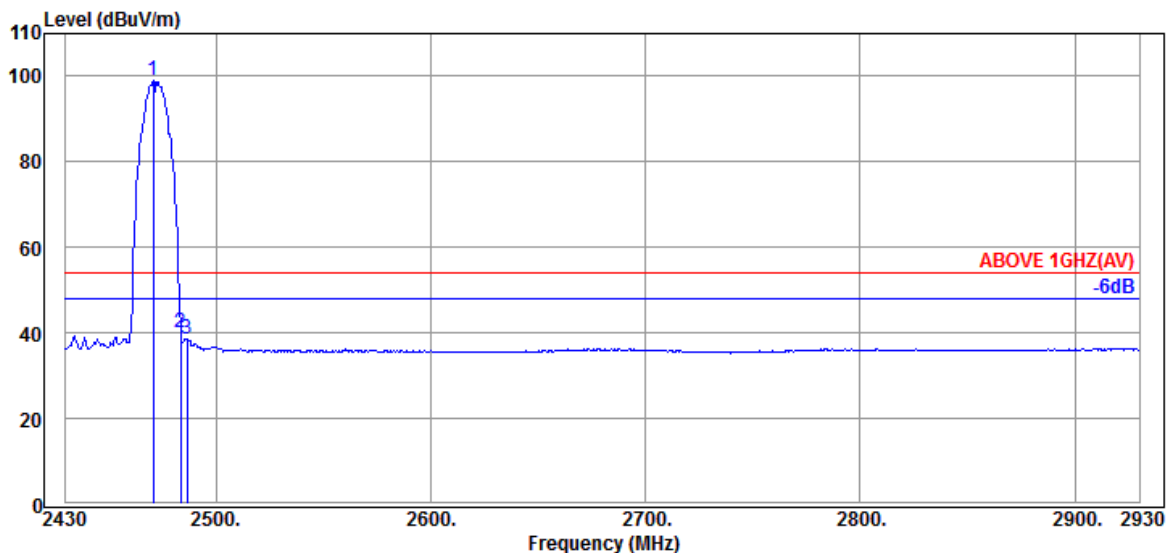

Antenna at Vertical Polarization

Emission Frequency (MHz)	Antenna Factor (dB/m)	Cable Loss (dB)	Preamplifier Gain (dB)	Read Level (dBμV)	Emission Level (dBμV/m)	Limits (dBμV/m)	Margin (dB)	Detector
@ 2471.000	32.09	7.99	34.60	93.38	98.86	---	---	Average
2483.500	32.14	7.99	34.61	34.66	40.18	54.00	13.82	Average
2486.500	32.14	8.00	34.61	33.13	38.66	54.00	15.34	Average

Remark: The "@" means fundamental frequency, it is ignored in this section.

Mode	802.11g	Frequency	TX 2412MHz
------	---------	-----------	------------

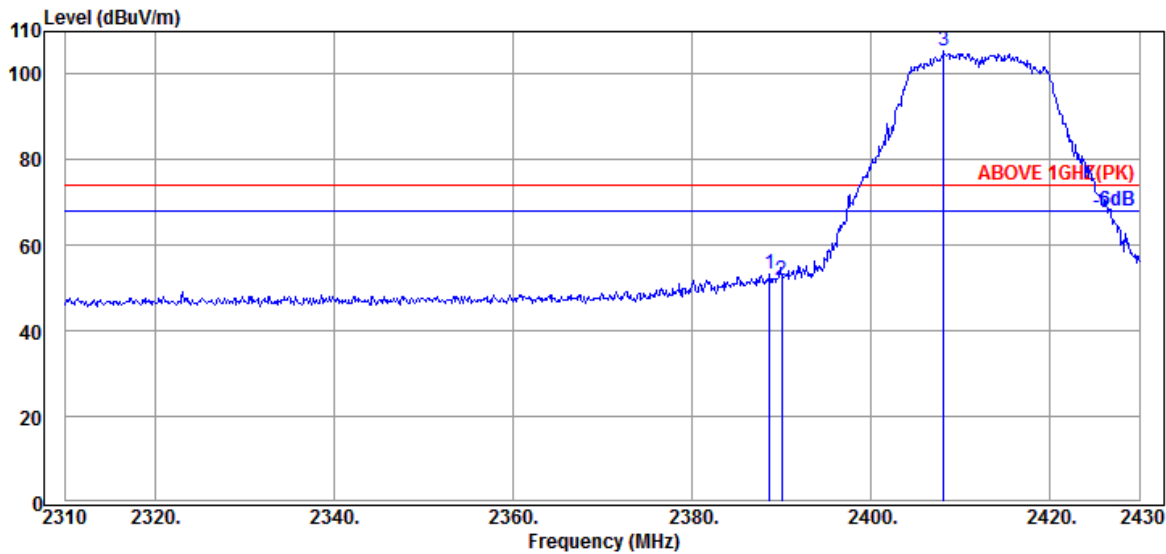

Antenna at Horizontal Polarization

Emission Frequency (MHz)	Antenna Factor (dB/m)	Cable Loss (dB)	Preamplifier Gain (dB)	Read Level (dBμV)	Emission Level (dBμV/m)	Limits (dBμV/m)	Margin (dB)	Detector
2388.720	32.44	7.95	34.58	47.54	53.35	74.00	20.65	Peak
2390.040	32.44	7.95	34.58	45.81	51.62	74.00	22.38	Peak
@ 2408.160	32.43	7.96	34.59	99.69	105.49	---	---	Peak

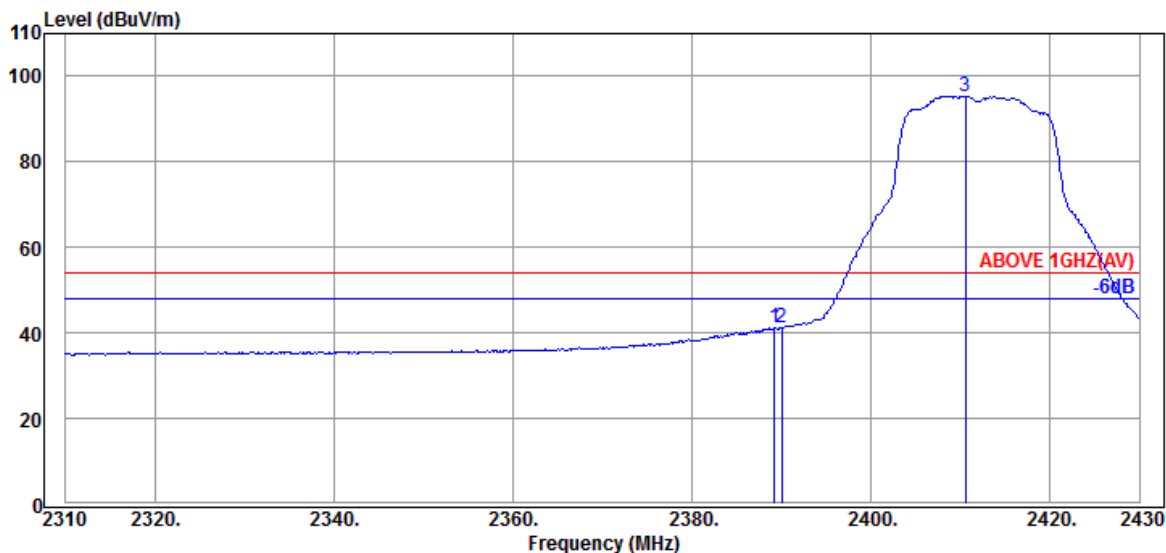

Antenna at Horizontal Polarization

Emission Frequency (MHz)	Antenna Factor (dB/m)	Cable Loss (dB)	Preamplifier Gain (dB)	Read Level (dBμV)	Emission Level (dBμV/m)	Limits (dBμV/m)	Margin (dB)	Detector
2389.200	32.44	7.95	34.58	35.41	41.22	54.00	12.78	Average
2390.040	32.44	7.95	34.58	35.32	41.13	54.00	12.87	Average
@ 2410.560	32.43	7.96	34.59	89.59	95.39	---	---	Average

Remark: The "@" means fundamental frequency, it is ignored in this section.

Mode	802.11g	Frequency	TX 2412MHz
------	---------	-----------	------------

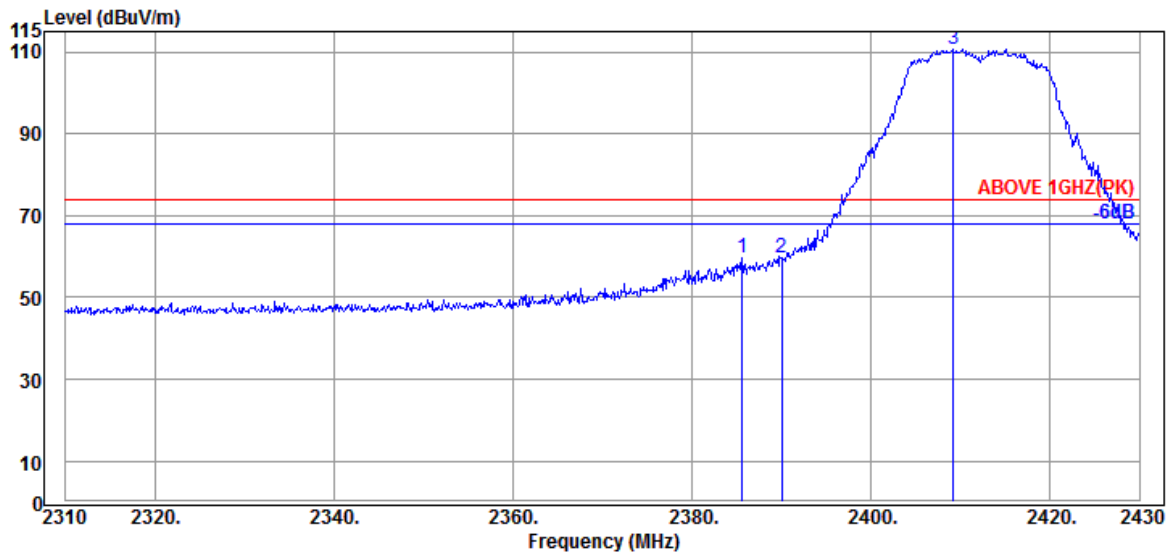

Antenna at Vertical Polarization

Emission Frequency (MHz)	Antenna Factor (dB/m)	Cable Loss (dB)	Preamp Gain (dB)	Read Level (dBμV)	Emission Level (dBμV/m)	Limits (dBμV/m)	Margin (dB)	Detector
2385.600	32.44	7.95	34.58	53.98	59.79	74.00	14.21	Peak
2390.040	32.44	7.95	34.58	54.06	59.87	74.00	14.13	Peak
@ 2409.240	32.43	7.96	34.59	105.02	110.82	---	---	Peak

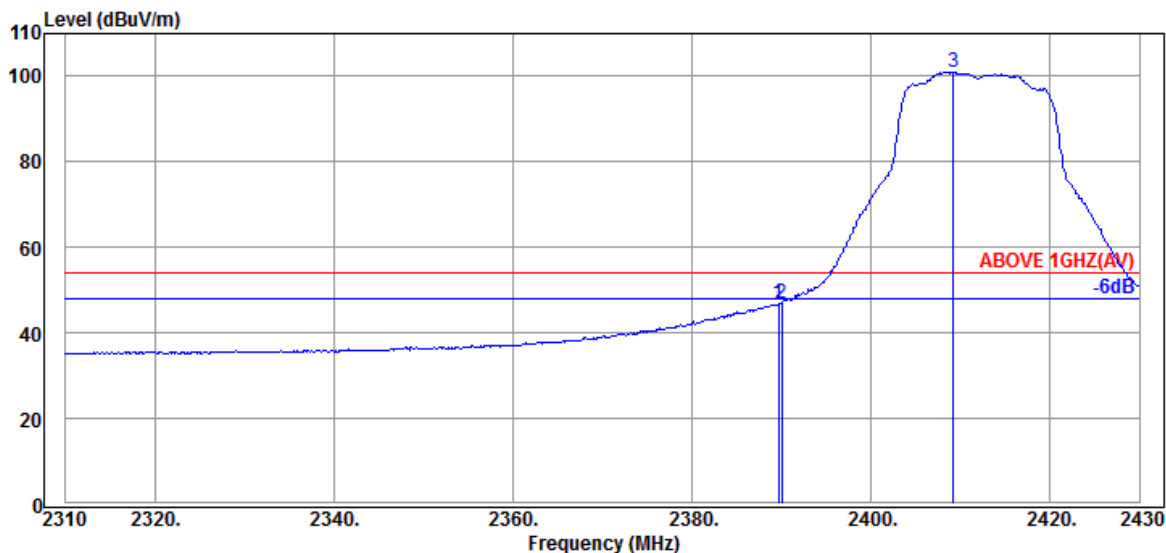

Antenna at Vertical Polarization

Emission Frequency (MHz)	Antenna Factor (dB/m)	Cable Loss (dB)	Preamp Gain (dB)	Read Level (dBμV)	Emission Level (dBμV/m)	Limits (dBμV/m)	Margin (dB)	Detector
2389.680	32.44	7.95	34.58	40.92	46.73	54.00	7.27	Average
2390.040	32.44	7.95	34.58	41.15	46.96	54.00	7.04	Average
@ 2409.240	32.43	7.96	34.59	95.15	100.95	---	---	Average

Remark: The “@” means fundamental frequency, it is ignored in this section.

Mode	802.11g	Frequency	TX 2417MHz
------	---------	-----------	------------

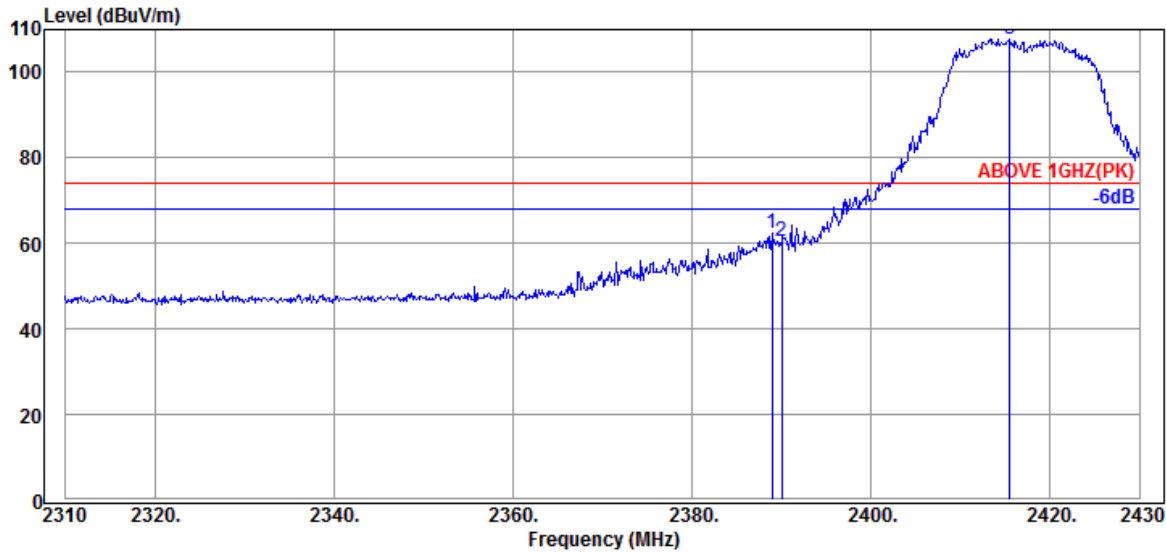

Antenna at Horizontal Polarization

Emission Frequency (MHz)	Antenna Factor (dB/m)	Cable Loss (dB)	Preamplifier Gain (dB)	Read Level (dBμV)	Emission Level (dBμV/m)	Limits (dBμV/m)	Margin (dB)	Detector
2388.960	32.44	7.95	34.58	56.55	62.36	74.00	11.64	Peak
2390.040	32.44	7.95	34.58	54.65	60.46	74.00	13.54	Peak
@ 2415.480	32.36	7.96	34.59	102.07	107.80	---	---	Peak

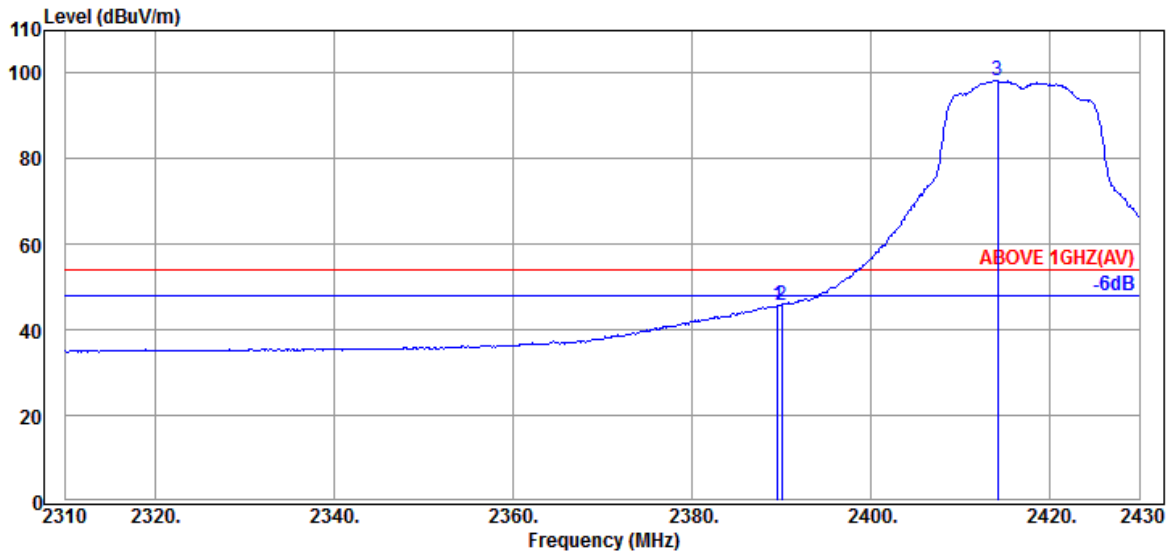

Antenna at Horizontal Polarization

Emission Frequency (MHz)	Antenna Factor (dB/m)	Cable Loss (dB)	Preamplifier Gain (dB)	Read Level (dBμV)	Emission Level (dBμV/m)	Limits (dBμV/m)	Margin (dB)	Detector
2389.560	32.44	7.95	34.58	40.06	45.87	54.00	8.13	Average
2390.040	32.44	7.95	34.58	39.96	45.77	54.00	8.23	Average
@ 2414.160	32.36	7.96	34.59	92.45	98.18	---	---	Average

Remark: The "@" means fundamental frequency, it is ignored in this section.

Mode	802.11g	Frequency	TX 2417MHz
------	---------	-----------	------------

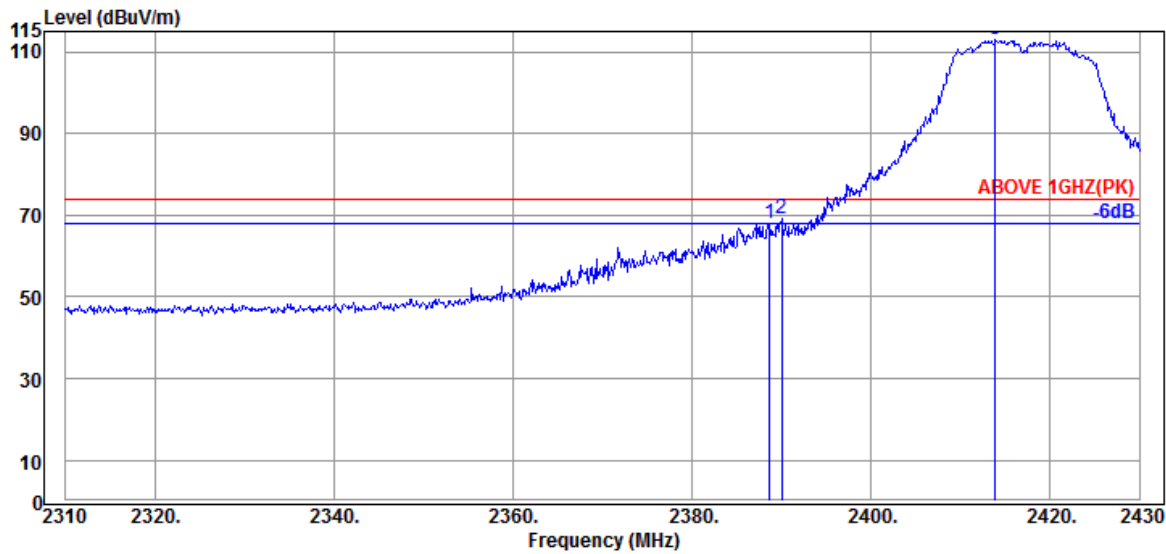

Antenna at Vertical Polarization

Emission Frequency (MHz)	Antenna Factor (dB/m)	Cable Loss (dB)	Preamplifier Gain (dB)	Read Level (dBμV)	Emission Level (dBμV/m)	Limits (dBμV/m)	Margin (dB)	Detector
2388.720	32.44	7.95	34.58	62.18	67.99	74.00	6.01	Peak
2390.040	32.44	7.95	34.58	63.41	69.22	74.00	4.78	Peak
@ 2413.920	32.36	7.96	34.59	107.36	113.09	---	---	Peak

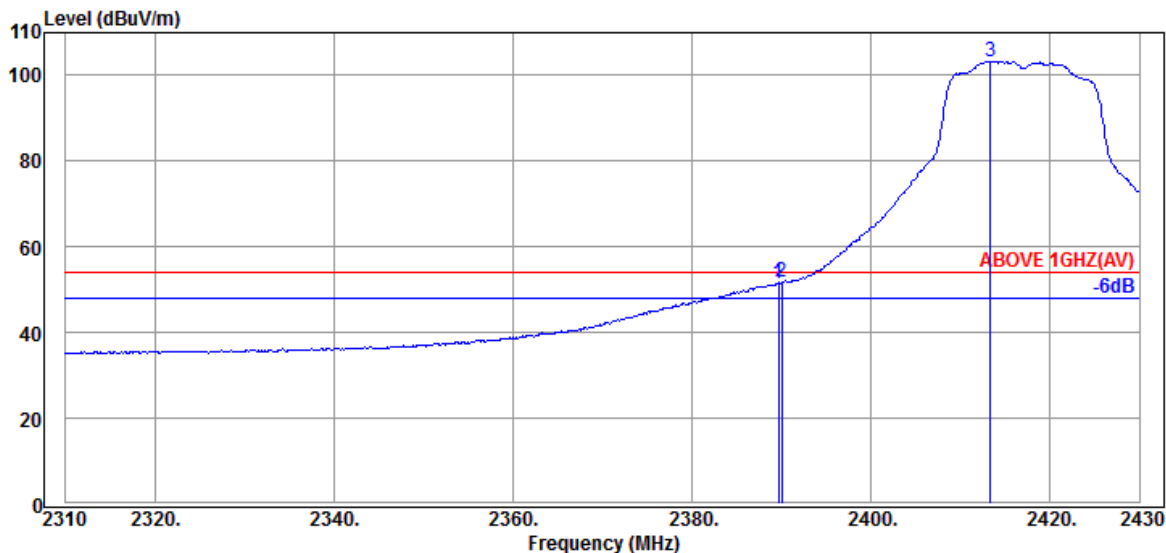

Antenna at Vertical Polarization

Emission Frequency (MHz)	Antenna Factor (dB/m)	Cable Loss (dB)	Preamplifier Gain (dB)	Read Level (dBμV)	Emission Level (dBμV/m)	Limits (dBμV/m)	Margin (dB)	Detector
2389.680	32.44	7.95	34.58	45.76	51.57	54.00	2.43	Average
2390.040	32.44	7.95	34.58	45.82	51.63	54.00	2.37	Average
@ 2413.320	32.36	7.96	34.59	97.58	103.31	---	---	Average

Remark: The “@” means fundamental frequency, it is ignored in this section.

Mode	802.11g	Frequency	TX 2457MHz
------	---------	-----------	------------

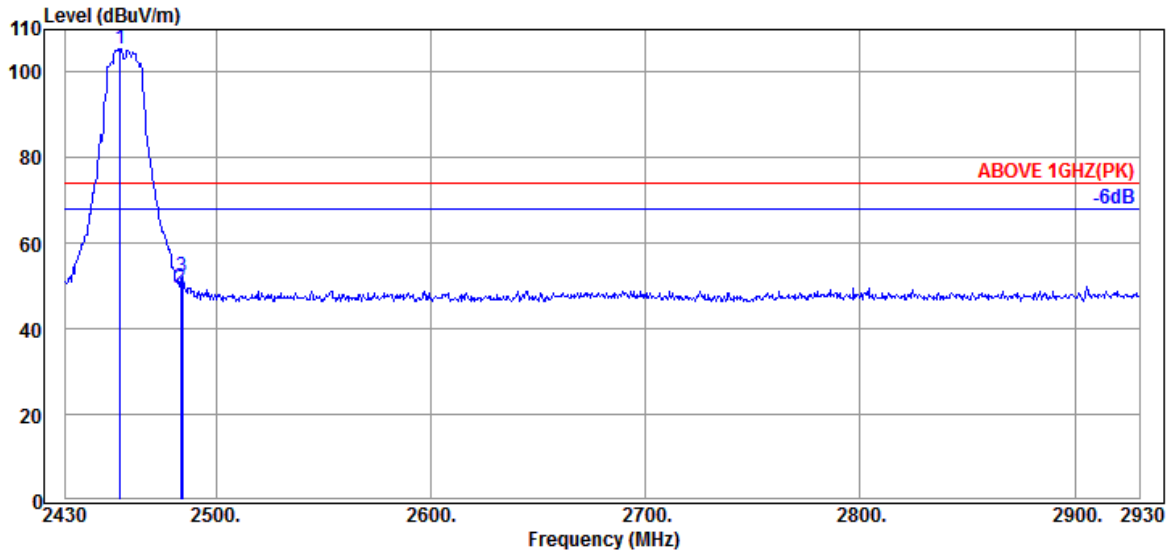

Antenna at Horizontal Polarization

Emission Frequency (MHz)	Antenna Factor (dB/m)	Cable Loss (dB)	Preamplifier Gain (dB)	Read Level (dBμV)	Emission Level (dBμV/m)	Limits (dBμV/m)	Margin (dB)	Detector
@ 2455.500	32.03	7.98	34.60	99.94	105.35	---	---	Peak
2483.500	32.14	7.99	34.61	43.92	49.44	74.00	24.56	Peak
2484.500	32.14	7.99	34.61	46.76	52.28	74.00	21.72	Peak

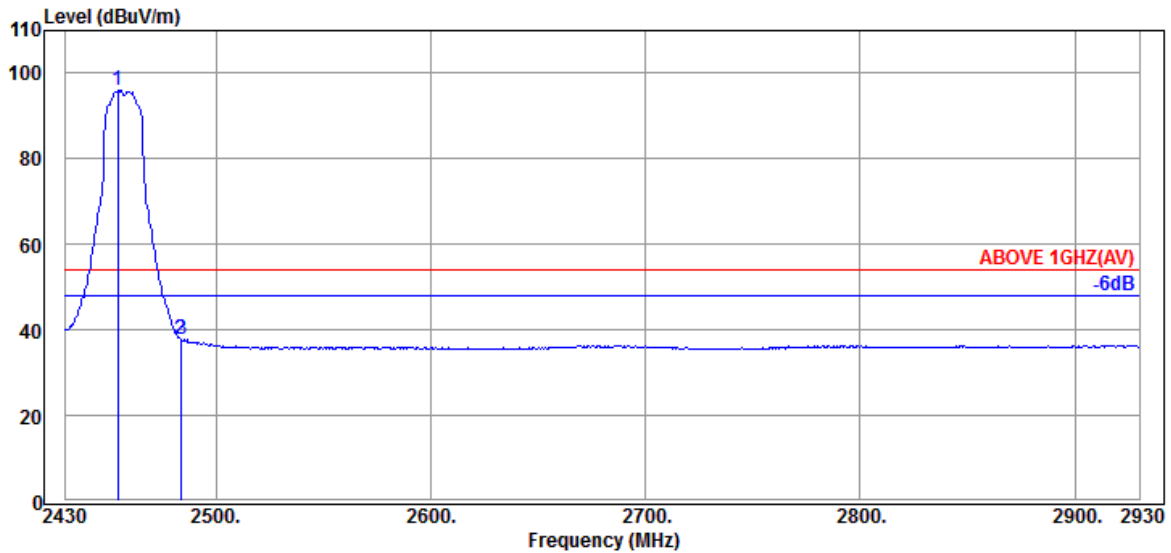

Antenna at Horizontal Polarization

Emission Frequency (MHz)	Antenna Factor (dB/m)	Cable Loss (dB)	Preamplifier Gain (dB)	Read Level (dBμV)	Emission Level (dBμV/m)	Limits (dBμV/m)	Margin (dB)	Detector
@ 2454.500	32.03	7.98	34.60	90.45	95.86	---	---	Average
2483.500	32.14	7.99	34.61	32.36	37.88	54.00	16.12	Average
2484.000	32.14	7.99	34.61	32.15	37.67	54.00	16.33	Average

Remark: The "@" means fundamental frequency, it is ignored in this section.

Mode	802.11g	Frequency	TX 2457MHz
------	---------	-----------	------------

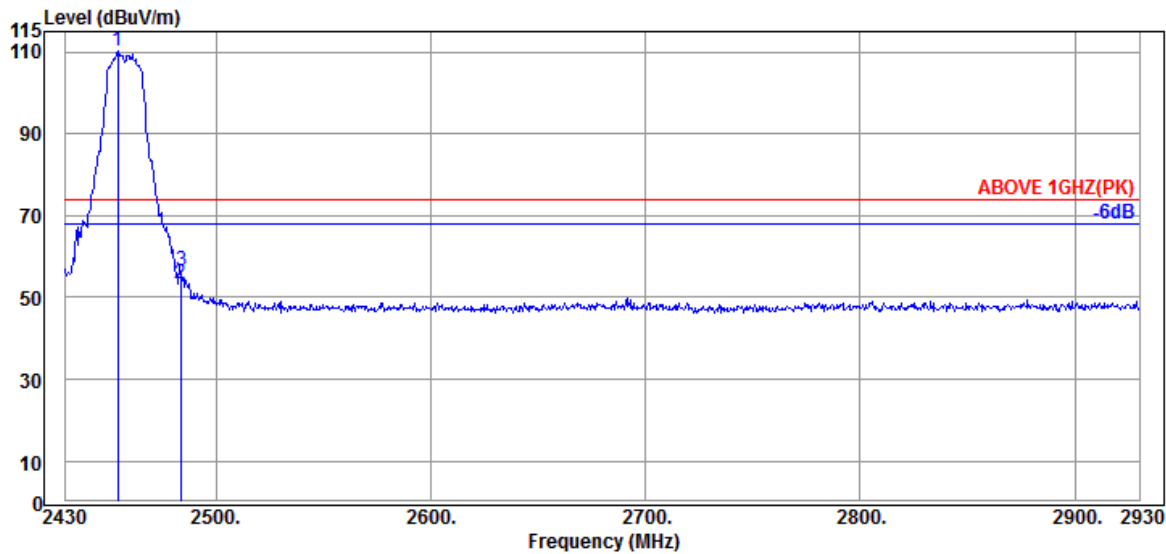

Antenna at Vertical Polarization

Emission Frequency (MHz)	Antenna Factor (dB/m)	Cable Loss (dB)	Preamplifier Gain (dB)	Read Level (dBμV)	Emission Level (dBμV/m)	Limits (dBμV/m)	Margin (dB)	Detector
@ 2454.500	32.03	7.98	34.60	104.70	110.11	---	---	Peak
2483.500	32.14	7.99	34.61	47.73	53.25	74.00	20.75	Peak
2484.000	32.14	7.99	34.61	51.05	56.57	74.00	17.43	Peak

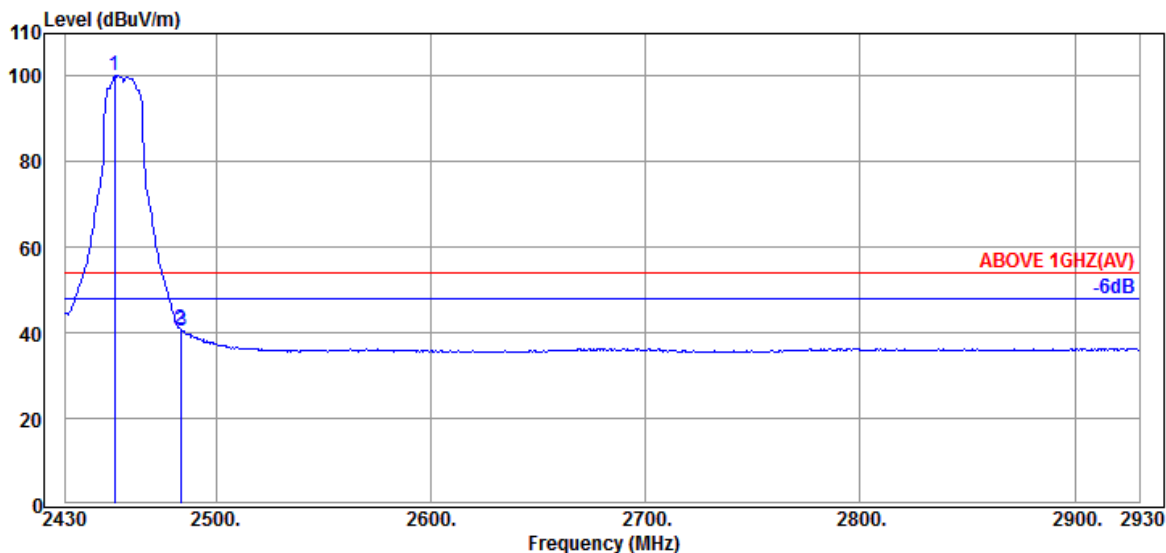

Antenna at Vertical Polarization

Emission Frequency (MHz)	Antenna Factor (dB/m)	Cable Loss (dB)	Preamplifier Gain (dB)	Read Level (dBμV)	Emission Level (dBμV/m)	Limits (dBμV/m)	Margin (dB)	Detector
@ 2453.000	32.00	7.98	34.60	94.92	100.30	---	---	Average
2483.500	32.14	7.99	34.61	35.22	40.74	54.00	13.26	Average
2484.000	32.14	7.99	34.61	34.98	40.50	54.00	13.50	Average

Remark: The "@" means fundamental frequency, it is ignored in this section.

Mode	802.11g	Frequency	TX 2462MHz
------	---------	-----------	------------

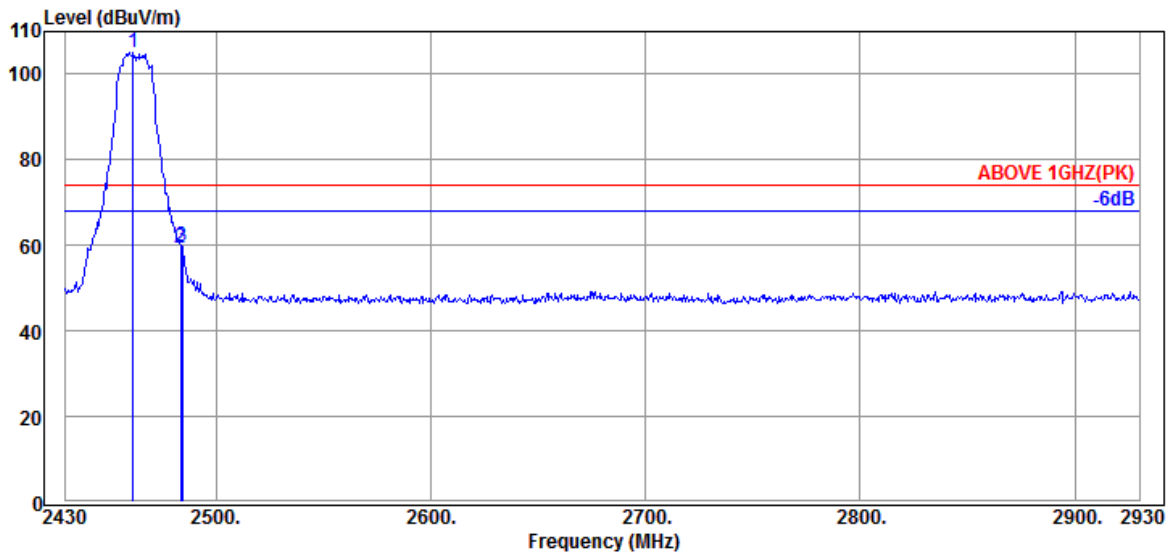

Antenna at Horizontal Polarization

Emission Frequency (MHz)	Antenna Factor (dB/m)	Cable Loss (dB)	Preamplifier Gain (dB)	Read Level (dBμV)	Emission Level (dBμV/m)	Limits (dBμV/m)	Margin (dB)	Detector
@ 2461.500	32.06	7.98	34.60	99.51	104.95	---	---	Peak
2483.500	32.14	7.99	34.61	53.78	59.30	74.00	14.70	Peak
2484.500	32.14	7.99	34.61	54.39	59.91	74.00	14.09	Peak

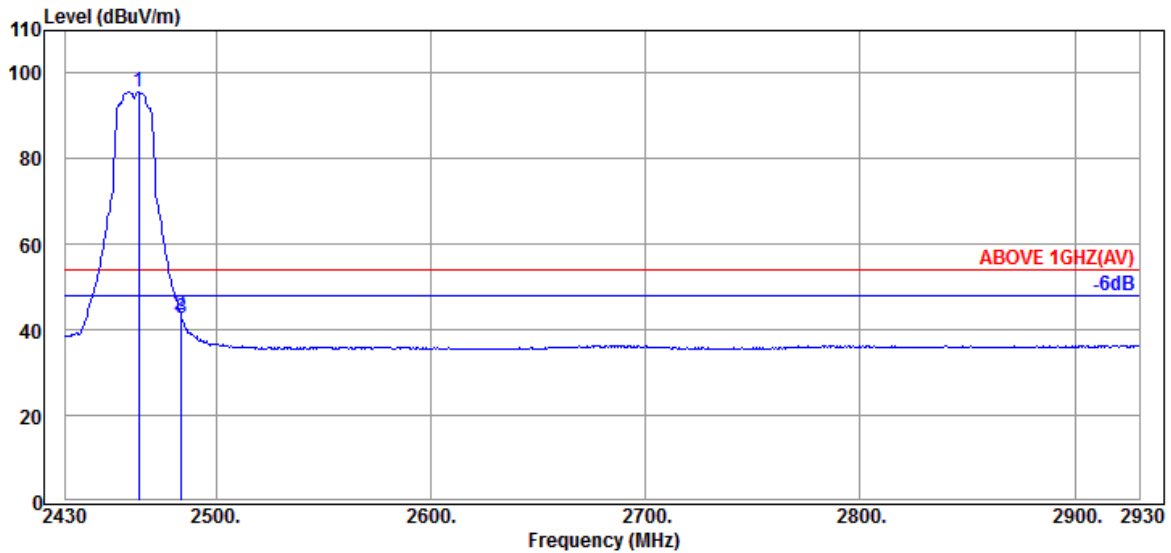

Antenna at Horizontal Polarization

Emission Frequency (MHz)	Antenna Factor (dB/m)	Cable Loss (dB)	Preamplifier Gain (dB)	Read Level (dBμV)	Emission Level (dBμV/m)	Limits (dBμV/m)	Margin (dB)	Detector
@ 2464.000	32.06	7.98	34.60	90.24	95.68	---	---	Average
2483.500	32.14	7.99	34.61	37.90	43.42	54.00	10.58	Average
2484.000	32.14	7.99	34.61	37.24	42.76	54.00	11.24	Average

Remark: The "@" means fundamental frequency, it is ignored in this section.

Mode	802.11g	Frequency	TX 2462MHz
------	---------	-----------	------------

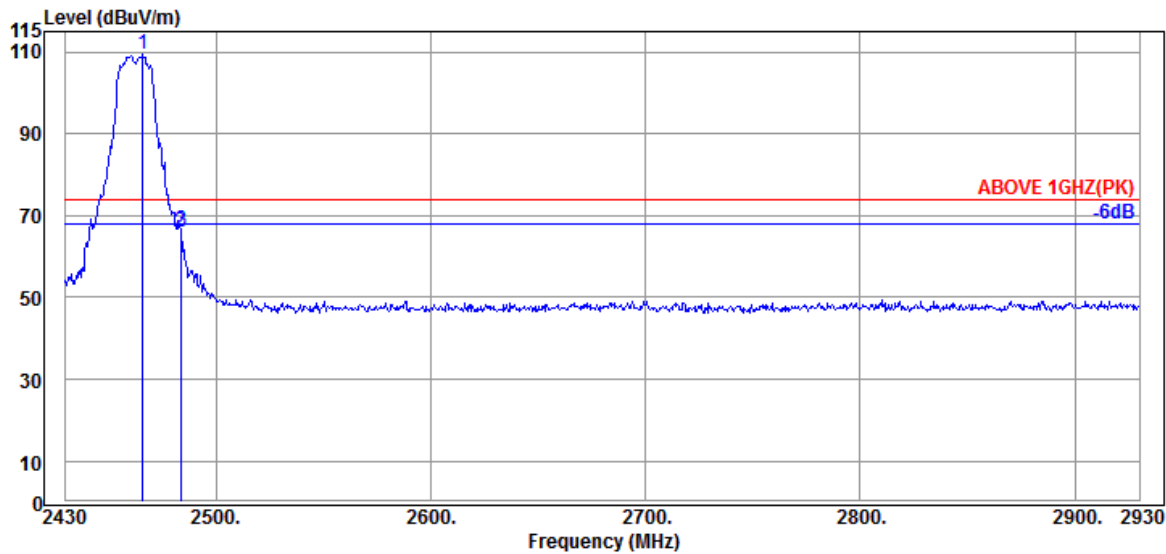

Antenna at Vertical Polarization

Emission Frequency (MHz)	Antenna Factor (dB/m)	Cable Loss (dB)	Preamplifier Gain (dB)	Read Level (dBμV)	Emission Level (dBμV/m)	Limits (dBμV/m)	Margin (dB)	Detector
@ 2466.000	32.06	7.98	34.60	104.00	109.44	---	---	Peak
2483.500	32.14	7.99	34.61	60.59	66.11	74.00	7.89	Peak
2484.000	32.14	7.99	34.61	60.69	66.21	74.00	7.79	Peak

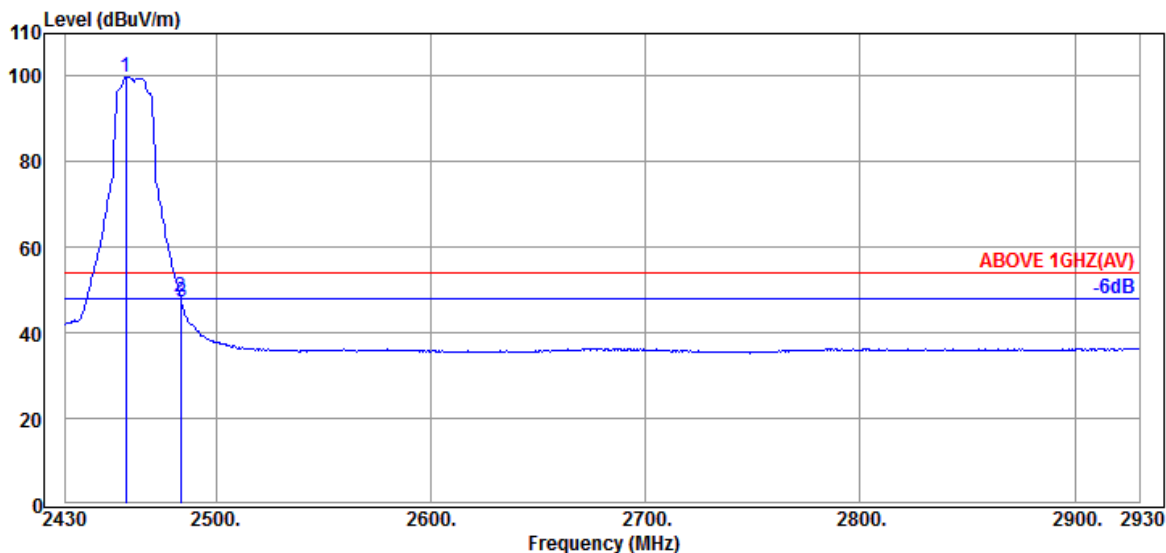

Antenna at Vertical Polarization

Emission Frequency (MHz)	Antenna Factor (dB/m)	Cable Loss (dB)	Preamplifier Gain (dB)	Read Level (dBμV)	Emission Level (dBμV/m)	Limits (dBμV/m)	Margin (dB)	Detector
@ 2458.000	32.03	7.98	34.60	94.39	99.80	---	---	Average
2483.500	32.14	7.99	34.61	42.88	48.40	54.00	5.60	Average
2484.000	32.14	7.99	34.61	41.87	47.39	54.00	6.61	Average

Remark: The “@” means fundamental frequency, it is ignored in this section.

Mode	802.11g	Frequency	TX 2467MHz
------	---------	-----------	------------

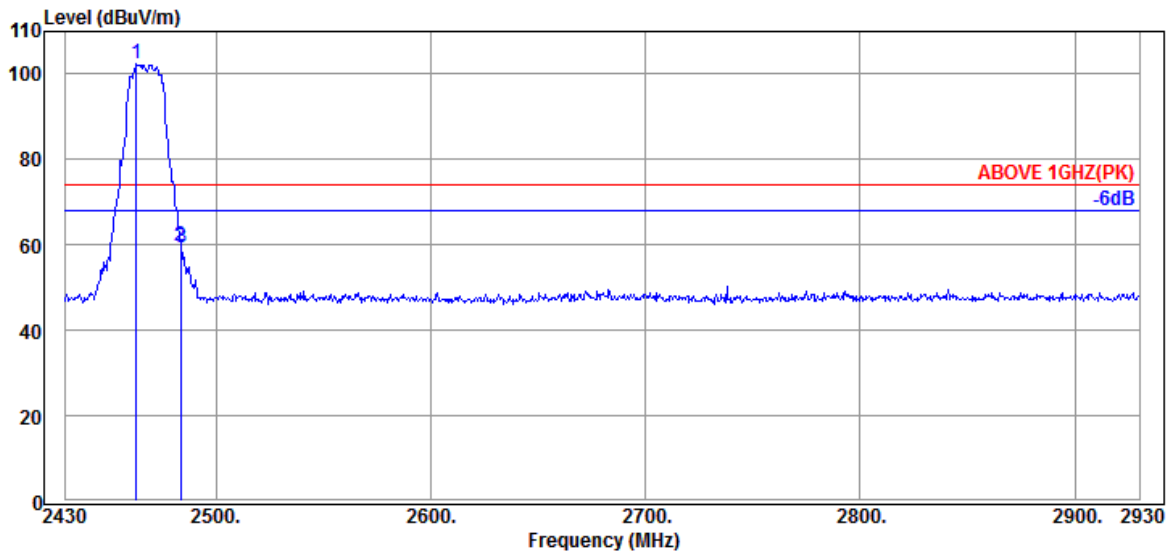

Antenna at Horizontal Polarization

Emission Frequency (MHz)	Antenna Factor (dB/m)	Cable Loss (dB)	Preamplifier Gain (dB)	Read Level (dBμV)	Emission Level (dBμV/m)	Limits (dBμV/m)	Margin (dB)	Detector
@ 2463.000	32.06	7.98	34.60	97.07	102.51	---	---	Peak
2483.500	32.14	7.99	34.61	54.03	59.55	74.00	14.45	Peak
2484.000	32.14	7.99	34.61	53.94	59.46	74.00	14.54	Peak

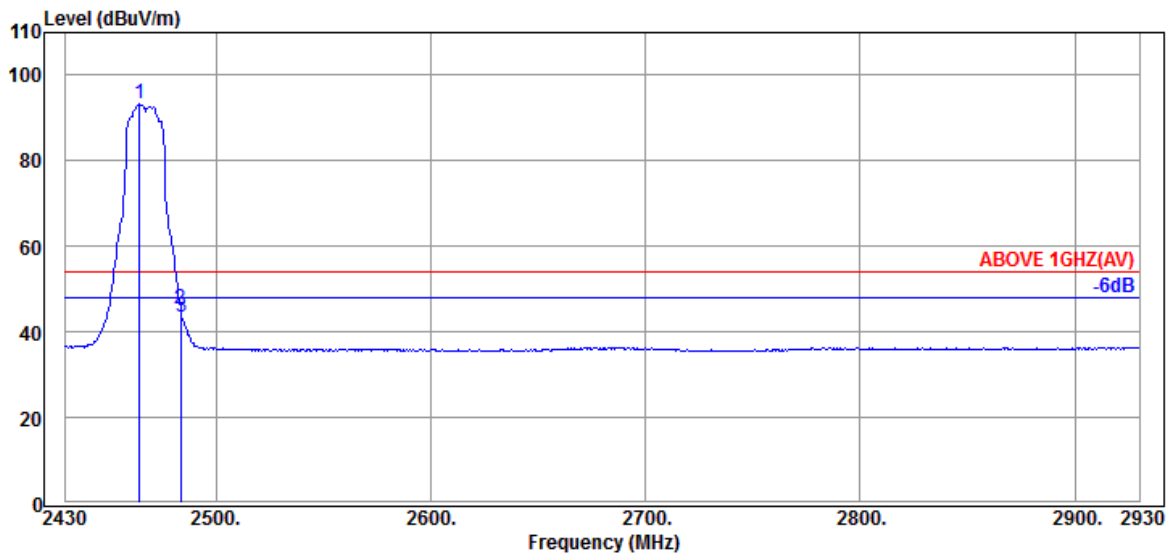

Antenna at Horizontal Polarization

Emission Frequency (MHz)	Antenna Factor (dB/m)	Cable Loss (dB)	Preamplifier Gain (dB)	Read Level (dBμV)	Emission Level (dBμV/m)	Limits (dBμV/m)	Margin (dB)	Detector
@ 2464.500	32.06	7.98	34.60	87.81	93.25	---	---	Average
2483.500	32.14	7.99	34.61	39.87	45.39	54.00	8.61	Average
2484.000	32.14	7.99	34.61	38.08	43.60	54.00	10.40	Average

Remark: The “@” means fundamental frequency, it is ignored in this section.

Mode	802.11g	Frequency	TX 2467MHz
------	---------	-----------	------------

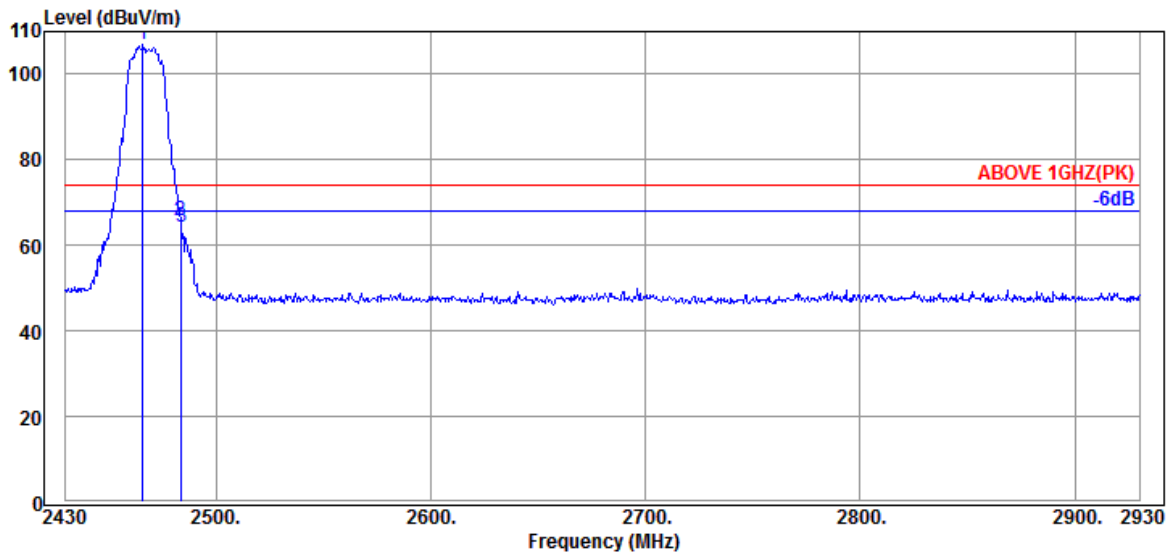

Antenna at Vertical Polarization

Emission Frequency (MHz)	Antenna Factor (dB/m)	Cable Loss (dB)	Preamplifier Gain (dB)	Read Level (dBμV)	Emission Level (dBμV/m)	Limits (dBμV/m)	Margin (dB)	Detector
@ 2466.000	32.06	7.98	34.60	101.39	106.83	---	---	Peak
2483.500	32.14	7.99	34.61	60.14	65.66	74.00	8.34	Peak
2484.000	32.14	7.99	34.61	58.72	64.24	74.00	9.76	Peak

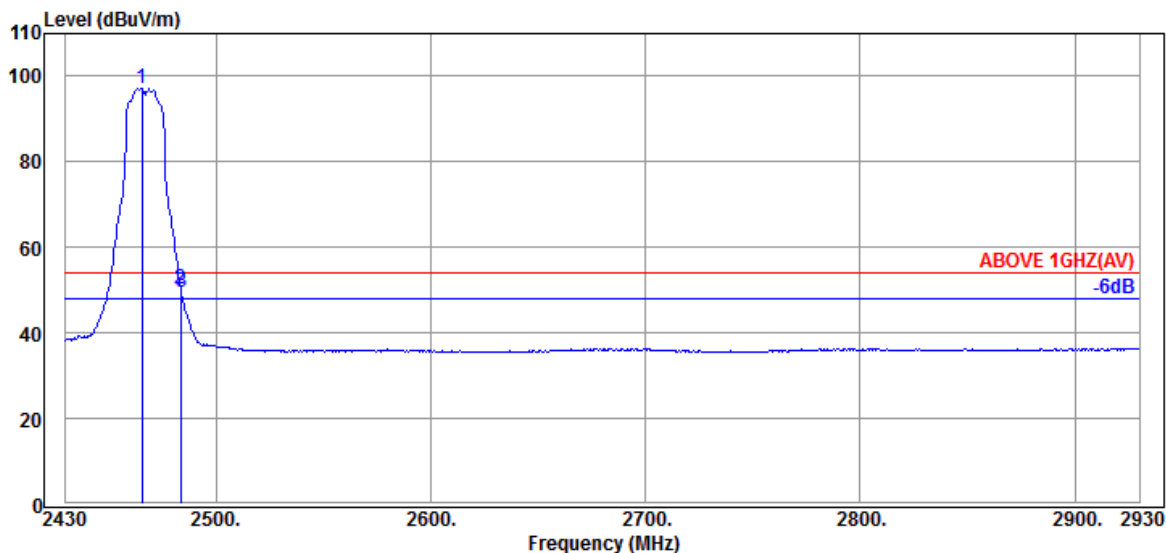

Antenna at Vertical Polarization

Emission Frequency (MHz)	Antenna Factor (dB/m)	Cable Loss (dB)	Preamplifier Gain (dB)	Read Level (dBμV)	Emission Level (dBμV/m)	Limits (dBμV/m)	Margin (dB)	Detector
@ 2465.500	32.06	7.98	34.60	91.65	97.09	---	---	Average
2483.500	32.14	7.99	34.61	44.69	50.21	54.00	3.79	Average
2484.000	32.14	7.99	34.61	43.88	49.40	54.00	4.60	Average

Remark: The "@" means fundamental frequency, it is ignored in this section.

Mode	802.11g	Frequency	TX 2472MHz
------	---------	-----------	------------

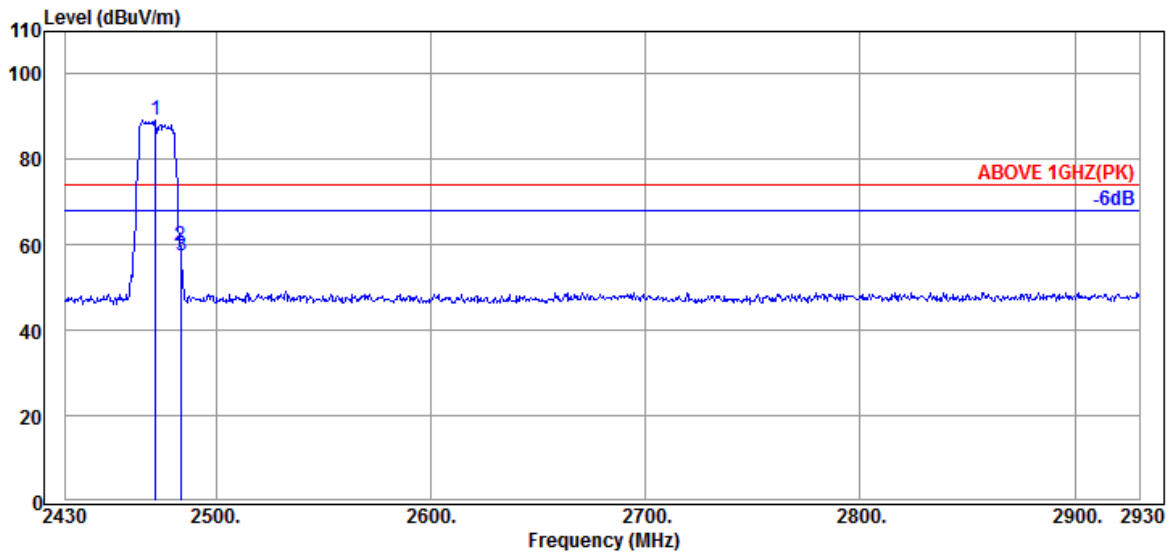

Antenna at Horizontal Polarization

Emission Frequency (MHz)	Antenna Factor (dB/m)	Cable Loss (dB)	Preamplifier Gain (dB)	Read Level (dBμV)	Emission Level (dBμV/m)	Limits (dBμV/m)	Margin (dB)	Detector
@ 2472.000	32.09	7.99	34.60	83.88	89.36	---	---	Peak
2483.500	32.14	7.99	34.61	54.15	59.67	74.00	14.33	Peak
2484.000	32.14	7.99	34.61	51.99	57.51	74.00	16.49	Peak

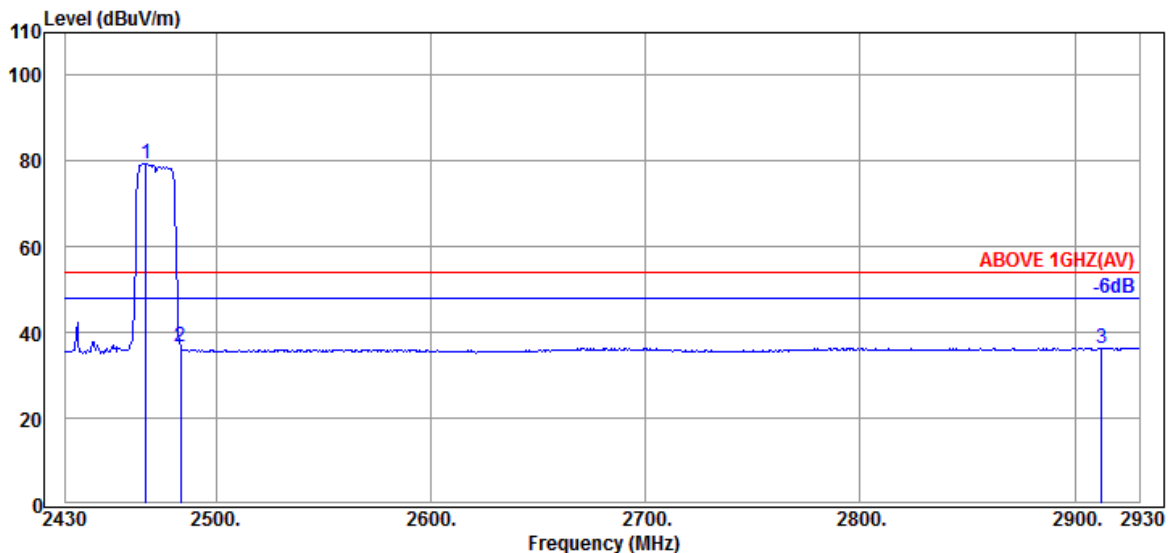

Antenna at Horizontal Polarization

Emission Frequency (MHz)	Antenna Factor (dB/m)	Cable Loss (dB)	Preamplifier Gain (dB)	Read Level (dBμV)	Emission Level (dBμV/m)	Limits (dBμV/m)	Margin (dB)	Detector
@ 2467.500	32.06	7.98	34.60	74.09	79.53	---	---	Average
2483.500	32.14	7.99	34.61	31.15	36.67	54.00	17.33	Average
2912.500	32.87	8.18	34.69	29.99	36.35	54.00	17.65	Average

Remark: The "@" means fundamental frequency, it is ignored in this section.

Mode	802.11g	Frequency	TX 2472MHz
------	---------	-----------	------------

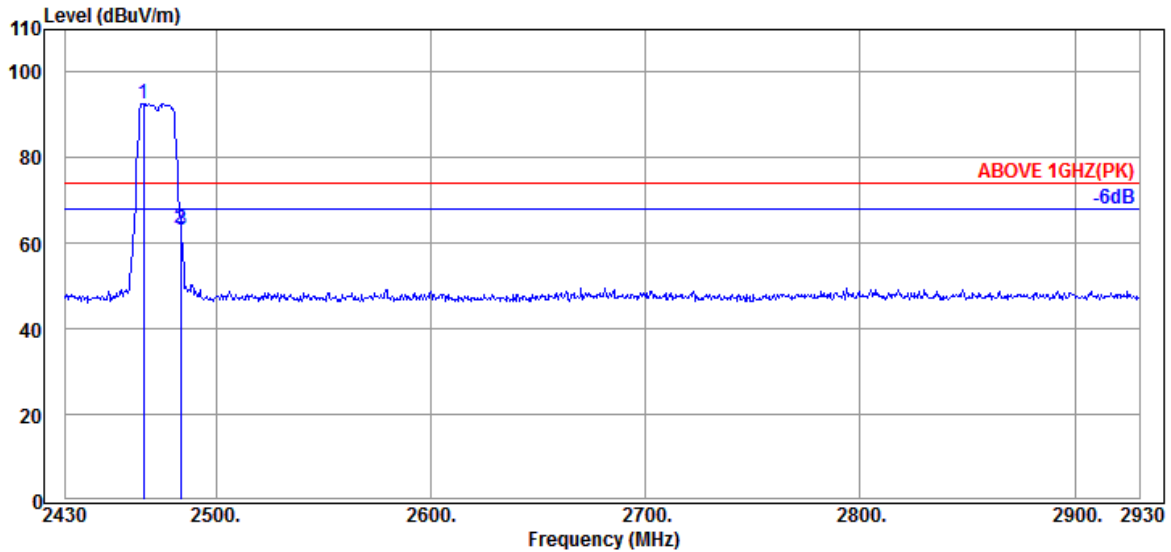

Antenna at Vertical Polarization

Emission Frequency (MHz)	Antenna Factor (dB/m)	Cable Loss (dB)	Preamplifier Gain (dB)	Read Level (dBμV)	Emission Level (dBμV/m)	Limits (dBμV/m)	Margin (dB)	Detector
@ 2466.500	32.06	7.98	34.60	87.34	92.78	---	---	Peak
2483.500	32.14	7.99	34.61	57.86	63.38	74.00	10.62	Peak
2484.000	32.14	7.99	34.61	57.50	63.02	74.00	10.98	Peak

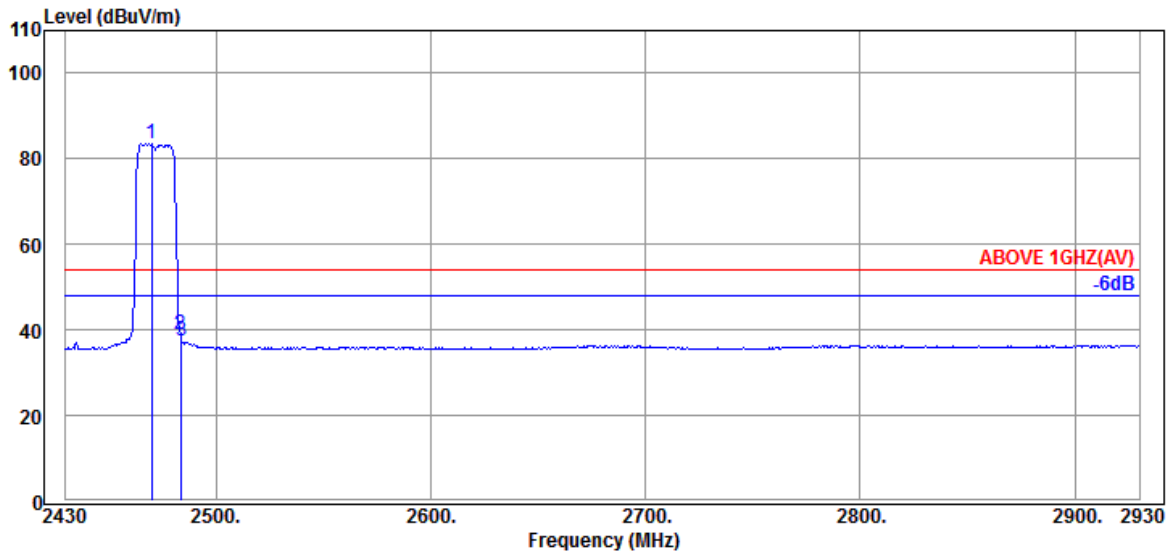

Antenna at Vertical Polarization

Emission Frequency (MHz)	Antenna Factor (dB/m)	Cable Loss (dB)	Preamplifier Gain (dB)	Read Level (dBμV)	Emission Level (dBμV/m)	Limits (dBμV/m)	Margin (dB)	Detector
@ 2470.000	32.09	7.99	34.60	78.15	83.63	---	---	Average
2483.500	32.14	7.99	34.61	33.24	38.76	54.00	15.24	Average
2484.000	32.14	7.99	34.61	32.06	37.58	54.00	16.42	Average

Remark: The "@" means fundamental frequency, it is ignored in this section.

Mode	802.11n-HT20	Frequency	TX 2412MHz
------	--------------	-----------	------------

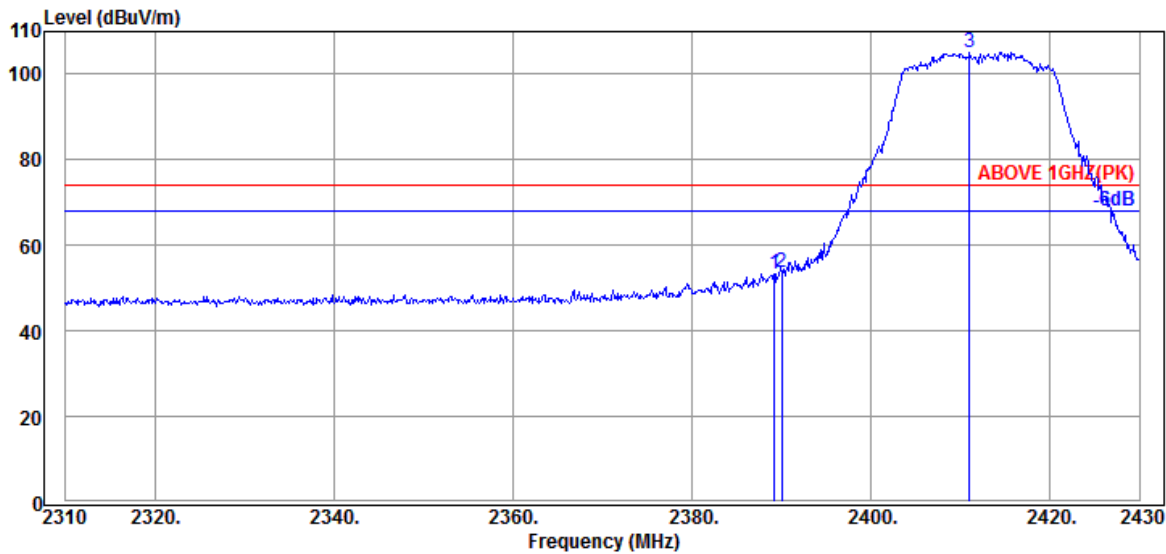

Antenna at Horizontal Polarization

Emission Frequency (MHz)	Antenna Factor (dB/m)	Cable Loss (dB)	Preamplifier Gain (dB)	Read Level (dBμV)	Emission Level (dBμV/m)	Limits (dBμV/m)	Margin (dB)	Detector
2389.200	32.44	7.95	34.58	47.58	53.39	74.00	20.61	Peak
2390.040	32.44	7.95	34.58	48.00	53.81	74.00	20.19	Peak
@ 2411.040	32.43	7.96	34.59	99.33	105.13	---	---	Peak

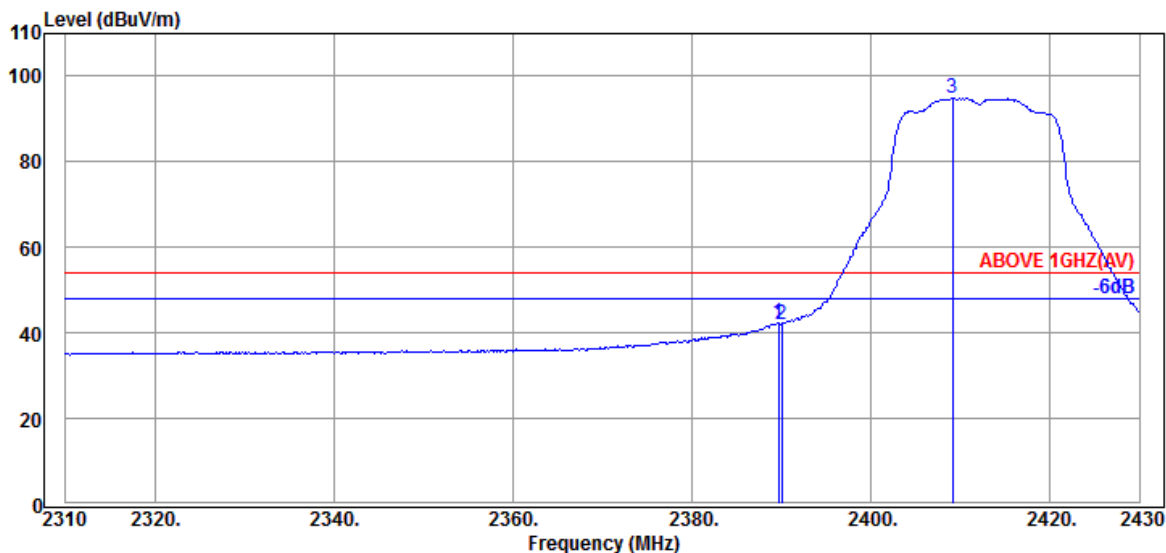

Antenna at Horizontal Polarization

Emission Frequency (MHz)	Antenna Factor (dB/m)	Cable Loss (dB)	Preamplifier Gain (dB)	Read Level (dBμV)	Emission Level (dBμV/m)	Limits (dBμV/m)	Margin (dB)	Detector
2389.680	32.44	7.95	34.58	36.47	42.28	54.00	11.72	Average
2390.040	32.44	7.95	34.58	36.30	42.11	54.00	11.89	Average
@ 2409.120	32.43	7.96	34.59	89.04	94.84	---	---	Average

Remark: The “@” means fundamental frequency, it is ignored in this section.

Mode	802.11n-HT20	Frequency	TX 2412MHz
------	--------------	-----------	------------

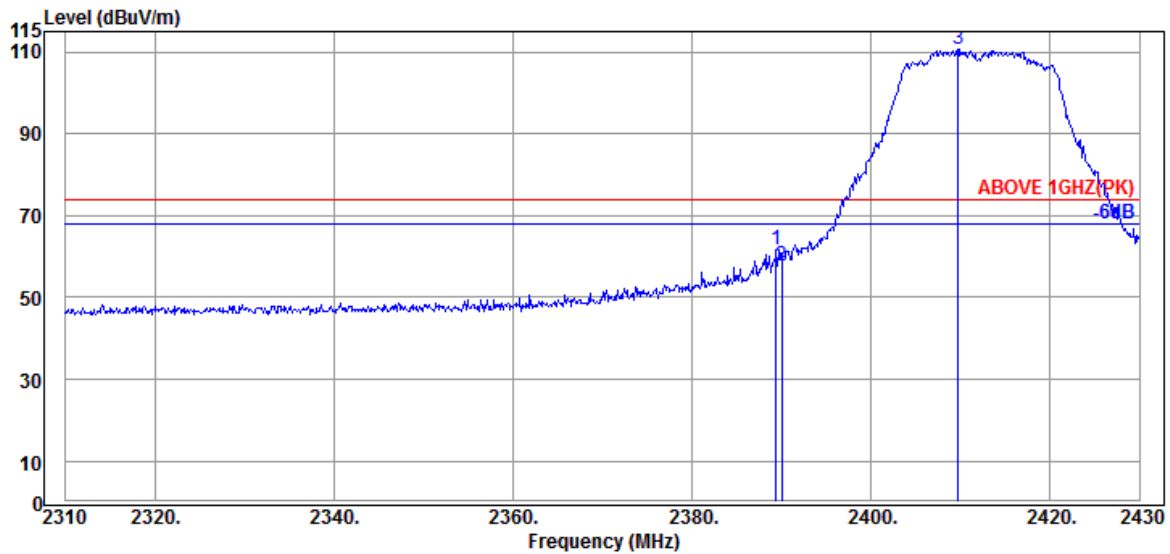

Antenna at Vertical Polarization

Emission Frequency (MHz)	Antenna Factor (dB/m)	Cable Loss (dB)	Preamp Gain (dB)	Read Level (dBμV)	Emission Level (dBμV/m)	Limits (dBμV/m)	Margin (dB)	Detector
2389.440	32.44	7.95	34.58	55.73	61.54	74.00	12.46	Peak
2390.040	32.44	7.95	34.58	52.07	57.88	74.00	16.12	Peak
@ 2409.720	32.43	7.96	34.59	104.90	110.70	---	---	Peak

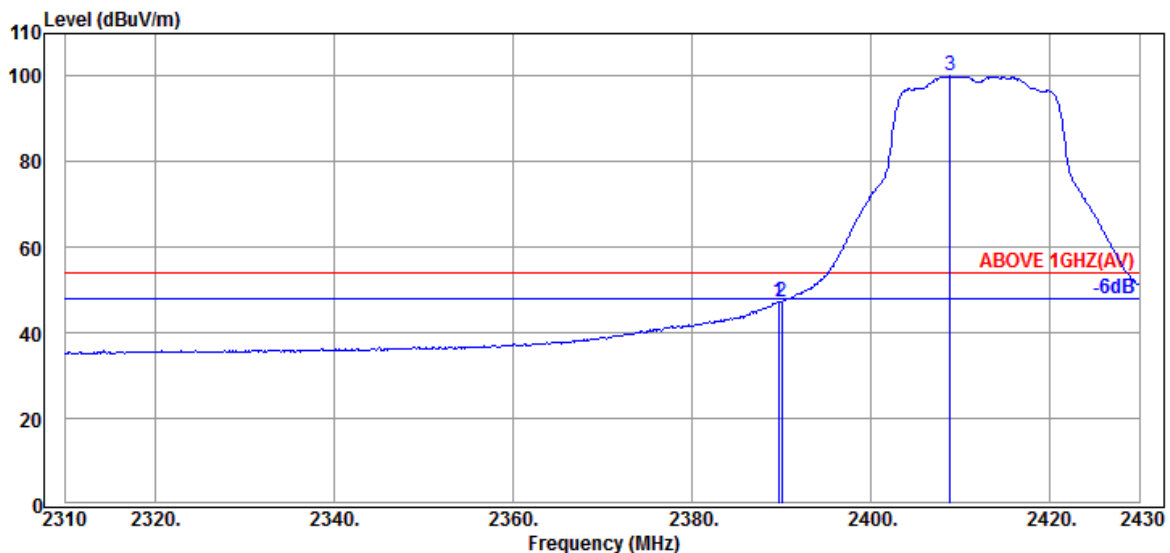

Antenna at Vertical Polarization

Emission Frequency (MHz)	Antenna Factor (dB/m)	Cable Loss (dB)	Preamp Gain (dB)	Read Level (dBμV)	Emission Level (dBμV/m)	Limits (dBμV/m)	Margin (dB)	Detector
2389.680	32.44	7.95	34.58	41.30	47.11	54.00	6.89	Average
2390.040	32.44	7.95	34.58	41.57	47.38	54.00	6.62	Average
@ 2408.880	32.43	7.96	34.59	94.20	100.00	---	---	Average

Remark: The "@" means fundamental frequency, it is ignored in this section.

Mode	802.11n-HT20	Frequency	TX 2417MHz
------	--------------	-----------	------------

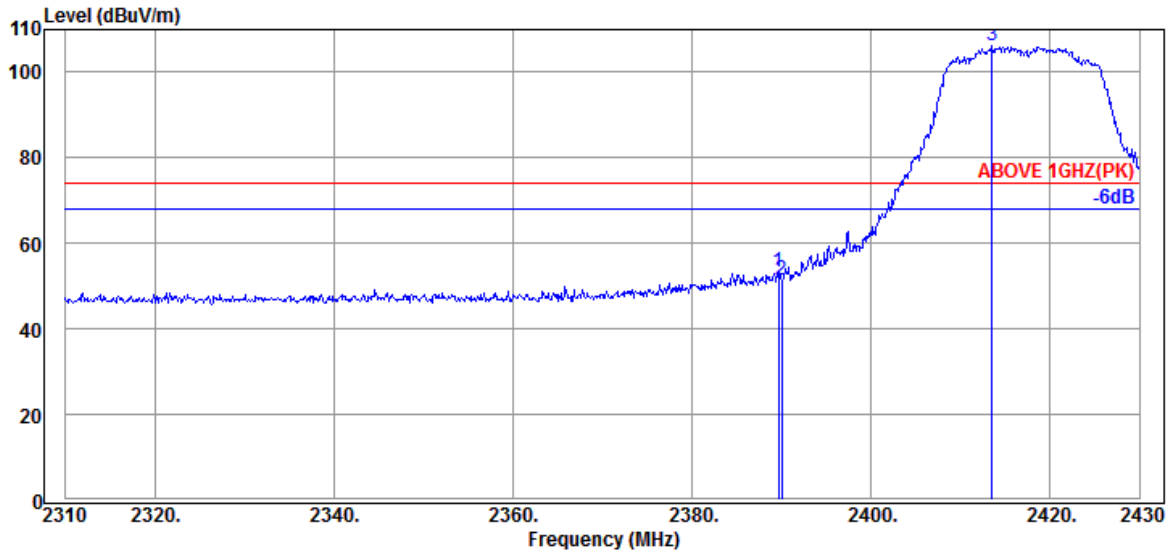

Antenna at Horizontal Polarization

Emission Frequency (MHz)	Antenna Factor (dB/m)	Cable Loss (dB)	Preamplifier Gain (dB)	Read Level (dBμV)	Emission Level (dBμV/m)	Limits (dBμV/m)	Margin (dB)	Detector
2389.680	32.44	7.95	34.58	47.33	53.14	74.00	20.86	Peak
2390.040	32.44	7.95	34.58	45.55	51.36	74.00	22.64	Peak
@ 2413.560	32.36	7.96	34.59	100.51	106.24	---	---	Peak

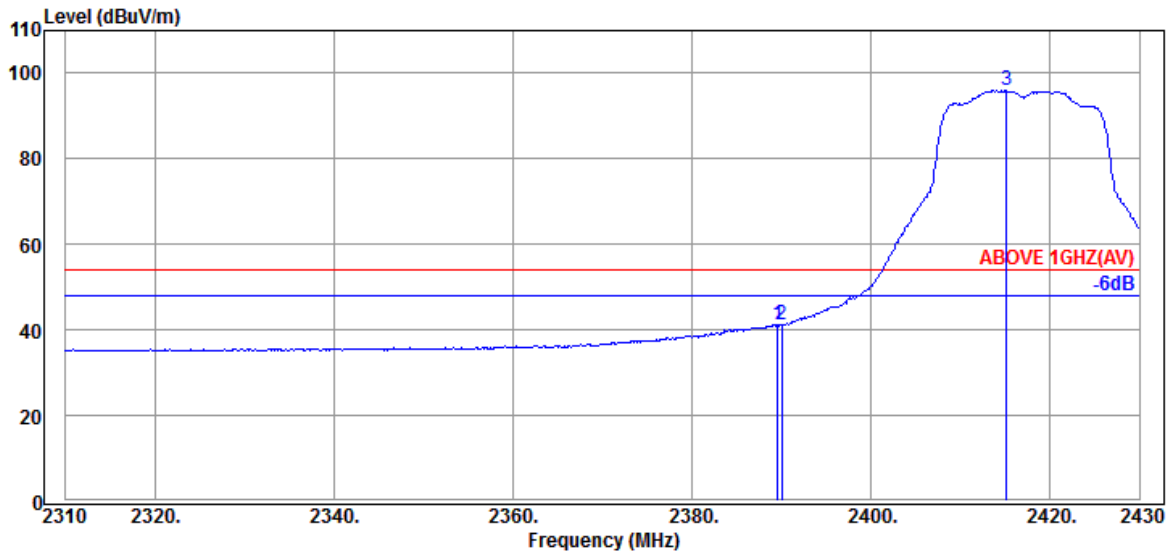

Antenna at Horizontal Polarization

Emission Frequency (MHz)	Antenna Factor (dB/m)	Cable Loss (dB)	Preamplifier Gain (dB)	Read Level (dBμV)	Emission Level (dBμV/m)	Limits (dBμV/m)	Margin (dB)	Detector
2389.560	32.44	7.95	34.58	35.26	41.07	54.00	12.93	Average
2390.040	32.44	7.95	34.58	35.47	41.28	54.00	12.72	Average
@ 2415.120	32.36	7.96	34.59	90.15	95.88	---	---	Average

Remark: The “@” means fundamental frequency, it is ignored in this section.

Mode	802.11n-HT20	Frequency	TX 2417MHz
------	--------------	-----------	------------

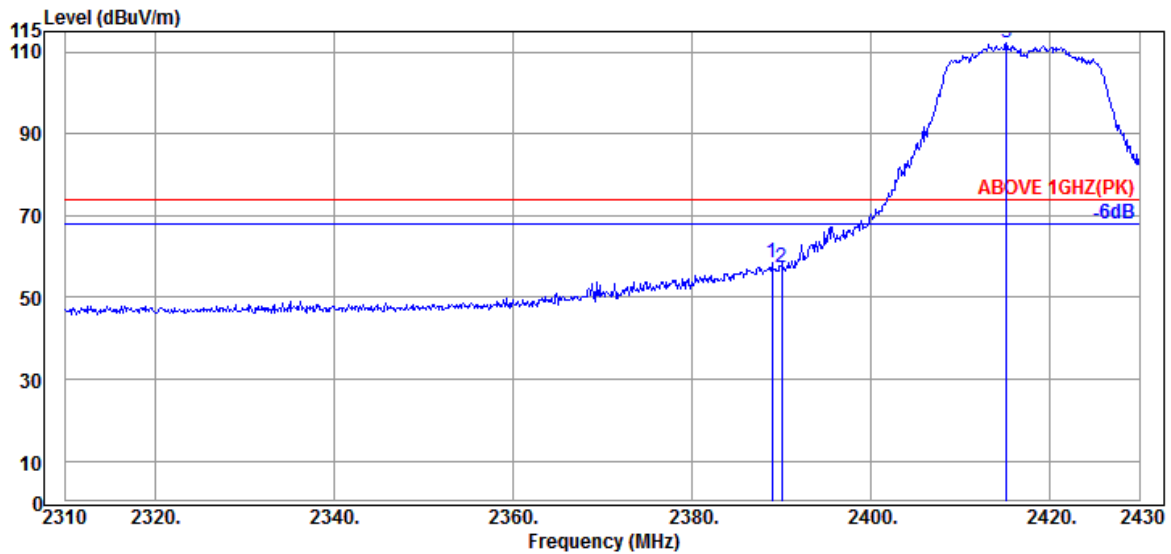

Antenna at Vertical Polarization

Emission Frequency (MHz)	Antenna Factor (dB/m)	Cable Loss (dB)	Preamplifier Gain (dB)	Read Level (dBμV)	Emission Level (dBμV/m)	Limits (dBμV/m)	Margin (dB)	Detector
2388.960	32.44	7.95	34.58	52.56	58.37	74.00	15.63	Peak
2390.040	32.44	7.95	34.58	51.34	57.15	74.00	16.85	Peak
@ 2415.120	32.36	7.96	34.59	106.33	112.06	---	---	Peak

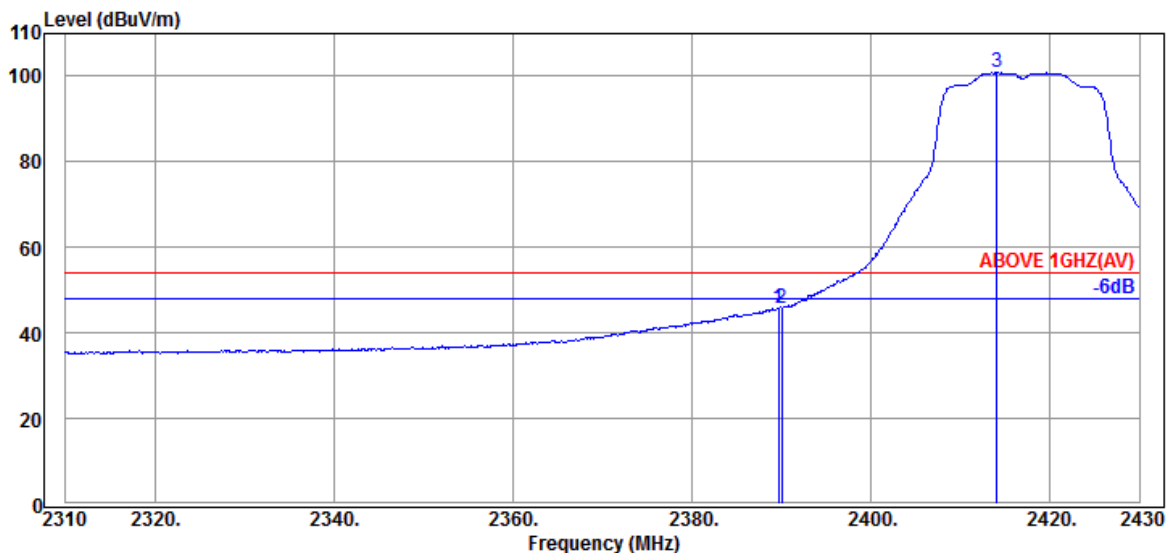

Antenna at Vertical Polarization

Emission Frequency (MHz)	Antenna Factor (dB/m)	Cable Loss (dB)	Preamplifier Gain (dB)	Read Level (dBμV)	Emission Level (dBμV/m)	Limits (dBμV/m)	Margin (dB)	Detector
2389.680	32.44	7.95	34.58	40.10	45.91	54.00	8.09	Average
2390.040	32.44	7.95	34.58	40.03	45.84	54.00	8.16	Average
@ 2414.040	32.36	7.96	34.59	95.10	100.83	---	---	Average

Remark: The “@” means fundamental frequency, it is ignored in this section.

Mode	802.11n-HT20	Frequency	TX 2457MHz
------	--------------	-----------	------------

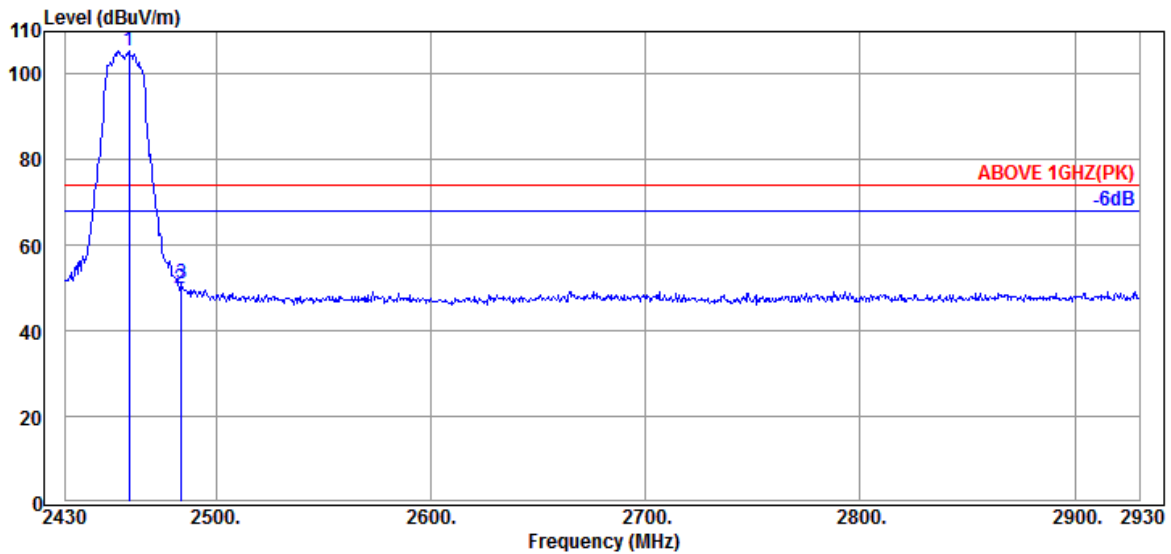

Antenna at Horizontal Polarization

Emission Frequency (MHz)	Antenna Factor (dB/m)	Cable Loss (dB)	Preamplifier Gain (dB)	Read Level (dBμV)	Emission Level (dBμV/m)	Limits (dBμV/m)	Margin (dB)	Detector
@ 2459.500	32.03	7.98	34.60	100.22	105.63	---	---	Peak
2483.500	32.14	7.99	34.61	44.36	49.88	74.00	24.12	Peak
2484.000	32.14	7.99	34.61	45.48	51.00	74.00	23.00	Peak

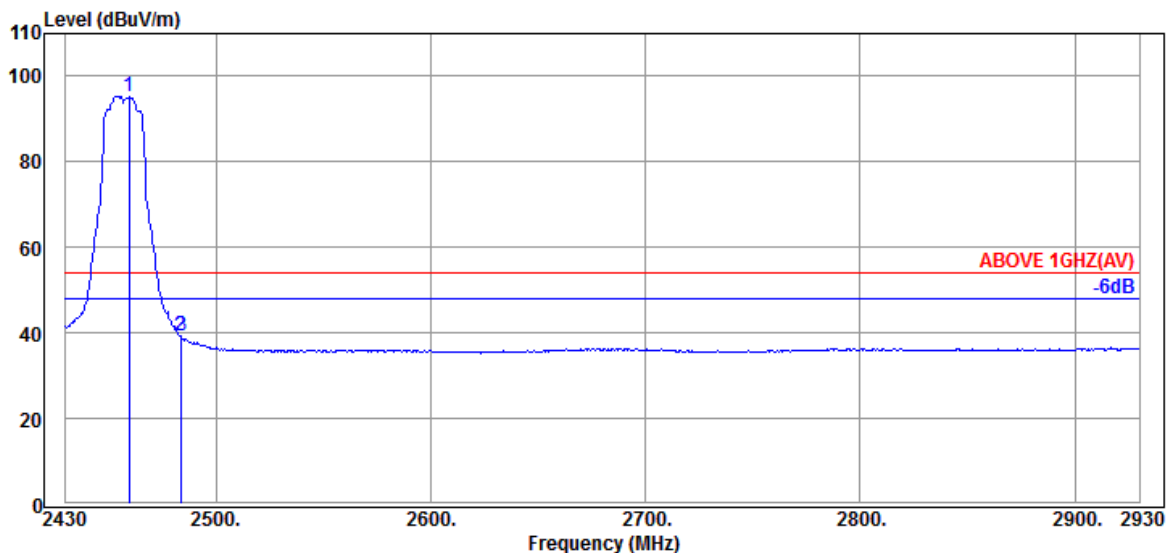

Antenna at Horizontal Polarization

Emission Frequency (MHz)	Antenna Factor (dB/m)	Cable Loss (dB)	Preamplifier Gain (dB)	Read Level (dBμV)	Emission Level (dBμV/m)	Limits (dBμV/m)	Margin (dB)	Detector
@ 2459.500	32.03	7.98	34.60	89.79	95.20	---	---	Average
2483.500	32.14	7.99	34.61	33.83	39.35	54.00	14.65	Average
2484.000	32.14	7.99	34.61	33.61	39.13	54.00	14.87	Average

Remark: The “@” means fundamental frequency, it is ignored in this section.

Mode	802.11n-HT20	Frequency	TX 2457MHz
------	--------------	-----------	------------

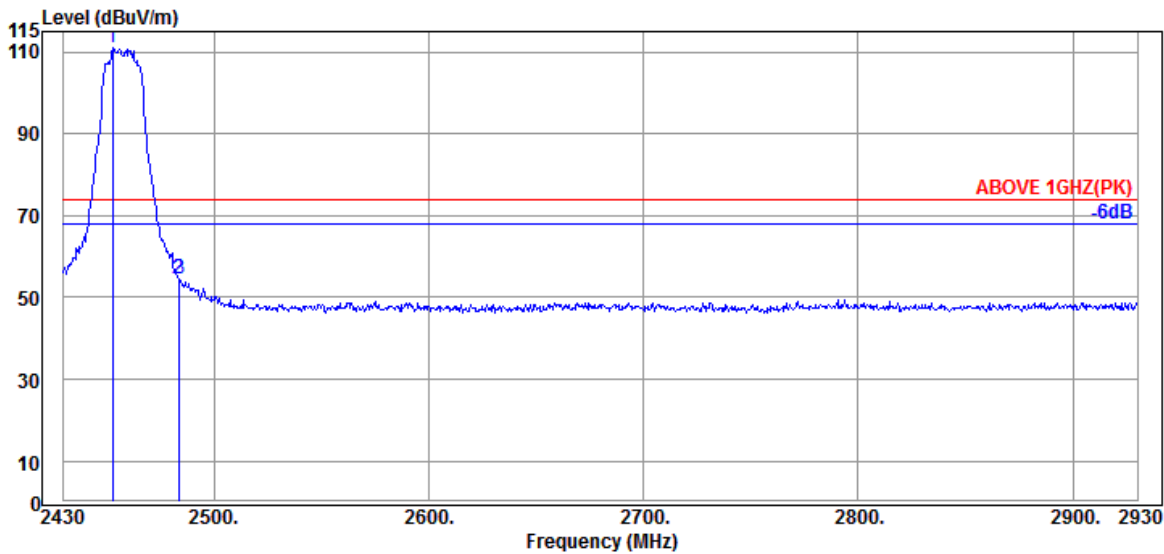

Antenna at Vertical Polarization

Emission Frequency (MHz)	Antenna Factor (dB/m)	Cable Loss (dB)	Preamplifier Gain (dB)	Read Level (dBμV)	Emission Level (dBμV/m)	Limits (dBμV/m)	Margin (dB)	Detector
@ 2453.000	32.00	7.98	34.60	105.74	111.12	---	---	Peak
2483.500	32.14	7.99	34.61	49.18	54.70	74.00	19.30	Peak
2484.000	32.14	7.99	34.61	49.07	54.59	74.00	19.41	Peak

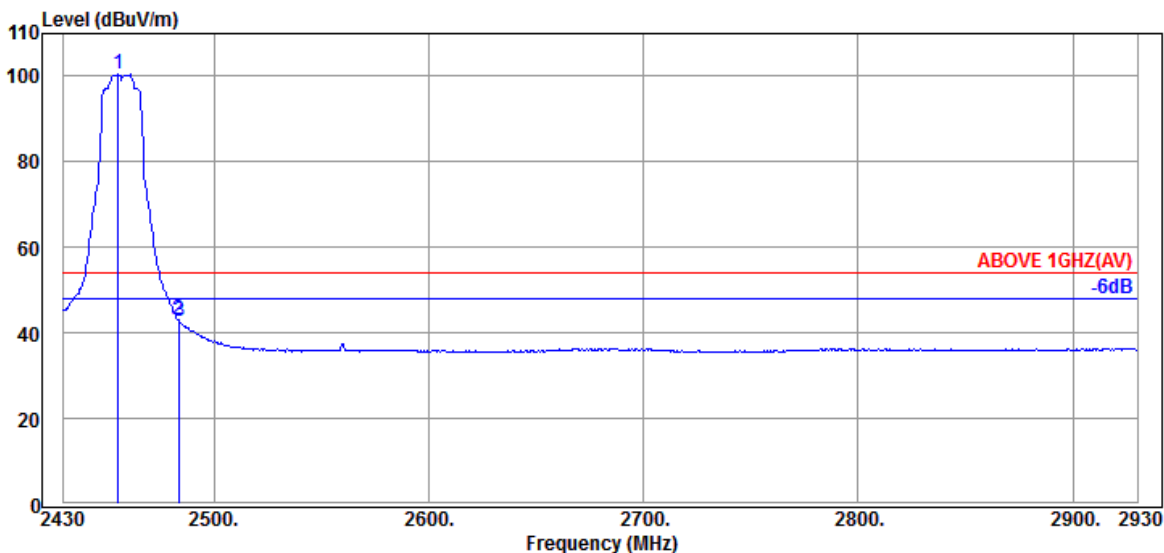

Antenna at Vertical Polarization

Emission Frequency (MHz)	Antenna Factor (dB/m)	Cable Loss (dB)	Preamplifier Gain (dB)	Read Level (dBμV)	Emission Level (dBμV/m)	Limits (dBμV/m)	Margin (dB)	Detector
@ 2455.500	32.03	7.98	34.60	95.08	100.49	---	---	Average
2483.500	32.14	7.99	34.61	37.54	43.06	54.00	10.94	Average
2484.000	32.14	7.99	34.61	37.04	42.56	54.00	11.44	Average

Remark: The "@" means fundamental frequency, it is ignored in this section.

Mode	802.11n-HT20	Frequency	TX 2462MHz
------	--------------	-----------	------------

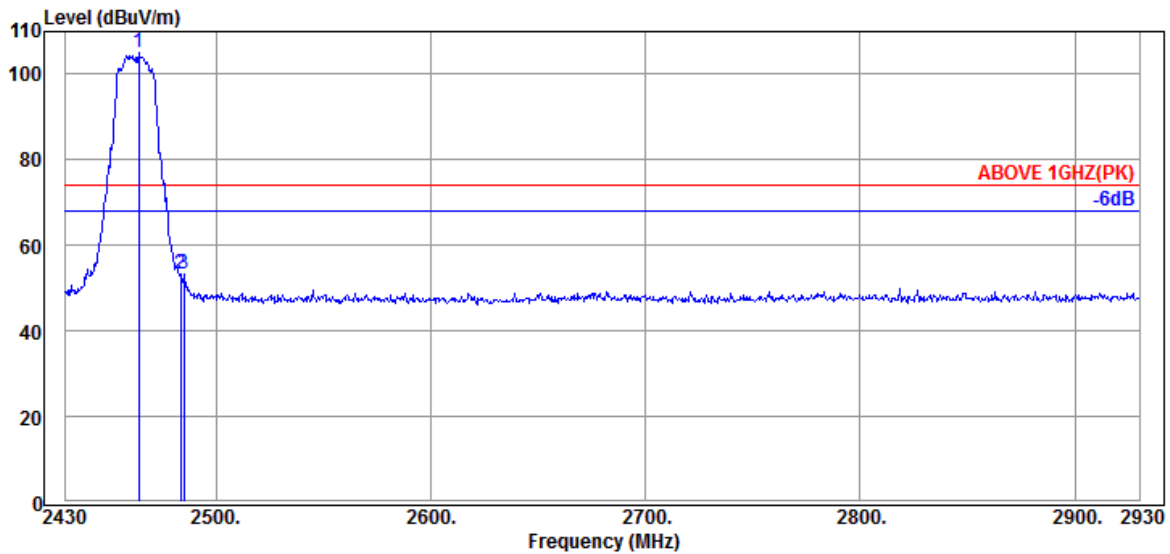

Antenna at Horizontal Polarization

Emission Frequency (MHz)	Antenna Factor (dB/m)	Cable Loss (dB)	Preamplifier Gain (dB)	Read Level (dBμV)	Emission Level (dBμV/m)	Limits (dBμV/m)	Margin (dB)	Detector
@ 2464.000	32.06	7.98	34.60	99.83	105.27	---	---	Peak
2483.500	32.14	7.99	34.61	47.83	53.35	74.00	20.65	Peak
2485.000	32.14	7.99	34.61	47.94	53.46	74.00	20.54	Peak

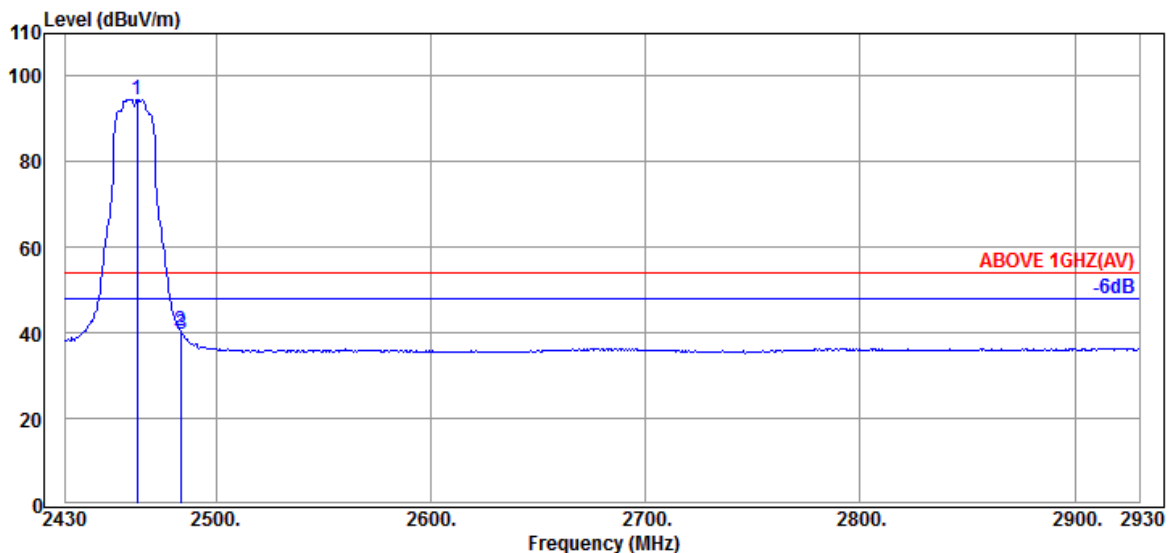

Antenna at Horizontal Polarization

Emission Frequency (MHz)	Antenna Factor (dB/m)	Cable Loss (dB)	Preamplifier Gain (dB)	Read Level (dBμV)	Emission Level (dBμV/m)	Limits (dBμV/m)	Margin (dB)	Detector
@ 2463.500	32.06	7.98	34.60	89.20	94.64	---	---	Average
2483.500	32.14	7.99	34.61	34.86	40.38	54.00	13.62	Average
2484.000	32.14	7.99	34.61	34.35	39.87	54.00	14.13	Average

Remark: The "@" means fundamental frequency, it is ignored in this section.

Mode	802.11n-HT20	Frequency	TX 2462MHz
------	--------------	-----------	------------

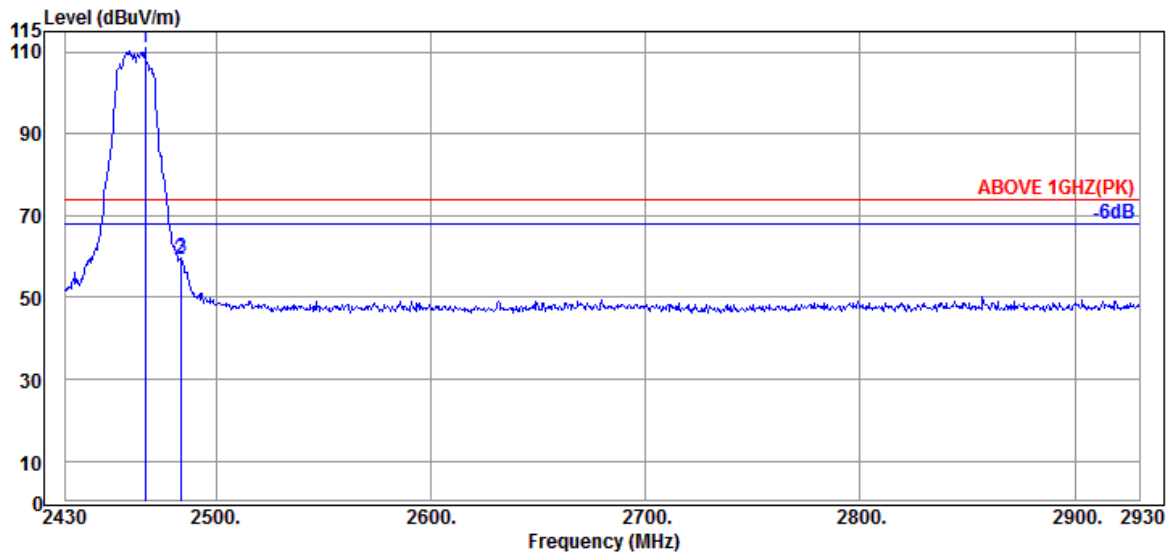

Antenna at Vertical Polarization

Emission Frequency (MHz)	Antenna Factor (dB/m)	Cable Loss (dB)	Preamplifier Gain (dB)	Read Level (dBμV)	Emission Level (dBμV/m)	Limits (dBμV/m)	Margin (dB)	Detector
@ 2467.000	32.06	7.98	34.60	105.49	110.93	---	---	Peak
2483.500	32.14	7.99	34.61	53.93	59.45	74.00	14.55	Peak
2484.000	32.14	7.99	34.61	54.00	59.52	74.00	14.48	Peak

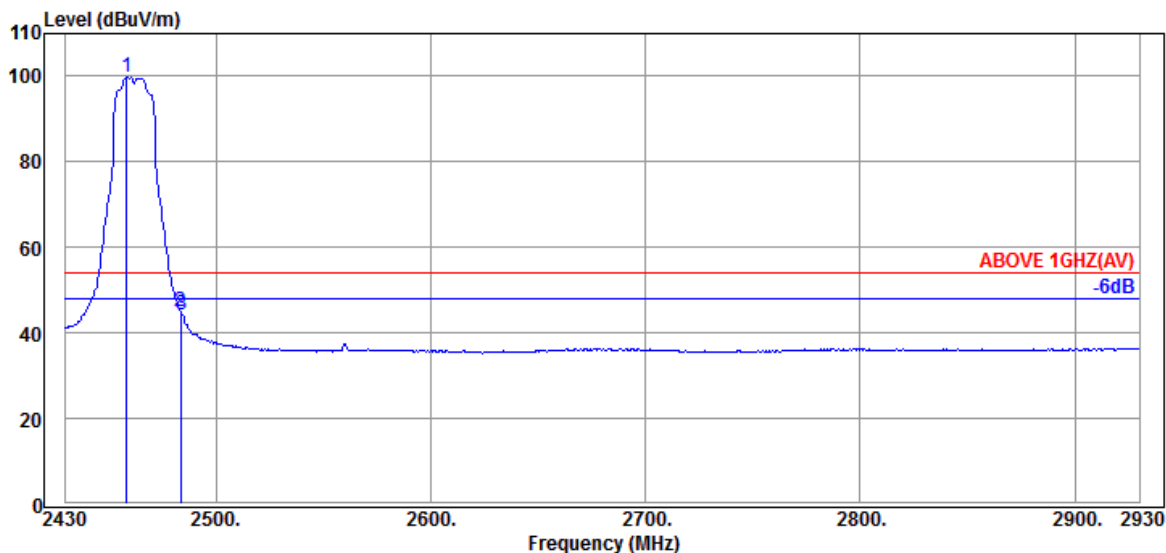

Antenna at Vertical Polarization

Emission Frequency (MHz)	Antenna Factor (dB/m)	Cable Loss (dB)	Preamplifier Gain (dB)	Read Level (dBμV)	Emission Level (dBμV/m)	Limits (dBμV/m)	Margin (dB)	Detector
@ 2458.500	32.03	7.98	34.60	94.44	99.85	---	---	Average
2483.500	32.14	7.99	34.61	39.59	45.11	54.00	8.89	Average
2484.000	32.14	7.99	34.61	38.90	44.42	54.00	9.58	Average

Remark: The “@” means fundamental frequency, it is ignored in this section.

Mode	802.11n-HT20	Frequency	TX 2467MHz
------	--------------	-----------	------------

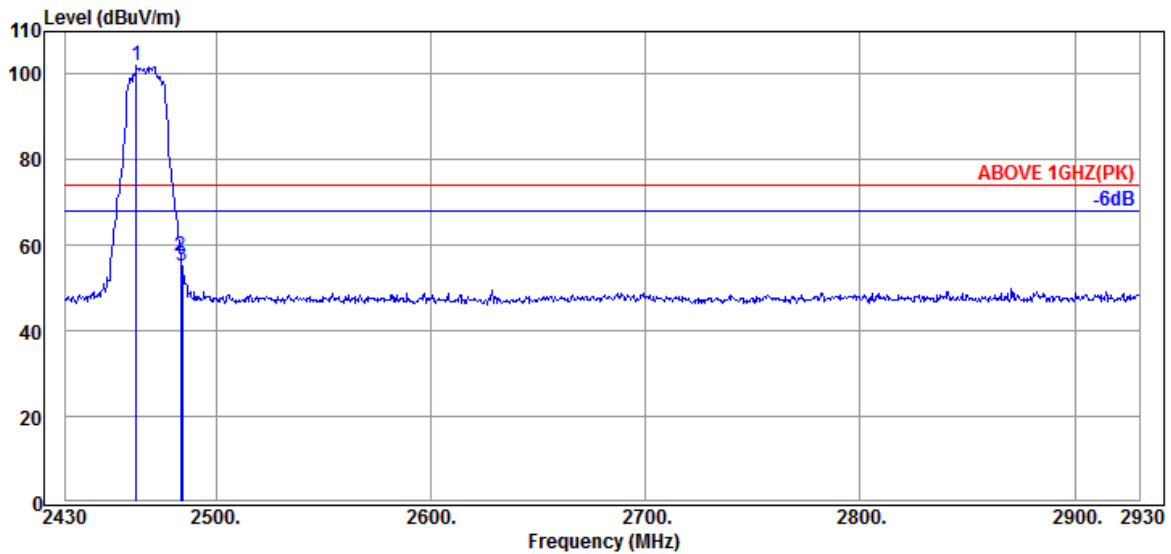

Antenna at Horizontal Polarization

Emission Frequency (MHz)	Antenna Factor (dB/m)	Cable Loss (dB)	Preamplifier Gain (dB)	Read Level (dBμV)	Emission Level (dBμV/m)	Limits (dBμV/m)	Margin (dB)	Detector
@ 2463.000	32.06	7.98	34.60	96.45	101.89	---	---	Peak
2483.500	32.14	7.99	34.61	51.79	57.31	74.00	16.69	Peak
2484.500	32.14	7.99	34.61	49.76	55.28	74.00	18.72	Peak

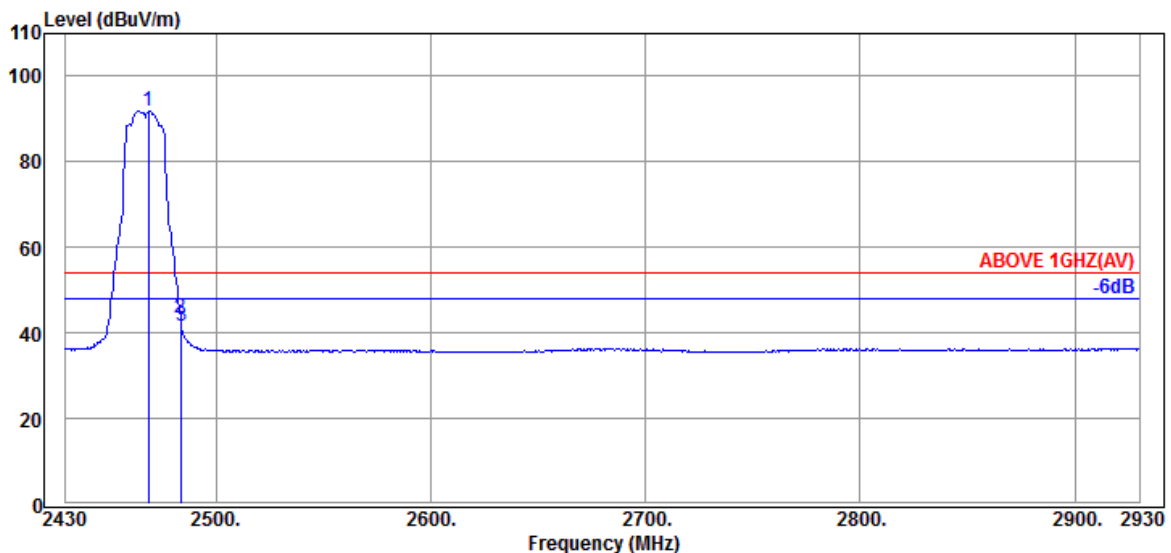

Antenna at Horizontal Polarization

Emission Frequency (MHz)	Antenna Factor (dB/m)	Cable Loss (dB)	Preamplifier Gain (dB)	Read Level (dBμV)	Emission Level (dBμV/m)	Limits (dBμV/m)	Margin (dB)	Detector
@ 2468.500	32.09	7.98	34.60	86.38	91.85	---	---	Average
2483.500	32.14	7.99	34.61	37.85	43.37	54.00	10.63	Average
2484.000	32.14	7.99	34.61	36.20	41.72	54.00	12.28	Average

Remark: The "@" means fundamental frequency, it is ignored in this section.

Mode	802.11n-HT20	Frequency	TX 2467MHz
------	--------------	-----------	------------

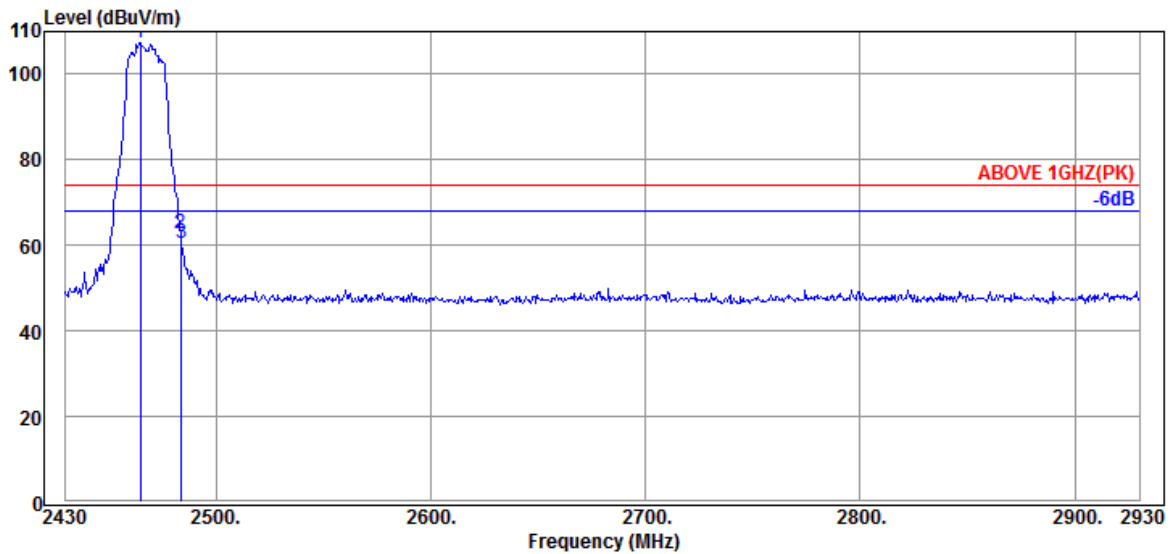

Antenna at Vertical Polarization

Emission Frequency (MHz)	Antenna Factor (dB/m)	Cable Loss (dB)	Preamplifier Gain (dB)	Read Level (dBμV)	Emission Level (dBμV/m)	Limits (dBμV/m)	Margin (dB)	Detector
@ 2465.000	32.06	7.98	34.60	101.96	107.40	---	---	Peak
2483.500	32.14	7.99	34.61	57.13	62.65	74.00	11.35	Peak
2484.000	32.14	7.99	34.61	54.87	60.39	74.00	13.61	Peak

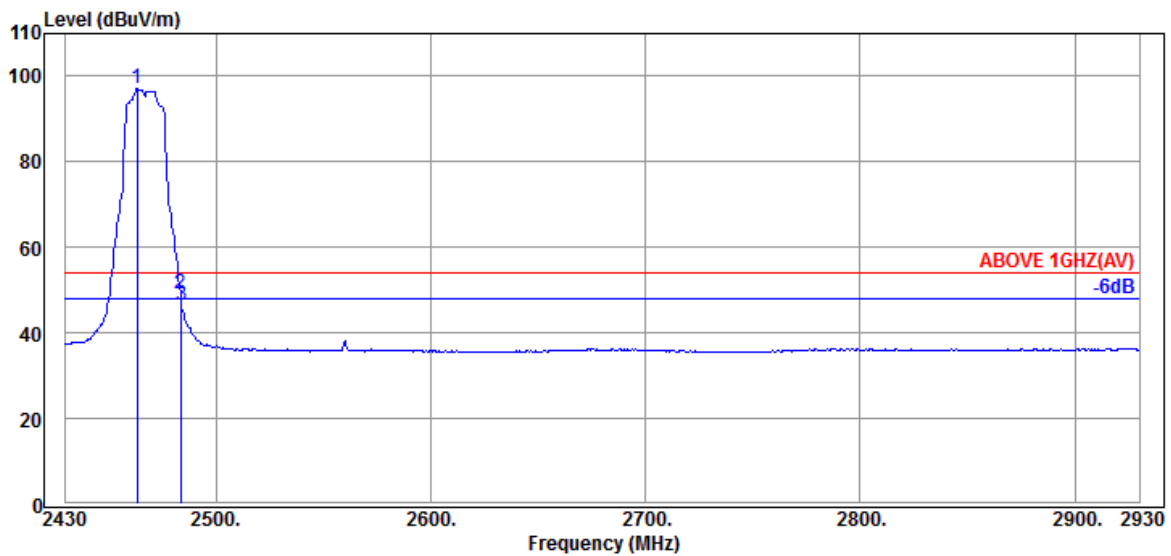

Antenna at Vertical Polarization

Emission Frequency (MHz)	Antenna Factor (dB/m)	Cable Loss (dB)	Preamplifier Gain (dB)	Read Level (dBμV)	Emission Level (dBμV/m)	Limits (dBμV/m)	Margin (dB)	Detector
@ 2463.500	32.06	7.98	34.60	91.56	97.00	---	---	Average
2483.500	32.14	7.99	34.61	43.64	49.16	54.00	4.84	Average
2484.000	32.14	7.99	34.61	41.12	46.64	54.00	7.36	Average

Remark: The "@" means fundamental frequency, it is ignored in this section.

Mode	802.11n-HT20	Frequency	TX 2472MHz
------	--------------	-----------	------------

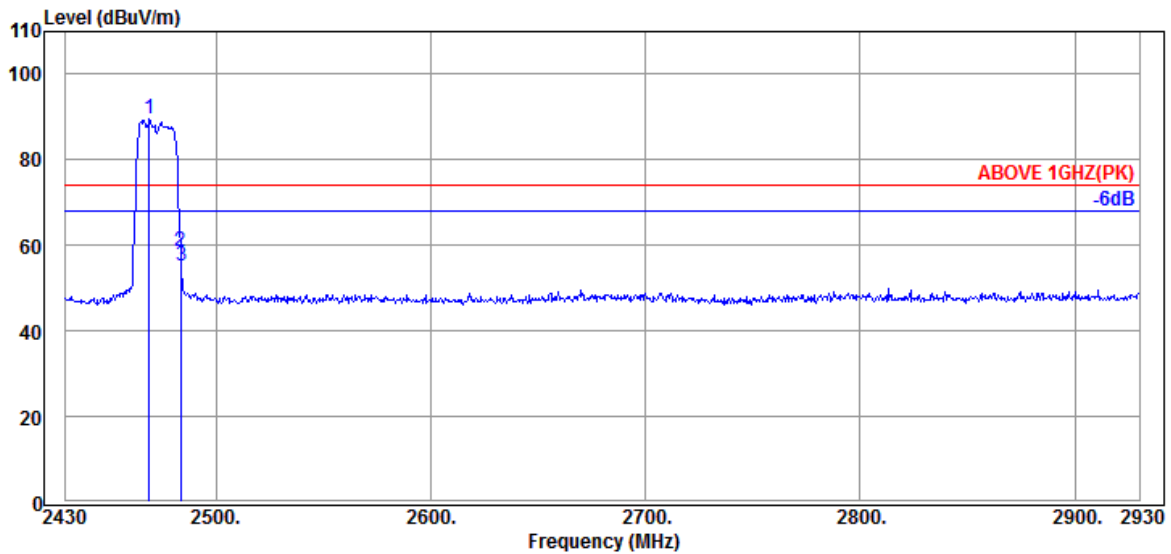

Antenna at Horizontal Polarization

Emission Frequency (MHz)	Antenna Factor (dB/m)	Cable Loss (dB)	Preamplifier Gain (dB)	Read Level (dBμV)	Emission Level (dBμV/m)	Limits (dBμV/m)	Margin (dB)	Detector
@ 2469.000	32.09	7.98	34.60	84.15	89.62	---	---	Peak
2483.500	32.14	7.99	34.61	53.10	58.62	74.00	15.38	Peak
2484.000	32.14	7.99	34.61	49.65	55.17	74.00	18.83	Peak

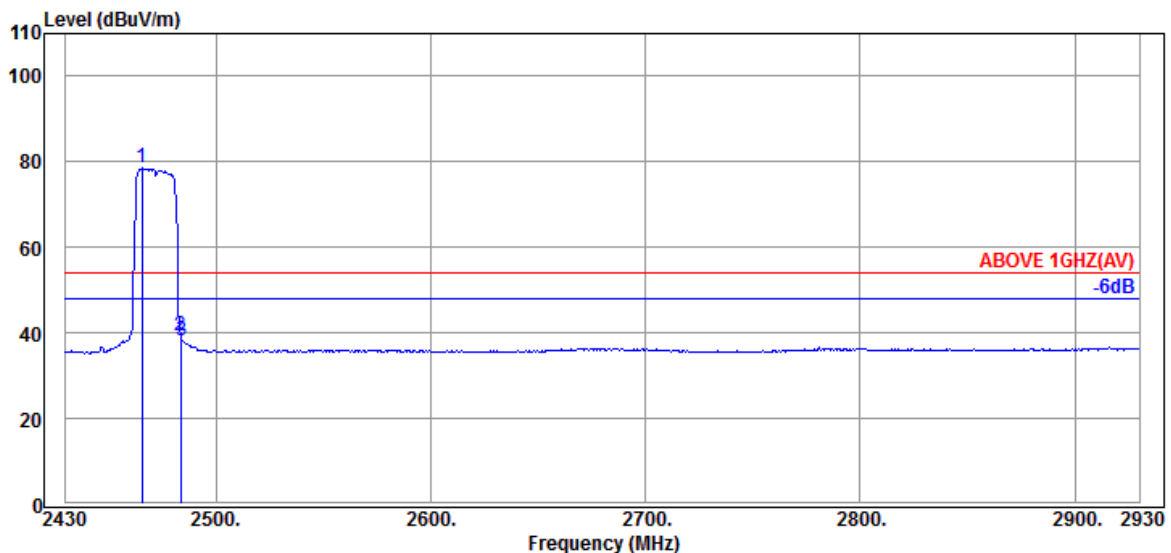

Antenna at Horizontal Polarization

Emission Frequency (MHz)	Antenna Factor (dB/m)	Cable Loss (dB)	Preamplifier Gain (dB)	Read Level (dBμV)	Emission Level (dBμV/m)	Limits (dBμV/m)	Margin (dB)	Detector
@ 2465.500	32.06	7.98	34.60	73.01	78.45	---	---	Average
2483.500	32.14	7.99	34.61	33.65	39.17	54.00	14.83	Average
2484.000	32.14	7.99	34.61	32.72	38.24	54.00	15.76	Average

Remark: The "@" means fundamental frequency, it is ignored in this section.

Mode	802.11n-HT20	Frequency	TX 2472MHz
------	--------------	-----------	------------

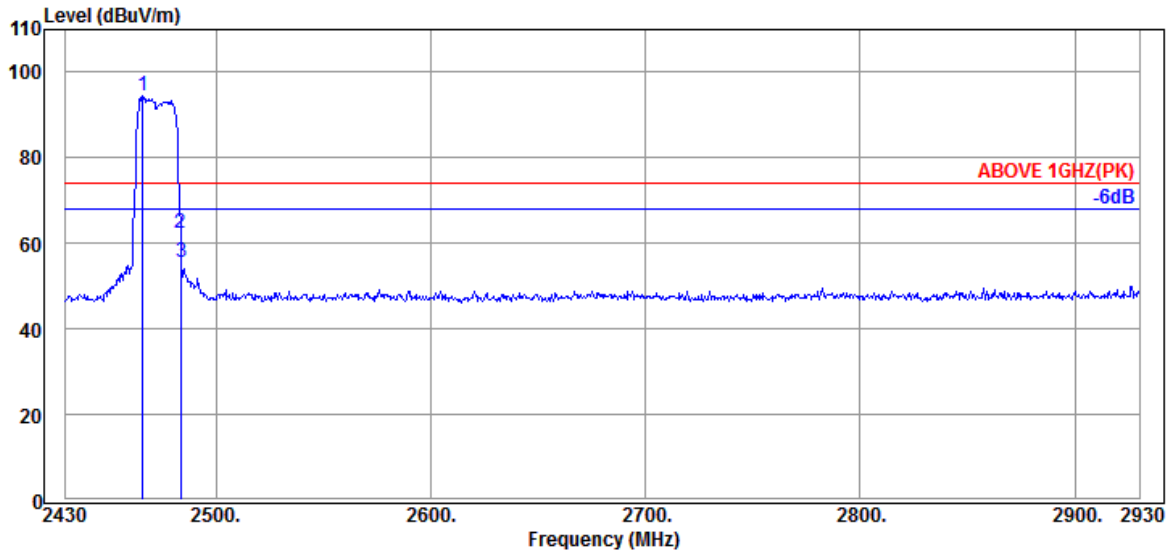

Antenna at Vertical Polarization

Emission Frequency (MHz)	Antenna Factor (dB/m)	Cable Loss (dB)	Preamplifier Gain (dB)	Read Level (dBμV)	Emission Level (dBμV/m)	Limits (dBμV/m)	Margin (dB)	Detector
@ 2466.000	32.06	7.98	34.60	89.05	94.49	---	---	Peak
2483.500	32.14	7.99	34.61	56.81	62.33	74.00	11.67	Peak
2484.000	32.14	7.99	34.61	49.91	55.43	74.00	18.57	Peak

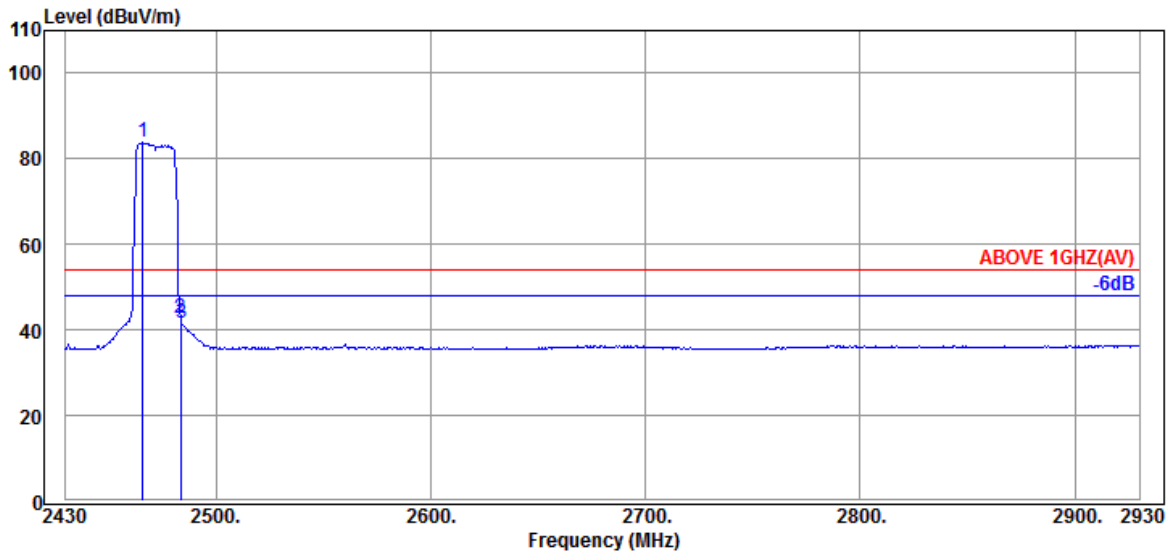

Antenna at Vertical Polarization

Emission Frequency (MHz)	Antenna Factor (dB/m)	Cable Loss (dB)	Preamplifier Gain (dB)	Read Level (dBμV)	Emission Level (dBμV/m)	Limits (dBμV/m)	Margin (dB)	Detector
@ 2466.000	32.06	7.98	34.60	78.35	83.79	---	---	Average
2483.500	32.14	7.99	34.61	37.36	42.88	54.00	11.12	Average
2484.000	32.14	7.99	34.61	36.07	41.59	54.00	12.41	Average

Remark: The "@" means fundamental frequency, it is ignored in this section.

Mode	802.11n-HT40	Frequency	TX 2422MHz
------	--------------	-----------	------------

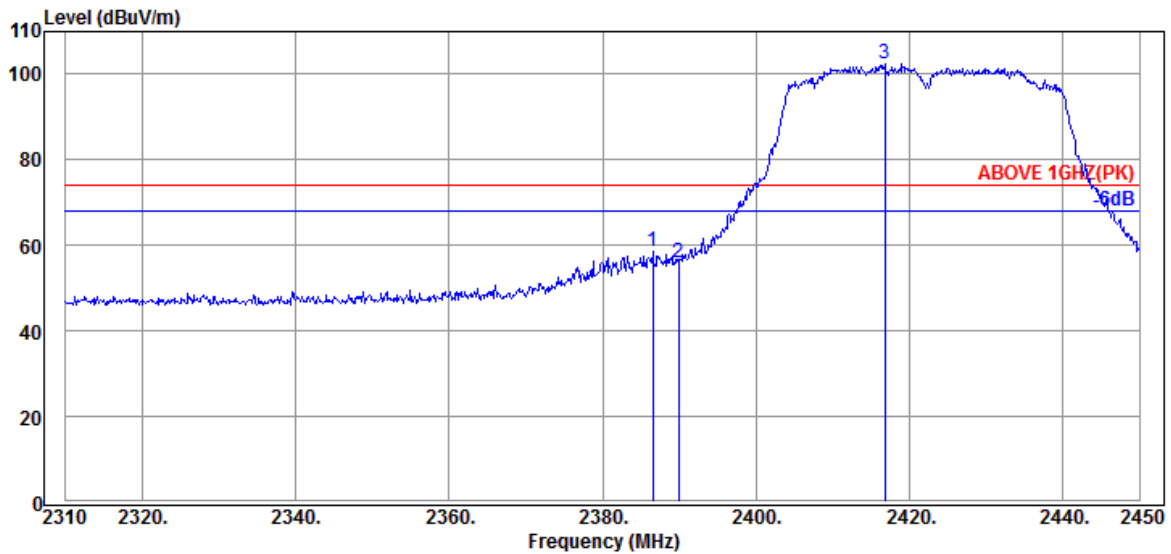

Antenna at Horizontal Polarization

Emission Frequency (MHz)	Antenna Factor (dB/m)	Cable Loss (dB)	Preamplifier Gain (dB)	Read Level (dBμV)	Emission Level (dBμV/m)	Liits (dBμV/m)	Margin (dB)	Detector
2386.580	32.44	7.95	34.58	52.68	58.49	74.00	15.51	Peak
2389.940	32.44	7.95	34.58	49.96	55.77	74.00	18.23	Peak
@ 2416.820	32.36	7.96	34.59	96.71	102.44	---	---	Peak

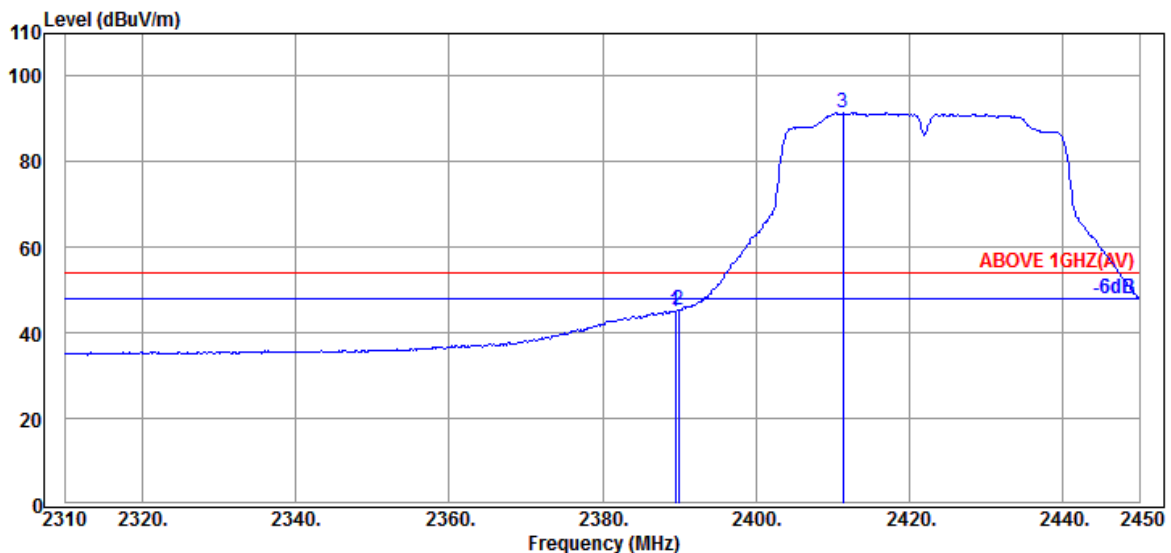

Antenna at Horizontal Polarization

Emission Frequency (MHz)	Antenna Factor (dB/m)	Cable Loss (dB)	Preamplifier Gain (dB)	Read Level (dBμV)	Emission Level (dBμV/m)	Limits (dBμV/m)	Margin (dB)	Detector
2389.520	32.44	7.95	34.58	39.32	45.13	54.00	8.87	Average
2389.940	32.44	7.95	34.58	39.54	45.35	54.00	8.65	Average
@ 2411.360	32.36	7.96	34.59	85.70	91.43	---	---	Average

Remark: The “@” means fundamental frequency, it is ignored in this section.

Mode	802.11n-HT40	Frequency	TX 2422MHz
------	--------------	-----------	------------

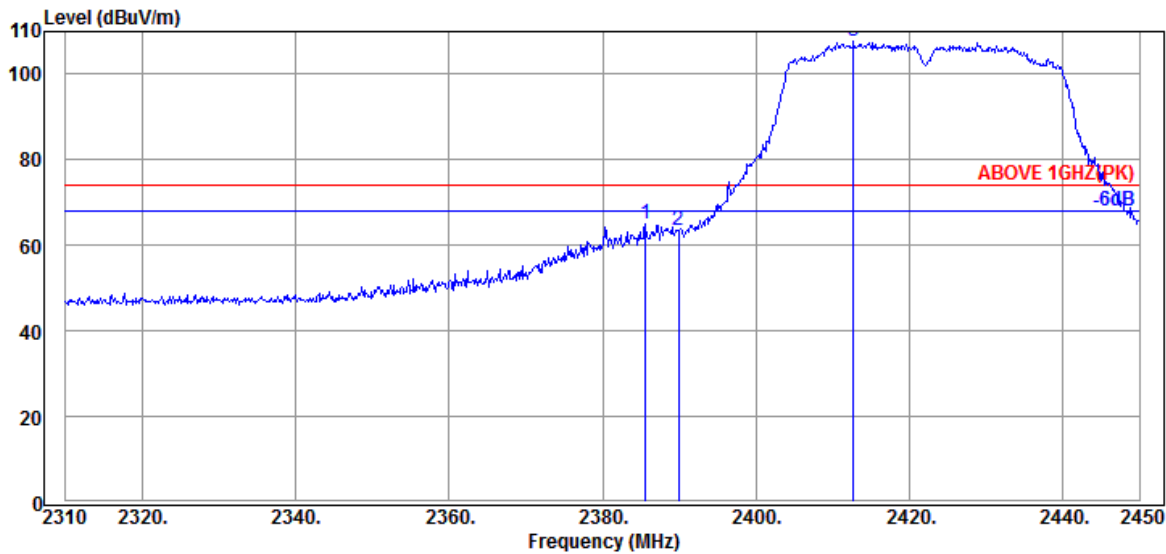

Antenna at Vertical Polarization

Emission Frequency (MHz)	Antenna Factor (dB/m)	Cable Loss (dB)	Preamplifier Gain (dB)	Read Level (dBμV)	Emission Level (dBμV/m)	Limits (dBμV/m)	Margin (dB)	Detector
2385.600	32.44	7.95	34.58	59.27	65.08	74.00	8.92	Peak
2389.940	32.44	7.95	34.58	57.80	63.61	74.00	10.39	Peak
@ 2412.760	32.36	7.96	34.59	101.98	107.71	---	---	Peak

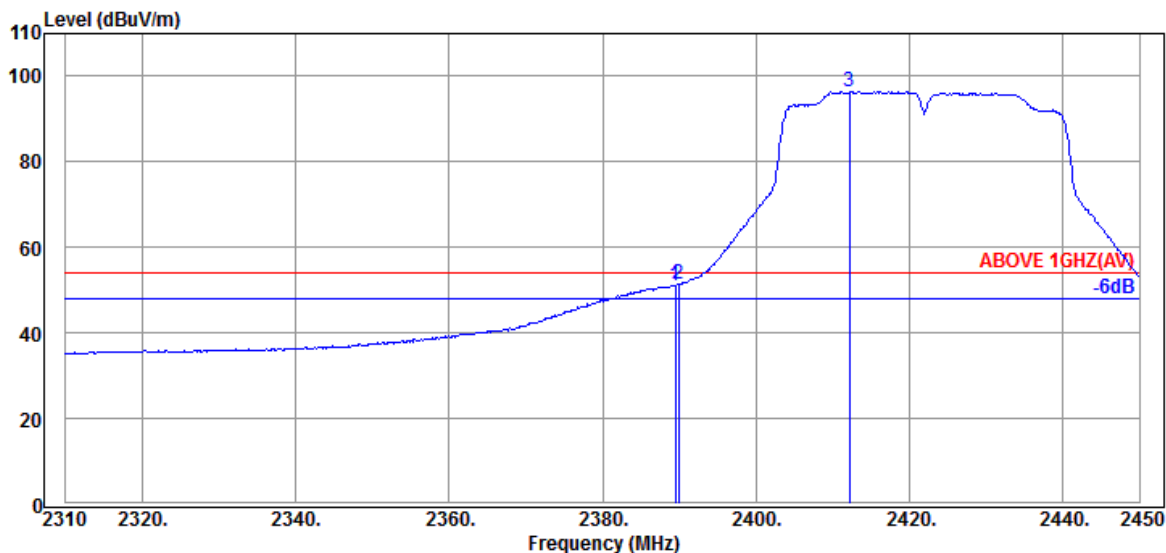

Antenna at Vertical Polarization

Emission Frequency (MHz)	Antenna Factor (dB/m)	Cable Loss (dB)	Preamplifier Gain (dB)	Read Level (dBμV)	Emission Level (dBμV/m)	Limits (dBμV/m)	Margin (dB)	Detector
2389.520	32.44	7.95	34.58	45.33	51.14	54.00	2.86	Average
2389.940	32.44	7.95	34.58	45.55	51.36	54.00	2.64	Average
@ 2412.200	32.36	7.96	34.59	90.62	96.35	---	---	Average

Remark: The "@" means fundamental frequency, it is ignored in this section.

Mode	802.11n-HT40	Frequency	TX 2427MHz
------	--------------	-----------	------------

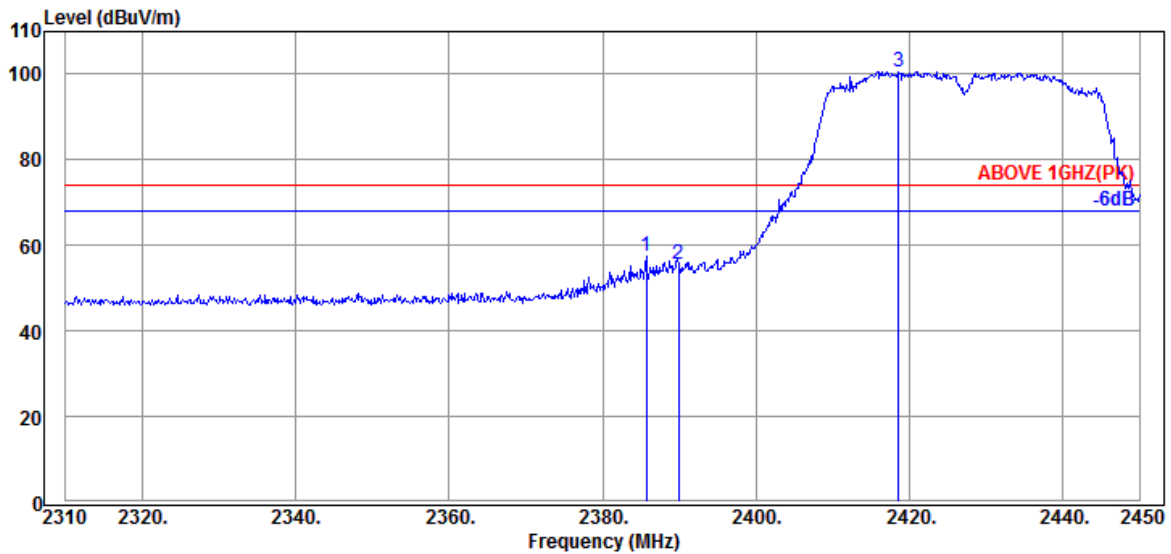

Antenna at Horizontal Polarization

Emission Frequency (MHz)	Antenna Factor (dB/m)	Cable Loss (dB)	Preamplifier Gain (dB)	Read Level (dBμV)	Emission Level (dBμV/m)	Limits (dBμV/m)	Margin (dB)	Detector
2385.740	32.44	7.95	34.58	51.82	57.63	74.00	16.37	Peak
2389.940	32.44	7.95	34.58	49.77	55.58	74.00	18.42	Peak
@ 2418.640	32.29	7.96	34.59	95.05	100.71	---	---	Peak

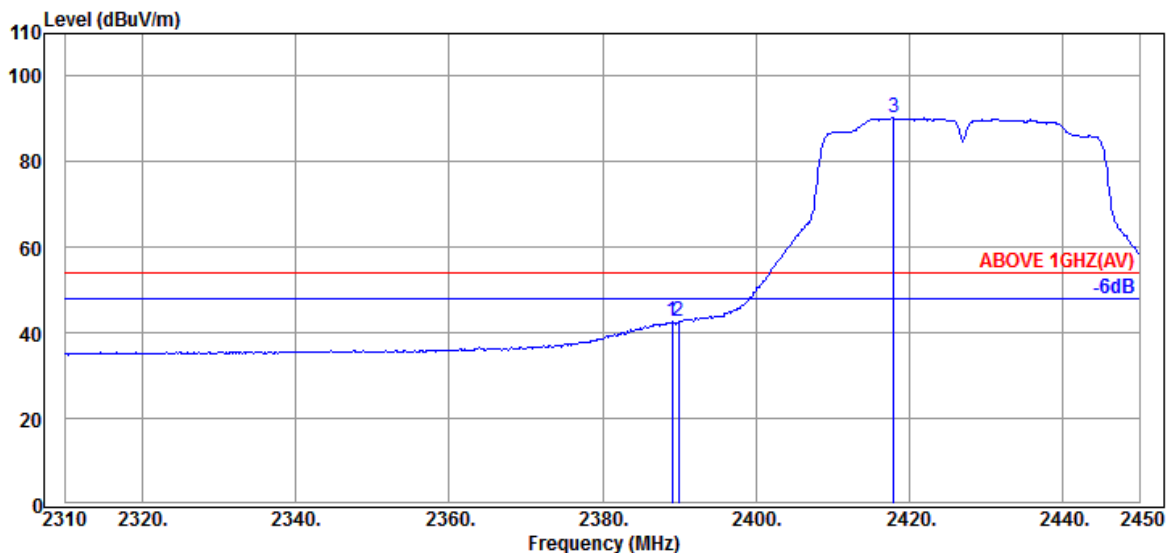

Antenna at Horizontal Polarization

Emission Frequency (MHz)	Antenna Factor (dB/m)	Cable Loss (dB)	Preamplifier Gain (dB)	Read Level (dBμV)	Emission Level (dBμV/m)	Limits (dBμV/m)	Margin (dB)	Detector
2389.100	32.44	7.95	34.58	36.89	42.70	54.00	11.30	Average
2389.940	32.44	7.95	34.58	36.76	42.57	54.00	11.43	Average
@ 2417.940	32.36	7.96	34.59	84.61	90.34	---	---	Average

Remark: The “@” means fundamental frequency, it is ignored in this section.

Mode	802.11n-HT40	Frequency	TX 2427MHz
------	--------------	-----------	------------

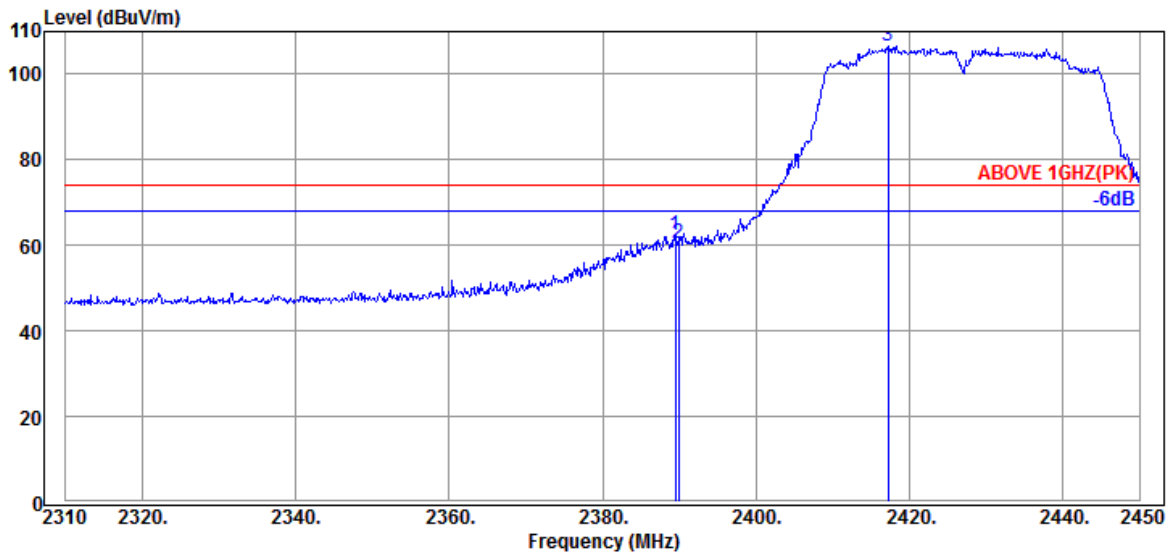

Antenna at Vertical Polarization

Emission Frequency (MHz)	Antenna Factor (dB/m)	Cable Loss (dB)	Preamplifier Gain (dB)	Read Level (dBμV)	Emission Level (dBμV/m)	Limits (dBμV/m)	Margin (dB)	Detector
2389.520	32.44	7.95	34.58	56.69	62.50	74.00	11.50	Peak
2389.940	32.44	7.95	34.58	54.66	60.47	74.00	13.53	Peak
@ 2417.240	32.36	7.96	34.59	100.77	106.50	---	---	Peak

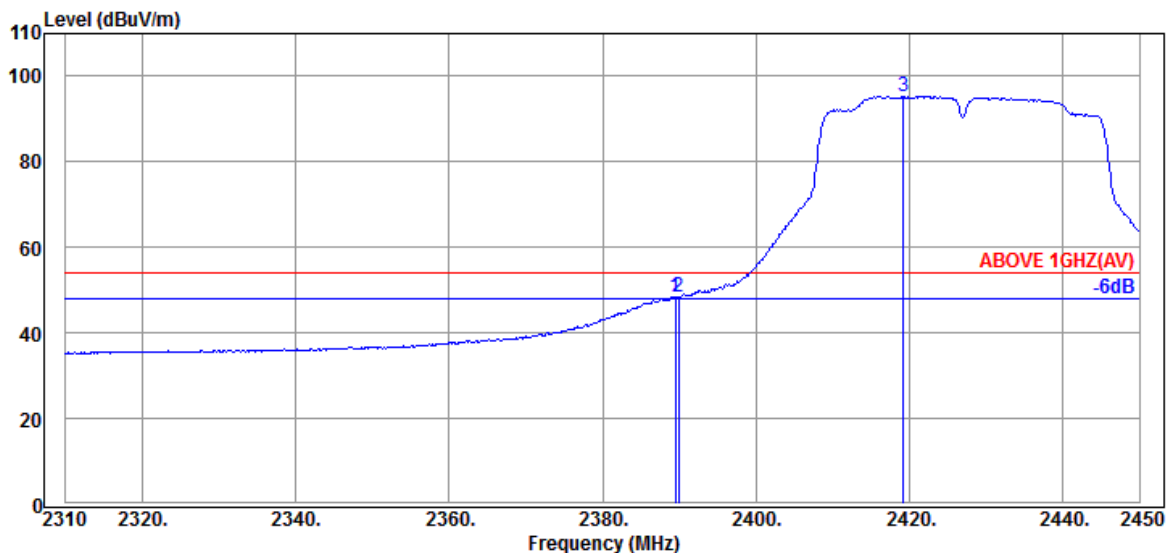

Antenna at Vertical Polarization

Emission Frequency (MHz)	Antenna Factor (dB/m)	Cable Loss (dB)	Preamplifier Gain (dB)	Read Level (dBμV)	Emission Level (dBμV/m)	Limits (dBμV/m)	Margin (dB)	Detector
2389.520	32.44	7.95	34.58	42.49	48.30	54.00	5.70	Average
2389.940	32.44	7.95	34.58	42.60	48.41	54.00	5.59	Average
@ 2419.200	32.29	7.96	34.59	89.67	95.33	---	---	Average

Remark: The "@" means fundamental frequency, it is ignored in this section.

Mode	802.11n-HT40	Frequency	TX 2447MHz
------	--------------	-----------	------------

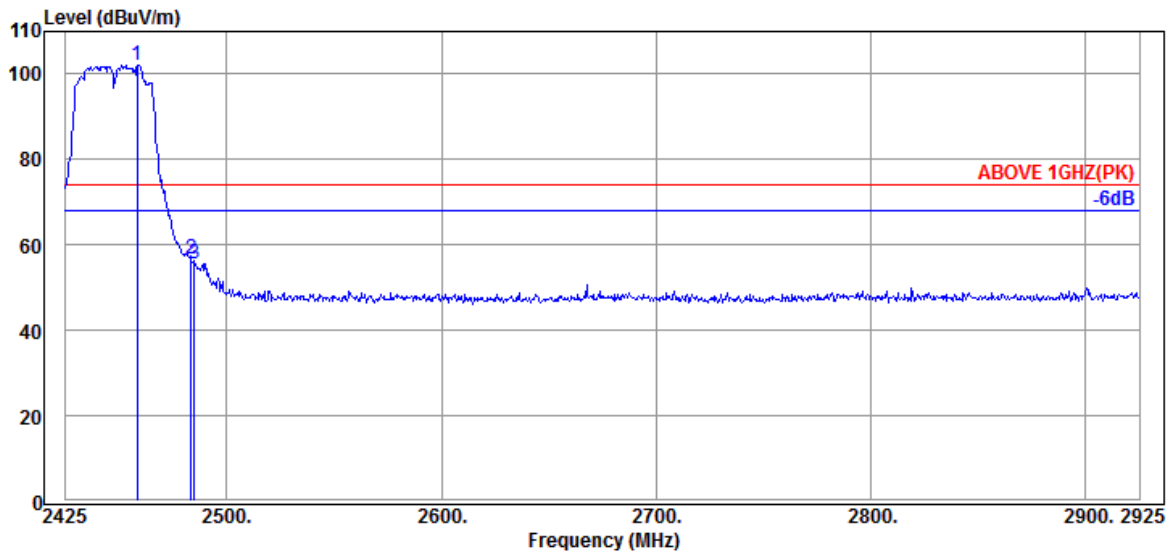

Antenna at Horizontal Polarization

Emission Frequency (MHz)	Antenna Factor (dB/m)	Cable Loss (dB)	Preamplifier Gain (dB)	Read Level (dBμV)	Emission Level (dBμV/m)	Limits (dBμV/m)	Margin (dB)	Detector
@ 2458.500	32.03	7.98	34.60	96.81	102.22	---	---	Peak
2483.500	32.14	7.99	34.61	51.03	56.55	74.00	17.45	Peak
2485.000	32.14	7.99	34.61	50.13	55.65	74.00	18.35	Peak

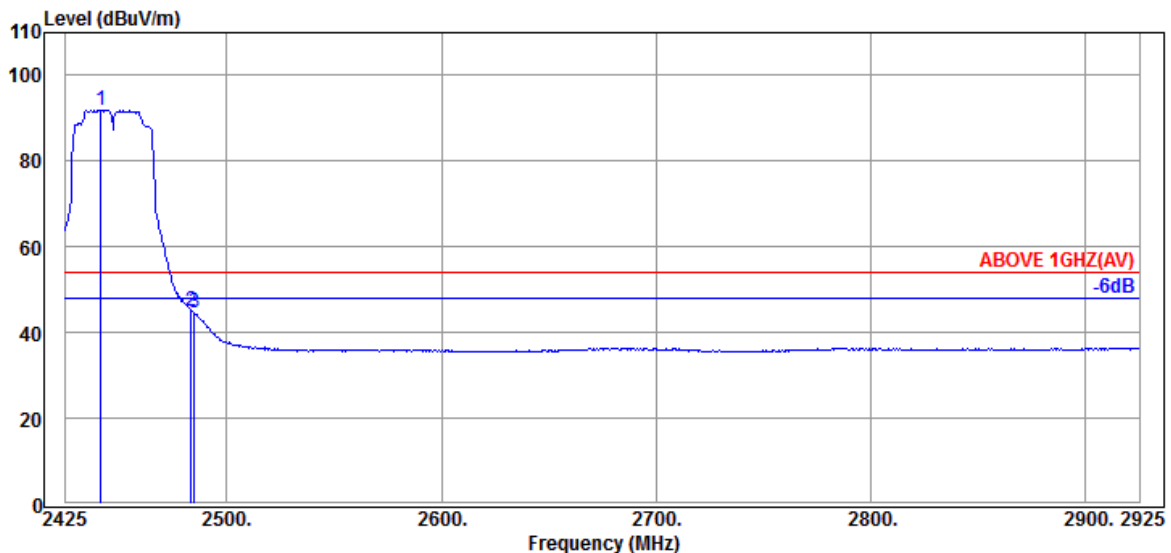

Antenna at Horizontal Polarization

Emission Frequency (MHz)	Antenna Factor (dB/m)	Cable Loss (dB)	Preamplifier Gain (dB)	Read Level (dBμV)	Emission Level (dBμV/m)	Limits (dBμV/m)	Margin (dB)	Detector
@ 2441.500	32.07	7.98	34.59	86.44	91.90	---	---	Average
2483.500	32.14	7.99	34.61	39.55	45.07	54.00	8.93	Average
2485.000	32.14	7.99	34.61	39.17	44.69	54.00	9.31	Average

Remark: The “@” means fundamental frequency, it is ignored in this section.

Mode	802.11n-HT40	Frequency	TX 2447MHz
------	--------------	-----------	------------

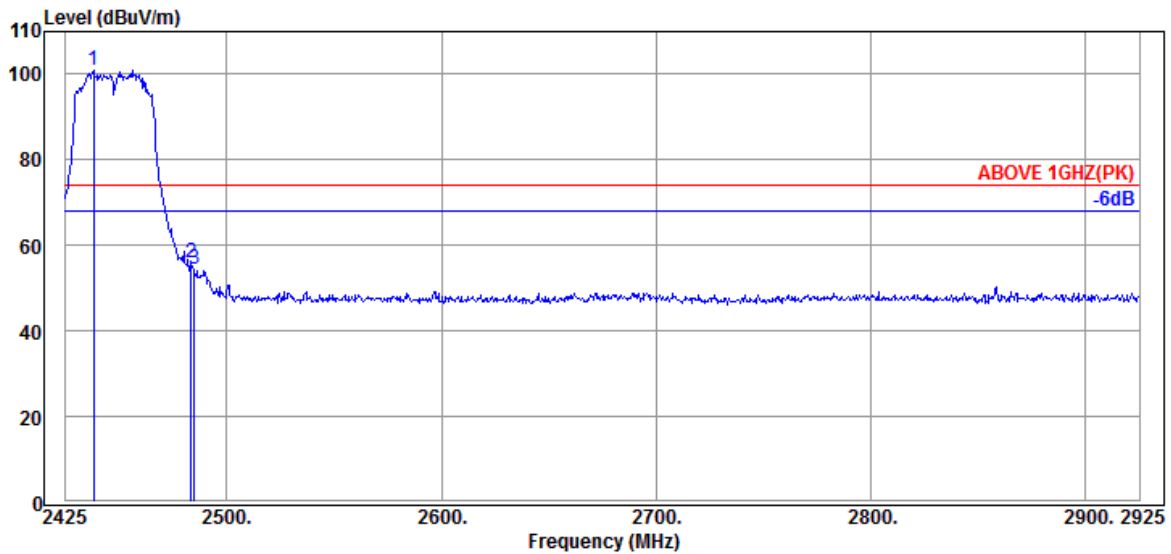

Antenna at Vertical Polarization

Emission Frequency (MHz)	Antenna Factor (dB/m)	Cable Loss (dB)	Preamplifier Gain (dB)	Read Level (dBμV)	Emission Level (dBμV/m)	Limits (dBμV/m)	Margin (dB)	Detector
@ 2438.000	32.14	7.97	34.59	95.34	100.86	---	---	Peak
2483.500	32.14	7.99	34.61	50.47	55.99	74.00	18.01	Peak
2485.000	32.14	7.99	34.61	48.76	54.28	74.00	19.72	Peak

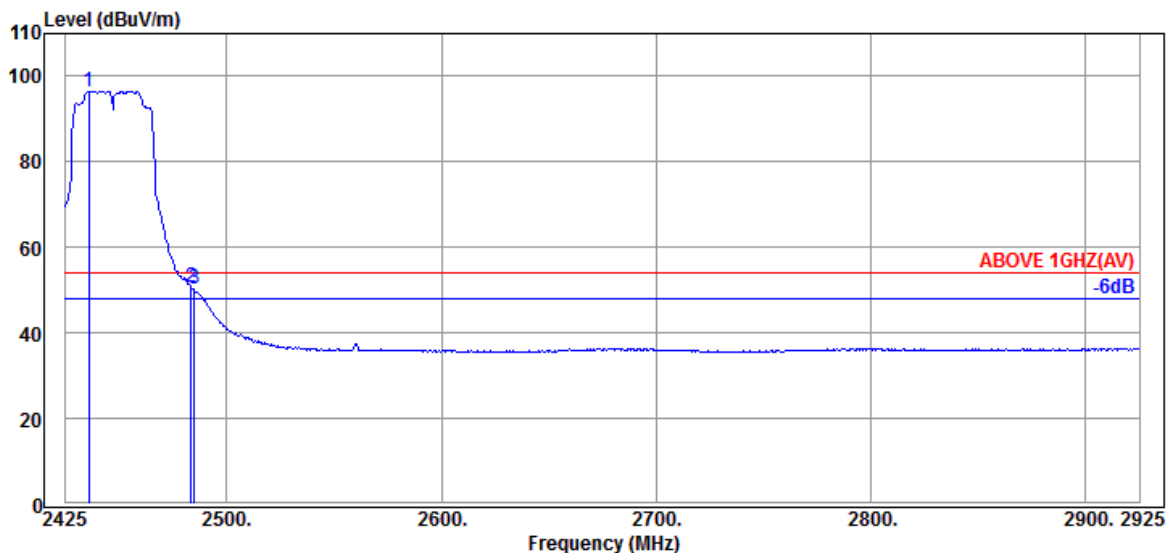

Antenna at Vertical Polarization

Emission Frequency (MHz)	Antenna Factor (dB/m)	Cable Loss (dB)	Preamplifier Gain (dB)	Read Level (dBμV)	Emission Level (dBμV/m)	Limits (dBμV/m)	Margin (dB)	Detector
@ 2436.000	32.14	7.97	34.59	91.00	96.52	---	---	Average
2483.500	32.14	7.99	34.61	44.99	50.51	54.00	3.49	Average
2485.000	32.14	7.99	34.61	44.70	50.22	54.00	3.78	Average

Remark: The "@" means fundamental frequency, it is ignored in this section.

Mode	802.11n-HT40	Frequency	TX 2452MHz
------	--------------	-----------	------------

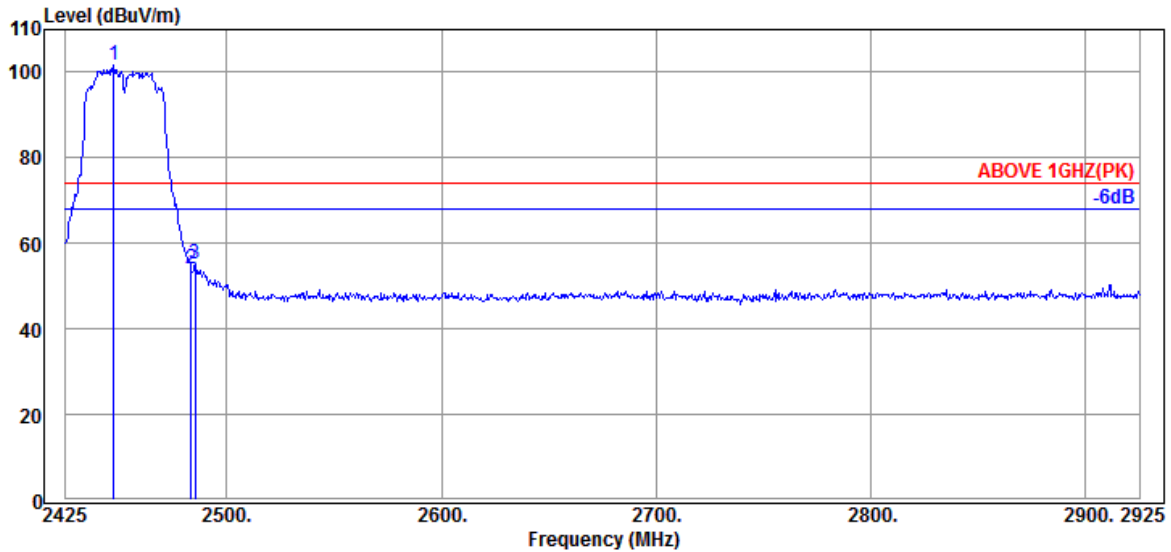

Antenna at Horizontal Polarization

Emission Frequency (MHz)	Antenna Factor (dB/m)	Cable Loss (dB)	Preamplifier Gain (dB)	Read Level (dBμV)	Emission Level (dBμV/m)	Limits (dBμV/m)	Margin (dB)	Detector
@ 2447.500	32.00	7.98	34.60	96.49	101.87	---	---	Peak
2483.500	32.14	7.99	34.61	48.58	54.10	74.00	19.90	Peak
2485.500	32.14	7.99	34.61	49.66	55.18	74.00	18.82	Peak

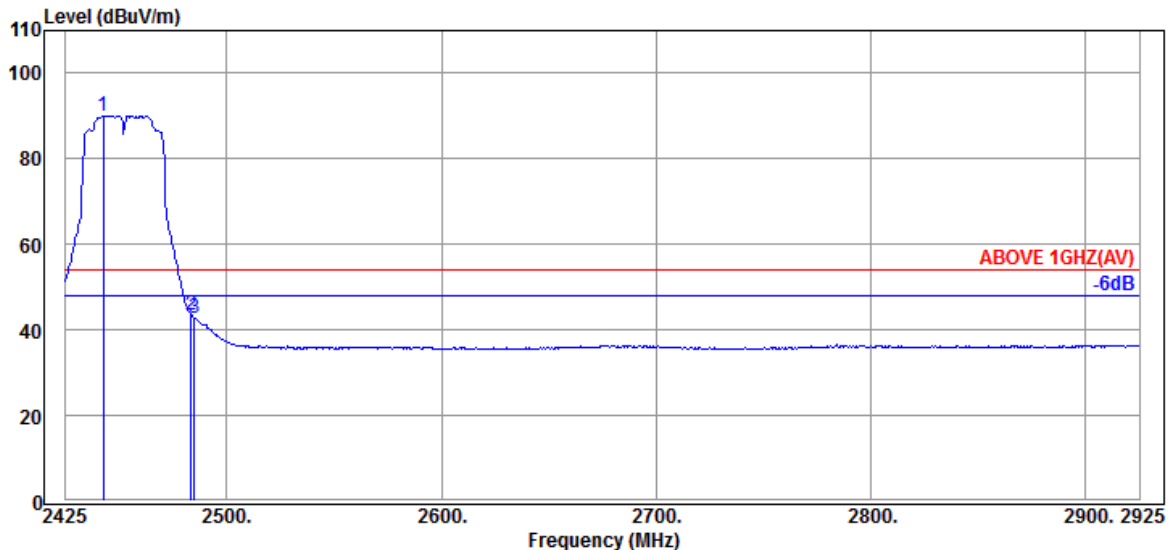

Antenna at Horizontal Polarization

Emission Frequency (MHz)	Antenna Factor (dB/m)	Cable Loss (dB)	Preamplifier Gain (dB)	Read Level (dBμV)	Emission Level (dBμV/m)	Limits (dBμV/m)	Margin (dB)	Detector
@ 2442.500	32.07	7.98	34.60	84.67	90.12	---	---	Average
2483.500	32.14	7.99	34.61	37.88	43.40	54.00	10.60	Average
2485.000	32.14	7.99	34.61	37.12	42.64	54.00	11.36	Average

Remark: The “@” means fundamental frequency, it is ignored in this section.

Mode	802.11n-HT40	Frequency	TX 2452MHz
------	--------------	-----------	------------

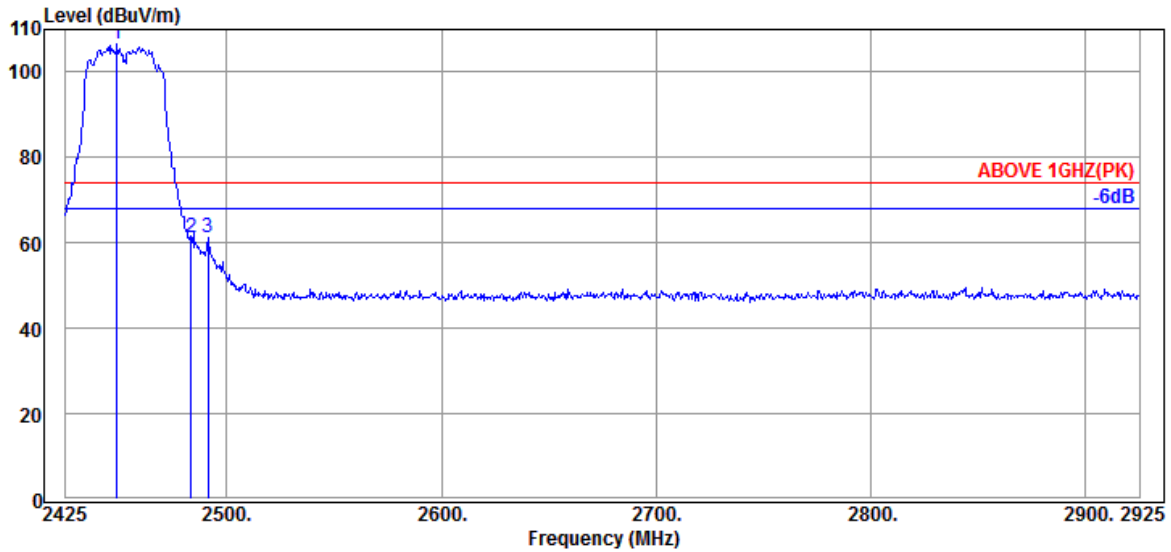

Antenna at Vertical Polarization

Emission Frequency (MHz)	Antenna Factor (dB/m)	Cable Loss (dB)	Preamplifier Gain (dB)	Read Level (dBμV)	Emission Level (dBμV/m)	Limits (dBμV/m)	Margin (dB)	Detector
@ 2449.000	32.00	7.98	34.60	101.11	106.49	---	---	Peak
2483.500	32.14	7.99	34.61	55.75	61.27	74.00	12.73	Peak
2491.500	32.17	8.00	34.61	55.53	61.09	74.00	12.91	Peak

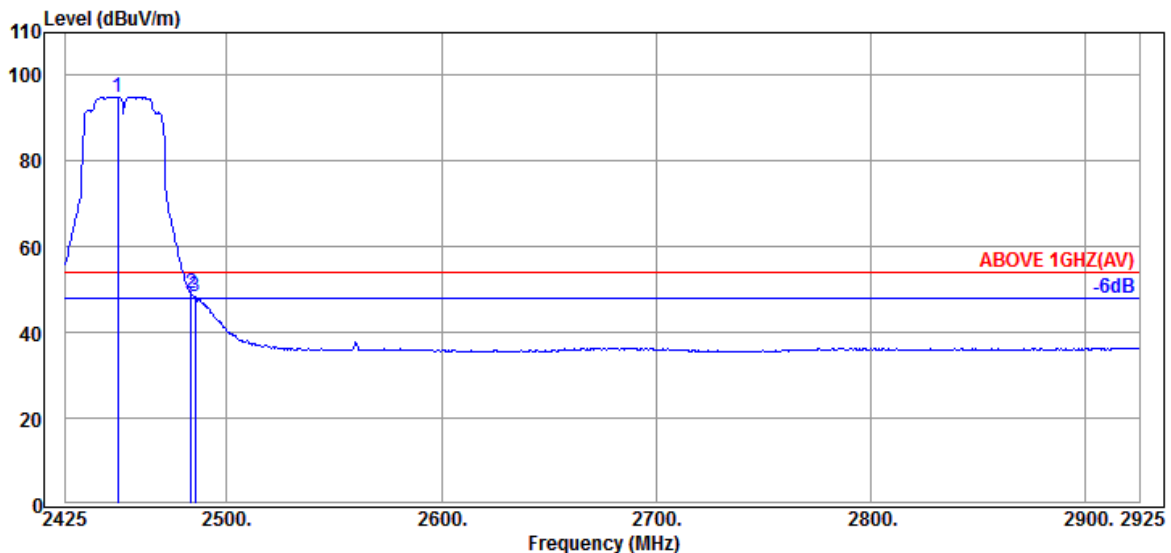

Antenna at Vertical Polarization

Emission Frequency (MHz)	Antenna Factor (dB/m)	Cable Loss (dB)	Preamplifier Gain (dB)	Read Level (dBμV)	Emission Level (dBμV/m)	Limits (dBμV/m)	Margin (dB)	Detector
@ 2449.500	32.00	7.98	34.60	89.69	95.07	---	---	Average
2483.500	32.14	7.99	34.61	43.64	49.16	54.00	4.84	Average
2485.500	32.14	7.99	34.61	42.74	48.26	54.00	5.74	Average

Remark: The "@" means fundamental frequency, it is ignored in this section.

Mode	802.11n-HT40	Frequency	TX 2457MHz
------	--------------	-----------	------------

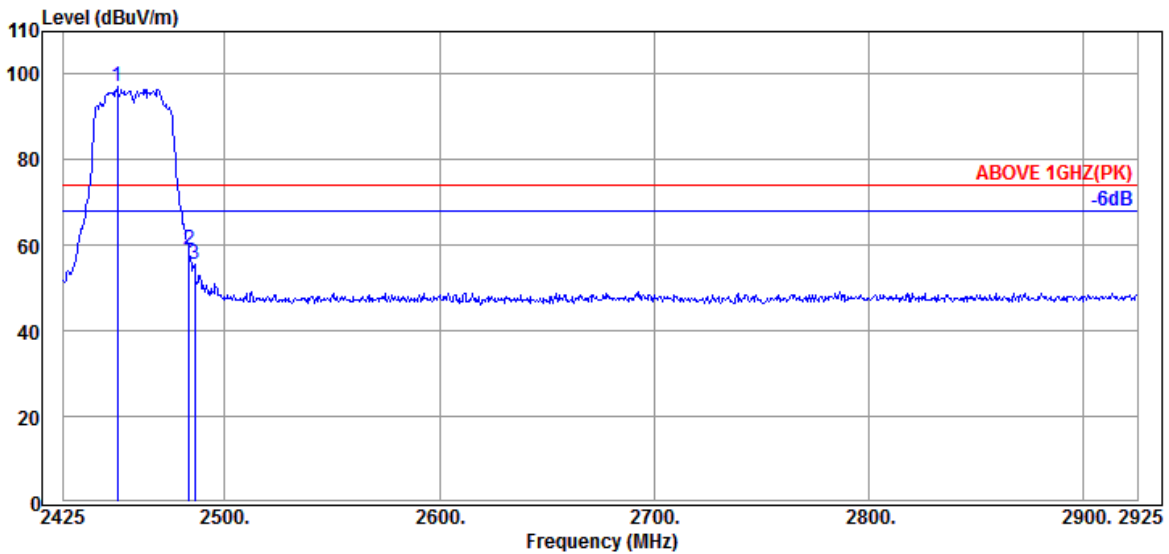

Antenna at Horizontal Polarization

Emission Frequency (MHz)	Antenna Factor (dB/m)	Cable Loss (dB)	Preamplifier Gain (dB)	Read Level (dBμV)	Emission Level (dBμV/m)	Limits (dBμV/m)	Margin (dB)	Detector
@ 2450.000	32.00	7.98	34.60	91.59	96.97	---	---	Peak
2483.500	32.14	7.99	34.61	53.40	58.92	74.00	15.08	Peak
2486.000	32.14	8.00	34.61	49.95	55.48	74.00	18.52	Peak

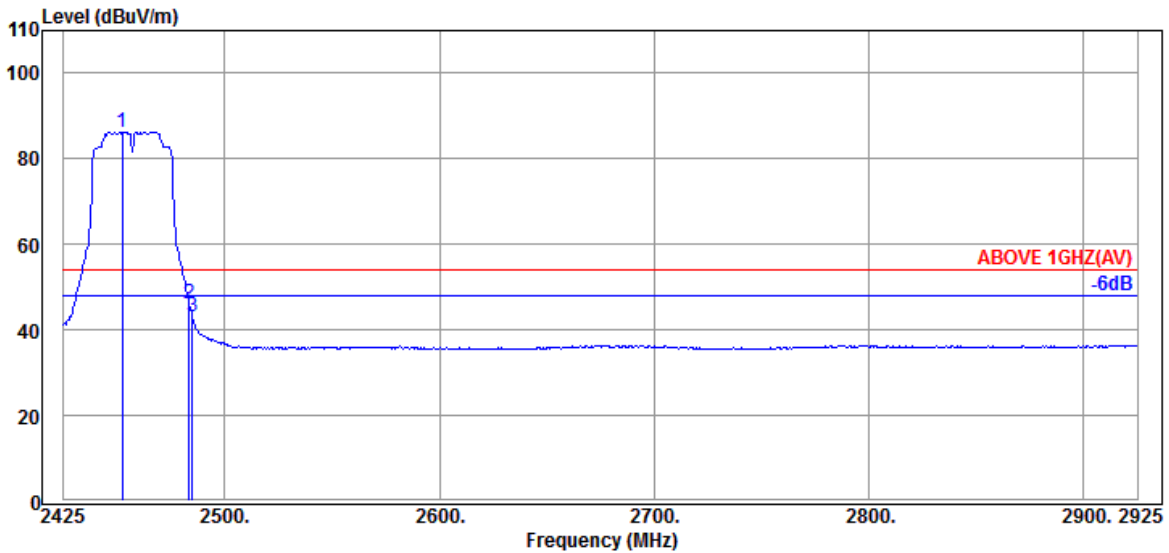

Antenna at Horizontal Polarization

Emission Frequency (MHz)	Antenna Factor (dB/m)	Cable Loss (dB)	Preamplifier Gain (dB)	Read Level (dBμV)	Emission Level (dBμV/m)	Limits (dBμV/m)	Margin (dB)	Detector
@ 2452.500	32.00	7.98	34.60	80.85	86.23	---	---	Average
2483.500	32.14	7.99	34.61	40.77	46.29	54.00	7.71	Average
2485.000	32.14	7.99	34.61	37.42	42.94	54.00	11.06	Average

Remark: The "@" means fundamental frequency, it is ignored in this section.

Mode	802.11n-HT40	Frequency	TX 2457MHz
------	--------------	-----------	------------

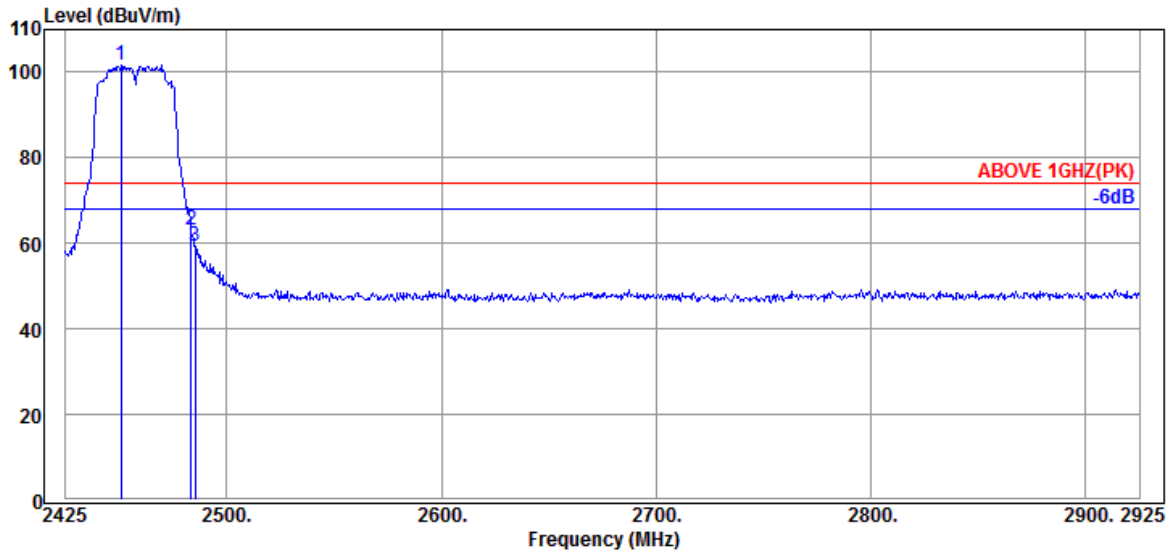

Antenna at Vertical Polarization

Emission Frequency (MHz)	Antenna Factor (dB/m)	Cable Loss (dB)	Preamplifier Gain (dB)	Read Level (dBμV)	Emission Level (dBμV/m)	Limits (dBμV/m)	Margin (dB)	Detector
@ 2451.000	32.00	7.98	34.60	96.47	101.85	---	---	Peak
2483.500	32.14	7.99	34.61	57.56	63.08	74.00	10.92	Peak
2485.500	32.14	7.99	34.61	53.82	59.34	74.00	14.66	Peak

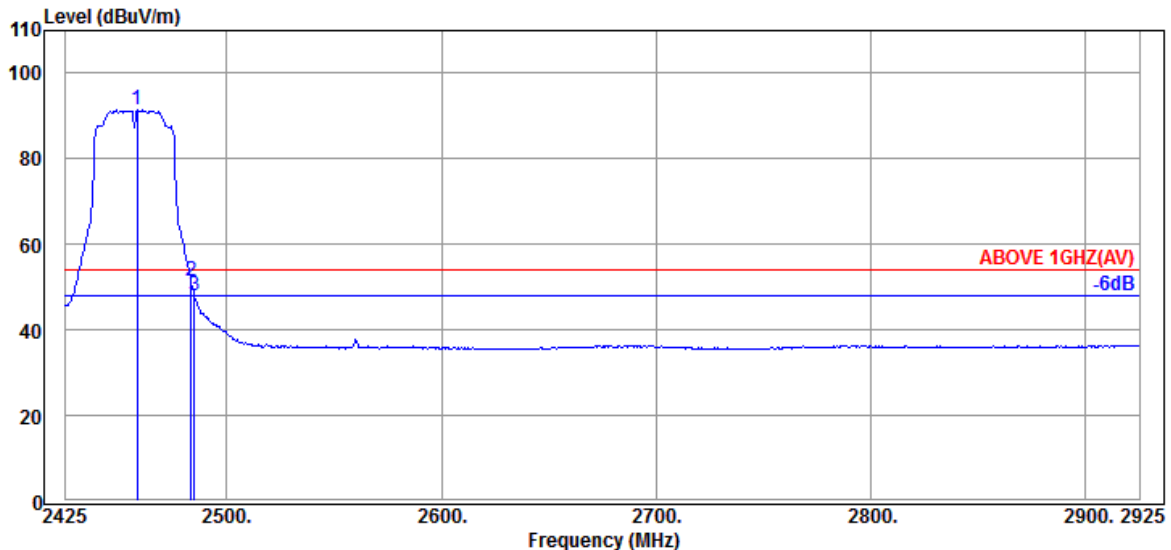

Antenna at Vertical Polarization

Emission Frequency (MHz)	Antenna Factor (dB/m)	Cable Loss (dB)	Preamplifier Gain (dB)	Read Level (dBμV)	Emission Level (dBμV/m)	Limits (dBμV/m)	Margin (dB)	Detector
@ 2458.500	32.03	7.98	34.60	85.98	91.39	---	---	Average
2483.500	32.14	7.99	34.61	45.88	51.40	54.00	2.60	Average
2485.000	32.14	7.99	34.61	42.40	47.92	54.00	6.08	Average

Remark: The "@" means fundamental frequency, it is ignored in this section.

Mode	802.11n-HT40	Frequency	TX 2462MHz
------	--------------	-----------	------------

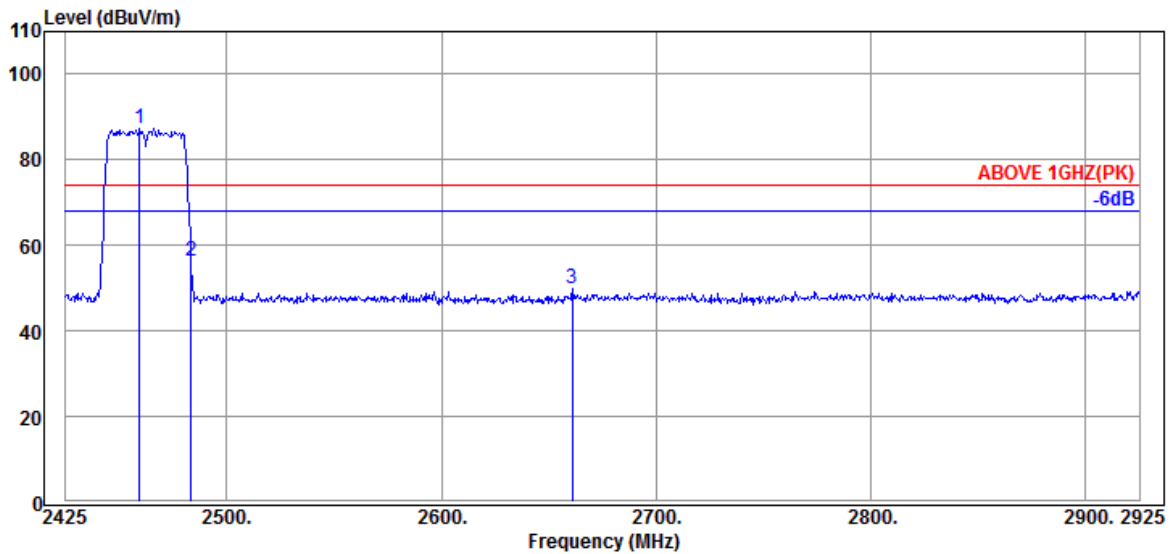

Antenna at Horizontal Polarization

Emission Frequency (MHz)	Antenna Factor (dB/m)	Cable Loss (dB)	Preamplifier Gain (dB)	Read Level (dBμV)	Emission Level (dBμV/m)	Limits (dBμV/m)	Margin (dB)	Detector
@ 2459.500	32.03	7.98	34.60	81.83	87.24	---	---	Peak
2483.500	32.14	7.99	34.61	50.90	56.42	74.00	17.58	Peak
2661.000	32.26	8.08	34.64	44.31	50.01	74.00	23.99	Peak

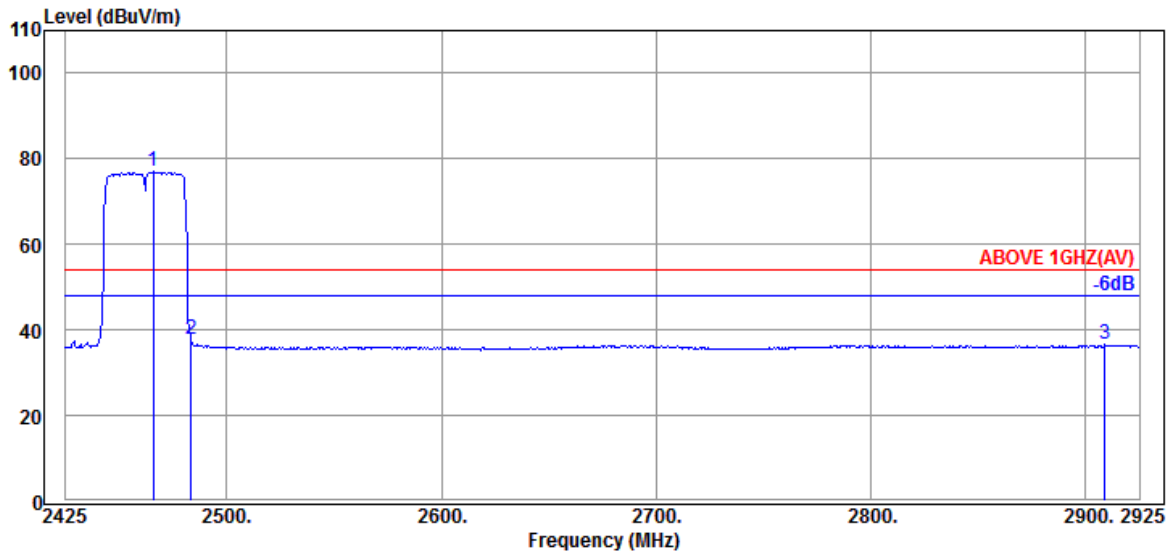

Antenna at Horizontal Polarization

Emission Frequency (MHz)	Antenna Factor (dB/m)	Cable Loss (dB)	Preamplifier Gain (dB)	Read Level (dBμV)	Emission Level (dBμV/m)	Limits (dBμV/m)	Margin (dB)	Detector
@ 2466.000	32.06	7.98	34.60	71.50	76.94	---	---	Average
2483.500	32.14	7.99	34.61	32.21	37.73	54.00	16.27	Average
2909.000	32.83	8.18	34.69	30.25	36.57	54.00	17.43	Average

Remark: The “@” means fundamental frequency, it is ignored in this section.

Mode	802.11n-HT40	Frequency	TX 2462MHz
------	--------------	-----------	------------

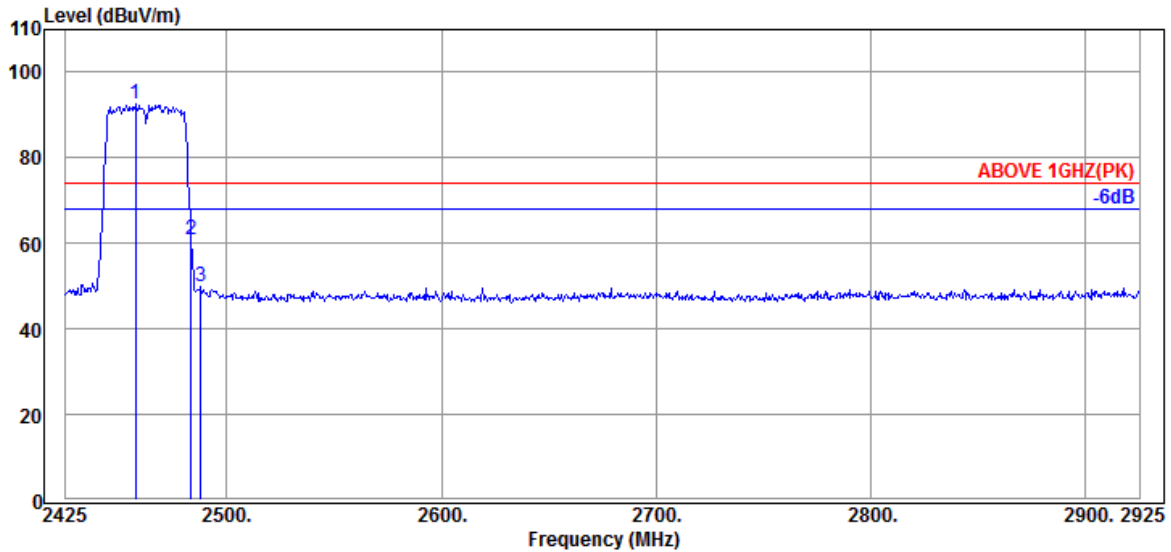

Antenna at Vertical Polarization

Emission Frequency (MHz)	Antenna Factor (dB/m)	Cable Loss (dB)	Preamplifier Gain (dB)	Read Level (dBμV)	Emission Level (dBμV/m)	Limits (dBμV/m)	Margin (dB)	Detector
@ 2457.500	32.03	7.98	34.60	87.08	92.49	---	---	Peak
2483.500	32.14	7.99	34.61	55.28	60.80	74.00	13.20	Peak
2488.000	32.14	8.00	34.61	44.20	49.73	74.00	24.27	Peak

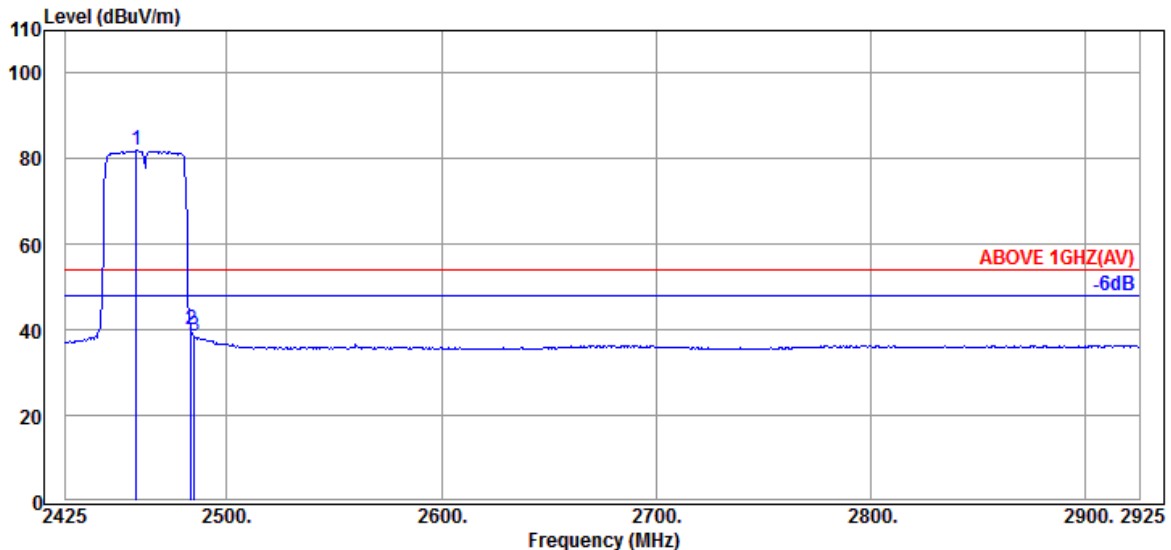

Antenna at Vertical Polarization

Emission Frequency (MHz)	Antenna Factor (dB/m)	Cable Loss (dB)	Preamplifier Gain (dB)	Read Level (dBμV)	Emission Level (dBμV/m)	Limits (dBμV/m)	Margin (dB)	Detector
@ 2458.000	32.03	7.98	34.60	76.48	81.89	---	---	Average
2483.500	32.14	7.99	34.61	34.65	40.17	54.00	13.83	Average
2485.000	32.14	7.99	34.61	32.98	38.50	54.00	15.50	Average

Remark: The "@" means fundamental frequency, it is ignored in this section.

Mode	802.11ax-HE20	Frequency	TX 2412MHz
------	---------------	-----------	------------

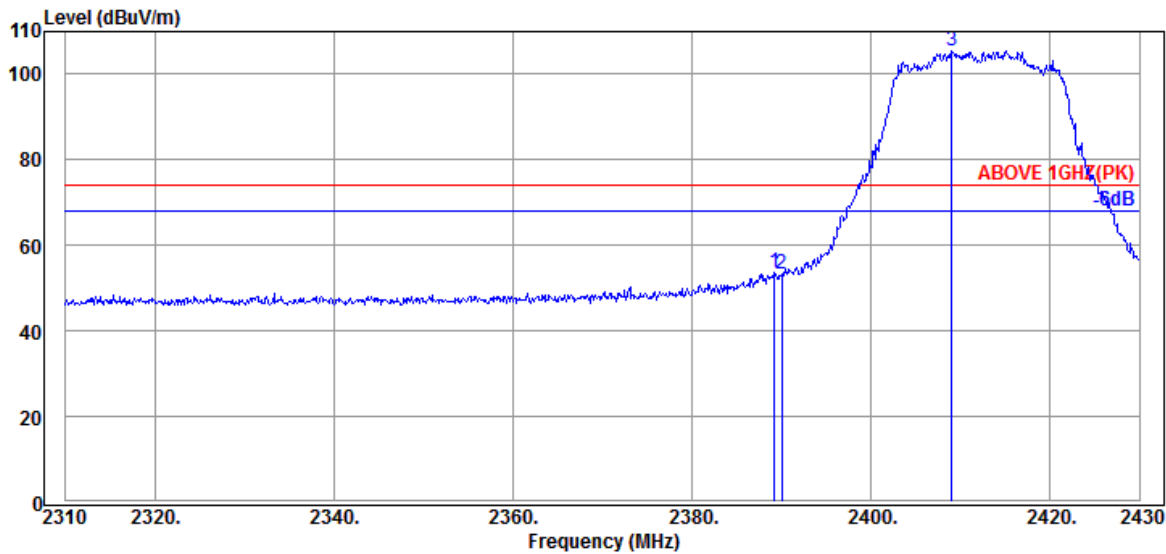

Antenna at Horizontal Polarization

Emission Frequency (MHz)	Antenna Factor (dB/m)	Cable Loss (dB)	Preamplifier Gain (dB)	Read Level (dBμV)	Emission Level (dBμV/m)	Limits (dBμV/m)	Margin (dB)	Detector
2389.200	32.44	7.95	34.58	47.84	53.65	74.00	20.35	Peak
2390.040	32.44	7.95	34.58	47.33	53.14	74.00	20.86	Peak
@ 2409.000	32.43	7.96	34.59	99.56	105.36	---	---	Peak

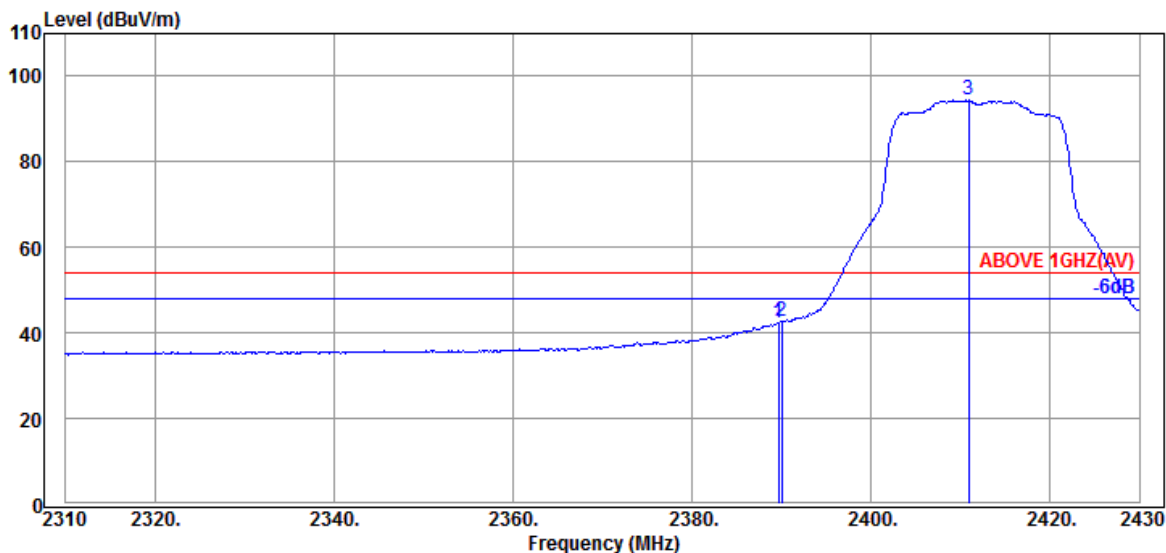

Antenna at Horizontal Polarization

Emission Frequency (MHz)	Antenna Factor (dB/m)	Cable Loss (dB)	Preamplifier Gain (dB)	Read Level (dBμV)	Emission Level (dBμV/m)	Limits (dBμV/m)	Margin (dB)	Detector
2389.680	32.44	7.95	34.58	36.51	42.32	54.00	11.68	Average
2390.040	32.44	7.95	34.58	36.73	42.54	54.00	11.46	Average
@ 2410.920	32.43	7.96	34.59	88.65	94.45	---	---	Average

Remark: The “@” means fundamental frequency, it is ignored in this section.

Mode	802.11ax-HE20	Frequency	TX 2412MHz
------	---------------	-----------	------------

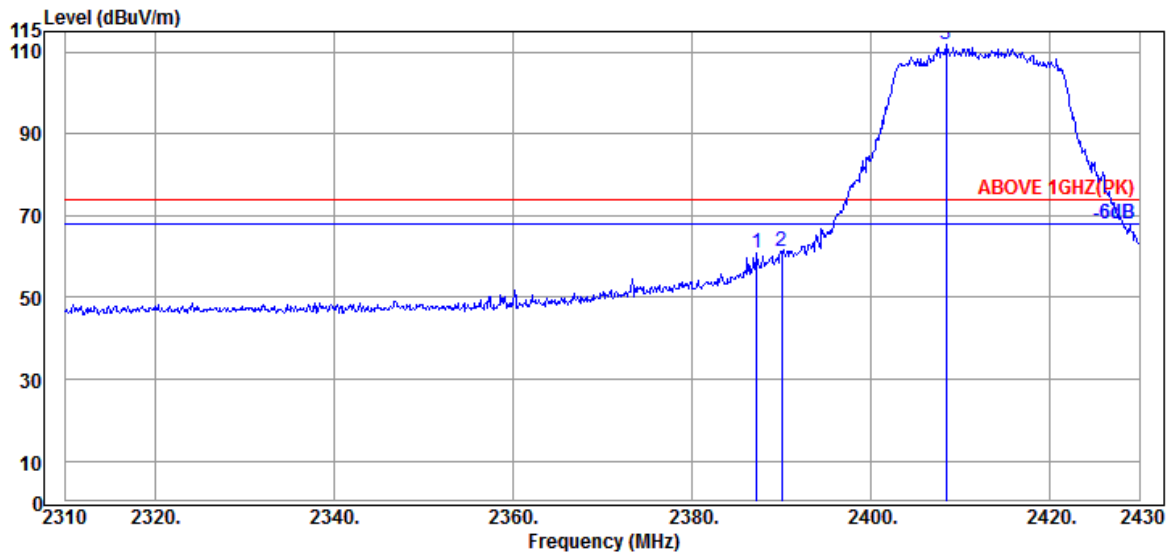

Antenna at Vertical Polarization

Emission Frequency (MHz)	Antenna Factor (dB/m)	Cable Loss (dB)	Preamplifier Gain (dB)	Read Level (dBμV)	Emission Level (dBμV/m)	Limits (dBμV/m)	Margin (dB)	Detector
2387.280	32.44	7.95	34.58	54.90	60.71	74.00	13.29	Peak
2390.040	32.44	7.95	34.58	55.44	61.25	74.00	12.75	Peak
@ 2408.400	32.43	7.96	34.59	105.98	111.78	---	---	Peak

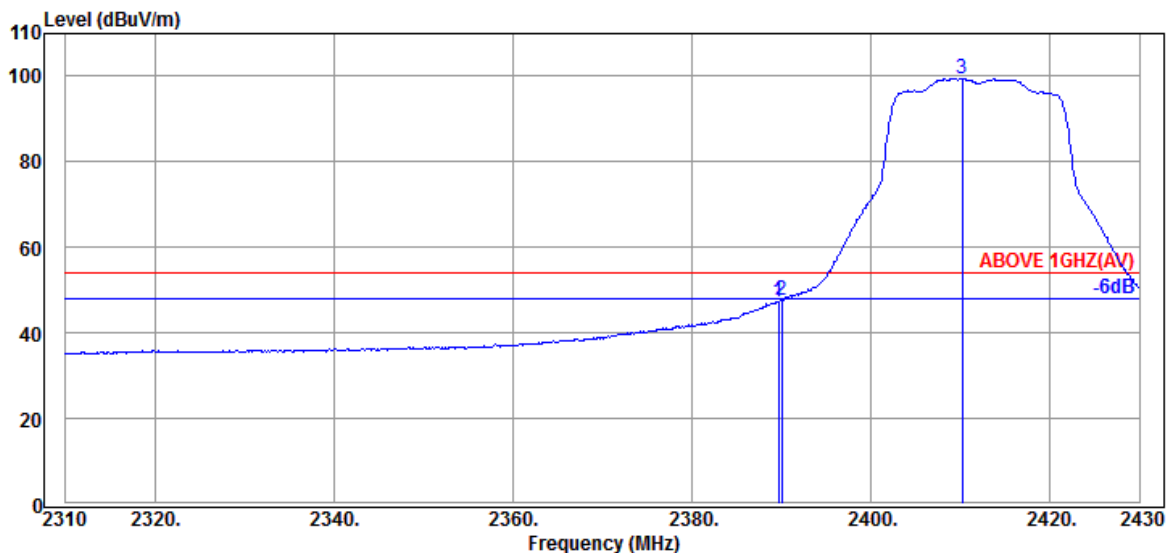

Antenna at Vertical Polarization

Emission Frequency (MHz)	Antenna Factor (dB/m)	Cable Loss (dB)	Preamplifier Gain (dB)	Read Level (dBμV)	Emission Level (dBμV/m)	Limits (dBμV/m)	Margin (dB)	Detector
2389.680	32.44	7.95	34.58	41.62	47.43	54.00	6.57	Average
2390.040	32.44	7.95	34.58	41.94	47.75	54.00	6.25	Average
@ 2410.200	32.43	7.96	34.59	93.79	99.59	---	---	Average

Remark: The “@” means fundamental frequency, it is ignored in this section.

Mode	802.11ax-HE20	Frequency	TX 2417MHz
------	---------------	-----------	------------

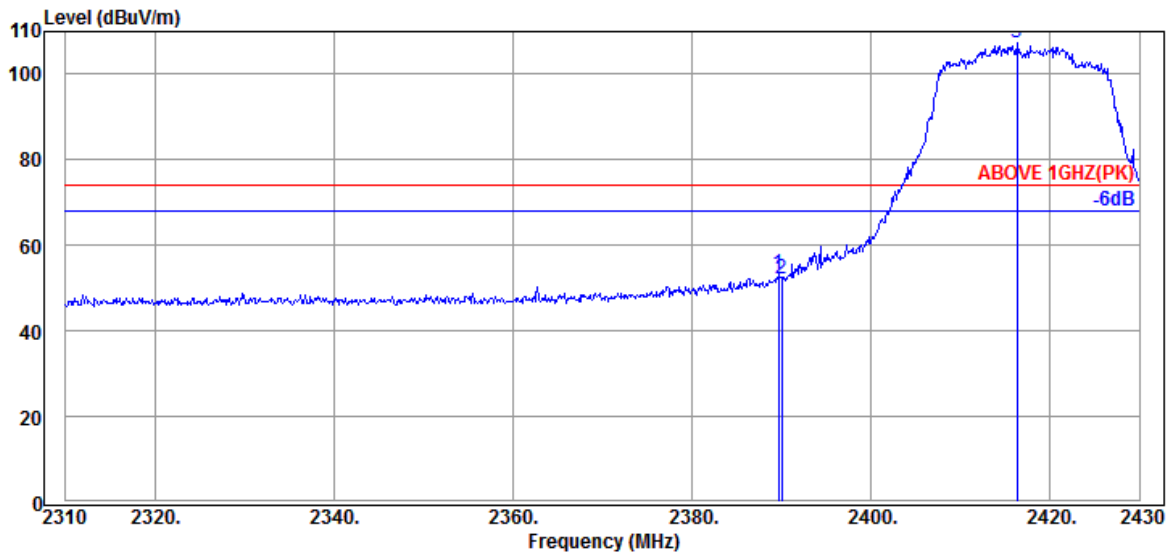

Antenna at Horizontal Polarization

Emission Frequency (MHz)	Antenna Factor (dB/m)	Cable Loss (dB)	Preamp Gain (dB)	Read Level (dBμV)	Emission Level (dBμV/m)	Limits (dBμV/m)	Margin (dB)	Detector
2389.680	32.44	7.95	34.58	47.56	53.37	74.00	20.63	Peak
2390.040	32.44	7.95	34.58	46.19	52.00	74.00	22.00	Peak
@ 2416.320	32.36	7.96	34.59	101.57	107.30	---	---	Peak

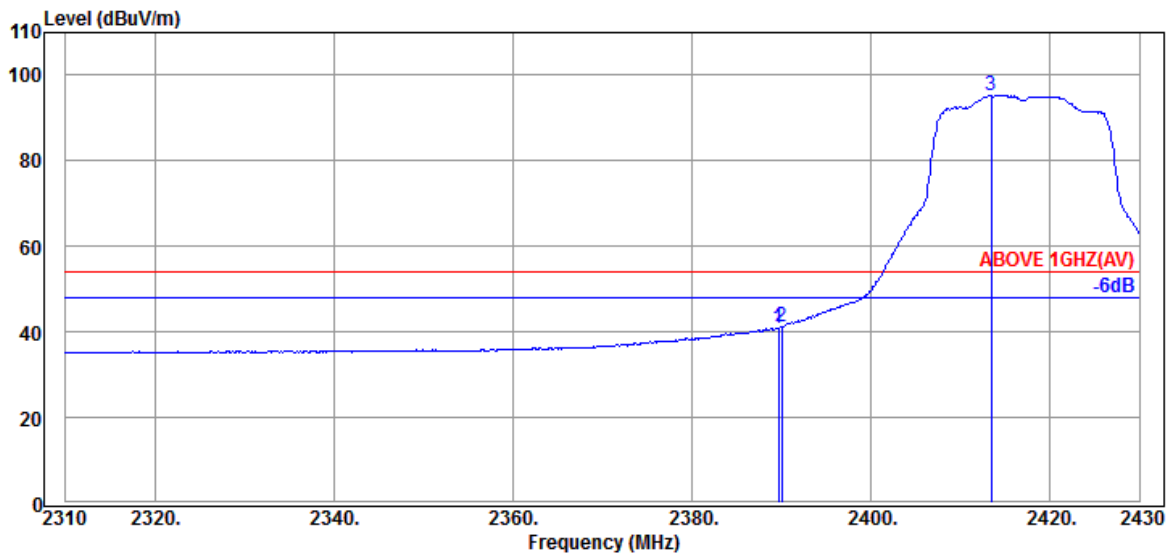

Antenna at Horizontal Polarization

Emission Frequency (MHz)	Antenna Factor (dB/m)	Cable Loss (dB)	Preamp Gain (dB)	Read Level (dBμV)	Emission Level (dBμV/m)	Limits (dBμV/m)	Margin (dB)	Detector
2389.680	32.44	7.95	34.58	35.14	40.95	54.00	13.05	Average
2390.040	32.44	7.95	34.58	35.38	41.19	54.00	12.81	Average
@ 2413.440	32.36	7.96	34.59	89.66	95.39	---	---	Average

Remark: The "@" means fundamental frequency, it is ignored in this section.

Mode	802.11ax-HE20	Frequency	TX 2417MHz
------	---------------	-----------	------------

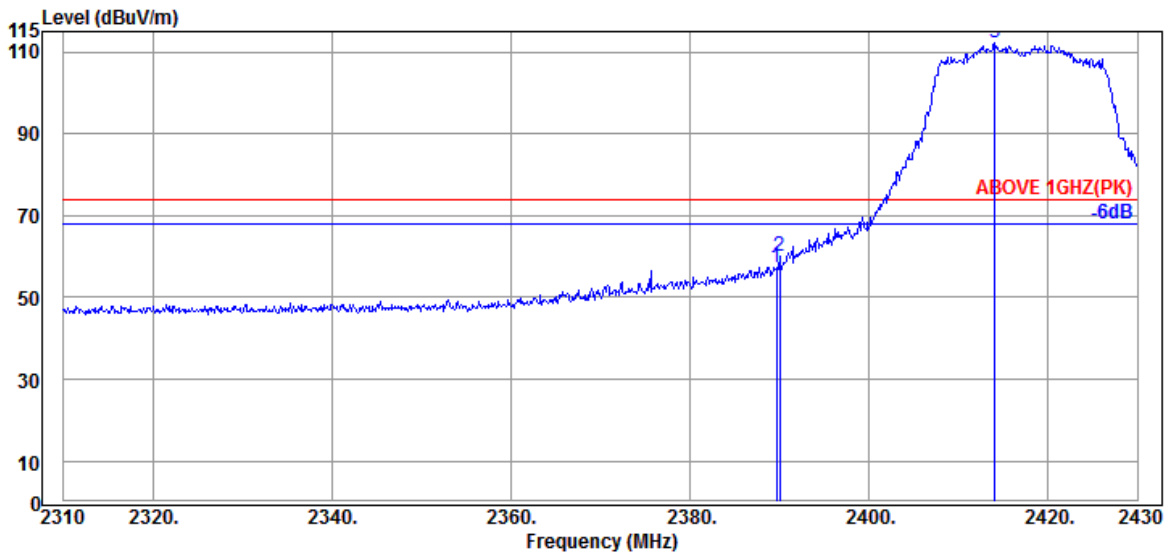

Antenna at Vertical Polarization

Emission Frequency (MHz)	Antenna Factor (dB/m)	Cable Loss (dB)	Preamplifier Gain (dB)	Read Level (dBμV)	Emission Level (dBμV/m)	Limits (dBμV/m)	Margin (dB)	Detector
2389.680	32.44	7.95	34.58	51.54	57.35	74.00	16.65	Peak
2390.040	32.44	7.95	34.58	54.20	60.01	74.00	13.99	Peak
@ 2414.040	32.36	7.96	34.59	106.36	112.09	---	---	Peak

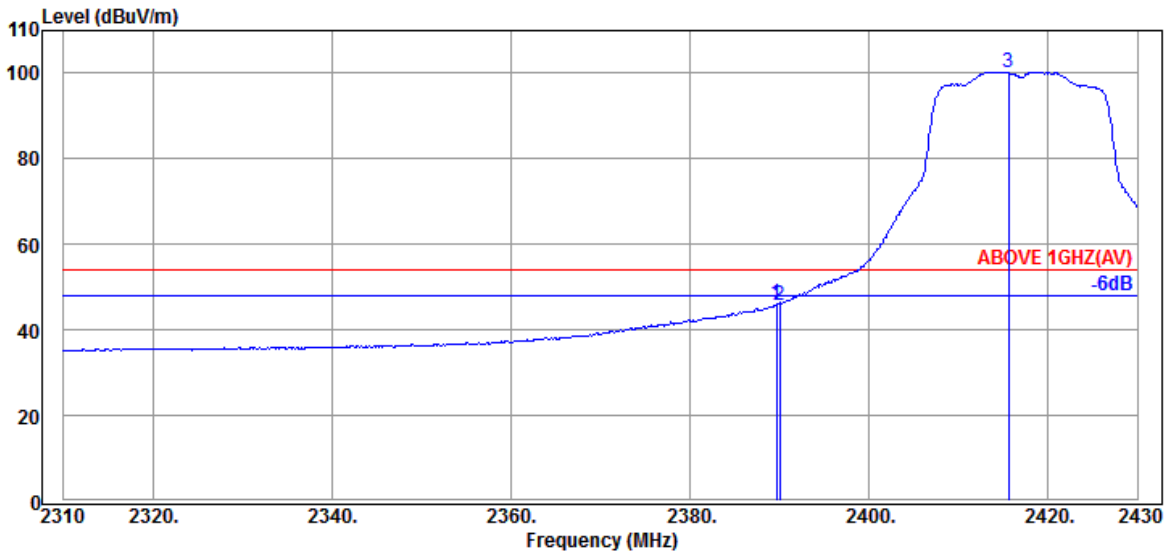

Antenna at Vertical Polarization

Emission Frequency (MHz)	Antenna Factor (dB/m)	Cable Loss (dB)	Preamplifier Gain (dB)	Read Level (dBμV)	Emission Level (dBμV/m)	Limits (dBμV/m)	Margin (dB)	Detector
2389.680	32.44	7.95	34.58	40.17	45.98	54.00	8.02	Average
2390.040	32.44	7.95	34.58	40.02	45.83	54.00	8.17	Average
@ 2415.600	32.36	7.96	34.59	94.59	100.32	---	---	Average

Remark: The “@” means fundamental frequency, it is ignored in this section.

Mode	802.11ax-HE20	Frequency	TX 2457MHz
------	---------------	-----------	------------

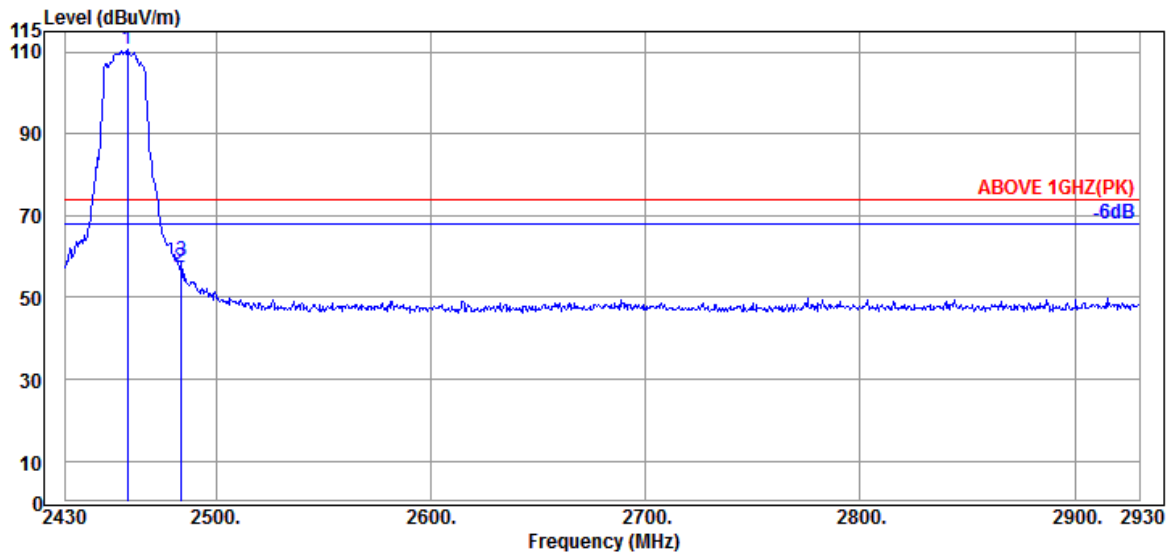

Antenna at Horizontal Polarization

Emission Frequency (MHz)	Antenna Factor (dB/m)	Cable Loss (dB)	Preamplifier Gain (dB)	Read Level (dBμV)	Emission Level (dBμV/m)	Limits (dBμV/m)	Margin (dB)	Detector
@ 2459.000	32.03	7.98	34.60	105.35	110.76	---	---	Peak
2483.500	32.14	7.99	34.61	51.60	57.12	74.00	16.88	Peak
2484.000	32.14	7.99	34.61	53.36	58.88	74.00	15.12	Peak

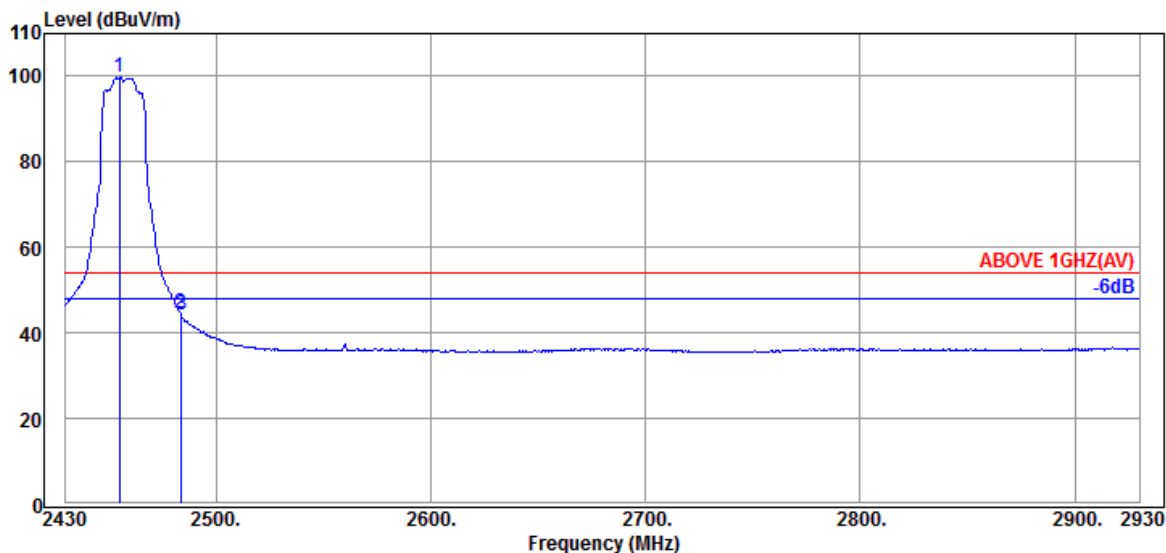

Antenna at Horizontal Polarization

Emission Frequency (MHz)	Antenna Factor (dB/m)	Cable Loss (dB)	Preamplifier Gain (dB)	Read Level (dBμV)	Emission Level (dBμV/m)	Limits (dBμV/m)	Margin (dB)	Detector
@ 2455.000	32.03	7.98	34.60	94.56	99.97	---	---	Average
2483.500	32.14	7.99	34.61	38.91	44.43	54.00	9.57	Average
2484.000	32.14	7.99	34.61	38.56	44.08	54.00	9.92	Average

Remark: The "@" means fundamental frequency, it is ignored in this section.

Mode	802.11ax-HE20	Frequency	TX 2457MHz
------	---------------	-----------	------------

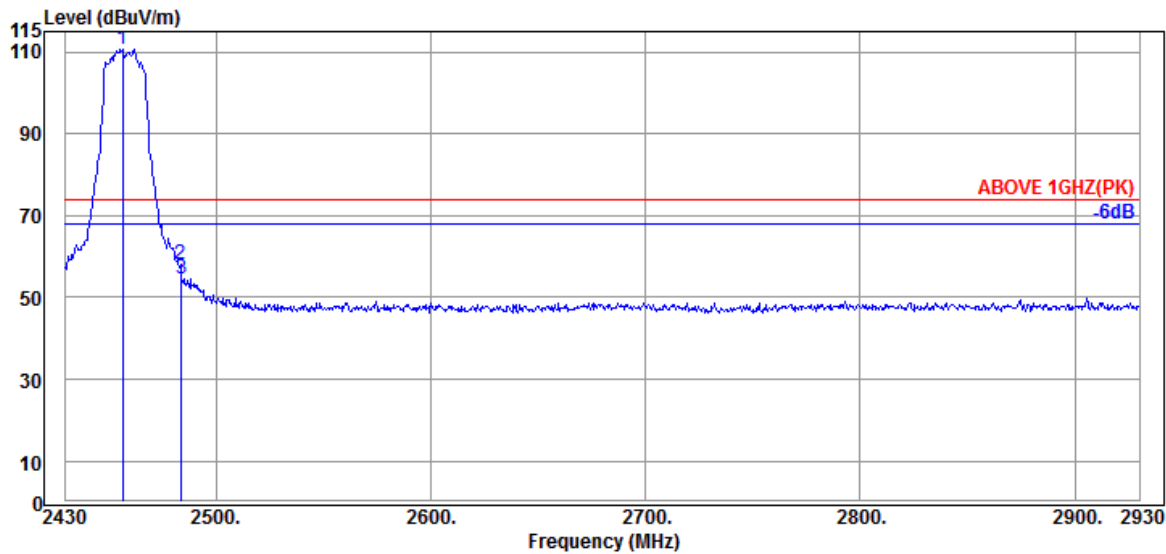

Antenna at Vertical Polarization

Emission Frequency (MHz)	Antenna Factor (dB/m)	Cable Loss (dB)	Preamplifier Gain (dB)	Read Level (dBμV)	Emission Level (dBμV/m)	Limits (dBμV/m)	Margin (dB)	Detector
@ 2456.500	32.03	7.98	34.60	105.27	110.68	---	---	Peak
2483.500	32.14	7.99	34.61	52.71	58.23	74.00	15.77	Peak
2484.000	32.14	7.99	34.61	49.15	54.67	74.00	19.33	Peak

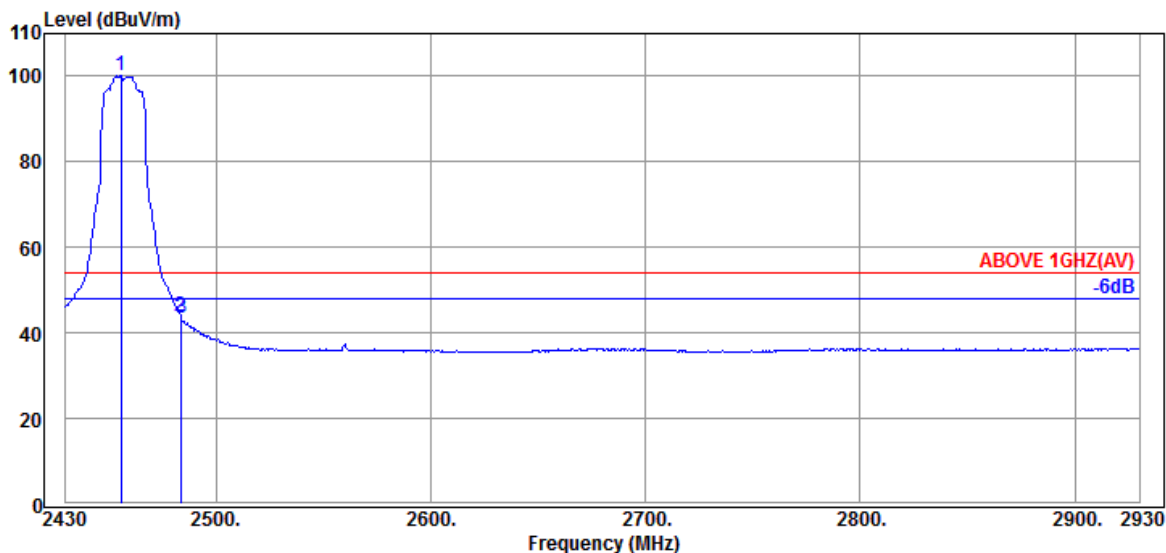

Antenna at Vertical Polarization

Emission Frequency (MHz)	Antenna Factor (dB/m)	Cable Loss (dB)	Preamplifier Gain (dB)	Read Level (dBμV)	Emission Level (dBμV/m)	Limits (dBμV/m)	Margin (dB)	Detector
@ 2456.000	32.03	7.98	34.60	94.74	100.15	---	---	Average
2483.500	32.14	7.99	34.61	38.46	43.98	54.00	10.02	Average
2484.000	32.14	7.99	34.61	38.12	43.64	54.00	10.36	Average

Remark: The “@” means fundamental frequency, it is ignored in this section.

Mode	802.11ax-HE20	Frequency	TX 2462MHz
------	---------------	-----------	------------

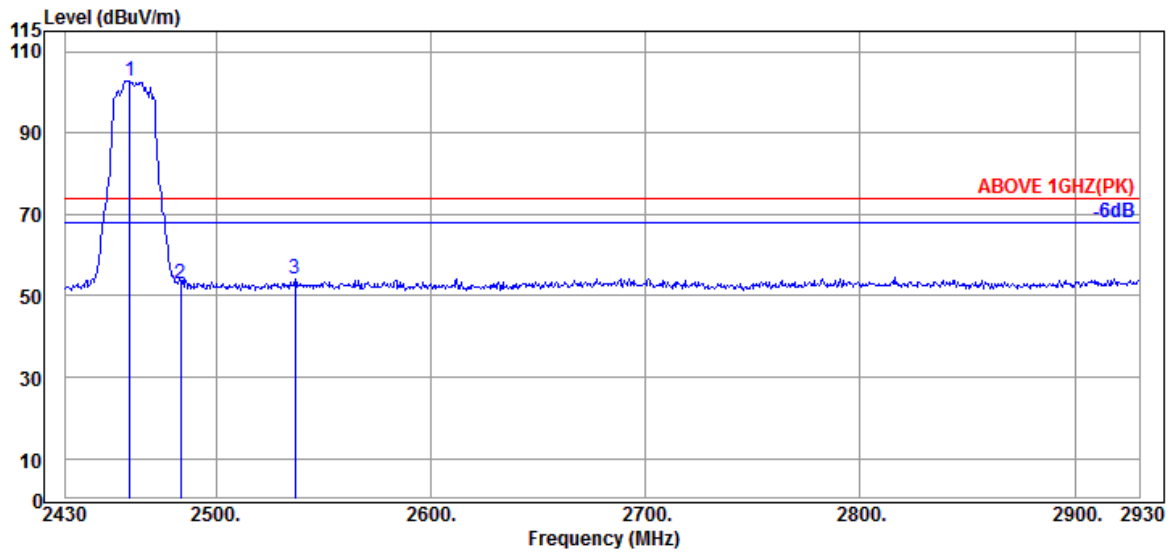

Antenna at Horizontal Polarization

Emission Frequency (MHz)	Antenna Factor (dB/m)	Cable Loss (dB)	Preamplifier Gain (dB)	Read Level (dBμV)	Emission Level (dBμV/m)	Limits (dBμV/m)	Margin (dB)	Detector
@ 2460.000	32.03	7.98	34.60	97.47	102.88	---	---	Peak
2483.500	32.14	7.99	34.61	47.47	52.99	74.00	21.01	Peak
2537.000	32.27	8.02	34.62	48.54	54.21	74.00	19.79	Peak

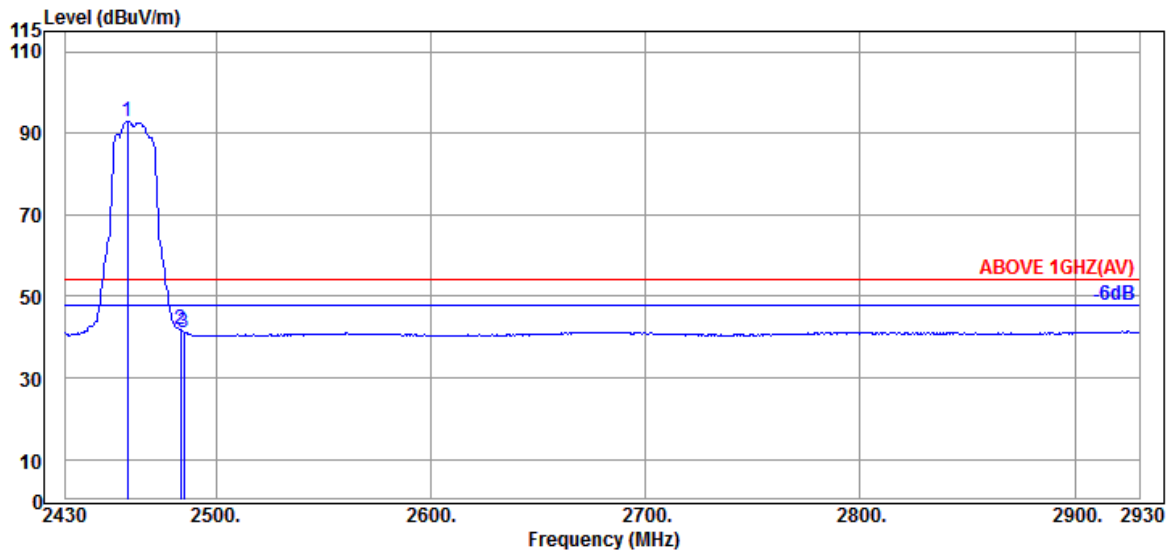

Antenna at Horizontal Polarization

Emission Frequency (MHz)	Antenna Factor (dB/m)	Cable Loss (dB)	Preamplifier Gain (dB)	Read Level (dBμV)	Emission Level (dBμV/m)	Limits (dBμV/m)	Margin (dB)	Detector
@ 2459.000	32.03	7.98	34.60	87.50	92.91	---	---	Average
2483.500	32.14	7.99	34.61	36.40	41.92	54.00	12.08	Average
2485.000	32.14	7.99	34.61	35.63	41.15	54.00	12.85	Average

Remark: The "@" means fundamental frequency, it is ignored in this section.

Mode	802.11ax-HE20	Frequency	TX 2462MHz
------	---------------	-----------	------------

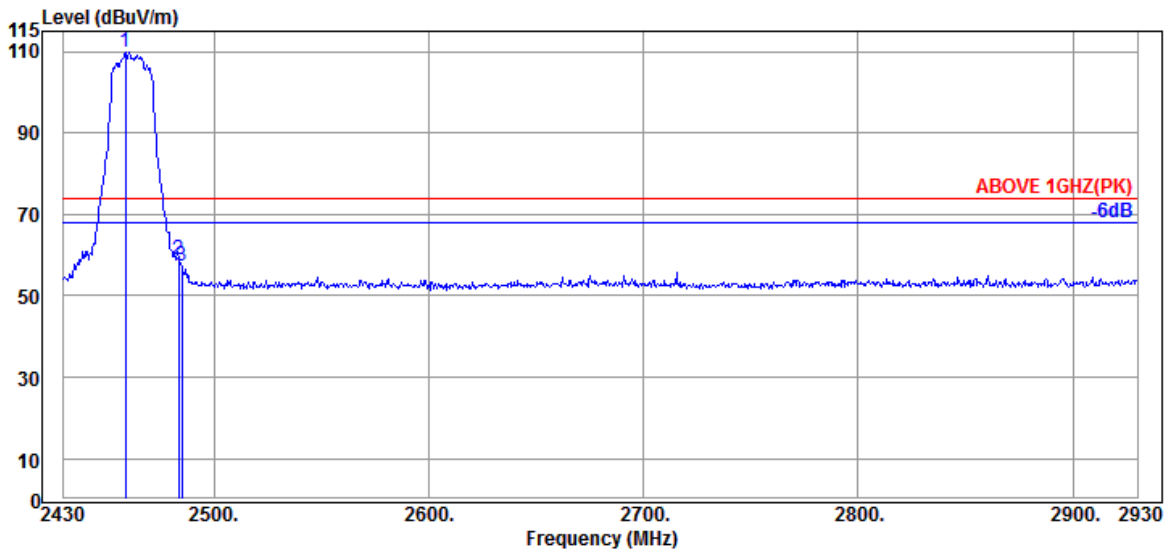

Antenna at Vertical Polarization

Emission Frequency (MHz)	Antenna Factor (dB/m)	Cable Loss (dB)	Preamplifier Gain (dB)	Read Level (dBμV)	Emission Level (dBμV/m)	Limits (dBμV/m)	Margin (dB)	Detector
@ 2459.000	32.03	7.98	34.60	104.55	109.96	---	---	Peak
2483.500	32.14	7.99	34.61	53.39	58.91	74.00	15.09	Peak
2485.000	32.14	7.99	34.61	51.94	57.46	74.00	16.54	Peak

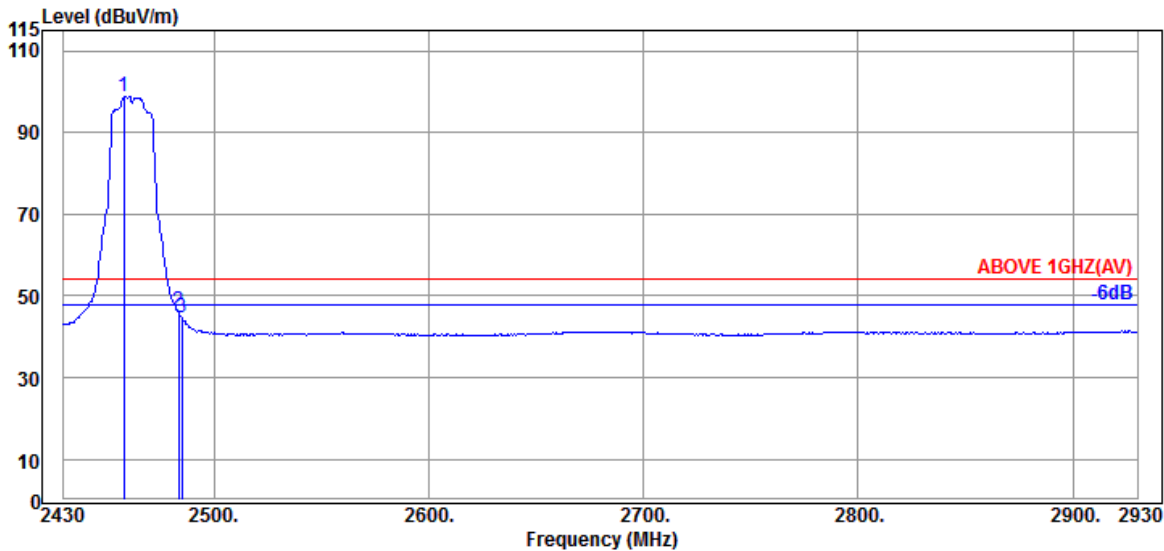

Antenna at Vertical Polarization

Emission Frequency (MHz)	Antenna Factor (dB/m)	Cable Loss (dB)	Preamplifier Gain (dB)	Read Level (dBμV)	Emission Level (dBμV/m)	Limits (dBμV/m)	Margin (dB)	Detector
@ 2458.000	32.03	7.98	34.60	93.40	98.81	---	---	Average
2483.500	32.14	7.99	34.61	40.78	46.30	54.00	7.70	Average
2485.000	32.14	7.99	34.61	39.10	44.62	54.00	9.38	Average

Remark: The “@” means fundamental frequency, it is ignored in this section.

Mode	802.11ax-HE20	Frequency	TX 2467MHz
------	---------------	-----------	------------

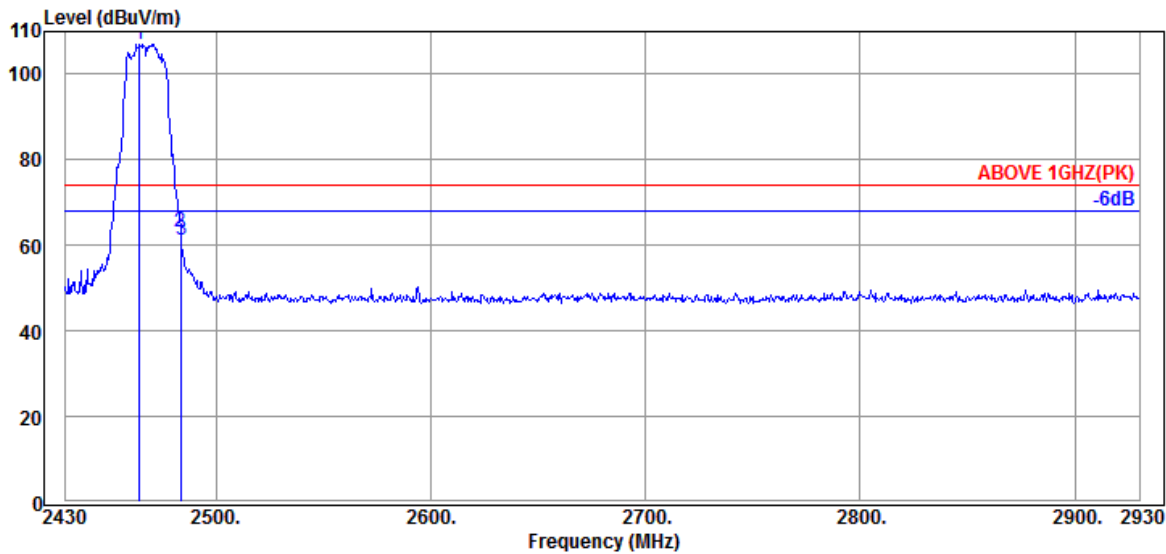

Antenna at Horizontal Polarization

Emission Frequency (MHz)	Antenna Factor (dB/m)	Cable Loss (dB)	Preamplifier Gain (dB)	Read Level (dBμV)	Emission Level (dBμV/m)	Limits (dBμV/m)	Margin (dB)	Detector
@ 2464.500	32.06	7.98	34.60	101.64	107.08	---	---	Peak
2483.500	32.14	7.99	34.61	57.44	62.96	74.00	11.04	Peak
2484.000	32.14	7.99	34.61	55.86	61.38	74.00	12.62	Peak

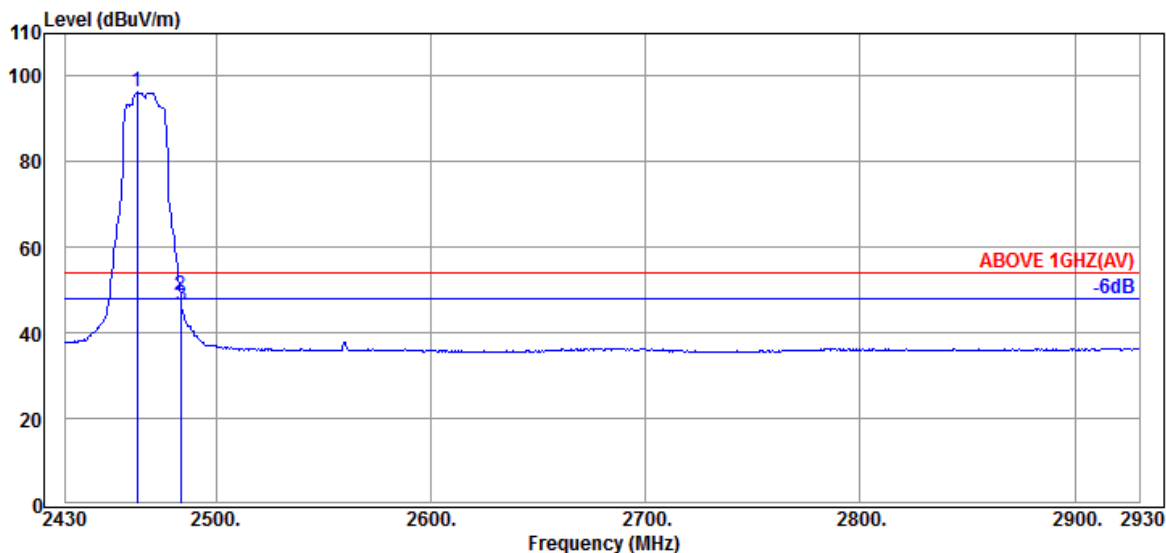

Antenna at Horizontal Polarization

Emission Frequency (MHz)	Antenna Factor (dB/m)	Cable Loss (dB)	Preamplifier Gain (dB)	Read Level (dBμV)	Emission Level (dBμV/m)	Limits (dBμV/m)	Margin (dB)	Detector
@ 2463.500	32.06	7.98	34.60	90.78	96.22	---	---	Average
2483.500	32.14	7.99	34.61	43.15	48.67	54.00	5.33	Average
2484.000	32.14	7.99	34.61	40.95	46.47	54.00	7.53	Average

Remark: The “@” means fundamental frequency, it is ignored in this section.

Mode	802.11ax-HE20	Frequency	TX 2467MHz
------	---------------	-----------	------------

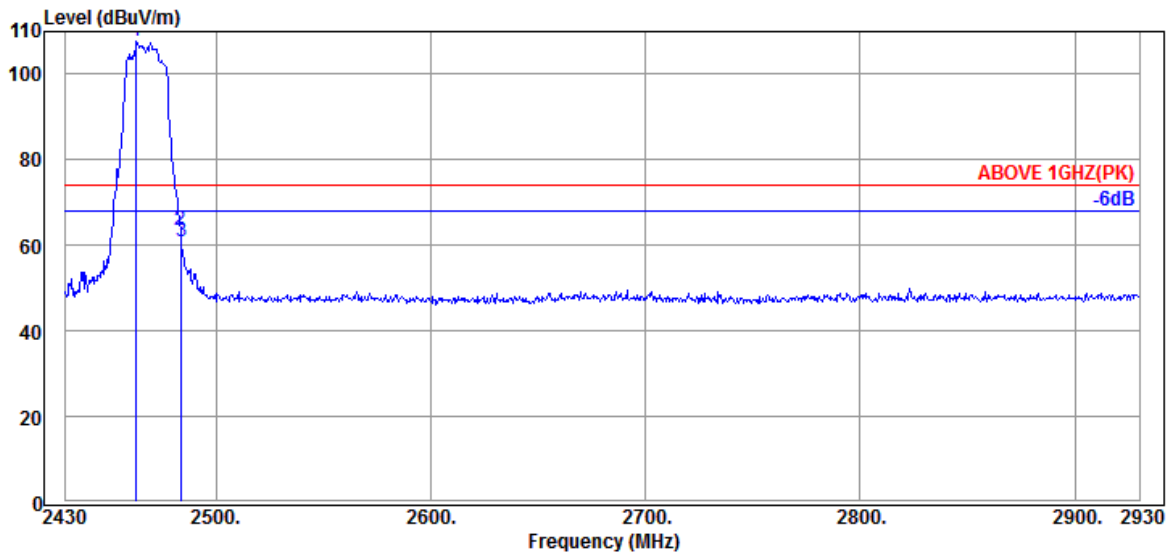

Antenna at Vertical Polarization

Emission Frequency (MHz)	Antenna Factor (dB/m)	Cable Loss (dB)	Preamplifier Gain (dB)	Read Level (dBμV)	Emission Level (dBμV/m)	Limits (dBμV/m)	Margin (dB)	Detector
@ 2463.000	32.06	7.98	34.60	102.25	107.69	---	---	Peak
2483.500	32.14	7.99	34.61	58.10	63.62	74.00	10.38	Peak
2484.000	32.14	7.99	34.61	55.20	60.72	74.00	13.28	Peak

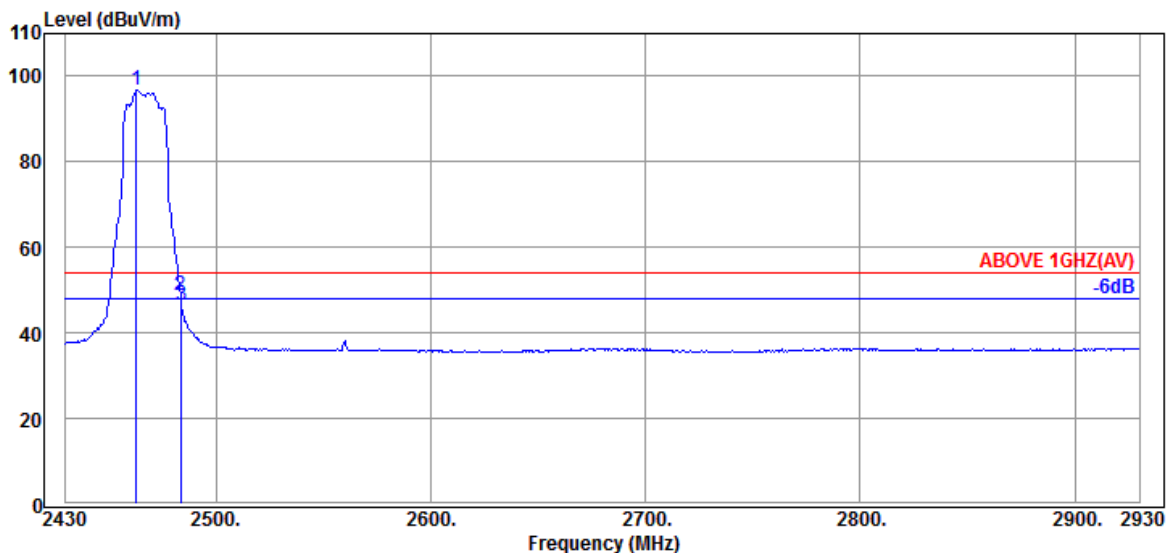

Antenna at Vertical Polarization

Emission Frequency (MHz)	Antenna Factor (dB/m)	Cable Loss (dB)	Preamplifier Gain (dB)	Read Level (dBμV)	Emission Level (dBμV/m)	Limits (dBμV/m)	Margin (dB)	Detector
@ 2463.000	32.06	7.98	34.60	91.24	96.68	---	---	Average
2483.500	32.14	7.99	34.61	43.24	48.76	54.00	5.24	Average
2484.000	32.14	7.99	34.61	41.13	46.65	54.00	7.35	Average

Remark: The “@” means fundamental frequency, it is ignored in this section.

Mode	802.11ax-HE20	Frequency	TX 2472MHz
------	---------------	-----------	------------

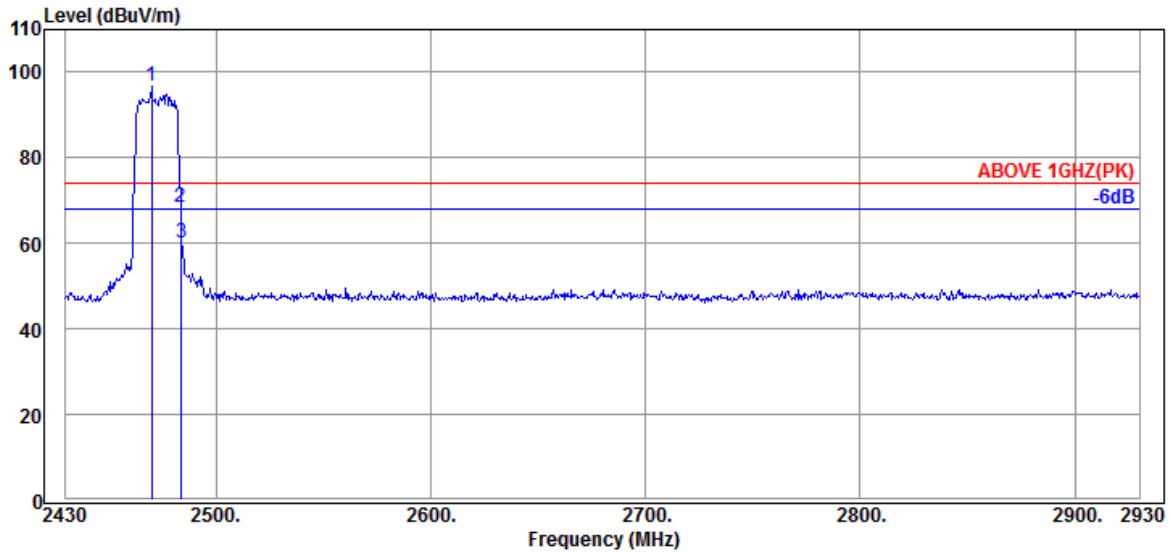

Antenna at Horizontal Polarization

Emission Frequency (MHz)	Antenna Factor (dB/m)	Cable Loss (dB)	Preamplifier Gain (dB)	Read Level (dBμV)	Emission Level (dBμV/m)	Limits (dBμV/m)	Margin (dB)	Detector
@ 2470.000	32.09	7.99	34.60	91.22	96.70	---	---	Peak
2483.500	32.14	7.99	34.61	63.08	68.60	74.00	5.40	Peak
2484.000	32.14	7.99	34.61	54.75	60.27	74.00	13.73	Peak

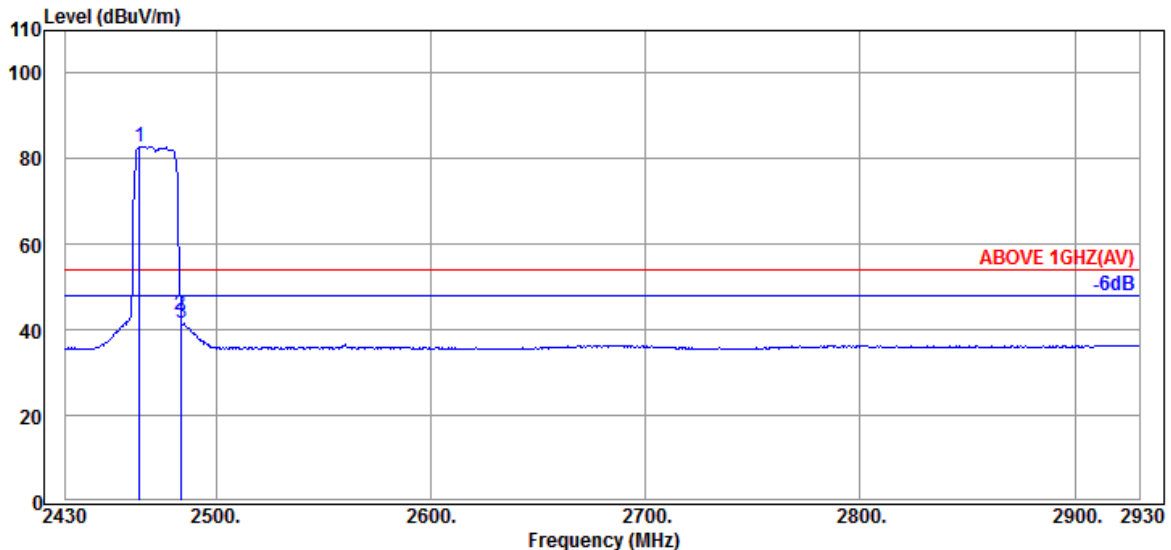

Antenna at Horizontal Polarization

Emission Frequency (MHz)	Antenna Factor (dB/m)	Cable Loss (dB)	Preamplifier Gain (dB)	Read Level (dBμV)	Emission Level (dBμV/m)	Limits (dBμV/m)	Margin (dB)	Detector
@ 2464.500	32.06	7.98	34.60	77.43	82.87	---	---	Average
2483.500	32.14	7.99	34.61	38.06	43.58	54.00	10.42	Average
2484.000	32.14	7.99	34.61	36.25	41.77	54.00	12.23	Average

Remark: The “@” means fundamental frequency, it is ignored in this section.

Mode	802.11ax-HE20	Frequency	TX 2472MHz
------	---------------	-----------	------------

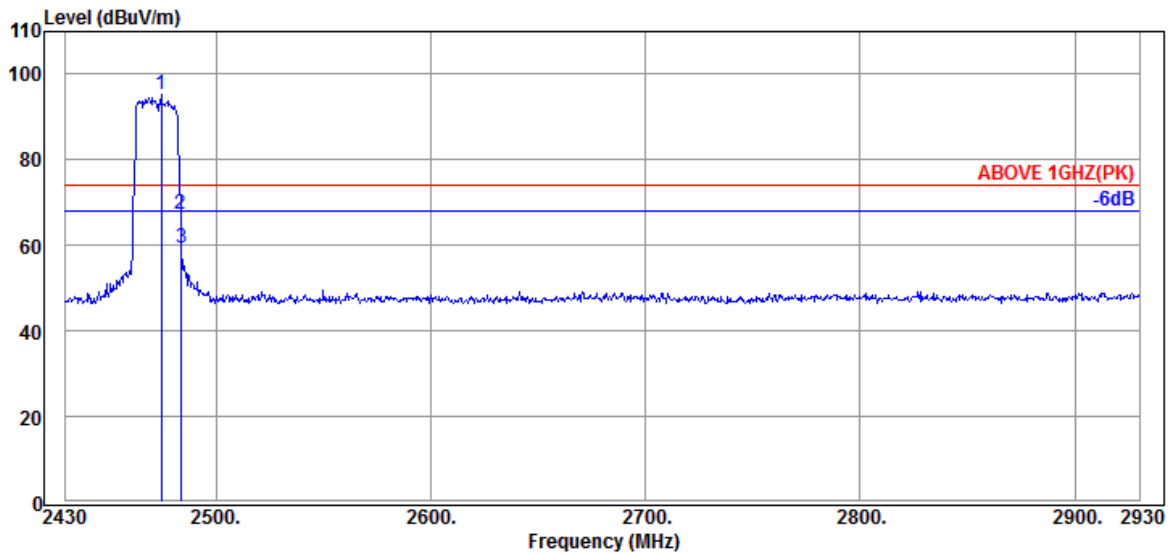

Antenna at Vertical Polarization

Emission Frequency (MHz)	Antenna Factor (dB/m)	Cable Loss (dB)	Preamplifier Gain (dB)	Read Level (dBμV)	Emission Level (dBμV/m)	Limits (dBμV/m)	Margin (dB)	Detector
@ 2474.500	32.09	7.99	34.60	89.72	95.20	---	---	Peak
2483.500	32.14	7.99	34.61	61.75	67.27	74.00	6.73	Peak
2484.000	32.14	7.99	34.61	53.88	59.40	74.00	14.60	Peak

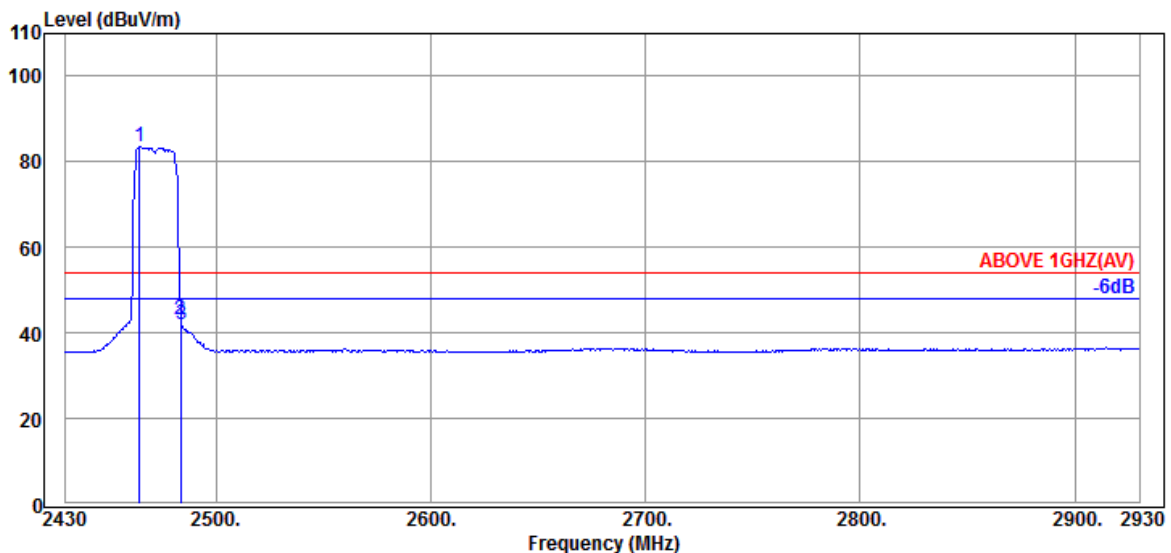

Antenna at Vertical Polarization

Emission Frequency (MHz)	Antenna Factor (dB/m)	Cable Loss (dB)	Preamplifier Gain (dB)	Read Level (dBμV)	Emission Level (dBμV/m)	Limits (dBμV/m)	Margin (dB)	Detector
@ 2464.500	32.06	7.98	34.60	78.08	83.52	---	---	Average
2483.500	32.14	7.99	34.61	37.76	43.28	54.00	10.72	Average
2484.000	32.14	7.99	34.61	36.47	41.99	54.00	12.01	Average

Remark: The “@” means fundamental frequency, it is ignored in this section.

Mode	802.11ax-HE40	Frequency	TX 2422MHz
------	---------------	-----------	------------

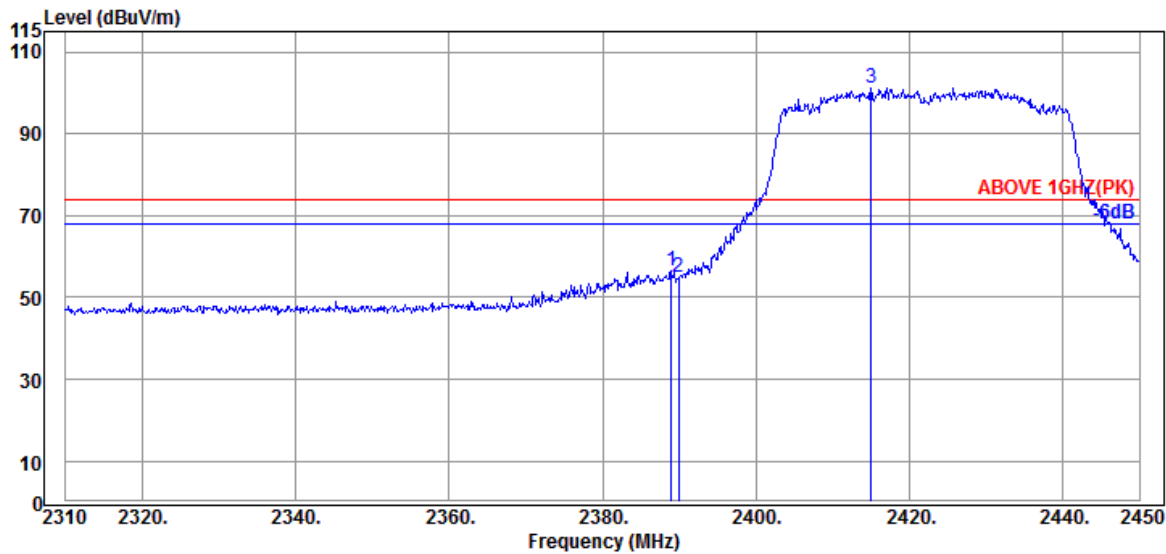

Antenna at Horizontal Polarization

Emission Frequency (MHz)	Antenna Factor (dB/m)	Cable Loss (dB)	Preamplifier Gain (dB)	Read Level (dBμV)	Emission Level (dBμV/m)	Limits (dBμV/m)	Margin (dB)	Detector
2388.960	32.44	7.95	39.91	55.88	56.36	74.00	17.64	Peak
2389.940	32.44	7.95	39.91	54.37	54.85	74.00	19.15	Peak
@ 2415.000	32.36	7.96	39.91	100.91	101.32	---	---	Peak

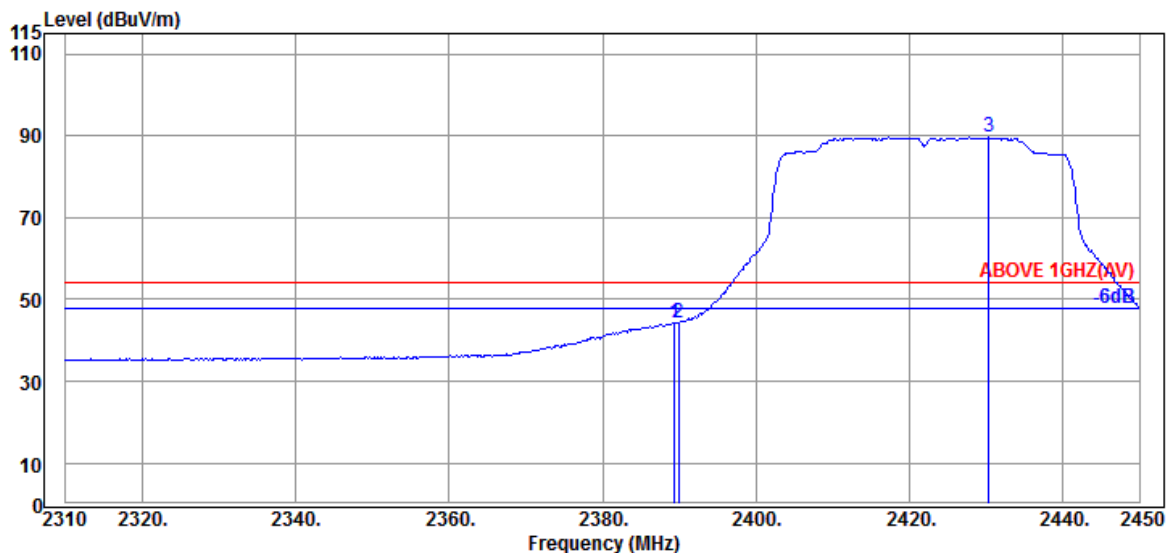

Antenna at Horizontal Polarization

Emission Frequency (MHz)	Antenna Factor (dB/m)	Cable Loss (dB)	Preamplifier Gain (dB)	Read Level (dBμV)	Emission Level (dBμV/m)	Limits (dBμV/m)	Margin (dB)	Detector
2389.380	32.44	7.95	39.91	43.83	44.31	54.00	9.69	Average
2389.940	32.44	7.95	39.91	43.71	44.19	54.00	9.81	Average
@ 2430.400	32.21	7.97	39.91	89.40	89.67	---	---	Average

Remark: The “@” means fundamental frequency, it is ignored in this section.

Mode	802.11ax-HE40	Frequency	TX 2422MHz
------	---------------	-----------	------------

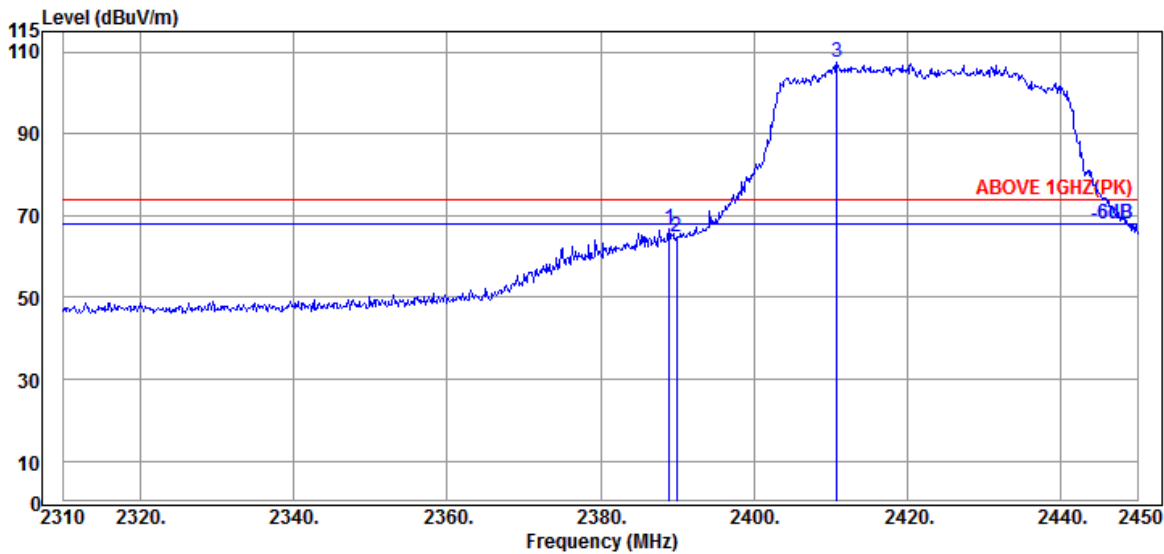

Antenna at Vertical Polarization

Emission Frequency (MHz)	Antenna Factor (dB/m)	Cable Loss (dB)	Preamplifier Gain (dB)	Read Level (dBμV)	Emission Level (dBμV/m)	Limits (dBμV/m)	Margin (dB)	Detector
2388.960	32.44	7.95	39.91	66.36	66.84	74.00	7.16	Peak
2389.940	32.44	7.95	39.91	64.48	64.96	74.00	9.04	Peak
@ 2410.800	32.43	7.96	39.91	106.90	107.38	---	---	Peak

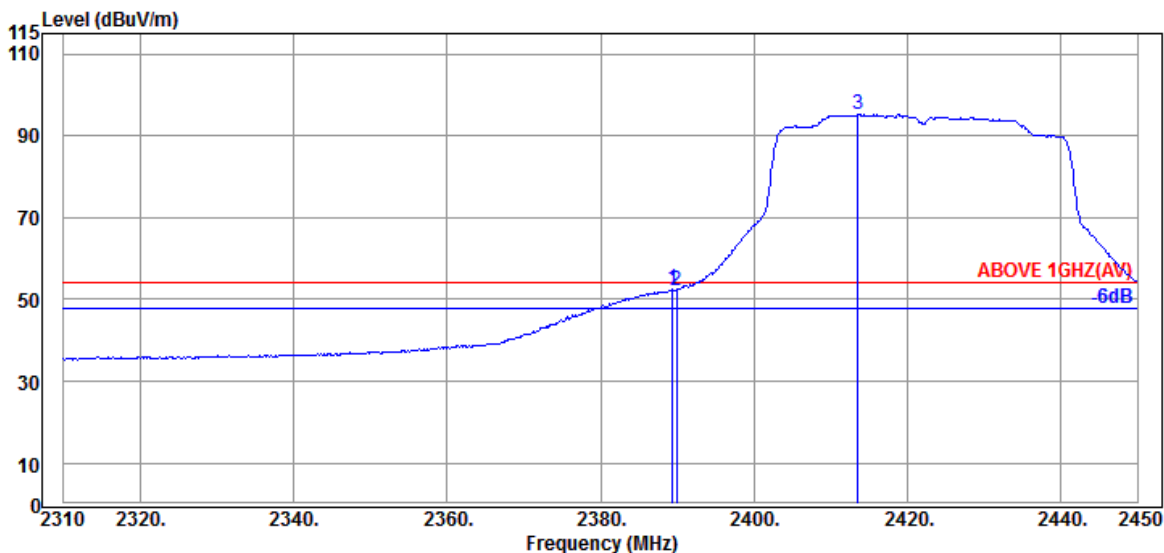

Antenna at Vertical Polarization

Emission Frequency (MHz)	Antenna Factor (dB/m)	Cable Loss (dB)	Preamplifier Gain (dB)	Read Level (dBμV)	Emission Level (dBμV/m)	Limits (dBμV/m)	Margin (dB)	Detector
2389.380	32.44	7.95	39.91	51.90	52.38	54.00	1.62	Average
2389.940	32.44	7.95	39.91	51.60	52.08	54.00	1.92	Average
@ 2413.600	32.36	7.96	39.91	94.75	95.16	---	---	Average

Remark: The “@” means fundamental frequency, it is ignored in this section.

Mode	802.11ax-HE40	Frequency	TX 2427MHz
------	---------------	-----------	------------

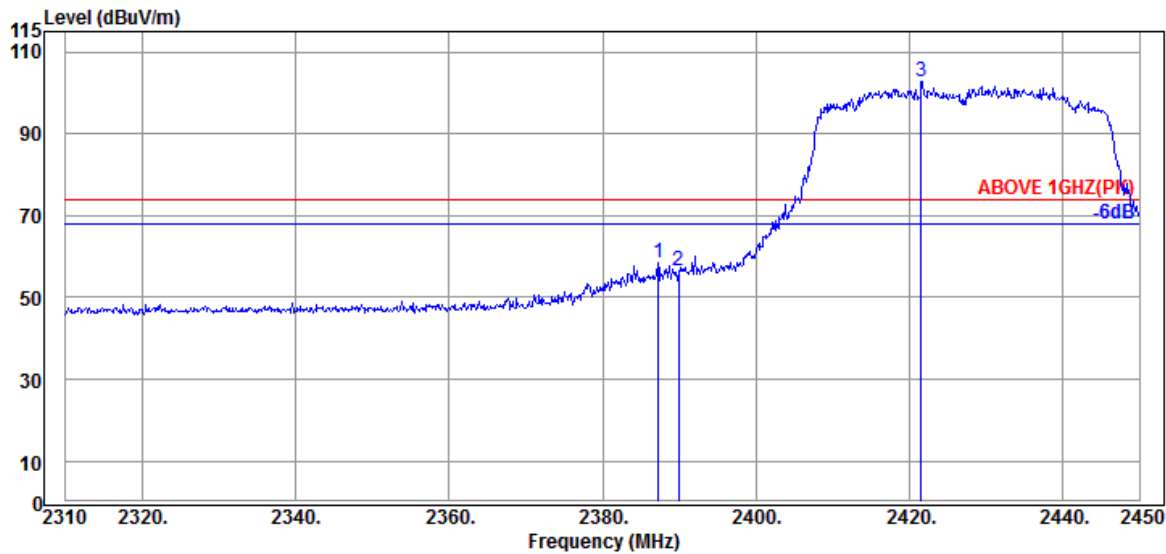

Antenna at Horizontal Polarization

Emission Frequency (MHz)	Antenna Factor (dB/m)	Cable Loss (dB)	Preamplifier Gain (dB)	Read Level (dBμV)	Emission Level (dBμV/m)	Limits (dBμV/m)	Margin (dB)	Detector
2387.280	32.44	7.95	39.91	57.95	58.43	74.00	15.57	Peak
2389.940	32.44	7.95	39.91	56.13	56.61	74.00	17.39	Peak
@ 2421.580	32.29	7.96	39.91	102.38	102.72	---	---	Peak

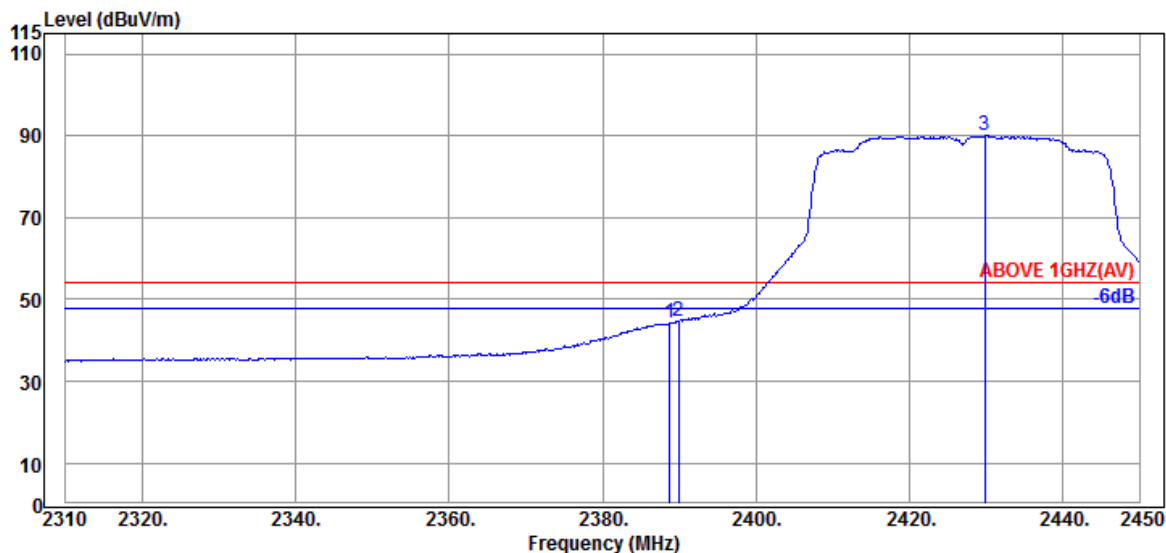

Antenna at Horizontal Polarization

Emission Frequency (MHz)	Antenna Factor (dB/m)	Cable Loss (dB)	Preamplifier Gain (dB)	Read Level (dBμV)	Emission Level (dBμV/m)	Limits (dBμV/m)	Margin (dB)	Detector
2388.820	32.44	7.95	39.91	43.92	44.40	54.00	9.60	Average
2389.940	32.44	7.95	39.91	44.11	44.59	54.00	9.41	Average
@ 2429.840	32.21	7.97	39.91	89.65	89.92	---	---	Average

Remark: The “@” means fundamental frequency, it is ignored in this section.

Mode	802.11ax-HE40	Frequency	TX 2427MHz
------	---------------	-----------	------------

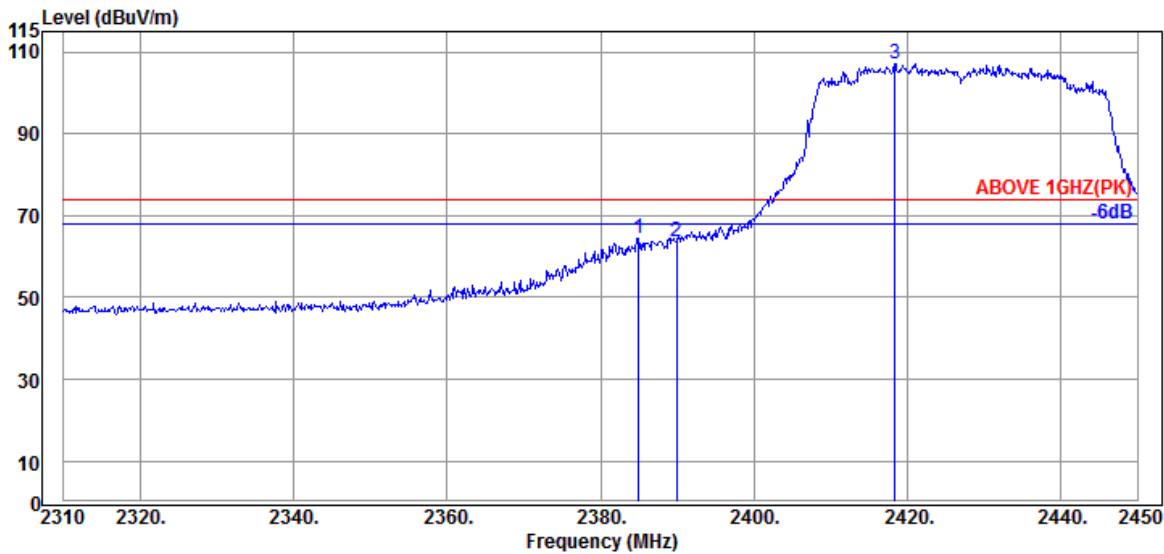

Antenna at Vertical Polarization

Emission Frequency (MHz)	Antenna Factor (dB/m)	Cable Loss (dB)	Preamplifier Gain (dB)	Read Level (dBμV)	Emission Level (dBμV/m)	Limits (dBμV/m)	Margin (dB)	Detector
2385.040	32.44	7.95	39.91	64.11	64.59	74.00	9.41	Peak
2389.940	32.44	7.95	39.91	63.29	63.77	74.00	10.23	Peak
@ 2418.360	32.29	7.96	39.91	106.79	107.13	---	---	Peak

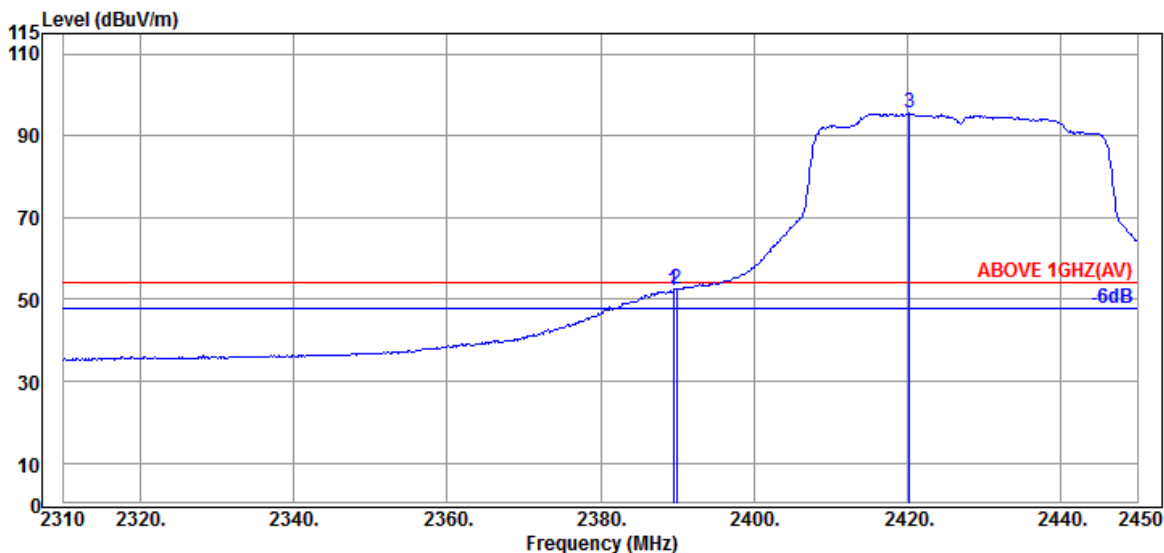

Antenna at Vertical Polarization

Emission Frequency (MHz)	Antenna Factor (dB/m)	Cable Loss (dB)	Preamplifier Gain (dB)	Read Level (dBμV)	Emission Level (dBμV/m)	Limits (dBμV/m)	Margin (dB)	Detector
2389.520	32.44	7.95	39.91	51.74	52.22	54.00	1.78	Average
2389.940	32.44	7.95	39.91	51.99	52.47	54.00	1.53	Average
@ 2420.320	32.29	7.96	39.91	95.12	95.46	---	---	Average

Remark: The “@” means fundamental frequency, it is ignored in this section.

Mode	802.11ax-HE40	Frequency	TX 2447MHz
------	---------------	-----------	------------

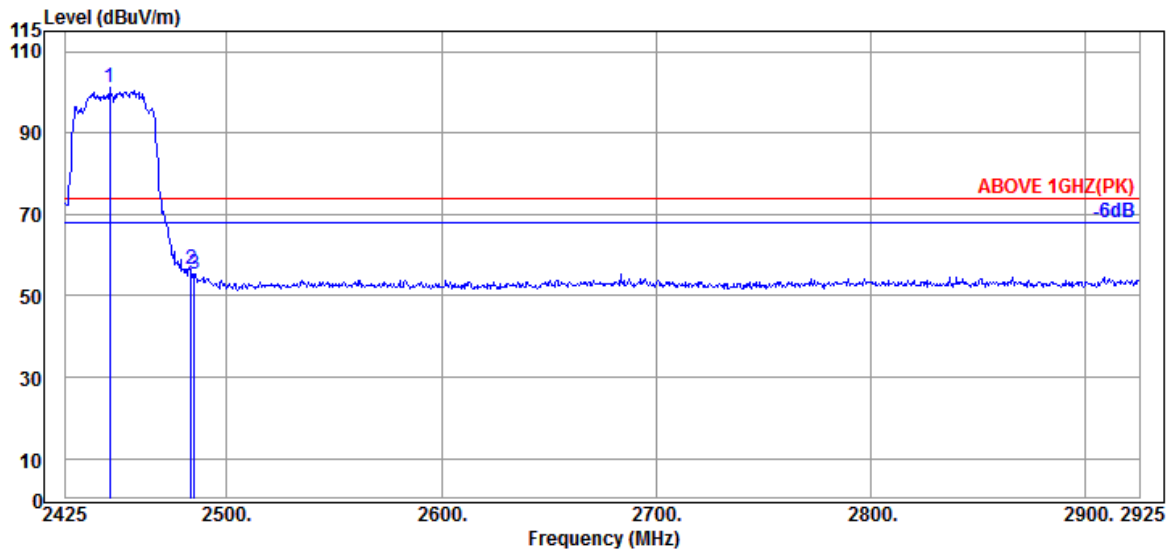

Antenna at Horizontal Polarization

Emission Frequency (MHz)	Antenna Factor (dB/m)	Cable Loss (dB)	Preamplifier Gain (dB)	Read Level (dBμV)	Emission Level (dBμV/m)	Limits (dBμV/m)	Margin (dB)	Detector
@ 2445.500	32.07	7.98	34.60	95.54	100.99	---	---	Peak
2483.500	32.14	7.99	34.61	50.89	56.41	74.00	17.59	Peak
2485.000	32.14	7.99	34.61	49.96	55.48	74.00	18.52	Peak

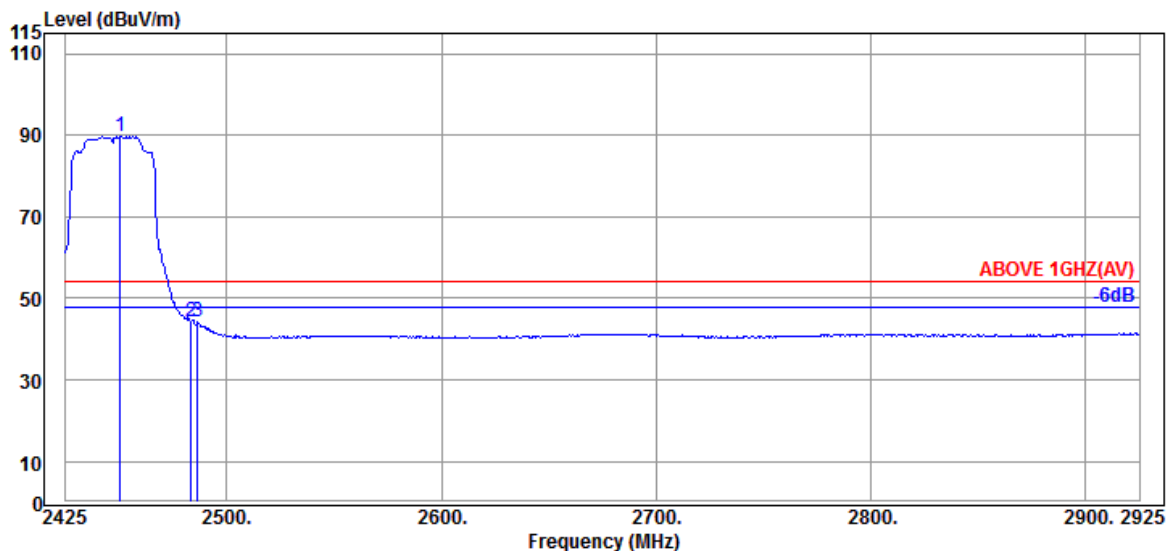

Antenna at Horizontal Polarization

Emission Frequency (MHz)	Antenna Factor (dB/m)	Cable Loss (dB)	Preamplifier Gain (dB)	Read Level (dBμV)	Emission Level (dBμV/m)	Limits (dBμV/m)	Margin (dB)	Detector
@ 2450.500	32.00	7.98	34.60	84.30	89.68	---	---	Average
2483.500	32.14	7.99	34.61	38.92	44.44	54.00	9.56	Average
2486.500	32.14	8.00	34.61	38.56	44.09	54.00	9.91	Average

Remark: The “@” means fundamental frequency, it is ignored in this section.

Mode	802.11ax-HE40	Frequency	TX 2447MHz
------	---------------	-----------	------------

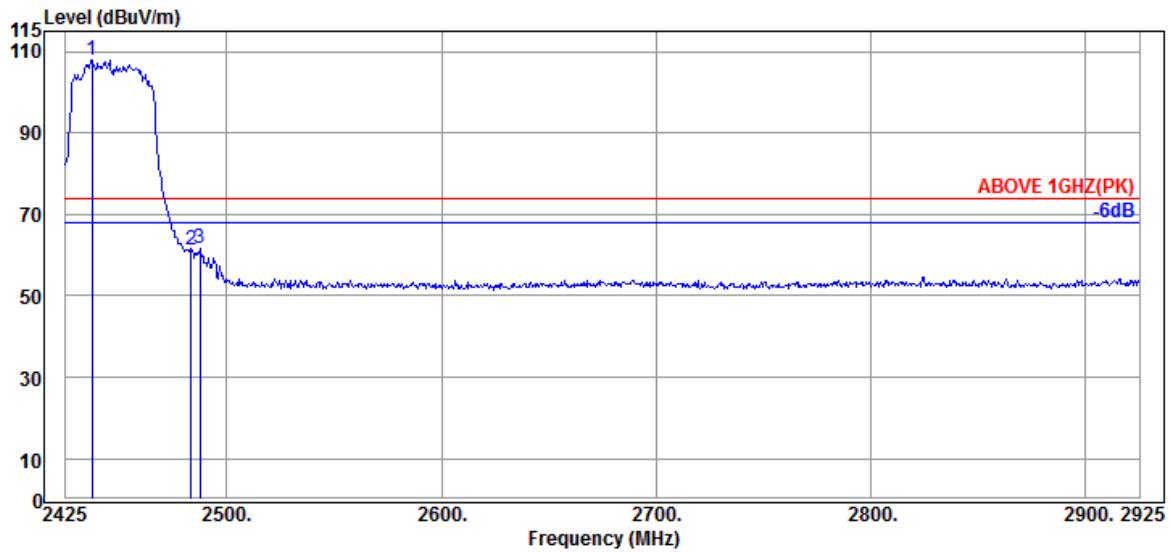

Antenna at Vertical Polarization

Emission Frequency (MHz)	Antenna Factor (dB/m)	Cable Loss (dB)	Preamp Gain (dB)	Read Level (dBμV)	Emission Level (dBμV/m)	Limits (dBμV/m)	Margin (dB)	Detector
@ 2437.500	32.14	7.97	34.59	102.48	108.00	---	---	Peak
2483.500	32.14	7.99	34.61	55.58	61.10	74.00	12.90	Peak
2487.500	32.14	8.00	34.61	56.18	61.71	74.00	12.29	Peak

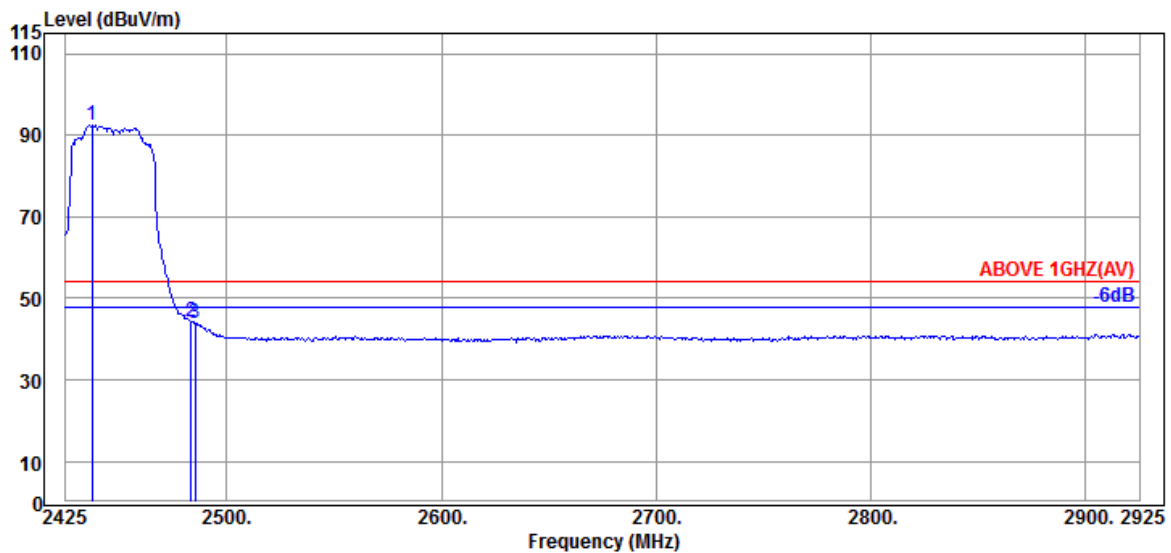

Antenna at Vertical Polarization

Emission Frequency (MHz)	Antenna Factor (dB/m)	Cable Loss (dB)	Preamp Gain (dB)	Read Level (dBμV)	Emission Level (dBμV/m)	Limits (dBμV/m)	Margin (dB)	Detector
@ 2437.500	32.14	7.97	34.59	86.82	92.34	---	---	Average
2483.500	32.14	7.99	34.61	38.68	44.20	54.00	9.80	Average
2485.500	32.14	7.99	34.61	38.46	43.98	54.00	10.02	Average

Remark: The "@" means fundamental frequency, it is ignored in this section.

Mode	802.11ax-HE40	Frequency	TX 2452MHz
------	---------------	-----------	------------

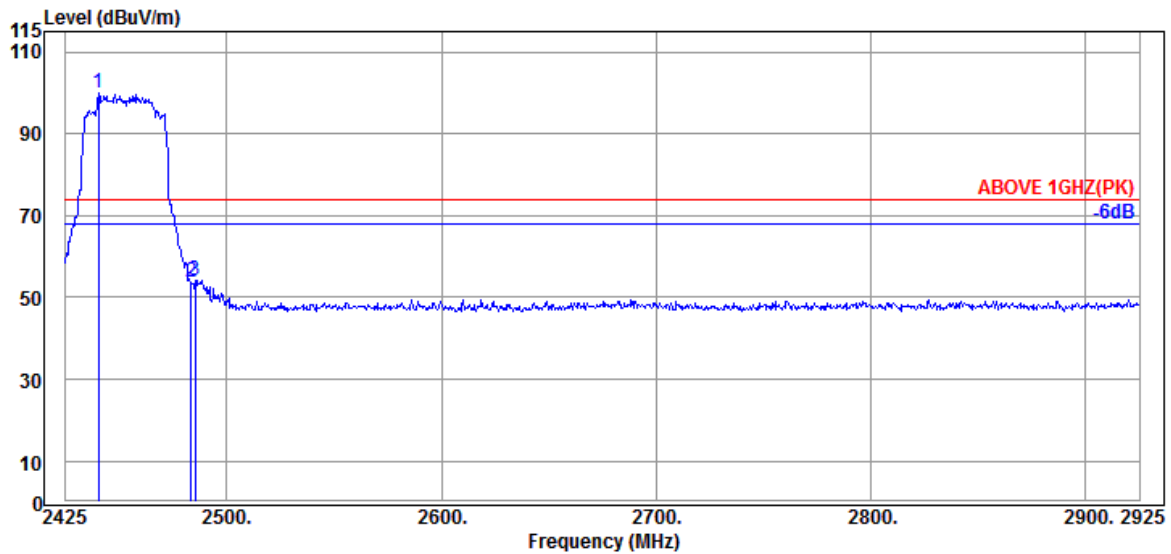

Antenna at Horizontal Polarization

Emission Frequency (MHz)	Antenna Factor (dB/m)	Cable Loss (dB)	Preamplifier Gain (dB)	Read Level (dBμV)	Emission Level (dBμV/m)	Limits (dBμV/m)	Margin (dB)	Detector
@ 2440.500	32.07	7.98	39.91	99.76	99.90	---	---	Peak
2483.500	32.14	7.99	39.91	53.63	53.85	74.00	20.15	Peak
2485.500	32.14	7.99	39.91	53.97	54.19	74.00	19.81	Peak

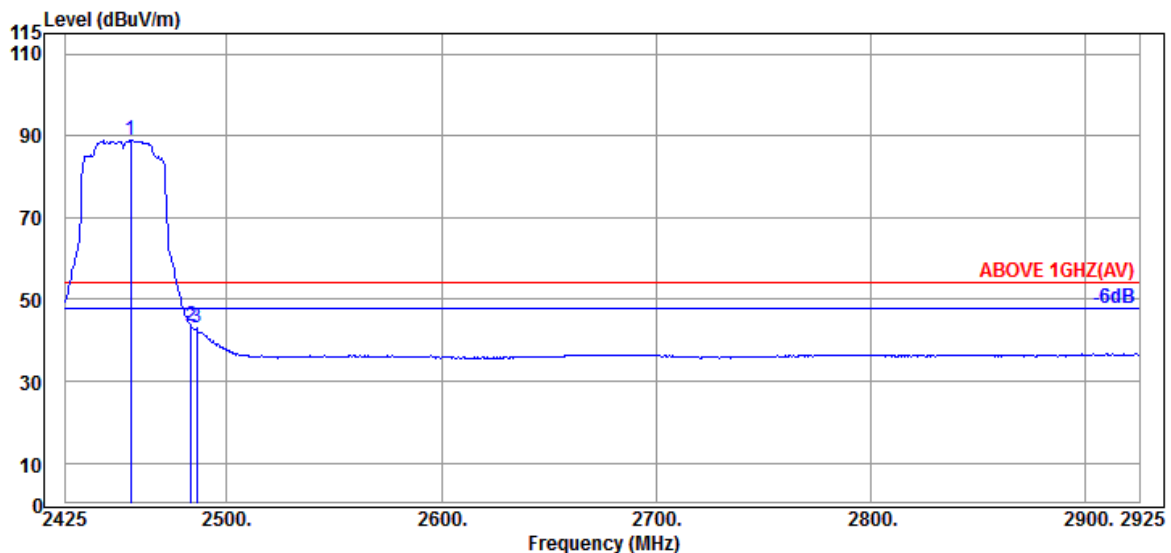

Antenna at Horizontal Polarization

Emission Frequency (MHz)	Antenna Factor (dB/m)	Cable Loss (dB)	Preamplifier Gain (dB)	Read Level (dBμV)	Emission Level (dBμV/m)	Limits (dBμV/m)	Margin (dB)	Detector
@ 2455.500	32.03	7.98	39.91	88.83	88.93	---	---	Average
2483.500	32.14	7.99	39.91	43.27	43.49	54.00	10.51	Average
2486.000	32.14	8.00	39.91	42.65	42.88	54.00	11.12	Average

Remark: The "@" means fundamental frequency, it is ignored in this section.

Mode	802.11ax-HE40	Frequency	TX 2452MHz
------	---------------	-----------	------------

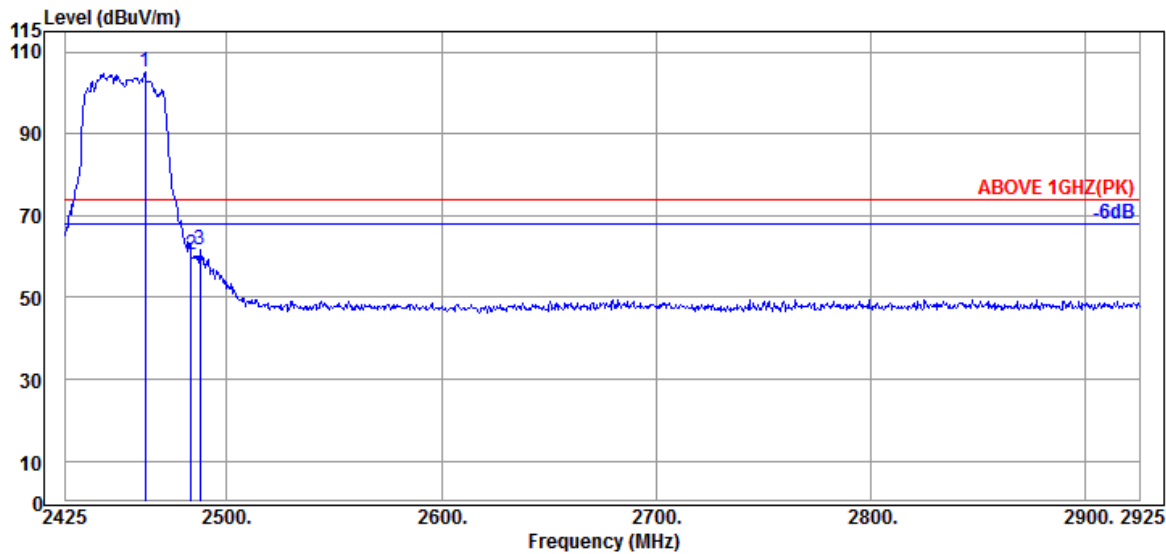

Antenna at Vertical Polarization

Emission Frequency (MHz)	Antenna Factor (dB/m)	Cable Loss (dB)	Preamplifier Gain (dB)	Read Level (dBμV)	Emission Level (dBμV/m)	Limits (dBμV/m)	Margin (dB)	Detector
@ 2462.000	32.06	7.98	39.91	104.80	104.93	---	---	Peak
2483.500	32.14	7.99	39.91	60.22	60.44	74.00	13.56	Peak
2487.500	32.14	8.00	39.91	61.32	61.55	74.00	12.45	Peak

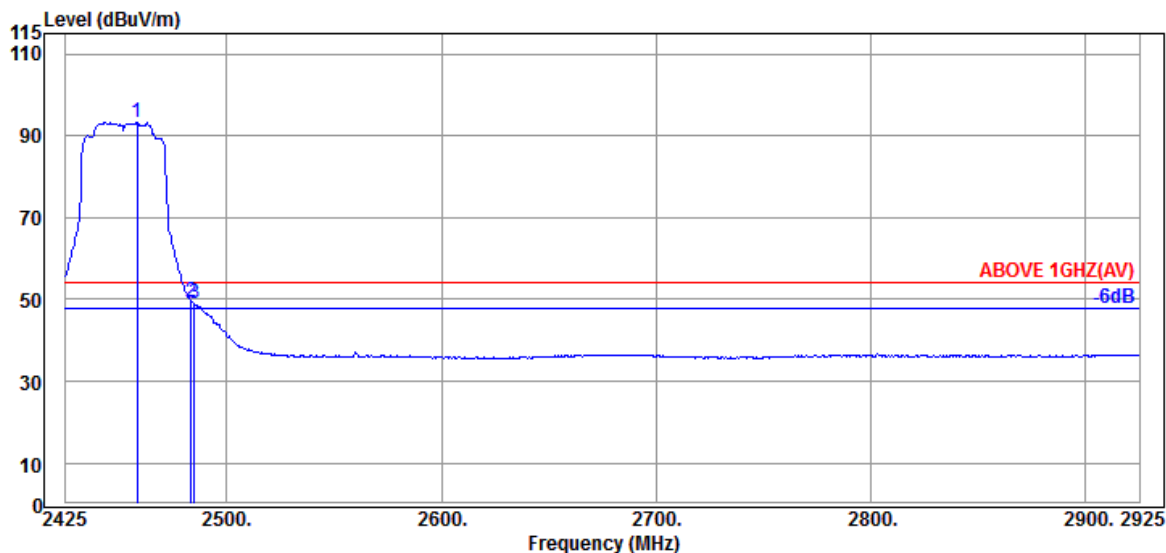

Antenna at Vertical Polarization

Emission Frequency (MHz)	Antenna Factor (dB/m)	Cable Loss (dB)	Preamplifier Gain (dB)	Read Level (dBμV)	Emission Level (dBμV/m)	Limits (dBμV/m)	Margin (dB)	Detector
@ 2458.500	32.03	7.98	39.91	93.21	93.31	---	---	Average
2483.500	32.14	7.99	39.91	49.26	49.48	54.00	4.52	Average
2485.000	32.14	7.99	39.91	48.85	49.07	54.00	4.93	Average

Remark: The “@” means fundamental frequency, it is ignored in this section.

Mode	802.11ax-HE40	Frequency	TX 2457MHz
------	---------------	-----------	------------

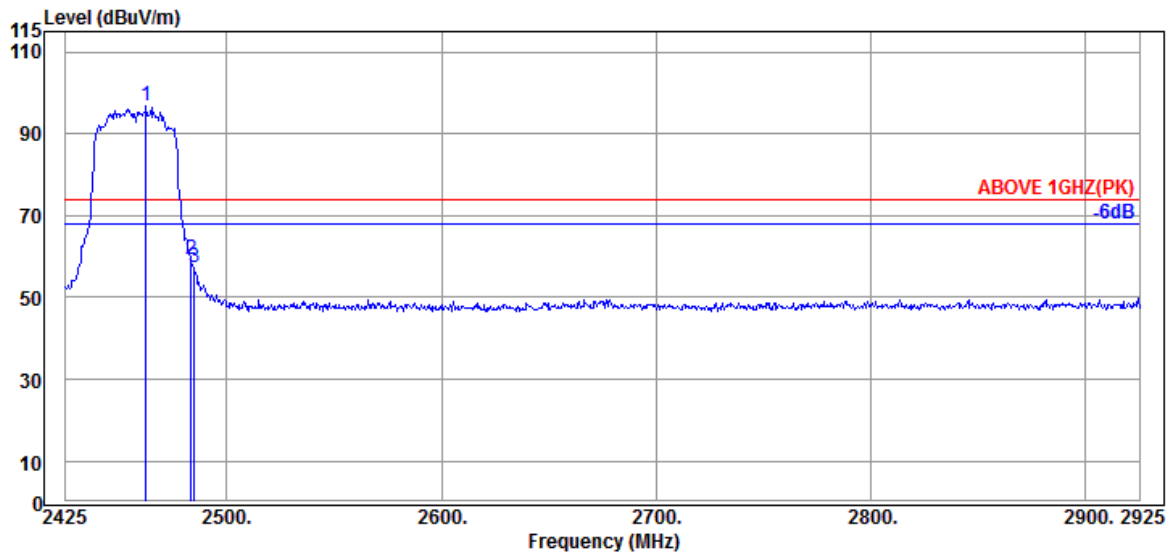

Antenna at Horizontal Polarization

Emission Frequency (MHz)	Antenna Factor (dB/m)	Cable Loss (dB)	Preamplifier Gain (dB)	Read Level (dBμV)	Emission Level (dBμV/m)	Limits (dBμV/m)	Margin (dB)	Detector
@ 2462.500	32.06	7.98	39.91	96.68	96.81	---	---	Peak
2483.500	32.14	7.99	39.91	59.16	59.38	74.00	14.62	Peak
2485.000	32.14	7.99	39.91	57.11	57.33	74.00	16.67	Peak

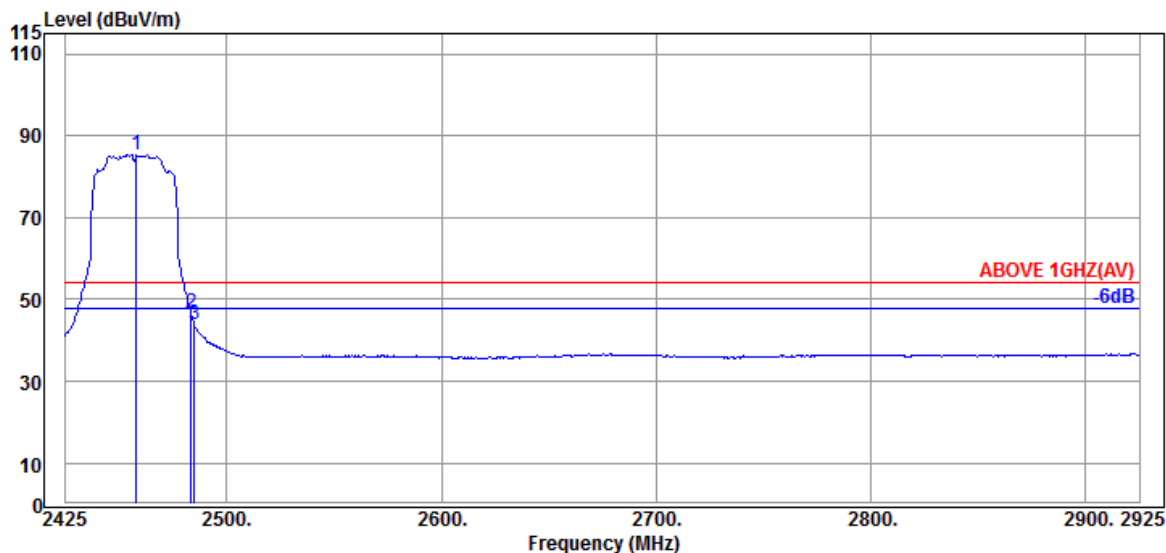

Antenna at Horizontal Polarization

Emission Frequency (MHz)	Antenna Factor (dB/m)	Cable Loss (dB)	Preamplifier Gain (dB)	Read Level (dBμV)	Emission Level (dBμV/m)	Limits (dBμV/m)	Margin (dB)	Detector
@ 2458.000	32.03	7.98	39.91	85.34	85.44	---	---	Average
2483.500	32.14	7.99	39.91	46.44	46.66	54.00	7.34	Average
2485.000	32.14	7.99	39.91	43.52	43.74	54.00	10.26	Average

Remark: The "@" means fundamental frequency, it is ignored in this section.

Mode	802.11ax-HE40	Frequency	TX 2457MHz
------	---------------	-----------	------------

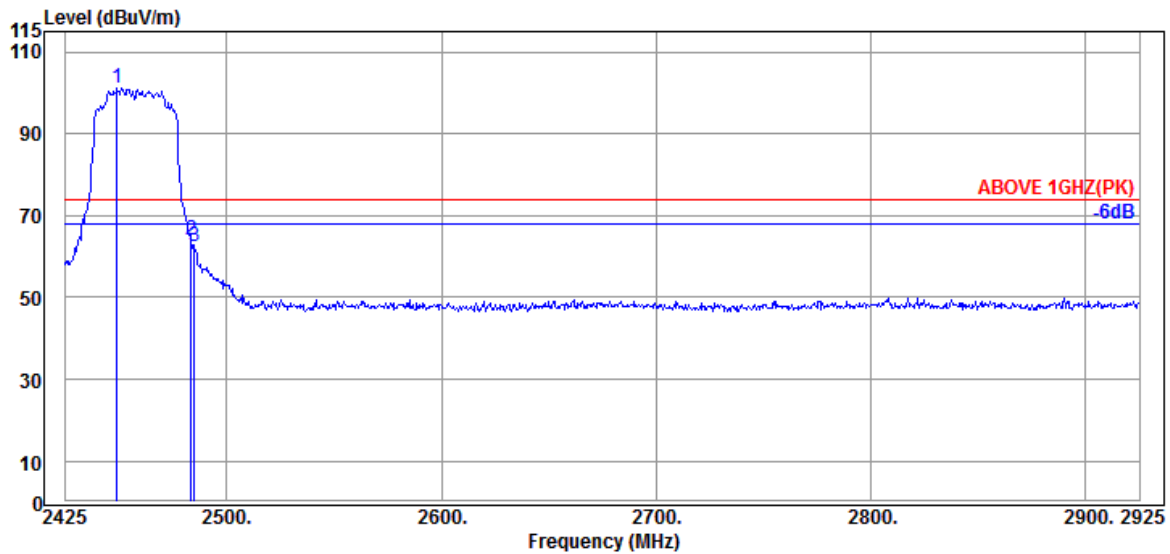

Antenna at Vertical Polarization

Emission Frequency (MHz)	Antenna Factor (dB/m)	Cable Loss (dB)	Preamplifier Gain (dB)	Read Level (dBμV)	Emission Level (dBμV/m)	Limits (dBμV/m)	Margin (dB)	Detector
@ 2449.000	32.00	7.98	39.91	101.29	101.36	---	---	Peak
2483.500	32.14	7.99	39.91	63.78	64.00	74.00	10.00	Peak
2485.000	32.14	7.99	39.91	62.09	62.31	74.00	11.69	Peak

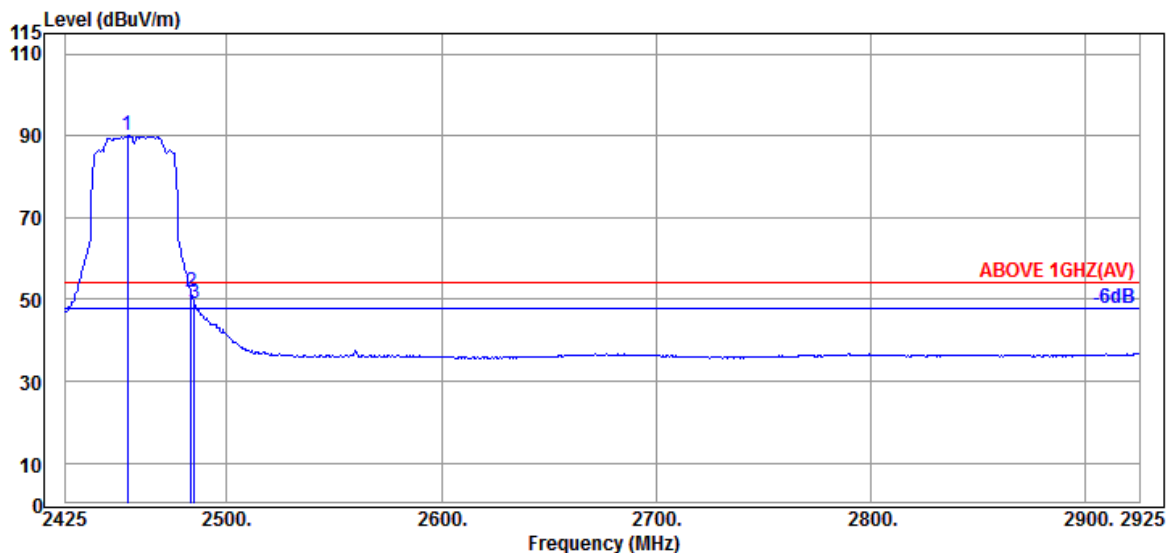

Antenna at Vertical Polarization

Emission Frequency (MHz)	Antenna Factor (dB/m)	Cable Loss (dB)	Preamplifier Gain (dB)	Read Level (dBμV)	Emission Level (dBμV/m)	Limits (dBμV/m)	Margin (dB)	Detector
@ 2454.000	32.03	7.98	39.91	89.88	89.98	---	---	Average
2483.500	32.14	7.99	39.91	51.45	51.67	54.00	2.33	Average
2485.000	32.14	7.99	39.91	48.87	49.09	54.00	4.91	Average

Remark: The “@” means fundamental frequency, it is ignored in this section.

Mode	802.11ax-HE40	Frequency	TX 2462MHz
------	---------------	-----------	------------

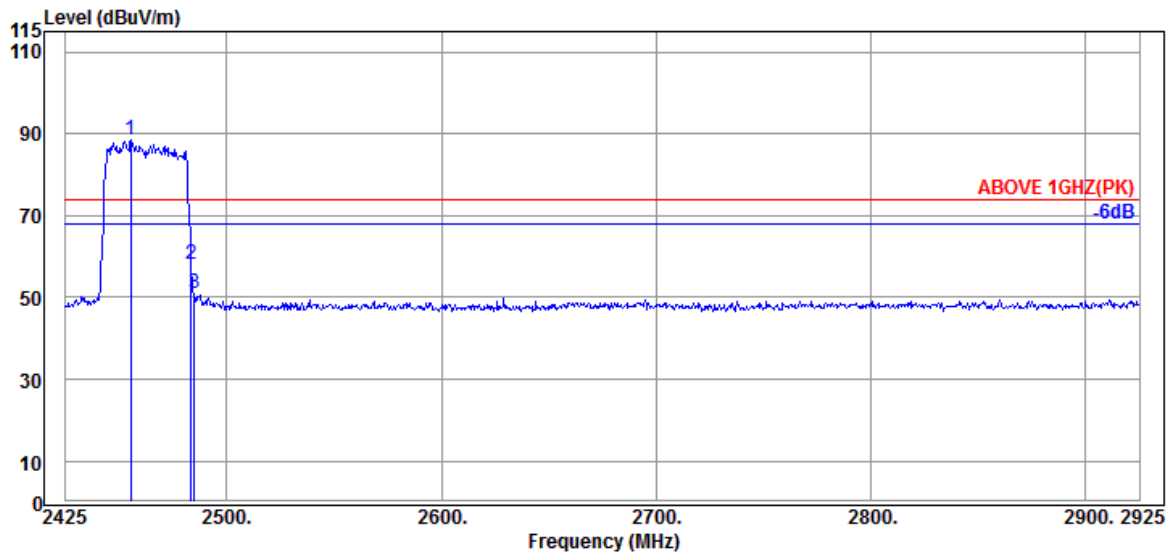

Antenna at Horizontal Polarization

Emission Frequency (MHz)	Antenna Factor (dB/m)	Cable Loss (dB)	Preamplifier Gain (dB)	Read Level (dBμV)	Emission Level (dBμV/m)	Limits (dBμV/m)	Margin (dB)	Detector
@ 2455.500	32.03	7.98	39.91	88.40	88.50	---	---	Peak
2483.500	32.14	7.99	39.91	58.00	58.22	74.00	15.78	Peak
2485.000	32.14	7.99	39.91	50.82	51.04	74.00	22.96	Peak

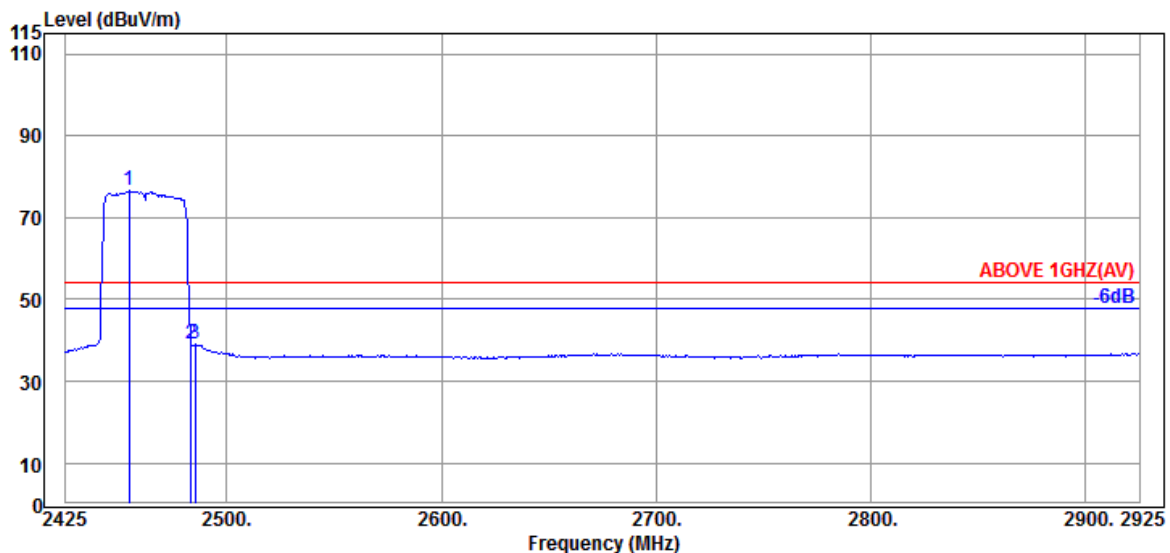

Antenna at Horizontal Polarization

Emission Frequency (MHz)	Antenna Factor (dB/m)	Cable Loss (dB)	Preamplifier Gain (dB)	Read Level (dBμV)	Emission Level (dBμV/m)	Limits (dBμV/m)	Margin (dB)	Detector
@ 2454.500	32.03	7.98	39.91	76.39	76.49	---	---	Average
2483.500	32.14	7.99	39.91	38.81	39.03	54.00	14.97	Average
2485.500	32.14	7.99	39.91	38.76	38.98	54.00	15.02	Average

Remark: The "@" means fundamental frequency, it is ignored in this section.

Mode	802.11ax-HE40	Frequency	TX 2462MHz
------	---------------	-----------	------------

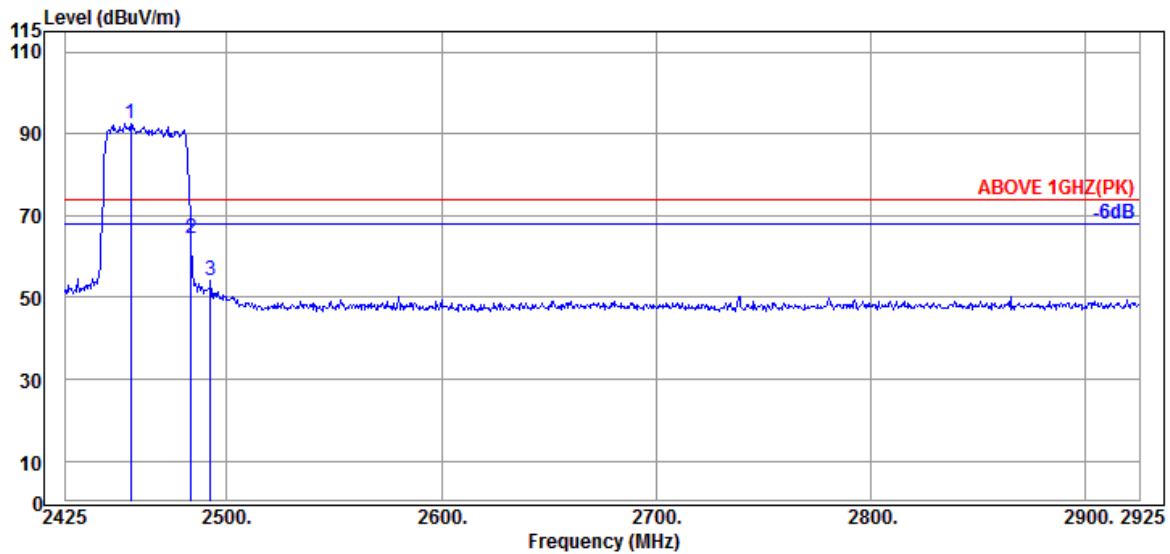

Antenna at Vertical Polarization

Emission Frequency (MHz)	Antenna Factor (dB/m)	Cable Loss (dB)	Preamplifier Gain (dB)	Read Level (dBμV)	Emission Level (dBμV/m)	Limits (dBμV/m)	Margin (dB)	Detector
@ 2455.500	32.03	7.98	39.91	92.26	92.36	---	---	Peak
2483.500	32.14	7.99	39.91	64.31	64.53	74.00	9.47	Peak
2492.500	32.17	8.00	39.91	53.68	53.94	74.00	20.06	Peak

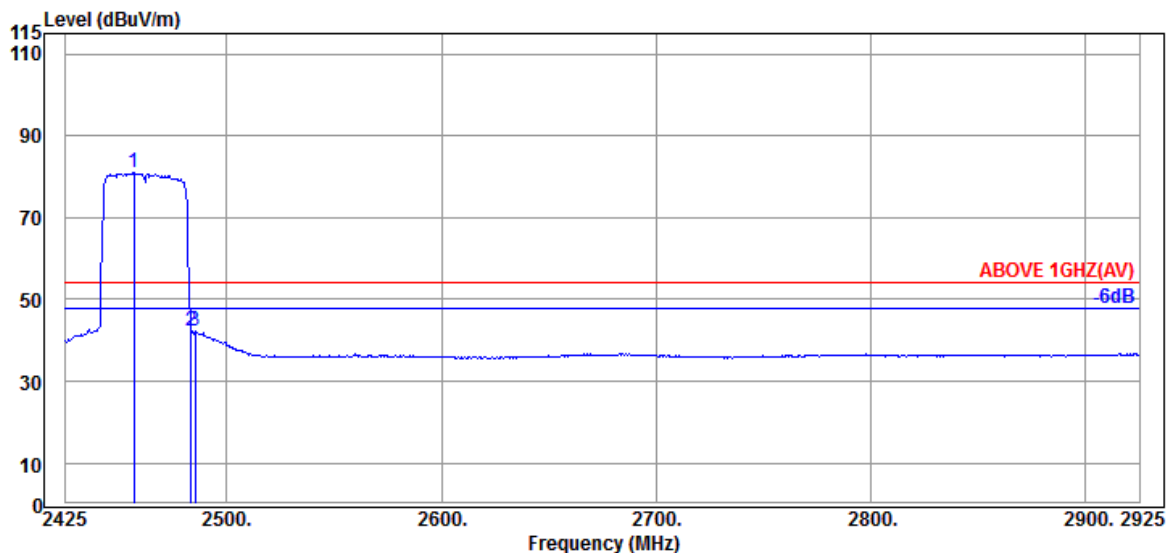

Antenna at Vertical Polarization

Emission Frequency (MHz)	Antenna Factor (dB/m)	Cable Loss (dB)	Preamplifier Gain (dB)	Read Level (dBμV)	Emission Level (dBμV/m)	Limits (dBμV/m)	Margin (dB)	Detector
@ 2457.000	32.03	7.98	39.91	80.79	80.89	---	---	Average
2483.500	32.14	7.99	39.91	42.24	42.46	54.00	11.54	Average
2485.500	32.14	7.99	39.91	41.94	42.16	54.00	11.84	Average

Remark: The "@" means fundamental frequency, it is ignored in this section.

Mode	802.11ax-HE20	Frequency	TX 2412MHz
		RU Configuration	26/0

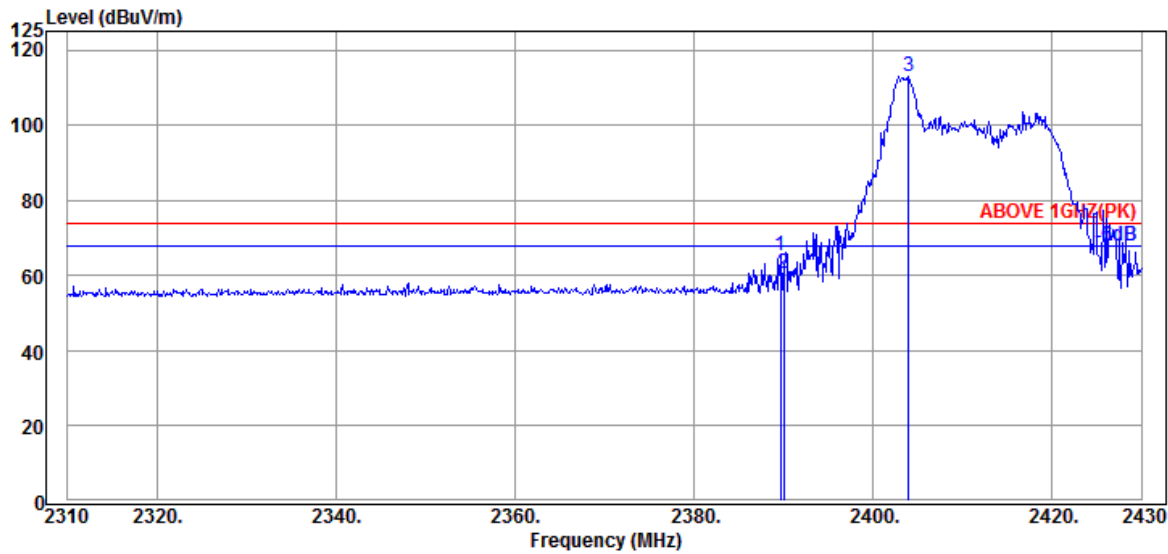

Antenna at Horizontal Polarization

Emission Frequency (MHz)	Antenna Factor (dB/m)	Cable Loss (dB)	Preamplifier Gain (dB)	Read Level (dBμV)	Emission Level (dBμV/m)	Limits (dBμV/m)	Margin (dB)	Detector
2389.680	32.44	7.95	39.91	64.88	65.36	74.00	8.64	Peak
2390.040	32.44	7.95	39.91	59.88	60.36	74.00	13.64	Peak
@ 2403.960	32.50	7.95	39.91	112.58	113.12	---	---	Peak

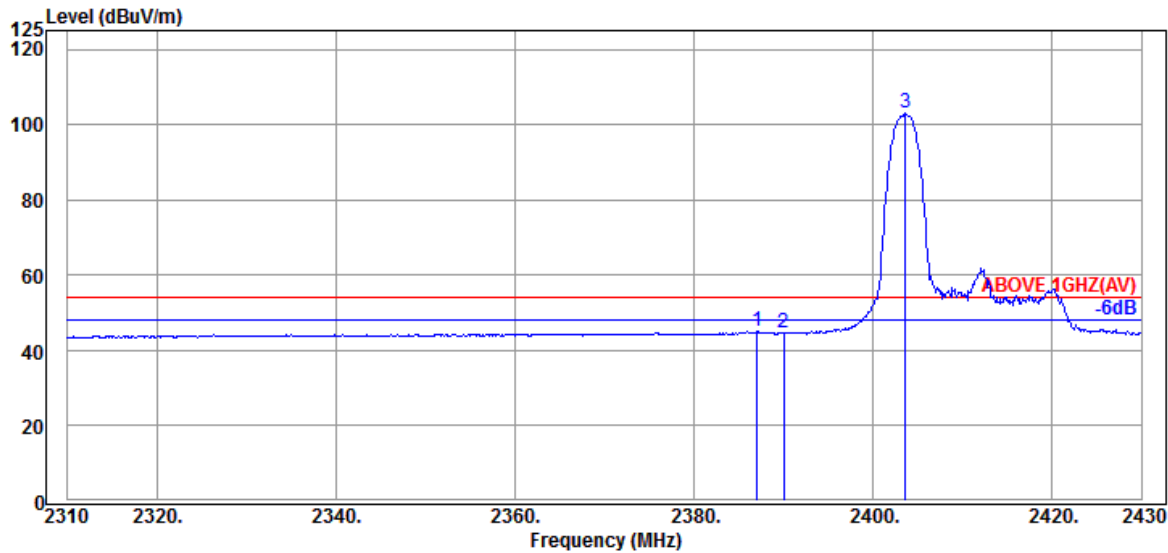

Antenna at Horizontal Polarization

Emission Frequency (MHz)	Antenna Factor (dB/m)	Cable Loss (dB)	Preamplifier Gain (dB)	Read Level (dBμV)	Emission Level (dBμV/m)	Limits (dBμV/m)	Margin (dB)	Detector
2387.040	32.44	7.95	39.91	44.55	45.03	54.00	8.97	Average
2390.040	32.44	7.95	39.91	44.04	44.52	54.00	9.48	Average
@ 2403.600	32.50	7.95	39.91	102.35	102.89	---	---	Average

Remark: The “@” means fundamental frequency, it is ignored in this section.

Mode	802.11ax-HE20	Frequency	TX 2412MHz
		RU Configuration	26/0

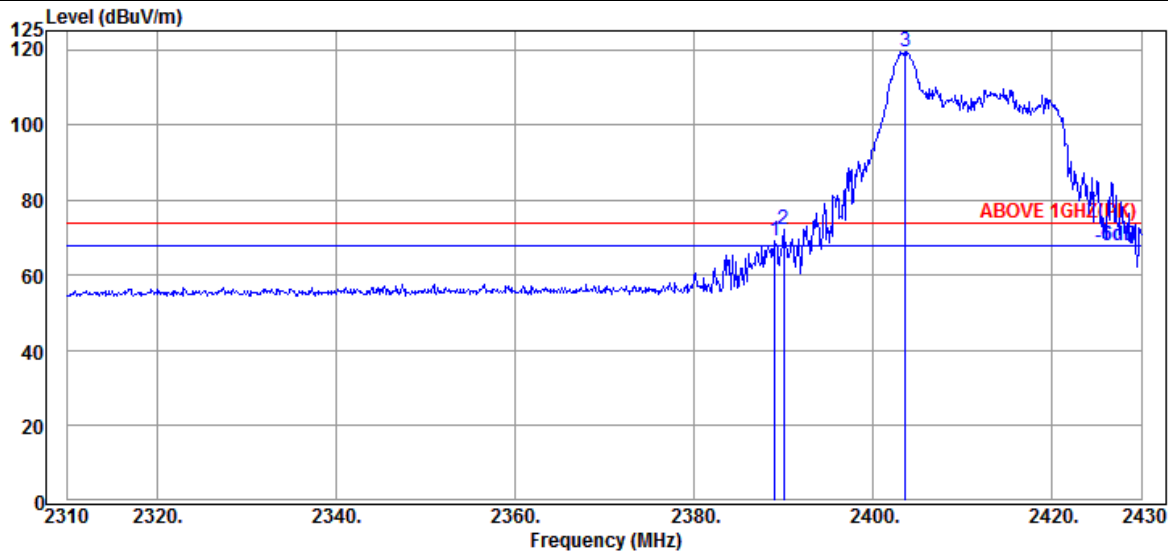

Antenna at Vertical Polarization

Emission Frequency (MHz)	Antenna Factor (dB/m)	Cable Loss (dB)	Preamplifier Gain (dB)	Read Level (dBμV)	Emission Level (dBμV/m)	Limits (dBμV/m)	Margin (dB)	Detector
2389.080	32.44	7.95	39.91	68.57	69.05	74.00	4.95	Peak
2390.040	32.44	7.95	39.91	71.53	72.01	74.00	1.99	Peak
@ 2403.600	32.50	7.95	39.91	118.87	119.41	---	---	Peak

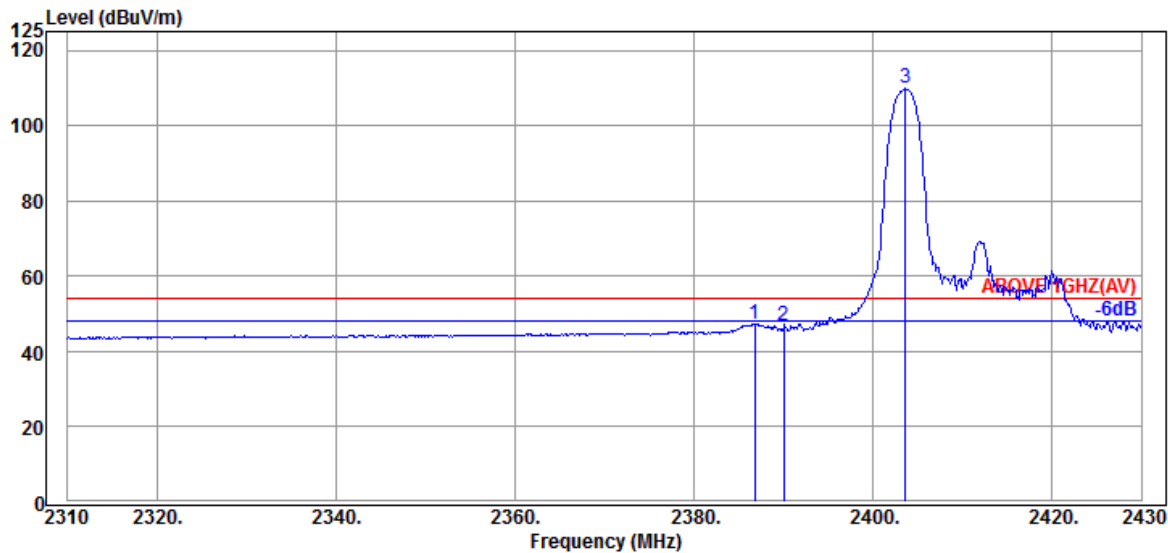

Antenna at Vertical Polarization

Emission Frequency (MHz)	Antenna Factor (dB/m)	Cable Loss (dB)	Preamplifier Gain (dB)	Read Level (dBμV)	Emission Level (dBμV/m)	Limits (dBμV/m)	Margin (dB)	Detector
2386.800	32.44	7.95	39.91	46.95	47.43	54.00	6.57	Average
2390.040	32.44	7.95	39.91	46.46	46.94	54.00	7.06	Average
@ 2403.600	32.50	7.95	39.91	109.28	109.82	---	---	Average

Remark: The "@" means fundamental frequency, it is ignored in this section.

Mode	802.11ax-HE20	Frequency	TX 2412MHz
		RU Configuration	52/37

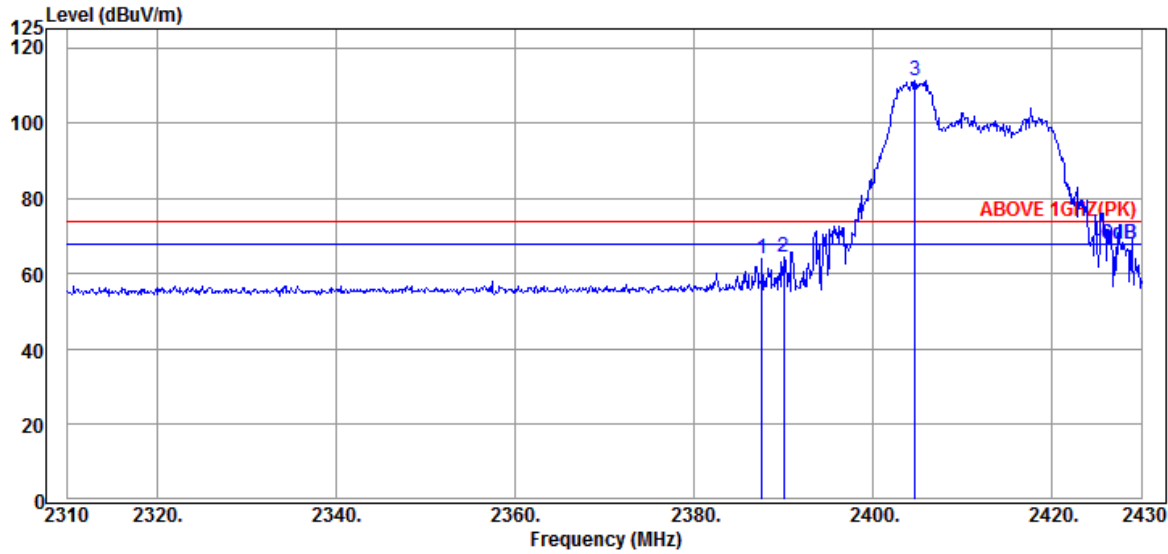

Antenna at Horizontal Polarization

Emission Frequency (MHz)	Antenna Factor (dB/m)	Cable Loss (dB)	Preamp Gain (dB)	Read Level (dBμV)	Emission Level (dBμV/m)	Limits (dBμV/m)	Margin (dB)	Detector
2387.640	32.44	7.95	39.91	63.54	64.02	74.00	9.98	Peak
2390.040	32.44	7.95	39.91	64.14	64.62	74.00	9.38	Peak
@ 2404.680	32.43	7.95	39.91	110.77	111.24	---	---	Peak

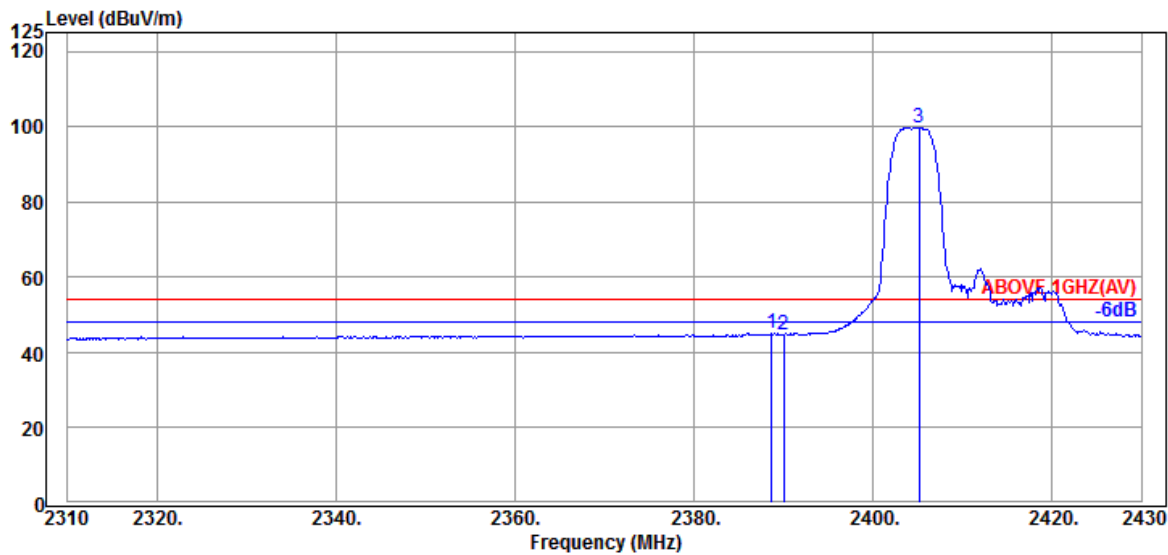

Antenna at Horizontal Polarization

Emission Frequency (MHz)	Antenna Factor (dB/m)	Cable Loss (dB)	Preamp Gain (dB)	Read Level (dBμV)	Emission Level (dBμV/m)	Limits (dBμV/m)	Margin (dB)	Detector
2388.720	32.44	7.95	39.91	44.57	45.05	54.00	8.95	Average
2390.040	32.44	7.95	39.91	44.31	44.79	54.00	9.21	Average
@ 2405.160	32.43	7.95	39.91	99.31	99.78	---	---	Average

Remark: The "@" means fundamental frequency, it is ignored in this section.

Mode	802.11ax-HE20	Frequency	TX 2412MHz
		RU Configuration	52/37

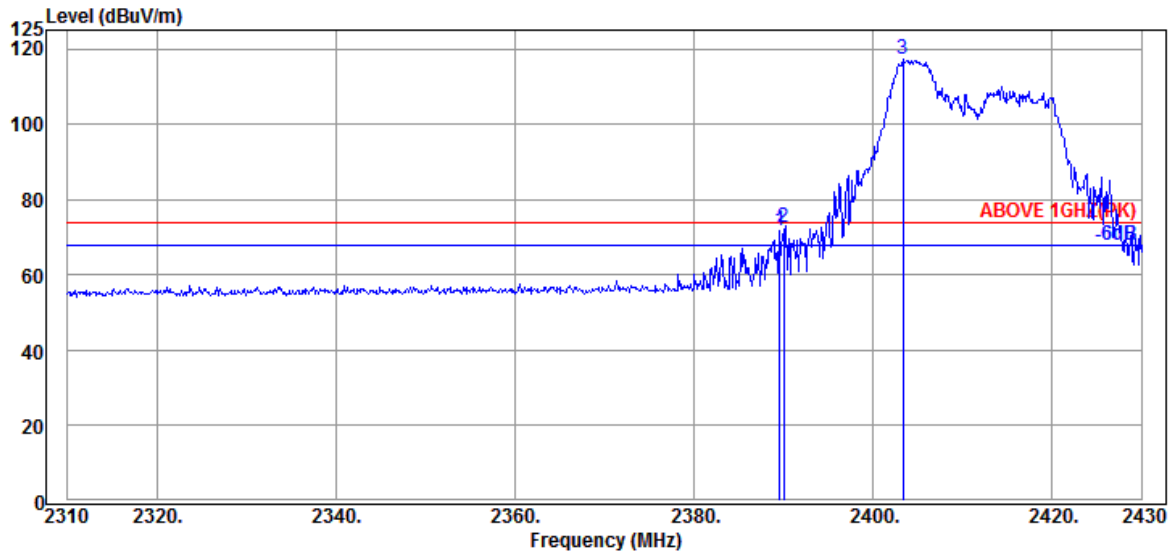

Antenna at Vertical Polarization

Emission Frequency (MHz)	Antenna Factor (dB/m)	Cable Loss (dB)	Preamplifier Gain (dB)	Read Level (dBμV)	Emission Level (dBμV/m)	Limits (dBμV/m)	Margin (dB)	Detector
2389.560	32.44	7.95	39.91	71.32	71.80	74.00	2.20	Peak
2390.040	32.44	7.95	39.91	71.95	72.43	74.00	1.57	Peak
@ 2403.360	32.50	7.95	39.91	116.55	117.09	---	---	Peak

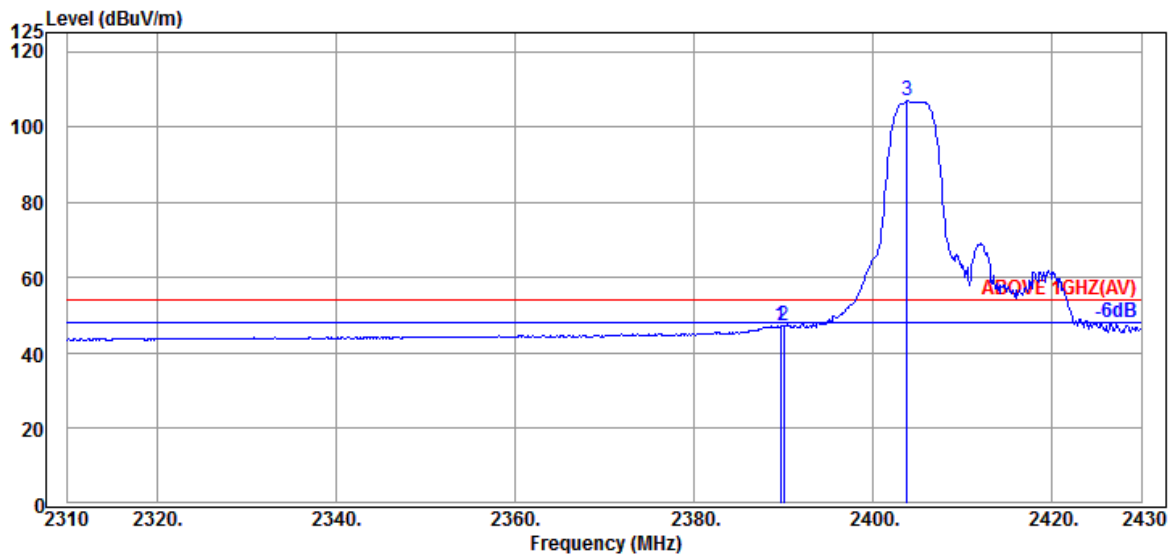

Antenna at Vertical Polarization

Emission Frequency (MHz)	Antenna Factor (dB/m)	Cable Loss (dB)	Preamplifier Gain (dB)	Read Level (dBμV)	Emission Level (dBμV/m)	Limits (dBμV/m)	Margin (dB)	Detector
2389.680	32.44	7.95	39.91	46.73	47.21	54.00	6.79	Average
2390.040	32.44	7.95	39.91	46.68	47.16	54.00	6.84	Average
@ 2403.840	32.50	7.95	39.91	106.33	106.87	---	---	Average

Remark: The "@" means fundamental frequency, it is ignored in this section.

Mode	802.11ax-HE20	Frequency	TX 2412MHz
		RU Configuration	106/53

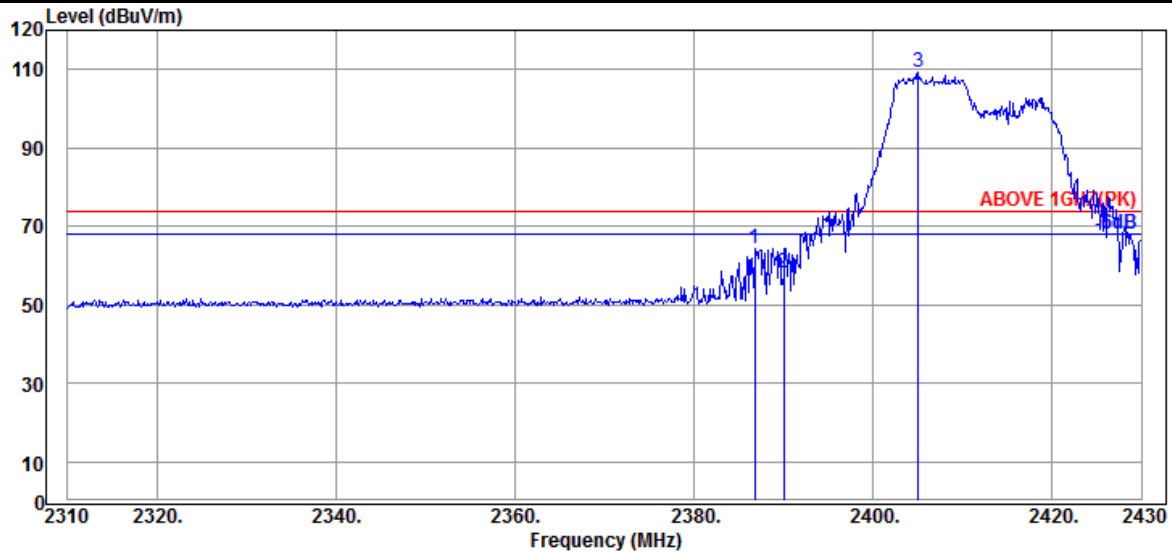

Antenna at Horizontal Polarization

Emission Frequency (MHz)	Antenna Factor (dB/m)	Cable Loss (dB)	Preamp Gain (dB)	Read Level (dBμV)	Emission Level (dBμV/m)	Limits (dBμV/m)	Margin (dB)	Detector
2386.800	32.44	7.95	39.91	64.05	64.53	74.00	9.47	Peak
2390.040	32.44	7.95	39.91	57.61	58.09	74.00	15.91	Peak
@ 2405.040	32.43	7.95	39.91	108.66	109.13	---	---	Peak

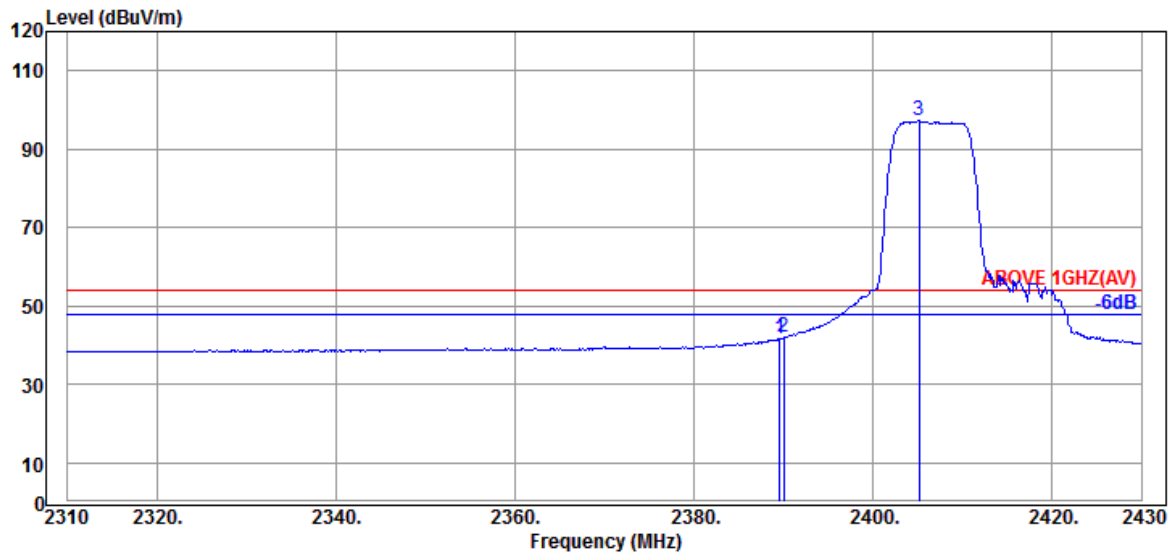

Antenna at Horizontal Polarization

Emission Frequency (MHz)	Antenna Factor (dB/m)	Cable Loss (dB)	Preamp Gain (dB)	Read Level (dBμV)	Emission Level (dBμV/m)	Limits (dBμV/m)	Margin (dB)	Detector
2389.560	32.44	7.95	39.91	41.35	41.83	54.00	12.17	Average
2390.040	32.44	7.95	39.91	41.49	41.97	54.00	12.03	Average
@ 2405.160	32.43	7.95	39.91	96.70	97.17	---	---	Average

Remark: The "@" means fundamental frequency, it is ignored in this section.

Mode	802.11ax-HE20	Frequency	TX 2412MHz
		RU Configuration	106/53

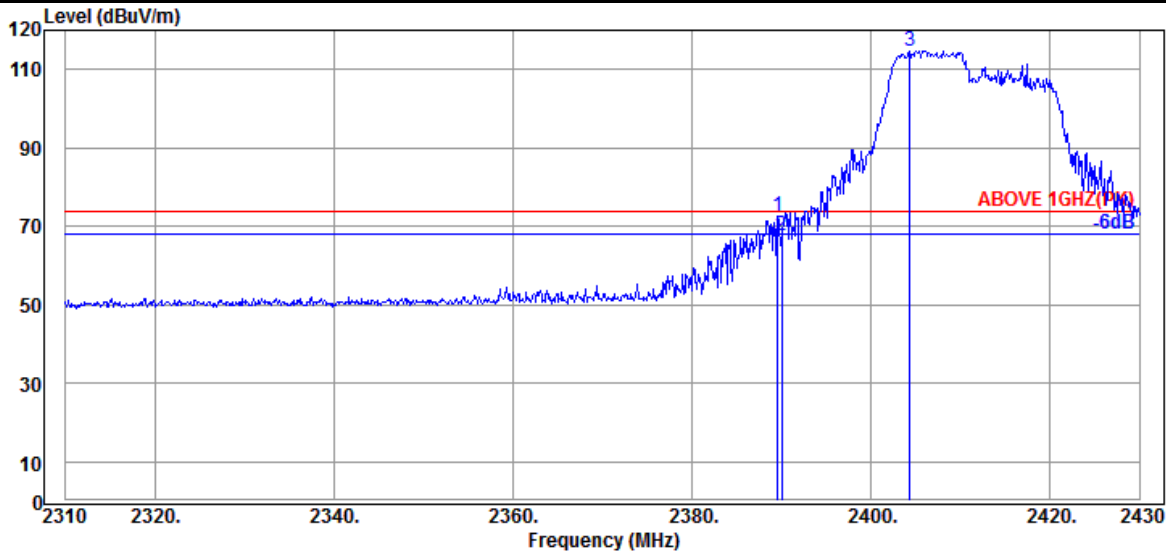

Antenna at Vertical Polarization

Emission Frequency (MHz)	Antenna Factor (dB/m)	Cable Loss (dB)	Preamp Gain (dB)	Read Level (dBμV)	Emission Level (dBμV/m)	Limits (dBμV/m)	Margin (dB)	Detector
2389.560	32.44	7.95	39.91	71.92	72.40	74.00	1.60	Peak
2390.040	32.44	7.95	39.91	67.27	67.75	74.00	6.25	Peak
@ 2404.320	32.43	7.95	39.91	114.37	114.84	---	---	Peak

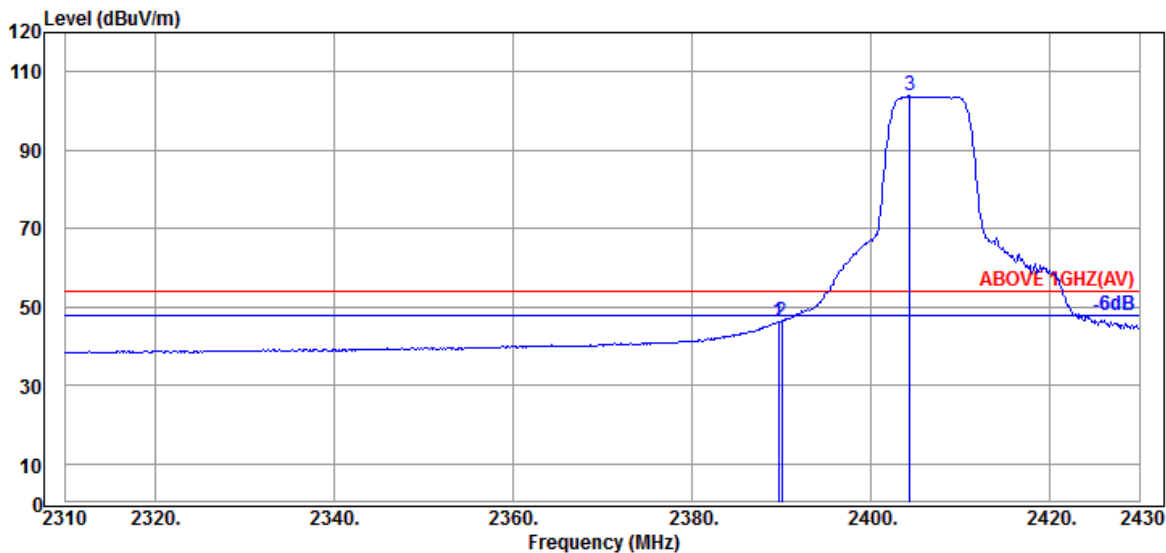

Antenna at Vertical Polarization

Emission Frequency (MHz)	Antenna Factor (dB/m)	Cable Loss (dB)	Preamp Gain (dB)	Read Level (dBμV)	Emission Level (dBμV/m)	Limits (dBμV/m)	Margin (dB)	Detector
2389.680	32.44	7.95	39.91	45.51	45.99	54.00	8.01	Average
2390.040	32.44	7.95	39.91	45.87	46.35	54.00	7.65	Average
@ 2404.320	32.43	7.95	39.91	103.29	103.76	---	---	Average

Remark: The “@” means fundamental frequency, it is ignored in this section.

Mode	802.11ax-HE20	Frequency	TX 2472MHz
		RU Configuration	26/8

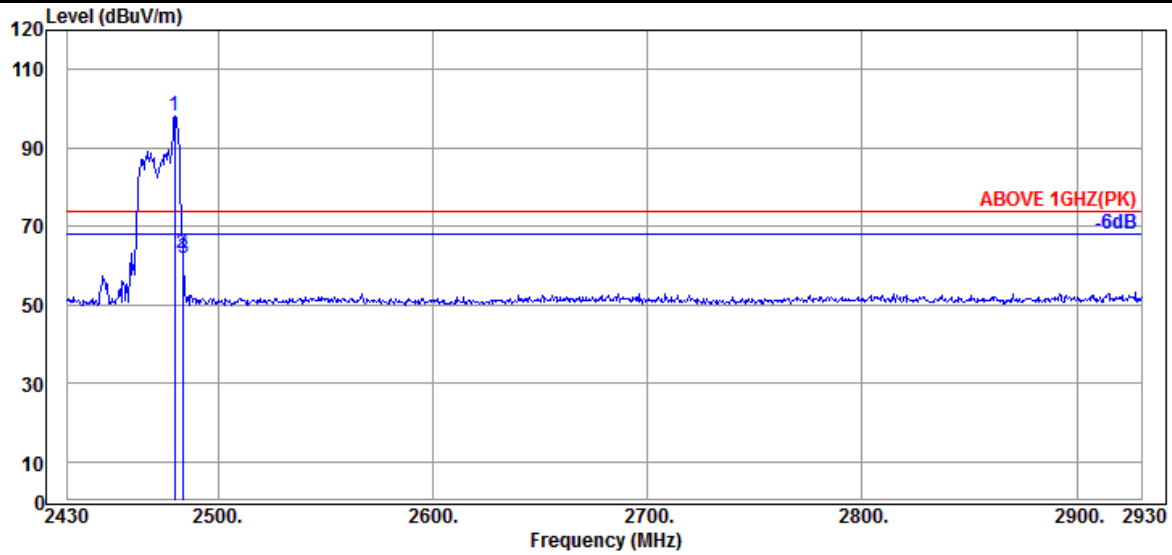

Antenna at Horizontal Polarization

	Emission Frequency (MHz)	Antenna Factor (dB/m)	Cable Loss (dB)	Preamplifier Gain (dB)	Read Level (dBμV)	Emission Level (dBμV/m)	Limits (dBμV/m)	Margin (dB)	Detector
@	2480.000	32.11	7.99	39.91	97.75	97.94	---	---	Peak
	2483.500	32.14	7.99	39.91	63.03	63.25	74.00	10.75	Peak
	2484.000	32.14	7.99	39.91	61.56	61.78	74.00	12.22	Peak

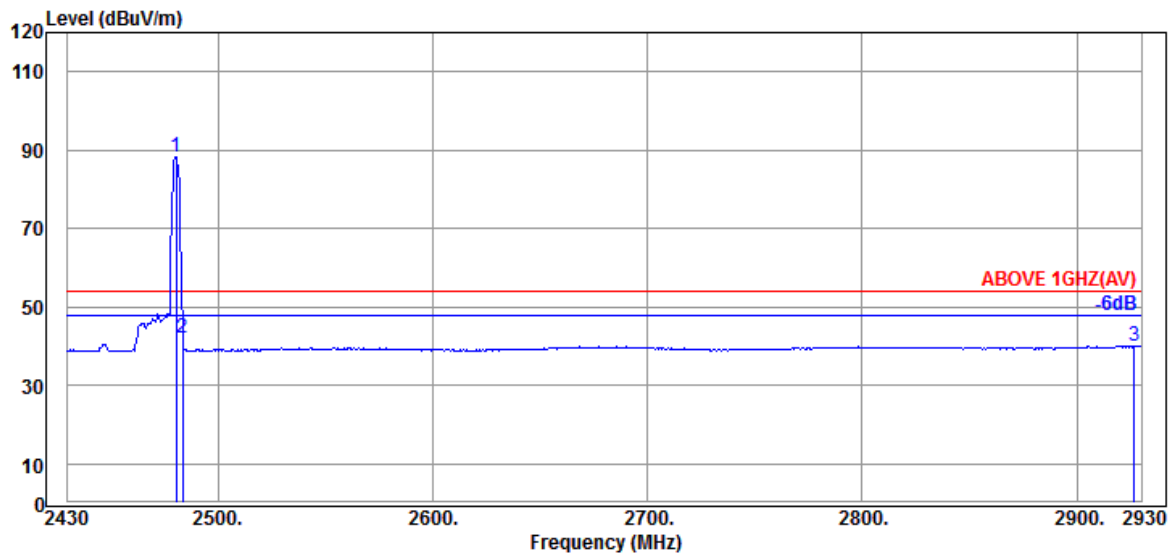

Antenna at Horizontal Polarization

	Emission Frequency (MHz)	Antenna Factor (dB/m)	Cable Loss (dB)	Preamplifier Gain (dB)	Read Level (dBμV)	Emission Level (dBμV/m)	Limits (dBμV/m)	Margin (dB)	Detector
@	2480.500	32.11	7.99	39.91	88.18	88.37	---	---	Average
	2483.500	32.14	7.99	39.91	41.66	41.88	54.00	12.12	Average
	2926.500	32.93	8.19	40.01	38.93	40.04	54.00	13.96	Average

Remark: The “@” means fundamental frequency, it is ignored in this section.

Mode	802.11ax-HE20	Frequency	TX 2472MHz
		RU Configuration	26/8

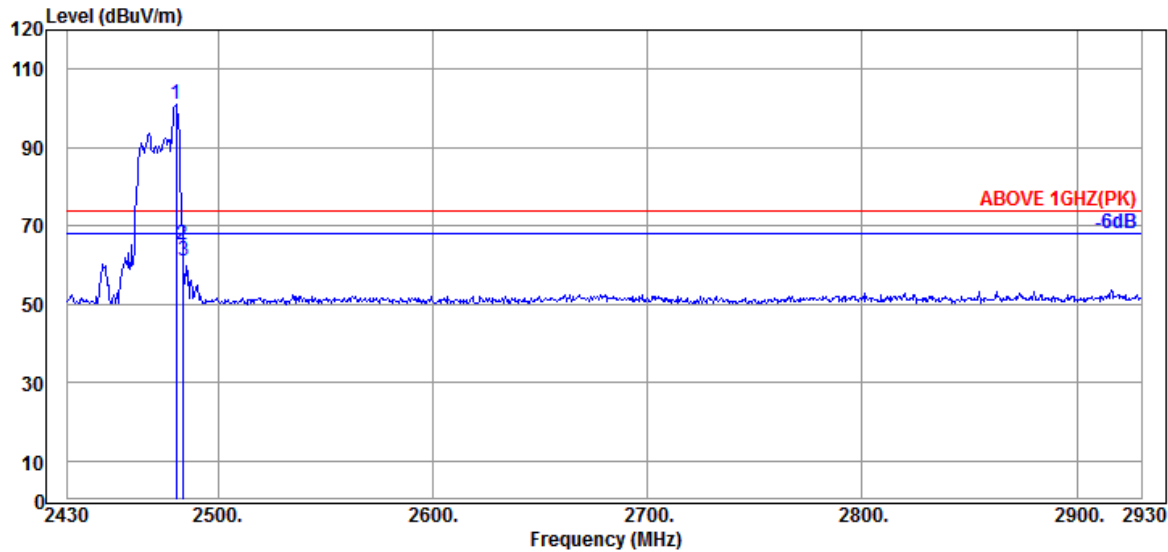

Antenna at Vertical Polarization

Emission Frequency (MHz)	Antenna Factor (dB/m)	Cable Loss (dB)	Preamplifier Gain (dB)	Read Level (dBμV)	Emission Level (dBμV/m)	Limits (dBμV/m)	Margin (dB)	Detector
@ 2480.500	32.11	7.99	39.91	100.77	100.96	---	---	Peak
2483.500	32.14	7.99	39.91	65.13	65.35	74.00	8.65	Peak
2484.000	32.14	7.99	39.91	61.00	61.22	74.00	12.78	Peak

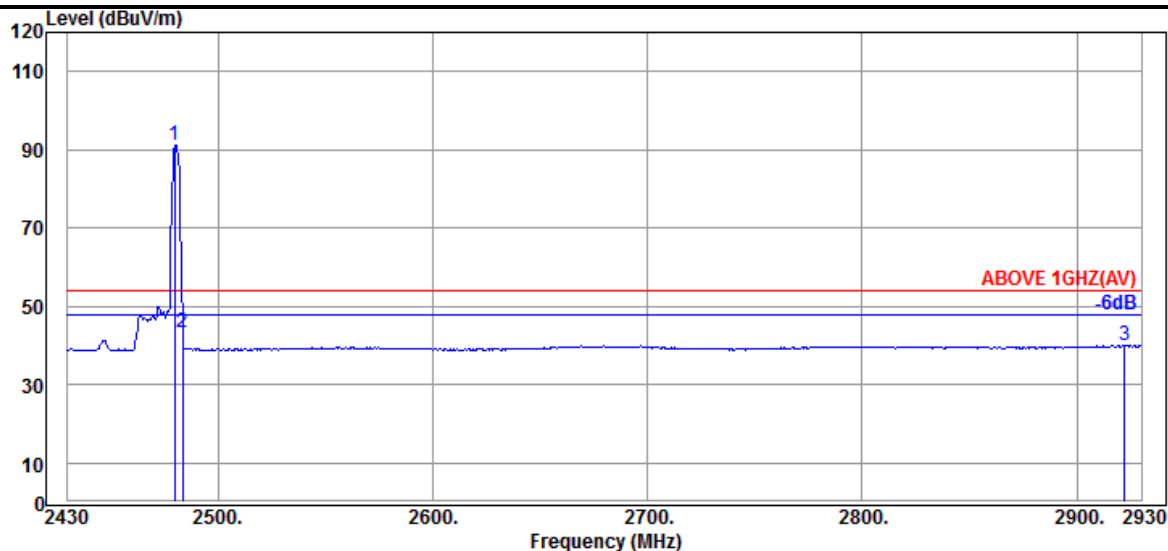

Antenna at Vertical Polarization

Emission Frequency (MHz)	Antenna Factor (dB/m)	Cable Loss (dB)	Preamplifier Gain (dB)	Read Level (dBμV)	Emission Level (dBμV/m)	Limits (dBμV/m)	Margin (dB)	Detector
@ 2480.000	32.11	7.99	39.91	91.01	91.20	---	---	Average
2483.500	32.14	7.99	39.91	42.92	43.14	54.00	10.86	Average
2922.000	32.90	8.19	40.01	38.98	40.06	54.00	13.94	Average

Remark: The "@" means fundamental frequency, it is ignored in this section.

Mode	802.11ax-HE20	Frequency	TX 2472MHz
		RU Configuration	52/40

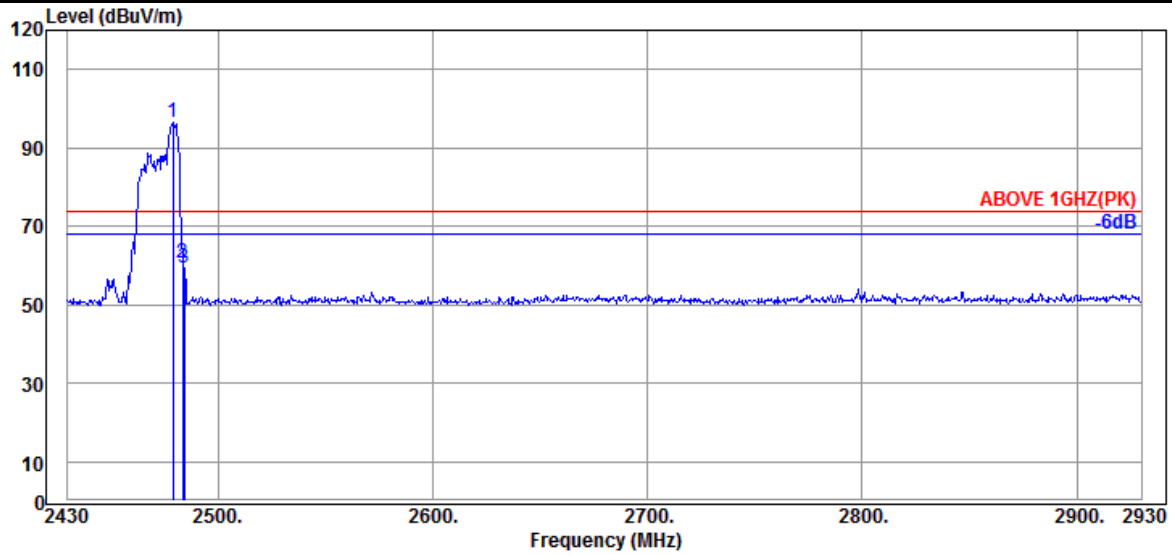

Antenna at Horizontal Polarization

Emission Frequency (MHz)	Antenna Factor (dB/m)	Cable Loss (dB)	Preamp Gain (dB)	Read Level (dBμV)	Emission Level (dBμV/m)	Limits (dBμV/m)	Margin (dB)	Detector
@ 2479.000	32.11	7.99	39.91	96.37	96.56	---	---	Peak
2483.500	32.14	7.99	39.91	60.51	60.73	74.00	13.27	Peak
2484.500	32.14	7.99	39.91	59.22	59.44	74.00	14.56	Peak

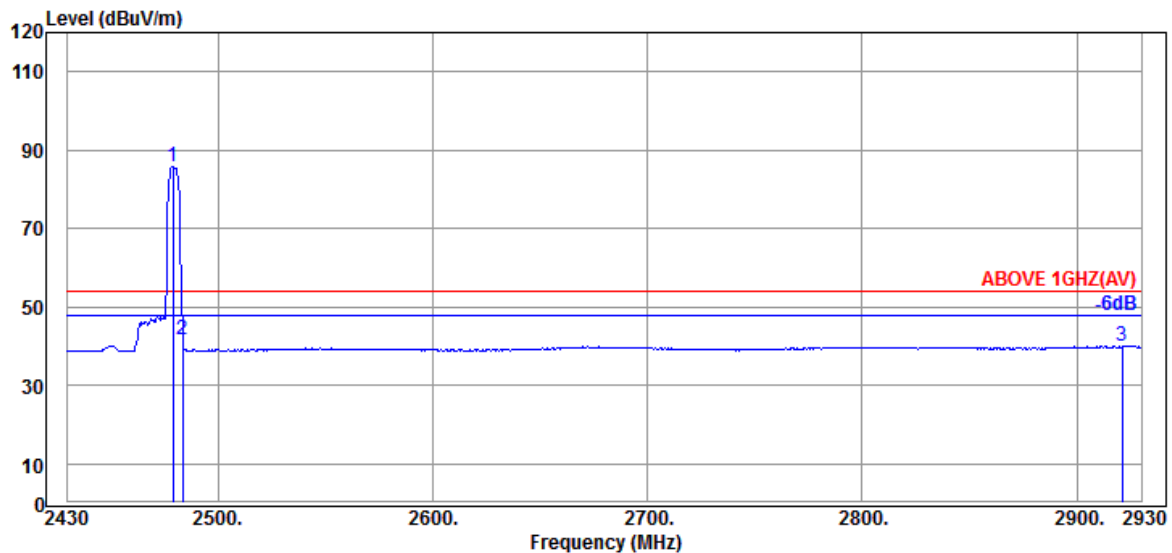

Antenna at Horizontal Polarization

Emission Frequency (MHz)	Antenna Factor (dB/m)	Cable Loss (dB)	Preamp Gain (dB)	Read Level (dBμV)	Emission Level (dBμV/m)	Limits (dBμV/m)	Margin (dB)	Detector
@ 2479.000	32.11	7.99	39.91	85.60	85.79	---	---	Average
2483.500	32.14	7.99	39.91	41.40	41.62	54.00	12.38	Average
2921.000	32.90	8.19	40.01	38.89	39.97	54.00	14.03	Average

Remark: The "@" means fundamental frequency, it is ignored in this section.

Mode	802.11ax-HE20	Frequency	TX 2472MHz
		RU Configuration	52/40

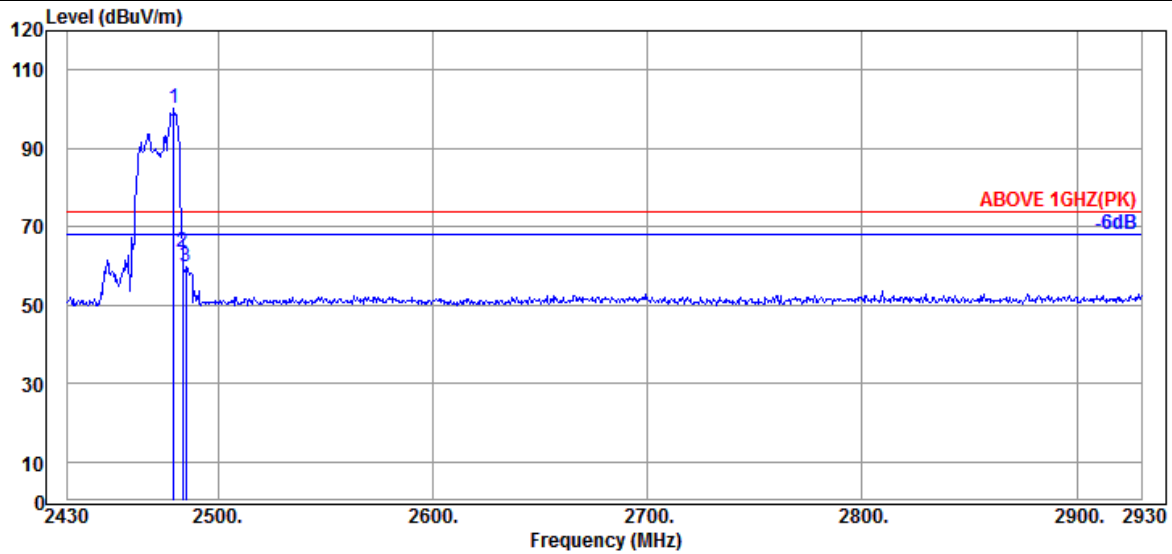

Antenna at Vertical Polarization

Emission Frequency (MHz)	Antenna Factor (dB/m)	Cable Loss (dB)	Preamplifier Gain (dB)	Read Level (dBμV)	Emission Level (dBμV/m)	Limits (dBμV/m)	Margin (dB)	Detector
@ 2479.500	32.11	7.99	39.91	99.95	100.14	---	---	Peak
2483.500	32.14	7.99	39.91	63.41	63.63	74.00	10.37	Peak
2485.000	32.14	7.99	39.91	59.60	59.82	74.00	14.18	Peak

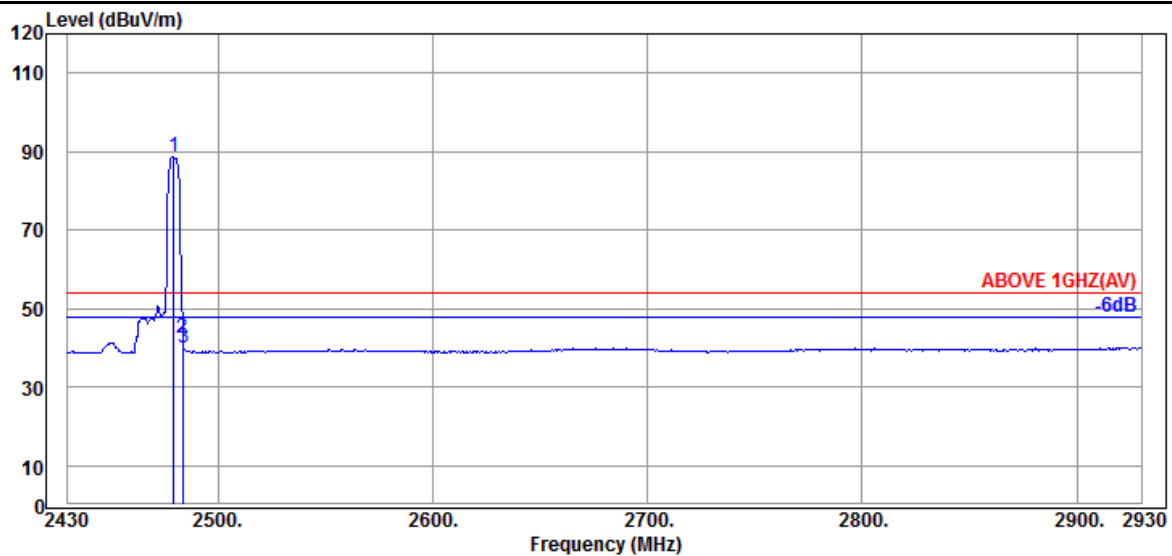

Antenna at Vertical Polarization

Emission Frequency (MHz)	Antenna Factor (dB/m)	Cable Loss (dB)	Preamplifier Gain (dB)	Read Level (dBμV)	Emission Level (dBμV/m)	Limits (dBμV/m)	Margin (dB)	Detector
@ 2479.500	32.11	7.99	39.91	88.33	88.52	---	---	Average
2483.500	32.14	7.99	39.91	42.17	42.39	54.00	11.61	Average
2484.000	32.14	7.99	39.91	39.88	40.10	54.00	13.90	Average

Remark: The “@” means fundamental frequency, it is ignored in this section.

Mode	802.11ax-HE20	Frequency	TX 2472MHz
		RU Configuration	106/54

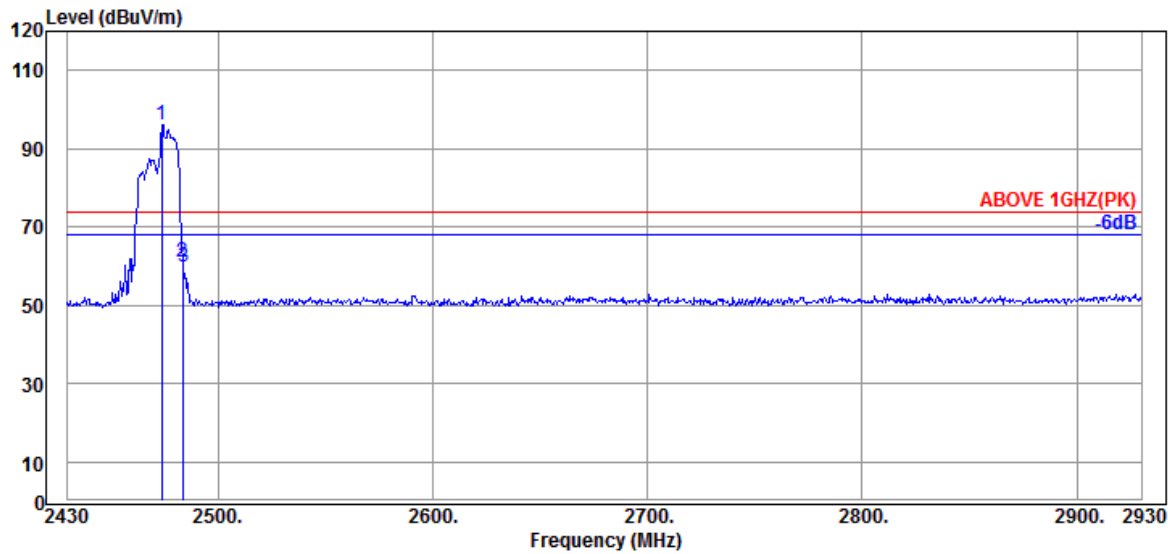

Antenna at Horizontal Polarization

Emission Frequency (MHz)	Antenna Factor (dB/m)	Cable Loss (dB)	Preamplifier Gain (dB)	Read Level (dBμV)	Emission Level (dBμV/m)	Limits (dBμV/m)	Margin (dB)	Detector
@ 2474.000	32.09	7.99	39.91	96.02	96.19	---	---	Peak
2483.500	32.14	7.99	39.91	60.86	61.08	74.00	12.92	Peak
2484.000	32.14	7.99	39.91	59.66	59.88	74.00	14.12	Peak

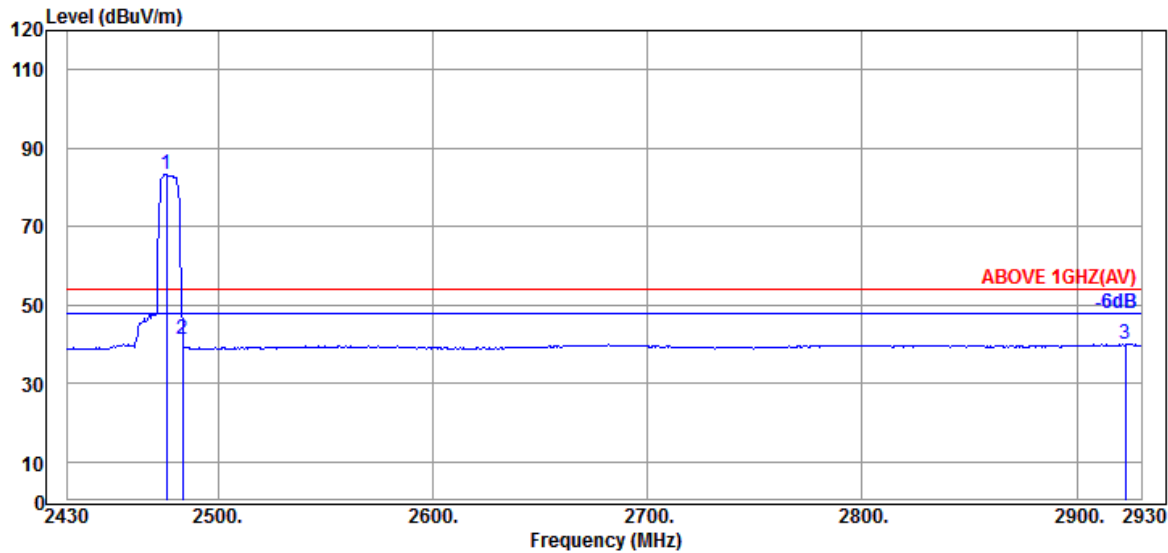

Antenna at Horizontal Polarization

Emission Frequency (MHz)	Antenna Factor (dB/m)	Cable Loss (dB)	Preamplifier Gain (dB)	Read Level (dBμV)	Emission Level (dBμV/m)	Limits (dBμV/m)	Margin (dB)	Detector
@ 2476.000	32.11	7.99	39.91	83.07	83.26	---	---	Average
2483.500	32.14	7.99	39.91	41.05	41.27	54.00	12.73	Average
2922.500	32.90	8.19	40.01	39.04	40.12	54.00	13.88	Average

Remark: The “@” means fundamental frequency, it is ignored in this section.

Mode	802.11ax-HE20	Frequency	TX 2472MHz
		RU Configuration	106/54

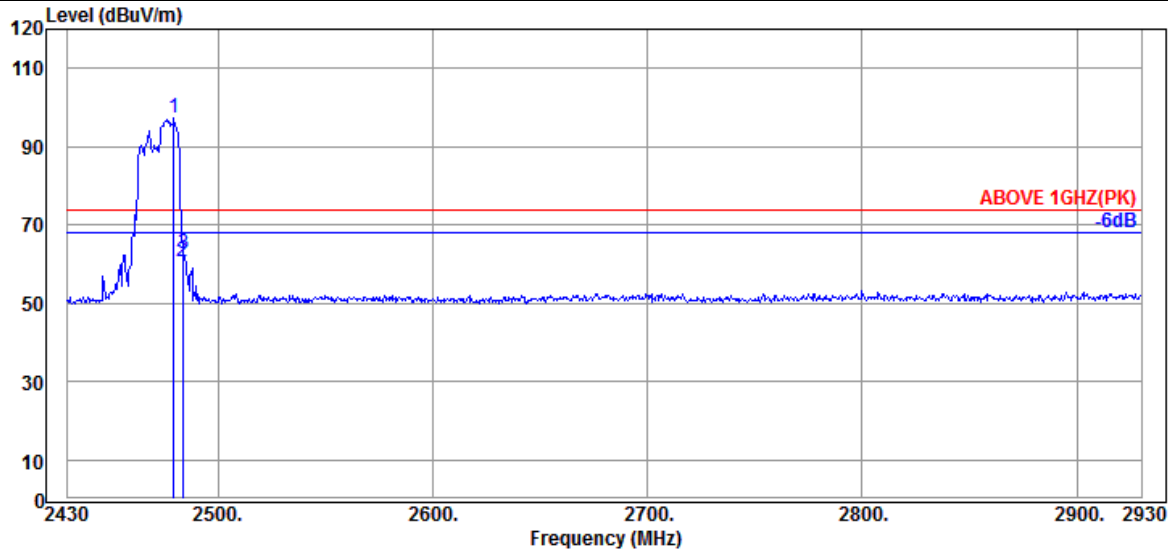

Antenna at Vertical Polarization

Emission Frequency (MHz)	Antenna Factor (dB/m)	Cable Loss (dB)	Preamplifier Gain (dB)	Read Level (dBμV)	Emission Level (dBμV/m)	Limits (dBμV/m)	Margin (dB)	Detector
@ 2479.500	32.11	7.99	39.91	97.26	97.45	---	---	Peak
2483.500	32.14	7.99	39.91	60.38	60.60	74.00	13.40	Peak
2484.000	32.14	7.99	39.91	62.59	62.81	74.00	11.19	Peak

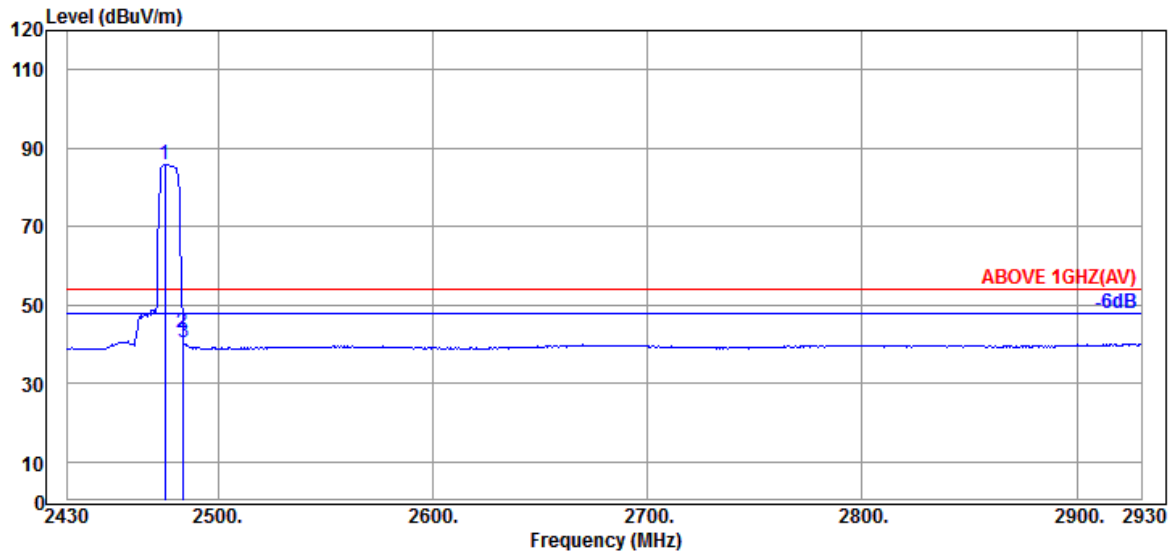

Antenna at Vertical Polarization

Emission Frequency (MHz)	Antenna Factor (dB/m)	Cable Loss (dB)	Preamplifier Gain (dB)	Read Level (dBμV)	Emission Level (dBμV/m)	Limits (dBμV/m)	Margin (dB)	Detector
@ 2475.500	32.11	7.99	39.91	85.66	85.85	---	---	Average
2483.500	32.14	7.99	39.91	42.47	42.69	54.00	11.31	Average
2484.000	32.14	7.99	39.91	39.99	40.21	54.00	13.79	Average

Remark: The “@” means fundamental frequency, it is ignored in this section.

Mode	802.11ax-HE40	Frequency	TX 2422MHz
		RU Configuration	242/61

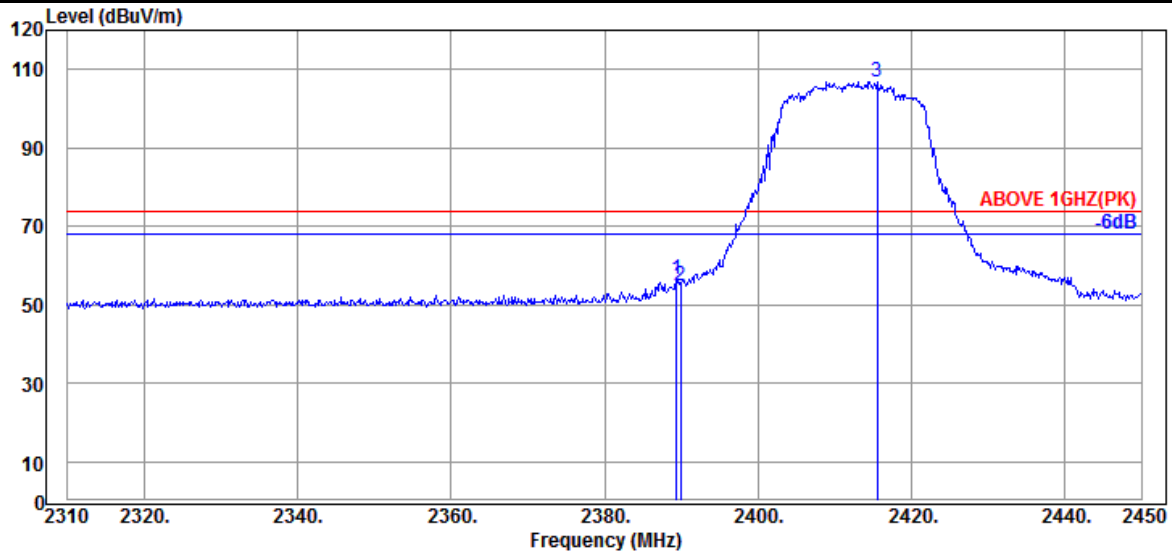

Antenna at Horizontal Polarization

Emission Frequency (MHz)	Antenna Factor (dB/m)	Cable Loss (dB)	Preamp Gain (dB)	Read Level (dBμV)	Emission Level (dBμV/m)	Limits (dBμV/m)	Margin (dB)	Detector
2389.380	32.44	7.95	39.91	56.04	56.52	74.00	17.48	Peak
2389.940	32.44	7.95	39.91	54.48	54.96	74.00	19.04	Peak
@ 2415.560	32.36	7.96	39.91	106.59	107.00	---	---	Peak

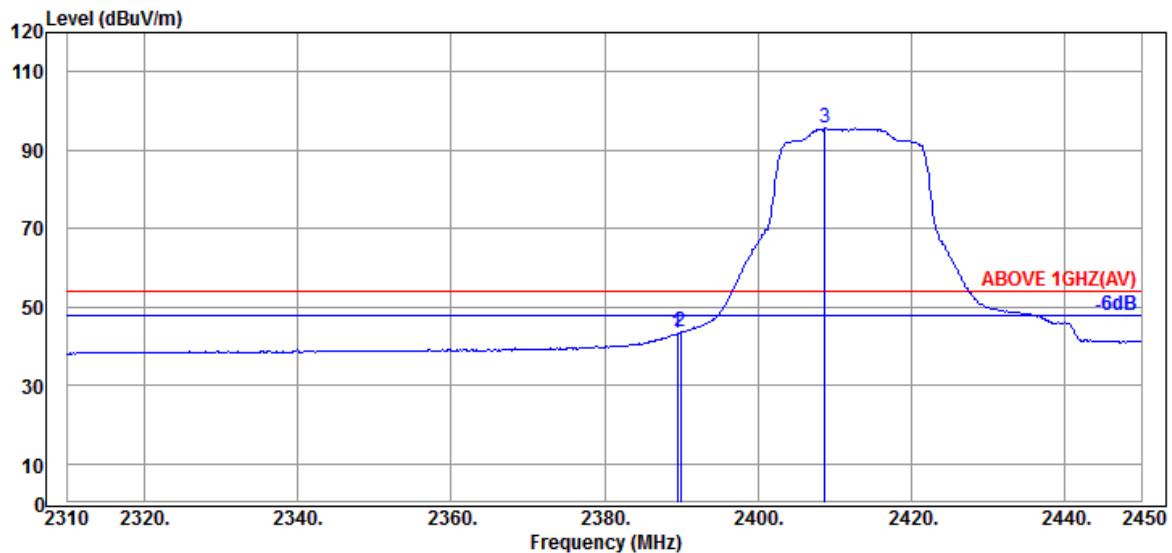

Antenna at Horizontal Polarization

Emission Frequency (MHz)	Antenna Factor (dB/m)	Cable Loss (dB)	Preamp Gain (dB)	Read Level (dBμV)	Emission Level (dBμV/m)	Limits (dBμV/m)	Margin (dB)	Detector
2389.520	32.44	7.95	39.91	42.67	43.15	54.00	10.85	Average
2389.940	32.44	7.95	39.91	43.10	43.58	54.00	10.42	Average
@ 2408.700	32.43	7.96	39.91	95.19	95.67	---	---	Average

Remark: The “@” means fundamental frequency, it is ignored in this section.

Mode	802.11ax-HE40	Frequency	TX 2422MHz
		RU Configuration	242/61

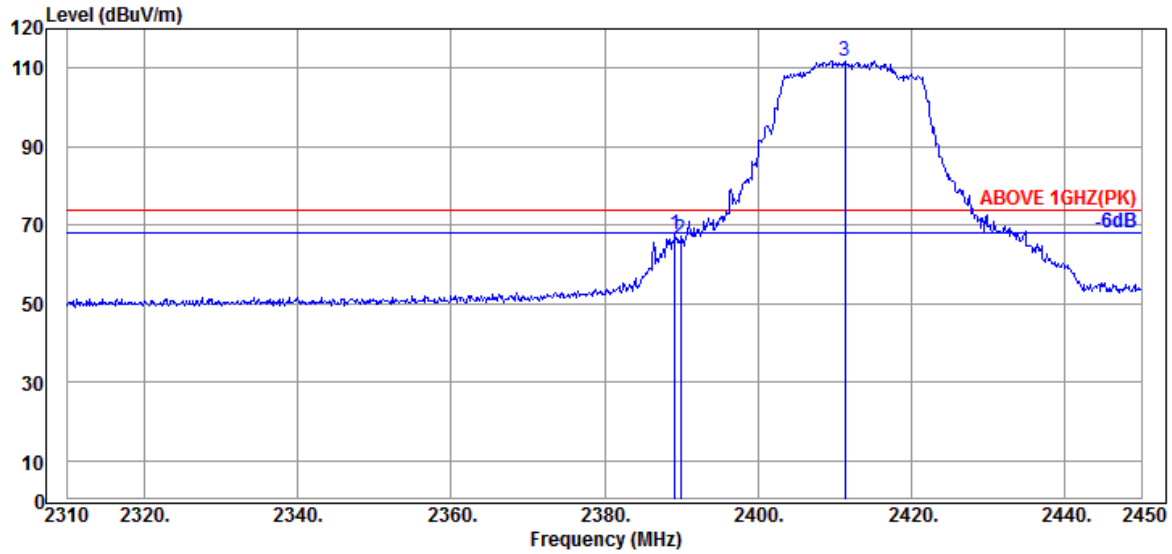

Antenna at Vertical Polarization

Emission Frequency (MHz)	Antenna Factor (dB/m)	Cable Loss (dB)	Preamp Gain (dB)	Read Level (dBμV)	Emission Level (dBμV/m)	Limits (dBμV/m)	Margin (dB)	Detector
2389.240	32.44	7.95	39.91	67.17	67.65	74.00	6.35	Peak
2389.940	32.44	7.95	39.91	66.05	66.53	74.00	7.47	Peak
@ 2411.360	32.36	7.96	39.91	111.53	111.94	---	---	Peak

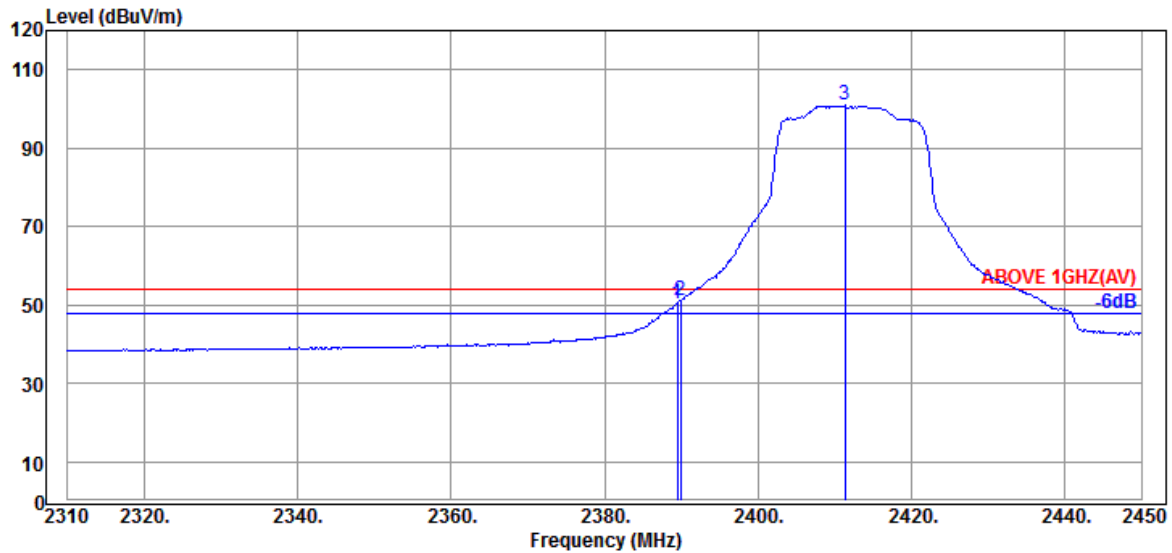

Antenna at Vertical Polarization

Emission Frequency (MHz)	Antenna Factor (dB/m)	Cable Loss (dB)	Preamp Gain (dB)	Read Level (dBμV)	Emission Level (dBμV/m)	Limits (dBμV/m)	Margin (dB)	Detector
2389.520	32.44	7.95	39.91	49.91	50.39	54.00	3.61	Average
2389.940	32.44	7.95	39.91	50.54	51.02	54.00	2.98	Average
@ 2411.360	32.36	7.96	39.91	100.47	100.88	---	---	Average

Remark: The "@" means fundamental frequency, it is ignored in this section.

Mode	802.11ax-HE40	Frequency	TX 2467MHz
		RU Configuration	242/62

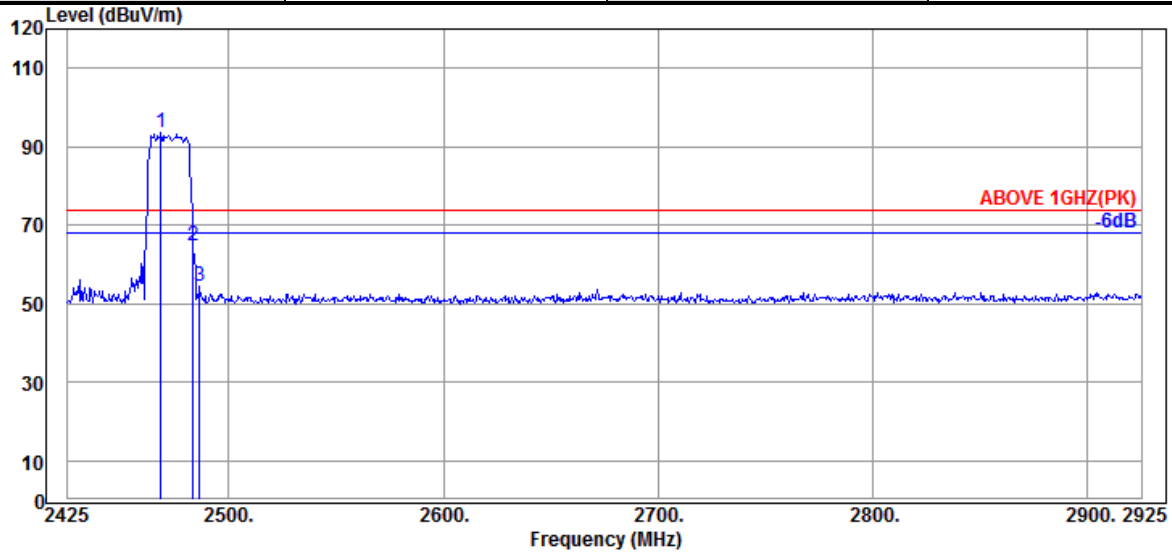

Antenna at Horizontal Polarization

Emission Frequency (MHz)	Antenna Factor (dB/m)	Cable Loss (dB)	Preamplifier Gain (dB)	Read Level (dBμV)	Emission Level (dBμV/m)	Limits (dBμV/m)	Margin (dB)	Detector
@ 2468.500	32.09	7.98	39.91	93.38	93.54	---	---	Peak
2483.500	32.14	7.99	39.91	64.36	64.58	74.00	9.42	Peak
2486.500	32.14	8.00	39.91	54.21	54.44	74.00	19.56	Peak

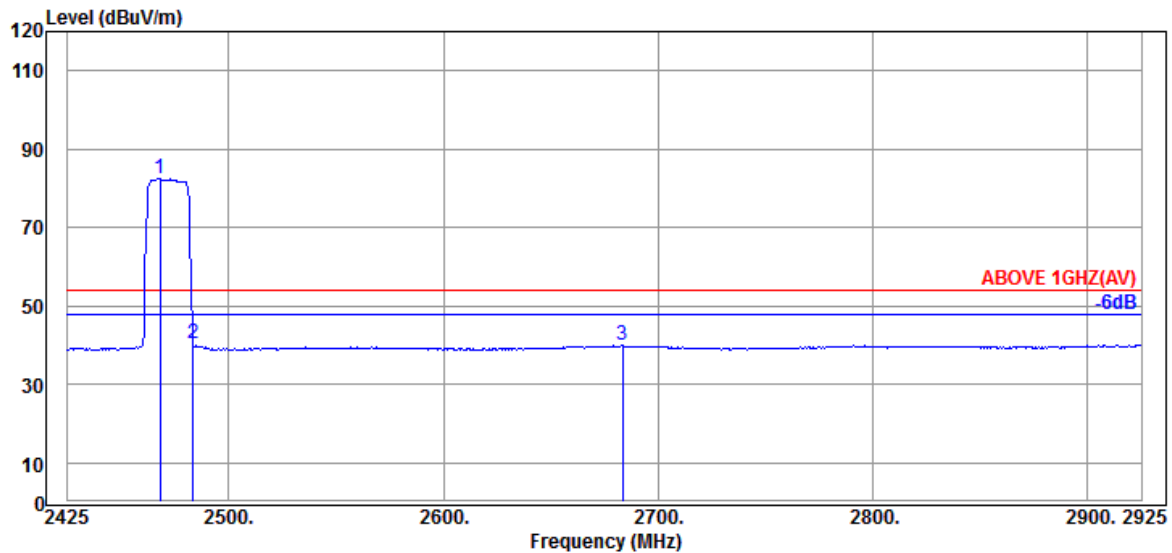

Antenna at Horizontal Polarization

Emission Frequency (MHz)	Antenna Factor (dB/m)	Cable Loss (dB)	Preamplifier Gain (dB)	Read Level (dBμV)	Emission Level (dBμV/m)	Limits (dBμV/m)	Margin (dB)	Detector
@ 2468.000	32.09	7.98	39.91	82.33	82.49	---	---	Average
2483.500	32.14	7.99	39.91	40.26	40.48	54.00	13.52	Average
2683.500	32.34	8.08	39.96	39.62	40.08	54.00	13.92	Average

Remark: The “@” means fundamental frequency, it is ignored in this section.

Mode	802.11ax-HE40	Frequency	TX 2467MHz
		RU Configuration	242/62

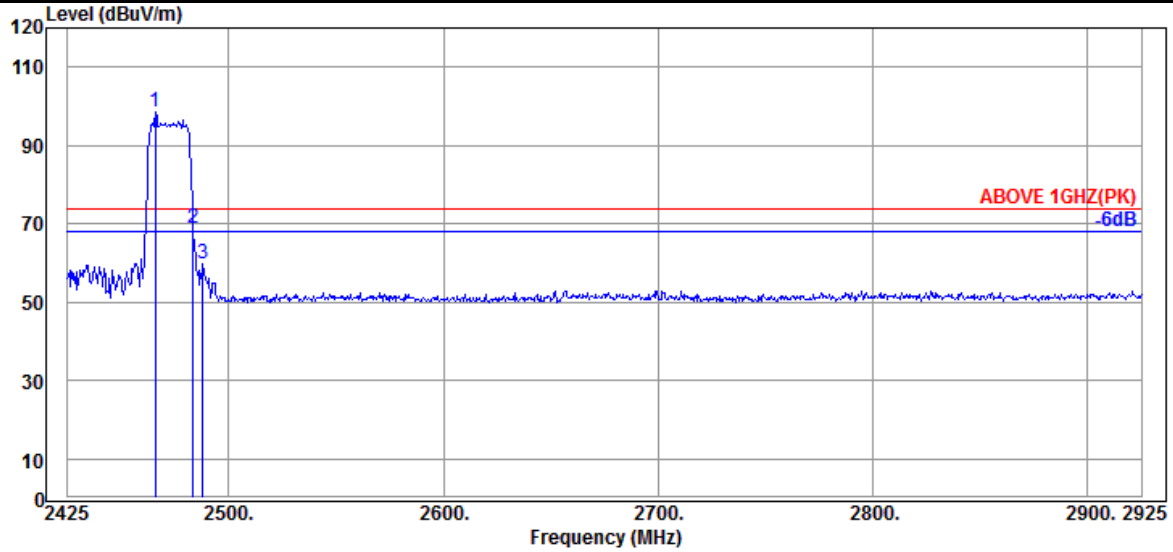

Antenna at Vertical Polarization

Emission Frequency (MHz)	Antenna Factor (dB/m)	Cable Loss (dB)	Preamplifier Gain (dB)	Read Level (dBμV)	Emission Level (dBμV/m)	Limits (dBμV/m)	Margin (dB)	Detector
@ 2466.000	32.06	7.98	39.91	98.57	98.70	---	---	Peak
2483.500	32.14	7.99	39.91	68.46	68.68	74.00	5.32	Peak
2488.000	32.14	8.00	39.91	59.69	59.92	74.00	14.08	Peak

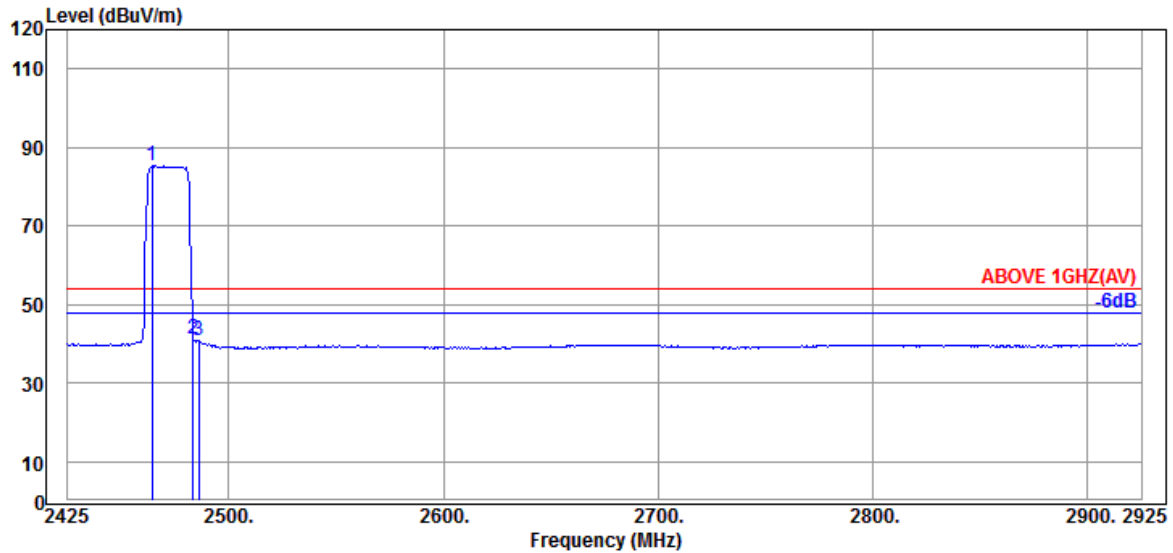

Antenna at Vertical Polarization

Emission Frequency (MHz)	Antenna Factor (dB/m)	Cable Loss (dB)	Preamplifier Gain (dB)	Read Level (dBμV)	Emission Level (dBμV/m)	Limits (dBμV/m)	Margin (dB)	Detector
@ 2464.500	32.06	7.98	39.91	85.30	85.43	---	---	Average
2483.500	32.14	7.99	39.91	41.22	41.44	54.00	12.56	Average
2486.000	32.14	8.00	39.91	40.57	40.80	54.00	13.20	Average

Remark: The “@” means fundamental frequency, it is ignored in this section.

Mode	BLE (PHY Coded S2)	Frequency	TX 2402MHz
------	--------------------	-----------	------------

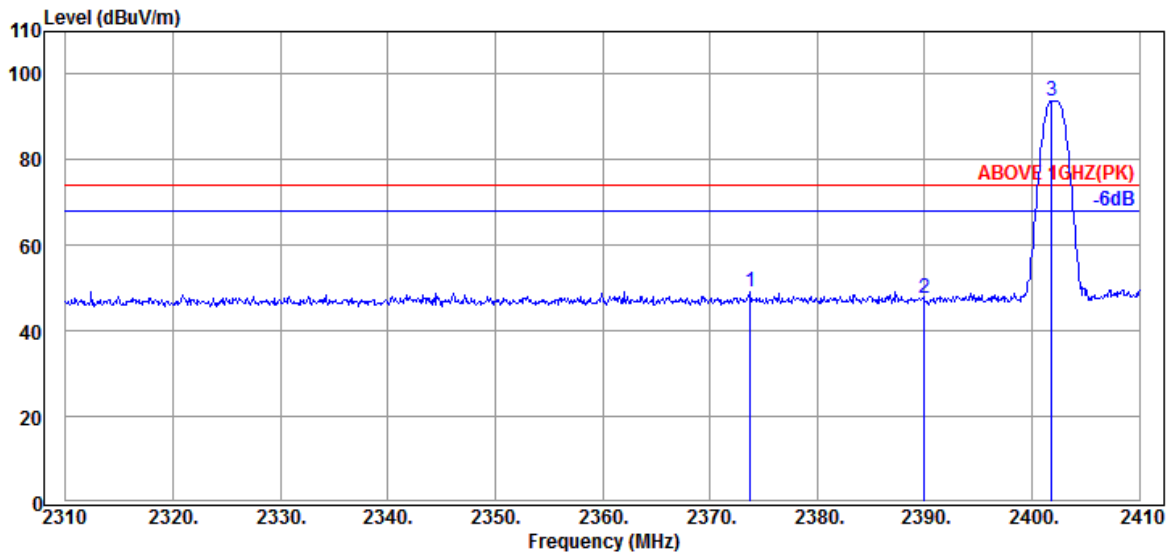

Antenna at Horizontal Polarization

Emission Frequency (MHz)	Antenna Factor (dB/m)	Cable Loss (dB)	Preamplifier Gain (dB)	Read Level (dBμV)	Emission Level (dBμV/m)	Limits (dBμV/m)	Margin (dB)	Detector
2373.800	32.39	7.94	34.58	43.35	49.10	74.00	24.90	Peak
2390.000	32.44	7.95	34.58	41.79	47.60	74.00	26.40	Peak
@ 2401.800	32.50	7.95	34.59	87.83	93.69	---	---	Peak

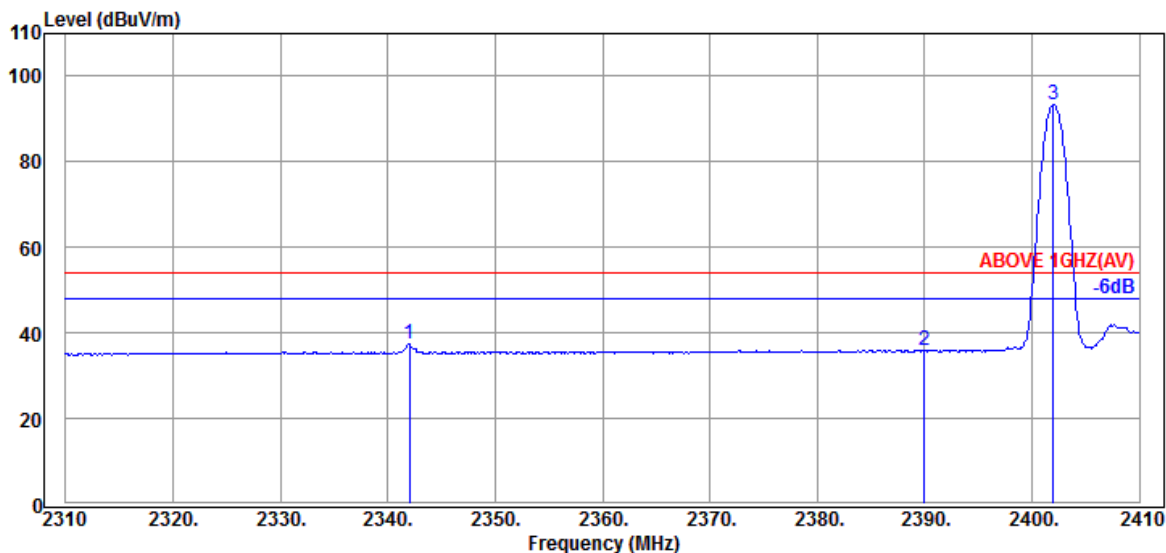

Antenna at Horizontal Polarization

Emission Frequency (MHz)	Antenna Factor (dB/m)	Cable Loss (dB)	Preamplifier Gain (dB)	Read Level (dBμV)	Emission Level (dBμV/m)	Limits (dBμV/m)	Margin (dB)	Detector
2342.000	32.17	7.92	34.57	31.85	37.37	54.00	16.63	Average
2390.000	32.44	7.95	34.58	30.02	35.83	54.00	18.17	Average
@ 2402.000	32.50	7.95	34.59	87.53	93.39	---	---	Average

Remark: The “@” means fundamental frequency, it is ignored in this section.

Mode	BLE (PHY Coded S2)	Frequency	TX 2402MHz
------	--------------------	-----------	------------

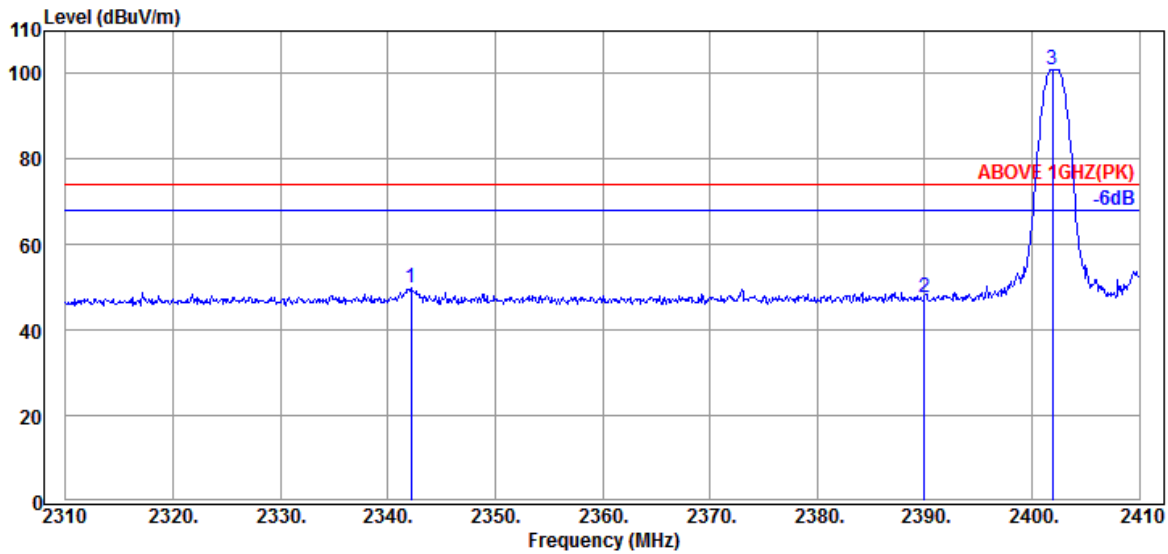

Antenna at Vertical Polarization

Emission Frequency (MHz)	Antenna Factor (dB/m)	Cable Loss (dB)	Preamp Gain (dB)	Read Level (dBμV)	Emission Level (dBμV/m)	Limits (dBμV/m)	Margin (dB)	Detector
2342.200	32.17	7.92	34.57	44.28	49.80	74.00	24.20	Peak
2390.000	32.44	7.95	34.58	41.74	47.55	74.00	26.45	Peak
@ 2401.900	32.50	7.95	34.59	95.06	100.92	---	---	Peak

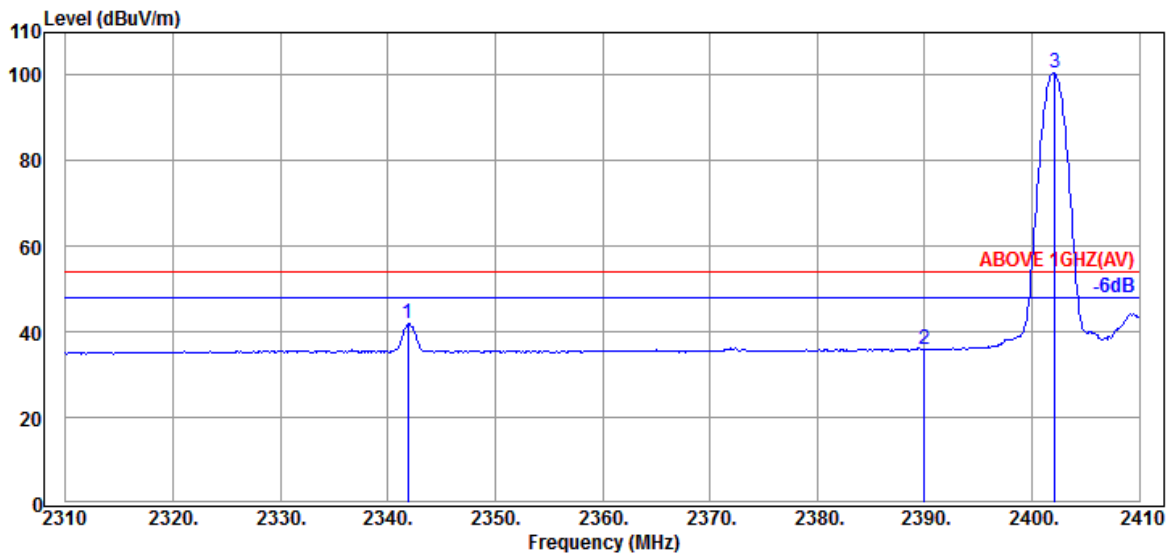

Antenna at Vertical Polarization

Emission Frequency (MHz)	Antenna Factor (dB/m)	Cable Loss (dB)	Preamp Gain (dB)	Read Level (dBμV)	Emission Level (dBμV/m)	Limits (dBμV/m)	Margin (dB)	Detector
2341.900	32.17	7.92	34.57	36.30	41.82	54.00	12.18	Average
2390.000	32.44	7.95	34.58	30.13	35.94	54.00	18.06	Average
@ 2402.100	32.50	7.95	34.59	94.56	100.42	---	---	Average

Remark: The “@” means fundamental frequency, it is ignored in this section.

Mode	BLE (PHY Coded S2)	Frequency	TX 2480MHz
------	--------------------	-----------	------------

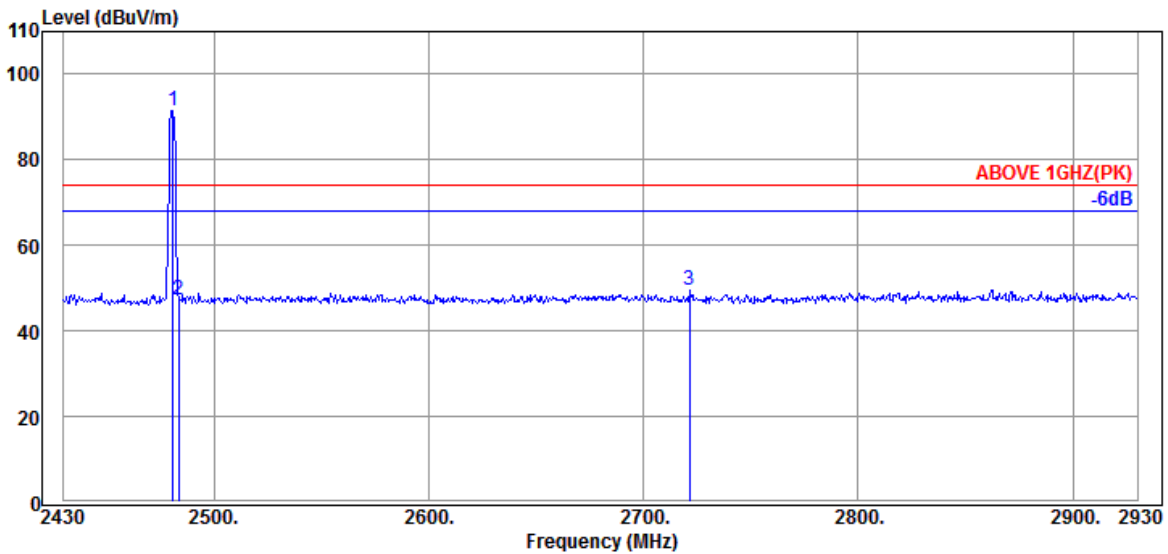

Antenna at Horizontal Polarization

Emission Frequency (MHz)	Antenna Factor (dB/m)	Cable Loss (dB)	Preamplifier Gain (dB)	Read Level (dBμV)	Emission Level (dBμV/m)	Limits (dBμV/m)	Margin (dB)	Detector
@ 2481.000	32.11	7.99	34.60	85.86	91.36	---	---	Peak
2483.500	32.14	7.99	34.61	41.81	47.33	74.00	26.67	Peak
2721.500	32.40	8.11	34.65	43.71	49.57	74.00	24.43	Peak

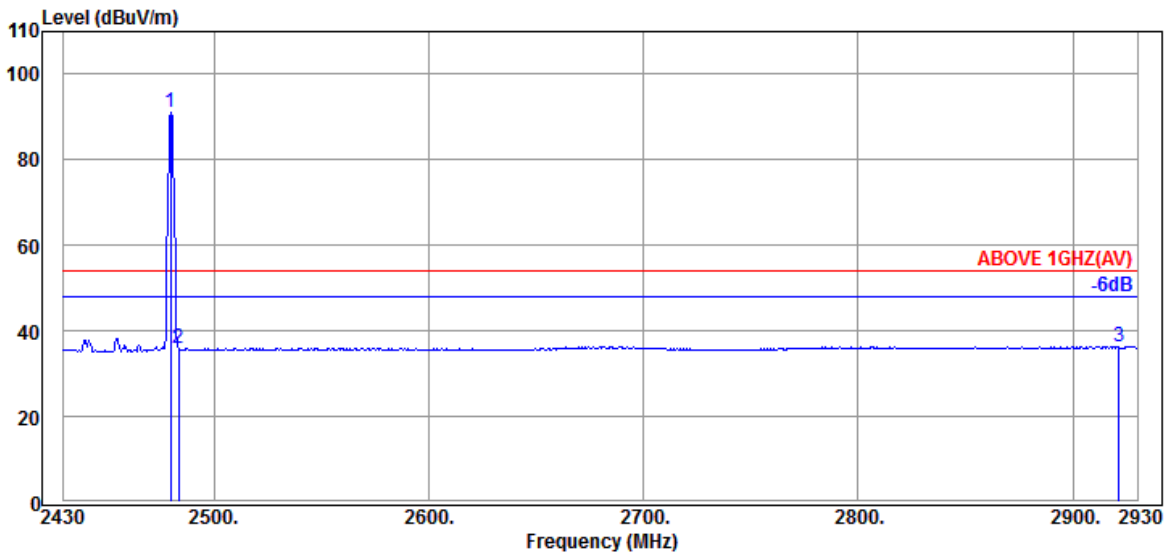

Antenna at Horizontal Polarization

Emission Frequency (MHz)	Antenna Factor (dB/m)	Cable Loss (dB)	Preamplifier Gain (dB)	Read Level (dBμV)	Emission Level (dBμV/m)	Limits (dBμV/m)	Margin (dB)	Detector
@ 2480.000	32.11	7.99	34.60	85.43	90.93	---	---	Average
2483.500	32.14	7.99	34.61	30.31	35.83	54.00	18.17	Average
2921.500	32.90	8.19	34.69	29.95	36.35	54.00	17.65	Average

Remark: The "@" means fundamental frequency, it is ignored in this section.

Mode	BLE (PHY Coded S2)	Frequency	TX 2480MHz
------	--------------------	-----------	------------

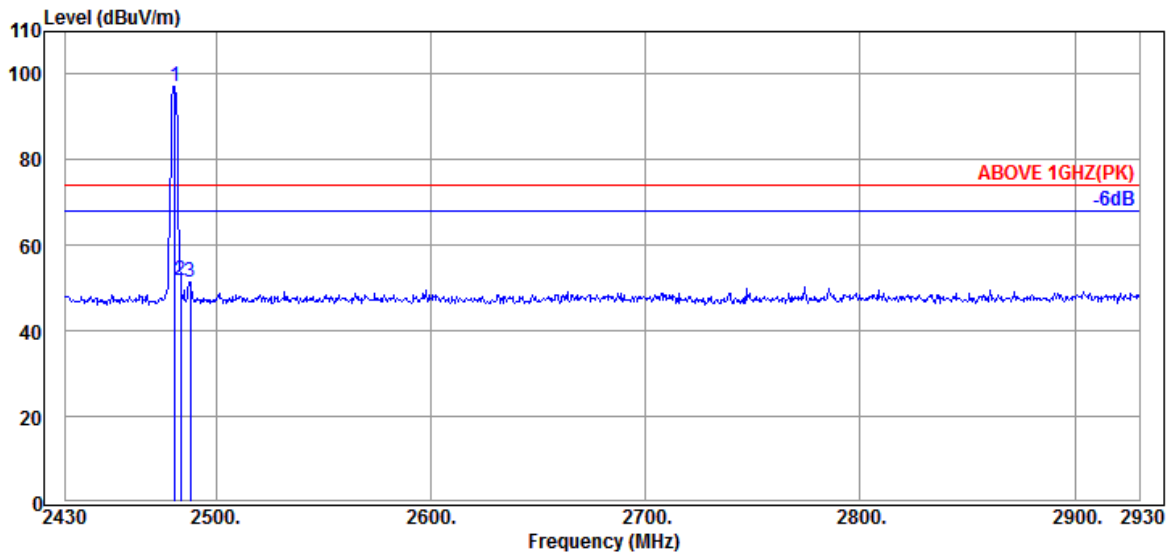

Antenna at Vertical Polarization

Emission Frequency (MHz)	Antenna Factor (dB/m)	Cable Loss (dB)	Preamplifier Gain (dB)	Read Level (dBμV)	Emission Level (dBμV/m)	Limits (dBμV/m)	Margin (dB)	Detector
@ 2481.000	32.11	7.99	34.60	91.71	97.21	---	---	Peak
2483.500	32.14	7.99	34.61	46.37	51.89	74.00	22.11	Peak
2488.000	32.14	8.00	34.61	45.77	51.30	74.00	22.70	Peak

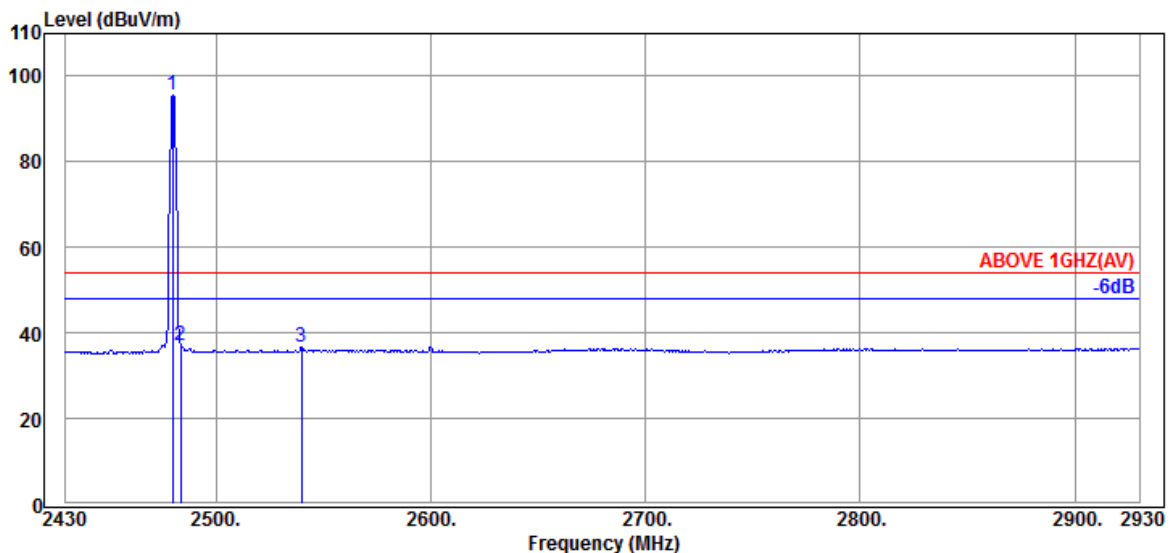

Antenna at Vertical Polarization

Emission Frequency (MHz)	Antenna Factor (dB/m)	Cable Loss (dB)	Preamplifier Gain (dB)	Read Level (dBμV)	Emission Level (dBμV/m)	Limits (dBμV/m)	Margin (dB)	Detector
@ 2480.000	32.11	7.99	34.60	90.30	95.80	---	---	Average
2483.500	32.14	7.99	34.61	31.56	37.08	54.00	16.92	Average
2540.000	32.29	8.02	34.62	31.14	36.83	54.00	17.17	Average

Remark: The "@" means fundamental frequency, it is ignored in this section.

Mode	BLE (2M)	Frequency	TX 2402MHz
------	----------	-----------	------------

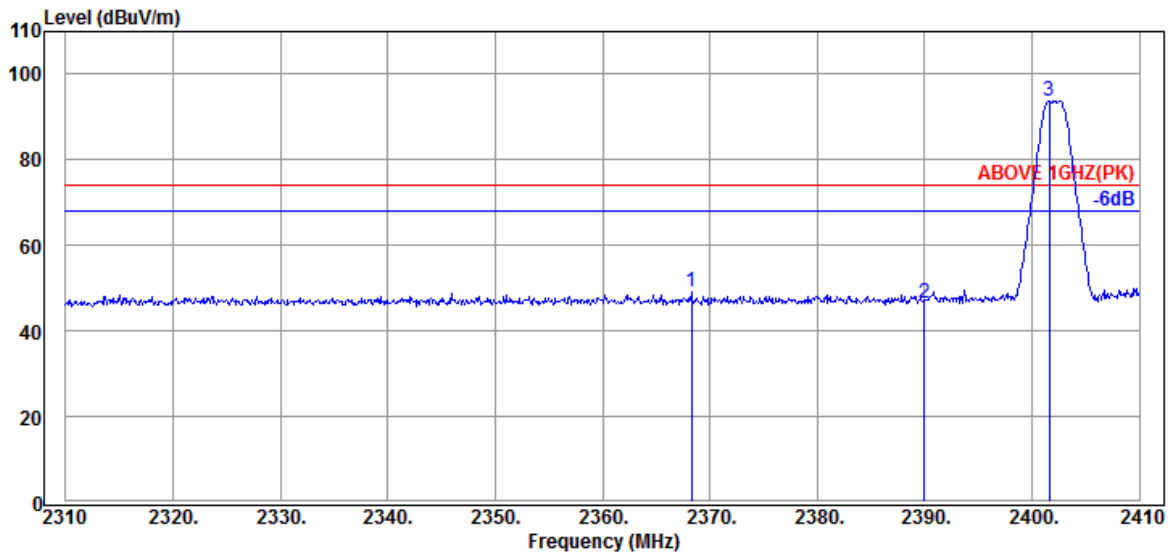

Antenna at Horizontal Polarization

Emission Frequency (MHz)	Antenna Factor (dB/m)	Cable Loss (dB)	Preamp Gain (dB)	Read Level (dBμV)	Emission Level (dBμV/m)	Limits (dBμV/m)	Margin (dB)	Detector
2368.300	32.36	7.94	34.58	43.47	49.19	74.00	24.81	Peak
2390.000	32.44	7.95	34.58	40.79	46.60	74.00	27.40	Peak
@ 2401.600	32.50	7.95	34.59	87.84	93.70	---	---	Peak

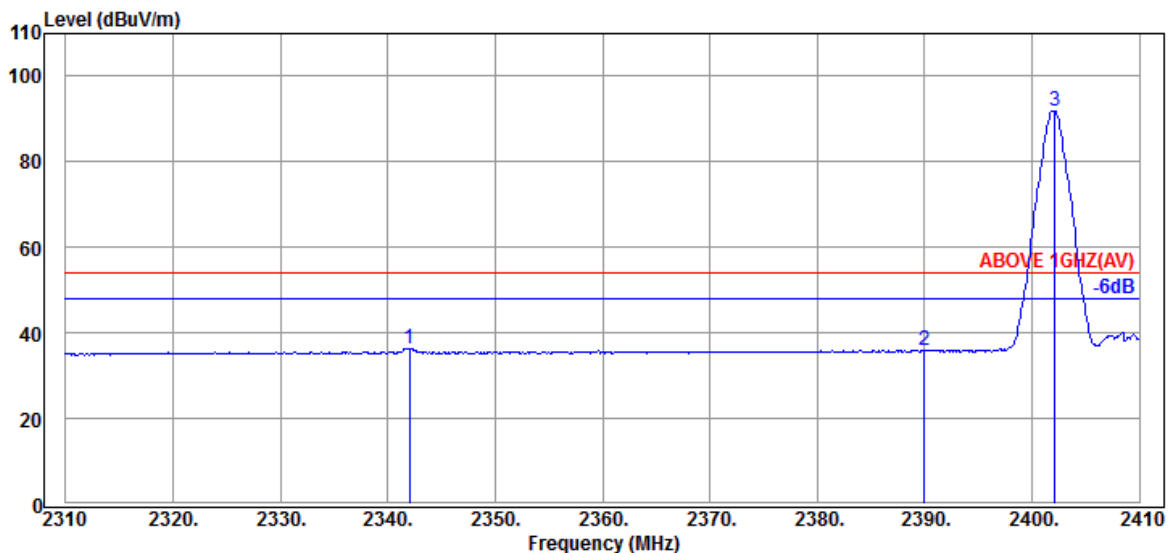

Antenna at Horizontal Polarization

Emission Frequency (MHz)	Antenna Factor (dB/m)	Cable Loss (dB)	Preamp Gain (dB)	Read Level (dBμV)	Emission Level (dBμV/m)	Limits (dBμV/m)	Margin (dB)	Detector
2342.000	32.17	7.92	34.57	30.88	36.40	54.00	17.60	Average
2390.000	32.44	7.95	34.58	29.98	35.79	54.00	18.21	Average
@ 2402.100	32.50	7.95	34.59	86.17	92.03	---	---	Average

Remark: The "@" means fundamental frequency, it is ignored in this section.

Mode	BLE (2M)	Frequency	TX 2402MHz
------	----------	-----------	------------

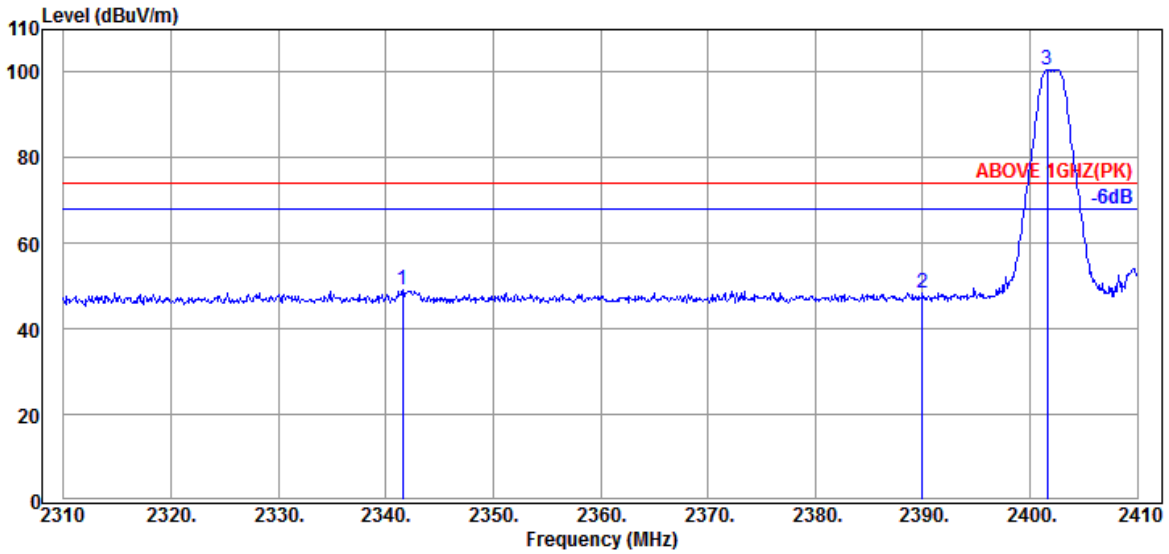

Antenna at Vertical Polarization

Emission Frequency (MHz)	Antenna Factor (dB/m)	Cable Loss (dB)	Preamplifier Gain (dB)	Read Level (dBμV)	Emission Level (dBμV/m)	Limits (dBμV/m)	Margin (dB)	Detector
2341.600	32.17	7.92	34.57	43.69	49.21	74.00	24.79	Peak
2390.000	32.44	7.95	34.58	42.51	48.32	74.00	25.68	Peak
@ 2401.600	32.50	7.95	34.59	94.73	100.59	---	---	Peak

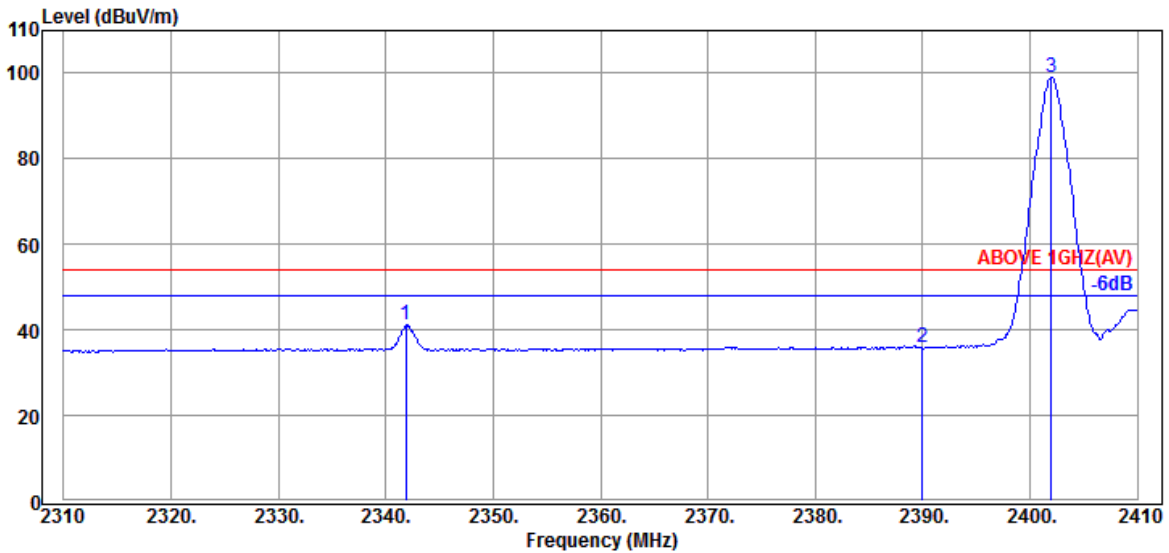

Antenna at Vertical Polarization

Emission Frequency (MHz)	Antenna Factor (dB/m)	Cable Loss (dB)	Preamplifier Gain (dB)	Read Level (dBμV)	Emission Level (dBμV/m)	Limits (dBμV/m)	Margin (dB)	Detector
2341.900	32.17	7.92	34.57	35.72	41.24	54.00	12.76	Average
2390.000	32.44	7.95	34.58	29.98	35.79	54.00	18.21	Average
@ 2402.000	32.50	7.95	34.59	93.20	99.06	---	---	Average

Remark: The “@” means fundamental frequency, it is ignored in this section.

Mode	BLE (2M)	Frequency	TX 2480MHz
------	----------	-----------	------------

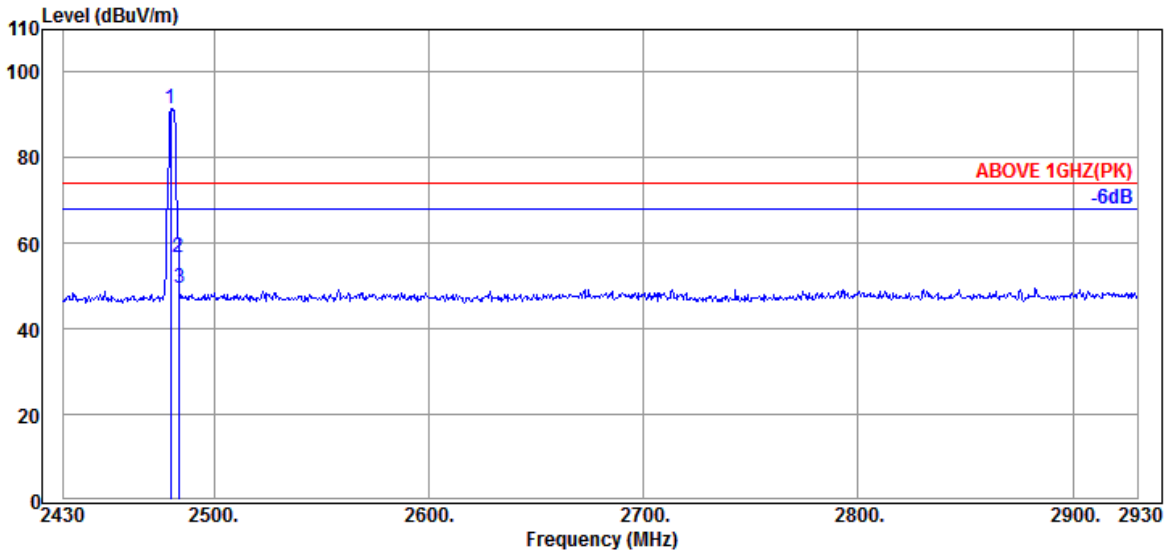

Antenna at Horizontal Polarization

Emission Frequency (MHz)	Antenna Factor (dB/m)	Cable Loss (dB)	Preamplifier Gain (dB)	Read Level (dBμV)	Emission Level (dBμV/m)	Limits (dBμV/m)	Margin (dB)	Detector
@ 2480.000	32.11	7.99	34.60	85.89	91.39	---	---	Peak
2483.500	32.14	7.99	34.61	51.35	56.87	74.00	17.13	Peak
2484.000	32.14	7.99	34.61	43.91	49.43	74.00	24.57	Peak

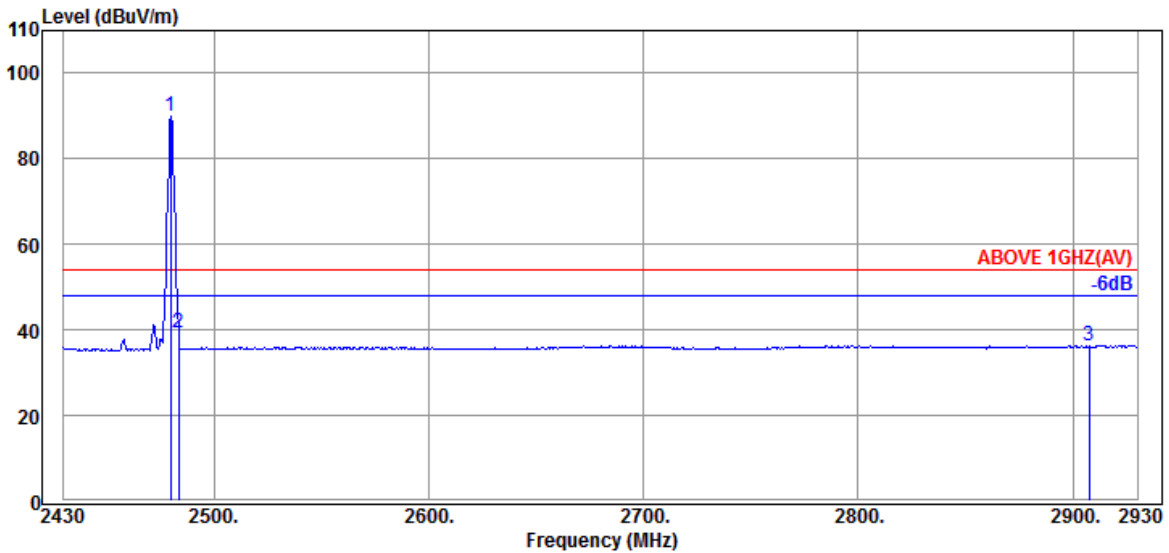

Antenna at Horizontal Polarization

Emission Frequency (MHz)	Antenna Factor (dB/m)	Cable Loss (dB)	Preamplifier Gain (dB)	Read Level (dBμV)	Emission Level (dBμV/m)	Limits (dBμV/m)	Margin (dB)	Detector
@ 2480.000	32.11	7.99	34.60	84.31	89.81	---	---	Average
2483.500	32.14	7.99	34.61	33.93	39.45	54.00	14.55	Average
2907.500	32.83	8.18	34.69	30.11	36.43	54.00	17.57	Average

Remark: The "@" means fundamental frequency, it is ignored in this section.

Mode	BLE (2M)	Frequency	TX 2480MHz
------	----------	-----------	------------

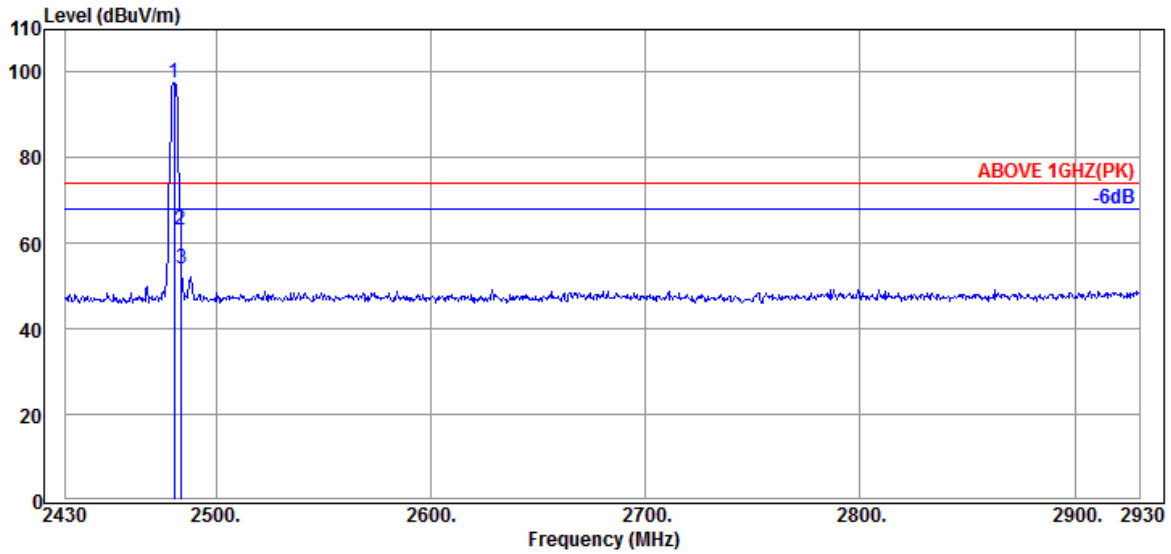

Antenna at Vertical Polarization

Emission Frequency (MHz)	Antenna Factor (dB/m)	Cable Loss (dB)	Preamplifier Gain (dB)	Read Level (dBμV)	Emission Level (dBμV/m)	Limits (dBμV/m)	Margin (dB)	Detector
@ 2480.500	32.11	7.99	34.60	91.91	97.41	---	---	Peak
2483.500	32.14	7.99	34.61	57.69	63.21	74.00	10.79	Peak
2484.000	32.14	7.99	34.61	48.57	54.09	74.00	19.91	Peak

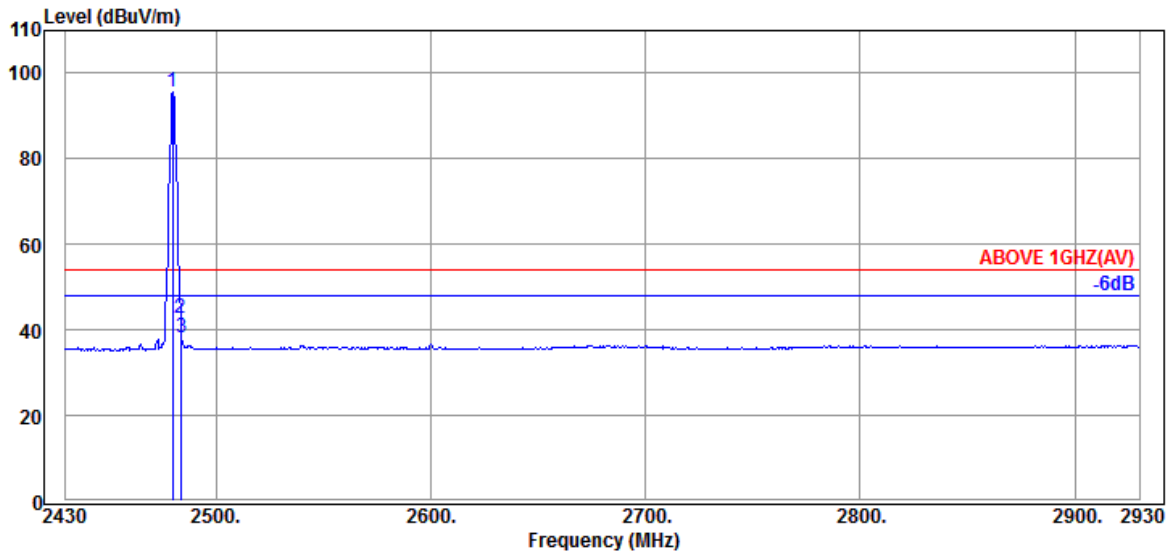

Antenna at Vertical Polarization

Emission Frequency (MHz)	Antenna Factor (dB/m)	Cable Loss (dB)	Preamplifier Gain (dB)	Read Level (dBμV)	Emission Level (dBμV/m)	Limits (dBμV/m)	Margin (dB)	Detector
@ 2480.000	32.11	7.99	34.60	90.18	95.68	---	---	Average
2483.500	32.14	7.99	34.61	37.02	42.54	54.00	11.46	Average
2484.000	32.14	7.99	34.61	32.62	38.14	54.00	15.86	Average

Remark: The “@” means fundamental frequency, it is ignored in this section..

A.2.2 Emissions outside the frequency band:

The emissions (up to 25GHz) not reported for there is no emission be found.

Mode	802.11b	Frequency	TX 2442MHz
------	---------	-----------	------------

Antenna at Horizontal Polarization

Emission Frequency (MHz)	Antenna Factor (dB/m)	Cable Loss (dB)	Preamp Gain (dB)	Read Level (dBμV)	Emission Level (dBμV/m)	Limits (dBμV/m)	Margin (dB)	Detector
4884.000	34.03	10.54	39.29	39.70	44.98	54.00	9.02	Peak

Antenna at Vertical Polarization

Emission Frequency (MHz)	Antenna Factor (dB/m)	Cable Loss (dB)	Preamp Gain (dB)	Read Level (dBμV)	Emission Level (dBμV/m)	Limits (dBμV/m)	Margin (dB)	Detector
4884.000	34.03	10.54	39.29	44.56	49.84	54.00	4.16	Peak

Mode	802.11g	Frequency	TX 2442MHz
------	---------	-----------	------------

Antenna at Horizontal Polarization

Emission Frequency (MHz)	Antenna Factor (dB/m)	Cable Loss (dB)	Preamp Gain (dB)	Read Level (dBμV)	Emission Level (dBμV/m)	Limits (dBμV/m)	Margin (dB)	Detector
4884.000	34.03	10.54	39.29	38.02	43.30	54.00	10.70	Peak

Antenna at Vertical Polarization

Emission Frequency (MHz)	Antenna Factor (dB/m)	Cable Loss (dB)	Preamp Gain (dB)	Read Level (dBμV)	Emission Level (dBμV/m)	Limits (dBμV/m)	Margin (dB)	Detector
4884.000	34.03	10.54	39.29	40.39	45.67	54.00	8.33	Peak

Mode	802.11n-HT20	Frequency	TX 2442MHz
------	--------------	-----------	------------

Antenna at Horizontal Polarization

Emission Frequency (MHz)	Antenna Factor (dB/m)	Cable Loss (dB)	Preamp Gain (dB)	Read Level (dBμV)	Emission Level (dBμV/m)	Limits (dBμV/m)	Margin (dB)	Detector
4884.000	34.03	10.54	39.29	37.23	42.51	54.00	11.49	Peak

Antenna at Vertical Polarization

Emission Frequency (MHz)	Antenna Factor (dB/m)	Cable Loss (dB)	Preamp Gain (dB)	Read Level (dBμV)	Emission Level (dBμV/m)	Limits (dBμV/m)	Margin (dB)	Detector
4884.000	34.03	10.54	39.29	43.01	48.29	54.00	5.71	Peak

Mode	802.11n-HT40	Frequency	TX 2447MHz
------	--------------	-----------	------------

Antenna at Horizontal Polarization

Emission Frequency (MHz)	Antenna Factor (dB/m)	Cable Loss (dB)	Preamplifier Gain (dB)	Read Level (dBμV)	Emission Level (dBμV/m)	Limits (dBμV/m)	Margin (dB)	Detector
4894.000	34.03	10.54	39.28	36.26	41.55	54.00	12.45	Peak

Antenna at Vertical Polarization

Emission Frequency (MHz)	Antenna Factor (dB/m)	Cable Loss (dB)	Preamplifier Gain (dB)	Read Level (dBμV)	Emission Level (dBμV/m)	Limits (dBμV/m)	Margin (dB)	Detector
4894.000	34.03	10.54	39.28	40.18	45.47	54.00	8.53	Peak

Mode	802.11ax-HE20	Frequency	TX 2442MHz
------	---------------	-----------	------------

Antenna at Horizontal Polarization

Emission Frequency (MHz)	Antenna Factor (dB/m)	Cable Loss (dB)	Preamplifier Gain (dB)	Read Level (dBμV)	Emission Level (dBμV/m)	Limits (dBμV/m)	Margin (dB)	Detector
4884.000	34.03	10.54	39.29	38.25	43.53	54.00	10.47	Peak

Antenna at Vertical Polarization

Emission Frequency (MHz)	Antenna Factor (dB/m)	Cable Loss (dB)	Preamplifier Gain (dB)	Read Level (dBμV)	Emission Level (dBμV/m)	Limits (dBμV/m)	Margin (dB)	Detector
4884.000	34.03	10.54	39.29	42.59	47.87	54.00	6.13	Peak

Mode	802.11ax-HE40	Frequency	TX 2442MHz
------	---------------	-----------	------------

Antenna at Horizontal Polarization

Emission Frequency (MHz)	Antenna Factor (dB/m)	Cable Loss (dB)	Preamplifier Gain (dB)	Read Level (dBμV)	Emission Level (dBμV/m)	Limits (dBμV/m)	Margin (dB)	Detector
4884.000	34.03	10.54	39.29	36.66	41.94	54.00	12.06	Peak

Antenna at Vertical Polarization

Emission Frequency (MHz)	Antenna Factor (dB/m)	Cable Loss (dB)	Preamplifier Gain (dB)	Read Level (dBμV)	Emission Level (dBμV/m)	Limits (dBμV/m)	Margin (dB)	Detector
4884.000	34.03	10.54	39.29	37.67	42.95	54.00	11.05	Peak

Mode	BLE (PHY Coded S2)	Frequency	TX 2402MHz
------	--------------------	-----------	------------

Antenna at Horizontal Polarization

Emission Frequency (MHz)	Antenna Factor (dB/m)	Cable Loss (dB)	Preamplifier Gain (dB)	Read Level (dBμV)	Emission Level (dBμV/m)	Limits (dBμV/m)	Margin (dB)	Detector
4804.000	34.10	10.49	39.33	37.18	42.44	54.00	11.56	Peak

Antenna at Vertical Polarization

Emission Frequency (MHz)	Antenna Factor (dB/m)	Cable Loss (dB)	Preamplifier Gain (dB)	Read Level (dBμV)	Emission Level (dBμV/m)	Limits (dBμV/m)	Margin (dB)	Detector
4804.000	34.10	10.49	39.33	36.06	41.32	54.00	12.68	Peak

Mode	BLE (PHY Coded S2)	Frequency	TX 2440MHz
------	--------------------	-----------	------------

Antenna at Horizontal Polarization

Emission Frequency (MHz)	Antenna Factor (dB/m)	Cable Loss (dB)	Preamplifier Gain (dB)	Read Level (dBμV)	Emission Level (dBμV/m)	Limits (dBμV/m)	Margin (dB)	Detector
4880.000	34.05	10.54	39.29	36.13	41.43	54.00	12.57	Peak

Antenna at Vertical Polarization

Emission Frequency (MHz)	Antenna Factor (dB/m)	Cable Loss (dB)	Preamplifier Gain (dB)	Read Level (dBμV)	Emission Level (dBμV/m)	Limits (dBμV/m)	Margin (dB)	Detector
4880.000	34.05	10.54	39.29	37.10	42.40	54.00	11.60	Peak

Mode	BLE (PHY Coded S2)	Frequency	TX 2480MHz
------	--------------------	-----------	------------

Antenna at Horizontal Polarization

Emission Frequency (MHz)	Antenna Factor (dB/m)	Cable Loss (dB)	Preamplifier Gain (dB)	Read Level (dBμV)	Emission Level (dBμV/m)	Limits (dBμV/m)	Margin (dB)	Detector
4960.000	34.10	10.60	39.25	35.84	41.29	54.00	12.71	Peak

Antenna at Vertical Polarization

Emission Frequency (MHz)	Antenna Factor (dB/m)	Cable Loss (dB)	Preamplifier Gain (dB)	Read Level (dBμV)	Emission Level (dBμV/m)	Limits (dBμV/m)	Margin (dB)	Detector
4960.000	34.10	10.60	39.25	35.74	41.19	54.00	12.81	Peak

A.2.3 Emissions in Non-restricted Frequency Bands:

Pursuant to ANSI C63.10:2013 that emission levels below the FCC 15.209(a)/RSS-Gen Section 8.9 table 4 general radiated emissions limits is not required.



Audix Technology Corp.
No. 491, Zhongfu Rd., Linkou Dist.,
New Taipei City 244, Taiwan

Tel: +886 2 26099301
Fax: +886 2 26099303

APPDNDIX B

TEST PHOTOGRAPHS

(Model: 15Z90P)