

FCC 15.407 NII 5GHz Test Report

for

LG Electronics Inc.

**222, LG-ro, Jinwi-myeon Pyeongtaek-Si, Gyeonggi-Do,
17709 Republic of Korea**

Product Name : Notebook Computer
Model Name : (1)14Z95P (2)14ZB95P
(3)14ZD95P (4)14ZG95P
(5)14ZC95P
Brand : LG
FCC ID : BEJNT-14Z95P

Prepared by: : AUDIX Technology Corporation,
EMC Department



The test report is based on a single evaluation of one sample of the above-mentioned products. It does not imply an assessment of the whole production and does not permit the use of the test lab logo.

TABLE OF CONTENTS

Description	Page
TEST REPORT.....	4
1. REVISION RECORD OF TEST REPORT	5
2. SUMMARY OF TEST RESULTS	6
3. GENERAL INFORMATION	7
3.1. Description of Application	7
3.2. Description of EUT	8
3.3. Reference Test Guidance.....	9
3.4. Antenna Information	9
3.5. EUT Specifications Assessed in Current Report	10
3.6. Description of Key Components	12
3.7. Test Configuration.....	13
3.8. Output Power Setting	20
3.9. Tested Supporting System List.....	23
3.10. Setup Configuration.....	23
3.11. Operating Condition of EUT	23
3.12. Description of Test Facility	24
3.13. Measurement Uncertainty	25
4. MEASUREMENT EQUIPMENTLIST.....	26
4.1. Conducted Emission Measurement	26
4.2. Radiated Emission Measurement	26
4.3. RF Conducted Measurement	27
5. CONDUCTED EMISSION.....	28
5.1. Block Diagram of Test Setup	28
5.2. Conducted Emission Limit	28
5.3. Test Procedure	28
5.4. Test Results	28
6. RADIATED EMISSION	29
6.1. Block Diagram of Test Setup	29
6.2. Radiated Emission Limits.....	31
6.3. Test Procedure	33
6.4. Measurement Result Explanation.....	34
6.5. Test Results	34
7. 26dB/6dB BANDWIDTH	35
7.1. Block Diagram of Test Setup	35
7.2. Specification Limits.....	35
7.3. Test Procedure	35
7.4. Test Results	35
8. MAXIMUM OUTPUT POWER	36
8.1. Block Diagram of Test Setup	36
8.2. Specification Limits.....	36
8.3. Test Procedure	37
8.4. Test Results	37
9. POWER SPECTRAL DENSITY	38
9.1. Block Diagram of Test Setup	38



Audix Technology Corp.
No. 491, Zhongfu Rd., Linkou Dist.,
New Taipei City 244, Taiwan

Tel: +886 2 26099301
Fax: +886 2 26099303

9.2. Specification Limits.....	38
9.3. Test Procedure	38
9.4. Test Results	38
10. FREQUENCY STABILITY	39
10.1. Block Diagram of Test Setup	39
10.2. Specification Limits.....	39
10.3. Test Procedure	39
10.4. Test Results	39
11. DEVIATION TO TEST SPECIFICATIONS	40

APPENDIX A TEST DATA AND PLOTS
APPENDIX B TESTPHOTOGRAPHS

TEST REPORT

Applicant : LG Electronics Inc.
Manufacturer : LG Electronics Inc.
Factory #1 : LG Electronics Nanjing New Technology Co., Ltd.
Factory #2 : LG Electronics Do Brasil Ltda. (048130)
EUT Description
(1) Product : Notebook Computer
(2) Model : (1)14Z95P (2)14ZB95P (3)14ZD95P (4)14ZG95P (5)14ZC95P
(3) Brand : LG
(4) Power Supply: DC 20V, 3.25A

Applicable Standards:

Title 47 FCC CFR Part 15 Subpart E
ANSI C63.10:2013

Audix Technology Corp. tested the equipment mentioned in accordance with the requirements set forth in the above standards. Test results indicate that the equipment tested is capable of demonstrating compliance with the requirements as documented within this report.

Audix Technology Corp. does not assume responsibility for any conclusions and generalizations drawn from the test results with regard to other specimens and samples.

Date of Report: 2021. 10. 04

Reviewed by:



(Sabrina Wang/Administrator)

Approved by:

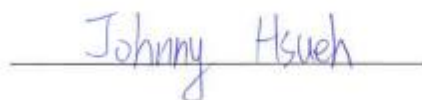

(Johnny Hsueh/Section Manager)

1. REVISION RECORD OF TEST REPORT

Edition No	Issued Date	Revision Summary	Report Number
0	2021. 10. 04	Original Report	EM-F210737

2. SUMMARY OF TEST RESULTS

Rule	Description	Data Reused	Results
15.207	Conducted Emission	No	PASS
15.205/15.209	Radiated Band Edge and Radiated Spurious Emission	No	PASS
15.407(a)(5)/15.407(e)	26dB/6dB Bandwidth	No	PASS
15.407(a)	Maximum Output Power	No	PASS
15.407(b)	Conducted Band Edges	No	N/A
15.407(a)	Power Spectral Density	No	PASS
15.407	Frequency Stability	No	PASS
15.203	Antenna Requirement	---	Compliance

Note: The uncertainties value is not used in determining the result.

3. GENERAL INFORMATION

3.1. Description of Application

Applicant	LG Electronics Inc. 222, LG-ro, Jinwi-myeon Pyeongtaek-Si, Gyeonggi-Do, 17709 Republic of Korea
Manufacturer	LG Electronics Inc. 222, LG-ro, Jinwi-myeon Pyeongtaek-Si, Gyeonggi-Do, 17709 Republic of Korea
Factory #1	LG Electronics Nanjing New Technology Co., Ltd. No.346, Yaixin Road, Economic & Technical Development Zone, Nanjing, China.
Factory #2	LG Electronics Do Brasil Ltda. (048130) Avenida Dom Pedro 1, W7777 12091-000 D.I.Piracangagua II, Taubate-SP BRAZIL
Product	Notebook Computer
Model	(1)14Z95P (2)14ZB95P (3)14ZD95P (4)14ZG95P (5)14ZC95P The difference between all models is different in the sales customers.
Brand	LG

3.2. Description of EUT

Test Model	14Z95P	
Serial Number	N/A	
Power Rating	DC 20V, 3.25A	
RF Features	WLAN: 802.11 a/b/g/n/ac/ax Bluetooth: BT and BLE (BT 5.0)	
Transmit Type	2.4 GHz	
	802.11b	1T1R
	802.11g	1T1R
	802.11n-HT20	2T2R
	802.11n-HT40	2T2R
	802.11ax-HE20	2T2R
	802.11ax-HE40	2T2R
	BT/BLE	1T1R
	U-NII Bands	
	802.11a	1T1R
	802.11n-HT20/802.11ac-VHT20/802.11ax-HE20	2T2R
	802.11n-HT40/802.11ac-VHT40/802.11ax-HE40	2T2R
	802.11ac-VHT80/802.11ax-HE80	2T2R
	802.11ac-VHT160/802.11ax-HE160	2T2R
	The MIMO is uncorrelated and supported SDM mode only.	
Device Category	<input type="checkbox"/> Outdoor Access Point <input type="checkbox"/> Fixed point-to-point Access Point <input type="checkbox"/> Indoor Access Point <input checked="" type="checkbox"/> Mobile and Portable client device	
Test Sample	Sample No.	Test Item
	01	AC Conduction, RSE, Output Power
	02	AC Conduction, Output Power
Sample Status	Mass production	
Date of Receipt	2021. 09. 26	
Date of Test	2021. 09. 09 ~ 10. 04	
Interface Ports of EUT	<ul style="list-style-type: none"> • One Micro SD Card Slot • One Earphone Port • Two USB 3.0 Ports • Two USB Type C Ports • One HDMI Port 	
Accessories Supplied	<ul style="list-style-type: none"> • AC Adapter • LAN Gender 	

3.3. Reference Test Guidance

KDB 789033 D02 General UNII Test Procedures New Rules v02r01

3.4. Antenna Information

No.	Antenna Part Number	Manufacture	Antenna Type	Frequency (MHz)	Max Gain(dBi)	
					Main	AUX
1.	WA-P-LELE-04-001	INPAQ	Mono-pole	2400	3.9	3.0
				2425	5.3	3.4
				2450	5.1	2.0
				2475	6.0	1.8
				2500	6.3	1.8
				5150	2.9	2.9
				5250	3.8	3.8
				5350	0.5	0.5
				5725	2.4	2.4
				5825	2.7	2.7
2	L1LRF005-CS-H	LUXSHARE-ICT	Mono-pole	2400	2.0	1.9
				2450	1.9	1.8
				2500	1.3	1.7
				5150	0.1	0.9
				5250	0.2	2.8
				5350	1.7	2.7
				5470	2.1	2.3
				5600	2.8	1.6
				5725	3.0	0.2
				5785	2.3	0.4
				5800	2.3	1.2
5850	1.5	2.3				

3.5. EUT Specifications Assessed in Current Report

Mode	U-NII Band	Fundamental Range (MHz)	Channel Number
802.11a	I	5180-5240	4
	2A	5260-5320	4
	2C	5500-5720	12
	III	5745-5825	5
802.11n-HT20/ 802.11ac-VHT20 802.11ax-HE20	I	5180-5240	4
	2A	5260-5320	4
	2C	5500-5720	12
	III	5745-5825	5
802.11n-HT40/ 802.11ac-VHT40 802.11ax-HE40	I	5190-5230	2
	2A	5270-5310	2
	2C	5510-5710	6
	III	5755-5795	2
802.11ac-VHT80 802.11ax-HE80	I	5210	1
	2A	5290	1
	2C	5530-5690	3
	III	5775	1
802.11ac-VHT160 802.11ax-HE160	I/2A	5250	1
	2C	5570	1

Remark: U-NII Band 2A and 2C (DFS Function, Slave/no In service monitor, no Ad-Hoc mode)

Mode	Modulation	Data Rate (Mbps)
802.11a	OFDM (BPSK/QPSK/16QAM/64QAM)	Up to 54
802.11n-HT20	OFDM (BPSK/QPSK/16QAM/64QAM)	Up to 144.4
802.11n-HT40		Up to 300
802.11ac-VHT20	OFDM (BPSK/QPSK/16QAM/64QAM/256QAM)	Up to 173.3
802.11ac-VHT40		Up to 400
802.11ac-VHT80		Up to 866.7
802.11ac-VHT160		Up to 1733.3
802.11ax-HE20	OFDMA (BPSK/ QPSK/ 16QAM/ 64QAM/ 256QAM/1024QAM)	Up to 287
802.11ax-HE40		Up to 574
802.11ax-HE80		Up to 1201
802.11ax-HE160		Up to 2402

Channel List						
802.11a/802.11n-HT20/802.11ac-VHT20/802.11ax-HE20						
U-NII Band	Channel Number	Frequency (MHz)	U-NII Band	Channel Number	Frequency (MHz)	
I	36	5180	2C	120	5600	
	40	5200		124	5620	
	44	5220		128	5640	
	48	5240		132	5660	
2A	52	5260		136	5680	
	56	5280		140	5700	
	60	5300		144	5720	
	64	5320		III	149	5745
2C	100	5500			153	5765
	104	5520			157	5785
	108	5540	161		5805	
	112	5560	165		5825	
	116	5580				

Channel List					
802.11n-HT40/802.11ac-VHT40/802.11ax-HE40					
U-NII Band	Channel Number	Frequency (MHz)	U-NII Band	Channel Number	Frequency (MHz)
I	38	5190	2C	118	5590
	46	5230		126	5630
2A	54	5270		134	5670
	62	5310		142	5710
2C	102	5510	III	151	5755
	110	5550		159	5795

Channel List					
802.11ac-VHT80/802.11ax-HE80					
U-NII Band	Channel Number	Frequency (MHz)	U-NII Band	Channel Number	Frequency (MHz)
I	42	5210	2C	138	5690
2A	58	5290	III	155	5775
2C	106	5530			
	122	5610			

Channel List					
802.11ac-VHT160/802.11ax-HE160					
U-NII Band	Channel Number	Frequency (MHz)	U-NII Band	Channel Number	Frequency (MHz)
I/2A	50	5250	2C	114	5570

Note: Test modes are presented at section 3.7.

3.6. Description of Key Components

3.6.1. For the All Component Lists

Item	Supplier	Model / Type	Character
System	Microsoft	Win10 Home	---
		Win10 Pro	---
		Win11 Home	---
Main Board	LG	Blanc MAIN B/D PCB	Manufacturer: #1 Hannstar Board Tech(Jiang Yin) Corp.,Ltd. #2 Elec & Eltek Company (MCO) Limited.
		1xZ90P MAIN B/D PCB	
WLAN SUB Board	LG	14Z90P SUB B/D	Manufacturer: #1 Hannstar Board Tech(Jiang Yin) Corp.,Ltd. #2 Elec & Eltek Company (MCO) Limited. #3 JiangSu HuaShen Electronic co.,ltd (HXF)
CPU (Socket: FCBGA1449)	Intel	i7-1195G7	2.9GHz
	Intel	i5-1155G7	2.5GHz
14" LCD Panel	LG Display	LP140WU1(SP)(A1)	Resolution: 1920*1200, 60Hz WUXGA IPS (Non Touch)
Storage (SSD)	SK hynix	HFM256GD3JX013N	256GB (M.2)
		HFM512GD3JX013N	512GB (M.2)
		HFM001TD3JX013N	1TB (M.2)
Memory (RAM)	Samsung	---	16GB LPDDR4x(On Board)
	Samsung	---	8GB LPDDR4x(On Board)
	SK Hynix	---	16GB LPDDR4x(On Board)
	SK Hynix	---	8GB LPDDR4x(On Board)
Battery Pack	LG	LBS1224E	72Wh, DC7.7V, 72Wh Typ 9450mAh
WLAN Combo Card	Intel	AX201D2W	WLAN and BT, 2x2 CNVi 1216 FCC ID: PD9AX201NG IC: 1000M-AX201NG NCC ID: CCAH18LP3410T5
WLAN Combo Antenna	LG (INPAQ)	WA-P-LELE-04-001	PCB, Mono-pole Type Main: Black, Aux: Gray
	LG (LUXSHARE-ICT)	L1LRF005-CS-H	PCB, Mono-pole Typ Main: Black, Aux: Gray
Keyboard	TIC	KT0120B9	---
	LITE ON	SN8002	---
Web Camera	Chicony	CKFKH33-0	---
	Luxvisions	0BF108N3	---
LAN Gender (Type C to LAN)	SUZHOU MEC ELECTRONICS	80-5946-111	(White) 10/100 Megabit Ethernet
		80-5946-101	(Black) 10/100 Megabit Ethernet
	Type C to LAN: Shielded, Undetached, 0.12m		
	ARIN TECH CO. LTD	GD-08MF-36-WH-LP10	(White) 10/100 Megabit Ethernet
		GD-08MF-36-BK-LP11	(Black) 10/100 Megabit Ethernet
	Type C to LAN: Shielded, Undetached, 0.12m		
	SUZHOU MEC ELECTRONICS	80-5946-200	(White) 10/100/1000 Megabit Ethernet
80-5946-210		(Black) 10/100/1000 Megabit Ethernet	
Type C to LAN: Shielded, Undetached, 0.13m			
AC Adapter (65W)	LG (HONOR)	ADT-65DSU-D03-2	I/P: AC 100-240V, 1.6A, 50-60Hz O/P: DC 20V, 3.25A
	DC Power Cord: Non-Shielded, Undetached, 1.5m		
	AC Power Cord: Non-Shielded, Detached, 1.0m (2C) (For Other Countries)		
	AC Power Cord: Non-Shielded, Detached, 1.55m (2C) (For US, Canada, Mexico)		

Remark: For more detailed features description, please refer to the manufacturer's specifications or the user manual.

3.6.2. The EUT collocates with following worst components, which are used to establish a basic configuration of system during test:

SKU		#1	#2	
Main Board	LG, Blanc MAIN B/D PCB	V	V	
SUB Board	LG, 14Z90P SUB B/D	V	V	
CPU	Intel, i7-1195G7	V		
	Intel, i5-1155G7		V	
14" LCD Panel	LG Display, LP140WU1(SP)(A1)	V	V	
Storage (SSD)	SK hynix, 1TB (M.2)	V	V	
Memory (RAM)	Samsung, 16GB	V	V	
Battery Pack	LG, LBS1224E	V	V	
WLAN Combo Card	Intel, AX201D2W	V	V	
WLAN Combo Antenna	LG (INPAQ), WA-P-LELE-04-001	V		
	LG (LUXSHARE-ICT), L1LRF005-CS-H		V	
Keyboard	TIC, KT0120B9	V	V	
Web Camera	Chicony, CKFKH33-0	V	V	
Type C *2	LAN Gender	MEC, 80-5946-111	V	V
	AC Adapter	LG (HONOR), ADT-65DSU-D03-2	V	V

3.7. Test Configuration

Mode	TX _{on} (ms)	1/ TX _{on} (kHz)	Duty Cycle (x)	Duty Cycle Factor [10log(1/x)] (dB)
802.11a	2.090	0.478	0.986	0
802.11n-HT20	3.980	0.251	0.993	0
802.11n-HT40	3.970	0.252	0.993	0
802.11ac-VHT80	3.960	0.253	0.990	0
802.11ac-VHT160	2.780	0.360	0.986	0
802.11ax-HE20	3.950	0.253	0.990	0
802.11ax-HE40	3.960	0.253	0.990	0
802.11ax-HE80	3.980	0.251	0.993	0
802.11ax-HE160	2.290	0.437	0.983	0

Note: When duty cycle is less than 98% (0.98) that duty cycle factor 10log(1/x) is needed to add in conducted test items measured in average detector.

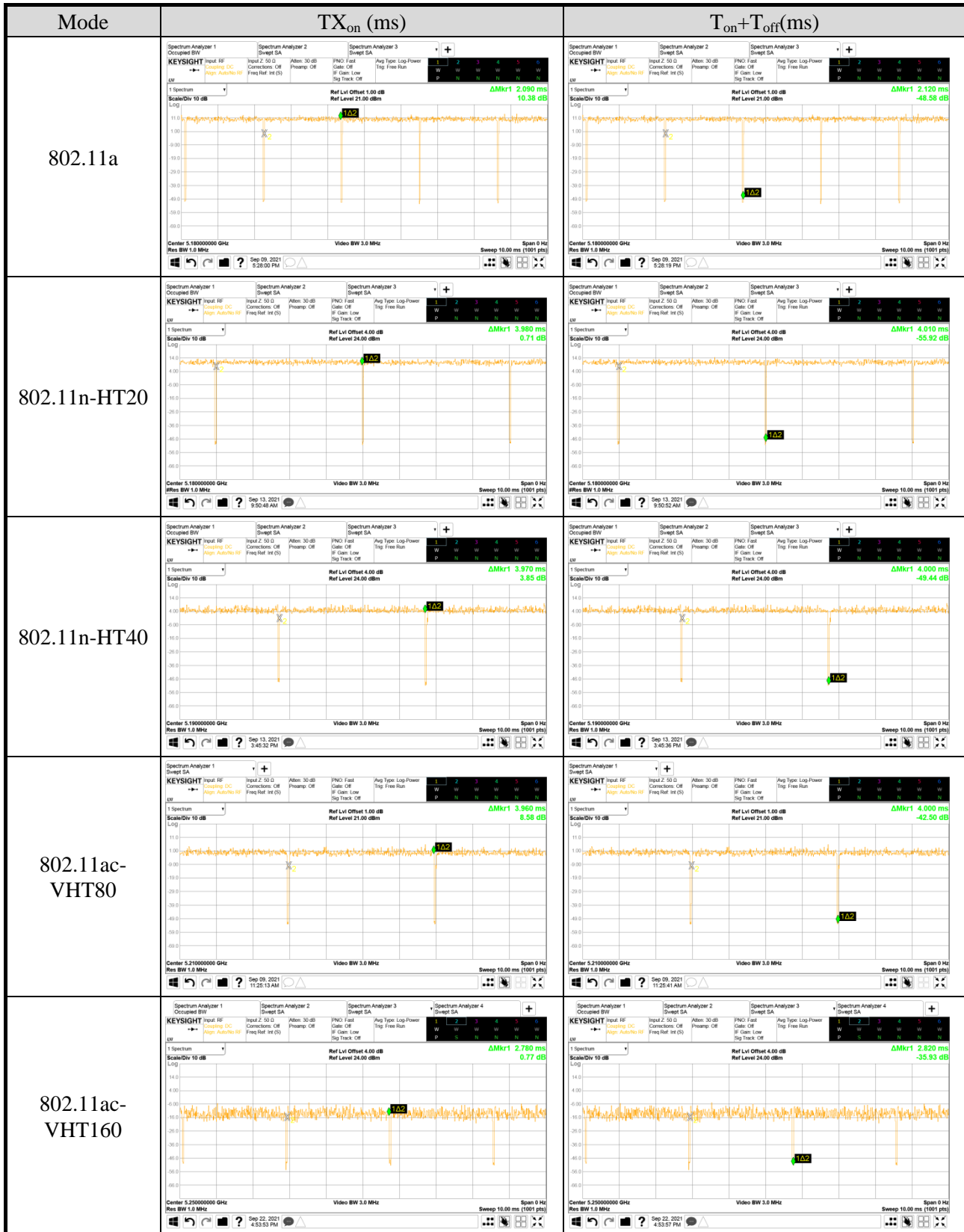

Mode	TX _{on} (ms)	T _{on} +T _{off} (ms)
802.11ax-HE20	<p>Center 5.18000000 GHz Res BW 1.0 MHz Video BW 3.0 MHz Sweep 10.00 ms (1001 pts)</p>	<p>Center 5.18000000 GHz Res BW 1.0 MHz Video BW 3.0 MHz Sweep 10.00 ms (1001 pts)</p>
802.11ax-HE40	<p>Center 5.19000000 GHz Res BW 1.0 MHz Video BW 3.0 MHz Sweep 10.00 ms (1001 pts)</p>	<p>Center 5.19000000 GHz Res BW 1.0 MHz Video BW 3.0 MHz Sweep 10.00 ms (1001 pts)</p>
802.11ax-HE80	<p>Center 5.21000000 GHz Res BW 1.0 MHz Video BW 3.0 MHz Sweep 10.00 ms (1001 pts)</p>	<p>Center 5.21000000 GHz Res BW 1.0 MHz Video BW 3.0 MHz Sweep 10.00 ms (1001 pts)</p>
802.11ax-HE160	<p>Center 5.25000000 GHz Res BW 1.0 MHz Video BW 3.0 MHz Sweep 10.00 ms (1001 pts)</p>	<p>Center 5.25000000 GHz Res BW 1.0 MHz Video BW 3.0 MHz Sweep 10.00 ms (1001 pts)</p>

AC Conduction	
SKU #1	Normal operation [SKU #1 (with INPAQ Antenna)]
SKU #2	Normal operation [SKU #2 (with LUXSHARE-ICT Antenna)]

Item		Mode	Data Rate	Test Channel	
Radiated Test Case	SKU#1	Radiated Band Edge <small>Note1 & 3</small>	802.11a	6 Mbps	36/64/100/140/144/149/165
			802.11n-HT20	MCS8	36/64/100/140/144/149/165
			802.11n-HT40	MCS8	38/62/102/134/142/151/159
			802.11ac-VHT80	MCS0	42/58/106/122/138/155
			802.11ac-VHT160	MCS0	50/114
			802.11ax-HE20	HE0	36/64/100/140/144/149/165
			802.11ax-HE40	HE0	38/62/102/134/142/151/159
			802.11ax-HE80	HE0	42/58/106/122/138/155
	802.11ax-HE160	HE0	50/114		
	Radiated Spurious Emission <small>Note1 & 2 & 3</small>	802.11a	6 Mbps	48/52/116/144/157	
		802.11n-HT20	MCS8	48/52/116/144/157	
		802.11n-HT40	MCS8	46/54/134/142/159	
		802.11ac-VHT80	MCS0	42/58/122/138/155	
		802.11ac-VHT160	MCS0	50/114	
		802.11ax-HE20	HE0	48/52/116/144/157	
		802.11ax-HE40	HE0	46/54/134/142/159	
802.11ax-HE80		HE0	42/58/122/138/155		
802.11ax-HE160	HE0	50/114			

Item		Mode	Data Rate	RU Configuration	Test Channel	
Radiated Test Case	SKU#1	Radiated Band Edge <small>Note1 & 3</small>	802.11ax-HE20	HE0	26/0	36/100/149
					52/37	
					106/53	
				HE0	26/8	64/140/165
					52/40	
					106/54	
			802.11ax-HE40	HE0	242/61	38/102/151
				HE0	242/62	62/134/159
			802.11ax-HE80	HE0	484/65	42/106/155
				HE0	484/66	58/122/155
			802.11ax-HE160	HE0	996/67	50/114
				HE0	996/S67	50/114
HE0	996/S67	50/114				

Item		Mode	Data Rate	Test Channel
Conducted Test Case	26dB/6dB Bandwidth	802.11a	6 Mbps	36/40/48/52/60/64/100/116/140/144/149/157/165
		802.11n-HT20	MCS8	36/40/48/52/60/64/100/116/140/144/149/157/165
		802.11n-HT40	MCS8	38/46/54/62/102/110/134/142/151/159
		802.11ac-VHT80	MCS0	42/58/106/122/138/155
		802.11ac-VHT160	MCS0	50/114
		802.11ax-HE20	HE0	36/40/48/52/60/64/100/116/140/144/149/157/165
		802.11ax-HE40	HE0	38/46/54/62/102/110/134/142/151/159
		802.11ax-HE80	HE0	42/58/106/122/138/155
	802.11ax-HE160	HE0	50/114	
	Maximum output power	802.11a	6 Mbps	36/40/48/52/60/64/100/116/140/144/149/157/165
		802.11n-HT20	MCS8	36/40/48/52/60/64/100/116/140/144/149/157/165
		802.11n-HT40	MCS8	38/46/54/62/102/110/134/142/151/159
		802.11ac-VHT80	MCS0	42/58/106/122/138/155
		802.11ac-VHT160	MCS0	50/114
		802.11ax-HE20	HE0	36/40/48/52/60/64/100/116/140/144/149/157/165
		802.11ax-HE40	HE0	38/46/54/62/102/110/134/142/151/159
		802.11ax-HE80	HE0	42/58/106/122/138/155
	802.11ax-HE160	HE0	50/114	
	Power spectral density	802.11a	6 Mbps	36/40/48/52/60/64/100/116/140/144/149/157/165
		802.11n-HT20	MCS8	36/40/48/52/60/64/100/116/140/144/149/157/165
		802.11n-HT40	MCS8	38/46/54/62/102/110/134/142/151/159
		802.11ac-VHT80	MCS0	42/58/106/122/138/155
		802.11ac-VHT160	MCS0	50/114
		802.11ax-HE20	HE0	36/40/48/52/60/64/100/116/140/144/149/157/165
		802.11ax-HE40	HE0	38/46/54/62/102/110/134/142/151/159
		802.11ax-HE80	HE0	42/58/106/122/138/155
	802.11ax-HE160	HE0	50/114	

Item		Mode	Data Rate	RU Configuration	Test Channel
Conducted Test Case	26dB/6dB Bandwidth	802.11ax-HE20	HE0	26/0	36/100/149
				52/37	
				106/53	
			HE0	26/8	64/140/165
				52/40	
				106/54	
		802.11ax-HE40	HE0	242/61	38/102/151
			HE0	242/62	62/134/159
		802.11ax-HE80	HE0	484/65	42/106/155
			HE0	484/66	58/122/155
		802.11ax-HE160	HE0	996/67	50/114
			HE0	996/S67	50/114
Conducted Test Case	Maximum output power	802.11ax-HE20	HE0	26/0	36/100/149
				52/37	
				106/53	
			HE0	26/8	64/140/165
				52/40	
				106/5	
		802.11ax-HE40	HE0	242/61	38/102/151
			HE0	242/62	62/134/159
		802.11ax-HE80	HE0	484/65	42/106/155
			HE0	484/66	58/122/155
		802.11ax-HE160	HE0	996/67	50/114
			HE0	996/S67	50/114

Item	Mode	Data Rate	RU Configuration	Test Channel
Conducted Test Case	802.11ax-HE20	HE0	26/0	36/100/149
			52/37	
			106/53	
		HE0	26/8	64/140/165
			52/40	
			106/54	
	802.11ax-HE40	HE0	242/61	38/102/151
		HE0	242/62	62/134/159
	802.11ax-HE80	HE0	484/65	42/106/155
		HE0	484/66	58/122/155
	802.11ax-HE160	HE0	996/67	50/114
		HE0	996/S67	50/114

Note 1: Mobile Device

Portable Device, and 3 axis were assessed. The worst scenario for Radiated Spurious Emission as follow: Lie Side Stand

Note 2: Low, mid, and high channels were measured, only the worst channel of each modulation was presented in this report.

Note 3: Both of the antennas are the same type, and we presented the worst case in the report. The max-gain condition with SISO (main port) and MIMO is SKU 1. The MIMO is uncorrelated and supported SDM mode only.

Note 4: The modulation and bandwidth are similar for 802.11n mode for HT20/HT40 and 802.11ac mode for VHT20/VHT40, therefore investigated worst case to representative mode in the test report.

Note 5: The data rates were selected based on preliminary testing that identified rate as the worst case for output power.

3.8. Output Power Setting

Mode	U-NII Band	Centre Frequency (MHz)	Power Setting	
			Chain 0 (AUX)	Chain 1 (Main)
802.11a	I	5180	18.875	18.875
		5200	19.625	19.625
		5240	19.750	19.750
	2A	5260	19.750	19.750
		5300	19.750	19.750
		5320	18.625	18.625
	2C	5500	19.250	19.250
		5580	20.375	20.375
		5700	19.125	19.125
		5720	21.000	21.000
	III	5745	21.000	21.000
		5785	21.000	21.000
5825		21.000	21.000	

Mode	U-NII Band	Centre Frequency (MHz)	Power Setting	Mode	U-NII Band	Centre Frequency (MHz)	Power Setting
802.11n- HT20	I	5180	16.250	802.11ax- HE20	I	5180	16.125
		5200	16.625			5200	16.625
		5240	16.625			5240	16.625
	2A	5260	16.625		2A	5260	16.750
		5300	16.625			5300	16.750
		5320	15.750			5320	15.875
	2C	5500	16.250		2C	5500	16.250
		5580	17.750			5580	17.875
		5700	15.500			5700	15.625
		5720	18.125			5720	18.125
	III	5745	18.125		III	5745	18.250
		5785	18.125			5785	18.250
5825		18.125	5825	18.250			

Mode	U-NII Band	Centre Frequency (MHz)	Power Setting	Mode	U-NII Band	Centre Frequency (MHz)	Power Setting
802.11n-HT40	I	5190	16.000	802.11ax-HE40	I	5190	15.875
		5230	16.500			5230	17.357
	2A	5270	16.500		2A	5270	16.875
		5310	15.250			5310	15.000
	2C	5510	15.500		2C	5510	15.125
		5550	15.875			5550	16.000
		5670	17.500			5670	17.000
		5710	18.375			5710	18.000
	III	5755	18.375		III	5755	18.000
		5795	18.375			5795	18.000

Mode	U-NII Band	Centre Frequency (MHz)	Power Setting	Mode	U-NII Band	Centre Frequency (MHz)	Power Setting
802.11ac-VT80	I	5210	17.250	802.11ax-HE80	I	5210	16.750
	2A	5290	16.625		2A	5290	15.875
	2C	5530	16.250		2C	5530	16.625
		5610	19.000			5610	18.875
		5690	19.500			5690	19.375
	III	5775	17.750		III	5775	17.875

Mode	U-NII Band	Centre Frequency (MHz)	Power Setting	Mode	U-NII Band	Centre Frequency (MHz)	Power Setting
802.11ac-VT160	I/2A	5250	13.000	802.11ax-HE160	I/2A	5250	12.500
	2C	5570	12.875		2C	5570	12.125

Mode	U-NII Band	Centre Frequency (MHz)	RU Configuration	Power Setting
802.11ax-HE20	I	5180	26/0	12.500
			52/37	15.000
			106/53	16.125
	2A	5320	26/8	12.500
			52/40	12.500
			106/54	16.125
	2C	5500	26/0	12.500
			52/37	15.250
			106/53	16.125
		5700	26/8	12.750
			52/40	13.625
			106/54	14.875
	III	5745	26/0	11.125
			52/37	15.625
			106/53	18.000
5825		26/8	15.000	
		52/40	17.000	
		106/54	17.625	
802.11ax-HE40	I	5190	242/61	16.125
	2A	5310	242/62	15.000
	2C	5510	242/61	15.125
		5670	242/62	17.250
	III	5755	242/61	18.000
		5795	242/62	17.625
802.11ax-HE80	I	5210	484/65	15.875
	2A	5290	484/66	12.375
	2C	5530	484/65	14.125
		5610	484/66	16.375
	III	5775	484/65	16.750
			484/66	16.750
802.11ax-HE160	I/2A	5250	996/67	11.750
			996/S67	11.750
	2C	5570	996/67	11.250
			996/S67	12.375

3.9. Tested Supporting System List

3.9.1. Support Peripheral Unit

No.	Product	Brand	Model No.	Serial No.	Approval
1.	LCD Monitor	DELL	U2718Qb	N/A	N/A
2.	USB Mouse	Beauty	A11	N/A	FCC By DoC
3.	Earphone	APPLE	N/A	N/A	N/A
4.	SD Card	ADATA	Micro SDHC Card	N/A	N/A
Partner System					
5.	AP Server	ASUS	RT-AX88U	N/A	FCC ID: MSQ-RTAXHP00 IC: 3568A-RTAXHP00

3.9.2. Cable Lists

No.	Cable Description Of The Above Support Units
1.	HDMI Cable: Shielded, Detachable, 1.8m AC Power Cord: Unshielded, Detachable, 1.8m
2.	USB Cable: Unshielded, Undetachable, 1.8m
3.	Earphone Cable: Unshielded, Undetachable, 0.9m
4.	N/A
5.	AC Power Cord: Unshielded, Detachable, 1.8m LAN cable: Unshielded, Detachable, 3.0m

3.10. Setup Configuration

3.10.1. EUT Configuration for Power Line & Radiated Emission

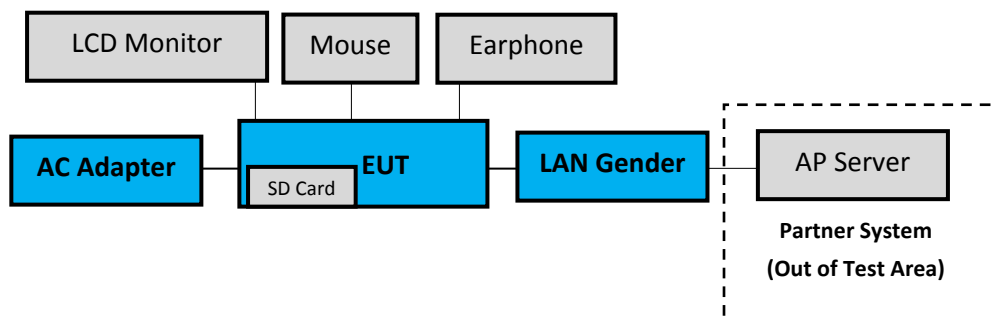

3.10.2. EUT Configuration for RF Conducted Test Items

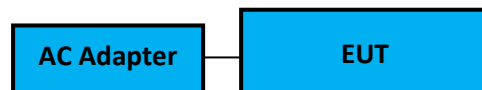

3.11. Operating Condition of EUT

Test program “DRTU” is used for enabling EUT WLAN function under continues transmitting and choosing data rate/ channel.

[Chain 0 is aux port (A Button in DRTU) Chain 1 is main port (B Button in DRTU)].

3.12. Description of Test Facility

Name of Test Firm	Audix Technology Corporation / EMC Department No. 491, Zhongfu Rd., Linkou Dist., New Taipei City 244, Taiwan Tel: +886-2-26092133 Fax: +886-2-26099303 Website : www.audixtech.com Contact e-mail: attemc_report@audixtech.com
Accreditations	The laboratory is accredited by following organizations under ISO/IEC 17025:2017 (1) NVLAP(USA) NVLAP Lab Code 200077-0 (2) TAF(Taiwan) No. 1724
Test Facilities	FCC OET Designation Number under APEC MRA by NCC is : TW1724 ISED CAB Identifier Number under APEC TEL MRA by NCC is TW1724 (1) No.8 Shielded Room (2) No.1 3m Semi Anechoic Chamber (3) Fully Anechoic Chamber

3.13.Measurement Uncertainty

Test Items/Facilities		Frequency Range	Uncertainty	
Conduction Test		9kHz-150kHz	±3.7dB	
		150kHz-30MHz	±3.4dB	
Radiation Test	<input checked="" type="checkbox"/>	No.1 3m Semi Anechoic Chamber	30MHz-200MHz, 3m, Horizontal	±3.8dB
			200MHz-1000MHz, 3m, Horizontal	±4.1dB
			30MHz-200MHz, 3m, Vertical	±4.5dB
			200MHz-1000MHz, 3m, Vertical	±4.5dB
			1GHz-6GHz, 3m	±4.7dB
			6GHz-18GHz, 3m	±4.1dB
	<input type="checkbox"/>	No.3 3m Semi Anechoic Chamber	30MHz-200MHz, 3m, Horizontal	±3.9dB
			200MHz-1000MHz, 3m, Horizontal	±4.2dB
			30MHz-200MHz, 3m, Vertical	±4.3dB
			200MHz-1000MHz, 3m, Vertical	±4.5dB
		No.4 3m Semi Anechoic Chamber	30MHz-200MHz, 3m, Horizontal	±4.1dB
			200MHz-1000MHz, 3m, Horizontal	±4.5dB
			30MHz-200MHz, 3m, Vertical	±4.4dB
			200MHz-1000MHz, 3m, Vertical	±4.8dB
	<input type="checkbox"/>	No.5 3m Semi Anechoic Chamber	1GHz-6GHz, 3m	±5.0dB
			6GHz-18GHz, 3m	±4.7dB
			30MHz-200MHz, 3m, Horizontal	±4.2dB
			200MHz-1000MHz, 3m, Horizontal	±4.3dB
			30MHz-200MHz, 3m, Vertical	±4.3dB
			200MHz-1000MHz, 3m, Vertical	±4.7dB
	<input checked="" type="checkbox"/>	Fully Anechoic Chamber	1GHz-6GHz, 3m	±4.8dB
			6GHz-18GHz, 3m	±4.5dB
			30MHz~1000MHz	±4.6dB
			1GHz~18GHz	±5.4dB
18GHz~40GHz			±3.52dB	
40GHz~260GHz			±3.56dB	

Remark : Uncertainty = $ku_c(y)$

Test Items	Uncertainty
Emission Bandwidth	± 0.2kHz
Maximum output power	± 0.33dB
Power spectral density	± 0.13dB

4. MEASUREMENT EQUIPMENT LIST

4.1. Conducted Emission Measurement

Item	Type	Manufacturer	Model No.	Serial No.	Cal. Date	Cal. Interval
1.	Test Receiver	R&S	ESR3	101774	2021.02.02	1 Year
2.	A.M.N.	R&S	ENV432	101567	2021.04.21	1 Year
3.	L.I.S.N.	Kyoritsu	KNW-407	8-855-9	2020.12.10	1 Year
4.	Pulse Limiter	R&S	ESH3-Z2	100354	2021.01.04	1 Year
5.	Digital Thermo-Hygro Meter	iMax	HTC-1	No.8 S/R	2021.04.15	1 Year
6.	Coaxial Cable	Yeida	RG/58AU	CE-08	2021.09.13	1 Year
7.	Test Software	Audix	e3	V6.120619c	N.C.R.	N.C.R.

4.2. Radiated Emission Measurement

Item	Type	Manufacturer	Model No.	Serial No.	Cal. Date	Cal. Interval
1.	Spectrum Analyzer	Agilent	N9030A-526	MY53310269	2021.01.14	1 Year
2.	Spectrum Analyzer	Agilent	N9010A-526	MY53400071	2021.09.09	1 Year
3.	Test Receiver	R&S	ESCS30	100039	2021.06.02	1 Year
4.	Amplifier	HP	8447D	2944A06305	2021.01.14	1 Year
5.	Microwave Preamplifier	Agilent	8449B	3008A02678	2021.02.19	1 Year
6.	Microwave Amplifier	Keysight	83051A	MY53010042	2021.07.30	1 Year
7.	Loop Antenna	R&S	HFH2-Z2	891847/27	2019.12.26	2 Years
8.	Bilog Antenna	TESEQ	CBL6112D	33821	2021.07.16	1 Year
9.	Double-Ridged Waveguide Horn	ETS-Lindgren	3117	00135902	2021.03.19	1 Year
10.	Horn Antenna	COM-POWER	AH-840	101092	2021.01.05	1 Year
11.	5G Notch Filter	Microwave Circuits	N0452502	459775	2021.05.05	1 Year
12.	5G Notch Filter	Microwave Circuits	N0555983	504921	2021.08.04	1 Year
13.	5G Notch Filter	Microwave Circuits	N0257881	459776	2021.08.16	1 Year
14.	Coaxial Cable	MIYAZAKI	5D2W	CLAMP-01	2021.09.13	1 Year
15.	Coaxial Cable	MIYAZAKI	5D2W	RE-11	2021.01.29	1 Year
16.	Coaxial Cable	HUBER+SUHNER	SUCOFLEX 104	RE-29	2021.09.13	1 Year
17.	Coaxial Cable	HUBER+SUHNER	SUCOFLEX 102	RE-30	2021.08.25	1 Year
18.	Digital Thermo-Hygro Meter	iMax	HTC-1	No.1 3m A/C	2021.04.15	1 Year
19.	Digital Thermo-Hygro Meter	EVERY DAY	E-512	RF-02	2021.04.15	1 Year
20.	Test Software	Audix	e3	V6.120619c	N.C.R.	N.C.R.
21.	Test Software	Audix	e3	V6.110601	N.C.R.	N.C.R.

4.3. RF Conducted Measurement

Item	Type	Manufacturer	Model No.	Serial No.	Cal. Date	Cal. Interval
1.	Spectrum Analyzer	Keysight	N9020B-544	MY57120357	2021.01.06	1 Year
2.	Power Meter	Anritsu	ML2495A	1145008	2021.06.30	1 Year
3.	Power Sensor	Anritsu	MA2411B	1126096	2021.06.30	1 Year
4.	Digital Thermo-Hygro Meter	iMax	HTC-1	RF-03	2021.04.15	1 Year

5. CONDUCTED EMISSION

5.1. Block Diagram of Test Setup

5.1.1. Block Diagram of EUT

Indicated as section 3.9

5.1.2. Shielded Room Setup Diagram

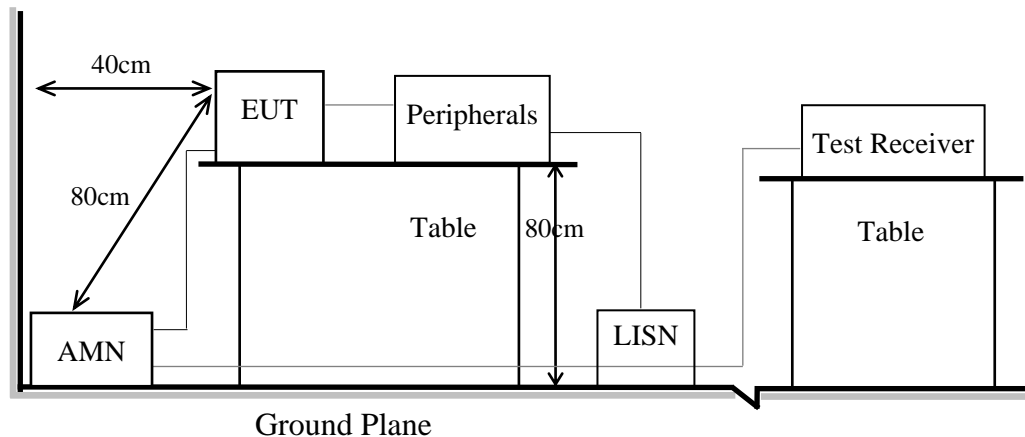

5.2. Conducted Emission Limit

Frequency	Conducted Limit	
	Quasi-Peak Level	Average Level
150kHz ~ 500kHz	66 ~ 56 dB μ V	56 ~ 46 dB μ V
500kHz ~ 5MHz	56 dB μ V	46 dB μ V
5MHz ~ 30MHz	60 dB μ V	50 dB μ V

Remark1.: If the average limit is met when using a Quasi-Peak detector, the measurement using the average detector is not required.

2.: The lower limit applies to the band edges.

5.3. Test Procedure

- 5.3.1. To set up the EUT as indicated in ANSI C63.10. The EUT was placed on the table which has 80 cm height to the ground and 40 cm distance to the conducting wall.
- 5.3.2. Power supplier of the EUT was connected to the AC mains through an Artificial Mains Network (A.M.N.).
- 5.3.3. The AC power supplies to all peripheral devices must be provided through line impedance stabilization network (L.I.S.N.)
- 5.3.4. Checking frequency range from 150kHz to 30 MHz and record the emission which does not have 20 dB below limit.

5.4. Test Results

Please refer to Appendix A.

6. RADIATED EMISSION

6.1. Block Diagram of Test Setup

6.1.1. Block Diagram of EUT

Indicated as section 3.9

6.1.2. Setup Diagram for 9kHz-30MHz

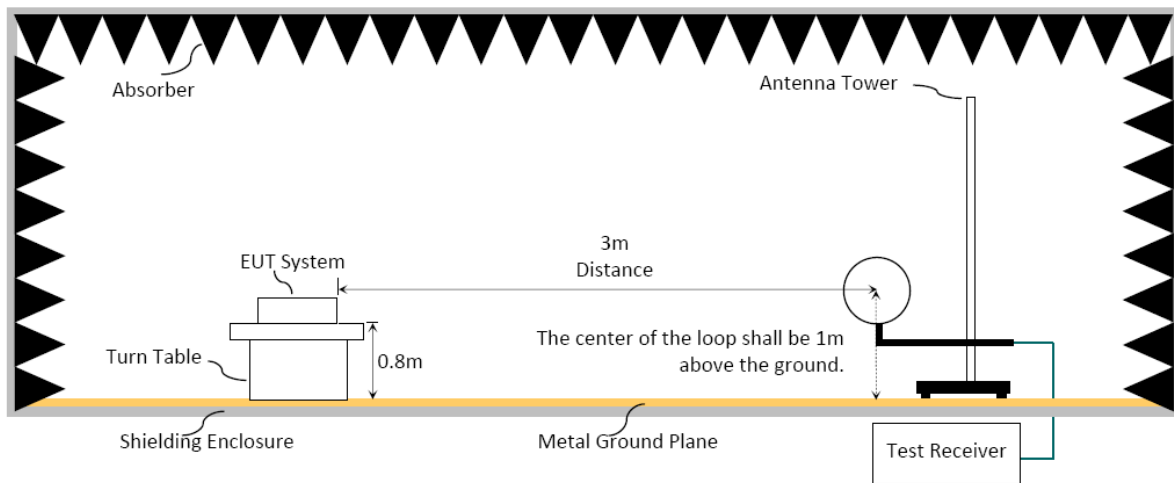

6.1.3. Setup Diagram for 30-1000MHz

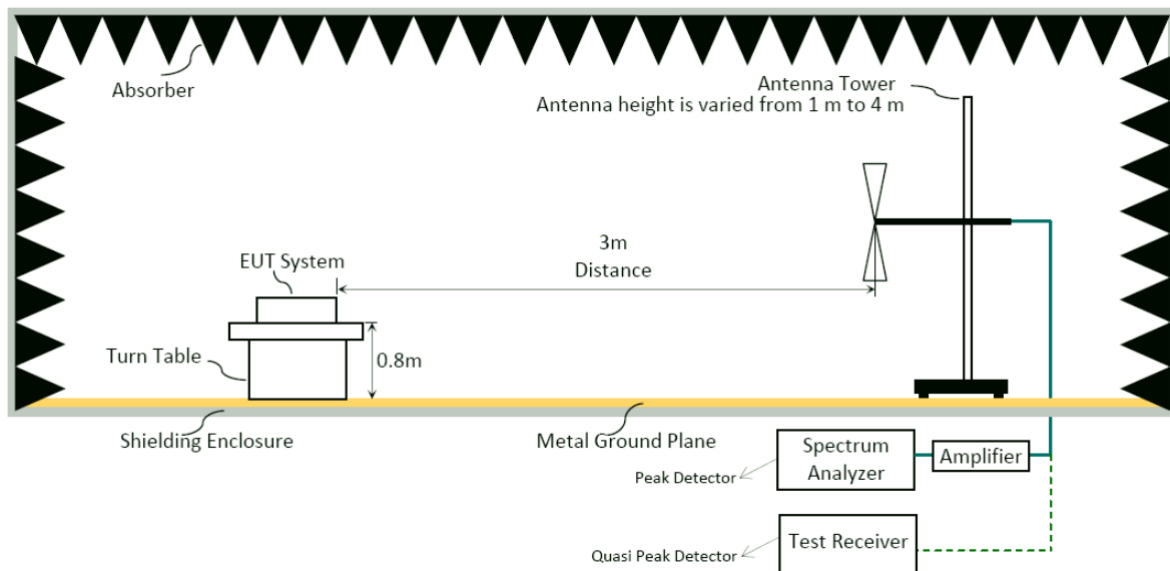

6.1.4. Setup Diagram for above 1GHz

Fully Anechoic Chamber

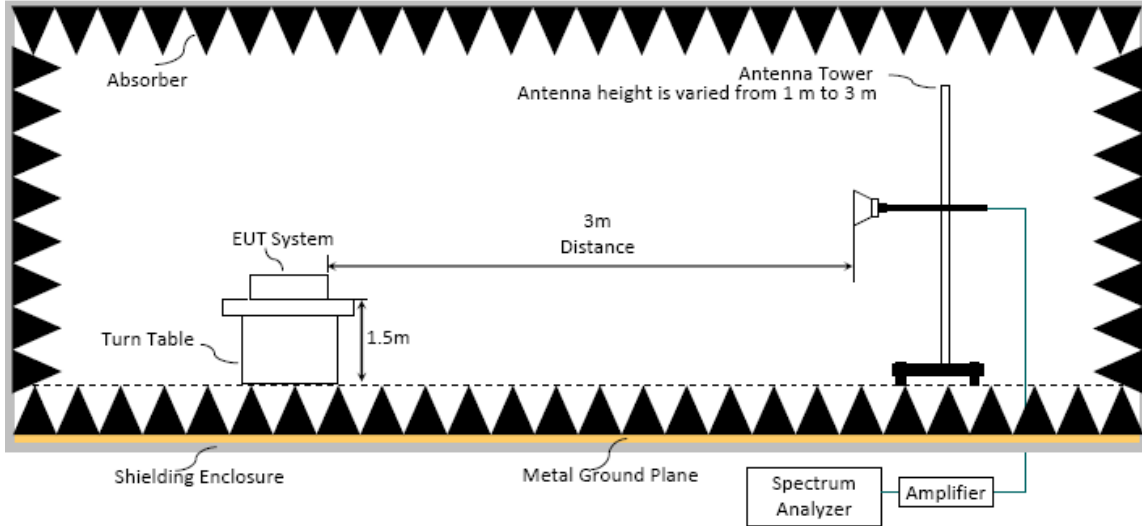

Semi Anechoic Chamber

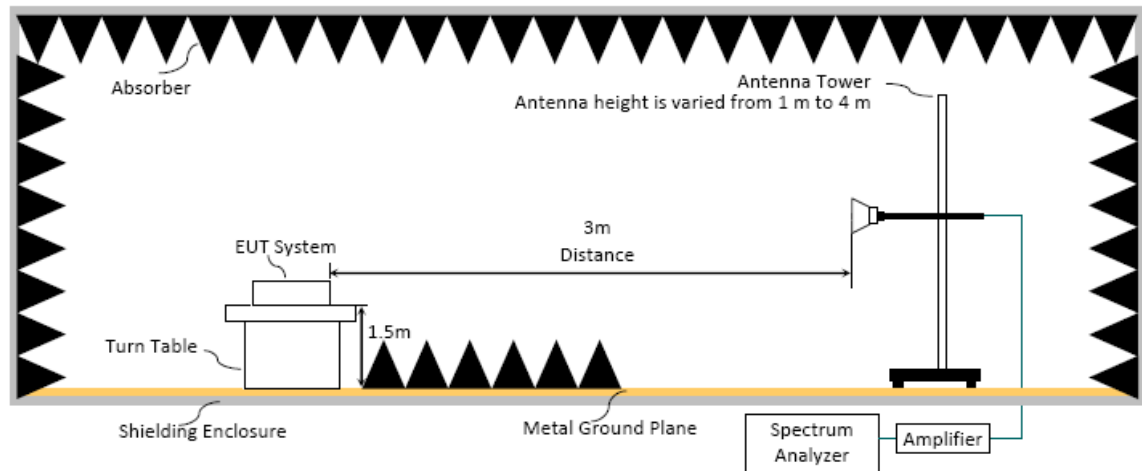

6.2. Radiated Emission Limits

Radiated emissions fall in restricted bands, as defined in Section 15.205 must be in compliance with the radiated emission limits specified in 15.209 as below.

6.2.1. General Limit

Frequency (MHz)	Distance(m)	Limits	
		dB μ V/m	μ V/m
0.009 - 0.490	300	67.6-20 log f(kHz)	2400/f kHz
0.490 - 1.705	30	87.6-20 log f(kHz)	24000/f kHz
1.705 - 30	30	29.5	30
30 - 88	3	40.0	100
88- 216	3	43.5	150
216- 960	3	46.0	200
Above 960	3	54.0	500
Above 1000	3	74.0 dB μ V/m (Peak) 54.0 dB μ V/m (Average)	

Remark : (1) dB μ V/m = 20 log (μ V/m)

- (2) The tighter limit applies to the edge between two frequency bands.
- (3) Distance refers to the distance in meters between the measuring instrument antenna and the closed point of any part of the device or system.
- (4) Fundamental and emission fall within operation band are exempted from this section.
- (5) Pursuant to ANSI C63.10: 6.6.4.3, if the maximized peak measured value complies with the average limit, then it is unnecessary to perform an average measurement.

6.2.2. Limit for non-restricted frequency above 1 GHz

Frequency Band (MHz)	E.I.R.P. Limit	Field Strength Limit at 3 m
5150 to 5250	-27 dBm	68.2
5250 to 5350		68.2
5470 to 5725		68.2

Note: Field Strength at 3 m = E.I.R.P. + 95.2 dB

Frequency Band (MHz)	Field Strength Limit at 3 m	
5725 to 5850	<input checked="" type="checkbox"/>	15.407(b)(4)(i) All emissions shall be limited to a level of 68.2 dB μ V/m at 75 MHz or more above or below the band edge increasing linearly to 105.2 dB μ V/m at 25 MHz above or below the band edge, and from 25 MHz above or below the band edge increasing linearly to a level of 110.8 dB μ V/m at 5 MHz above or below the band edge, and from 5 MHz above or below the band edge increasing linearly to a level of 68.2 dB μ V/m at the band edge.
	<input type="checkbox"/>	15.407(b)(4)(ii) , compliance with the emission limits in § 15.247(d) Shall be at least 30dB below that in the 100 kHz bandwidth within the band that contains the highest level of the desired power,. Attenuation below the general limits specified in §15.209(a) is not required. In addition, radiated emissions which fall in the restricted bands, as defined in §15.205(a), must also comply with the radiated emission limits specified in §15.209(a) (see §15.205(c))

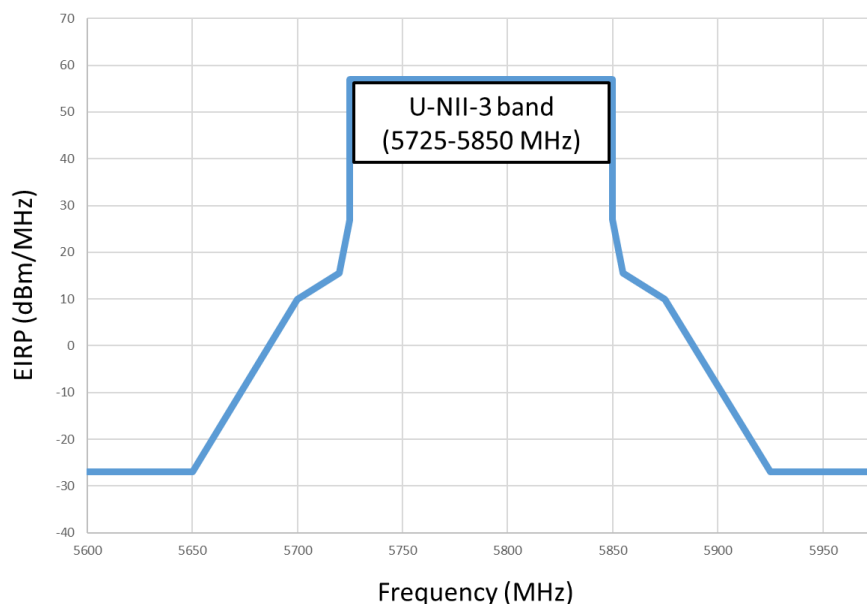

6.3. Test Procedure

Frequency Range 9kHz~30MHz:

The EUT setup on the turntable which has 0.8 m height to the ground. The turn table rotated 360 degrees and antenna fixed to 1 m to find the maximum emission level. In order to find the maximum emission, all of the interface cables were manipulated according to ANSI C63.10-2013 regulation.

- (1) RBW = 9kHz with peak and average detector.
- (2) Detector: average and peak (9kHz-490kHz)
Q.P. (490kHz-30MHz)

Frequency Range 30MHz ~ 40GHz:

The EUT setup on the turn table which has 80cm (for 30-1000MHz) and 1.5m (for above 1GHz) height to the ground. The turn table rotated 360 degrees and antenna varied from 1 m to 4 m (for 30-1000MHz) and from 1m to 3m (for above 1GHz at fully Anechoic Chamber) or from 1 m to 4 m (for above 1GHz at Semi Anechoic Chamber) to find the maximum emission level. Both horizontal and vertical polarization are required. In order to find the maximum emission, all of the interface cables were manipulated according to ANSI C63.10-2013 regulation.

Frequency below 1GHz:

Spectrum Analyzer is used for pre-testing with following setting:

- (1) RBW = 120kHz
- (2) VBW $\geq 3 \times$ RBW.
- (3) Detector = Peak.
- (4) Sweep time = auto.
- (5) Trace mode = max hold.
- (6) Allow sweeps to continue until the trace stabilizes.

Note 1: When peak-detected value is lower than limit that the measurement using the Q.P. detector is not required, otherwise using Q.P. for final measurement.

Note 2: When the radiated emissions limits are expressed in terms of the average value of the emissions, and pulsed operation is employed, the measurement field strength shall be determined by averaging over one complete pulse train, including blanking intervals, as long as the pulse train does not exceed 0.1 seconds.

Frequency above 1GHz to 10th harmonic (up to 40 GHz):

Peak Detector:

- (1) RBW = 1MHz
- (2) VBW $\geq 3 \times$ RBW.
- (3) Detector = Peak.
- (4) Sweep time = auto.
- (5) Trace mode = max hold.
- (6) Allow sweeps to continue until the trace stabilizes.

Note: When peak-detected value is lower than limit that the measurement using the average detector is not required, otherwise using average detector for final measurement.

Average Detector:

Option 1:

(1) RBW = 1MHz

(2) VBW \geq 1/ T.

Modulation Type	T (ms)	1/ T (kHz)	VBW Setting(kHz)
802.11a	2.090	0.478	10Hz
802.11n-HT20	3.980	0.251	10Hz
802.11n-HT40	3.970	0.252	10Hz
802.11ac-VHT80	3.960	0.253	10Hz
802.11ac-VHT160	2.780	0.360	10Hz
802.11ax-HE20	3.950	0.253	10Hz
802.11ax-HE40	3.960	0.253	10Hz
802.11ax-HE80	3.980	0.251	10Hz
802.11ax-HE160	2.290	0.437	10Hz

N/A: 1/ T is not implemented when duty cycle presented in section 3.6 is \geq 98%.

(1) Detector = Peak.

(2) Sweep time = auto.

(3) Trace mode = max hold.

(4) Allow sweeps to continue until the trace stabilizes.

Option 2:

Average Emission Level= Peak Emission Level+ D.C.C.F.

6.4. Measurement Result Explanation

Peak Emission Level=Antenna Factor + Cable Loss + Meter Reading (including Preamp factor if test used)

Average Emission Level=Antenna Factor + Cable Loss + Meter Reading (including Preamp factor if test used)

Average Emission Level= Peak Emission Level+ DCCF

Duty Cycle Correction Factor (DCCF)= $20\log(TX_{on}/TX_{on+off})$ presented in section 3.6.

ERP= Peak Emission Level-95.2dB-2.14dB

6.5. Test Results

Please refer to Appendix A.

7. 26dB/6dB BANDWIDTH

7.1. Block Diagram of Test Setup

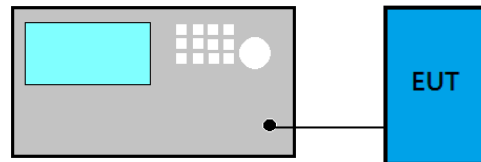

7.2. Specification Limits

Frequency Band (MHz)	Limit
5150 to 5250	Reference only
5250 to 5350	
5470 to 5725	
5725 to 5850	$\geq 500\text{kHz}$

7.3. Test Procedure

Following measurement procedure is reference to KDB 789033 D02 General UNII Test Procedures New Rules v02r01:

■ Applicable to all bands except to 5725 MHz- 5850 MHz

- (1) Set RBW= 1% of the emission bandwidth
- (2) Set VBW > RBW
- (3) Detector = Peak
- (4) Trace mode = max hold
- (5) Setting channel bandwidth function x dB to -26 dB to record the final bandwidth.

■ 5725 MHz- 5850 MHz

- (1) Set RBW = 100 kHz.
- (2) Set the video bandwidth (VBW) $\geq 3 \times$ RBW.
- (3) Detector = Peak.
- (4) Trace mode = max hold.
- (5) Sweep = auto couple.
- (6) Allow the trace to stabilize.
- (7) Setting channel bandwidth function x dB to -6 dB to record the final bandwidth.

7.4. Test Results

Please refer to Appendix A

8. MAXIMUM OUTPUT POWER

8.1. Block Diagram of Test Setup

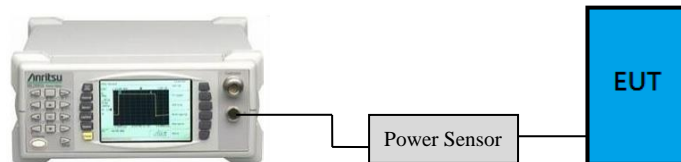

- For 802.11ac-VHT80/160, 802.11ax-HE160 modes only

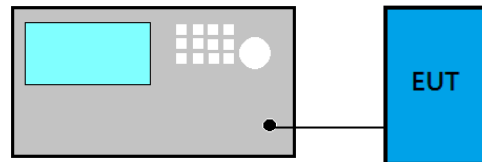

8.2. Specification Limits

Frequency Band (MHz)	Category	Limit
5150 to 5250	Outdoor Access Point	1 W(30 dBm)/ Max e.i.r.p. ≤125 mW(21 dBm) at any elevation angle above 30 degrees as measured from the horizon
	Fixed point-to-point Access Point	1 W(30 dBm)
	Indoor Access Point	1 W(30 dBm)
	Mobile and Portable client device	250 mW(24 dBm)
5250 to 5350	N/A	250 mW or 11 dBm + 10 log B ^{Note1}
5470 to 5725		250 mW or 11 dBm + 10 log B ^{Note1}
5725 to 5850		1 W(30 dBm)

Note 1: B is the 26 dB emission bandwidth, which presented in section 7 and appendix A.1.

8.3. Test Procedure

Following measurement procedure is reference to KDB 789033 D02 General UNII Test Procedures New Rules v02r01:

■ **Method AVGPM (Measurement using an RF average power meter):**

EUT is connected to power sensor and record the maximum average output power and duty cycle factor is added when duty cycle presented in section 3.7 is $< 98\%$.

■ **Method AVGSA-2 (Spectrum channel power) for 802.11ac-VHT80/160, 802.11ax-HE80/160 modes only**

- (1) Set span to at least 1.5 times the OBW
- (2) Set RBW = 1 MHz
- (3) Set the video bandwidth (VBW) ≥ 3 MHz.
- (4) Detector = RMS.
- (5) Trace mode = trace average at least 100 traces
- (6) Sweep = auto couple.
- (7) Compute power by integrating the spectrum across the OBW of the signal using the instrument's band power measurement function with band limits set equal to the OBW band edges.
- (8) Duty cycle factor is added when duty cycle presented in section 3.6 is $< 98\%$.

8.4. Test Results

Please refer to Appendix A

9. POWER SPECTRAL DENSITY

9.1. Block Diagram of Test Setup

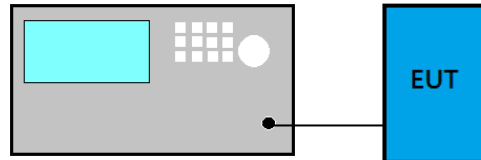

9.2. Specification Limits

Frequency Band (MHz)	Category	Limit
5150 to 5250	Outdoor Access Point	17dBm/MHz
	Fixed point-to-point Access Point	
	Indoor Access Point	
	Mobile and Portable client device	11 dBm/MHz
5250 to 5350	N/A	11 dBm/MHz
5470 to 5725		11 dBm/MHz
5725 to 5850		30dBm/500 kHz

9.3. Test Procedure

Following measurement procedure is reference to KDB 789033 D02 General UNII Test Procedures New Rules v02r01:

■ Method AVGSA-2 (Spectrum channel power)

- (1) Set span to at least 1.5 times the OBW
- (2) Set RBW = 1 MHz
- (3) Set the video bandwidth (VBW) \geq 3 MHz.
- (4) Detector = RMS.
- (5) Trace mode = trace average at least 100 traces
- (6) Sweep = auto couple.
- (7) Use peak search function to find out the maximum power density.
- (8) Duty cycle factor is added when duty cycle presented in section 3.6 is $<$ 98%.

9.4. Test Results

Please refer to Appendix A

10. FREQUENCY STABILITY

10.1. Block Diagram of Test Setup

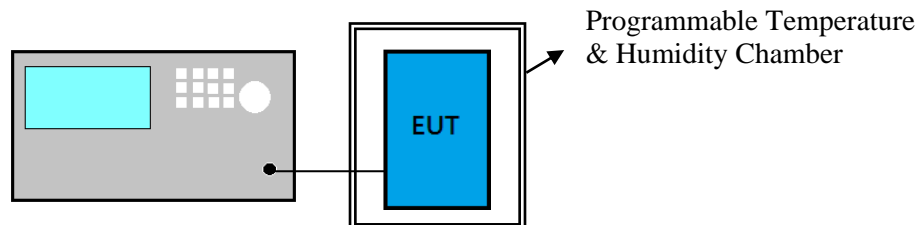

10.2. Specification Limits

NONE

10.3. Test Procedure

- (1) Frequency: Test frequency.
- (2) Span: enough to cover the complete power envelope
- (3) RBW: 1MHz(modulation ON) ; 10KHz(CW)
- (4) VBW: 1MHz(modulation ON) ; 10KHz(CW)
- (5) Detector Mode: Positive Peak
- (6) Indication mode: Max hold
- (7) Find the peak frequency and take calculate by the formula:
(Measurement Value-declaration frequency)/ declaration frequency)

10.4. Test Results

Please refer to Appendix A



11. DEVIATION TO TEST SPECIFICATIONS

【NONE】



Audix Technology Corp.
No. 53-11, Dingfu, Linkou, Dist.,
New Taipei City 244, Taiwan

Tel: +886 2 26099301
Fax: +886 2 26099303

APPDNDIX A

TEST DATA AND PLOTS

(Model: 14Z95P)



*Audix Technology Corp.
No. 53-11, Dingfu, Linkou, Dist.,
New Taipei City 244, Taiwan*

*Tel: +886 2 26099301
Fax: +886 2 26099303*

APPDNDIX B

TEST PHOTOGRAPHS

(Model: 14Z95P)