

## **FCC 15.247 & RSS-247 2.4GHz Test Report**

**for**

**LG Electronics Inc.**

**222, LG-ro, Jinwi-myeon Pyeongtaek-Si, Gyeonggi-Do,  
17709 Republic of Korea**

**Product Name : Notebook Computer**  
**Model Name : (1)14Z90RS (2)14ZD90RS**  
**Brand : LG**  
**FCC ID : BEJNT-14Z90RS**  
**IC : 2703H-14Z90RS**

**Prepared by: : AUDIX Technology Corporation,  
EMC Department**



The test report is based on a single evaluation of one sample of the above-mentioned products. It does not imply an assessment of the whole production and does not permit the use of the test lab logo.

## TABLE OF CONTENTS

Description	Page
TEST REPORT .....	4
<b>1. REVISION RECORD OF TEST REPORT .....</b>	<b>5</b>
<b>2. SUMMARY OF TEST RESULTS .....</b>	<b>6</b>
<b>3. GENERAL INFORMATION .....</b>	<b>7</b>
3.1. Description of Application .....	7
3.2. Description of EUT .....	8
3.3. Reference Test Guidance .....	9
3.4. Antenna Information .....	9
3.5. EUT Specifications Assessed in Current Report .....	10
3.6. Description of Key Components .....	11
3.7. Test Configuration .....	13
3.8. Output Power Setting .....	14
3.9. Tested Supporting System List .....	14
3.10. Setup Configuration .....	15
3.11. Operating Condition of EUT .....	15
3.12. Description of Test Facility .....	16
3.13. Measurement Uncertainty .....	17
<b>4. MEASUREMENT EQUIPMENT LIST .....</b>	<b>19</b>
4.1. Conducted Emission Measurement .....	19
4.2. Radiated Emission Measurement .....	20
4.3. RF Conducted Measurement .....	20
<b>5. CONDUCTED EMISSION .....</b>	<b>21</b>
5.1. Block Diagram of Test Setup .....	21
5.2. Conducted Emission Limit .....	21
5.3. Test Procedure .....	21
5.4. Test Results .....	21
<b>6. RADIATED EMISSION .....</b>	<b>22</b>
6.1. Block Diagram of Test Setup .....	22
6.2. Radiated Emission Limits .....	23
6.3. Test Procedure .....	24
6.4. Measurement Result Explanation .....	25
6.5. Test Results .....	25
<b>7. 20dB/OCCUPIED BANDWIDTH .....</b>	<b>26</b>
7.1. Block Diagram of Test Setup .....	26
7.2. Specification Limits .....	26
7.3. Test Procedure .....	26
7.4. Test Results .....	26
<b>8. CARRIER FREQUENCY SEPARATION .....</b>	<b>27</b>
8.1. Block Diagram of Test Setup .....	27
8.2. Specification Limits .....	27
8.3. Test Procedure .....	27
8.4. Test Results .....	27
<b>9. TIME OF OCCUPANCY .....</b>	<b>28</b>
9.1. Block Diagram of Test Setup .....	28



**Audix Technology Corp.**  
No. 491, Zhongfu Rd., Linkou Dist.,  
New Taipei City 244, Taiwan

**Tel: +886 2 26099301**  
**Fax: +886 2 26099303**

---

9.2. Specification Limits.....	28
9.3. Test Procedure.....	28
9.4. Test Results .....	28
<b>10. NUMBER OF HOPPING CHANNELS .....</b>	<b>29</b>
10.1. Block Diagram of Test Setup .....	29
10.2. Specification Limits.....	29
10.3. Test Procedure .....	29
10.4. Test Results .....	29
<b>11. MAXIMUM PEAK OUTPUT POWER .....</b>	<b>30</b>
11.1. Block Diagram of Test Setup .....	30
11.2. Specification Limits.....	30
11.3. Test Procedure .....	30
11.4. Test Results .....	30
<b>12. EMISSION LIMITATIONS .....</b>	<b>31</b>
12.1. Block Diagram of Test Setup .....	31
12.2. Specification Limits.....	31
12.3. Test Procedure .....	31
12.4. Test Results .....	31
<b>13. DEVIATION TO TEST SPECIFICATIONS .....</b>	<b>32</b>

APPENDIX A TEST DATA AND PLOTS  
APPENDIX B TEST PHOTOGRAPHS



**Audix Technology Corp.**  
No. 491, Zhongfu Rd., Linkou Dist.,  
New Taipei City 244, Taiwan

**Tel: +886 2 26099301**  
**Fax: +886 2 26099303**

## TEST REPORT

Applicant : LG Electronics Inc.  
Manufacturer : LG Electronics Inc.  
Factory : LG Electronics Nanjing New Technology Co., Ltd.  
EUT Description  
(1) Product : Notebook Computer  
(2) Model : (1)14Z90RS (2)14ZD90RS  
(3) Brand : LG  
(4) Power Supply: DC 20V, 3.25A

### Applicable Standards:

Title 47 CFR FCC Part 15 Subpart C  
RSS-Gen (Issue 5), Amendment 2, February 2021  
RSS-247 (Issue 2), February 2017

**Audix Technology Corp.** tested the equipment mentioned in accordance with the requirements set forth in the above standards. Test results indicate that the equipment tested is capable of demonstrating compliance with the requirements as documented within this report.

**Audix Technology Corp.** does not assume responsibility for any conclusions and generalizations drawn from the test results with regard to other specimens and samples.

Date of Report: 2022. 11. 18

Reviewed by:

Sunnice Huang

(Sunnice Huang/Administrator)

Approved by:

Johnny Hsueh

(Johnny Hsueh/Section Manager)



**Audix Technology Corp.**  
No. 491, Zhongfu Rd., Linkou Dist.,  
New Taipei City 244, Taiwan

**Tel: +886 2 26099301**  
**Fax: +886 2 26099303**

## 1. REVISION RECORD OF TEST REPORT

Edition No	Issued Date	Revision Summary	Report Number
0	2022. 11. 18	Original Report	EM-F220770

## 2. SUMMARY OF TEST RESULTS

Rule		Description	Results
FCC	IC		
15.207	RSS-Gen §8.8	Conducted Emission	<b>PASS</b>
15.247(d)/15.205	RSS-Gen §8.9 RSS-247 §5.5	Radiated Band Edge and Radiated Spurious Emission	<b>PASS</b>
15.247(a)(1)	RSS-247 §5.1(2)	20dB/Occupied Bandwidth	<b>PASS</b>
15.247(a)(1)	RSS-247 §5.1(2)	Carrier Frequency Separation	<b>PASS</b>
15.247(a)(1)(iii)	RSS-247 §5.1(4)	Time of Occupancy	<b>PASS</b>
15.247(a)(1)(iii)	RSS-247 §5.1(4)	Number of Hopping Channels	<b>PASS</b>
15.247(b)(1)	RSS-247 §5.1(2)	Maximum Peak Output Power	<b>PASS</b>
15.247(d)	RSS-247 §5.5	Conducted Band Edges and Conducted Spurious Emission	<b>PASS</b>
15.203	---	Antenna Requirement	<b>Compliance</b>

Note: The uncertainties value is not used in determining the result.

### 3. GENERAL INFORMATION

#### 3.1. Description of Application

Applicant	LG Electronics Inc. 222, LG-ro, Jinwi-myeon Pyeongtaek-Si, Gyeonggi-Do, 17709 Republic of Korea
Manufacturer	LG Electronics Inc. 222, LG-ro, Jinwi-myeon Pyeongtaek-Si, Gyeonggi-Do, 17709 Republic of Korea
Factory	LG Electronics Nanjing New Technology Co., Ltd. No.346, Yaoxin Road, Economic & Technical Development Zone, Nanjing, China.
Product	Notebook Computer
Model	(1)14Z90RS (2)14ZD90RS The difference between all models is different in the sales customers and color difference.
Brand	LG

### 3.2. Description of EUT

Test Model	14Z90RS		
Serial Number	N/A		
Power Rating	DC 20V, 3.25A		
Software Version	XY (X, Y can be 0 to 9 for different SW version not influence RF parameter)		
RF Features	WLAN:802.11 a/b/g/n/ac/ax Bluetooth: BT and BLE (BT 5.1)		
Transmit Type	<b>2.4 GHz</b>		
	802.11b		1T1R
	802.11g		1T1R
	802.11n-HT20		2T2R
	802.11n-HT40		2T2R
	802.11ax-HE20		2T2R
	802.11ax-HE40		2T2R
	BT/BLE		1T1R
	<b>U-NII Bands</b>		
	802.11a		1T1R
	802.11n-HT20/802.11ac-VHT20/802.11ax-HE20		2T2R
	802.11n-HT40/802.11ac-VHT40/802.11ax-HE40		2T2R
	802.11ac-VHT80/802.11ax-HE80		2T2R
	802.11ac-VHT160/802.11ax-HE160		2T2R
	The MIMO is uncorrelated and supported SDM mode only.		
Test Sample	<b>Sample No.</b>	<b>Test Item</b>	<b>Firmware</b>
	02	AC Conduction, RSE, RF Conducted	N/A
Sample Status	Trial sample		
Date of Receipt	2022. 10. 13		
Date of Test	2022. 10. 17 ~ 11. 10		
Interface Ports of EUT	<ul style="list-style-type: none"> <li>• Two USB Type C Ports</li> <li>• One Earphone Port</li> <li>• One Micro SD Card Slot</li> <li>• One USB 3.2 Port</li> </ul>		
Accessories Supplied	<ul style="list-style-type: none"> <li>• AC Adapter</li> <li>• USB C Cable</li> <li>• LAN Gender</li> </ul>		



### 3.3. Reference Test Guidance

ANSI C63.10:2013

### 3.4. Antenna Information

No.	Antenna Part Number	Manufacture	Antenna Type	Frequency (MHz)	Max Gain(dBi)	
					AUX	Main
1.	WA-P-LELE-04-033	INPAQ	Mono-Pole	2400	3.8	3.1
				2450	3.9	3.7
				2500	4.1	3.2
				5150	2.5	1.9
				5400	1.0	2.8
				5850	1.2	1.4
				5925	1.7	1.5
				6525	0.2	-0.4
				7125	2.9	3.8

According to KDB 662911 D01 d) ii), transmit signals are completely uncorrelated, then  
 Directional gain =  $10 \log[(10^{G1/10} + 10^{G2/10} + \dots + 10^{GN/10})/N_{ANT}]$  dBi  
 Note 1. 2.4G: Directional gain =  
 2400MHz: Directional gain =  $10 \log[(10^{3.8/10} + 10^{3.1/10})/2] = 3.46$  dBi  
 2450MHz: Directional gain =  $10 \log[(10^{3.9/10} + 10^{3.7/10})/2] = 3.80$  dBi  
 Note 2. 5G: Directional gain =  
 5150MHz: =  $10 \log[(10^{2.5/10} + 10^{1.9/10})/2] = 2.21$  dBi  
 5400MHz: =  $10 \log[(10^{1.0/10} + 10^{2.8/10})/2] = 1.99$  dBi  
 5850MHz: =  $10 \log[(10^{1.2/10} + 10^{1.4/10})/2] = 1.30$  dBi  
 Note 3. UNII Band (WLAN 6G):  
 5925MHz: Directional gain =  $10 \log[(10^{1.7/10} + 10^{1.5/10})/2] = 1.60$  dBi  
 6525MHz: Directional gain =  $10 \log[(10^{0.2/10} + 10^{-0.4/10})/2] = -0.09$  dBi  
 7125MHz: Directional gain =  $10 \log[(10^{2.9/10} + 10^{3.8/10})/2] = 3.37$  dBi  
 We chose the antenna gain corresponding to the frequency listed on the table which is closer to center frequency of WLAN.

### 3.5. EUT Specifications Assessed in Current Report

Mode	Fundamental Range (MHz)	Channel Number	Modulation	Data Rate (Mbps)
Bluetooth	2402-2480	79	FHSS (GFSK, $\pi/4$ DQPSK, 8-DPSK)	1/2/3

Channel List							
Channel Number	Frequency (MHz)	Channel Number	Frequency (MHz)	Channel Number	Frequency (MHz)	Channel Number	Frequency (MHz)
00	2402	20	2422	40	2442	60	2462
01	2403	21	2423	41	2443	61	2463
02	2404	22	2424	42	2444	62	2464
03	2405	23	2425	43	2445	63	2465
04	2406	24	2426	44	2446	64	2466
05	2407	25	2427	45	2447	65	2467
06	2408	26	2428	46	2448	66	2468
07	2409	27	2429	47	2449	67	2469
08	2410	28	2430	48	2450	68	2470
09	2411	29	2431	49	2451	69	2471
10	2412	30	2432	50	2452	70	2472
11	2413	31	2433	51	2453	71	2473
12	2414	32	2434	52	2454	72	2474
13	2415	33	2435	53	2455	73	2475
14	2416	34	2436	54	2456	74	2476
15	2417	35	2437	55	2457	75	2477
16	2418	36	2438	56	2458	76	2478
17	2419	37	2439	57	2459	77	2479
18	2420	38	2440	58	2460	78	2480
19	2421	39	2441	59	2461		

### 3.6. Description of Key Components

#### 3.6.1. For the All Component Lists

Item	Supplier	Model / Type	Character
System	Microsoft	Win 10	---
		Win 10 Pro	
		Win11 Home	
Main Board	LG	1XZ90RS MAIN B/D PCB	Manufacturer: #1 Hannstar Board Tech (Jiang Yin) Corp.,Ltd. #2 Elec&Eltek Company (MCO) Limited.
WLAN SUB Board	LG	14Z90RS SUB B/D	Manufacturer: #1 HannstarBoardTech(Jiang Yin)Corp.,Ltd. #2JiangSuHuaShen Electronic co.,ltd (HXF) #3 Elec&Eltek Company (MCO) Limited.
CPU (Socket: BGA1744)	Intel	i7-1360P	2.2GHz
	Intel	i5-1340P	1.9GHz
14" LCD Panel	Samsung	ATNA40YK10-0	Resolution: 2880 x 1800, 60/90Hz (WQXGA)
Storage (SSD)	SK hynix	---	256GB
		---	512GB
		---	1TB
		---	2TB
	Samsung	---	128GB
		---	256GB
		---	512GB
		---	1TB
---	---	2TB	
Memory (RAM)	Samsung	---	16GB LPDDR5x(On Board)
		---	8GB LPDDR5x(On Board)
		---	32GB LPDDR5x(On Board)
	SK Hynix	---	16GB LPDDR5x(On Board)
		---	8GB LPDDR5x(On Board)
		---	32GB LPDDR5x(On Board)
Battery Pack	LG	LBZ722DM	DC 7.76V, 72Wh
WLAN Combo Card	Intel	AX211D2W	WLAN and BT, 2x2 PCIe M.2 1216 SD adapter card FCC ID: PD9AX211D2 IC: 1000M-AX211D2
WLAN Combo Antenna	LG (INPAQ)	WA-P-LELE-04-033	PCB, Mono-pole Type Main: Black, Aux: Gray

Item	Supplier	Model / Type	Character
Keyboard	TIC	KT0120B7	---
	LITE ON	SN8B00	---
Touch Pad	Taifang	TF100AP02001	---
Web Camera	Chicony	CKFLF26(2Mic)	---
	Luxvisions	1BF225N3(2Mic)	---
LAN Gender (Type C to LAN)	SUZHOU MEC ELECTRONICS	80-5946-111	10/100 Megabit Ethernet
		80-5946-230	10/100/1000 Megabit Ethernet
	ARIN TECH CO. LTD	GD-08MF-36-WH-LP10	10/100 Megabit Ethernet
		GD-08MF-36-WH-LP12	10/100/1000 Megabit Ethernet
	HUIZHOU DEHONG TECHNOLOGY CO.,LTD.	370-50713	10/100 Megabit Ethernet
Type C to LAN: Shielded, Undetached, 0.12m			
AC Adapter	LG (PI ELECTRONICS)	LP65WFC20P-NJ W	I/P: AC 100-240V, 1.6A, 50-60Hz O/P:DC 5V,3A(15W) or DC 9V, 3A(27W)or DC 15V,3A (45W) or DC 20V,3.25A (65W) (US Type, Wall-mount)
			Type C Cable, Shielded, Undetached, 2.0m

Remark: For more detailed features description, please refer to the manufacturer's specifications or the user manual.

3.6.2. The EUT collocates with following worst components, which are used to establish a basic configuration of system during test:

SKU (Mode) 1		
Main Board	LG, 1XZ90RS MAIN B/D PCB	
SUB Board	LG, 14Z90RS SUB B/D	
CPU	Intel, i7-1360P	
14" LCD Panel	Samsung, ATNA40YK10-0	
Storage (SSD)	Samsung, 2TB	
	Samsung, 256GB	
Memory (RAM)	32GB	
Battery Pack	LG, 75Wh	
Keyboard	TIC, KT0120B7	
Touch Pad	Taifang, TF100AP02001	
Web Camera	Chicony, CKFLF26	
WLAN Combo Card	Intel, AX211D2W	
WLAN Combo Antenna	LG (INPAQ), WA-P-LELE-04-033	
Type C #1	AC Adapter	LG (PI ELECTRONICS), LP65WFC20P-NJ W
Type C #2	Link to LAN Gender	MEC   10/100/1000Mbps

### 3.7. Test Configuration

Mode	Duty Cycle (x)	T (ms)	Duty Cycle Correction Factor (dB)
BT	N/A	2.89	N/A

AC Conduction
Normal operation

Item	Mode	Data Rate	Test Channel
Radiated Test Case Radiated Spurious Emission (30MHz~1GHz)	GFSK	1Mbps	78

Item	Modulation	Data Rate	Test Channel	
Radiated Test Case Radiated Band Edge <sup>Note 1 &amp; 2</sup>	GFSK	1Mbps	00/78	
	8-DPSK	3Mbps	00/78	
Radiated Spurious Emission <sup>Note 1</sup>	GFSK	1Mbps	00/39/78	
Conducted Test Case 20dB/Occupied Bandwidth	GFSK	1Mbps	00/39/78	
	8-DPSK	3Mbps	00/39/78	
	Carrier Frequency Separation	GFSK	1Mbps	00/39/78
		8-DPSK	3Mbps	00/39/78
	Time of Occupancy	GFSK	1Mbps	00/39/78
		8-DPSK	3Mbps	00/39/78
	Number of Hopping Channels	GFSK	1Mbps	39
		8-DPSK	3Mbps	39
	Maximum Peak Output Power	GFSK	1Mbps	00/39/78
		8-DPSK	3Mbps	00/39/78
	Band Edges	GFSK	1Mbps	00/78
		8-DPSK	3Mbps	00/78
	Spurious Emission	GFSK	1Mbps	00/39/78
		8-DPSK	3Mbps	00/39/78

Note 1:  Mobile Device  Portable Device  
 and 3 axis were assessed. The worst scenario for Radiated Spurious Emission as follow:  
 Lie  Side  Stand

Note 2: We performed testing of the highest and lowest data rate.

### 3.8. Output Power Setting

Centre Frequency (MHz)	Power Setting	
	GFSK	8-DPSK
2402	12	7
2441	12	7
2480	12	7

### 3.9. Tested Supporting System List

#### 3.9.1. Support Peripheral Unit

No.	Product	Brand	Model No.	Serial No.	Approval
1.	USB Mouse	hp	MOFYUO	FCMHH0AKZB D7LC	N/A
2.	Earphone	APPLE	N/A	N/A	N/A
3.	SD Card	ADATA	MicroSDHC Card	N/A	N/A
<b>Partner System</b>					
4.	AP Server	ASUS	RT-AX88U	N/A	FCC ID: MSQ-RTAXHP00 IC: 3568A-RTAXHP00

#### 3.9.2. Cable Lists

No.	Cable Description Of The Above Support Units
1.	USB Cable: Unshielded, Undetachable, 0.7m
2.	Earphone Cable: Unshielded, Undetachable, 1.2m
3.	N/A
4.	AC adapter: M/N:WA-30B12, Cable: Unshielded, Detachable, 1.2m LAN cable: Unshielded, Detachable, 3.0m
5.	LAN cable: Unshielded, Detachable, 1.8m

### 3.10. Setup Configuration

#### 3.10.1. EUT Configuration for Power Line & Radiated Emission

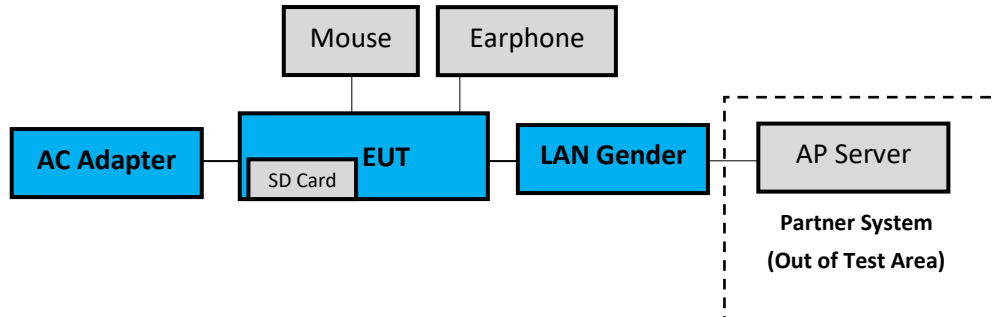

#### 3.10.2. EUT Configuration for RF Conducted Test Items

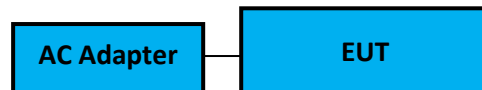

### 3.11. Operating Condition of EUT

Test program “DRTU” is used for enabling EUT BT function under continues transmitting and choosing data rate/ channel.  
[ANT AUX port (A Button in DRTU), ANT Main port (B Button in DRTU)].

### 3.12. Description of Test Facility

Name of Test Firm	Audix Technology Corporation / EMC Department No. 491, Zhongfu Rd., Linkou Dist., New Taipei City 244, Taiwan Tel: +886-2-26092133 Fax: +886-2-26099303 Website : www.audixtech.com Contact e-mail: attemc_report@audixtech.com
Accreditations	The laboratory is accredited by following organizations under ISO/IEC 17025:2017 (1) NVLAP(USA) NVLAP Lab Code 200077-0 (2) TAF(Taiwan) No. 1724
Test Facilities	FCC OET Designation Number under APEC MRA by NCC is : TW1724 ISED CAB Identifier Number under APEC TEL MRA by NCC is TW1724 (1) No.8 Shielded Room (2) No.1 3m Semi Anechoic Chamber



### 3.13. Measurement Uncertainty

Test Items/Facilities		Frequency Range	Uncertainty	
Conduction Test	<input type="checkbox"/>	No. 7 Shielded Room	9kHz-150kHz	±3.7dB
			150kHz-30MHz	±3.4dB
	<input checked="" type="checkbox"/>	No. 8 Shielded Room	9kHz-150kHz	±3.7dB
			150kHz-30MHz	±3.5dB
Radiation Test	<input checked="" type="checkbox"/>	No.1 3m Semi Anechoic Chamber	30MHz-200MHz, 3m, Horizontal	±3.8dB
			200MHz-1000MHz, 3m, Horizontal	±4.4dB
			30MHz-200MHz, 3m, Vertical	±4.5dB
			200MHz-1000MHz, 3m, Vertical	±4.7dB
			1GHz-6GHz, 3m	±4.9dB
			6GHz-18GHz, 3m	±4.5dB
	<input type="checkbox"/>	No.3 3m Semi Anechoic Chamber	30MHz-200MHz, 3m, Horizontal	±4.0dB
			200MHz-1000MHz, 3m, Horizontal	±4.3dB
			30MHz-200MHz, 3m, Vertical	±4.6dB
			200MHz-1000MHz, 3m, Vertical	±4.7dB
			1GHz-6GHz, 3m	±4.8dB
			6GHz-18GHz, 3m	±4.5dB
	<input type="checkbox"/>	No.4 3m Semi Anechoic Chamber	30MHz-200MHz, 3m, Horizontal	±4.3dB
			200MHz-1000MHz, 3m, Horizontal	±4.3dB
			30MHz-200MHz, 3m, Vertical	±4.6dB
			200MHz-1000MHz, 3m, Vertical	±4.7dB
			1GHz-6GHz, 3m	±4.8dB
			6GHz-18GHz, 3m	±4.4dB
	<input type="checkbox"/>	No.5 3m Semi Anechoic Chamber	30MHz-200MHz, 3m, Horizontal	±4.3dB
			200MHz-1000MHz, 3m, Horizontal	±4.3dB
			30MHz-200MHz, 3m, Vertical	±4.5dB
			200MHz-1000MHz, 3m, Vertical	±4.6dB
			1GHz-6GHz, 3m	±4.9dB
			6GHz-18GHz, 3m	±4.1dB
Radiated emissions (18GHz-40GHz)		18GHz-40GHz, 3m	±3.4dB	

Remark : Uncertainty =  $ku_c(y)$

---

---

Test Item	Uncertainty
20dB Bandwidth	$\pm 0.2\text{kHz}$
99% Occupied Bandwidth	$\pm 0.38\%$
Carrier Frequency Separation	$\pm 0.2\text{kHz}$
Time of Occupancy	$\pm 0.03\text{sec}$
Maximum peak Output power	$\pm 0.52\text{dB}$
Conducted Emission Limitations	$\pm 0.13\text{dB}$

## 4. MEASUREMENT EQUIPMENT LIST

### 4.1. Conducted Emission Measurement

Item	Type	Manufacturer	Model No.	Serial No.	Cal. Date	Cal. Interval
1.	Test Receiver	R&S	ESR3	101774	2022. 01. 11	1 Year
2.	A.M.N.	R&S	ENV432	101567	2022. 05. 26	1 Year
3.	L.I.S.N.	Kyoritsu	KNW-407	8-855-9	2021. 12. 19	1 Year
4.	Pulse Limiter	R&S	ESH3-Z2	100354	2021. 12. 23	1 Year
5.	Digital Thermo-Hygro Meter	iMax	HTC-1	No.8 S/R	2022. 04. 14	1 Year
6.	Coaxial Cable	Yeida	RG/58AU	CE-08	2022. 09. 07	1 Year
7.	Test Software	Audix	e3	V9 18621a	N.C.R.	N.C.R.

## 4.2. Radiated Emission Measurement

Item	Type	Manufacturer	Model No.	Serial No.	Cal. Date	Cal. Interval
1.	Spectrum Analyzer	Agilent	N9010A-526	MY53400071	2022. 08. 24	1 Year
2.	Spectrum Analyzer	Agilent	N9030A-526	MY53310269	2022. 02. 01	1 Year
3.	Spectrum Analyzer	Keysight	N9010B-544	MY55460198	2022. 04. 08	1 Year
4.	Test Receiver	R&S	ESCS30	100338	2022. 06. 15	1 Year
5.	Amplifier	HP	8447D	2944A06305	2022. 01. 05	1 Year
6.	Microwave Amplifier	Keysight	83051A	MY56480113	2022. 09. 07	1 Year
7.	Microwave Amplifier	Agilent	8449B	3008A02678	2022. 02. 22	1 Year
8.	Loop Antenna	TESEQ	HLA 6121	60478	2022. 02. 17	1 Year
9.	Bilog Antenna	TESEQ	CBL6112D	33821	2022. 07. 01	1 Year
10.	Double-Ridged Waveguide Horn	ETS-Lindgren	3117	00135902	2022. 03. 21	1 Year
11.	Horn Antenna	COM-POWER	AH-840	101092	2022. 01. 06	1 Year
12.	2.4GHz Notch Filter	K&L Microwave	7NSL10-2441 .5/E130.5-O/O	2	2022 .07. 23	1 Year
13.	3GHz Notch Filter	Microwave	H3G018G1	484796	2022 .07. 23	1 Year
14.	Coaxial Cable	MIYAZAKI	5D2W	RE-11	2022. 01. 20	1 Year
15.	Coaxial Cable	HUBER+SUHNER	SUCOFLEX 106	RE-14	2022. 01. 20	1 Year
16.	Coaxial Cable	HUBER+SUHNER	SUCOFLEX 102	RE-30	2022. 08. 22	1 Year
17.	Digital Thermo-Hygro Meter	iMax	HTC-1	No.1 3m A/C	2022. 04. 14	1 Year
18.	Test Software	Audix	e3	V9 18621a	N.C.R.	N.C.R.

## 4.3. RF Conducted Measurement

Item	Type	Manufacturer	Model No.	Serial No.	Cal. Date	Cal. Interval
1.	Spectrum Analyzer	Keysight	N9010B-544	MY55460198	2022. 04. 08	1 Year
2.	Digital Thermo-Hygro Meter	iMax	HTC-1	RF-03	2022. 04. 14	1 Year

## 5. CONDUCTED EMISSION

### 5.1. Block Diagram of Test Setup

#### 5.1.1. Block Diagram of EUT

Indicated as section 3.10

#### 5.1.2. Shielded Room Setup Diagram

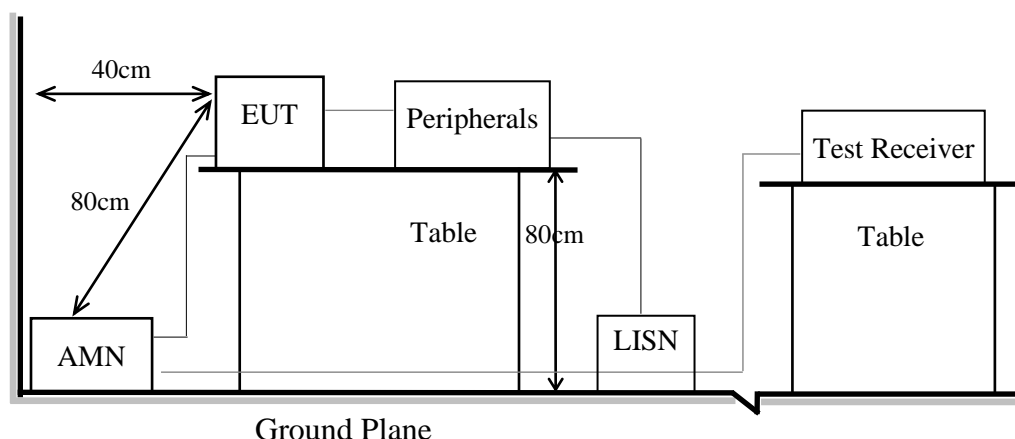

### 5.2. Conducted Emission Limit

Frequency	Conducted Limit	
	Quasi-Peak Level	Average Level
150kHz ~ 500kHz	66 ~ 56 dB $\mu$ V	56 ~ 46 dB $\mu$ V
500kHz ~ 5MHz	56 dB $\mu$ V	46 dB $\mu$ V
5MHz ~ 30MHz	60 dB $\mu$ V	50 dB $\mu$ V

Remark1.: If the average limit is met when using a Quasi-Peak detector, the measurement using the average detector is not required.

2.: The lower limit applies to the band edges.

### 5.3. Test Procedure

- 5.3.1. To set up the EUT as indicated in ANSI C63.10. The EUT was placed on the table which has 80 cm height to the ground and 40 cm distance to the conducting wall.
- 5.3.2. Power supplier of the EUT was connected to the AC mains through an Artificial Mains Network (A.M.N.).
- 5.3.3. The AC power supplies to all peripheral devices must be provided through line impedance stabilization network (L.I.S.N.)
- 5.3.4. Checking frequency range from 150kHz to 30 MHz and record the emission which does not have 20 dB below limit.

### 5.4. Test Results

Please refer to Appendix A.

## 6. RADIATED EMISSION

### 6.1. Block Diagram of Test Setup

#### 6.1.1. Block Diagram of EUT

Indicated as section 3.10

#### 6.1.2. Setup Diagram for 9kHz-30MHz

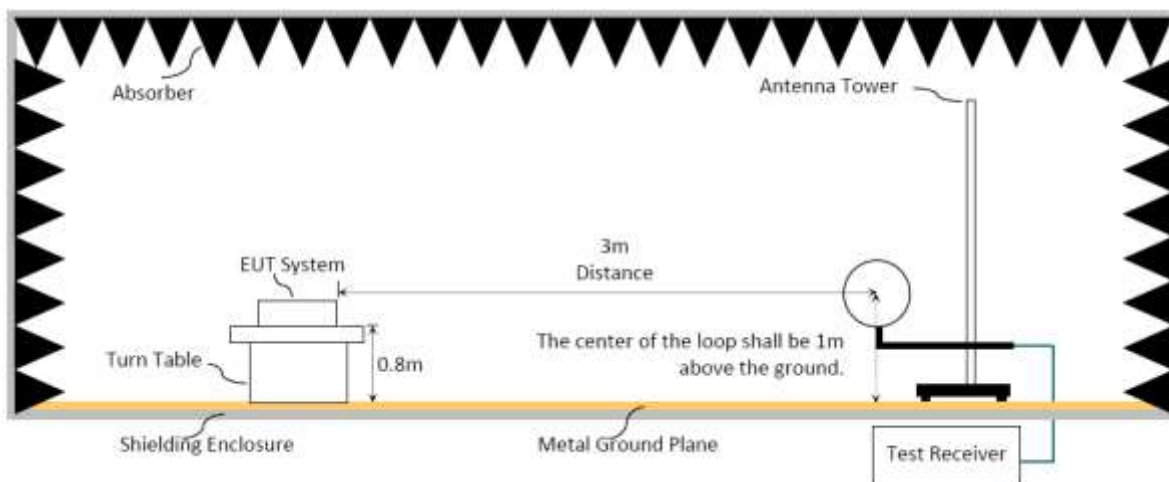

#### 6.1.3. Setup Diagram for 30-1000MHz

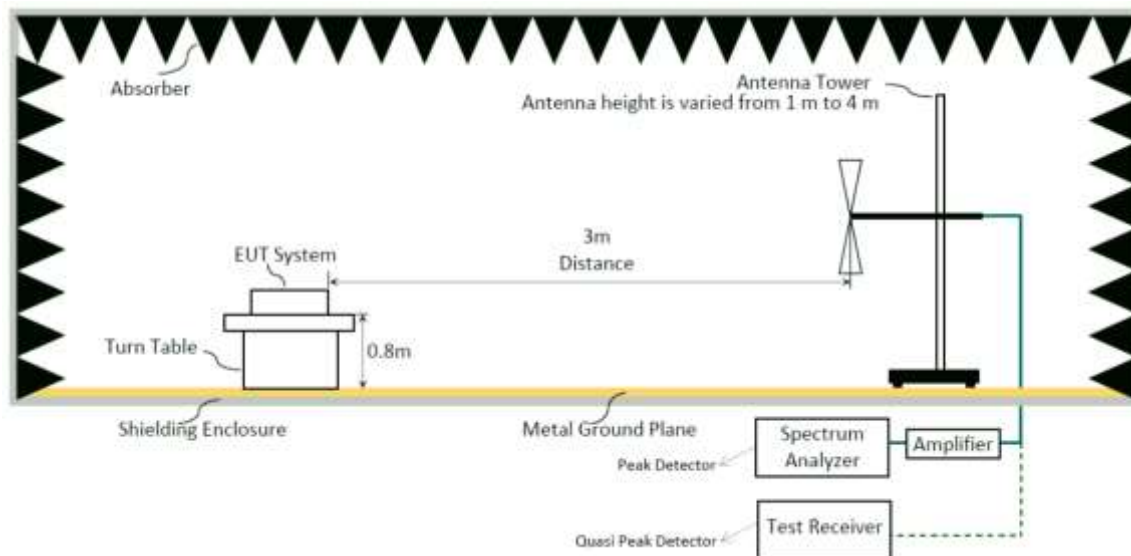

### 6.1.4. Setup Diagram for above 1GHz

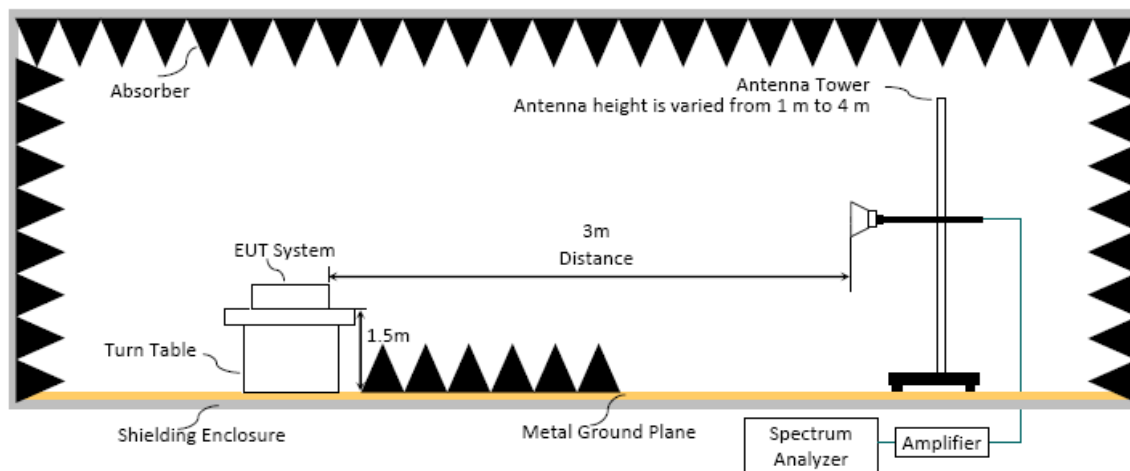

## 6.2. Radiated Emission Limits

In any 100kHz bandwidth outside the frequency band, the radio frequency power produced by the intentional radiator shall be at least 20dB below that in the 100kHz bandwidth within the band that contains the highest level. In addition, radiated emissions which fall in restricted bands, as defined in Section 15.205/RSS-Gen Section 8.10 table 6, must also comply with the radiated emission limits specified as below.

Frequency (MHz)	Distance(m)	Limits	
		dB $\mu$ V/m	$\mu$ V/m
0.009 - 0.490	300	67.6-20 log f(kHz)	2400/f kHz
0.490 - 1.705	30	87.6-20 log f(kHz)	24000/f kHz
1.705 - 30	30	29.5	30
30 - 88	3	40.0	100
88- 216	3	43.5	150
216- 960	3	46.0	200
Above 960	3	54.0	500
Above 1000	3	74.0 dB $\mu$ V/m (Peak) 54.0 dB $\mu$ V/m (Average)	

Remark : (1) dB $\mu$ V/m = 20 log ( $\mu$ V/m)

- (2) The tighter limit applies to the edge between two frequency bands.
- (3) Distance refers to the distance in meters between the measuring instrument antenna and the closed point of any part of the device or system.
- (4) Fundamental and emission fall within operation band are exempted from this section.
- (5) Pursuant to ANSI C63.10: 6.6.4.3, if the maximized peak measured value complies with the average limit, then it is unnecessary to perform an average measurement.

### 6.3. Test Procedure

#### Frequency Range 9kHz~30MHz:

The EUT setup on the turntable which has 0.8 m height to the ground. The turn table rotated 360 degrees and antenna fixed to 1 m to find the maximum emission level. In order to find the maximum emission, all of the interface cables were manipulated according to ANSI C63.10-2013 regulation.

- (1) RBW = 9kHz with peak and average detector.
- (2) Detector: average and peak (9kHz-490kHz)  
Q.P. (490kHz-30MHz)

#### Frequency Range 30MHz ~ 25GHz:

The EUT setup on the turn table which has 80cm (for 30-1000MHz) and 1.5m (for above 1GHz) height to the ground. The turn table rotated 360 degrees and antenna varied from 1 m to 4 m to find the maximum emission level. Both horizontal and vertical polarization are required. In order to find the maximum emission, all of the interface cables were manipulated according to ANSI C63.10-2013 regulation.

#### Frequency below 1GHz:

Spectrum Analyzer is used for pre-testing with following setting:

- (1) RBW = 120KHz
- (2) VBW  $\geq 3 \times$  RBW.
- (3) Detector = Peak.
- (4) Sweep time = auto.
- (5) Trace mode = max hold.
- (6) Allow sweeps to continue until the trace stabilizes.

Note 1: When peak-detected value is lower than limit that the measurement using the Q.P. detector is not required, otherwise using Q.P. for final measurement.

Note 2: When the radiated emissions limits are expressed in terms of the average value of the emissions, and pulsed operation is employed, the measurement field strength shall be determined by averaging over one complete pulse train, including blanking intervals, as long as the pulse train does not exceed 0.1 seconds.

#### Frequency above 1GHz to 10th harmonic(up to 25 GHz):

##### Peak Detector:

- (1) RBW = 1MHz
- (2) VBW  $\geq 3 \times$  RBW.
- (3) Detector = Peak.
- (4) Sweep time = auto.
- (5) Trace mode = max hold.
- (6) Allow sweeps to continue until the trace stabilizes.

Note: When peak-detected value is lower than limit that the measurement using the average detector is not required, otherwise using average detector for final measurement.



**Average Detector:** **Option 1:**

(1) RBW = 1MHz

(2) VBW  $\geq$  1/ T

Mode	TX <sub>on</sub> (ms)	1/ TX <sub>on</sub> (kHz)	VBW(>1/ TX <sub>on</sub> ) (kHz)
BT	2.89	0.346	3

(3) Detector = Peak.

(4) Sweep time = auto.

(5) Trace mode = max hold.

(6) Allow sweeps to continue until the trace stabilizes.

 **Option 2:**

Average Emission Level = Peak Emission Level + D.C.C.F.

**6.4. Measurement Result Explanation** Peak Emission Level (dB $\mu$ V/m) = Antenna Factor (dB/m) + Cable Loss (dB) – Preamp Gain (dB) + Reading (dB $\mu$ V). Average Emission Level (dB $\mu$ V/m) = Antenna Factor (dB/m) + Cable Loss (dB) – Preamp Gain (dB) + Reading (dB $\mu$ V). Average Emission Level (dB $\mu$ V/m) = Peak Emission Level (dB $\mu$ V/m) + DCCF (dB) Duty Cycle Correction Factor (DCCF) (dB) = 20log(TX<sub>on</sub>/TX<sub>on+off</sub>) presented in section 3.7. ERP (dBm) = Peak Emission Level (dB $\mu$ V/m) - 95.2dB - 2.14dB**6.5. Test Results**

Please refer to Appendix A.

## 7. 20dB/OCCUPIED BANDWIDTH

### 7.1. Block Diagram of Test Setup

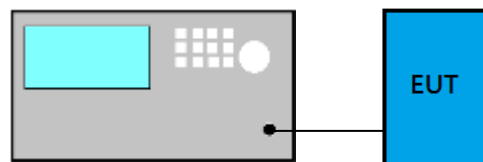

### 7.2. Specification Limits

Alternatively, frequency hopping systems operating in the 2400-2483.5MHz band may have hopping channel carrier frequencies that are separated by 25kHz or two-thirds of the 20dB bandwidth of the hopping channel, whichever is greater.

### 7.3. Test Procedure

Following measurement procedure is reference to ANSI C63.10:2013:

#### For 20dB Bandwidth

- (1) Set Span range 2~5 times the OBW
- (2) Set RBW close to 1% to 5% of OBW.
- (3) Set VBW  $\geq 3 \times$  RBW.
- (4) Detector = Peak.
- (5) Trace mode = Max hold.
- (6) Sweep = Auto couple.
- (7) Allow the trace to stabilize.
- (8) Setting channel bandwidth function x dB to -20 dB to record the final bandwidth.

#### For 99% Occupied Bandwidth

- (9) Set Span range 1.5~5 times the OBW
- (10) Set RBW close to 1% to 5% of OBW.
- (11) Set VBW  $\geq 3 \times$  RBW.
- (12) Detector = Peak.
- (13) Trace mode = Max hold
- (14) Sweep = Auto couple.
- (15) Allow the trace to stabilize.

### 7.4. Test Results

Please refer to Appendix A

## 8. CARRIER FREQUENCY SEPARATION

### 8.1. Block Diagram of Test Setup

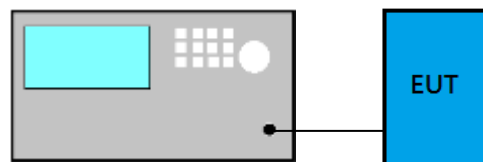

### 8.2. Specification Limits

Alternatively, frequency hopping systems operating in the 2400-2483.5MHz band may have hopping channel carrier frequencies that are separated by 25kHz or two-thirds of the 20dB bandwidth of the hopping channel, whichever is greater, provided the systems operate with an output no greater than 125mW.

### 8.3. Test Procedure

Following measurement procedure is reference to ANSI C63.10:2013:

- (1) Span = Wide enough to capture the peaks of two adjacent channels
- (2) RBW: Start with the RBW set to approximately 30% of the channel spacing; adjust as necessary to best identify the center of each individual channel.
- (3)  $VBW \geq RBW$
- (4) Sweep = Auto
- (5) Detector function = Peak
- (6) Trace = Max hold
- (7) Allow the trace to stabilize.

### 8.4. Test Results

Please refer to Appendix A

## 9. TIME OF OCCUPANCY

### 9.1. Block Diagram of Test Setup

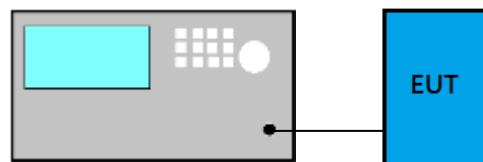

### 9.2. Specification Limits

Frequency hopping systems in the 2400-2483.5MHz shall use at least 15 non-overlapping channels. The average time of occupancy on any channel shall not be greater than 0.4 seconds within a period of 0.4 seconds multiplied by number of hopping channels employed.

### 9.3. Test Procedure

Following measurement procedure is reference to ANSI C63.10:2013:

- (1) Span: Zero span, centered on a hopping channel.
- (2) RBW shall be  $\leq$  channel spacing and where possible RBW should be set  $\gg 1/T$ , where T is the expected dwell time per channel.
- (3) Sweep: As necessary to capture the entire dwell time per hopping channel; where possible use a video trigger and trigger delay so that the transmitted signal starts a little to the right of the start of the plot. The trigger level might need slight adjustment to prevent triggering when the system hops on an adjacent channel; a second plot might be needed with a longer sweep time to show two successive hops on a channel.
- (4) Detector function = Peak
- (5) Trace = Max hold

### 9.4. Test Results

Please refer to Appendix A

## 10. NUMBER OF HOPPING CHANNELS

### 10.1. Block Diagram of Test Setup

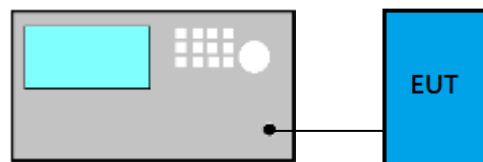

### 10.2. Specification Limits

Frequency hopping systems which use fewer than 20 hopping frequencies may employ intelligent hopping techniques to avoid interference to other transmissions. Frequency hopping systems may avoid or suppress transmissions on a particular hopping frequency provided that a minimum of 15 non-overlapping channels.

### 10.3. Test Procedure

Following measurement procedure is reference to ANSI C63.10:2013:

- (1) Span: The frequency band of operation. Depending on the number of channels the device supports, it may be necessary to divide the frequency range of operation across multiple spans, to allow the individual channels to be clearly seen.
- (2) RBW: To identify clearly the individual channels, set the RBW to less than 30% of the channel spacing or the 20 dB bandwidth, whichever is smaller.
- (3) VBW  $\geq$  RBW
- (4) Sweep = Auto
- (5) Detector function = Peak
- (6) Trace = m=Max hold
- (7) Allow the trace to stabilize.

### 10.4. Test Results

Please refer to Appendix A

## 11. MAXIMUM PEAK OUTPUT POWER

### 11.1. Block Diagram of Test Setup

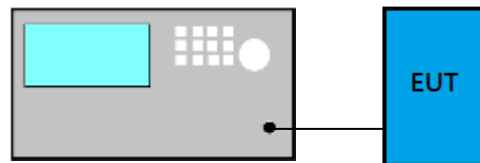

### 11.2. Specification Limits

The Limits of maximum Peak Output Power for frequency hopping systems in 2400-2483.5MHz is: 0.125Watt. (21dBm)

### 11.3. Test Procedure

Following measurement procedure is reference to ANSI C63.10:2013:

- (a) Use the following spectrum analyzer settings
  - (1) Span: Approximately five times the 20 dB bandwidth, centered on a hopping channel.
  - (2) RBW > 20 dB bandwidth of the emission being measured.
  - (3) VBW  $\geq$  RBW
  - (4) Sweep: Auto
  - (5) Detector function: Peak
  - (6) Trace: Max hold
- (b) Allow trace to stabilize.
- (c) Use the marker-to-peak function to set the marker to the peak of the emission.

### 11.4. Test Results

Please refer to Appendix A

## 12. EMISSION LIMITATIONS

### 12.1. Block Diagram of Test Setup

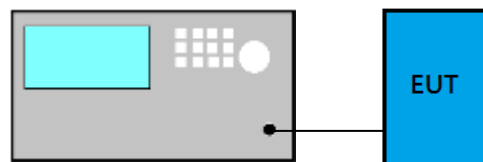

### 12.2. Specification Limits

In any 100kHz bandwidth outside the frequency band in which the spread spectrum or digitally modulated intentional radiator is operating, the radio frequency power that is produced by the intentional radiator shall be at least 20dB below that in the 100kHz bandwidth within the band that contains the highest level of the desired power, based on either an RF conducted or a radiated measurement. If the transmitter complies with the conducted power limits based on the use of RMS averaging over a time interval, that the required attenuation shall be 30 dB instead of 20 dB.

Attenuation below the general limits specified in Section 15.209(a)/RSS-Gen Section 8.9 table 4 is not required. In addition, radiated emissions which fall in restricted bands, as defined in Section 15.205(a)/RSS-Gen Section 8.10 table 6., must also comply with the radiated emission limits specified in Section 15.209(a)/RSS-Gen Section 8.9 table 4 (See Section 15.205(c)).

### 12.3. Test Procedure

Following measurement procedure is reference to ANSI C63.10:2013:

- (1) Set span wide enough to capture the peak level of the in-band emission and all spurious emissions; up to 10<sup>th</sup> harmonic.
- (2) RBW = 100 kHz
- (3) VBW  $\geq$  RBW
- (4) Sweep = Auto
- (5) Detector function = Peak
- (6) Trace = Max hold

### 12.4. Test Results

Please refer to Appendix A



## **13. DEVIATION TO TEST SPECIFICATIONS**

**【NONE】**





*Audix Technology Corp.*  
*No. 491, Zhongfu Rd., Linkou Dist.,*  
*New Taipei City 244, Taiwan*

*Tel: +886 2 26099301*  
*Fax: +886 2 26099303*

---

# APPDNDIX A

## TEST DATA AND PLOTS

(Model: 14Z90RS)

## TABLE OF CONTENTS

<b>A.1 CONDUCTED EMISSION</b> .....	<b>2</b>
<b>A.2 RADIATED EMISSION</b> .....	<b>4</b>
A.2.1 Emissions within Restricted Frequency Bands.....	4
A.2.2 Emissions outside the frequency band:.....	13
A.2.3 Emissions in Non-restricted Frequency Bands:.....	14
<b>A.3 20dB BANDWIDTH</b> .....	<b>15</b>
A.3.1 20dB Bandwidth Result.....	15
A.3.2 Measurement Plots .....	16
<b>A.4 CARRIER FREQUENCY SEPARATION</b> .....	<b>17</b>
<b>A.5 TIME OF OCCUPANCY</b> .....	<b>19</b>
A.5.1 Time of Occupancy .....	19
<b>A.6 NUMBER OF HOPPING CHANNELS</b> .....	<b>29</b>
<b>A.7 MAXIMUM PEAK OUTPUT POWER</b> .....	<b>30</b>
A.7.1 Maximum Peak Output Power.....	30
A.7.2 Measurement Plots .....	31
<b>A.8 EMISSION LIMITATIONS MEASUREMENT</b> .....	<b>32</b>
A.8.1 Band Edge.....	32
A.8.2 Spurious Emission .....	34

## A.1 CONDUCTED EMISSION

Test Date	2022/11/10	Temp./Hum.	26°C/64%
Test Voltage	AC 120V 60Hz (Via AC Adapter)	Tested By	Roy Hung

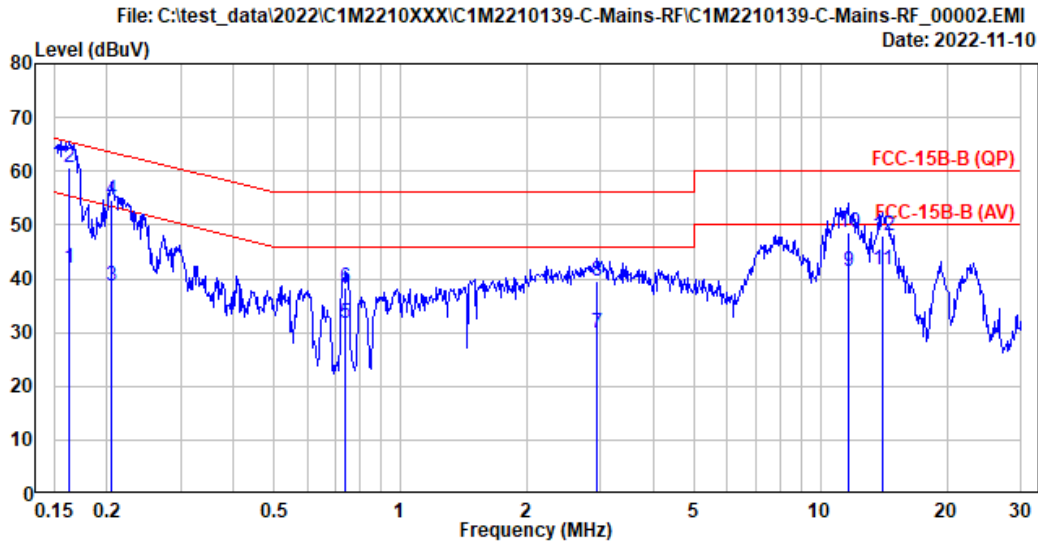

Site No.	: No.8 Shielded Room	Data No.	: 2
Instrument 1	: Receiver ESR(774)		
Instrument 2	: ENV432 (567)(A) CE-08 ESH3-Z2 (354)		
Limit	: FCC-15B-B (QP)	Phase	: Neutral
Environment	: 26°C/64 %	Engineer	: Roy Hung
EUT Model	: 14Z90RS	Test Rating	: 120Vac/60Hz
Test Mode	: Normal		

	Freq. (MHz)	AMN Factor (dB)	Cable Loss (dB)	Pulse Att. (dB)	Reading (dBµV)	Emission Level (dBµV)	Limits (dBµV)	Margin (dB)	Remark
1	0.163	10.33	0.03	9.85	21.62	41.83	55.30	13.47	Average
2	0.163	10.33	0.03	9.85	40.41	60.62	65.30	4.68	QP
3	0.205	10.32	0.03	9.85	18.58	38.78	53.39	14.61	Average
4	0.205	10.32	0.03	9.85	34.42	54.62	63.39	8.77	QP
5	0.739	10.33	0.04	9.85	11.41	31.63	46.00	14.37	Average
6	0.739	10.33	0.04	9.85	17.99	38.21	56.00	17.79	QP
7	2.940	10.38	0.07	9.86	9.44	29.75	46.00	16.25	Average
8	2.940	10.38	0.07	9.86	19.19	39.50	56.00	16.50	QP
9	11.637	10.72	0.15	9.90	20.60	41.37	50.00	8.63	Average
10	11.637	10.72	0.15	9.90	27.91	48.68	60.00	11.32	QP
11	14.064	10.84	0.16	9.91	20.70	41.61	50.00	8.39	Average
12	14.064	10.84	0.16	9.91	27.05	47.96	60.00	12.04	QP

Remarks: 1. Emission Level= AMN Factor + Cable Loss + Pulse Att. + Reading.  
 2. If the average limit is met when using a quasi-peak detector,  
 the EUT shall be deemed to meet both limits and measurement  
 with average detector is unnecessary.

Test Date	2022/11/10	Temp./Hum.	26°C/64%
Test Voltage	AC 120V 60Hz (Via AC Adapter)	Tested By	Roy Hung

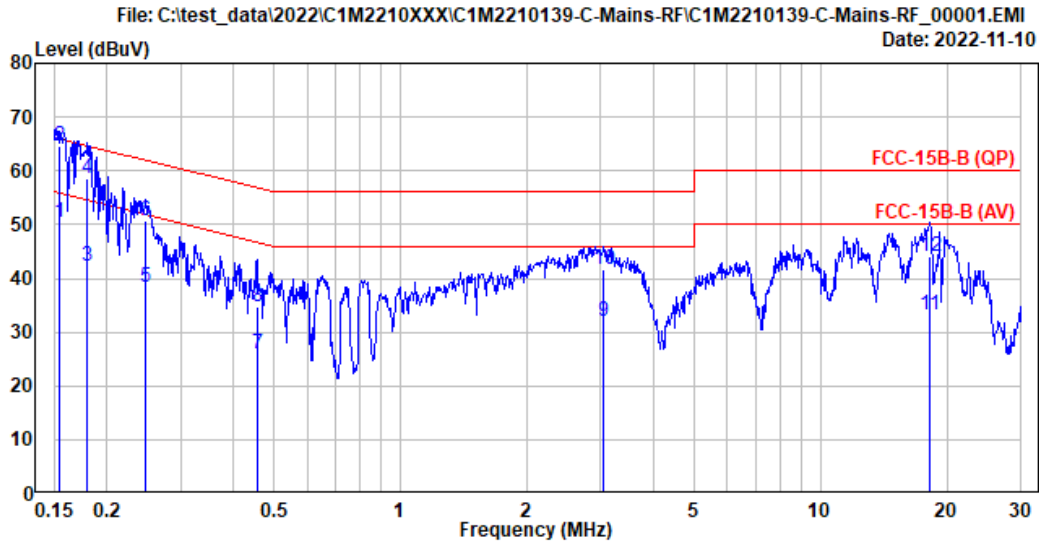

Site No.	: No.8 Shielded Room	Data No.	: 1
Instrument 1	: Receiver ESR(774)		
Instrument 2	: ENV432 (567)(A) CE-08 ESH3-Z2 (354)		
Limit	: FCC-15B-B (QP)	Phase	: Line
Environment	: 26°C/64 %	Engineer	: Roy Hung
EUT Model	: 14Z90RS	Test Rating	: 120Vac/60Hz
Test Mode	: Normal		

	Freq. (MHz)	AMN Factor (dB)	Cable Loss (dB)	Pulse Att. (dB)	Reading (dBµV)	Emission Level (dBµV)	Limits (dBµV)	Margin (dB)	Remark
1	0.154	10.22	0.03	9.85	30.33	50.43	55.79	5.36	Average
2	0.154	10.22	0.03	9.85	44.47	64.57	65.79	1.22	QP
3	0.179	10.22	0.03	9.85	22.16	42.26	54.51	12.25	Average
4	0.179	10.22	0.03	9.85	38.50	58.60	64.51	5.91	QP
5	0.248	10.22	0.03	9.85	18.13	38.23	51.82	13.59	Average
6	0.248	10.22	0.03	9.85	30.63	50.73	61.82	11.09	QP
7	0.456	10.22	0.03	9.85	5.88	25.98	46.77	20.79	Average
8	0.456	10.22	0.03	9.85	14.66	34.76	56.77	22.01	QP
9	3.045	10.27	0.07	9.86	11.73	31.93	46.00	14.07	Average
10	3.045	10.27	0.07	9.86	21.46	41.66	56.00	14.34	QP
11	18.225	10.61	0.19	9.93	12.50	33.23	50.00	16.77	Average
12	18.225	10.61	0.19	9.93	23.37	44.10	60.00	15.90	QP

Remarks: 1. Emission Level= AMN Factor + Cable Loss + Pulse Att. + Reading.  
 2. If the average limit is met when using a quasi-peak detector,  
 the EUT shall be deemed to meet both limits and measurement  
 with average detector is unnecessary.

## A.2 RADIATED EMISSION

Test Date	2022/10/25 ~ 28	Temp./Hum.	24-25°C/59-60%
Test Voltage	AC 120V 60Hz (Via AC Adapter)	Tested By	Martin Chen

### A.2.1 Emissions within Restricted Frequency Bands

#### A.2.1.1 Frequency 9kHz~30MHz

**The emissions (9kHz~30MHz) not reported for there is no emission be found.**

#### A.2.1.2 Frequency Below 1GHz

Mode	GFSK	Frequency	TX 2480MHz
------	------	-----------	------------

#### Antenna at Horizontal Polarization

Emission Frequency (MHz)	Antenna Factor (dB/m)	Cable Loss (dB)	Preamplifier Gain (dB)	Read Level (dBμV)	Emission Level (dBμV/m)	Limits (dBμV/m)	Margin (dB)	Detector
30.000	23.27	1.41	26.49	32.26	30.45	40.00	9.55	Peak
148.340	16.99	3.18	26.00	34.97	29.14	43.50	14.36	Peak
289.960	19.15	4.61	25.62	37.61	35.75	46.00	10.25	Peak
378.230	21.18	5.69	26.28	38.57	39.16	46.00	6.84	Peak
485.900	23.24	6.65	27.04	35.99	38.84	46.00	7.16	Peak
959.260	26.67	9.08	26.78	28.35	37.32	46.00	8.68	Peak

#### Antenna at Vertical Polarization

Emission Frequency (MHz)	Antenna Factor (dB/m)	Cable Loss (dB)	Preamplifier Gain (dB)	Read Level (dBμV)	Emission Level (dBμV/m)	Limits (dBμV/m)	Margin (dB)	Detector
31.940	22.87	1.46	0.00	12.80	37.13	40.00	2.87	QP
150.280	16.86	3.21	26.00	41.54	35.61	43.50	7.89	Peak
224.970	17.02	4.00	25.74	40.44	35.72	46.00	10.28	Peak
378.230	21.18	5.69	26.28	37.76	38.35	46.00	7.65	Peak
485.900	23.24	6.65	27.04	35.36	38.21	46.00	7.79	Peak
990.300	27.00	9.24	26.69	27.68	37.23	54.00	16.77	Peak

A.2.1.3 Frequency Above 1 GHz to 10<sup>th</sup> harmonics

**Band Edge:**

Mode	GFSK	Frequency	TX 2402MHz
------	------	-----------	------------

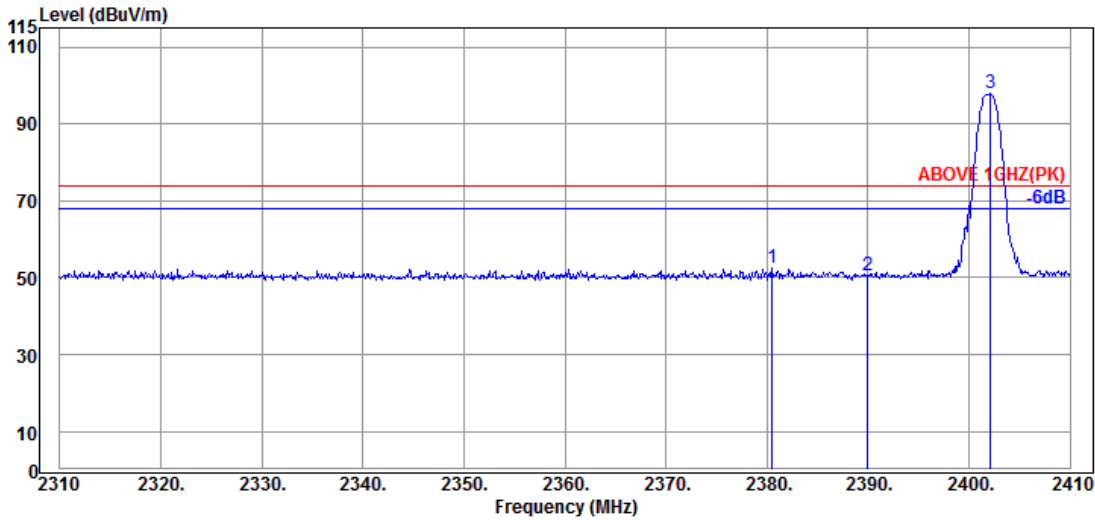

Antenna at Horizontal Polarization

Emission Frequency (MHz)	Antenna Factor (dB/m)	Cable Loss (dB)	Preamplifier Gain (dB)	Read Level (dBμV)	Emission Level (dBμV/m)	Limits (dBμV/m)	Margin (dB)	Detector
2380.500	32.00	5.71	34.51	49.41	52.61	74.00	21.39	Peak
2390.000	32.00	5.72	34.51	47.38	50.59	74.00	23.41	Peak
@ 2402.100	32.00	5.74	34.51	94.58	97.81	---	---	Peak

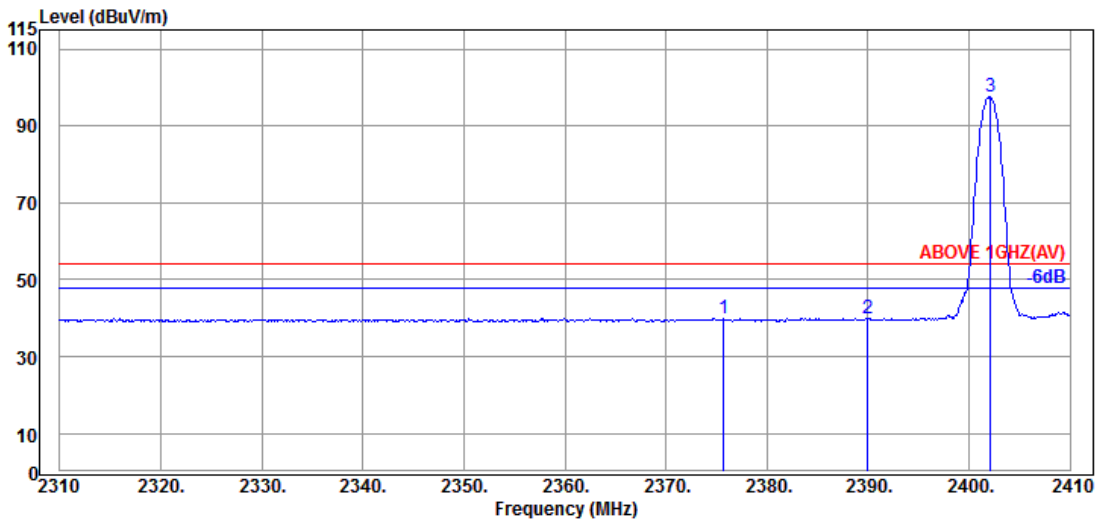

Antenna at Horizontal Polarization

Emission Frequency (MHz)	Antenna Factor (dB/m)	Cable Loss (dB)	Preamplifier Gain (dB)	Read Level (dBμV)	Emission Level (dBμV/m)	Limits (dBμV/m)	Margin (dB)	Detector
2375.700	32.00	5.70	34.50	36.83	40.03	54.00	13.97	Average
2390.000	32.00	5.72	34.51	36.66	39.87	54.00	14.13	Average
@ 2402.100	32.00	5.74	34.51	94.25	97.48	---	---	Average

Remark: The “@” means fundamental frequency, it is ignored in this section.

Mode	GFSK	Frequency	TX 2402MHz
------	------	-----------	------------

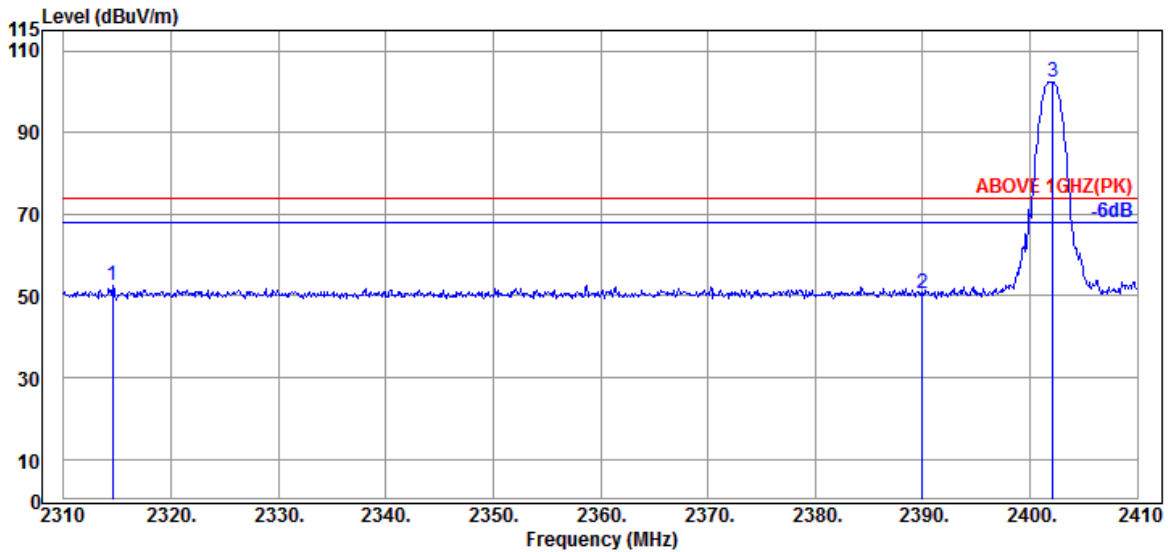

Antenna at Vertical Polarization

Emission Frequency (MHz)	Antenna Factor (dB/m)	Cable Loss (dB)	Preamplifier Gain (dB)	Read Level (dBμV)	Emission Level (dBμV/m)	Limits (dBμV/m)	Margin (dB)	Detector
2314.600	32.15	5.60	34.49	49.35	52.61	74.00	21.39	Peak
2390.000	32.00	5.72	34.51	47.46	50.67	74.00	23.33	Peak
@ 2402.100	32.00	5.74	34.51	99.03	102.26	---	---	Peak

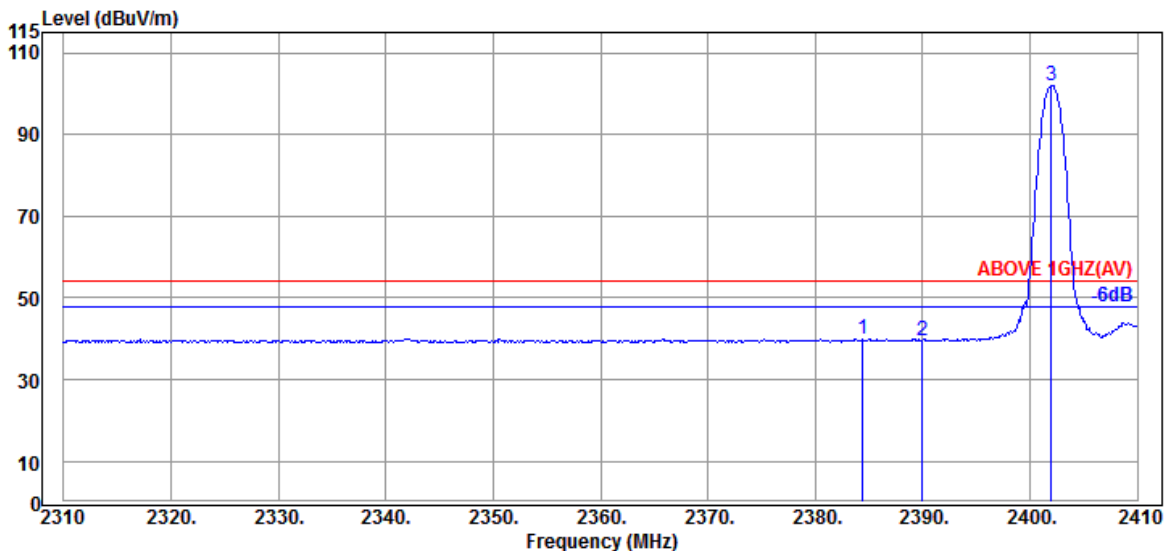

Antenna at Vertical Polarization

Emission Frequency (MHz)	Antenna Factor (dB/m)	Cable Loss (dB)	Preamplifier Gain (dB)	Read Level (dBμV)	Emission Level (dBμV/m)	Limits (dBμV/m)	Margin (dB)	Detector
2384.400	32.00	5.72	34.51	36.87	40.08	54.00	13.92	Average
2390.000	32.00	5.72	34.51	36.36	39.57	54.00	14.43	Average
@ 2402.000	32.00	5.74	34.51	98.87	102.10	---	---	Average

Remark: The “@” means fundamental frequency, it is ignored in this section.

Mode	GFSK	Frequency	TX 2480MHz
------	------	-----------	------------

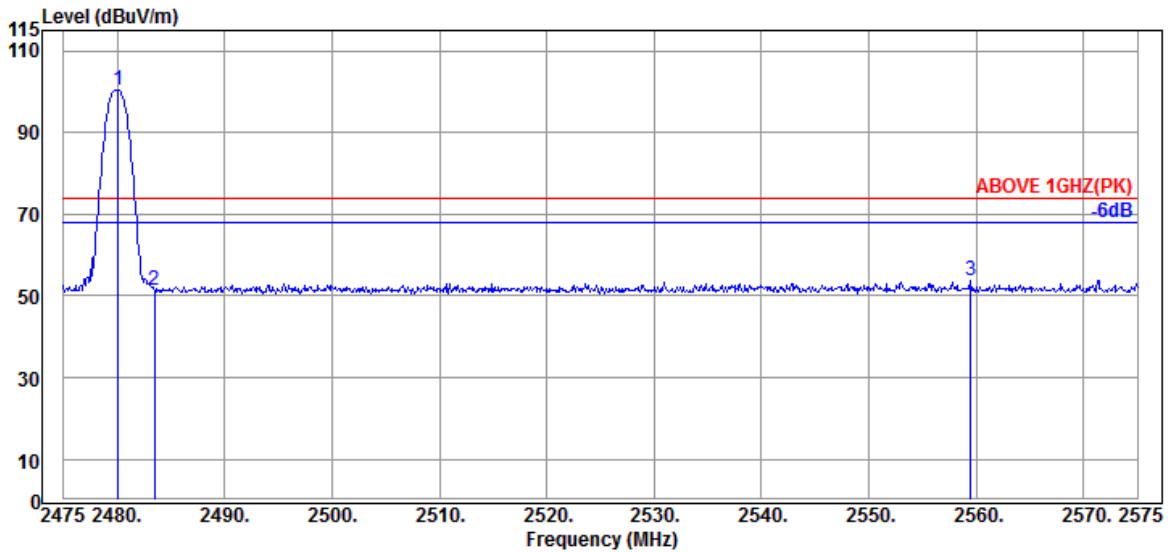

Antenna at Horizontal Polarization

Emission Frequency (MHz)	Antenna Factor (dB/m)	Cable Loss (dB)	Preamplifier Gain (dB)	Read Level (dBμV)	Emission Level (dBμV/m)	Limits (dBμV/m)	Margin (dB)	Detector
@ 2480.100	32.34	5.86	34.53	96.55	100.22	---	---	Peak
2483.500	32.43	5.87	34.53	47.54	51.31	74.00	22.69	Peak
2559.500	32.39	6.03	34.54	50.03	53.91	74.00	20.09	Peak

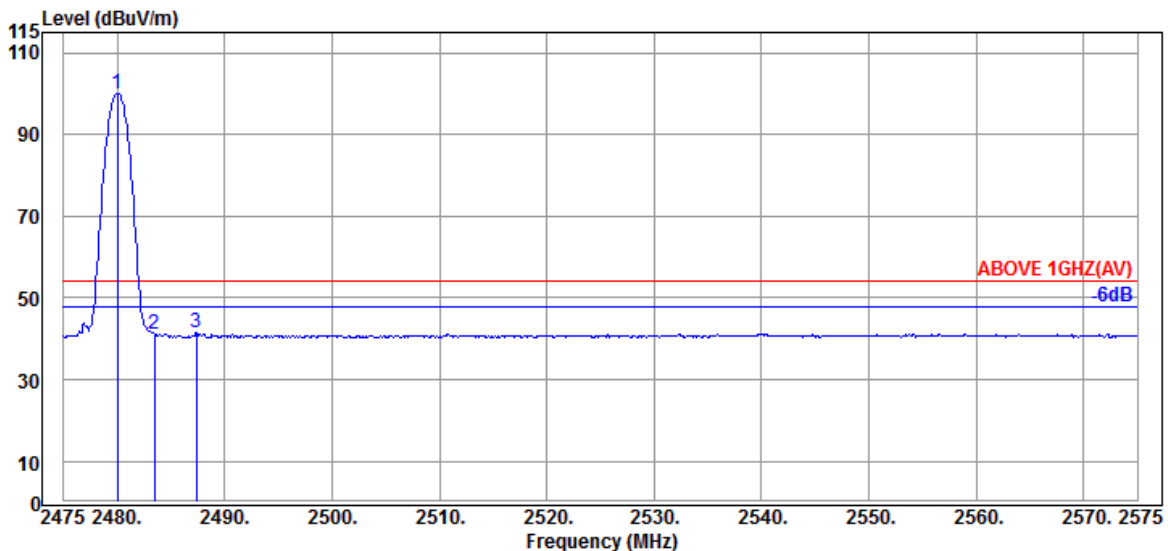

Antenna at Horizontal Polarization

Emission Frequency (MHz)	Antenna Factor (dB/m)	Cable Loss (dB)	Preamplifier Gain (dB)	Read Level (dBμV)	Emission Level (dBμV/m)	Limits (dBμV/m)	Margin (dB)	Detector
@ 2480.000	32.34	5.86	34.53	96.34	100.01	---	---	Average
2483.500	32.43	5.87	34.53	37.30	41.07	54.00	12.93	Average
2487.400	32.43	5.87	34.53	37.60	41.37	54.00	12.63	Average

Remark: The “@” means fundamental frequency, it is ignored in this section.



Mode	GFSK	Frequency	TX 2480MHz
------	------	-----------	------------

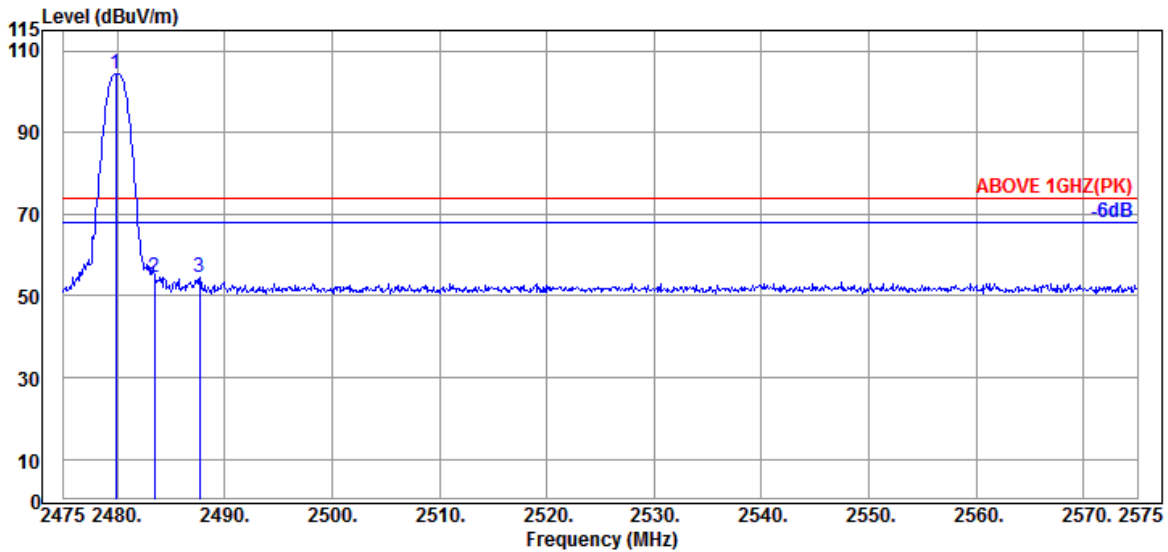

Antenna at Vertical Polarization

Emission Frequency (MHz)	Antenna Factor (dB/m)	Cable Loss (dB)	Preamplifier Gain (dB)	Read Level (dBμV)	Emission Level (dBμV/m)	Limits (dBμV/m)	Margin (dB)	Detector
@ 2479.900	32.34	5.86	34.53	100.64	104.31	---	---	Peak
2483.500	32.43	5.87	34.53	50.96	54.73	74.00	19.27	Peak
2487.700	32.43	5.87	34.53	50.61	54.38	74.00	19.62	Peak

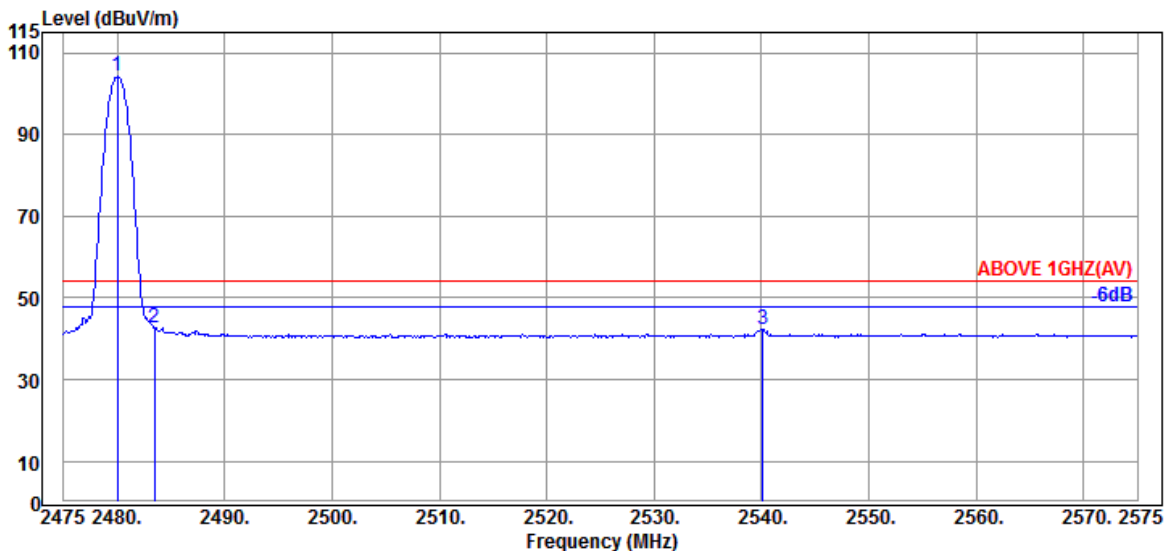

Antenna at Vertical Polarization

Emission Frequency (MHz)	Antenna Factor (dB/m)	Cable Loss (dB)	Preamplifier Gain (dB)	Read Level (dBμV)	Emission Level (dBμV/m)	Limits (dBμV/m)	Margin (dB)	Detector
@ 2480.000	32.34	5.86	34.53	100.52	104.19	---	---	Average
2483.500	32.43	5.87	34.53	38.94	42.71	54.00	11.29	Average
2540.100	32.43	6.00	34.54	38.29	42.18	54.00	11.82	Average

Remark: The "@" means fundamental frequency, it is ignored in this section.

Mode	8-DPSK	Frequency	TX 2402MHz
------	--------	-----------	------------

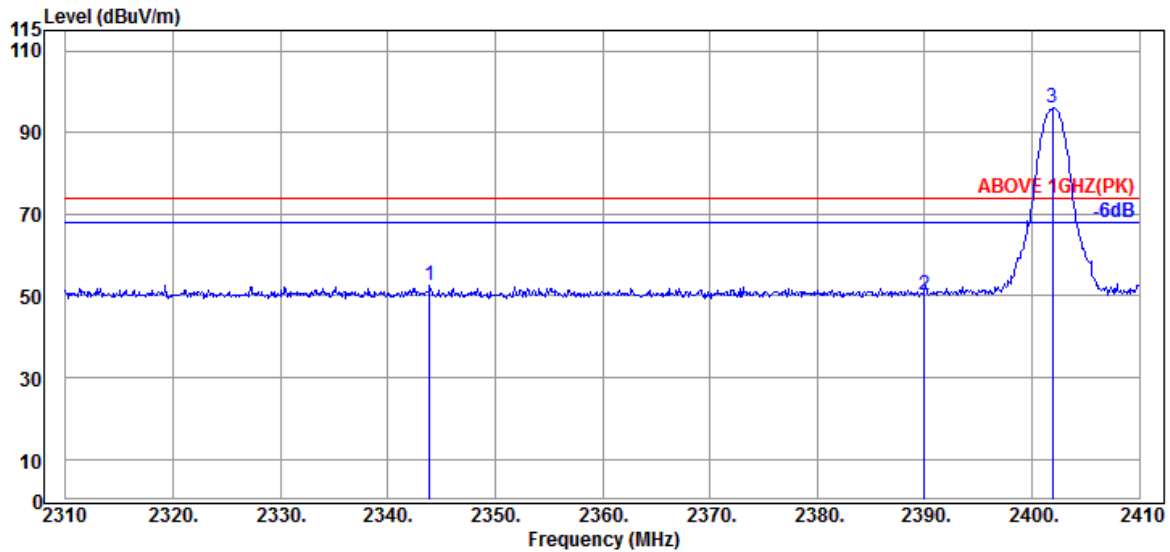

Antenna at Horizontal Polarization

Emission Frequency (MHz)	Antenna Factor (dB/m)	Cable Loss (dB)	Preamplifier Gain (dB)	Read Level (dBμV)	Emission Level (dBUV/m)	Limits (dBUV/m)	Margin (dB)	Detector
2343.900	32.03	5.65	34.50	49.32	52.50	74.00	21.50	Peak
2390.000	32.00	5.72	34.51	47.02	50.23	74.00	23.77	Peak
@ 2401.900	32.00	5.74	34.51	92.84	96.07	---	---	Peak

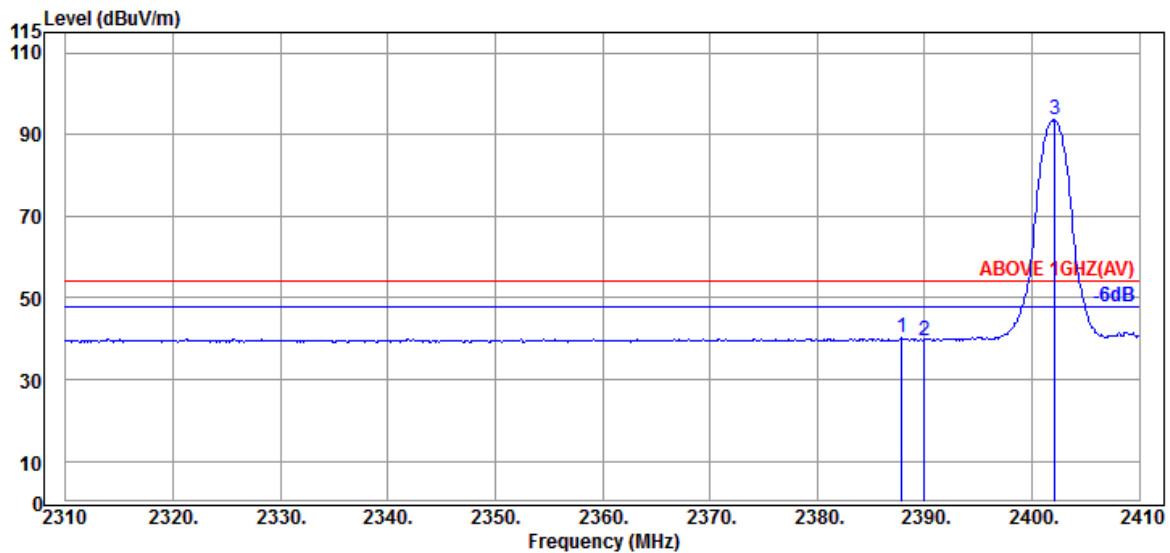

Antenna at Horizontal Polarization

Emission Frequency (MHz)	Antenna Factor (dB/m)	Cable Loss (dB)	Preamplifier Gain (dB)	Read Level (dBμV)	Emission Level (dBUV/m)	Limits (dBUV/m)	Margin (dB)	Detector
2387.900	32.00	5.72	34.51	36.91	40.12	54.00	13.88	Average
2390.000	32.00	5.72	34.51	36.49	39.70	54.00	14.30	Average
@ 2402.100	32.00	5.74	34.51	90.33	93.56	---	---	Average

Remark: The “@” means fundamental frequency, it is ignored in this section.

Mode	8-DPSK	Frequency	TX 2402MHz
------	--------	-----------	------------

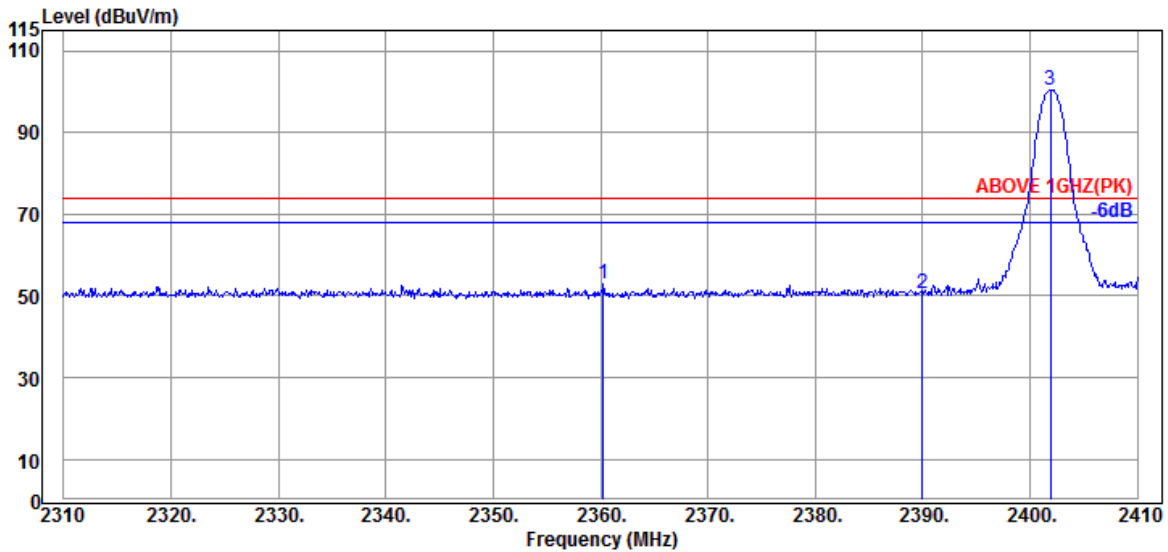

Antenna at Vertical Polarization

Emission Frequency (MHz)	Antenna Factor (dB/m)	Cable Loss (dB)	Preamplifier Gain (dB)	Read Level (dBμV)	Emission Level (dBμV/m)	Limits (dBμV/m)	Margin (dB)	Detector
2360.300	32.00	5.67	34.50	49.63	52.80	74.00	21.20	Peak
2390.000	32.00	5.72	34.51	47.24	50.45	74.00	23.55	Peak
@ 2401.900	32.00	5.74	34.51	97.24	100.47	---	---	Peak

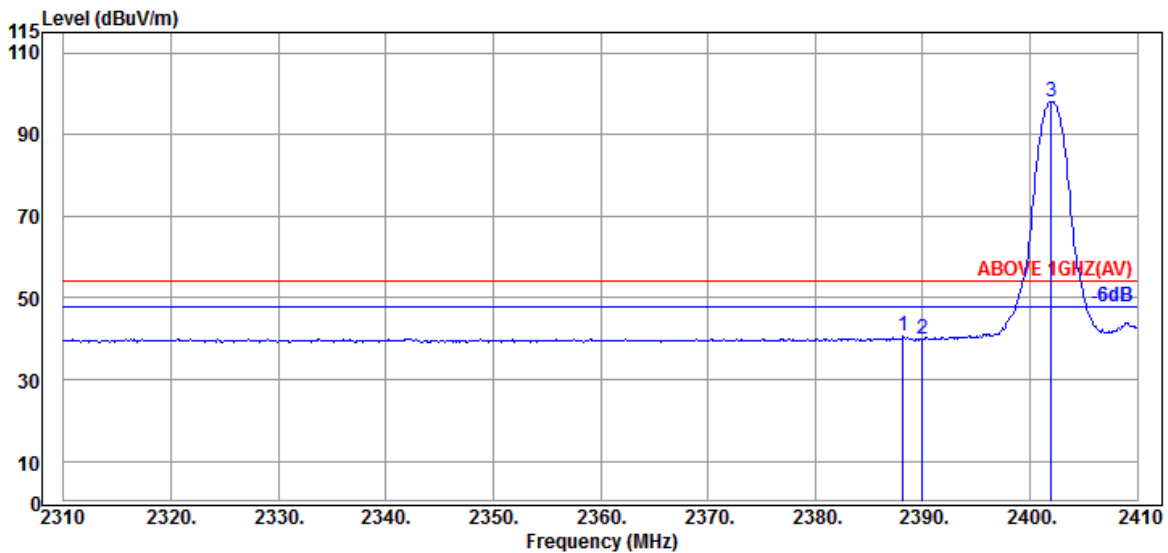

Antenna at Vertical Polarization

Emission Frequency (MHz)	Antenna Factor (dB/m)	Cable Loss (dB)	Preamplifier Gain (dB)	Read Level (dBμV)	Emission Level (dBμV/m)	Limits (dBμV/m)	Margin (dB)	Detector
2388.200	32.00	5.72	34.51	37.40	40.61	54.00	13.39	Average
2390.000	32.00	5.72	34.51	36.62	39.83	54.00	14.17	Average
@ 2402.000	32.00	5.74	34.51	94.82	98.05	---	---	Average

Remark: The "@" means fundamental frequency, it is ignored in this section.

Mode	8-DPSK	Frequency	TX 2480MHz
------	--------	-----------	------------

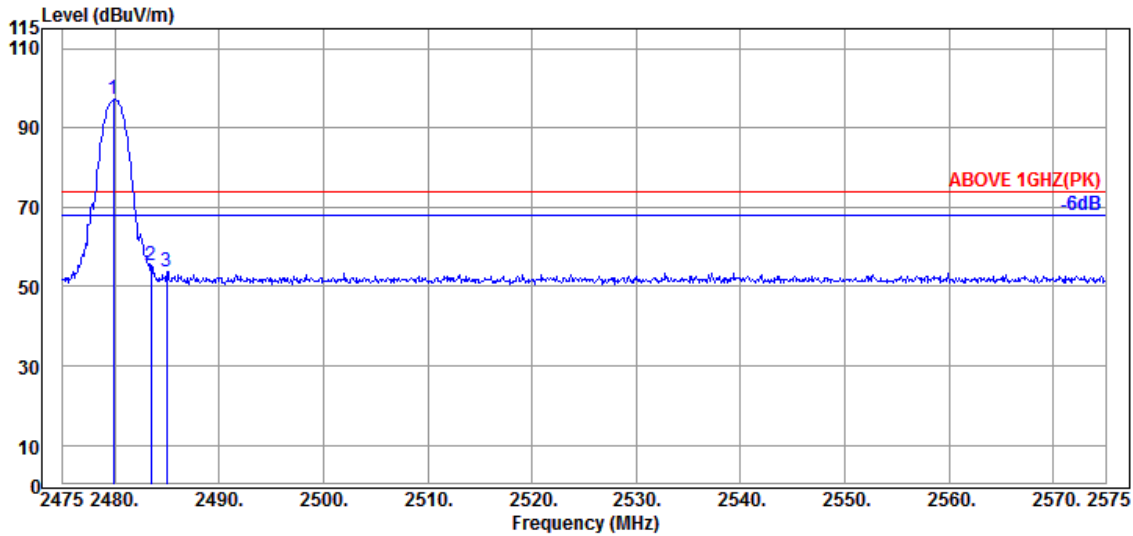

Antenna at Horizontal Polarization

Emission Frequency (MHz)	Antenna Factor (dB/m)	Cable Loss (dB)	Preamplifier Gain (dB)	Read Level (dBμV)	Emission Level (dBμV/m)	Limits (dBμV/m)	Margin (dB)	Detector
@ 2479.900	32.34	5.86	34.53	93.52	97.19	---	---	Peak
2483.500	32.43	5.87	34.53	51.63	55.40	74.00	18.60	Peak
2485.000	32.43	5.87	34.53	50.02	53.79	74.00	20.21	Peak

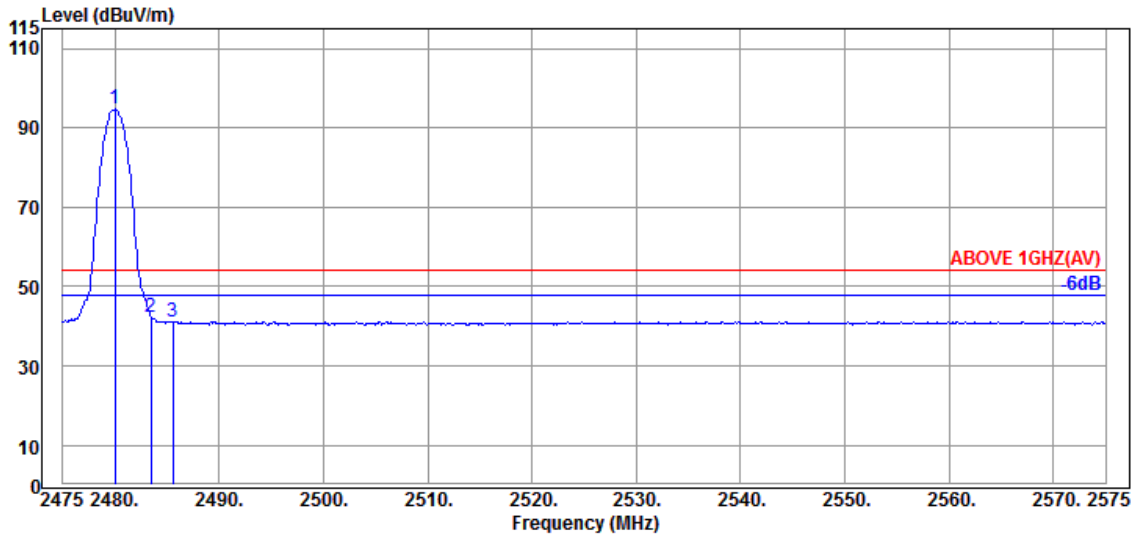

Antenna at Horizontal Polarization

Emission Frequency (MHz)	Antenna Factor (dB/m)	Cable Loss (dB)	Preamplifier Gain (dB)	Read Level (dBμV)	Emission Level (dBμV/m)	Limits (dBμV/m)	Margin (dB)	Detector
@ 2480.000	32.34	5.86	34.53	91.02	94.69	---	---	Average
2483.500	32.43	5.87	34.53	38.53	42.30	54.00	11.70	Average
2485.600	32.43	5.87	34.53	37.51	41.28	54.00	12.72	Average

Remark: The “@” means fundamental frequency, it is ignored in this section.

Mode	8-DPSK	Frequency	TX 2480MHz
------	--------	-----------	------------

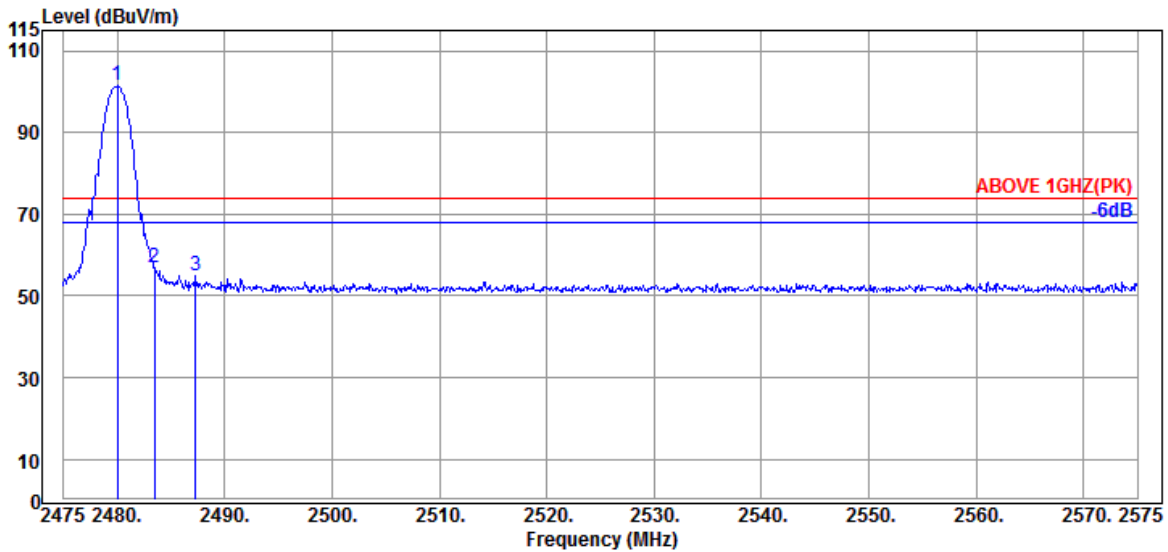

Antenna at Vertical Polarization

Emission Frequency (MHz)	Antenna Factor (dB/m)	Cable Loss (dB)	Preamplifier Gain (dB)	Read Level (dBμV)	Emission Level (dBUV/m)	Limits (dBUV/m)	Margin (dB)	Detector
@ 2480.000	32.34	5.86	34.53	97.71	101.38	---	---	Peak
2483.500	32.43	5.87	34.53	53.18	56.95	74.00	17.05	Peak
2487.300	32.43	5.87	34.53	50.97	54.74	74.00	19.26	Peak

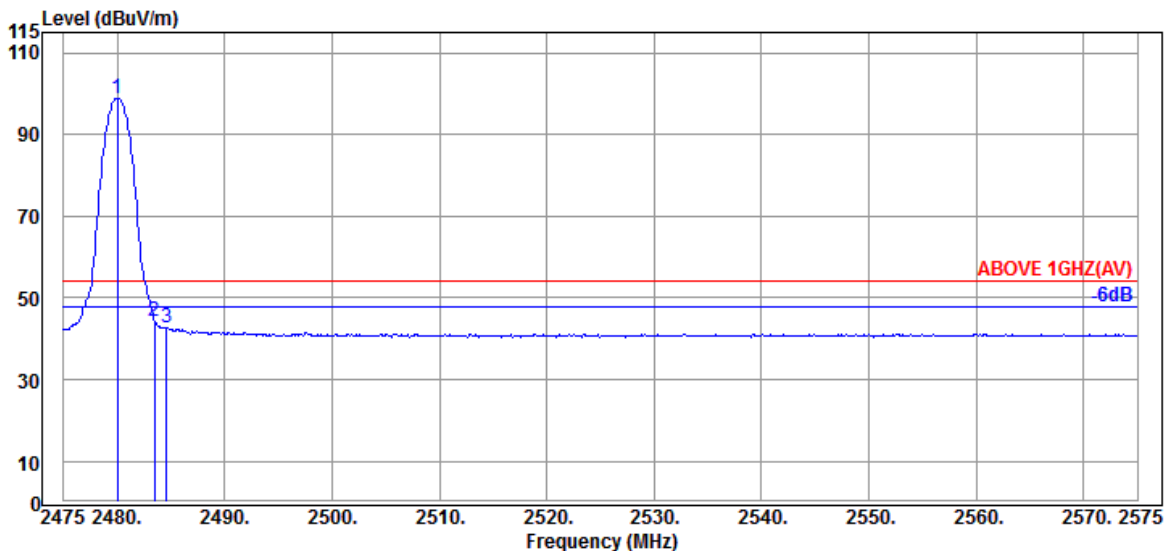

Antenna at Vertical Polarization

Emission Frequency (MHz)	Antenna Factor (dB/m)	Cable Loss (dB)	Preamplifier Gain (dB)	Read Level (dBμV)	Emission Level (dBUV/m)	Limits (dBUV/m)	Margin (dB)	Detector
@ 2480.000	32.34	5.86	34.53	95.17	98.84	---	---	Average
2483.500	32.43	5.87	34.53	40.57	44.34	54.00	9.66	Average
2484.600	32.43	5.87	34.53	38.88	42.65	54.00	11.35	Average

Remark: The “@” means fundamental frequency, it is ignored in this section.

**A.2.2 Emissions outside the frequency band:**

The emissions (up to 25GHz) not reported for there is no emission be found.

Mode	GFSK	Frequency	TX 2402MHz
------	------	-----------	------------

**Antenna at Horizontal Polarization**

Emission Frequency (MHz)	Antenna Factor (dB/m)	Cable Loss (dB)	Preamplifier Gain (dB)	Read Level (dBμV)	Emission Level (dBμV/m)	Limits (dBμV/m)	Margin (dB)	Detector
4804.000	34.10	8.53	34.43	33.21	41.41	54.00	12.59	Peak

**Antenna at Vertical Polarization**

Emission Frequency (MHz)	Antenna Factor (dB/m)	Cable Loss (dB)	Preamplifier Gain (dB)	Read Level (dBμV)	Emission Level (dBμV/m)	Limits (dBμV/m)	Margin (dB)	Detector
4804.000	34.10	8.53	34.43	34.51	42.71	54.00	11.29	Peak

Mode	GFSK	Frequency	TX 2441MHz
------	------	-----------	------------

**Antenna at Horizontal Polarization**

Emission Frequency (MHz)	Antenna Factor (dB/m)	Cable Loss (dB)	Preamplifier Gain (dB)	Read Level (dBμV)	Emission Level (dBμV/m)	Limits (dBμV/m)	Margin (dB)	Detector
4882.000	34.05	8.64	34.42	30.36	38.63	54.00	15.37	Peak

**Antenna at Vertical Polarization**

Emission Frequency (MHz)	Antenna Factor (dB/m)	Cable Loss (dB)	Preamplifier Gain (dB)	Read Level (dBμV)	Emission Level (dBμV/m)	Limits (dBμV/m)	Margin (dB)	Detector
4882.000	34.05	8.64	34.42	32.10	40.37	54.00	13.63	Peak

Mode	GFSK	Frequency	TX 2480MHz
------	------	-----------	------------

**Antenna at Horizontal Polarization**

Emission Frequency (MHz)	Antenna Factor (dB/m)	Cable Loss (dB)	Preamplifier Gain (dB)	Read Level (dB $\mu$ V)	Emission Level (dB $\mu$ V/m)	Limits (dB $\mu$ V/m)	Margin (dB)	Detector
4960.000	34.22	8.74	34.41	32.77	41.32	54.00	12.68	Peak

**Antenna at Vertical Polarization**

Emission Frequency (MHz)	Antenna Factor (dB/m)	Cable Loss (dB)	Preamplifier Gain (dB)	Read Level (dB $\mu$ V)	Emission Level (dB $\mu$ V/m)	Limits (dB $\mu$ V/m)	Margin (dB)	Detector
4960.000	34.22	8.74	34.41	32.46	41.01	54.00	12.99	Peak

**A.2.3 Emissions in Non-restricted Frequency Bands:**

All emission levels below the FCC 15.209(a)/RSS-Gen Section 8.9 table 4 general radiated emissions limits is not required.

## A.3 20dB BANDWIDTH

Test Date	2022/10/17	Temp./Hum.	23°C/76%
Cable Loss	0.5dB	Tested By	Kuper Hsu
Test Voltage	AC 120V 60Hz (Via AC Adapter)		

### A.3.1 20dB Bandwidth Result

Mode	Centre Frequency (MHz)	20dB Bandwidth (MHz)	99% Occupied Bandwidth (MHz) (Reference only)	2/3 (20dB Bandwidth)
GFSK	2402	0.9269	0.87767	0.618
	2441	0.9275	0.87430	0.618
	2480	0.9249	0.87620	0.617
8-DPSK	2402	1.453	1.3550	0.969
	2441	1.455	1.3556	0.970
	2480	1.435	1.3544	0.957

Remark: The maximum two-thirds of the 20dB bandwidth is the limit for carrier frequency separation presented.



A.3.2 Measurement Plots

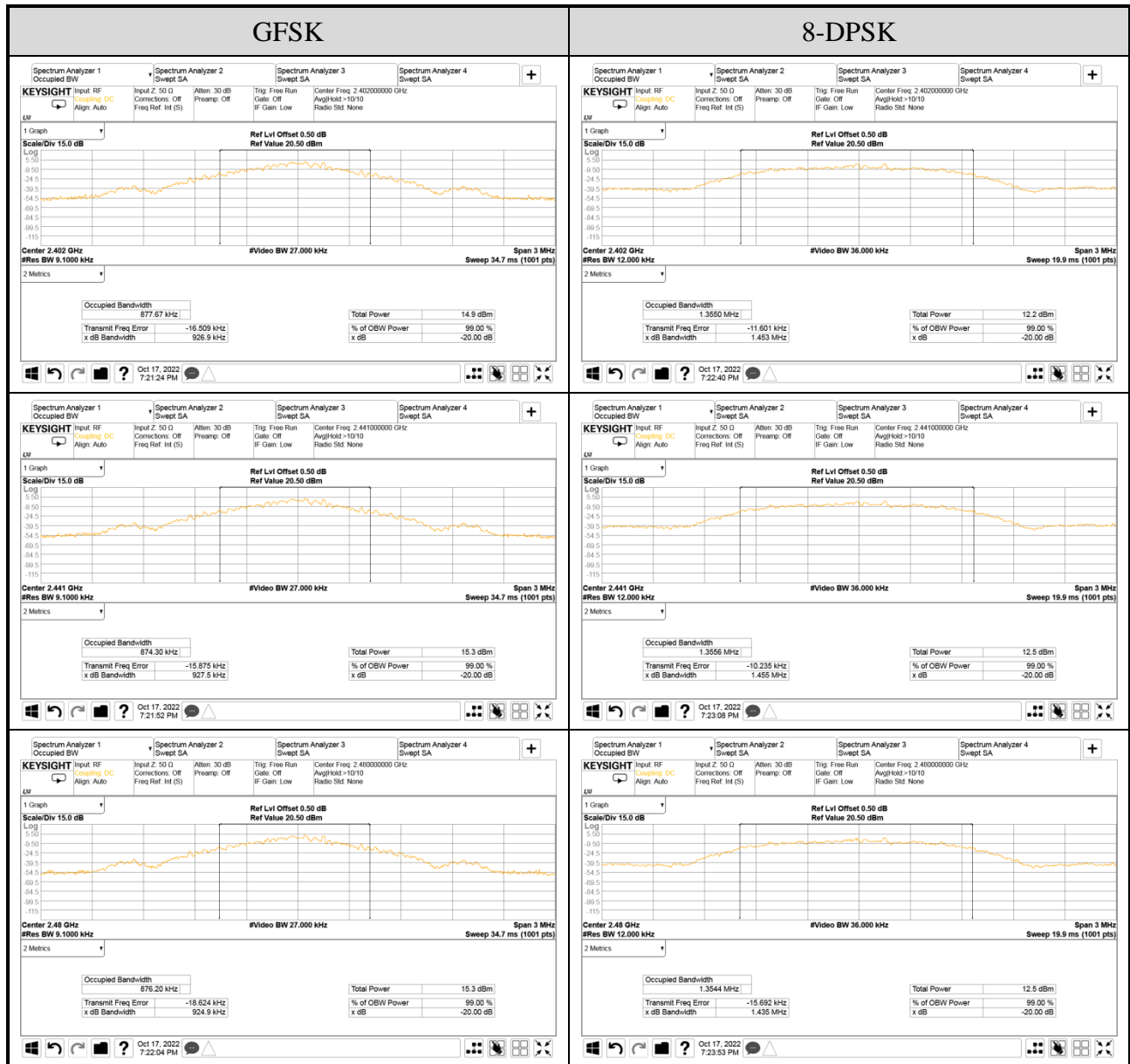

## A.4 CARRIER FREQUENCY SEPARATION

Test Date	2022/10/17	Temp./Hum.	23°C/76%
Cable Loss	0.5dB	Tested By	Kuper Hsu
Test Voltage	AC 120V 60Hz (Via AC Adapter)		

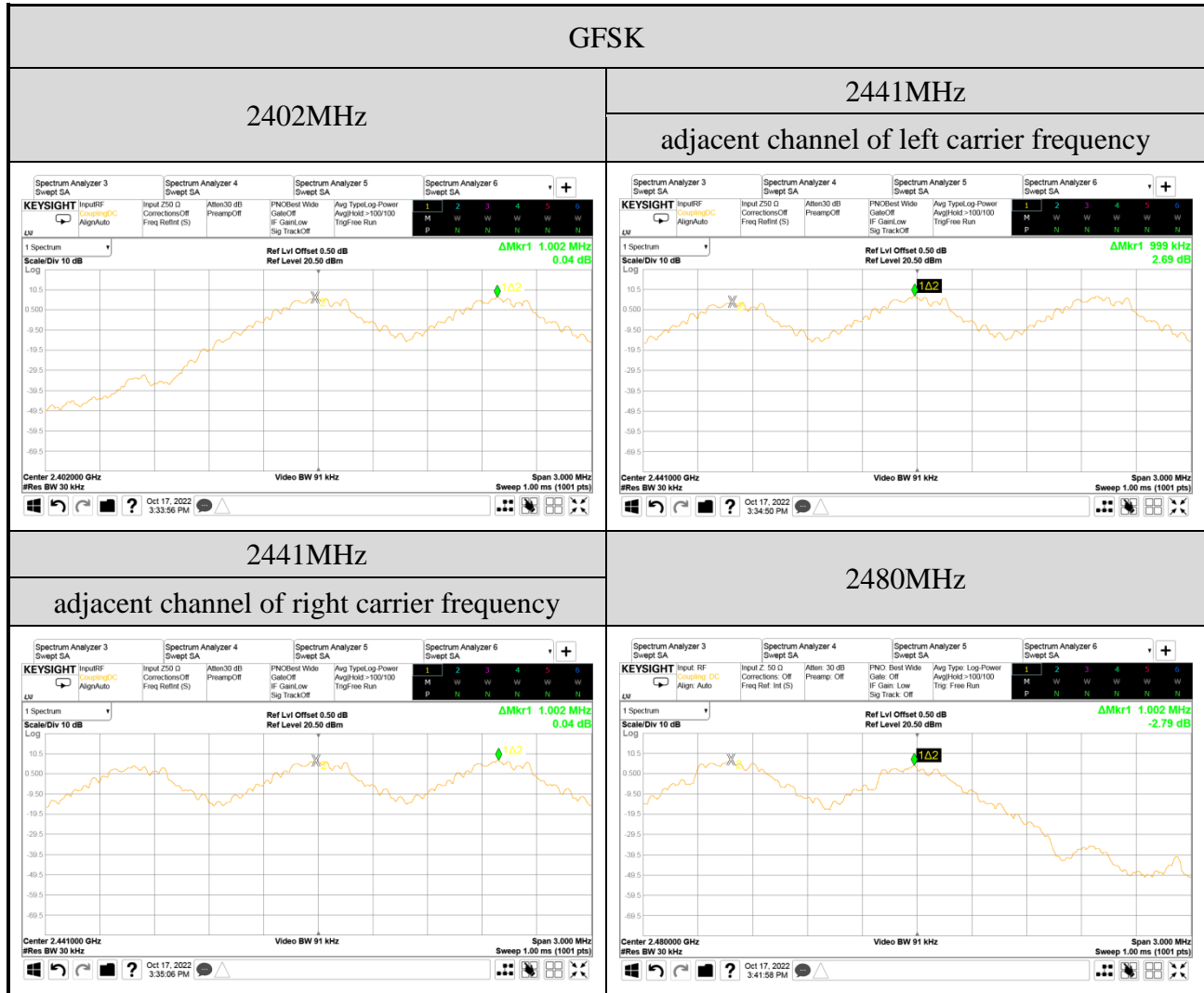

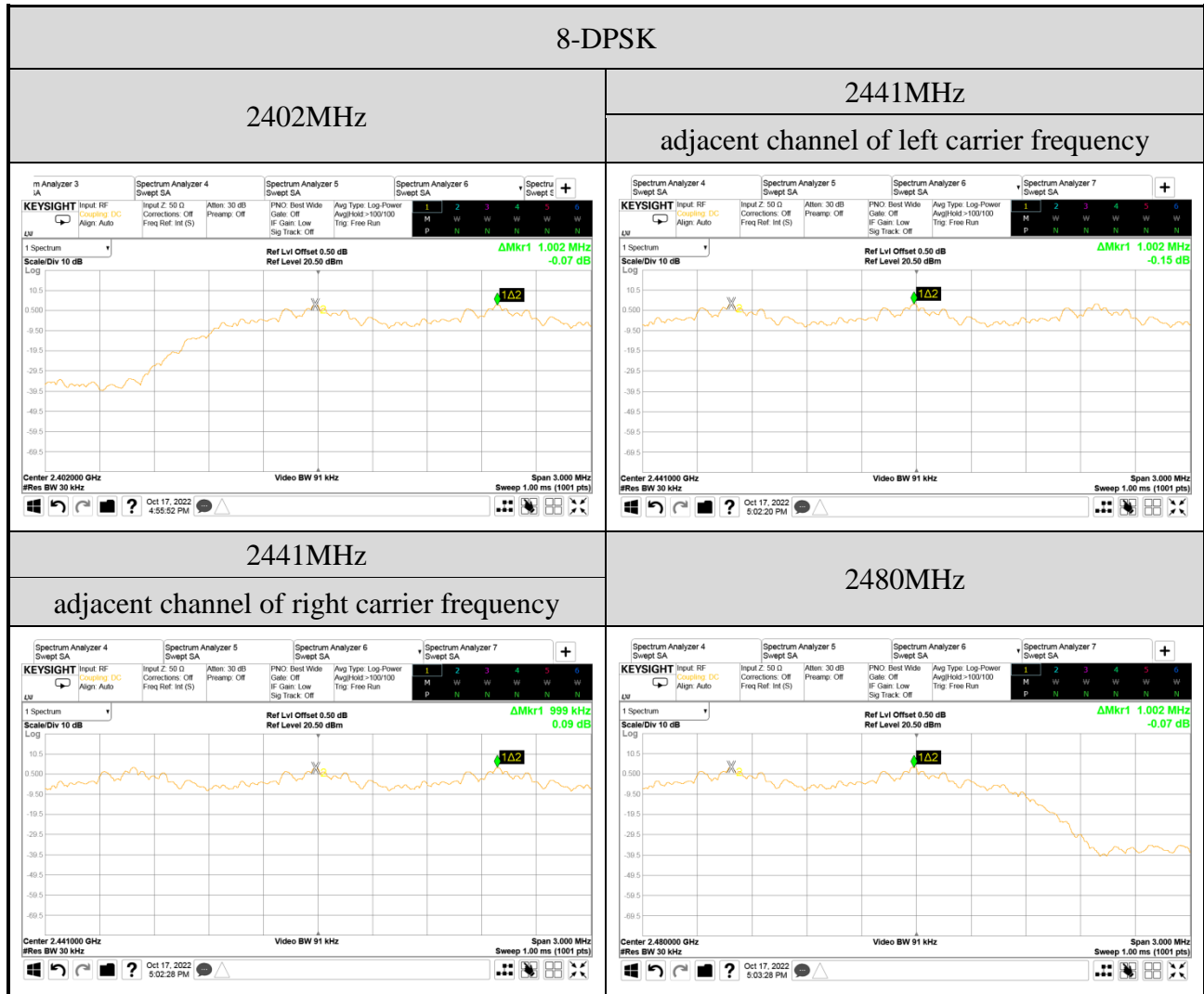

## A.5 TIME OF OCCUPANCY

Test Date	2022/10/17	Temp./Hum.	23°C/76%
Cable Loss	0.5dB	Tested By	Kuper Hsu
Test Voltage	AC 120V 60Hz (Via AC Adapter)		

### A.5.1 Time of Occupancy

Mode	Centre Frequency (MHz)	Mode	Each second appearance transmission	Time of Occupancy (ms)	Maximum accumulated Time of Occupancy (ms)	Limit (ms)
GFSK	2402	DH1	10	0.38	120.080	<400
		DH3	5	1.64	259.120	<400
		DH5	3	2.89	273.972	<400

Observation Period:

$$79 \text{ channels} * 0.4 \text{ seconds} = 31.6 \text{ seconds}$$

#### DH1 Mode

For each second of 10 transmission appearance, the longest time of occupancy is  
 10 transmission \* 31.6 seconds \* 0.380 ms = 120.080 ms (<400ms)

#### DH3 Mode

For each second of 5 transmission appearance, the longest time of occupancy is  
 5 transmission \* 31.6 seconds \* 1.640 ms = 259.120 ms (<400ms)

#### DH5 Mode

For each second of 3 transmission appearance, the longest time of occupancy is  
 3 transmission \* 31.6 seconds \* 2.890 ms = 273.972 ms (<400ms)

Mode	Centre Frequency (MHz)	Mode	Each second appearance transmission	Time of Occupancy (ms)	Maximum accumulated Time of Occupancy (ms)	Limit (ms)
GFSK	2441	DH1	10	0.38	120.080	<400
		DH3	5	1.64	259.120	<400
		DH5	3	2.88	273.024	<400

Observation Period:

$$79 \text{ channels} * 0.4 \text{ seconds} = 31.6 \text{ seconds}$$

#### DH1 Mode

For each second of 10 transmission appearance, the longest time of occupancy is  
 10 transmission \* 31.6 seconds \* 0.380 ms = 120.080 ms (<400ms)

#### DH3 Mode

For each second of 5 transmission appearance, the longest time of occupancy is  
 5 transmission \* 31.6 seconds \* 1.640 ms = 259.120 ms (<400ms)

#### DH5 Mode

For each second of 3 transmission appearance, the longest time of occupancy is  
 3 transmission \* 31.6 seconds \* 2.880 ms = 273.024 ms (<400ms)

Mode	Centre Frequency (MHz)	Mode	Each second appearance transmission	Time of Occupancy (ms)	Maximum accumulated Time of Occupancy (ms)	Limit (ms)
GFSK	2480	DH1	10	0.38	120.080	<400
		DH3	5	1.64	259.120	<400
		DH5	3	2.88	273.024	<400

Observation Period:

**79** channels\* **0.4** seconds= **31.6** seconds

**DH1 Mode**

For each second of **10** transmission appearance,the longest time of occupancy is  
**10** transmission\* **31.6** seconds\* **0.380** ms= **120.080** ms (<400ms)

**DH3 Mode**

For each second of **5** transmission appearance,the longest time of occupancy is  
**5** transmission\* **31.6** seconds\* **1.640** ms= **259.120** ms (<400ms)

**DH5 Mode**

For each second of **3** transmission appearance,the longest time of occupancy is  
**3** transmission\* **31.6** seconds\* **2.880** ms= **273.024** ms (<400ms)

● Measurement Plots

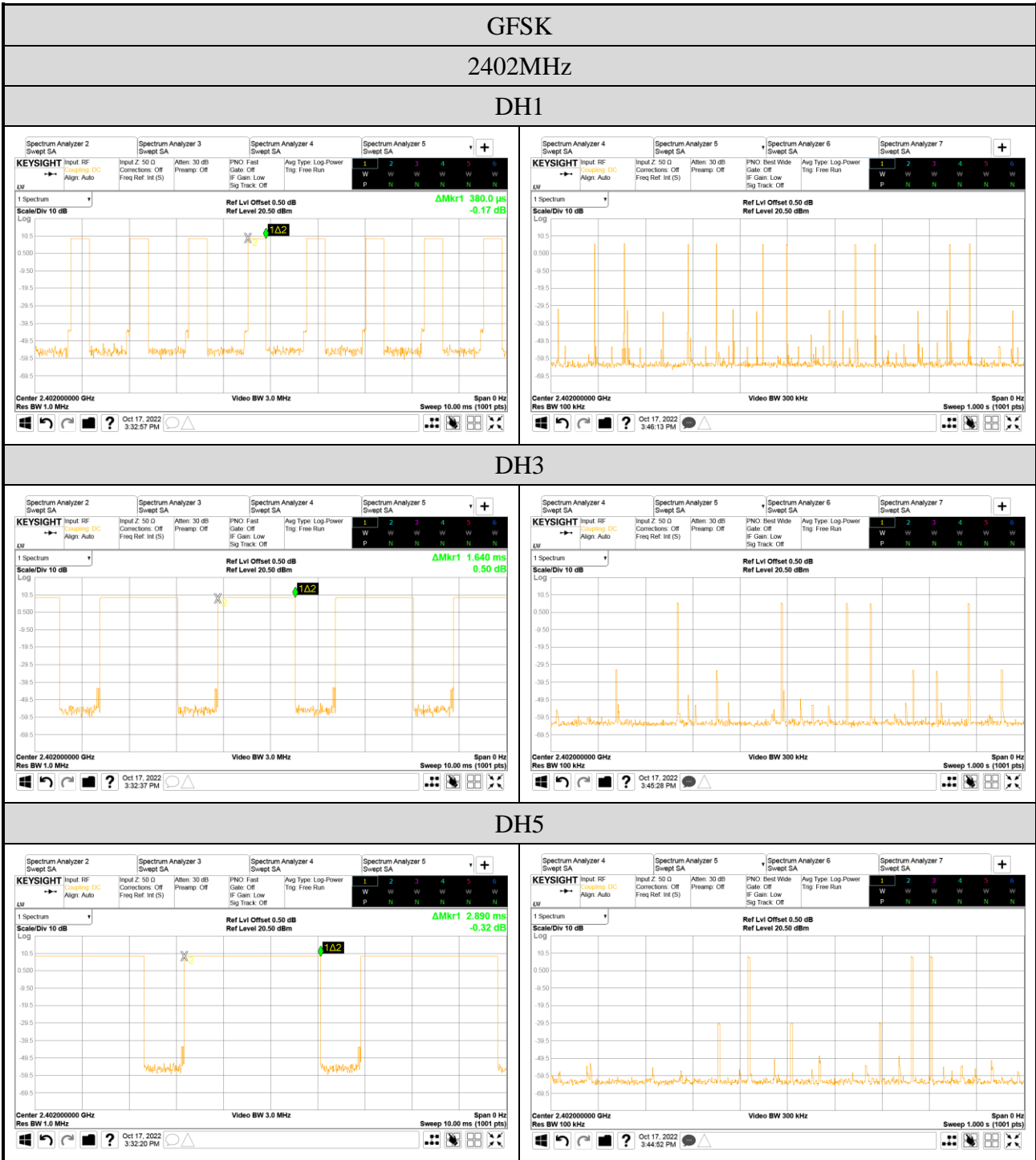

**GFSK**

**2441MHz**

**DH1**

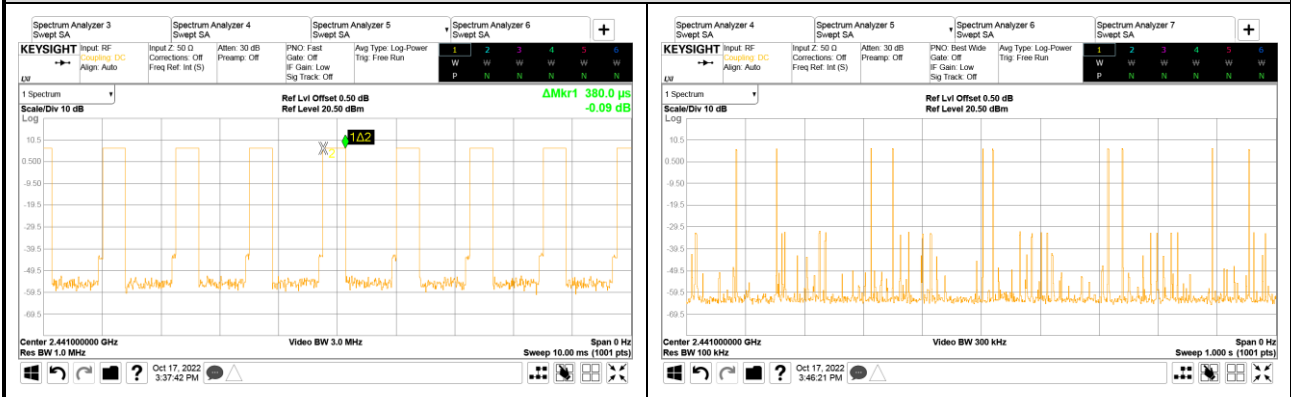

**DH3**

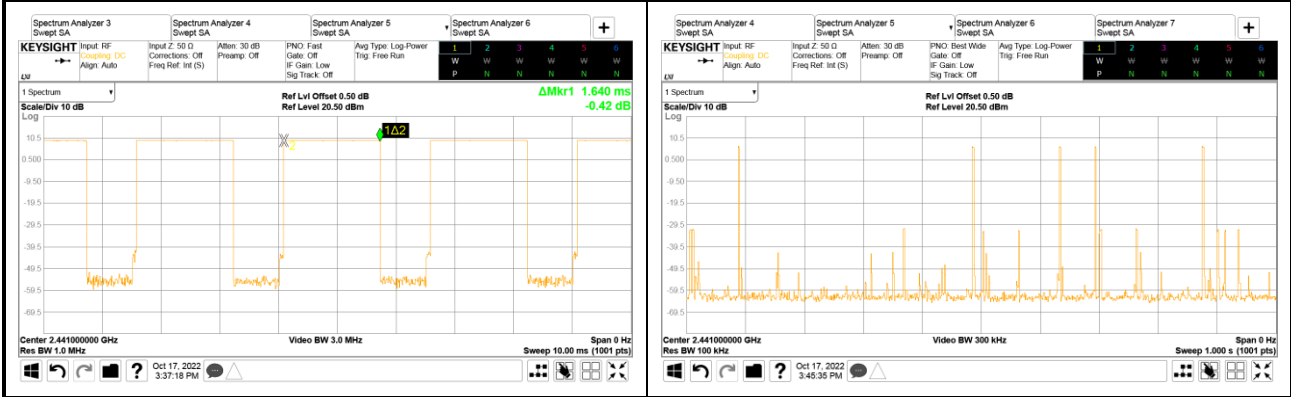

**DH5**



**GFSK**

**2480MHz**

**DH1**

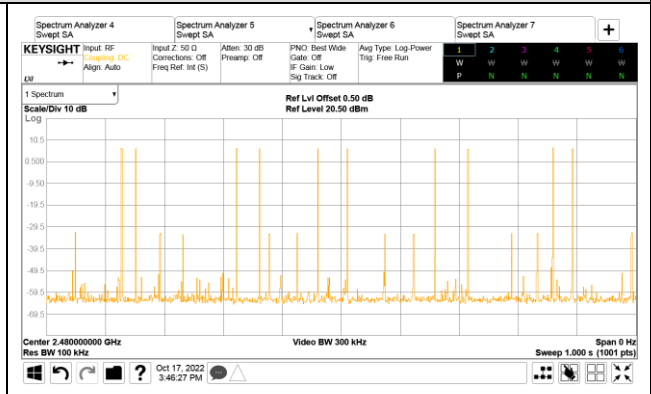

**DH3**

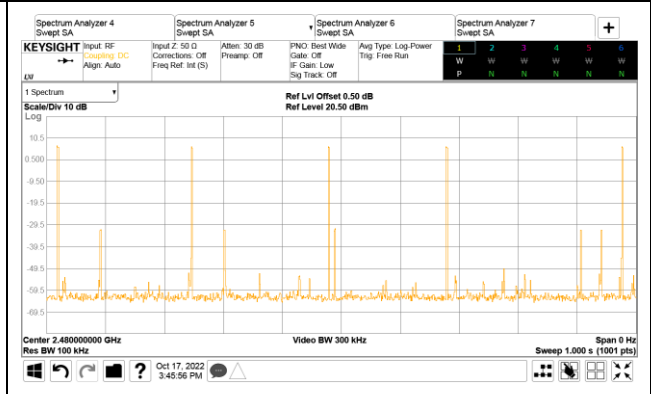
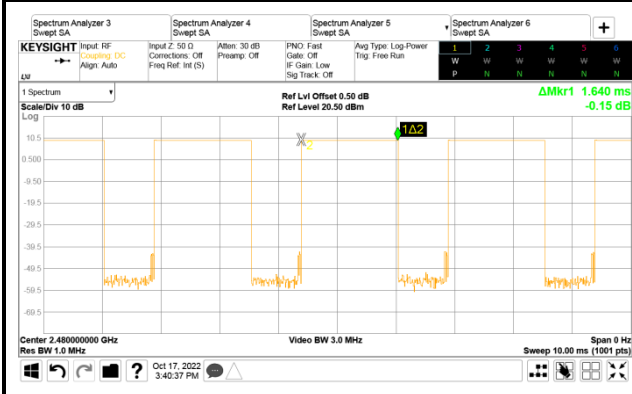

**DH5**

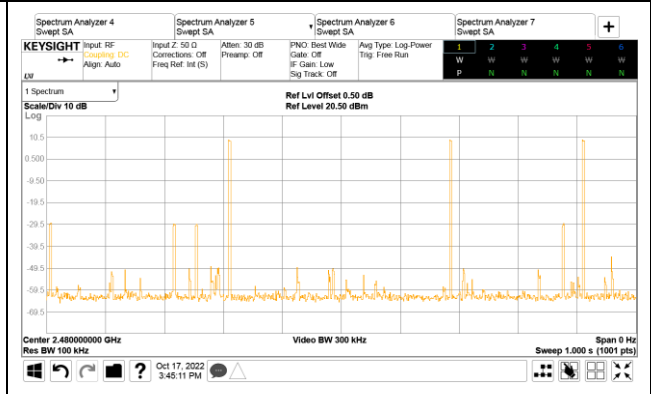
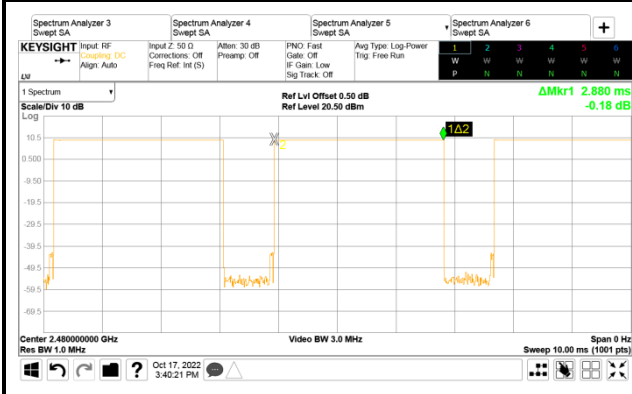



Mode	Centre Frequency (MHz)	Mode	Each second appearance transmission	Time of Occupancy (ms)	Maximum accumulated Time of Occupancy (ms)	Limit (ms)
8-DPSK	2402	3DH1	10	0.39	123.240	<400
		3DH3	5	1.64	259.120	<400
		3DH5	3	2.89	273.972	<400

Observation Period:

$79 \text{ channels} * 0.4 \text{ seconds} = 31.6 \text{ seconds}$

**3DH1 Mode**

For each second of **10** transmission appearance,the longest time of occupancy is  
**10** transmission\* **31.6** seconds\* **0.390** ms= **123.240** ms (<400ms)

**3DH3 Mode**

For each second of **5** transmission appearance,the longest time of occupancy is  
**5** transmission\* **31.6** seconds\* **1.640** ms= **259.120** ms (<400ms)

**3DH5 Mode**

For each second of **3** transmission appearance,the longest time of occupancy is  
**3** transmission\* **31.6** seconds\* **2.890** ms= **273.972** ms (<400ms)

Mode	Centre Frequency (MHz)	Mode	Each second appearance transmission	Time of Occupancy (ms)	Maximum accumulated Time of Occupancy (ms)	Limit (ms)
8-DPSK	2441	3DH1	10	0.39	123.240	<400
		3DH3	5	1.64	259.120	<400
		3DH5	3	2.89	273.972	<400

Observation Period:

$79 \text{ channels} * 0.4 \text{ seconds} = 31.6 \text{ seconds}$

**3DH1 Mode**

For each second of **10** transmission appearance,the longest time of occupancy is  
**10** transmission\* **31.6** seconds\* **0.390** ms= **123.240** ms (<400ms)

**3DH3 Mode**

For each second of **5** transmission appearance,the longest time of occupancy is  
**5** transmission\* **31.6** seconds\* **1.640** ms= **259.120** ms (<400ms)

**3DH5 Mode**

For each second of **3** transmission appearance,the longest time of occupancy is  
**3** transmission\* **31.6** seconds\* **2.890** ms= **273.972** ms (<400ms)

Mode	Centre Frequency (MHz)	Mode	Each second appearance transmission	Time of Occupancy (ms)	Maximum accumulated Time of Occupancy (ms)	Limit (ms)
8-DPSK	2480	3DH1	10	0.39	123.240	<400
		3DH3	5	1.64	259.120	<400
		3DH5	3	2.89	273.972	<400

Observation Period:

$$79 \text{ channels} * 0.4 \text{ seconds} = 31.6 \text{ seconds}$$

**3DH1 Mode**

For each second of **10** transmission appearance, the longest time of occupancy is  
**10** transmission \* **31.6** seconds \* **0.390** ms = **123.240** ms (<400ms)

**3DH3 Mode**

For each second of **5** transmission appearance, the longest time of occupancy is  
**5** transmission \* **31.6** seconds \* **1.640** ms = **259.120** ms (<400ms)

**3DH5 Mode**

For each second of **3** transmission appearance, the longest time of occupancy is  
**3** transmission \* **31.6** seconds \* **2.890** ms = **273.972** ms (<400ms)

● Measurement Plots

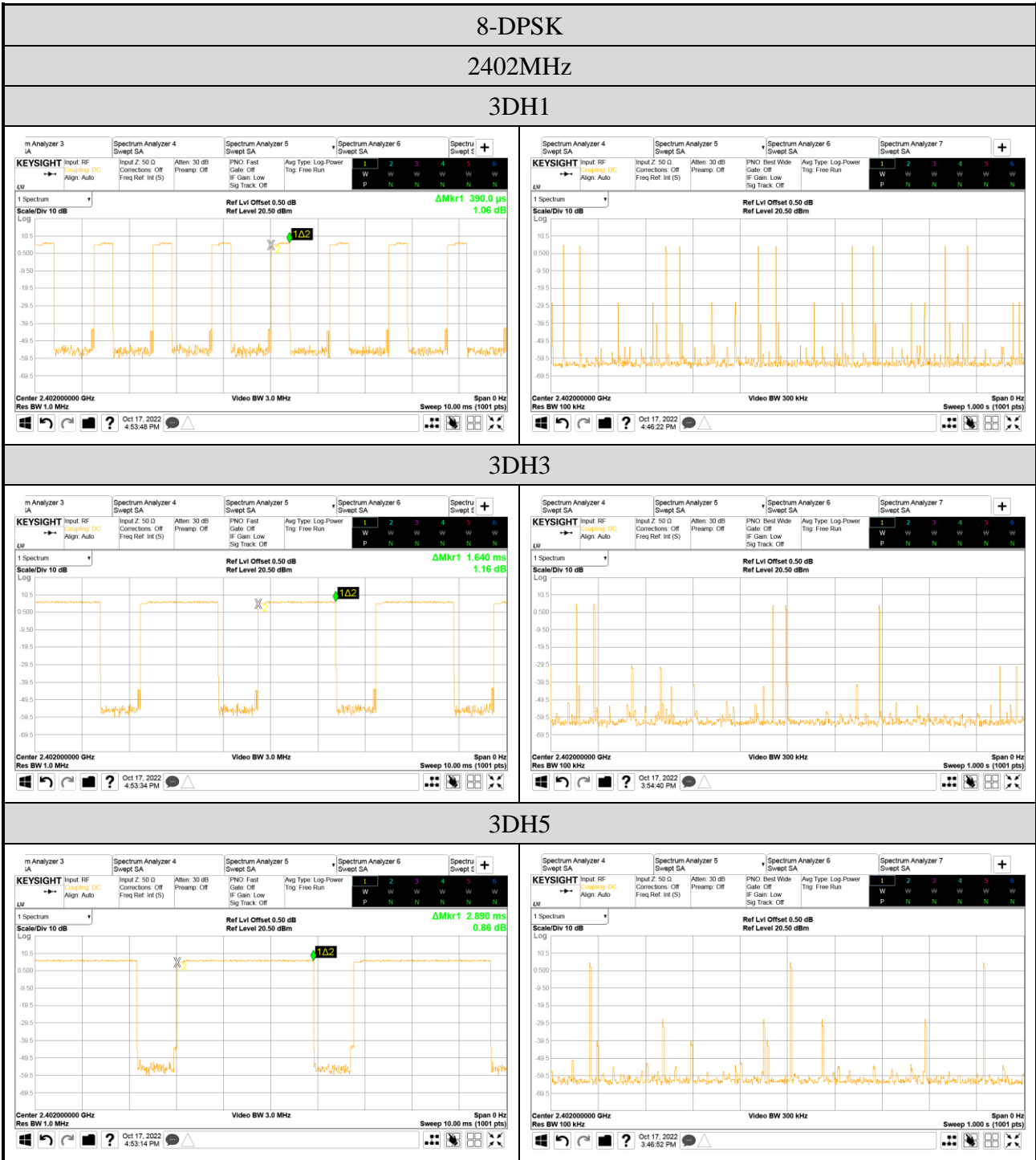

8-DPSK

2441MHz

3DH1

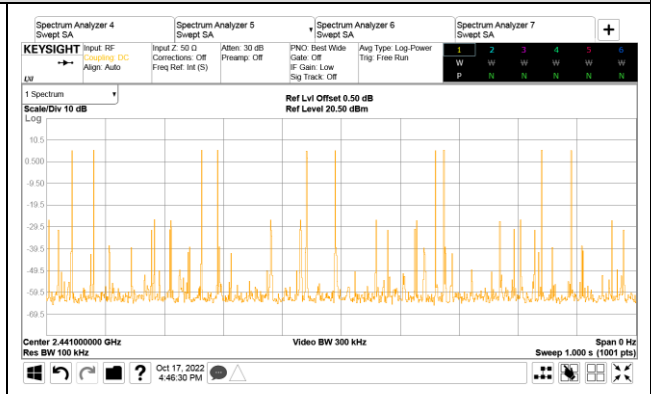
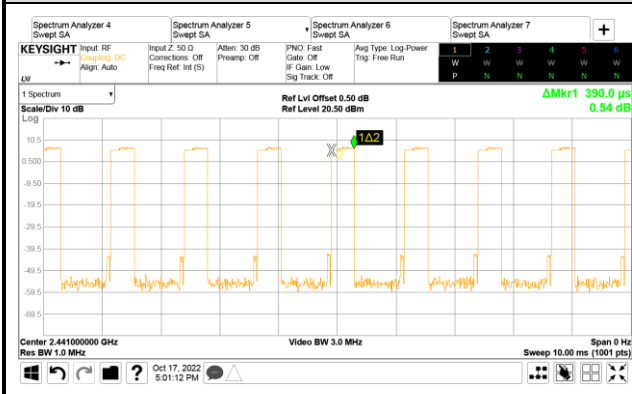

3DH3

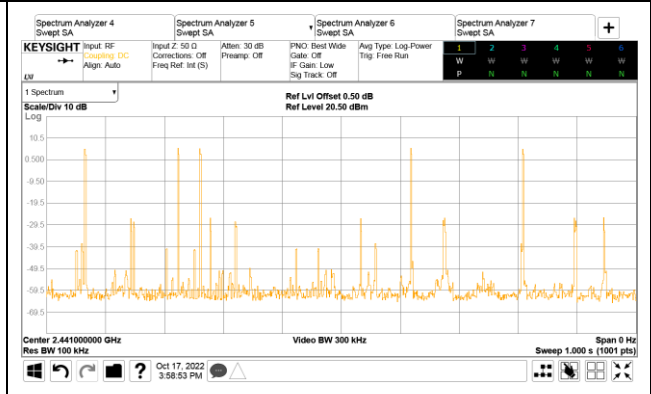
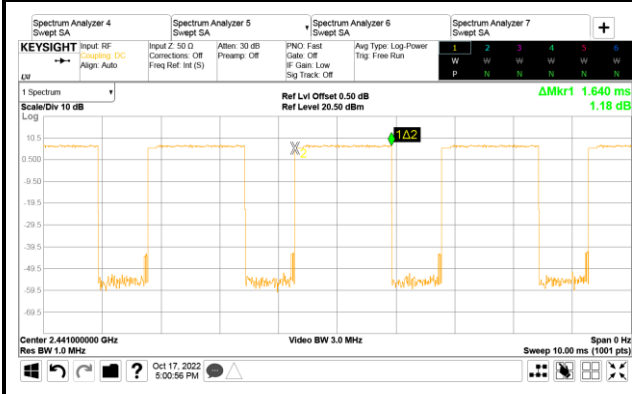

3DH5

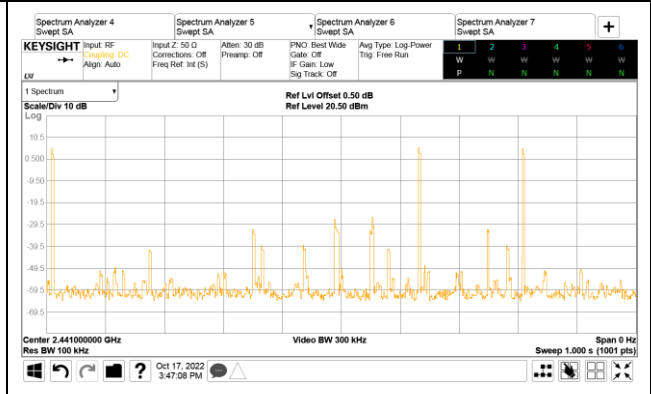
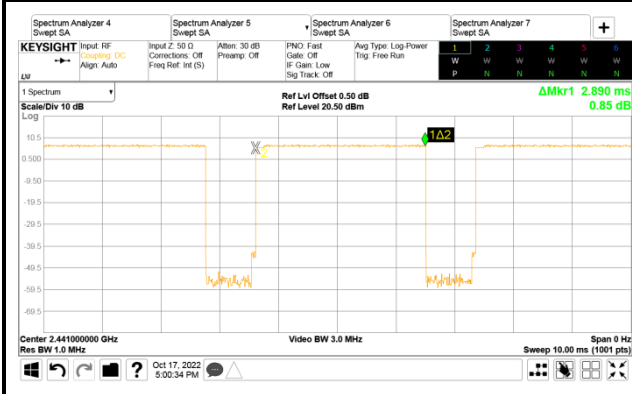

8-DPSK

2480MHz

3DH1

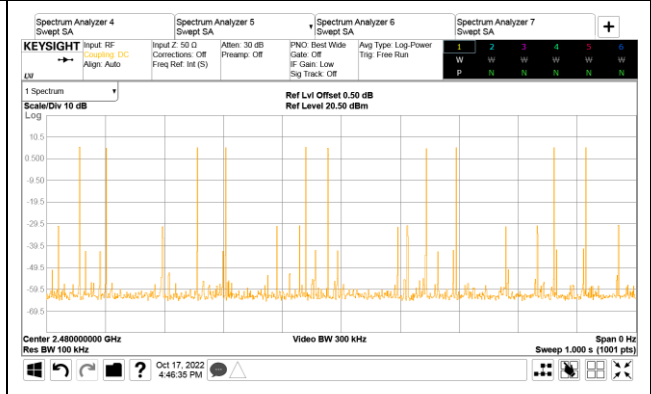
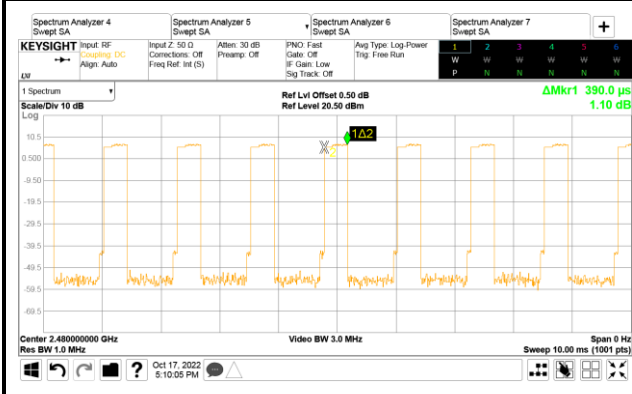

3DH3

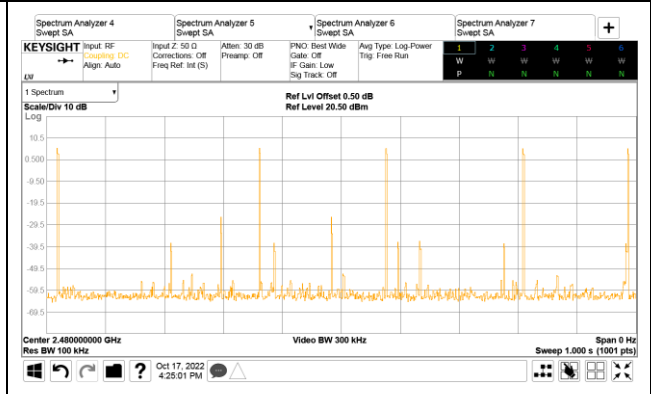
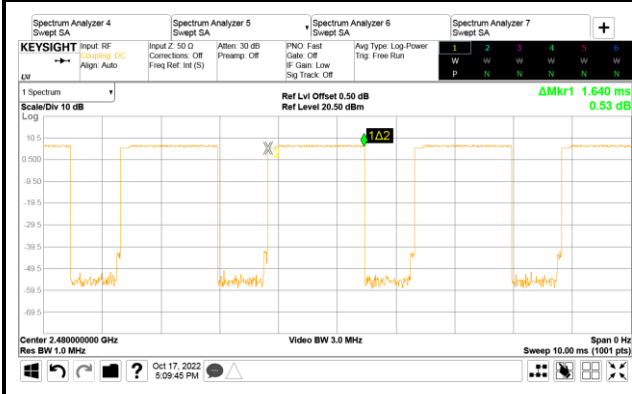

3DH5

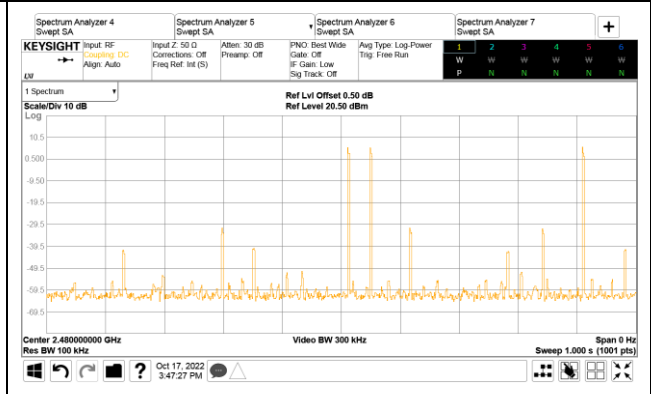
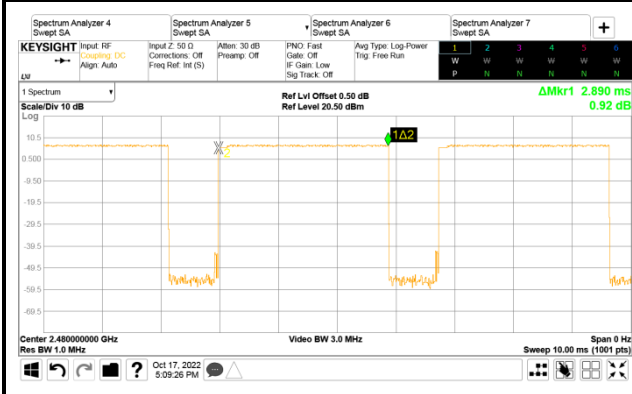

## A.6 NUMBER OF HOPPING CHANNELS

Test Date	2022/10/17	Temp./Hum.	23°C /76%
Cable Loss	0.5dB	Tested By	Kuper Hsu
Test Voltage	AC 120V 60Hz (Via AC Adapter)		

Mode: GFSK	Mode: 8-DPSK
<p>The number hopping channel is 79.</p>	<p>The number hopping channel is 79.</p>

## A.7 MAXIMUM PEAK OUTPUT POWER

Test Date	2022/10/17	Temp./Hum.	23°C/76%
Cable Loss	0.5dB	Tested By	Kuper Hsu
Test Voltage	AC 120V 60Hz (Via AC Adapter)		

### A.7.1 Maximum Peak Output Power

Mode	Centre Frequency (MHz)	Maximum Peak Output Power		Limit
		dBm	W	
GFSK	2402	9.13	0.008	21dBm (0.125W)
	2441	9.49	0.009	
	2480	<b>9.67</b>	<b>0.009</b>	
8-DPSK	2402	7.21	0.005	
	2441	7.62	0.006	
	2480	7.75	0.006	

A.7.2 Measurement Plots

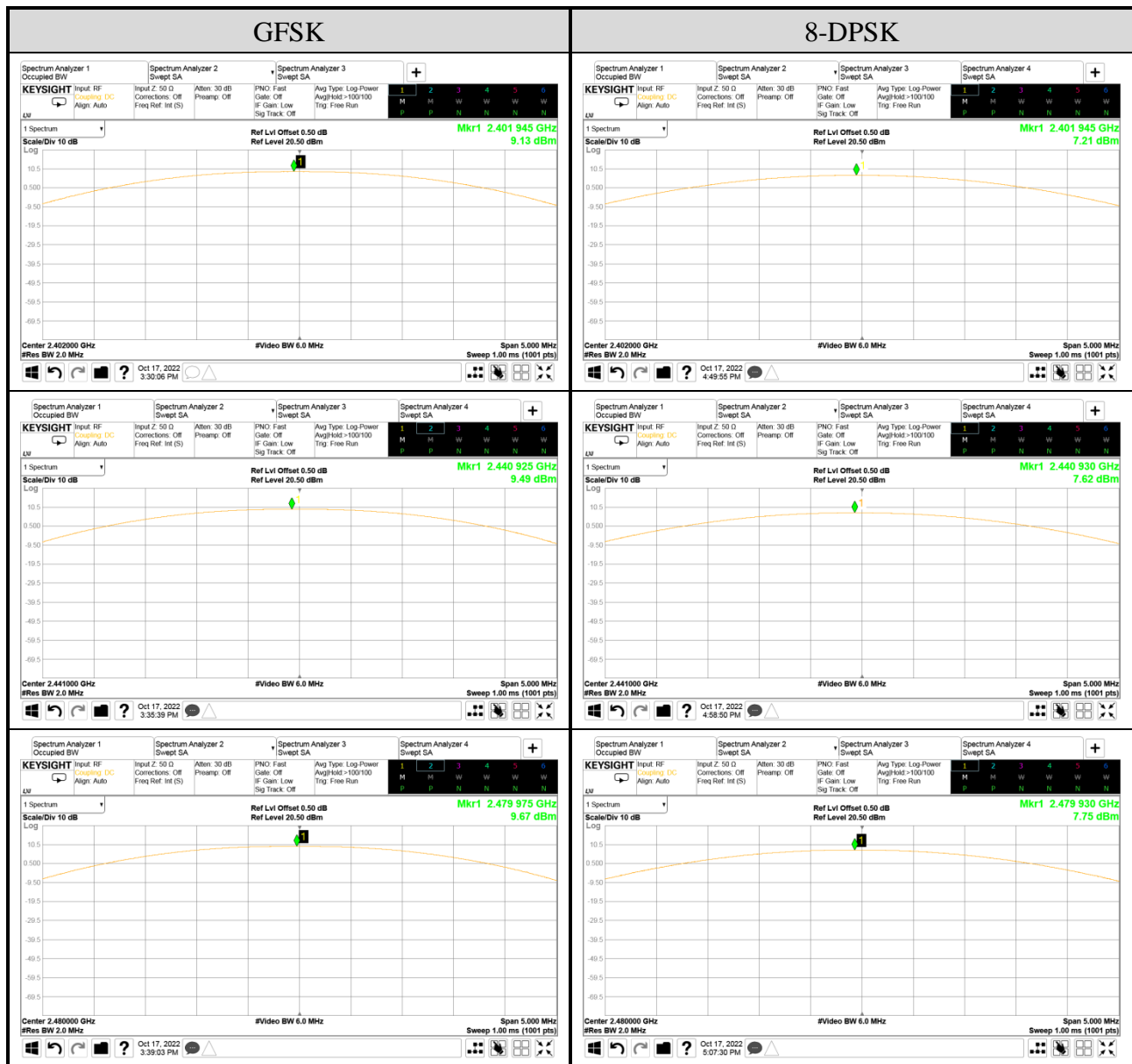



## A.8 EMISSION LIMITATIONS MEASUREMENT

Test Date	2022/10/17	Temp./Hum.	23°C/76%
Cable Loss	0.5dB	Tested By	Kuper Hsu
Test Voltage	AC 120V 60Hz (Via AC Adapter)		

### A.8.1 Band Edge

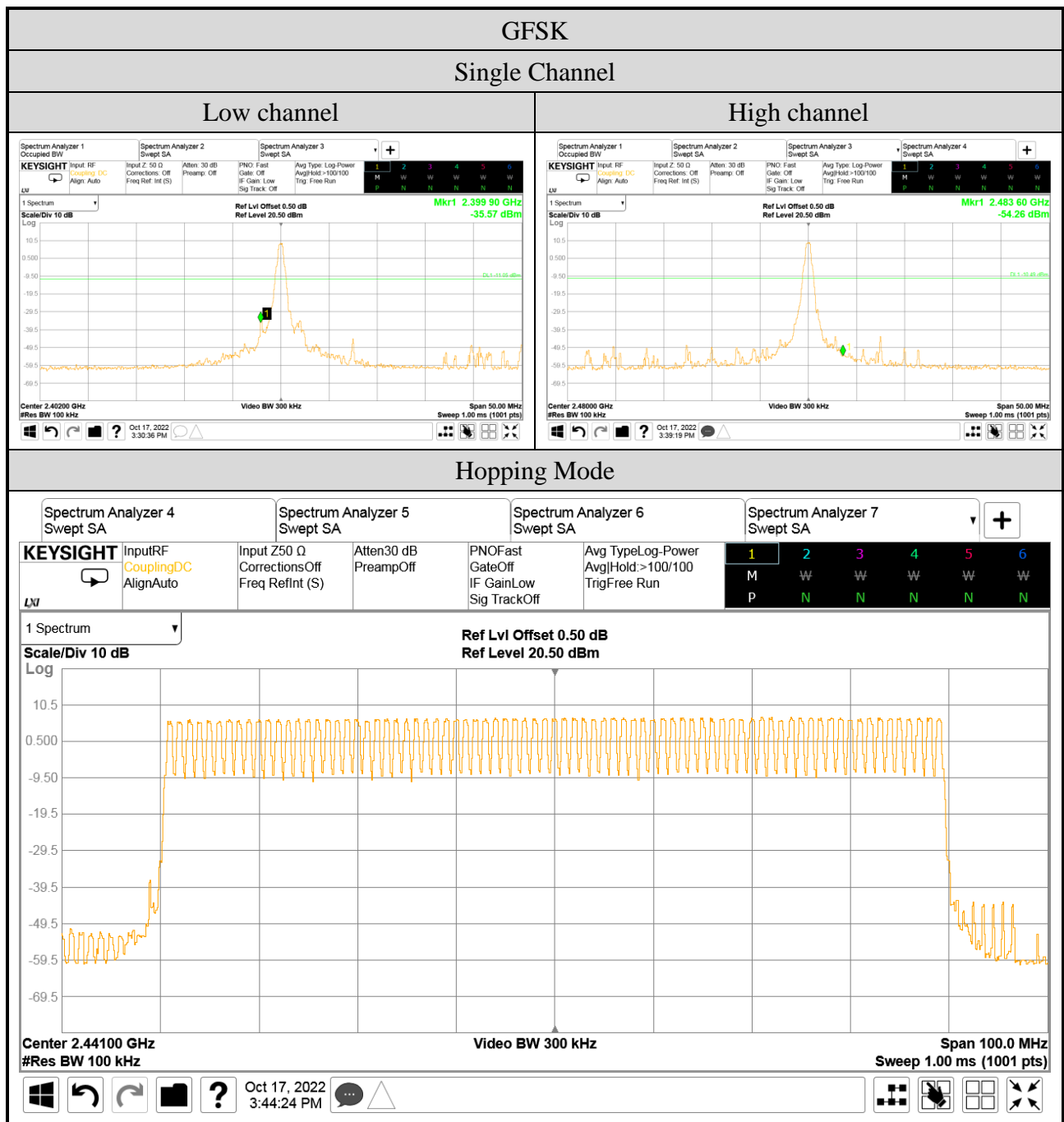

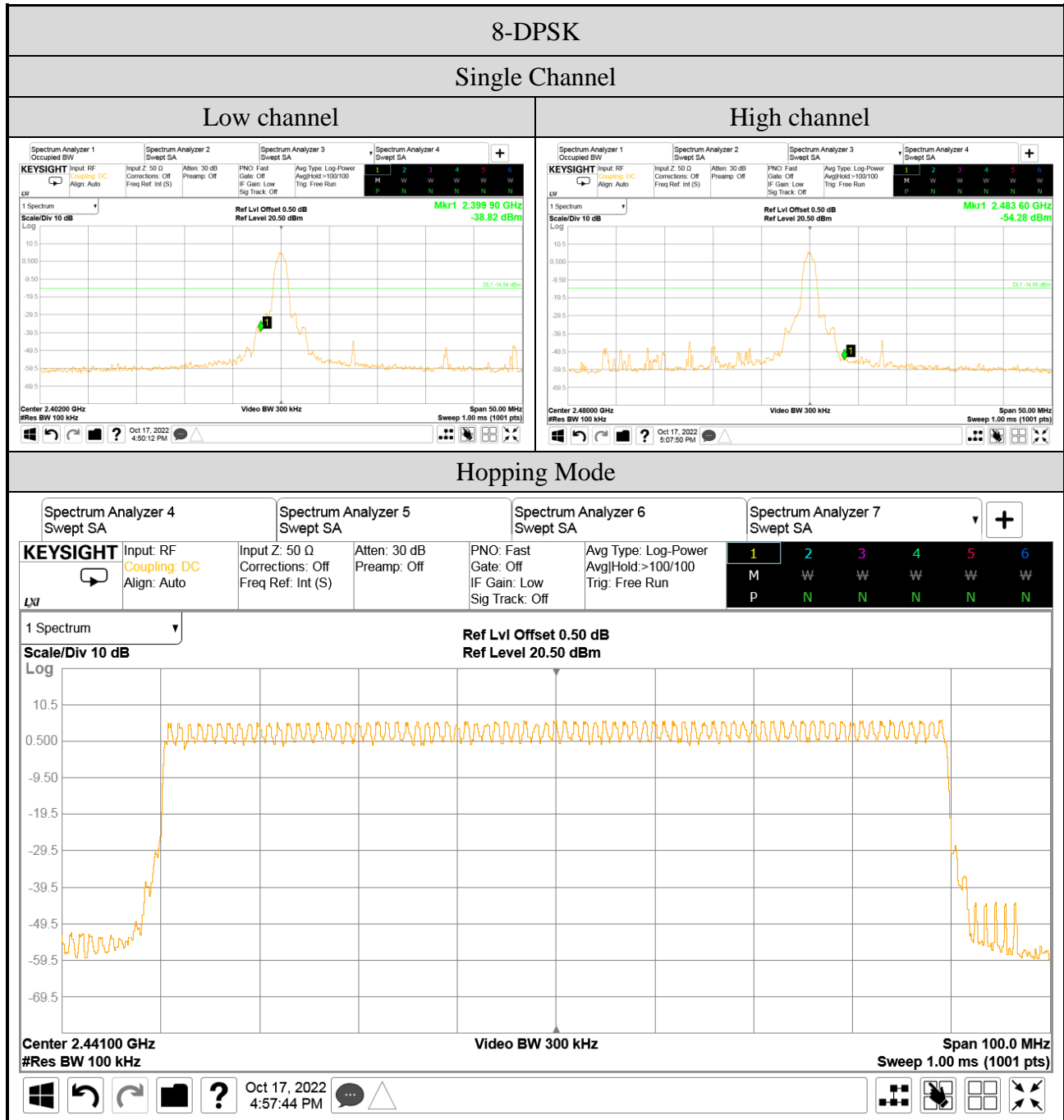

A.8.2 Spurious Emission

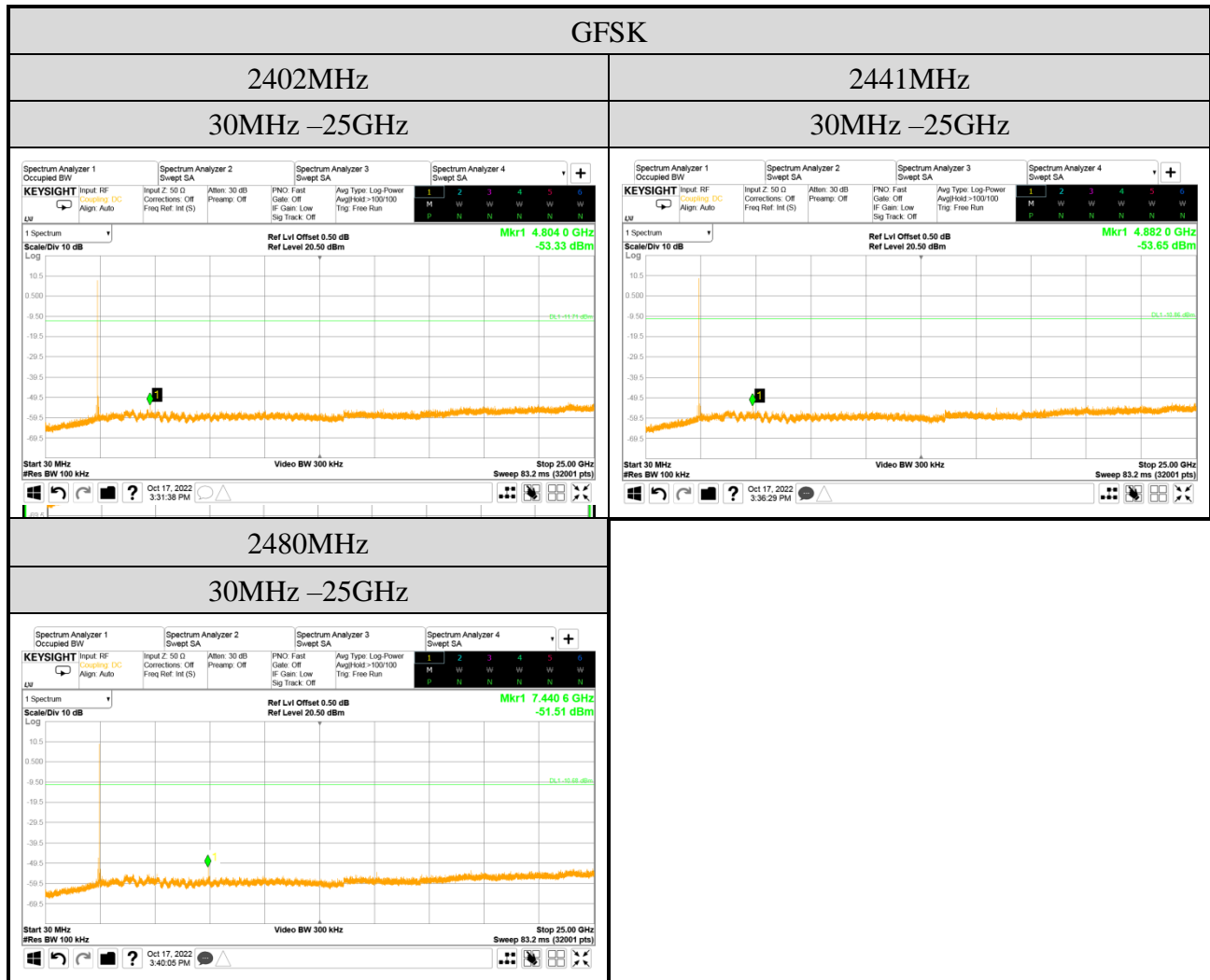

Note: All results have been included cable loss.

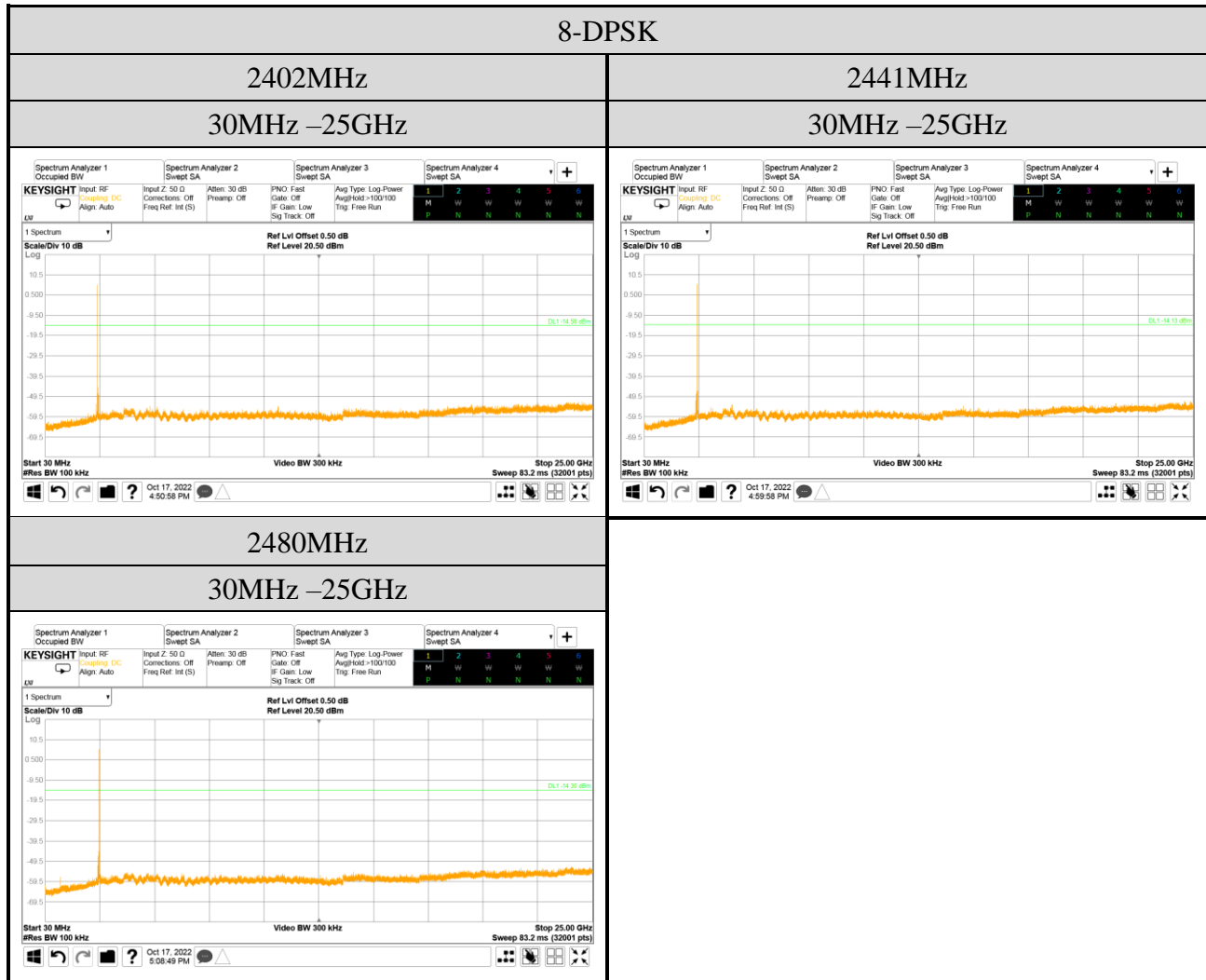

Note: All results have been included cable loss.