

FCC 15.407 U-NII 5GHz Test Report

for

LG Electronics Inc.

**222, LG-ro, Jinwi-myeon Pyeongtaek-Si, Gyeonggi-Do,
17709 Republic of Korea**

Product Name : Notebook Computer
Model Name : (1)14Z90RS (2)14ZD90RS
Brand : LG
FCC ID : BEJNT-14Z90RS

**Prepared by: : AUDIX Technology Corporation,
EMC Department**



The test report is based on a single evaluation of one sample of the above-mentioned products. It does not imply an assessment of the whole production and does not permit the use of the test lab logo.

TABLE OF CONTENTS

Description	Page
TEST REPORT.....	4
1. REVISION RECORD OF TEST REPORT	5
2. SUMMARY OF TEST RESULTS	6
3. GENERAL INFORMATION	7
3.1. Description of Application	7
3.2. Description of EUT	8
3.3. Reference Test Guidance.....	9
3.4. Antenna Information	9
3.5. EUT Specifications Assessed in Current Report	10
3.6. Description of Key Components	13
3.7. Test Configuration.....	15
3.8. Output Power Setting	24
3.9. Tested Supporting System List.....	27
3.10. Setup Configuration.....	27
3.11. Operating Condition of EUT	28
3.12. Description of Test Facility	28
3.13. Measurement Uncertainty	29
4. MEASUREMENT EQUIPMENTLIST.....	30
4.1. Conducted Emission Measurement	30
4.2. Radiated Emission Measurement	31
4.3. RF Conducted Measurement	31
5. CONDUCTED EMISSION.....	32
5.1. Block Diagram of Test Setup	32
5.2. Conducted Emission Limit	32
5.3. Test Procedure	32
5.4. Test Results	32
6. RADIATED EMISSION	33
6.1. Block Diagram of Test Setup	33
6.2. Radiated Emission Limits.....	34
6.3. Test Procedure	36
6.4. Measurement Result Explanation.....	37
6.5. Test Results	37
7. EMISSION/OCCUPIED BANDWIDTH.....	38
7.1. Block Diagram of Test Setup	38
7.2. Specification Limits.....	38
7.3. Test Procedure	38
7.4. Test Results	39
8. MAXIMUM OUTPUT POWER	40
8.1. Block Diagram of Test Setup	40
8.2. Specification Limits.....	40
8.3. Test Procedure	41
8.4. Test Results	41
9. POWER SPECTRAL DENSITY	42
9.1. Block Diagram of Test Setup	42



Audix Technology Corp.
No. 491, Zhongfu Rd., Linkou Dist.,
New Taipei City 244, Taiwan

Tel: +886 2 26099301
Fax: +886 2 26099303

9.2. Specification Limits.....	42
9.3. Test Procedure	42
9.4. Test Results	42
10. FREQUENCY STABILITY	43
10.1. Block Diagram of Test Setup	43
10.2. Specification Limits.....	43
10.3. Test Procedure	43
10.4. Test Results	43
11. DEVIATION TO TEST SPECIFICATIONS	44

APPENDIX A TEST DATA AND PLOTS
APPENDIX B TEST PHOTOGRAPHS

TEST REPORT

Applicant : LG Electronics Inc.
Manufacturer : LG Electronics Inc.
Factory : LG Electronics Nanjing New Technology Co., Ltd.
EUT Description
(1) Product : Notebook Computer
(2) Model : (1)14Z90RS (2)14ZD90RS
(3) Brand : LG
(4) Power Supply: DC 20V, 3.25A

Applicable Standards:

Title 47 FCC CFR Part 15 Subpart E

Audix Technology Corp. tested the equipment mentioned in accordance with the requirements set forth in the above standards. Test results indicate that the equipment tested is capable of demonstrating compliance with the requirements as documented within this report.

Audix Technology Corp. does not assume responsibility for any conclusions and generalizations drawn from the test results with regard to other specimens and samples.

Date of Report: 2022. 11. 18

Reviewed by:

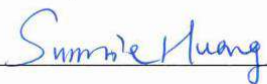

(Sunnie Huang/Administrator)

Approved by:

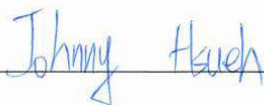

(Johnny Hsueh/Section Manager)

1. REVISION RECORD OF TEST REPORT

Edition No	Issued Date	Revision Summary	Report Number
0	2022. 11. 18	Original Report	EM-F220771

2. SUMMARY OF TEST RESULTS

Rule	Description	Results
15.207	Conducted Emission	PASS
15.205/15.209	Undesirable Emissions Limits: Radiated Band Edge and Radiated Spurious Emission	PASS
15.407(a)(5)/15.407(e)	Emission/Occupied Bandwidth	PASS
15.407(a)	Maximum Output Power	PASS
15.407(b)	Conducted Band Edges	N/A
15.407(a)	Power Spectral Density	PASS
15.407	Frequency Stability	PASS
15.407(h)(2)	Dynamic Frequency Selection(DFS)	PASS, Please refer to test report No. EM-F220772
15.203	Antenna Requirement	Compliance

Note: The uncertainties value is not used in determining the result.

3. GENERAL INFORMATION

3.1. Description of Application

Applicant	LG Electronics Inc. 222, LG-ro, Jinwi-myeon Pyeongtaek-Si, Gyeonggi-Do, 17709 Republic of Korea
Manufacturer	LG Electronics Inc. 222, LG-ro, Jinwi-myeon Pyeongtaek-Si, Gyeonggi-Do, 17709 Republic of Korea
Factory	LG Electronics Nanjing New Technology Co., Ltd. No.346, Yaoxin Road, Economic & Technical Development Zone, Nanjing, China.
Product	Notebook Computer
Model	(1)14Z90RS (2)14ZD90RS The difference between all models is different in the sales customers and color difference.
Brand	LG

3.2. Description of EUT

Test Model	14Z90RS		
Serial Number	N/A		
Power Rating	DC 20V, 3.25A		
Software Version	XY (X, Y can be 0 to 9 for different SW version not influence RF parameter)		
RF Features	WLAN:802.11 a/b/g/n/ac/ax Bluetooth: BT and BLE (BT 5.1)		
Transmit Type	2.4 GHz		
	802.11b		1T1R
	802.11g		1T1R
	802.11n-HT20		2T2R
	802.11n-HT40		2T2R
	802.11ax-HE20		2T2R
	802.11ax-HE40		2T2R
	BT/BLE		1T1R
	U-NII Bands		
	802.11a		1T1R
	802.11n-HT20/802.11ac-VHT20/802.11ax-HE20		2T2R
	802.11n-HT40/802.11ac-VHT40/802.11ax-HE40		2T2R
	802.11ac-VHT80/802.11ax-HE80		2T2R
	802.11ac-VHT160/802.11ax-HE160		2T2R
	The MIMO is uncorrelated and supported SDM mode only.		
Device Category	<input type="checkbox"/> Outdoor Access Point <input type="checkbox"/> Fixed point-to-point Access Point <input type="checkbox"/> Indoor Access Point <input checked="" type="checkbox"/> Mobile and Portable client device		
Test Sample	Sample No.	Test Item	Firmware
	02	AC Conduction, RSE, RF Conducted	N/A
Sample Status	Trial sample		
Date of Receipt	2022. 10. 13		
Date of Test	2022. 10.17 ~ 11. 10		
Interface Ports of EUT	<ul style="list-style-type: none"> • Two USB Type C Ports • One Earphone Port • One Micro SD Card Slot • One USB 3.2 Port 		
Accessories Supplied	<ul style="list-style-type: none"> • AC Adapter • USB C Cable • LAN Gender 		

3.3. Reference Test Guidance

KDB 789033 D02 General UNII Test Procedures New Rules v02r01
 KDB 662911 D01 Multiple Transmitter Output v02r01
 ANSI C63.10:2013

3.4. Antenna Information

No.	Antenna Part Number	Manufacture	Antenna Type	Frequency (MHz)	Max Gain(dBi)	
					AUX	Main
1.	WA-P-LELE-04-033	INPAQ	Mono-Pole	2400	3.8	3.1
				2450	3.9	3.7
				2500	4.1	3.2
				5150	2.5	1.9
				5400	1.0	2.8
				5850	1.2	1.4
				5925	1.7	1.5
				6525	0.2	-0.4
				7125	2.9	3.8

According to KDB 662911 D01 d) ii), transmit signals are completely uncorrelated, then
 Directional gain = $10 \log[(10^{G1/10} + 10^{G2/10} + \dots + 10^{GN/10})/N_{ANT}]$ dBi
 Note 1. 2.4G: Directional gain =
 2400MHz: Directional gain = $10 \log[(10^{3.8/10} + 10^{3.1/10})/2] = 3.46$ dBi
 2450MHz: Directional gain = $10 \log[(10^{3.9/10} + 10^{3.7/10})/2] = 3.80$ dBi
 Note 2. 5G: Directional gain =
 5150MHz: $= 10 \log[(10^{2.5/10} + 10^{1.9/10})/2] = 2.21$ dBi
 5400MHz: $= 10 \log[(10^{1.0/10} + 10^{2.8/10})/2] = 1.99$ dBi
 5850MHz: $= 10 \log[(10^{1.2/10} + 10^{1.4/10})/2] = 1.30$ dBi
 Note 3. UNII Band (WLAN 6G):
 5925MHz: Directional gain = $10 \log[(10^{1.7/10} + 10^{1.5/10})/2] = 1.60$ dBi
 6525MHz: Directional gain = $10 \log[(10^{0.2/10} + 10^{-0.4/10})/2] = -0.09$ dBi
 7125MHz: Directional gain = $10 \log[(10^{2.9/10} + 10^{3.8/10})/2] = 3.37$ dBi
 We chose the antenna gain corresponding to the frequency listed on the table which is closer to center frequency of WLAN.

3.5. EUT Specifications Assessed in Current Report

Mode	U-NII Band	Fundamental Range (MHz)	Channel Number
802.11a	1	5180-5240	4
	2A	5260-5320	4
	2C	5500-5720	12
	3	5745-5825	5
802.11n-HT20/ 802.11ac-VHT20 802.11ax-HE20	1	5180-5240	4
	2A	5260-5320	4
	2C	5500-5720	12
	3	5745-5825	5
802.11n-HT40/ 802.11ac-VHT40 802.11ax-HE40	1	5190-5230	2
	2A	5270-5310	2
	2C	5510-5710	6
	3	5755-5795	2
802.11ac-VHT80 802.11ax-HE80	1	5210	1
	2A	5290	1
	2C	5530-5690	3
	3	5775	1
802.11ac-VHT160 802.11ax-HE160	1	5250	1
	2A		
	2C	5570	1
Remark: U-NII Band 2A and 2C (DFS Function, Slave/no In service monitor, no Ad-Hoc mode)			

Mode	Modulation	Data Rate (Mbps)
802.11a	OFDM (BPSK/QPSK/16QAM/64QAM)	Up to 54
802.11n-HT20	OFDM (BPSK/QPSK/16QAM/64QAM)	Up to 144.4
802.11n-HT40		Up to 300
802.11ac-VHT20	OFDM (BPSK/QPSK/16QAM/64QAM/256QAM)	Up to 173.3
802.11ac-VHT40		Up to 400
802.11ac-VHT80		Up to 866.7
802.11ac-VHT160		Up to 1733.3
802.11ax-HE20	OFDMA (BPSK/ QPSK/ 16QAM/ 64QAM/ 256QAM/1024QAM)	Up to 287
802.11ax-HE40		Up to 574
802.11ax-HE80		Up to 1201
802.11ax-HE160		Up to 2402

Channel List					
802.11a/802.11n-HT20/802.11ac-VHT20/802.11ax-HE20					
U-NII Band	Channel Number	Frequency (MHz)	U-NII Band	Channel Number	Frequency (MHz)
1	36	5180	2C	120	5600
	40	5200		124	5620
	44	5220		128	5640
	48	5240		132	5660
2A	52	5260		136	5680
	56	5280		140	5700
	60	5300		144	5720
	64	5320		149	5745
2C	100	5500	3	153	5765
	104	5520		157	5785
	108	5540		161	5805
	112	5560		165	5825
	116	5580			

Channel List					
802.11n-HT40/802.11ac-VHT40/802.11ax-HE40					
U-NII Band	Channel Number	Frequency (MHz)	U-NII Band	Channel Number	Frequency (MHz)
1	38	5190	2C	118	5590
	46	5230		126	5630
2A	54	5270		134	5670
	62	5310		142	5710
2C	102	5510	3	151	5755
	110	5550		159	5795

Channel List					
802.11ac-VHT80/802.11ax-HE80					
U-NII Band	Channel Number	Frequency (MHz)	U-NII Band	Channel Number	Frequency (MHz)
1	42	5210	2C	138	5690
2A	58	5290	3	155	5775
2C	106	5530			
	122	5610			

Channel List					
802.11ac-VHT160/802.11ax-HE160					
U-NII Band	Channel Number	Frequency (MHz)	U-NII Band	Channel Number	Frequency (MHz)
1	50	5250	2C	114	5570
2A					

Note: Test modes are presented at section 3.7.

3.6. Description of Key Components

3.6.1. For the All Component Lists

Item	Supplier	Model / Type	Character
System	Microsoft	Win 10	---
		Win 10 Pro	
		Win11 Home	
Main Board	LG	ROYAL MAIN B/D	Manufacturer: #1 Hannstar Board Tech (Jiang Yin) Corp.,Ltd. #2 Elec&Eltek Company (MCO) Limited.
WLAN SUB Board	LG	14Z90RS SUB B/D	Manufacturer: #1 HannstarBoardTech(Jiang Yin)Corp.,Ltd. #2JiangSuHuaShen Electronic co.,ltd (HXF) #3 Elec&Eltek Company (MCO) Limited.
CPU (Socket: BGA1744)	Intel	i7-1360P	2.2GHz
	Intel	i5-1340P	1.9GHz
14" LCD Panel	Samsung	ATNA40YK10-0	Resolution: 2880 x 1800, 60/90Hz (WQXGA)
Storage (SSD)	SK hynix	---	256GB
		---	512GB
		---	1TB
		---	2TB
	Samsung	---	128GB
		---	256GB
		---	512GB
		---	1TB
---	---	2TB	
Memory (RAM)	Samsung	---	16GB LPDDR5x(On Board)
		---	8GB LPDDR5x(On Board)
		---	32GB LPDDR5x(On Board)
	SK Hynix	---	16GB LPDDR5x(On Board)
		---	8GB LPDDR5x(On Board)
		---	32GB LPDDR5x(On Board)
Battery Pack	LG	LBZ722DM	DC 7.76V,72Wh
WLAN Combo Card	Intel	AX211D2W	WLAN and BT, 2x2 PCIe M.2 1216 SD adapter card FCC ID: PD9AX211D2 IC: 1000M-AX211D2
WLAN Combo Antenna	LG (INPAQ)	WA-P-LELE-04-033	PCB, Mono-pole Type Main: Black, Aux: Gray

Item	Supplier	Model / Type	Character
Keyboard	TIC	KT0120B7	---
	LITE ON	SN8B00	---
Touch Pad	Taifang	TF100AP02001	---
Web Camera	Chicony	CKFLF26(2Mic)	---
	Luxvisions	1BF225N3(2Mic)	---
LAN Gender (Type C to LAN)	SUZHOU MEC ELECTRONICS	80-5946-111	10/100 Megabit Ethernet
		80-5946-230	10/100/1000 Megabit Ethernet
	ARIN TECH CO. LTD	GD-08MF-36-WH-LP10	10/100 Megabit Ethernet
		GD-08MF-36-WH-LP12	10/100/1000 Megabit Ethernet
	HUIZHOU DEHONG TECHNOLOGY CO.,LTD.	370-50713	10/100 Megabit Ethernet
	Type C to LAN: Shielded, Undetached, 0.12m		
AC Adapter	LG (PI ELECTRONICS)	LP65WFC20P-NJ W	I/P: AC 100-240V, 1.6A, 50-60Hz O/P:DC 5V,3A(15W) or DC 9V, 3A(27W)or DC 15V,3A (45W) or DC 20V,3.25A (65W) (US Type, Wall-mount)
		Type C Cable, Shielded, Undetached, 2.0m	

Remark: For more detailed features description, please refer to the manufacturer's specifications or the user manual.

3.6.2. The EUT collocates with following worst components, which are used to establish a basic configuration of system during test:

SKU (Mode) 1			
Main Board	LG, ROYAL MAIN B/D		
SUB Board	LG, 14Z90RS SUB B/D		
CPU	Intel, i7-1360P		
14" LCD Panel	Samsung, ATNA40YK10-0		
Storage (SSD)	Samsung, 2TB		
	Samsung, 256GB		
Memory (RAM)	32GB		
Battery Pack	LG, 75Wh		
Keyboard	TIC, KT0120B7		
Touch Pad	Taifang, TF100AP02001		
Web Camera	Chicony, CKFLF26		
WLAN Combo Card	Intel, AX211D2W		
WLAN Combo Antenna	LG (INPAQ), WA-P-LELE-04-033		
Type C #1	AC Adapter	LG (PI ELECTRONICS), LP65WFC20P-NJ W	
Type C #2	Link to LAN Gender	MEC	10/100/1000Mbps

3.7. Test Configuration

Mode	TX _{on} (ms)	TX _{on+off} (ms)	Duty Cycle (x)	Duty Cycle Factor [10log(1/x)] (dB)
802.11a	2.09	2.13	0.981	N/A
802.11n-HT20	4.00	4.03	0.993	N/A
802.11n-HT40	3.99	4.03	0.990	N/A
802.11ac-VHT80	3.97	4.01	0.990	N/A
802.11ac-VHT160	2.79	2.83	0.986	N/A
802.11ax-HE20	3.99	4.03	0.990	N/A
802.11ax-HE40	3.98	4.02	0.990	N/A
802.11ax-HE80	3.98	4.02	0.990	N/A
802.11ax-HE160	2.29	2.33	0.983	N/A
802.11ax-HE20 (RU Config 26)	0.75	0.78	0.962	0.168
802.11ax-HE20 (RU Config 52)	1.46	1.5	0.973	0.119
802.11ax-HE20 (RU Config 106)	3.04	3.07	0.990	N/A
802.11ax-HE40 (RU Config 242)	1.42	1.46	0.973	0.119
802.11ax-HE80 (RU Config 484)	2.78	2.82	0.986	N/A
802.11ax-HE160 (RU Config 996)	1.33	1.38	0.964	0.159

Note: When duty cycle is less than 98% (0.98) that duty cycle factor 10log(1/x) is needed to add in conducted test items measured in average detector.

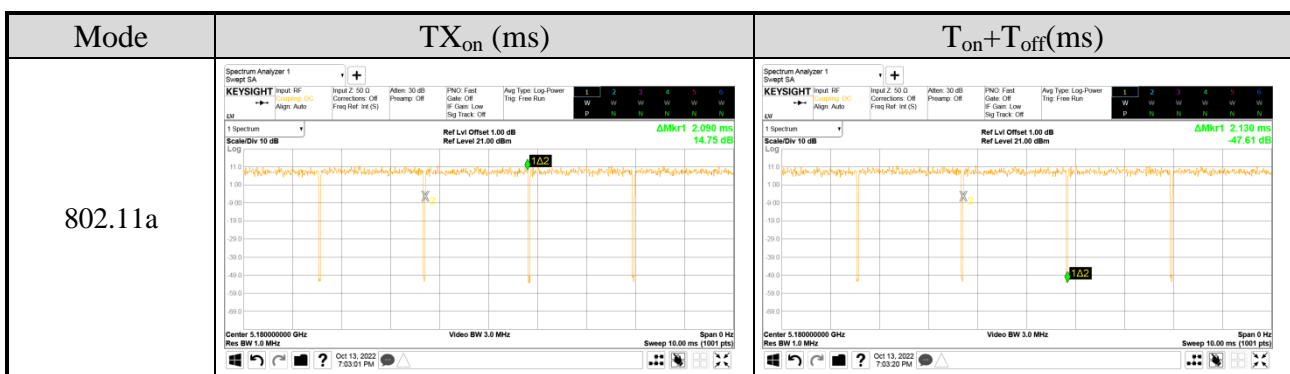

Mode	TX _{on} (ms)	T _{on} +T _{off} (ms)
802.11n-HT20		
802.11n-HT40		
802.11ac-VHT80		
802.11ac-VHT160		

Mode	TX _{on} (ms)	T _{on} +T _{off} (ms)
802.11ax-HE20	<p>Center: 5.18000000 GHz Res BW: 1.0 MHz Video BW: 3.0 MHz Sweep: 10.00 ms (1001 pts)</p>	<p>Center: 5.18000000 GHz Res BW: 1.0 MHz Video BW: 3.0 MHz Sweep: 10.00 ms (1001 pts)</p>
802.11ax-HE40	<p>Center: 5.19000000 GHz Res BW: 1.0 MHz Video BW: 3.0 MHz Sweep: 10.00 ms (1001 pts)</p>	<p>Center: 5.19000000 GHz Res BW: 1.0 MHz Video BW: 3.0 MHz Sweep: 10.00 ms (1001 pts)</p>
802.11ax-HE80	<p>Center: 5.21000000 GHz Res BW: 1.0 MHz Video BW: 3.0 MHz Sweep: 10.00 ms (1001 pts)</p>	<p>Center: 5.21000000 GHz Res BW: 1.0 MHz Video BW: 3.0 MHz Sweep: 10.00 ms (1001 pts)</p>
802.11ax-HE160	<p>Center: 5.22000000 GHz Res BW: 1.0 MHz Video BW: 3.0 MHz Sweep: 10.00 ms (1001 pts)</p>	<p>Center: 5.22000000 GHz Res BW: 1.0 MHz Video BW: 3.0 MHz Sweep: 10.00 ms (1001 pts)</p>

Mode	TX _{on} (ms)	T _{on} +T _{off} (ms)
802.11ax-HE20 (RU Config 26)		
802.11ax-HE20 (RU Config 52)		
802.11ax-HE20 (RU Config 106)		
802.11ax-HE40 (RU Config 242)		

Mode	TX _{on} (ms)	T _{on} +T _{off} (ms)
<p>802.11ax-HE80 (RU Config 484)</p>		
<p>802.11ax-HE160 (RU Config 996)</p>		

AC Conduction	
Normal operation	

Item		Mode	Data Rate	Test Channel
Radiated Test Case	Radiated Spurious Emission (30MHz~1GHz)	802.11n-HT40	MCS8	142

Item		Mode	Data Rate	Test Channel
Radiated Test Case	Radiated Band Edge <small>Note1</small>	802.11a	6 Mbps	36/64/100/140/144/149/165
		802.11n-HT20	MCS8	36/64/100/140/144/149/165
		802.11n-HT40	MCS8	38/62/102/134/142/151/159
		802.11ac-VHT80	MCS0	42/58/106/122/138/155
		802.11ac-VHT160	MCS0	50/114
		802.11ax-HE20	HE0	36/64/100/140/144/149/165
		802.11ax-HE40	HE0	38/62/102/134/142/151/159
		802.11ax-HE80	HE0	42/58/106/122/138/155
	802.11ax-HE160	HE0	50/114	
	Radiated Spurious Emission <small>Note1 & 2</small>	802.11a	6 Mbps	36/64/100/144/157
		802.11n-HT20	MCS8	40/64/100/144/165
		802.11n-HT40	MCS8	46/54/110/142/159
		802.11ac-VHT80	MCS0	42/58/122/138/155
		802.11ac-VHT160	MCS0	50/114
		802.11ax-HE20	HE0	40/64/100/144/165
		802.11ax-HE40	HE0	46/54/110/142/159
802.11ax-HE80		HE0	42/58/122/138/155	
802.11ax-HE160	HE0	50/114		

Item		Mode	Data Rate	RU Configuration	Test Channel	
Radiated Test Case	Radiated Band Edge <small>Note1</small>	802.11ax-HE20	HE0	26/0	36/100/149	
				52/37		
				106/53		
			HE0	26/8	64/140/165	
				52/40		
				106/54		
		802.11ax-HE40	HE0	242/61	38/102/151	
			HE0	242/62	62/134/159	
			802.11ax-HE80	HE0	484/65	42/106/155
				HE0	484/66	58/122/155
			802.11ax-HE160	HE0	996/67	50/114
				HE0	996/S67	50/114
HE0	996/S67	50/114				

Item		Mode	Data Rate	Test Channel
Conducted Test Case	Emission/Occupied Bandwidth	802.11a	6 Mbps	36/40/48/52/60/64/100/116/140/144/149/157/165
		802.11n-HT20	MCS8	36/40/48/52/60/64/100/116/140/144/149/157/165
		802.11n-HT40	MCS8	38/46/54/62/102/110/134/142/151/159
		802.11ac-VHT80	MCS0	42/58/106/122/138/155
		802.11ac-VHT160	MCS0	50/114
		802.11ax-HE20	HE0	36/40/48/52/60/64/100/116/140/144/149/157/165
		802.11ax-HE40	HE0	38/46/54/62/102/110/134/142/151/159
		802.11ax-HE80	HE0	42/58/106/122/138/155
	802.11ax-HE160	HE0	50/114	
	Maximum output power	802.11a	6 Mbps	36/40/48/52/60/64/100/116/140/144/149/157/165
		802.11n-HT20	MCS8	36/40/48/52/60/64/100/116/140/144/149/157/165
		802.11n-HT40	MCS8	38/46/54/62/102/110/134/142/151/159
		802.11ac-VHT80	MCS0	42/58/106/122/138/155
		802.11ac-VHT160	MCS0	50/114
		802.11ax-HE20	HE0	36/40/48/52/60/64/100/116/140/144/149/157/165
		802.11ax-HE40	HE0	38/46/54/62/102/110/134/142/151/159
		802.11ax-HE80	HE0	42/58/106/122/138/155
	802.11ax-HE160	HE0	50/114	
	Power spectral density	802.11a	6 Mbps	36/40/48/52/60/64/100/116/140/144/149/157/165
		802.11n-HT20	MCS8	36/40/48/52/60/64/100/116/140/144/149/157/165
		802.11n-HT40	MCS8	38/46/54/62/102/110/134/142/151/159
		802.11ac-VHT80	MCS0	42/58/106/122/138/155
		802.11ac-VHT160	MCS0	50/114
		802.11ax-HE20	HE0	36/40/48/52/60/64/100/116/140/144/149/157/165
802.11ax-HE40		HE0	38/46/54/62/102/110/134/142/151/159	
802.11ax-HE80		HE0	42/58/106/122/138/155	
802.11ax-HE160	HE0	50/114		

Item		Mode	Data Rate	RU Configuration	Test Channel
Conducted Test Case	Emission/ Occupied Bandwidth	802.11ax-HE20	HE0	26/0	36/100/149
				52/37	
				106/53	
			HE0	26/8	64/140/165
				52/40	
				106/54	
		802.11ax-HE40	HE0	242/61	38/102/151
			HE0	242/62	62/134/159
		802.11ax-HE80	HE0	484/65	42/106/155
			HE0	484/66	58/122/155
		802.11ax-HE160	HE0	996/67	50/114
			HE0	996/S67	50/114
Conducted Test Case	Maximum output power	802.11ax-HE20	HE0	26/0	36/100/149
				52/37	
				106/53	
			HE0	26/8	64/140/165
				52/40	
				106/5	
		802.11ax-HE40	HE0	242/61	38/102/151
			HE0	242/62	62/134/159
		802.11ax-HE80	HE0	484/65	42/106/155
			HE0	484/66	58/122/155
		802.11ax-HE160	HE0	996/67	50/114
			HE0	996/S67	50/114

Item		Mode	Data Rate	RU Configuration	Test Channel
Conducted Test Case	Power spectral density	802.11ax-HE20	HE0	26/0	36/100/149
				52/37	
				106/53	
		802.11ax-HE40	HE0	26/8	64/140/165
				52/40	
				106/54	
		802.11ax-HE40	HE0	242/61	38/102/151
			HE0	242/62	62/134/159
		802.11ax-HE80	HE0	484/65	42/106/155
			HE0	484/66	58/122/155
802.11ax-HE160	HE0	996/67	50/114		
	HE0	996/S67	50/114		

Note 1: Mobile Device Portable Device

and 3 axis were assessed. The worst scenario for Radiated Spurious Emission as follow:

Lie Side Stand

Note 2: Low, mid, and high channels were measured, only the worst channel of each modulation was presented in this report.

Note 3: The modulation and bandwidth are similar for 802.11n mode for HT20/HT40 and 802.11ac mode for VHT20/VHT40, therefore investigated worst case to representative mode in the test report.

Note 4: The data rates were selected based on preliminary testing that identified rate as the worst case for output power.

3.8. Output Power Setting

Mode	U-NII Band	Centre Frequency (MHz)	Power Setting	
			AUX	Main
802.11a	1	5180	17.000	17.000
		5200	17.000	17.000
		5240	17.000	17.000
	2A	5260	17.000	17.000
		5300	17.000	17.000
		5320	17.000	17.000
	2C	5500	17.000	17.000
		5580	17.000	17.000
		5700	17.000	17.000
		5720	17.000	17.000
	3	5745	17.000	17.000
		5785	17.000	17.000
5825		17.000	17.000	

Mode	U-NII Band	Centre Frequency (MHz)	Power Setting		Mode	U-NII Band	Centre Frequency (MHz)	Power Setting	
			AUX	Main				AUX	Main
802.11n-HT20	1	5180	17.000	17.000	802.11ax-HE20	1	5180	17.000	17.000
		5200	17.000	17.000			5200	17.000	17.000
		5240	17.000	17.000			5240	17.000	17.000
	2A	5260	17.000	17.000		2A	5260	17.000	17.000
		5300	17.000	17.000			5300	17.000	17.000
		5320	17.000	17.000			5320	17.000	17.000
	2C	5500	17.000	17.000		2C	5500	17.000	17.000
		5580	17.000	17.000			5580	17.000	17.000
		5700	17.000	17.000			5700	17.000	17.000
		5720	17.000	17.000			5720	17.000	17.000
	3	5745	17.000	17.000		3	5745	17.000	17.000
		5785	17.000	17.000			5785	17.000	17.000
5825		17.000	17.000	5825	17.000		17.000		

Mode	U-NII Band	Centre Frequency (MHz)	Power Setting		Mode	U-NII Band	Centre Frequency (MHz)	Power Setting	
			AUX	Main				AUX	Main
802.11n-HT40	1	5190	15.000	15.000	802.11ax-HE40	1	5190	15.000	15.000
		5230	17.000	17.000			5230	17.000	17.000
	2A	5270	17.000	17.000		2A	5270	17.000	17.000
		5310	15.250	15.250			5310	15.250	15.250
	2C	5510	17.000	17.000		2C	5510	17.000	17.000
		5550	17.000	17.000			5550	17.000	17.000
		5670	17.000	17.000			5670	17.000	17.000
		5710	17.000	17.000			5710	17.000	17.000
	3	5755	17.000	17.000		3	5755	17.000	17.000
		5795	17.000	17.000			5795	17.000	17.000

Mode	U-NII Band	Centre Frequency (MHz)	Power Setting		Mode	U-NII Band	Centre Frequency (MHz)	Power Setting	
			AUX	Main				AUX	Main
802.11ac-VT80	1	5210	14.000	14.000	802.11ax-HE80	1	5210	14.000	14.000
	2A	5290	15.250	15.250		2A	5290	15.250	15.250
	2C	5530	15.000	15.000		2C	5530	15.000	15.000
		5610	17.000	17.000			5610	17.000	17.000
		5690	17.000	17.000			5690	17.000	17.000
	3	5775	17.000	17.000		3	5775	17.000	17.000

Mode	U-NII Band	Centre Frequency (MHz)	Power Setting		Mode	U-NII Band	Centre Frequency (MHz)	Power Setting	
			AUX	Main				AUX	Main
802.11ac-VT160	1 /2A	5250	11.000	11.000	802.11ax-HE160	1 /2A	5250	11.000	11.000
	2C	5570	14.000	14.000		2C	5570	14.000	14.000

Mode	U-NII Band	Centre Frequency (MHz)	RU Configuration	Power Setting	
				AUX	Main
802.11ax-HE20	1	5180	26/0	10.000	10.000
			52/37	13.000	13.000
			106/53	16.000	16.000
	2A	5320	26/8	10.000	10.000
			52/40	13.000	13.000
			106/54	16.000	16.000
	2C	5500	26/0	10.000	10.000
			52/37	13.000	13.000
			106/53	15.250	15.250
		5700	26/8	10.000	10.000
			52/40	13.000	13.000
			106/54	16.000	16.000
	3	5745	26/0	16.000	16.000
			52/37	13.000	13.000
			106/53	17.000	17.000
5825		26/8	16.000	16.000	
		52/40	13.000	13.000	
		106/54	17.000	17.000	
802.11ax-HE40	1	5190	242/61	16.750	16.750
	2A	5310	242/62	16.250	16.250
	2C	5510	242/61	17.000	17.000
		5670	242/62	17.000	17.000
	3	5755	242/61	17.000	17.000
		5795	242/62	17.000	17.000
802.11ax-HE80	1	5210	484/65	14.000	14.000
	2A	5290	484/66	12.000	12.000
	2C	5530	484/65	15.250	15.250
		5610	484/66	17.000	17.000
	3	5775	484/65	17.000	17.000
			484/66	17.000	17.000
802.11ax-HE160	1/ 2A	5250	996/67	14.000	14.000
			996/S67	12.500	12.500
	2C	5570	996/67	14.000	14.000
			996/S67	17.000	17.000

3.9. Tested Supporting System List

3.9.1. Support Peripheral Unit

No.	Product	Brand	Model No.	Serial No.	Approval
1.	USB Mouse	hp	MOFYUO	FCMHH0AKZB D7LC	N/A
2.	Earphone	APPLE	N/A	N/A	N/A
3.	SD Card	ADATA	MicroSDHC Card	N/A	N/A
Partner System					
4.	AP Server	ASUS	RT-AX88U	N/A	FCC ID: MSQ-RTAXHP00 IC: 3568A-RTAXHP00

3.9.2. Cable Lists

No.	Cable Description Of The Above Support Units
1.	USB Cable: Unshielded, Undetachable, 0.7m
2.	Earphone Cable: Unshielded, Undetachable, 1.2m
3.	N/A
4.	AC adapter: M/N:WA-30B12, Cable: Unshielded, Detachable, 1.2m LAN cable: Unshielded, Detachable, 3.0m
5.	LAN cable: Unshielded, Detachable, 1.8m

3.10. Setup Configuration

3.10.1. EUT Configuration for Power Line & Radiated Emission

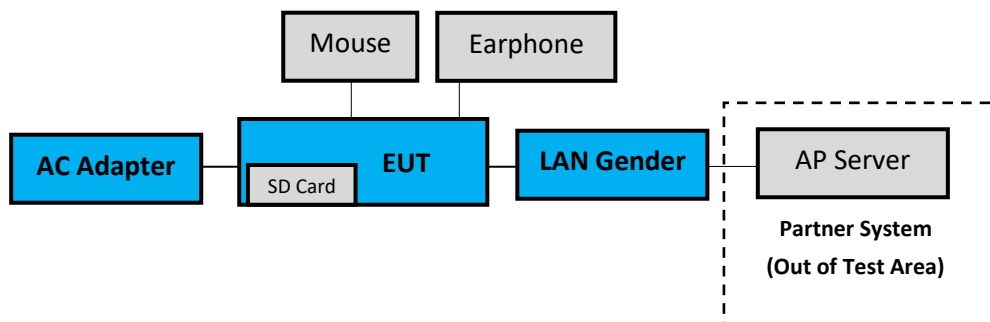

3.10.2. EUT Configuration for RF Conducted Test Items

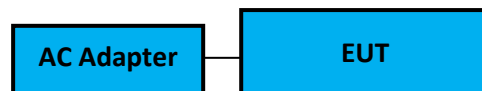

3.11. Operating Condition of EUT

Test program “DRTU” is used for enabling EUT WLAN function under continues transmitting and choosing data rate/ channel.

[ANT AUX port (A Button in DRTU), ANT Main port (B Button in DRTU)].

3.12. Description of Test Facility

Name of Test Firm	Audix Technology Corporation / EMC Department No. 491, Zhongfu Rd., Linkou Dist., New Taipei City 244, Taiwan Tel: +886-2-26092133 Fax: +886-2-26099303 Website : www.audixtech.com Contact e-mail: attemc_report@audixtech.com
Accreditations	The laboratory is accredited by following organizations under ISO/IEC 17025:2017 (1) NVLAP(USA) NVLAP Lab Code 200077-0 (2) TAF(Taiwan) No. 1724
Test Facilities	FCC OET Designation Number under APEC MRA by NCC is : TW1724 ISED CAB Identifier Number under APEC TEL MRA by NCC is TW1724 (1) No.8 Shielded Room (2) No.1 3m Semi Anechoic Chamber

3.13. Measurement Uncertainty

Test Items/Facilities		Frequency Range	Uncertainty	
Conduction Test	<input type="checkbox"/>	No. 7 Shielded Room	9kHz-150kHz	±3.7dB
			150kHz-30MHz	±3.4dB
	<input checked="" type="checkbox"/>	No. 8 Shielded Room	9kHz-150kHz	±3.7dB
			150kHz-30MHz	±3.5dB
Radiation Test	<input checked="" type="checkbox"/>	No.1 3m Semi Anechoic Chamber	30MHz-200MHz, 3m, Horizontal	±3.8dB
			200MHz-1000MHz, 3m, Horizontal	±4.4dB
			30MHz-200MHz, 3m, Vertical	±4.5dB
			200MHz-1000MHz, 3m, Vertical	±4.7dB
			1GHz-6GHz, 3m	±4.9dB
			6GHz-18GHz, 3m	±4.5dB
	<input type="checkbox"/>	No.3 3m Semi Anechoic Chamber	30MHz-200MHz, 3m, Horizontal	±4.0dB
			200MHz-1000MHz, 3m, Horizontal	±4.3dB
			30MHz-200MHz, 3m, Vertical	±4.6dB
			200MHz-1000MHz, 3m, Vertical	±4.7dB
			1GHz-6GHz, 3m	±4.8dB
			6GHz-18GHz, 3m	±4.5dB
	<input type="checkbox"/>	No.4 3m Semi Anechoic Chamber	30MHz-200MHz, 3m, Horizontal	±4.3dB
			200MHz-1000MHz, 3m, Horizontal	±4.3dB
			30MHz-200MHz, 3m, Vertical	±4.6dB
			200MHz-1000MHz, 3m, Vertical	±4.7dB
			1GHz-6GHz, 3m	±4.8dB
			6GHz-18GHz, 3m	±4.4dB
	<input type="checkbox"/>	No.5 3m Semi Anechoic Chamber	30MHz-200MHz, 3m, Horizontal	±4.3dB
			200MHz-1000MHz, 3m, Horizontal	±4.3dB
			30MHz-200MHz, 3m, Vertical	±4.5dB
			200MHz-1000MHz, 3m, Vertical	±4.6dB
			1GHz-6GHz, 3m	±4.9dB
			6GHz-18GHz, 3m	±4.1dB
	Radiated emissions (18GHz-40GHz)		18GHz-40GHz, 3m	±3.4dB

Remark : Uncertainty = $ku_c(y)$

Test Items	Uncertainty
Bandwidth	± 0.2kHz
Maximum output power	± 0.33dB
Power spectral density	± 0.13dB

4. MEASUREMENT EQUIPMENT LIST

4.1. Conducted Emission Measurement

Item	Type	Manufacturer	Model No.	Serial No.	Cal. Date	Cal. Interval
1.	Test Receiver	R&S	ESR3	101774	2022. 01. 11	1 Year
2.	A.M.N.	R&S	ENV432	101567	2022. 05. 26	1 Year
3.	L.I.S.N.	Kyoritsu	KNW-407	8-855-9	2021. 12. 19	1 Year
4.	Pulse Limiter	R&S	ESH3-Z2	100354	2021. 12. 23	1 Year
5.	Digital Thermo-Hygro Meter	iMax	HTC-1	No.8 S/R	2022. 04. 14	1 Year
6.	Coaxial Cable	Yeida	RG/58AU	CE-08	2022. 09. 07	1 Year
7.	Test Software	Audix	e3	V9 18621a	N.C.R.	N.C.R.

4.2. Radiated Emission Measurement

Item	Type	Manufacturer	Model No.	Serial No.	Cal. Date	Cal. Interval
1.	Spectrum Analyzer	Agilent	N9010A-526	MY53400071	2022. 08. 24	1 Year
2.	Spectrum Analyzer	Agilent	N9030A-526	MY53310269	2022. 02. 01	1 Year
3.	Spectrum Analyzer	Keysight	N9010B-544	MY55460198	2022. 04. 08	1 Year
4.	Test Receiver	R&S	ESCS30	100338	2022. 06. 15	1 Year
5.	Amplifier	HP	8447D	2944A06305	2022. 01. 05	1 Year
6.	Microwave Amplifier	Keysight	83051A	MY56480113	2022. 09. 07	1 Year
7.	Microwave Amplifier	Agilent	8449B	3008A02678	2022. 02. 22	1 Year
8.	Loop Antenna	TESEQ	HLA 6121	60478	2022. 02. 17	1 Year
9.	Bilog Antenna	TESEQ	CBL6112D	33821	2022. 07. 01	1 Year
10.	Double-Ridged Waveguide Horn	ETS-Lindgren	3117	00135902	2022. 03. 21	1 Year
11.	Horn Antenna	COM-POWER	AH-840	101092	2022. 01. 06	1 Year
12.	5G Notch Filter	Microwave Circuits	N0452502	459775	2022. 05. 04	1 Year
13.	5G Notch Filter	Microwave Circuits	N0555983	504921	2022. 08. 03	1 Year
14.	5G Notch Filter	Microwave Circuits	N0257881	459776	2022. 08. 10	1 Year
15.	Coaxial Cable	MIYAZAKI	5D2W	RE-11	2022. 01. 20	1 Year
16.	Coaxial Cable	HUBER+SUHNER	SUCOFLEX 106	RE-14	2022. 01. 20	1 Year
17.	Coaxial Cable	HUBER+SUHNER	SUCOFLEX 102	RE-30	2022. 08. 22	1 Year
18.	Digital Thermo-Hygro Meter	iMax	HTC-1	No.1 3m A/C	2022. 04. 14	1 Year
19.	Test Software	Audix	e3	V9 18621a	N.C.R.	N.C.R.

4.3. RF Conducted Measurement

Item	Type	Manufacturer	Model No.	Serial No.	Cal. Date	Cal. Interval
1.	Spectrum Analyzer	Keysight	N9020B-544	MY57120357	2022. 03. 02	1 Year
2.	Spectrum Analyzer	Agilent	N9030A-526	MY53310269	2022. 02. 01	1 Year
3.	Power Meter	Anritsu	ML2495A	2127005	2022. 11. 30	1 Year
4.	Power Sensor	Anritsu	MA2411B	1911360	2021. 12. 02	1 Year
5.	Digital Thermo-Hygro Meter	iMax	HTC-1	RF-03	2022. 04. 14	1 Year

5. CONDUCTED EMISSION

5.1. Block Diagram of Test Setup

5.1.1. Block Diagram of EUT

Indicated as section 3.10

5.1.2. Shielded Room Setup Diagram

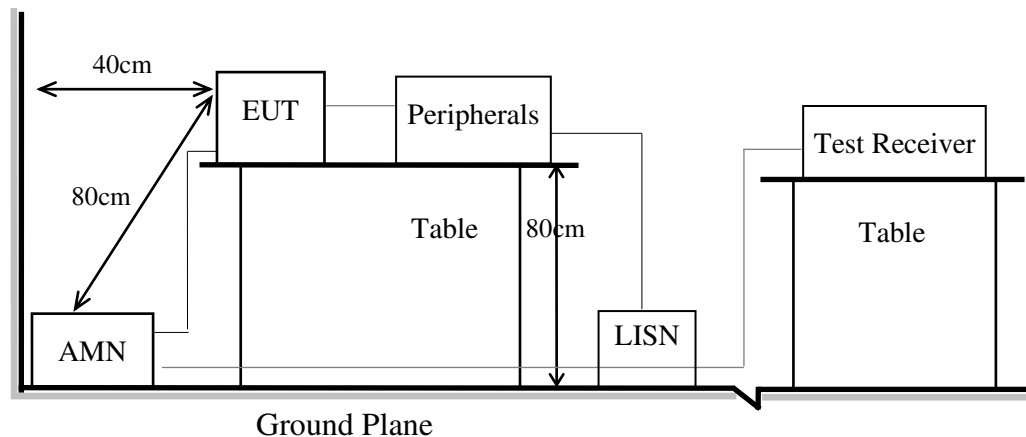

5.2. Conducted Emission Limit

Frequency	Conducted Limit	
	Quasi-Peak Level	Average Level
150kHz ~ 500kHz	66 ~ 56 dB μ V	56 ~ 46 dB μ V
500kHz ~ 5MHz	56 dB μ V	46 dB μ V
5MHz ~ 30MHz	60 dB μ V	50 dB μ V

Remark1.: If the average limit is met when using a Quasi-Peak detector, the measurement using the average detector is not required.

2.: The lower limit applies to the band edges.

5.3. Test Procedure

- 5.3.1. To set up the EUT as indicated in ANSI C63.10. The EUT was placed on the table which has 80 cm height to the ground and 40 cm distance to the conducting wall.
- 5.3.2. Power supplier of the EUT was connected to the AC mains through an Artificial Mains Network (A.M.N.).
- 5.3.3. The AC power supplies to all peripheral devices must be provided through line impedance stabilization network (L.I.S.N.)
- 5.3.4. Checking frequency range from 150kHz to 30 MHz and record the emission which does not have 20 dB below limit.

5.4. Test Results

Please refer to Appendix A.

6. RADIATED EMISSION

6.1. Block Diagram of Test Setup

6.1.1. Block Diagram of EUT

Indicated as section 3.10

6.1.2. Setup Diagram for 9kHz-30MHz

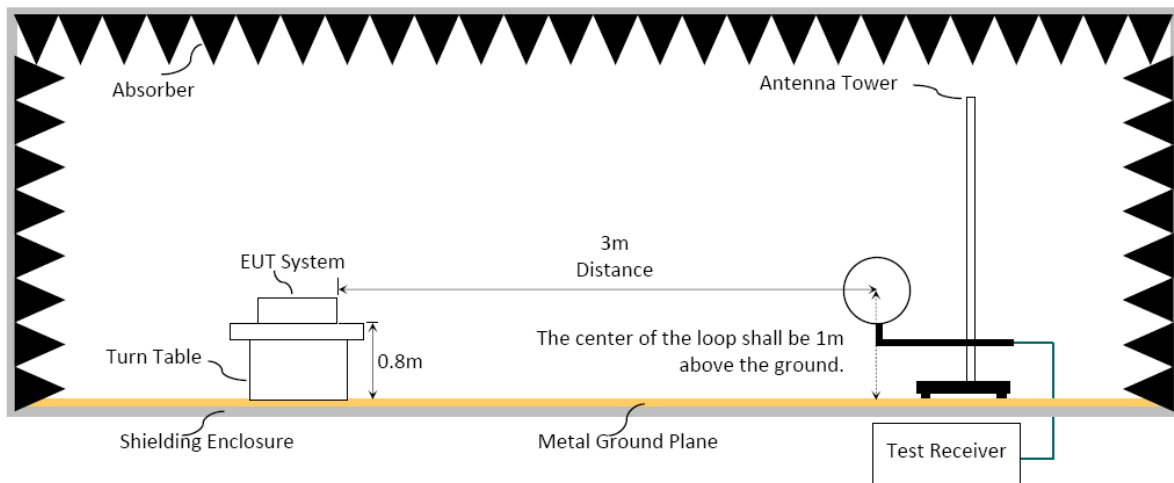

6.1.3. Setup Diagram for 30-1000MHz

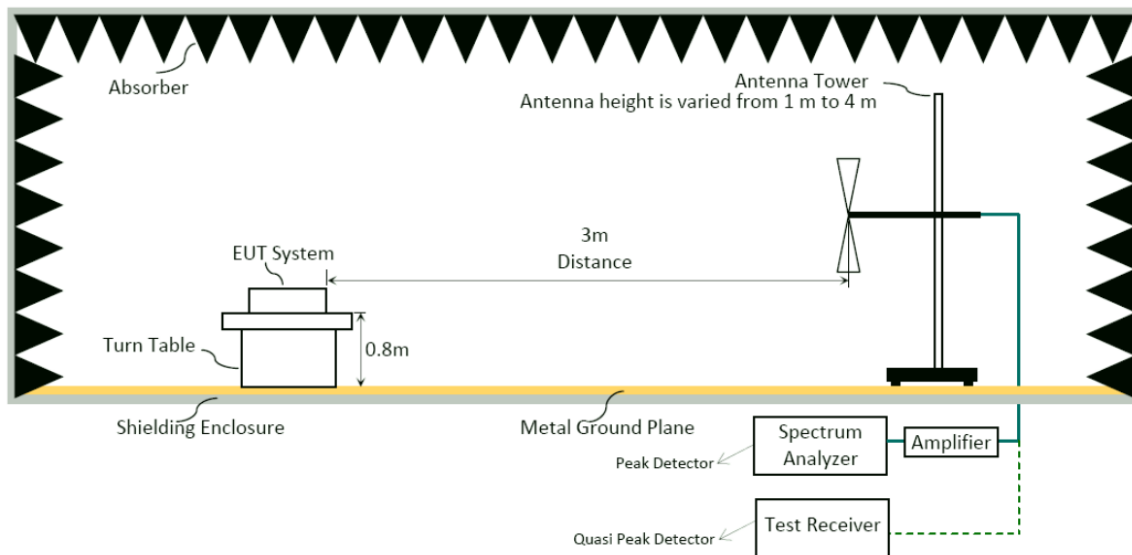

6.1.4. Setup Diagram for above 1GHz

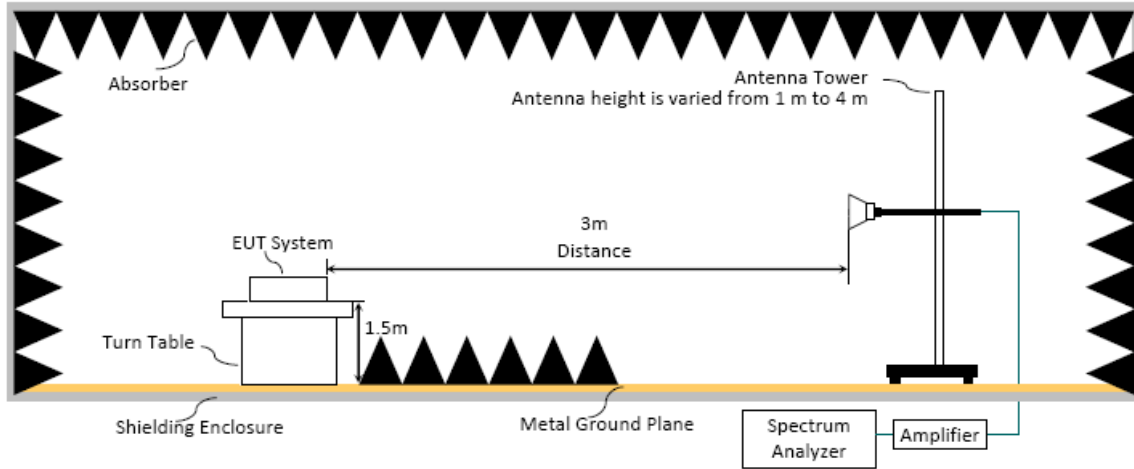

6.2. Radiated Emission Limits

Radiated emissions fall in restricted bands, as defined in Section 15.205 must be in compliance with the radiated emission limits specified in 15.209 as below.

6.2.1. General Limit

Frequency (MHz)	Distance(m)	Limits	
		dB μ V/m	μ V/m
0.009 - 0.490	300	67.6-20 log f(kHz)	2400/f kHz
0.490 - 1.705	30	87.6-20 log f(kHz)	24000/f kHz
1.705 - 30	30	29.5	30
30 - 88	3	40.0	100
88- 216	3	43.5	150
216- 960	3	46.0	200
Above 960	3	54.0	500
Above 1000	3	74.0 dB μ V/m (Peak) 54.0 dB μ V/m (Average)	

Remark : (1) dB μ V/m = 20 log (μ V/m)

- (2) The tighter limit applies to the edge between two frequency bands.
- (3) Distance refers to the distance in meters between the measuring instrument antenna and the closed point of any part of the device or system.
- (4) Fundamental and emission fall within operation band are exempted from this section.
- (5) Pursuant to ANSI C63.10: 6.6.4.3, if the maximized peak measured value complies with the average limit, then it is unnecessary to perform an average measurement.

6.2.2. Limit for non-restricted frequency above 1 GHz

Frequency Band (MHz)	E.I.R.P. Limit	Field Strength Limit at 3 m
5150 to 5250	-27 dBm	68.2 dB μ V/m
5250 to 5350		68.2 dB μ V/m
5470 to 5725		68.2 dB μ V/m

Note: Field Strength at 3 m = E.I.R.P. + 95.2 dB

Frequency Band (MHz)	Field Strength Limit at 3 m	
5725 to 5850	<input checked="" type="checkbox"/>	15.407(b)(4)(i) All emissions shall be limited to a level of 68.2 dB μ V/m at 75 MHz or more above or below the band edge increasing linearly to 105.2 dB μ V/m at 25 MHz above or below the band edge, and from 25 MHz above or below the band edge increasing linearly to a level of 110.8 dB μ V/m at 5 MHz above or below the band edge, and from 5 MHz above or below the band edge increasing linearly to a level of 122.2 dB μ V/m at the band edge.
	<input type="checkbox"/>	15.407(b)(4)(ii), compliance with the emission limits in § 15.247(d) shall be at least 30dB below that in the 100 kHz bandwidth within the band that contains the highest level of the desired power. Attenuation below the general limits specified in § 15.209(a) is not required. In addition, radiated emissions which fall in the restricted bands, as defined in § 15.205(a), must also comply with the radiated emission limits specified in § 15.209(a) (see § 15.205(c))

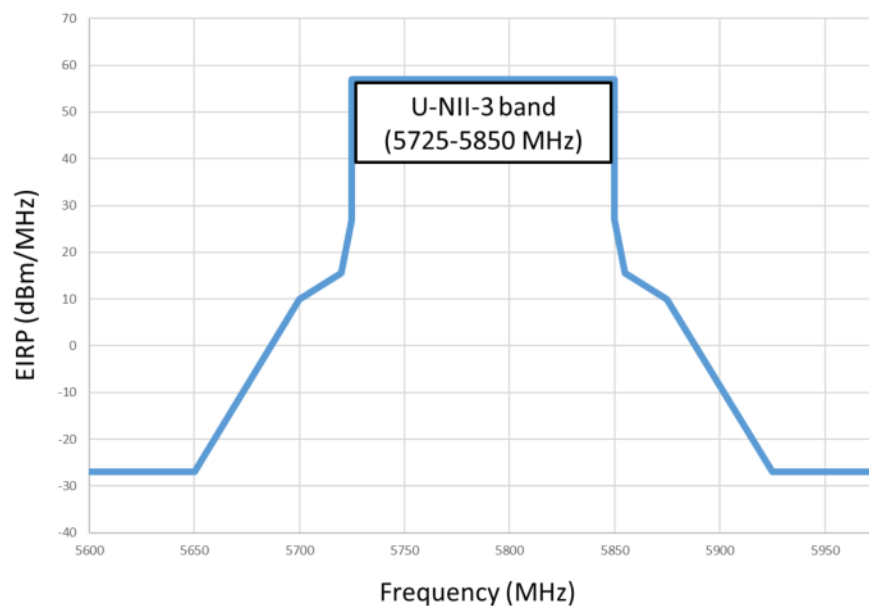

6.3. Test Procedure

Frequency Range 9kHz~30MHz:

The EUT setup on the turntable which has 0.8 m height to the ground. The turn table rotated 360 degrees and antenna fixed to 1 m to find the maximum emission level. In order to find the maximum emission, all of the interface cables were manipulated according to ANSI C63.10-2013 regulation.

- (1) RBW = 9kHz with peak and average detector.
- (2) Detector: average and peak (9kHz-490kHz)
Q.P. (490kHz-30MHz)

Frequency Range 30MHz ~ 40GHz:

The EUT setup on the turn table which has 80cm (for 30-1000MHz) and 1.5m (for above 1GHz) height to the ground. The turn table rotated 360 degrees and antenna varied from 1 m to 4 m to find the maximum emission level. Both horizontal and vertical polarization are required. In order to find the maximum emission, all of the interface cables were manipulated according to ANSI C63.10-2013 regulation.

Frequency below 1GHz:

Spectrum Analyzer is used for pre-testing with following setting:

- (1)RBW = 120kHz
- (2)VBW $\geq 3 \times$ RBW.
- (3)Detector = Peak.
- (4)Sweep time = auto.
- (5)Trace mode = max hold.
- (6)Allow sweeps to continue until the trace stabilizes.

Note 1: When peak-detected value is lower than limit that the measurement using the Q.P. detector is not required, otherwise using Q.P. for final measurement.

Note 2: When the radiated emissions limits are expressed in terms of the average value of the emissions, and pulsed operation is employed, the measurement field strength shall be determined by averaging over one complete pulse train, including blanking intervals, as long as the pulse train does not exceed 0.1 seconds.

Frequency above 1GHz to 10th harmonic(up to 40 GHz):

Peak Detector:

- (1)RBW = 1MHz
- (2)VBW $\geq 3 \times$ RBW.
- (3)Detector = Peak.
- (4)Sweep time = auto.
- (5)Trace mode = max hold.
- (6)Allow sweeps to continue until the trace stabilizes.

Note: When peak-detected value is lower than limit that the measurement using the average detector is not required, otherwise using average detector for final measurement.

Average Detector:

Option 1:

(1) RBW = 1MHz

(2) VBW $\geq 1/T$. (Duty Cycle < 98%, when duty cycle presented in section 3.7)

Modulation Type	VBW Setting
802.11ax-HE20 (RU Config 26)	1.5kHz
802.11ax-HE20 (RU Config 52)	750Hz
802.11ax-HE40 (RU Config 242)	750Hz
802.11ax-HE160 (RU Config 996)	820Hz

(3) VBW = set VBW \leq RBW / 100, but not less than 10Hz (Duty Cycle \geq 98%, when duty cycle presented in section 3.7)

Modulation Type	VBW Setting
802.11a	10Hz
802.11n-HT20	10Hz
802.11n-HT40	10Hz
802.11ac-VHT80	10Hz
802.11ac-VHT160	10Hz
802.11ax-HE20	10Hz
802.11ax-HE40	10Hz
802.11ax-HE80	10Hz
802.11ax-HE160	10Hz
802.11ax-HE20 (RU Config 106)	10Hz
802.11ax-HE80 (RU Config 484)	10Hz

(4) Detector = Peak.

(5) Sweep time = auto.

(6) Trace mode = max hold.

(7) Allow sweeps to continue until the trace stabilizes.

Option 2:

Average Emission Level(dB μ V/m) = Peak Emission Level(dB μ V/m) + DCCF(dB).

6.4. Measurement Result Explanation

Peak Emission Level(dB μ V/m) = Antenna Factor(dB/m) + Cable Loss (dB) – Preamp Gain (dB) + Reading(dB μ V).

Average Emission Level(dB μ V/m) = Antenna Factor(dB/m) + Cable Loss (dB) – Preamp Gain (dB) + Reading(dB μ V).

Average Emission Level(dB μ V/m) = Peak Emission Level(dB μ V/m) + DCCF(dB)
 Duty Cycle Correction Factor (DCCF)(dB) = $20\log(TX_{on}/TX_{on+off})$ presented in section 3.7.

ERP(dBm) = Peak Emission Level(dB μ V/m) - 95.2dB - 2.14dB

6.5. Test Results

Please refer to Appendix A.

7. EMISSION/OCCUPIED BANDWIDTH

7.1. Block Diagram of Test Setup

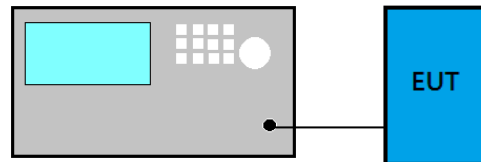

7.2. Specification Limits

Frequency Band (MHz)	Limit
5150 to 5250	Reference only
5250 to 5350	
5470 to 5725	
5725 to 5850	$\geq 500\text{kHz}$

7.3. Test Procedure

Following measurement procedure is reference to KDB 789033 D02 General UNII Test Procedures New Rules v02r01:

For Emission Bandwidth

■ Applicable to all bands except to 5725 MHz- 5850 MHz

- (1) Set RBW = 1% of the emission bandwidth
- (2) Set VBW > RBW
- (3) Detector = Peak
- (4) Trace mode = max hold
- (5) Setting channel bandwidth function x dB to -26 dB to record the final bandwidth.

■ 5725 MHz- 5850 MHz

- (1) Set RBW = 100 kHz.
- (2) Set the video bandwidth (VBW) $\geq 3 \times$ RBW.
- (3) Detector = Peak.
- (4) Trace mode = max hold.
- (5) Sweep = auto couple.
- (6) Allow the trace to stabilize.
- (7) Setting channel bandwidth function x dB to -6 dB to record the final bandwidth.

For 99% Occupied Bandwidth

- (1) Set Span range 1.5~5 times the OBW
- (2) Set RBW close to 1% to 5% of OBW.
- (3) Set $VBW \geq 3 \times RBW$.
- (4) Detector = Peak.
- (5) Trace mode = Max hold
- (6) Sweep = Auto couple.
- (7) Allow the trace to stabilize.

7.4. Test Results

Please refer to Appendix A

8. MAXIMUM OUTPUT POWER

8.1. Block Diagram of Test Setup

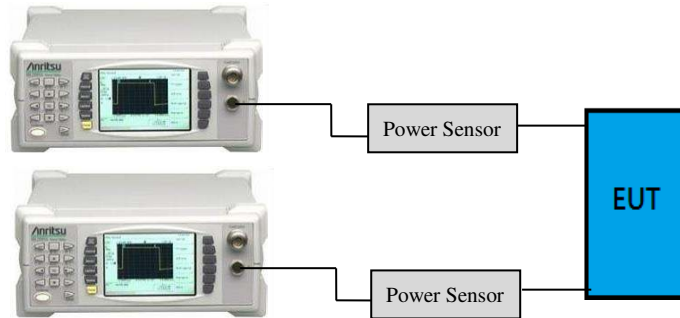

- For 802.11ac-VHT80/160, 802.11ax-HE160 modes only

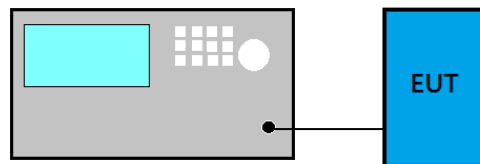

8.2. Specification Limits

Frequency Band (MHz)	Category	Limit
5150 to 5250	Outdoor Access Point	1 W(30 dBm)/ Max e.i.r.p. ≤125 mW(21 dBm) at any elevation angle above 30 degrees as measured from the horizon
	Fixed point-to-point Access Point	1 W(30 dBm)
	Indoor Access Point	1 W(30 dBm)
	Mobile and Portable client device	250 mW(24 dBm)
5250 to 5350	N/A	250 mW or 11 dBm + 10 log B ^{Note1}
5470 to 5725		250 mW or 11 dBm + 10 log B ^{Note1}
5725 to 5850		1 W(30 dBm)

Note 1: B is the 26 dB emission bandwidth, which presented in section 7 and appendix A.1.

8.3. Test Procedure

Following measurement procedure is reference to KDB 789033 D02 General UNII Test Procedures New Rules v02r01:

■ **Method AVGPM (Measurement using an RF average power meter):**

EUT is connected to power sensor and record the maximum average output power and duty cycle factor is added when duty cycle presented in section 3.7 is < 98%.

■ **Method AVGSA-2 (Spectrum channel power) for 802.11ac-VHT80/160, 802.11ax-HE80/160 modes only**

- (1) Set span to at least 1.5 times the OBW
- (2) Set RBW = 1 MHz
- (3) Set the video bandwidth (VBW) \geq 3 MHz.
- (4) Detector = RMS.
- (5) Trace mode = trace average at least 100 traces
- (6) Sweep = auto couple.
- (7) Compute power by integrating the spectrum across the OBW of the signal using the instrument's band power measurement function with band limits set equal to the OBW band edges.
- (8) Duty cycle factor is added when duty cycle presented in section 3.7 is < 98%.

8.4. Test Results

Please refer to Appendix A

9. POWER SPECTRAL DENSITY

9.1. Block Diagram of Test Setup

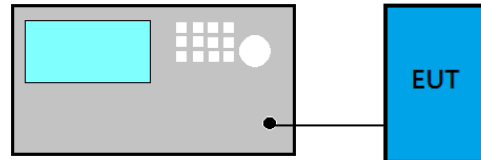

9.2. Specification Limits

Frequency Band (MHz)	Category	Limit
5150 to 5250	Outdoor Access Point	17dBm/MHz
	Fixed point-to-point Access Point	
	Indoor Access Point	
	Mobile and Portable client device	11 dBm/MHz
5250 to 5350	N/A	11 dBm/MHz
5470 to 5725		11 dBm/MHz
5725 to 5850		30dBm/500 kHz

9.3. Test Procedure

Following measurement procedure is reference to KDB 789033 D02 General UNII Test Procedures New Rules v02r01:

■ Method AVGSA-2

- (1) Set span to encompass the EBW (or 99% OBW) of the signal.
- (2) Set RBW = 1 MHz (Applicable to all bands except to 5725 MHz- 5850 MHz)/
Set RBW=100 KHz(when EUT operate at 5725 MHz- 5850 MHz)
- (3) Set the video bandwidth (VBW) ≥ 3 RBW.
- (4) Detector = RMS.
- (5) Trace mode = trace average at least 100 traces
- (6) Sweep = auto couple.
- (7) Use peak search function to find out the maximum power density.
- (8) Duty cycle factor is added when duty cycle presented in section 3.7 is $< 98\%$.
- (9) Offset BWCF (7dB) when EUT operate at 5725 MHz – 5850 MHz.

9.4. Test Results

Please refer to Appendix A

10. FREQUENCY STABILITY

10.1. Block Diagram of Test Setup

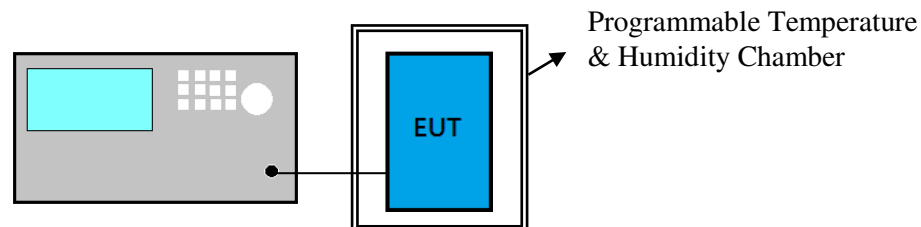

10.2. Specification Limits

NONE

10.3. Test Procedure

- (1) Frequency: Test frequency.
- (2) Span: enough to cover the complete power envelope
- (3) RBW: 1MHz(modulation ON) ; 10KHz(CW)
- (4) VBW: 1MHz(modulation ON) ; 10KHz(CW)
- (5) Detector Mode: Positive Peak
- (6) Indication mode: Max hold
- (7) Find the peak frequency and take calculate by the formula:
(Measurement Value-declaration frequency)/ declaration frequency)

10.4. Test Results

Please refer to Appendix A



11. DEVIATION TO TEST SPECIFICATIONS

【NONE】



APPDNDIX A

TEST DATA AND PLOTS

(Model: 14Z90RS)

TABLE OF CONTENTS

A.1 CONDUCTED EMISSION	2
A.2 RADIATED EMISSION	4
A.2.1 Emissions within Restricted Frequency Bands.....	4
A.2.2 Emissions outside the frequency band.....	153
A.2.3 Emissions in Non-restricted Frequency Bands.....	168
A.3 MAXIMUM OUTPUT POWER AND EMISSION/OCCUPIED BANDWIDTH	169
A.3.1 Average Output Power and Emission/Occupied Bandwidth.....	169
A.3.2 Measurement Plots	179
A.4 POWER SPECTRAL DENSITY	218
A.4.1 Power Spectral Density Result	218
A.4.2 Measurement Plots	227
A.5 FREQUENCY STABILITY	268
A.5.1 Frequency stability Result	268

A.1 CONDUCTED EMISSION

Test Date	2022/11/10	Temp./Hum.	26°C/64%
Test Voltage	AC 120V 60Hz (Via AC Adapter)	Tested By	Roy Hung

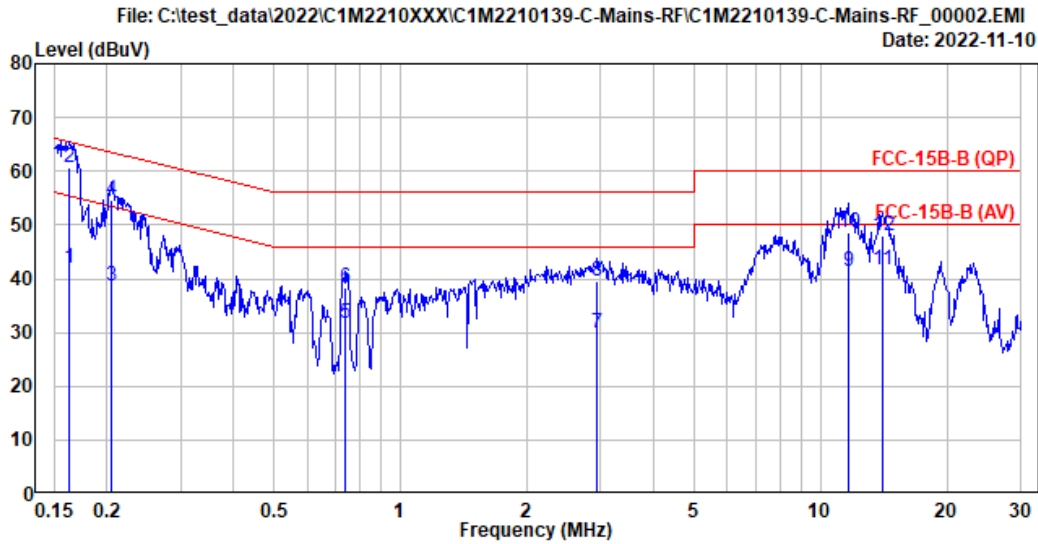

Site No.	: No.8 Shielded Room	Data No.	: 2
Instrument 1	: Receiver ESR(774)		
Instrument 2	: ENV432 (567)(A) CE-08 ESH3-Z2 (354)		
Limit	: FCC-15B-B (QP)	Phase	: Neutral
Environment	: 26°C/64 %	Engineer	: Roy Hung
EUT Model	: 14Z90RS	Test Rating	: 120Vac/60Hz
Test Mode	: Normal		

	Freq. (MHz)	AMN Factor (dB)	Cable Loss (dB)	Pulse Att. (dB)	Reading (dBµV)	Emission Level (dBµV)	Limits (dBµV)	Margin (dB)	Remark
1	0.163	10.33	0.03	9.85	21.62	41.83	55.30	13.47	Average
2	0.163	10.33	0.03	9.85	40.41	60.62	65.30	4.68	QP
3	0.205	10.32	0.03	9.85	18.58	38.78	53.39	14.61	Average
4	0.205	10.32	0.03	9.85	34.42	54.62	63.39	8.77	QP
5	0.739	10.33	0.04	9.85	11.41	31.63	46.00	14.37	Average
6	0.739	10.33	0.04	9.85	17.99	38.21	56.00	17.79	QP
7	2.940	10.38	0.07	9.86	9.44	29.75	46.00	16.25	Average
8	2.940	10.38	0.07	9.86	19.19	39.50	56.00	16.50	QP
9	11.637	10.72	0.15	9.90	20.60	41.37	50.00	8.63	Average
10	11.637	10.72	0.15	9.90	27.91	48.68	60.00	11.32	QP
11	14.064	10.84	0.16	9.91	20.70	41.61	50.00	8.39	Average
12	14.064	10.84	0.16	9.91	27.05	47.96	60.00	12.04	QP

Remarks: 1. Emission Level= AMN Factor + Cable Loss + Pulse Att. + Reading.
 2. If the average limit is met when using a quasi-peak detector, the EUT shall be deemed to meet both limits and measurement with average detector is unnecessary.

Test Date	2022/11/10	Temp./Hum.	26°C/64%
Test Voltage	AC 120V 60Hz (Via AC Adapter)	Tested By	Roy Hung

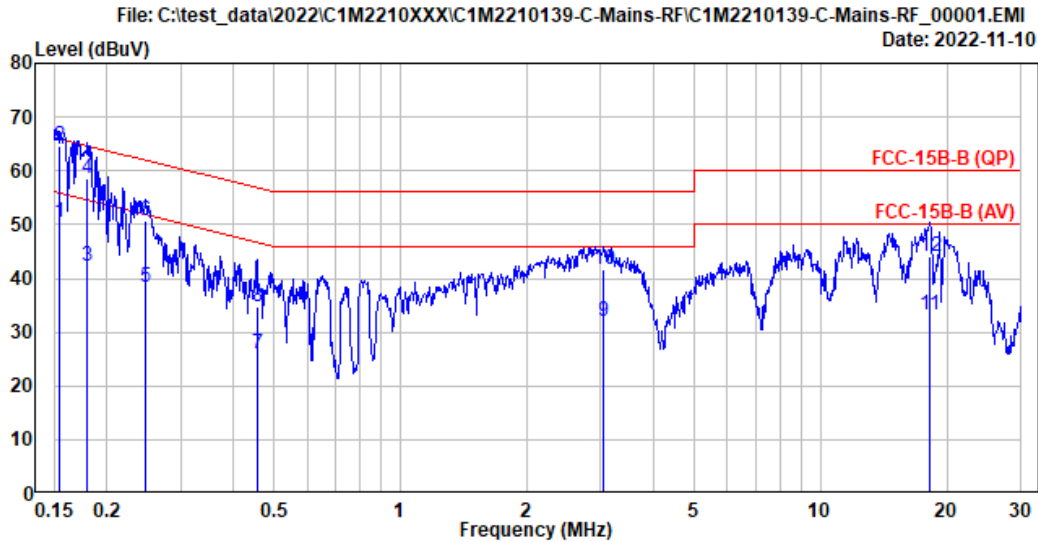

Site No.	: No.8 Shielded Room	Data No.	: 1
Instrument 1	: Receiver ESR(774)		
Instrument 2	: ENV432 (567)(A) CE-08 ESH3-Z2 (354)		
Limit	: FCC-15B-B (QP)	Phase	: Line
Environment	: 26°C/64 %	Engineer	: Roy Hung
EUT Model	: 14Z90RS	Test Rating	: 120Vac/60Hz
Test Mode	: Normal		

	Freq. (MHz)	AMN Factor (dB)	Cable Loss (dB)	Pulse Att. (dB)	Reading (dBµV)	Emission Level (dBµV)	Limits (dBµV)	Margin (dB)	Remark
1	0.154	10.22	0.03	9.85	30.33	50.43	55.79	5.36	Average
2	0.154	10.22	0.03	9.85	44.47	64.57	65.79	1.22	QP
3	0.179	10.22	0.03	9.85	22.16	42.26	54.51	12.25	Average
4	0.179	10.22	0.03	9.85	38.50	58.60	64.51	5.91	QP
5	0.248	10.22	0.03	9.85	18.13	38.23	51.82	13.59	Average
6	0.248	10.22	0.03	9.85	30.63	50.73	61.82	11.09	QP
7	0.456	10.22	0.03	9.85	5.88	25.98	46.77	20.79	Average
8	0.456	10.22	0.03	9.85	14.66	34.76	56.77	22.01	QP
9	3.045	10.27	0.07	9.86	11.73	31.93	46.00	14.07	Average
10	3.045	10.27	0.07	9.86	21.46	41.66	56.00	14.34	QP
11	18.225	10.61	0.19	9.93	12.50	33.23	50.00	16.77	Average
12	18.225	10.61	0.19	9.93	23.37	44.10	60.00	15.90	QP

Remarks: 1. Emission Level= AMN Factor + Cable Loss + Pulse Att. + Reading.
 2. If the average limit is met when using a quasi-peak detector,
 the EUT shall be deemed to meet both limits and measurement
 with average detector is unnecessary.

A.2 RADIATED EMISSION

Test Date	2022/10/25 ~ 28	Temp./Hum.	24-25°C/59-60%
Test Voltage	AC 120V 60Hz (Via AC Adapter)	Tested By	Martin Chen

A.2.1 Emissions within Restricted Frequency Bands

A.2.1.1 Frequency 9kHz~30MHz

The emissions (9kHz~30MHz) not reported for there is no emission be found.

A.2.1.2 Frequency Below 1GHz

Mode	802.11n-HT40	U-NII Band	2C
		Frequency	TX 5710MHz

Antenna at Horizontal Polarization

Emission Frequency (MHz)	Antenna Factor (dB/m)	Cable Loss (dB)	Preamplifier Gain (dB)	Read Level (dBμV)	Emission Level (dBμV/m)	Limits (dBμV/m)	Margin (dB)	Detector
30.970	23.07	1.43	26.49	32.55	30.56	40.00	9.44	Peak
149.310	16.92	3.19	26.00	34.65	28.76	43.50	14.74	Peak
259.890	18.66	4.35	25.67	39.30	36.64	46.00	9.36	Peak
378.230	21.18	5.69	26.28	37.97	38.56	46.00	7.44	Peak
485.900	23.24	6.65	27.04	35.91	38.76	46.00	7.24	Peak
988.360	27.00	9.24	26.69	28.19	37.74	54.00	16.26	Peak

Antenna at Vertical Polarization

Emission Frequency (MHz)	Antenna Factor (dB/m)	Cable Loss (dB)	Preamplifier Gain (dB)	Read Level (dBμV)	Emission Level (dBμV/m)	Limits (dBμV/m)	Margin (dB)	Detector
31.940	22.87	1.46	0.00	12.90	37.23	40.00	2.77	QP
179.380	15.55	3.50	25.87	43.21	36.39	43.50	7.11	Peak
378.230	21.18	5.69	26.28	38.38	38.97	46.00	7.03	Peak
485.900	23.24	6.65	27.04	35.41	38.26	46.00	7.74	Peak
540.220	23.86	6.90	27.24	31.76	35.28	46.00	10.72	Peak
970.900	26.82	9.15	26.75	28.63	37.85	54.00	16.15	Peak

A.2.1.3 Frequency Above 1 GHz to 10th harmonics

Band Edge:

Mode	802.11a	U-NII Band	1
		Frequency	TX 5180MHz

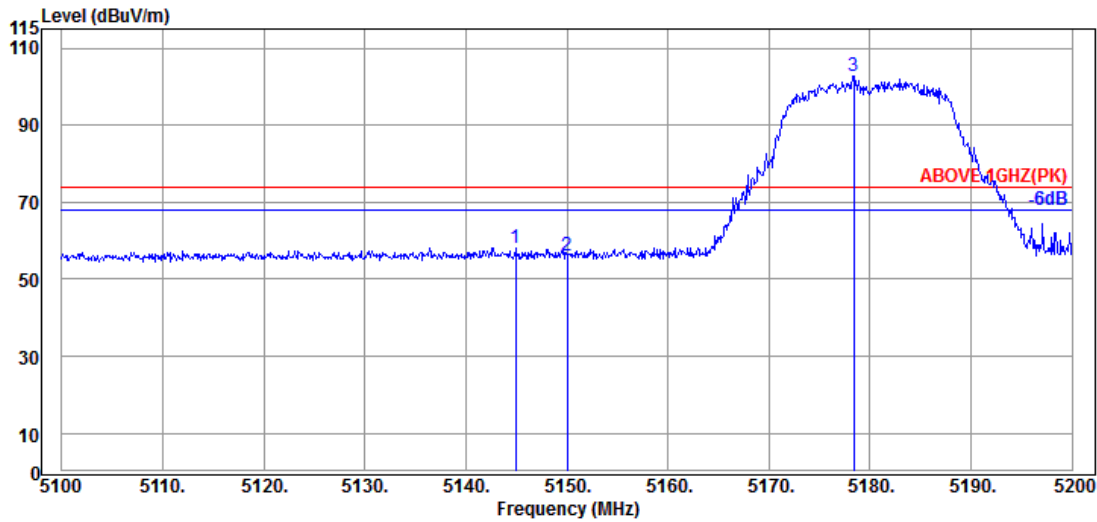

Antenna at Horizontal Polarization

Emission Frequency (MHz)	Antenna Factor (dB/m)	Cable Loss (dB)	Preamplifier Gain (dB)	Read Level (dBμV)	Emission Level (dBμV/m)	Limits (dBμV/m)	Margin (dB)	Detector
5144.900	34.50	8.88	34.34	49.11	58.15	74.00	15.85	Peak
5150.000	34.50	8.88	34.34	46.91	55.95	74.00	18.05	Peak
@ 5178.400	34.63	8.90	34.32	93.62	102.83	---	---	Peak

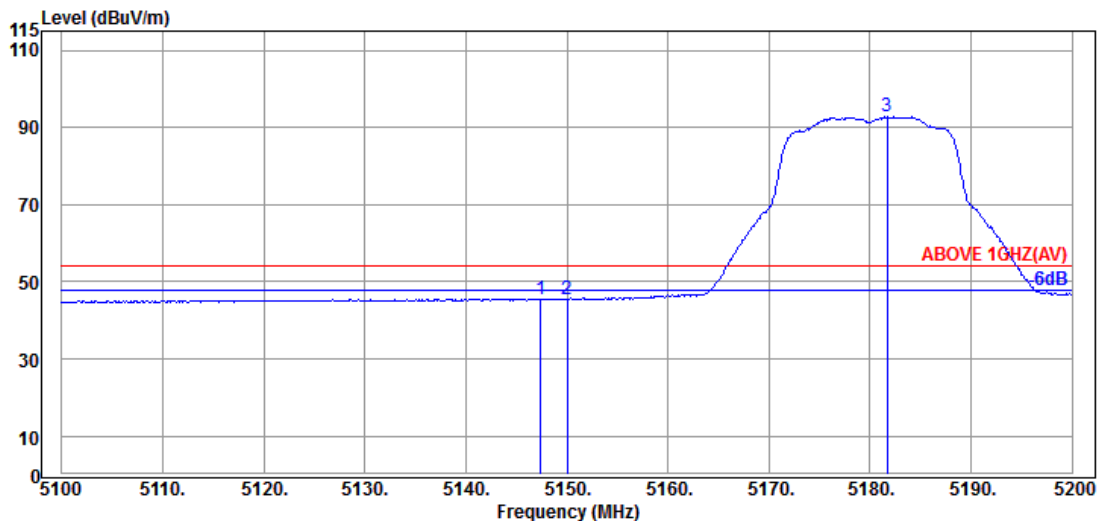

Antenna at Horizontal Polarization

Emission Frequency (MHz)	Antenna Factor (dB/m)	Cable Loss (dB)	Preamplifier Gain (dB)	Read Level (dBμV)	Emission Level (dBμV/m)	Limits (dBμV/m)	Margin (dB)	Detector
5147.400	34.50	8.88	34.34	36.53	45.57	54.00	8.43	Average
5150.000	34.50	8.88	34.34	36.38	45.42	54.00	8.58	Average
@ 5181.700	34.63	8.90	34.32	83.59	92.80	---	---	Average

Remark: The “@” means fundamental frequency, it is ignored in this section.

Mode	802.11a	U-NII Band	1
		Frequency	TX 5180MHz

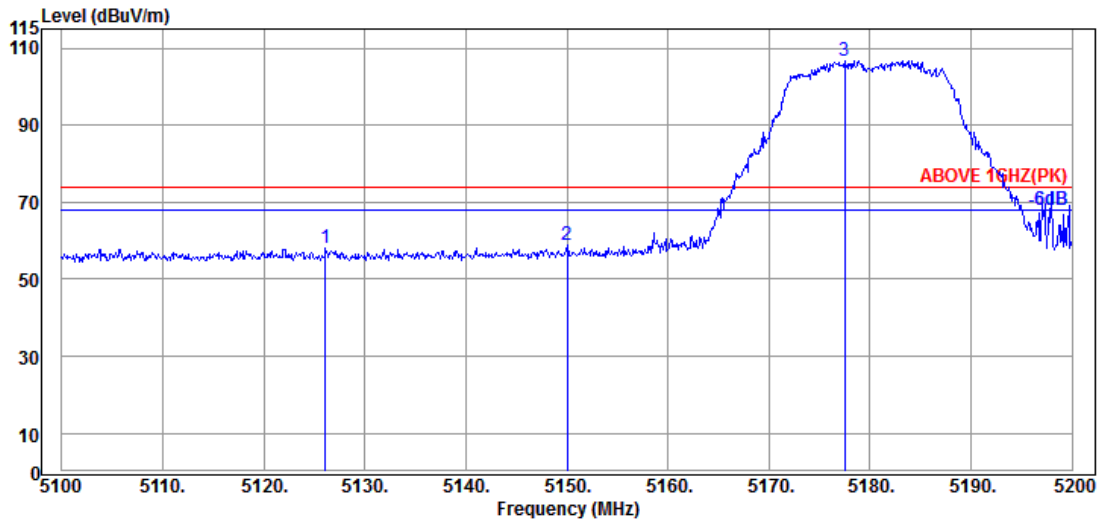

Antenna at Vertical Polarization

Emission Frequency (MHz)	Antenna Factor (dB/m)	Cable Loss (dB)	Preamplifier Gain (dB)	Read Level (dBμV)	Emission Level (dBμV/m)	Limits (dBμV/m)	Margin (dB)	Detector
5126.100	34.30	8.87	34.34	49.09	57.92	74.00	16.08	Peak
5150.000	34.50	8.88	34.34	49.77	58.81	74.00	15.19	Peak
@ 5177.500	34.63	8.90	34.32	97.67	106.88	---	---	Peak

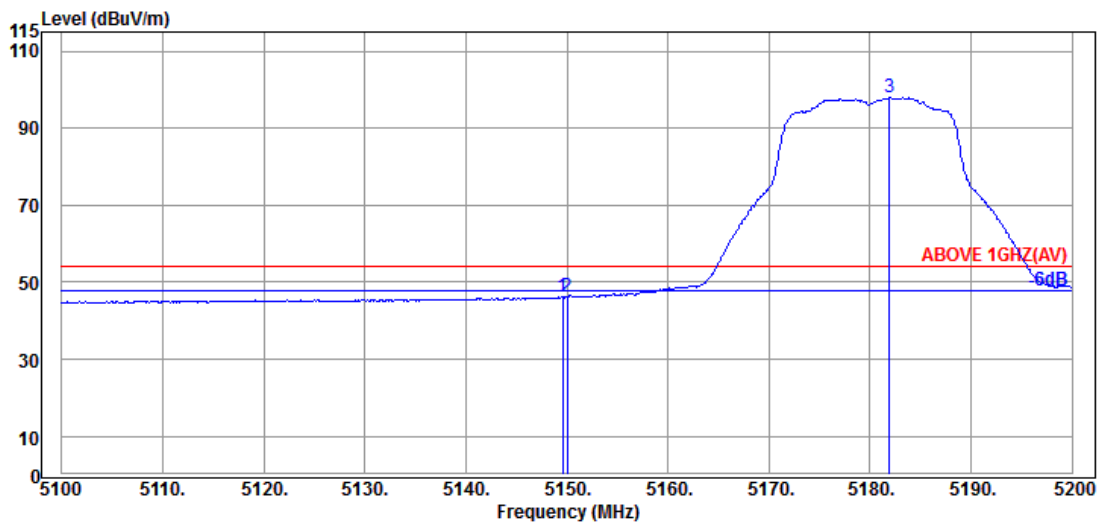

Antenna at Vertical Polarization

Emission Frequency (MHz)	Antenna Factor (dB/m)	Cable Loss (dB)	Preamplifier Gain (dB)	Read Level (dBμV)	Emission Level (dBμV/m)	Limits (dBμV/m)	Margin (dB)	Detector
5149.600	34.50	8.88	34.34	37.12	46.16	54.00	7.84	Average
5150.000	34.50	8.88	34.34	37.21	46.25	54.00	7.75	Average
@ 5181.900	34.63	8.90	34.32	88.79	98.00	---	---	Average

Remark: The “@” means fundamental frequency, it is ignored in this section.

Mode	802.11a	U-NII Band	2A
		Frequency	TX 5320MHz

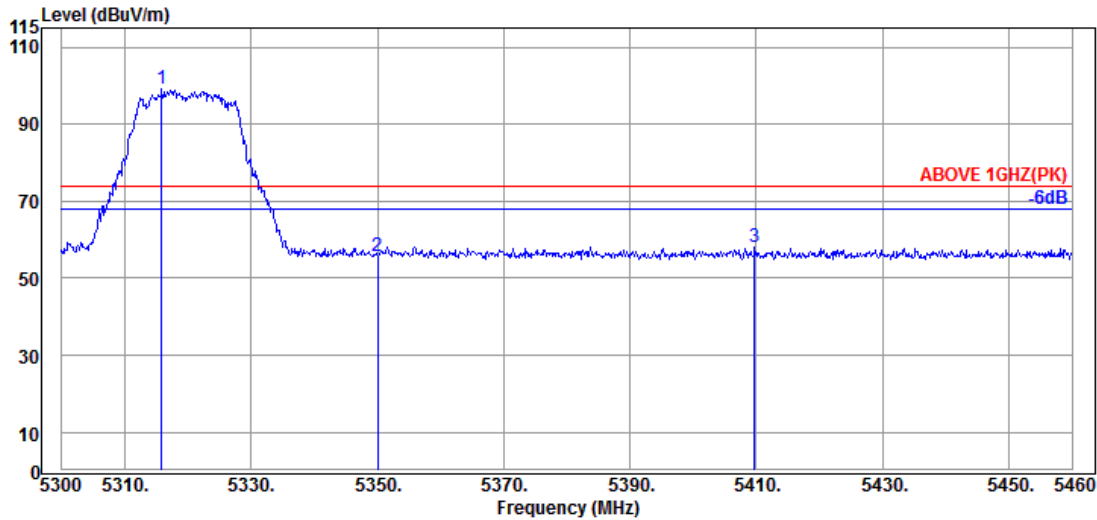

Antenna at Horizontal Polarization

Emission Frequency (MHz)	Antenna Factor (dB/m)	Cable Loss (dB)	Preamp Gain (dB)	Read Level (dBμV)	Emission Level (dBμV/m)	Limits (dBμV/m)	Margin (dB)	Detector
@ 5315.840	34.57	8.98	34.27	89.84	99.12	---	---	Peak
5350.080	34.90	8.99	34.26	46.22	55.85	74.00	18.15	Peak
5409.760	34.75	9.03	34.23	48.63	58.18	74.00	15.82	Peak

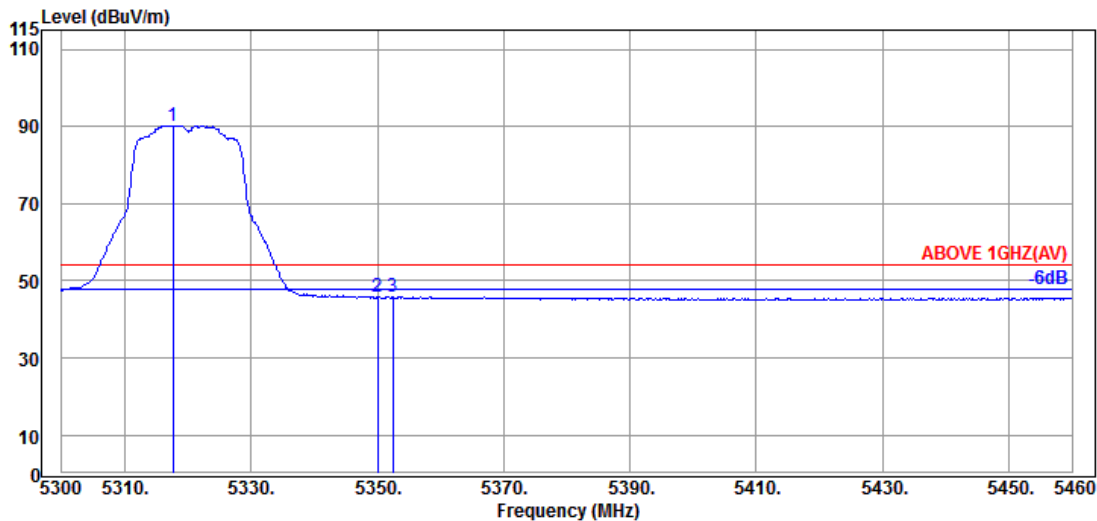

Antenna at Horizontal Polarization

Emission Frequency (MHz)	Antenna Factor (dB/m)	Cable Loss (dB)	Preamp Gain (dB)	Read Level (dBμV)	Emission Level (dBμV/m)	Limits (dBμV/m)	Margin (dB)	Detector
@ 5317.600	34.57	8.98	34.27	80.98	90.26	---	---	Average
5350.080	34.90	8.99	34.26	36.09	45.72	54.00	8.28	Average
5352.480	34.90	8.99	34.26	36.21	45.84	54.00	8.16	Average

Remark: The “@” means fundamental frequency, it is ignored in this section.

Mode	802.11a	U-NII Band	2A
		Frequency	TX 5320MHz

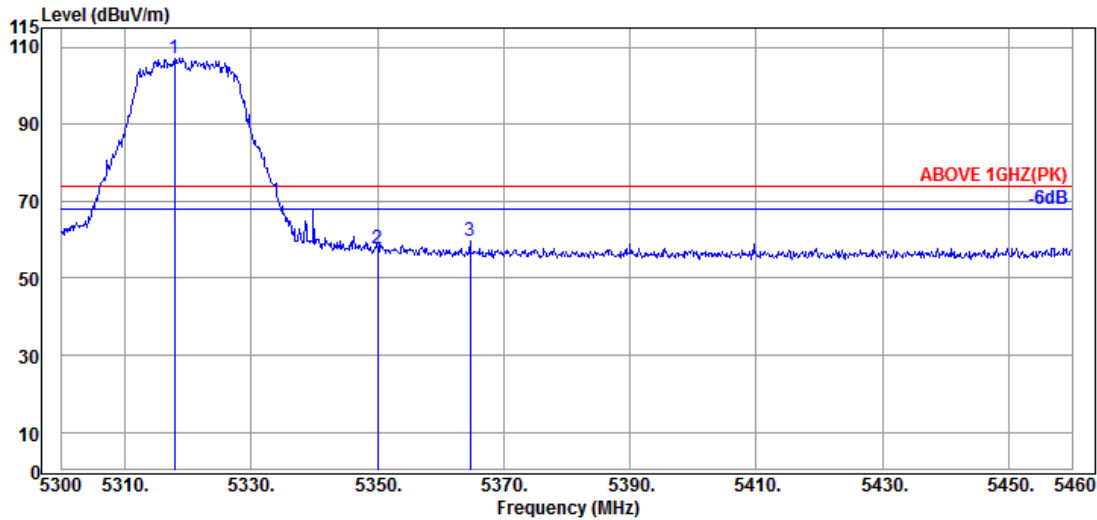

Antenna at Vertical Polarization

Emission Frequency (MHz)	Antenna Factor (dB/m)	Cable Loss (dB)	Preamplifier Gain (dB)	Read Level (dBμV)	Emission Level (dBμV/m)	Limits (dBμV/m)	Margin (dB)	Detector
@ 5317.920	34.57	8.98	34.27	97.80	107.08	---	---	Peak
5350.080	34.90	8.99	34.26	48.10	57.73	74.00	16.27	Peak
5364.640	34.87	9.00	34.25	49.89	59.51	74.00	14.49	Peak

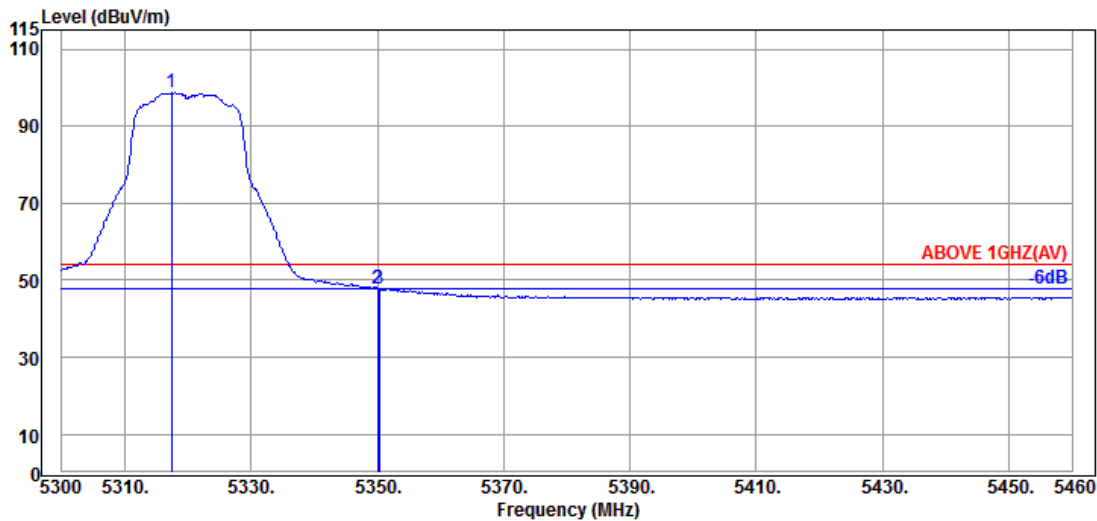

Antenna at Vertical Polarization

Emission Frequency (MHz)	Antenna Factor (dB/m)	Cable Loss (dB)	Preamplifier Gain (dB)	Read Level (dBμV)	Emission Level (dBμV/m)	Limits (dBμV/m)	Margin (dB)	Detector
@ 5317.440	34.57	8.98	34.27	89.45	98.73	---	---	Average
5350.080	34.90	8.99	34.26	38.33	47.96	54.00	6.04	Average
5350.240	34.90	8.99	34.26	38.21	47.84	54.00	6.16	Average

Remark: The “@” means fundamental frequency, it is ignored in this section.

Mode	802.11a	U-NII Band	2C
		Frequency	TX 5500MHz

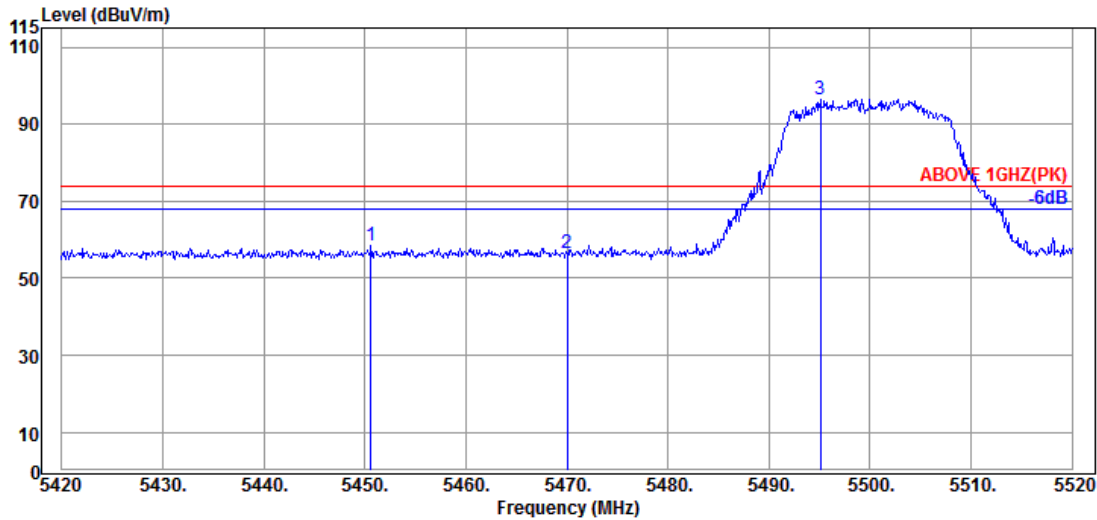

Antenna at Horizontal Polarization

Emission Frequency (MHz)	Antenna Factor (dB/m)	Cable Loss (dB)	Preamp Gain (dB)	Read Level (dBμV)	Emission Level (dBμV/m)	Limits (dBμV/m)	Margin (dB)	Detector
5450.600	34.60	9.05	34.22	49.17	58.60	74.00	15.40	Peak
5470.000	34.63	9.06	34.21	47.16	56.64	74.00	17.36	Peak
@ 5495.100	34.67	9.07	34.20	86.93	96.47	---	---	Peak

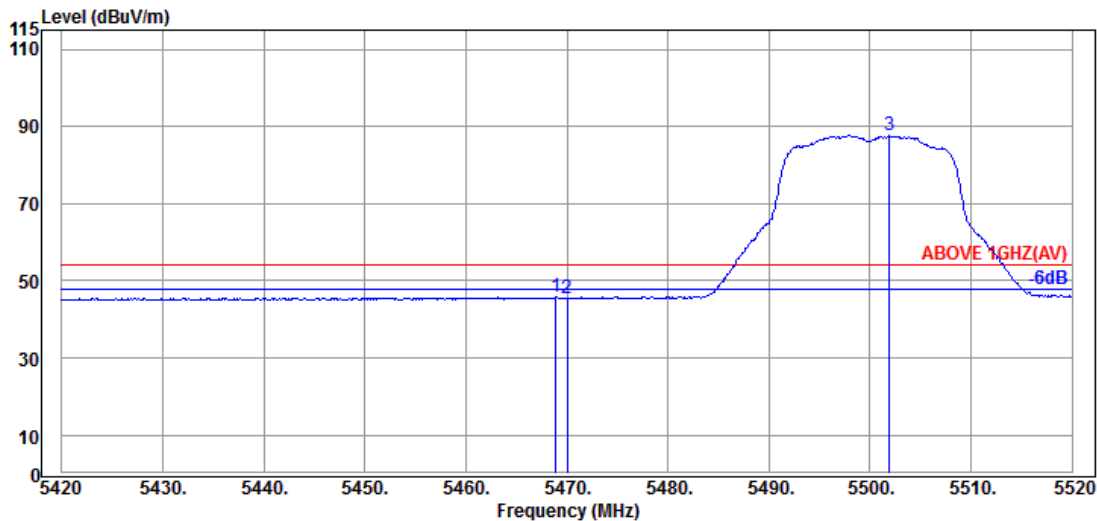

Antenna at Horizontal Polarization

Emission Frequency (MHz)	Antenna Factor (dB/m)	Cable Loss (dB)	Preamp Gain (dB)	Read Level (dBμV)	Emission Level (dBμV/m)	Limits (dBμV/m)	Margin (dB)	Detector
5468.900	34.63	9.06	34.21	36.27	45.75	54.00	8.25	Average
5470.000	34.63	9.06	34.21	35.95	45.43	54.00	8.57	Average
@ 5501.900	34.70	9.08	34.20	77.99	87.57	---	---	Average

Remark: The “@” means fundamental frequency, it is ignored in this section.

Mode	802.11a	U-NII Band	2C
		Frequency	TX 5500MHz

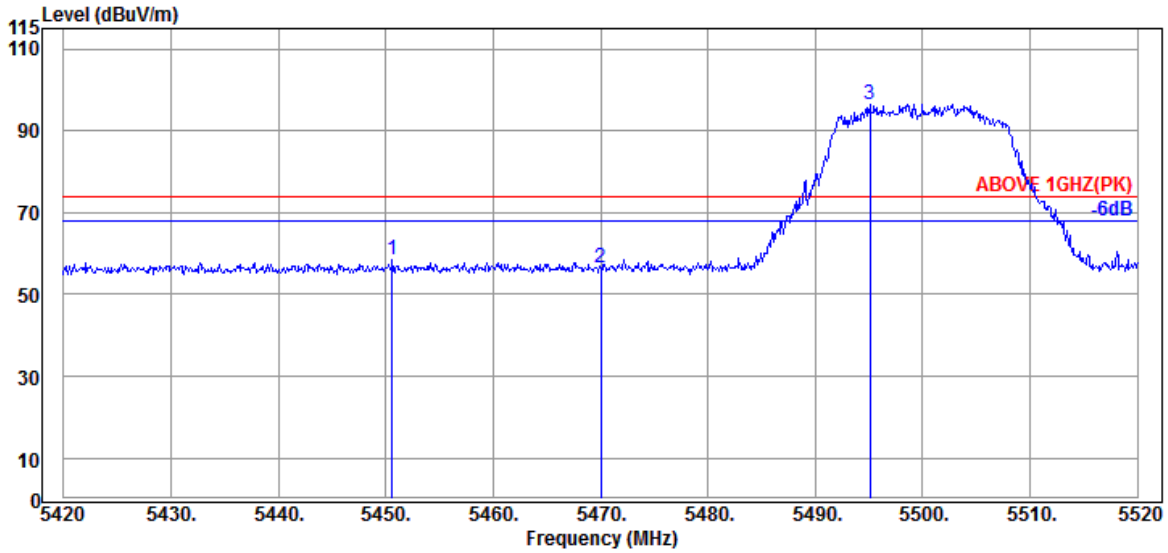

Antenna at Vertical Polarization

Emission Frequency (MHz)	Antenna Factor (dB/m)	Cable Loss (dB)	Preamplifier Gain (dB)	Read Level (dBμV)	Emission Level (dBμV/m)	Limits (dBμV/m)	Margin (dB)	Detector
5466.700	34.63	9.06	34.21	49.41	58.89	74.00	15.11	Peak
5470.000	34.63	9.06	34.21	47.68	57.16	74.00	16.84	Peak
@ 5495.800	34.70	9.08	34.20	99.04	108.62	---	---	Peak

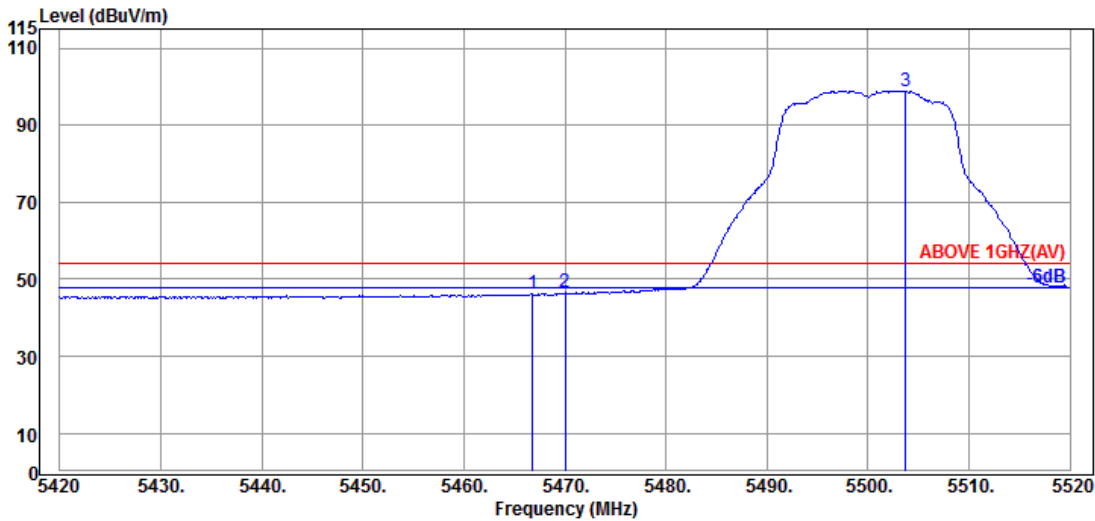

Antenna at Vertical Polarization

Emission Frequency (MHz)	Antenna Factor (dB/m)	Cable Loss (dB)	Preamplifier Gain (dB)	Read Level (dBμV)	Emission Level (dBμV/m)	Limits (dBμV/m)	Margin (dB)	Detector
5466.800	34.63	9.06	34.21	36.71	46.19	54.00	7.81	Average
5470.000	34.63	9.06	34.21	37.00	46.48	54.00	7.52	Average
@ 5503.700	34.70	9.08	34.20	89.40	98.98	---	---	Average

Remark: The “@” means fundamental frequency, it is ignored in this section.

Mode	802.11a	U-NII Band	2C
		Frequency	TX 5700MHz

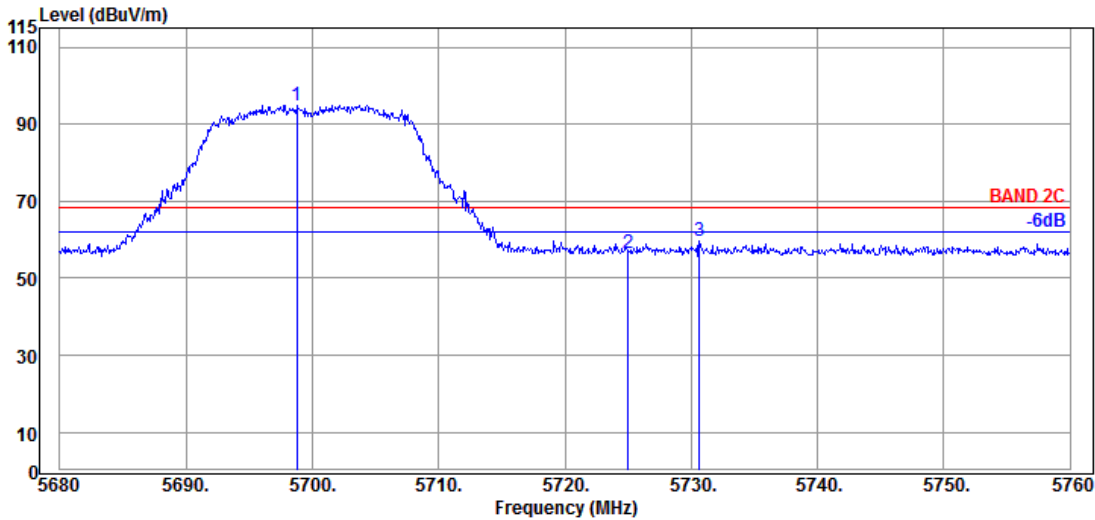

Antenna at Horizontal Polarization

Emission Frequency (MHz)	Antenna Factor (dB/m)	Cable Loss (dB)	Preamplifier Gain (dB)	Read Level (dBμV)	Emission Level (dBμV/m)	Limits (dBμV/m)	Margin (dB)	Detector
@ 5698.800	34.70	9.18	34.29	85.45	95.04	---	---	Peak
5725.040	34.90	9.20	34.30	46.71	56.51	68.20	11.69	Peak
5730.640	34.90	9.20	34.31	49.95	59.74	68.20	8.46	Peak

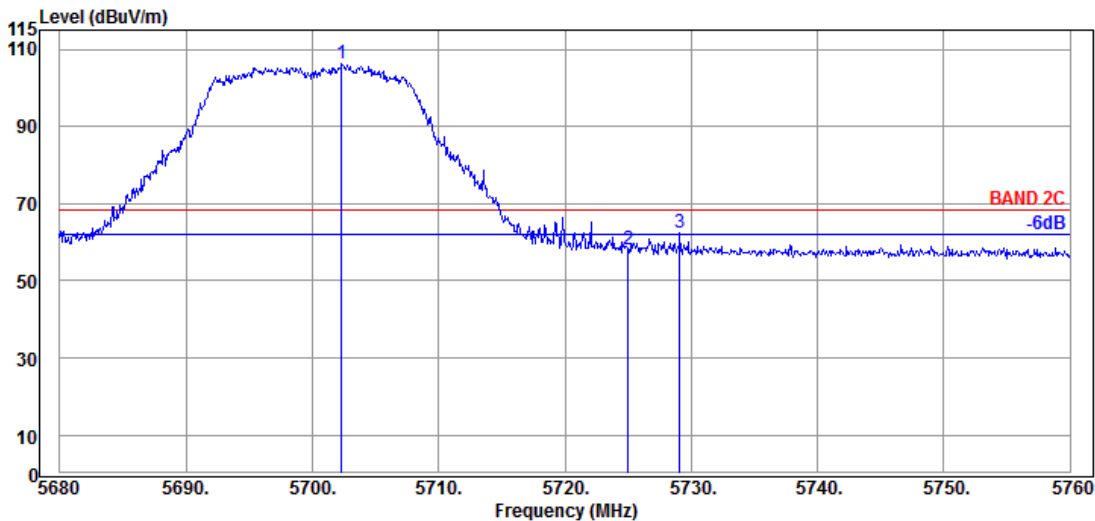

Antenna at Vertical Polarization

Emission Frequency (MHz)	Antenna Factor (dB/m)	Cable Loss (dB)	Preamplifier Gain (dB)	Read Level (dBμV)	Emission Level (dBμV/m)	Limits (dBμV/m)	Margin (dB)	Detector
@ 5702.320	34.70	9.18	34.29	96.69	106.28	---	---	Peak
5725.040	34.90	9.20	34.30	48.31	58.11	68.20	10.09	Peak
5729.120	34.90	9.20	34.31	52.63	62.42	68.20	5.78	Peak

Remark: The “@” means fundamental frequency, it is ignored in this section.

Mode	802.11a	U-NII Band	2C
		Frequency	TX 5720MHz

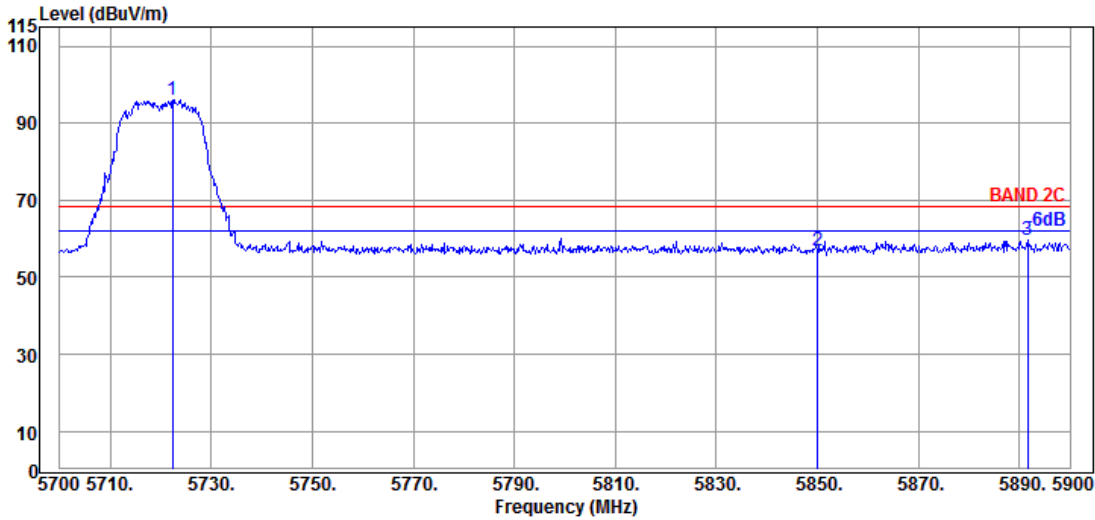

Antenna at Horizontal Polarization

Emission Frequency (MHz)	Antenna Factor (dB/m)	Cable Loss (dB)	Preamp Gain (dB)	Read Level (dBμV)	Emission Level (dBμV/m)	Limits (dBμV/m)	Margin (dB)	Detector
@ 5722.400	34.90	9.20	34.30	86.39	96.19	---	---	Peak
5850.000	35.40	9.25	34.36	46.48	56.77	68.20	11.43	Peak
5891.600	35.80	9.28	34.38	49.06	59.76	68.20	8.44	Peak

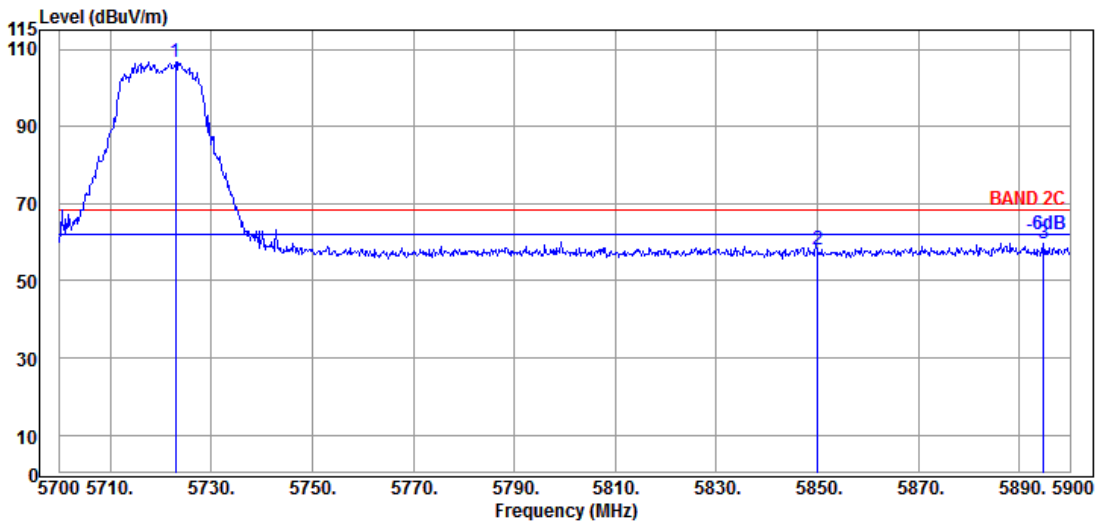

Antenna at Vertical Polarization

Emission Frequency (MHz)	Antenna Factor (dB/m)	Cable Loss (dB)	Preamp Gain (dB)	Read Level (dBμV)	Emission Level (dBμV/m)	Limits (dBμV/m)	Margin (dB)	Detector
@ 5723.000	34.90	9.20	34.30	97.02	106.82	---	---	Peak
5850.000	35.40	9.25	34.36	47.66	57.95	68.20	10.25	Peak
5894.800	35.80	9.28	34.38	49.16	59.86	68.20	8.34	Peak

Remark: The “@” means fundamental frequency, it is ignored in this section.

Mode	802.11a	U-NII Band	2C
		Frequency	TX 5720MHz

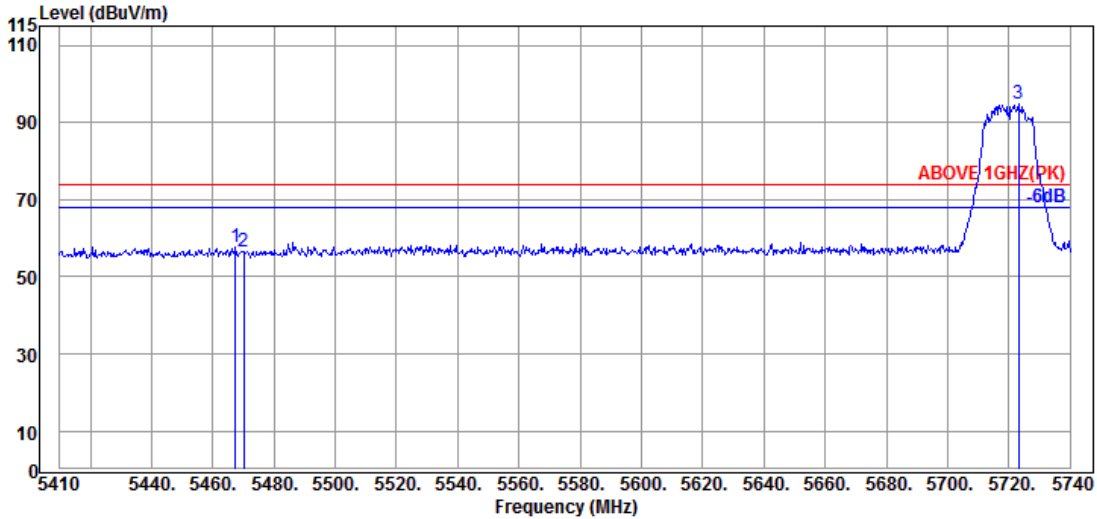

Antenna at Horizontal Polarization

Emission Frequency (MHz)	Antenna Factor (dB/m)	Cable Loss (dB)	Preamp Gain (dB)	Read Level (dBμV)	Emission Level (dBμV/m)	Limits (dBμV/m)	Margin (dB)	Detector
5467.420	34.63	9.06	34.21	48.37	57.85	74.00	16.15	Peak
5470.060	34.63	9.06	34.21	47.02	56.50	74.00	17.50	Peak
@ 5723.170	34.90	9.20	34.30	84.95	94.75	---	---	Peak

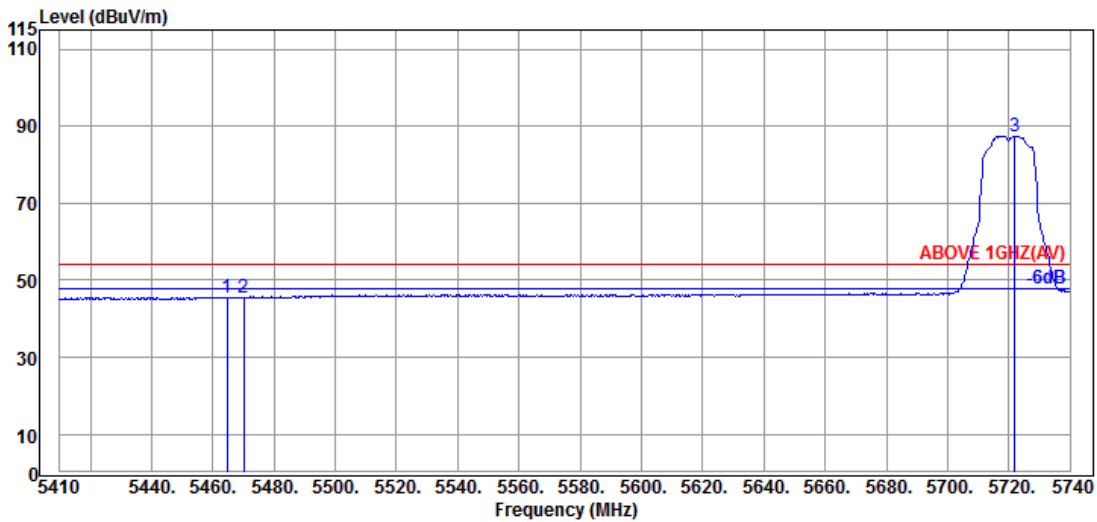

Antenna at Horizontal Polarization

Emission Frequency (MHz)	Antenna Factor (dB/m)	Cable Loss (dB)	Preamp Gain (dB)	Read Level (dBμV)	Emission Level (dBμV/m)	Limits (dBμV/m)	Margin (dB)	Detector
5464.780	34.63	9.06	34.21	36.07	45.55	54.00	8.45	Average
5470.060	34.63	9.06	34.21	35.92	45.40	54.00	8.60	Average
@ 5721.850	34.80	9.19	34.30	77.84	87.53	---	---	Average

Remark: The "@" means fundamental frequency, it is ignored in this section.

Mode	802.11a	U-NII Band	2C
		Frequency	TX 5720MHz

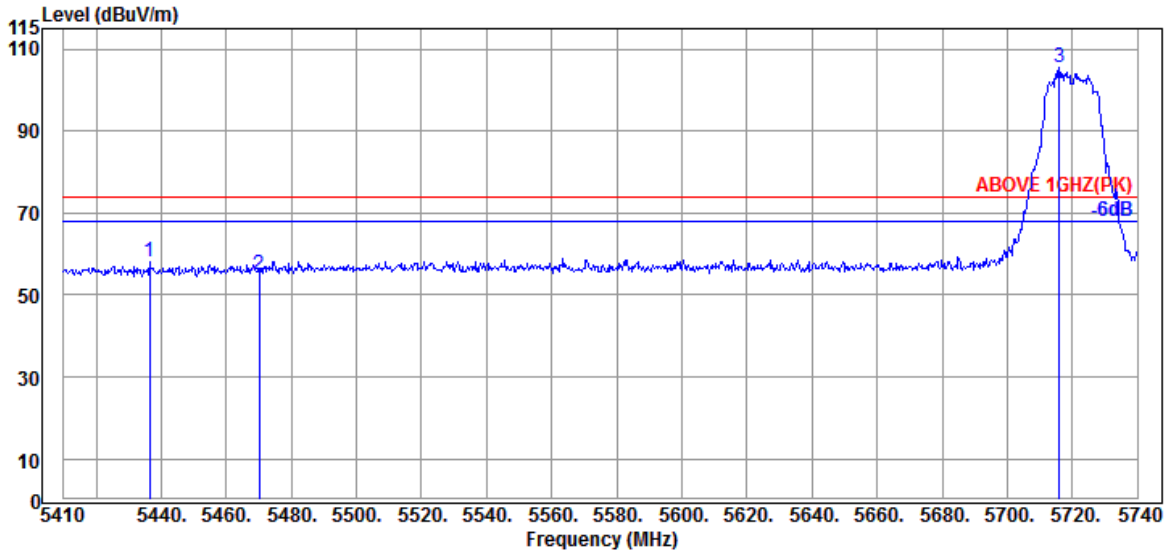

Antenna at Vertical Polarization

Emission Frequency (MHz)	Antenna Factor (dB/m)	Cable Loss (dB)	Preamplifier Gain (dB)	Read Level (dBμV)	Emission Level (dBμV/m)	Limits (dBμV/m)	Margin (dB)	Detector
5436.400	34.65	9.04	34.22	48.66	58.13	74.00	15.87	Peak
5470.060	34.63	9.06	34.21	45.46	54.94	74.00	19.06	Peak
@ 5715.910	34.80	9.19	34.30	95.67	105.36	---	---	Peak

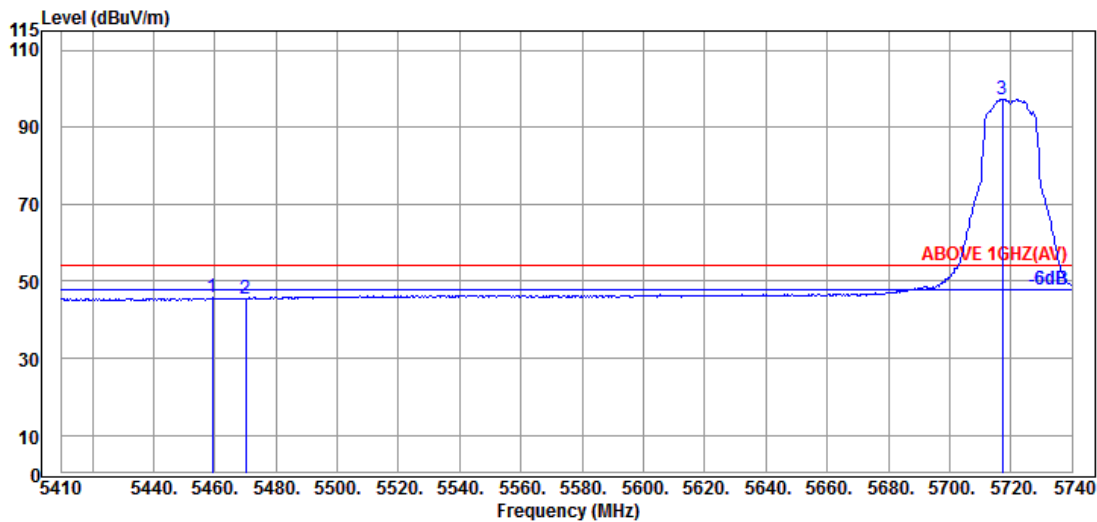

Antenna at Vertical Polarization

Emission Frequency (MHz)	Antenna Factor (dB/m)	Cable Loss (dB)	Preamplifier Gain (dB)	Read Level (dBμV)	Emission Level (dBμV/m)	Limits (dBμV/m)	Margin (dB)	Detector
5459.170	34.60	9.05	34.21	36.26	45.70	54.00	8.30	Average
5470.060	34.63	9.06	34.21	36.02	45.50	54.00	8.50	Average
@ 5717.230	34.80	9.19	34.30	87.61	97.30	---	---	Average

Remark: The “@” means fundamental frequency, it is ignored in this section.

Mode	802.11a	U-NII Band	3
		Frequency	TX 5745MHz

Antenna at Horizontal Polarization

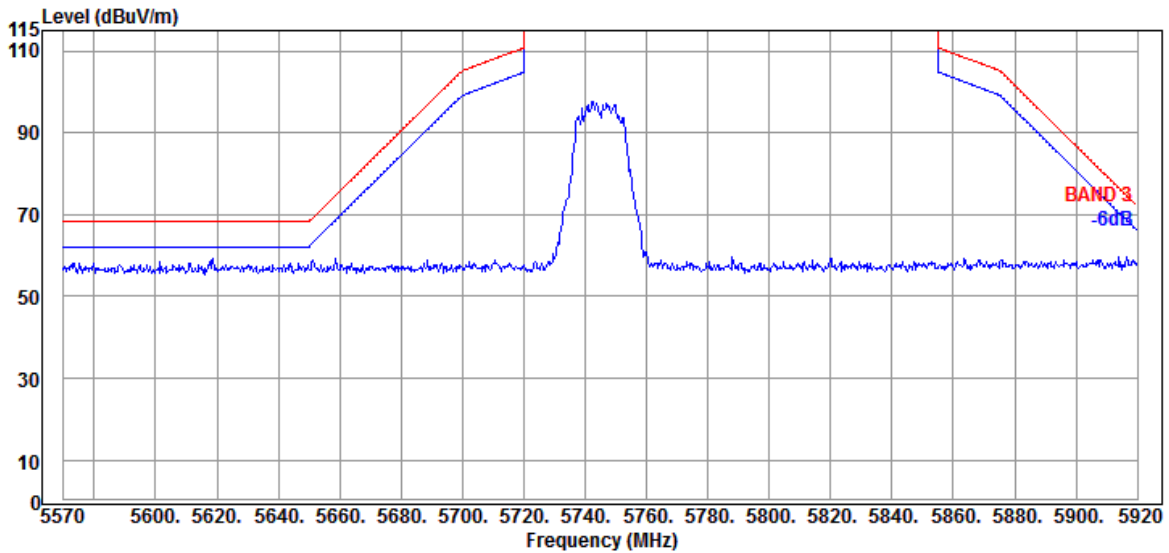

Antenna at Vertical Polarization

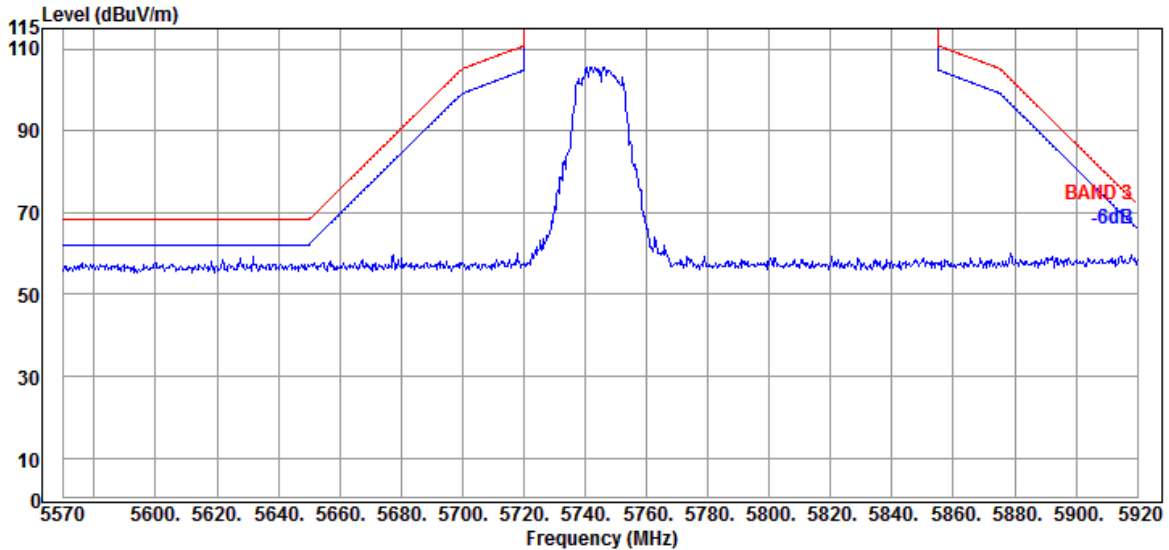

Mode	802.11a	U-NII Band	3
		Frequency	TX 5825MHz

Antenna at Horizontal Polarization

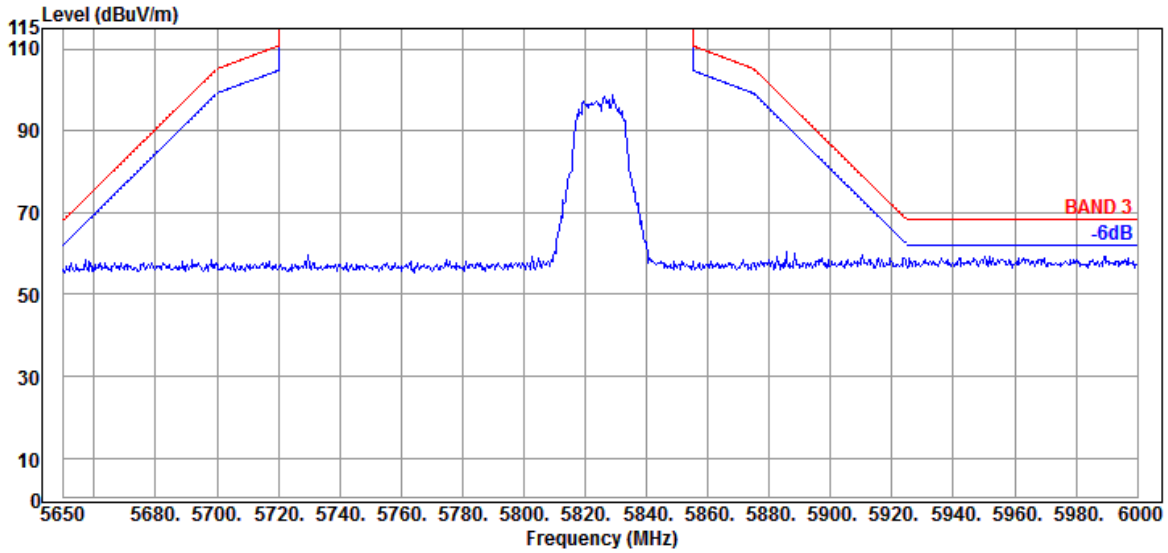

Antenna at Vertical Polarization

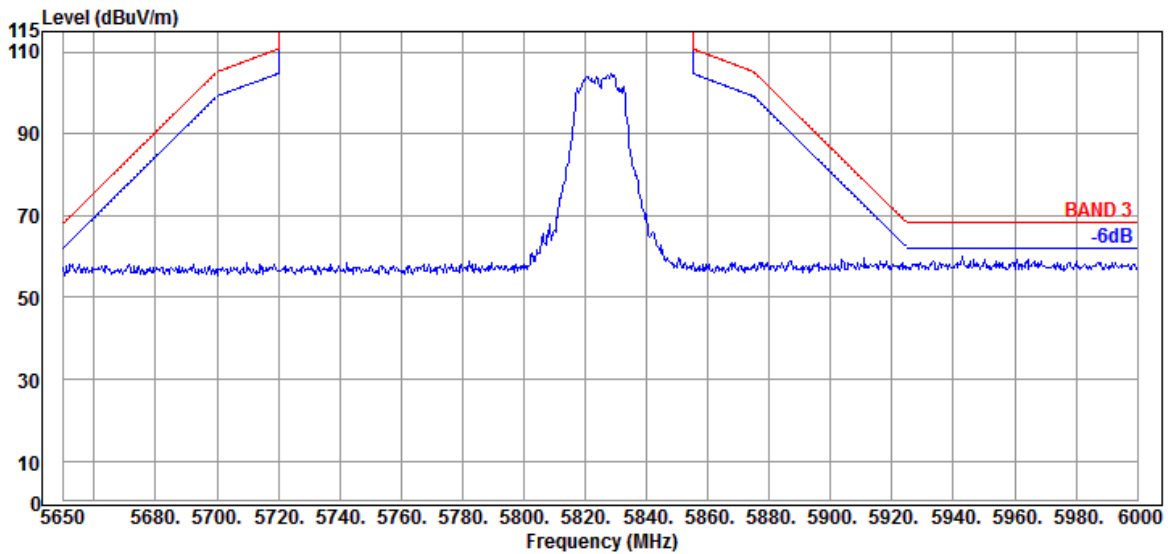

Mode	802.11n-HT20	U-NII Band	1
		Frequency	TX 5180MHz

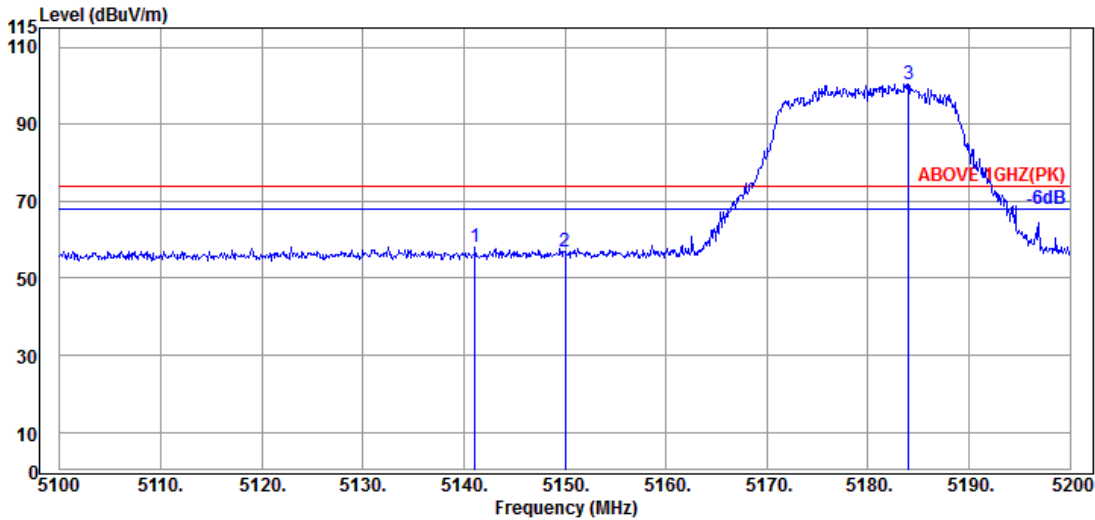

Antenna at Horizontal Polarization

Emission Frequency (MHz)	Antenna Factor (dB/m)	Cable Loss (dB)	Preamplifier Gain (dB)	Read Level (dBμV)	Emission Level (dBμV/m)	Limits (dBμV/m)	Margin (dB)	Detector
5141.100	34.40	8.88	34.34	49.24	58.18	74.00	15.82	Peak
5150.000	34.50	8.88	34.34	47.90	56.94	74.00	17.06	Peak
@ 5184.000	34.63	8.90	34.32	91.21	100.42	---	---	Peak

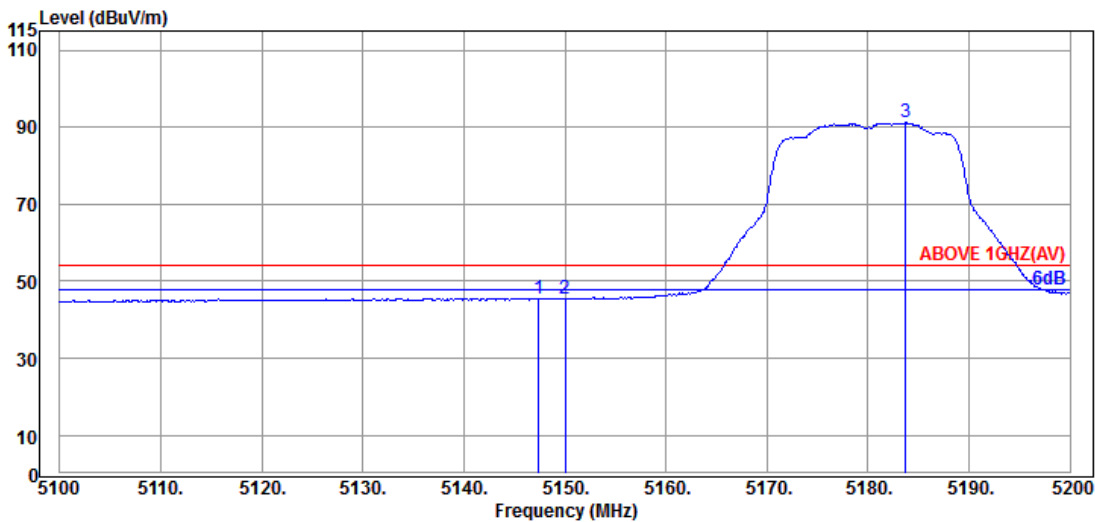

Antenna at Horizontal Polarization

Emission Frequency (MHz)	Antenna Factor (dB/m)	Cable Loss (dB)	Preamplifier Gain (dB)	Read Level (dBμV)	Emission Level (dBμV/m)	Limits (dBμV/m)	Margin (dB)	Detector
5147.400	34.50	8.88	34.34	36.52	45.56	54.00	8.44	Average
5150.000	34.50	8.88	34.34	36.26	45.30	54.00	8.70	Average
@ 5183.700	34.63	8.90	34.32	82.02	91.23	---	---	Average

Remark: The “@” means fundamental frequency, it is ignored in this section.

Mode	802.11n-HT20	U-NII Band	1
		Frequency	TX 5180MHz

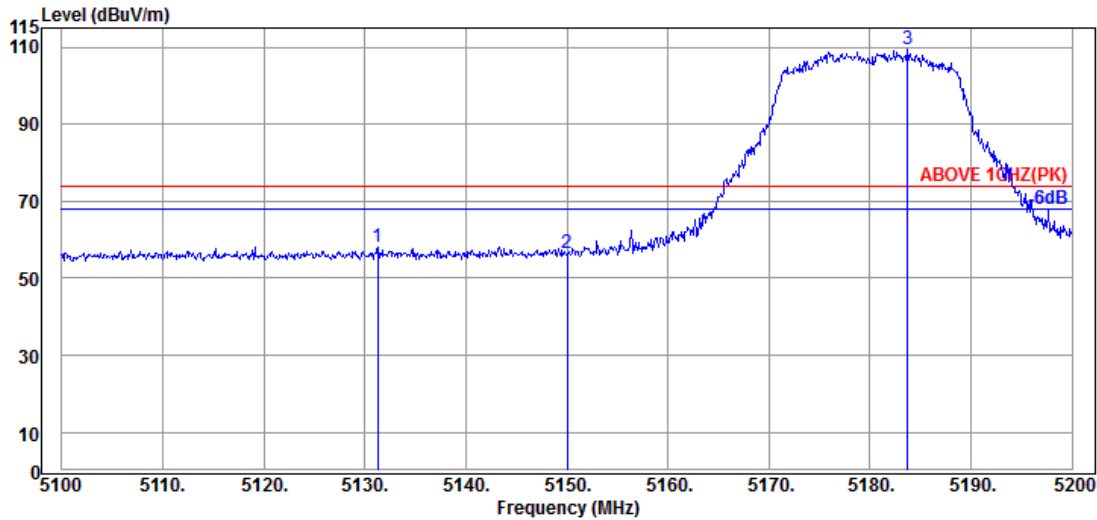

Antenna at Vertical Polarization

Emission Frequency (MHz)	Antenna Factor (dB/m)	Cable Loss (dB)	Preamp Gain (dB)	Read Level (dBμV)	Emission Level (dBμV/m)	Limits (dBμV/m)	Margin (dB)	Detector
5131.300	34.40	8.88	34.34	49.03	57.97	74.00	16.03	Peak
5150.000	34.50	8.88	34.34	47.59	56.63	74.00	17.37	Peak
@ 5183.700	34.63	8.90	34.32	100.23	109.44	---	---	Peak

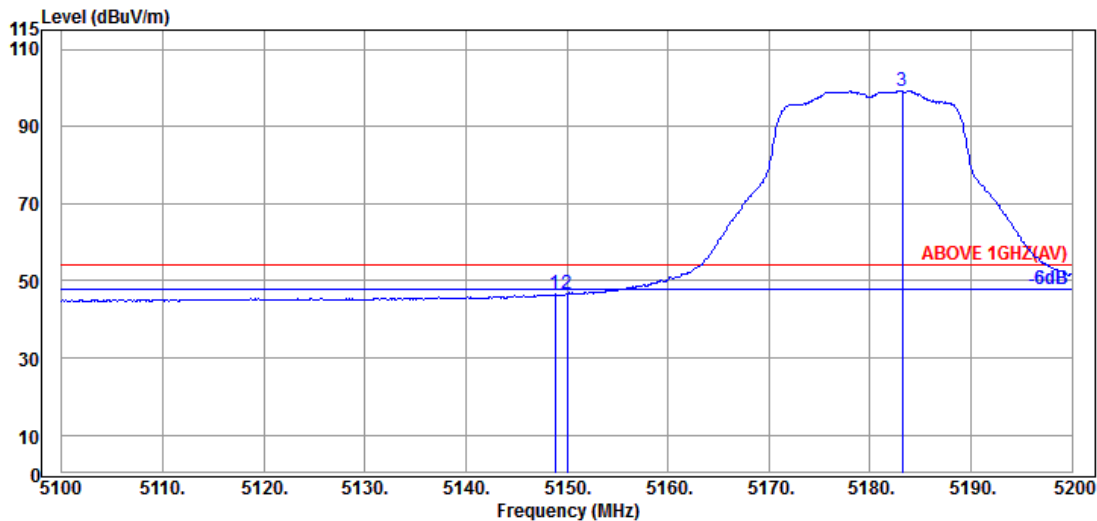

Antenna at Vertical Polarization

Emission Frequency (MHz)	Antenna Factor (dB/m)	Cable Loss (dB)	Preamp Gain (dB)	Read Level (dBμV)	Emission Level (dBμV/m)	Limits (dBμV/m)	Margin (dB)	Detector
5148.800	34.50	8.88	34.34	37.45	46.49	54.00	7.51	Average
5150.000	34.50	8.88	34.34	37.61	46.65	54.00	7.35	Average
@ 5183.200	34.63	8.90	34.32	89.97	99.18	---	---	Average

Remark: The “@” means fundamental frequency, it is ignored in this section.

Mode	802.11n-HT20	U-NII Band	2A
		Frequency	TX 5320MHz

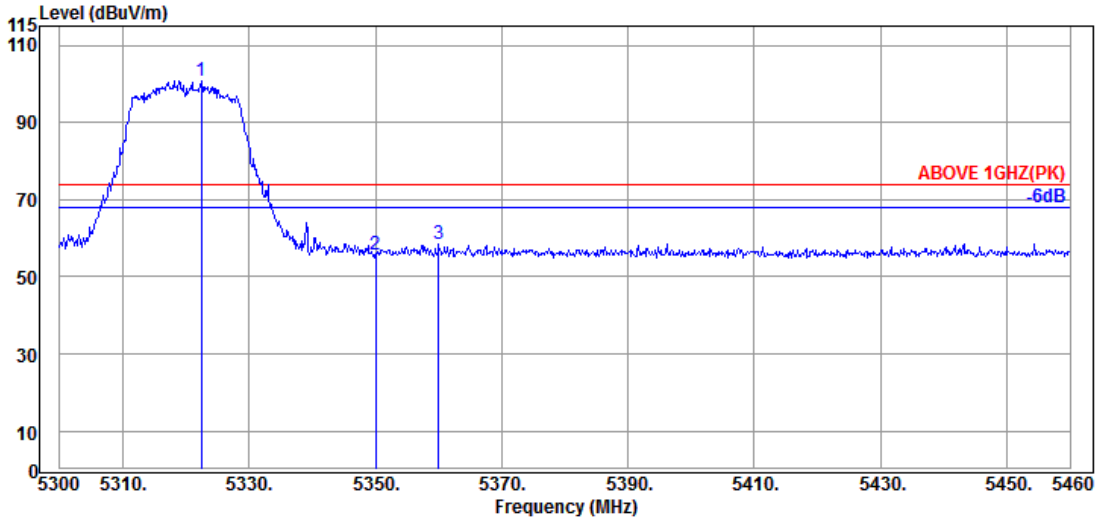

Antenna at Horizontal Polarization

Emission Frequency (MHz)	Antenna Factor (dB/m)	Cable Loss (dB)	Preamp Gain (dB)	Read Level (dBμV)	Emission Level (dBμV/m)	Limits (dBμV/m)	Margin (dB)	Detector
@ 5322.400	34.57	8.98	34.27	91.57	100.85	---	---	Peak
5350.080	34.90	8.99	34.26	46.03	55.66	74.00	18.34	Peak
5360.000	34.87	9.00	34.26	49.07	58.68	74.00	15.32	Peak

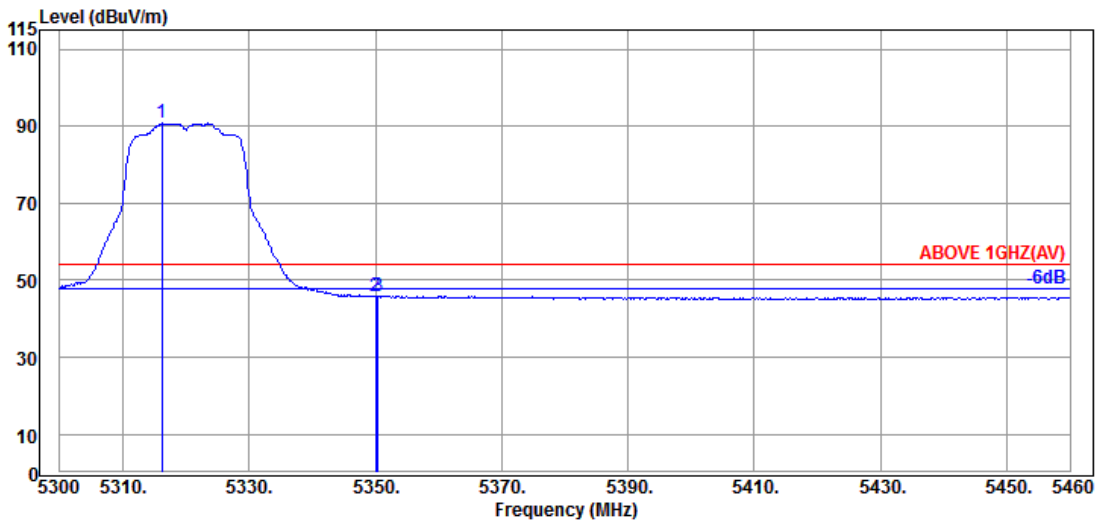

Antenna at Horizontal Polarization

Emission Frequency (MHz)	Antenna Factor (dB/m)	Cable Loss (dB)	Preamp Gain (dB)	Read Level (dBμV)	Emission Level (dBμV/m)	Limits (dBμV/m)	Margin (dB)	Detector
@ 5316.160	34.57	8.98	34.27	81.48	90.76	---	---	Average
5350.080	34.90	8.99	34.26	36.12	45.75	54.00	8.25	Average
5350.400	34.90	8.99	34.26	36.20	45.83	54.00	8.17	Average

Remark: The “@” means fundamental frequency, it is ignored in this section.

Mode	802.11n-HT20	U-NII Band	2A
		Frequency	TX 5320MHz

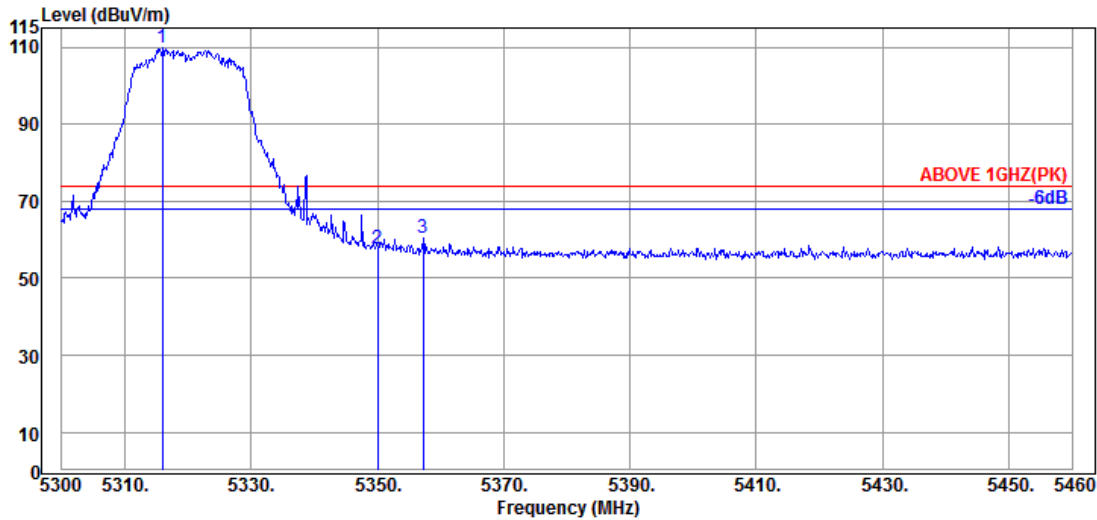

Antenna at Vertical Polarization

Emission Frequency (MHz)	Antenna Factor (dB/m)	Cable Loss (dB)	Preamp Gain (dB)	Read Level (dBμV)	Emission Level (dBμV/m)	Limits (dBμV/m)	Margin (dB)	Detector
@ 5316.000	34.57	8.98	34.27	100.58	109.86	---	---	Peak
5350.080	34.90	8.99	34.26	48.05	57.68	74.00	16.32	Peak
5357.280	34.87	9.00	34.26	50.72	60.33	74.00	13.67	Peak

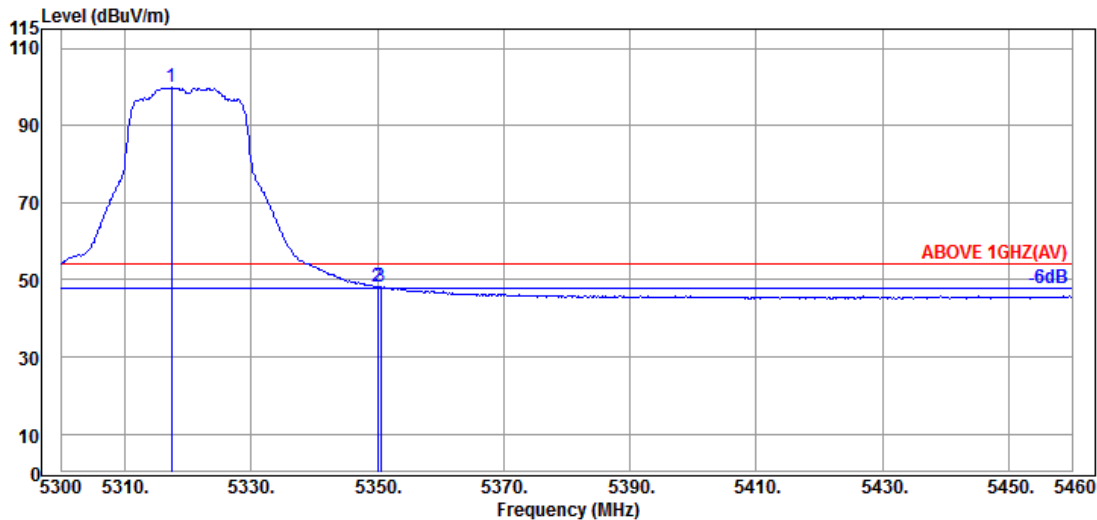

Antenna at Vertical Polarization

Emission Frequency (MHz)	Antenna Factor (dB/m)	Cable Loss (dB)	Preamp Gain (dB)	Read Level (dBμV)	Emission Level (dBμV/m)	Limits (dBμV/m)	Margin (dB)	Detector
@ 5317.440	34.57	8.98	34.27	90.51	99.79	---	---	Average
5350.080	34.90	8.99	34.26	38.68	48.31	54.00	5.69	Average
5350.560	34.90	8.99	34.26	38.73	48.36	54.00	5.64	Average

Remark: The “@” means fundamental frequency, it is ignored in this section.

Mode	802.11n-HT20	U-NII Band	2C
		Frequency	TX 5500MHz

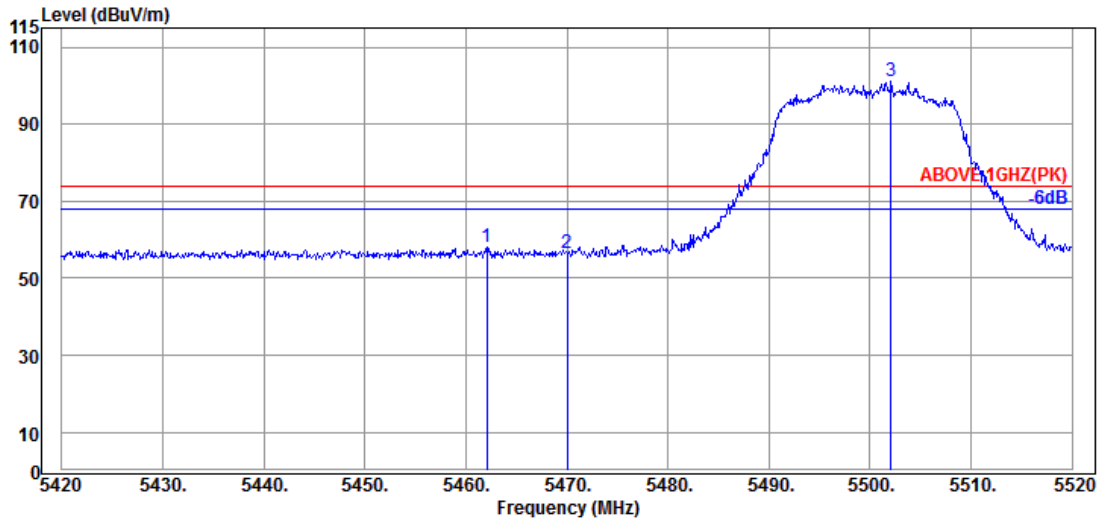

Antenna at Horizontal Polarization

Emission Frequency (MHz)	Antenna Factor (dB/m)	Cable Loss (dB)	Preamp Gain (dB)	Read Level (dBμV)	Emission Level (dBμV/m)	Limits (dBμV/m)	Margin (dB)	Detector
5462.100	34.60	9.05	34.21	48.49	57.93	74.00	16.07	Peak
5470.000	34.63	9.06	34.21	46.89	56.37	74.00	17.63	Peak
@ 5502.100	34.70	9.08	34.20	91.65	101.23	---	---	Peak

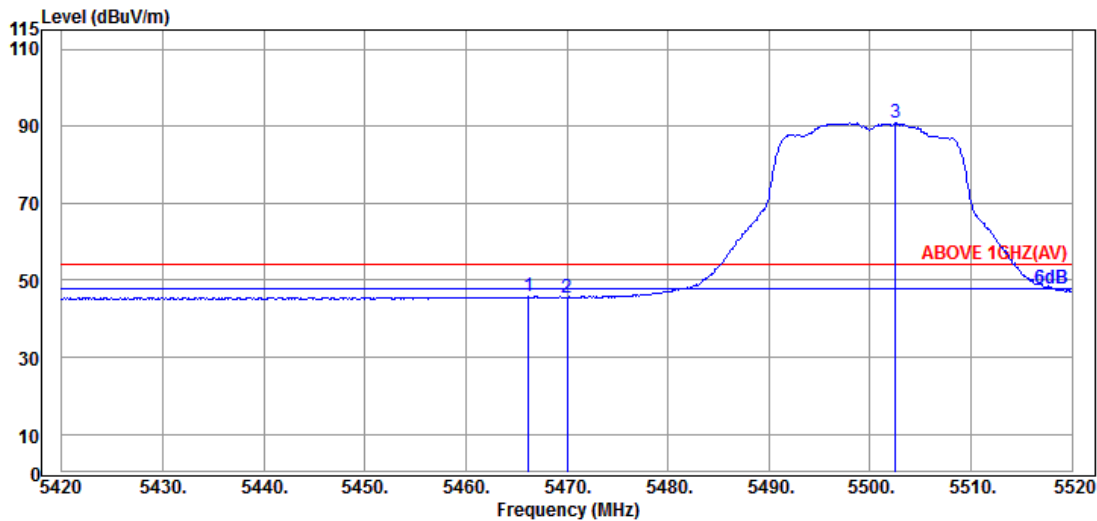

Antenna at Horizontal Polarization

Emission Frequency (MHz)	Antenna Factor (dB/m)	Cable Loss (dB)	Preamp Gain (dB)	Read Level (dBμV)	Emission Level (dBμV/m)	Limits (dBμV/m)	Margin (dB)	Detector
5466.200	34.63	9.06	34.21	36.28	45.76	54.00	8.24	Average
5470.000	34.63	9.06	34.21	36.04	45.52	54.00	8.48	Average
@ 5502.500	34.70	9.08	34.20	81.19	90.77	---	---	Average

Remark: The “@” means fundamental frequency, it is ignored in this section.

Mode	802.11n-HT20	U-NII Band	2C
		Frequency	TX 5500MHz

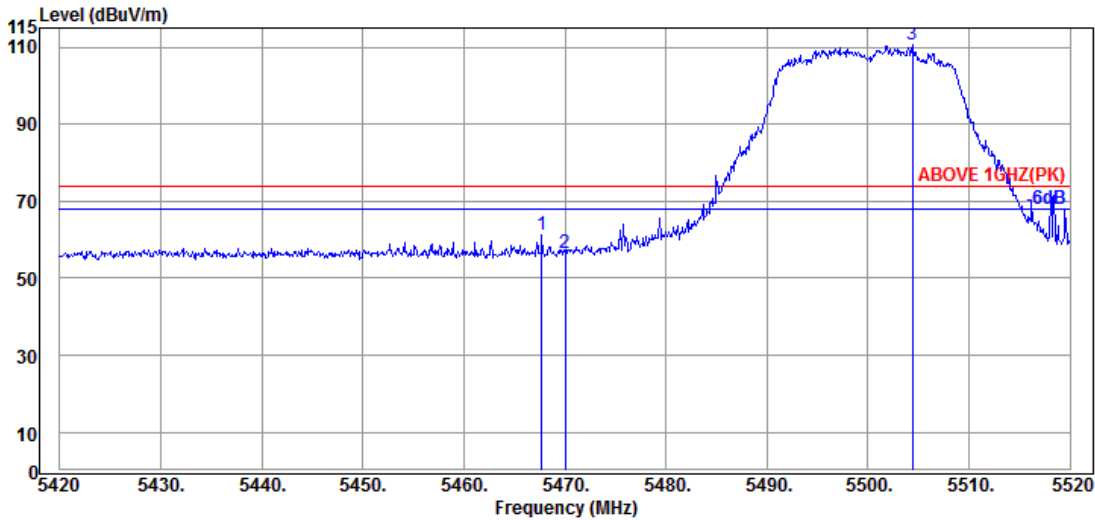

Antenna at Vertical Polarization

Emission Frequency (MHz)	Antenna Factor (dB/m)	Cable Loss (dB)	Preamp Gain (dB)	Read Level (dBμV)	Emission Level (dBμV/m)	Limits (dBμV/m)	Margin (dB)	Detector
5467.700	34.63	9.06	34.21	51.79	61.27	74.00	12.73	Peak
5470.000	34.63	9.06	34.21	46.84	56.32	74.00	17.68	Peak
@ 5504.400	34.70	9.08	34.20	100.88	110.46	---	---	Peak

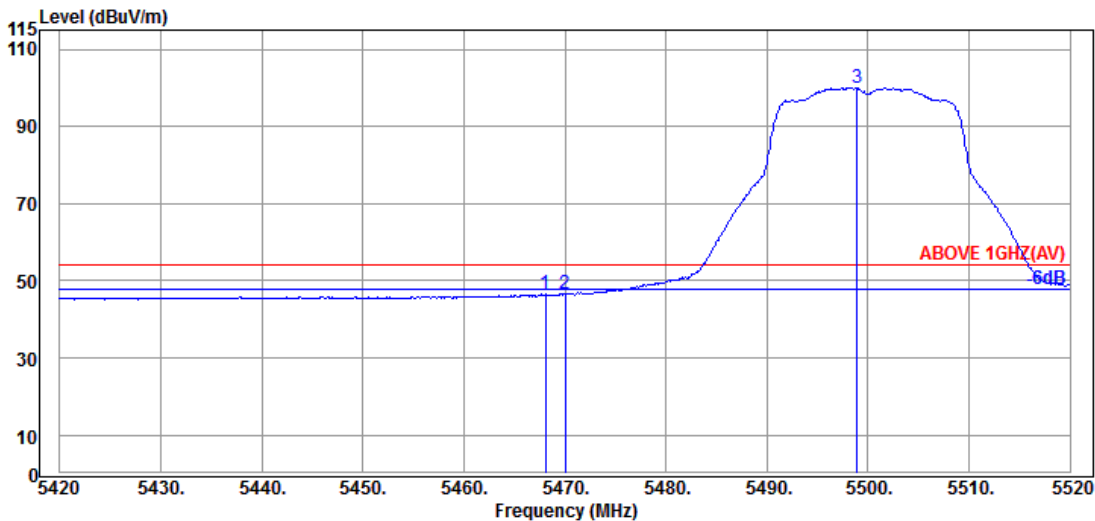

Antenna at Vertical Polarization

Emission Frequency (MHz)	Antenna Factor (dB/m)	Cable Loss (dB)	Preamp Gain (dB)	Read Level (dBμV)	Emission Level (dBμV/m)	Limits (dBμV/m)	Margin (dB)	Detector
5468.100	34.63	9.06	34.21	36.98	46.46	54.00	7.54	Average
5470.000	34.63	9.06	34.21	37.06	46.54	54.00	7.46	Average
@ 5498.900	34.70	9.08	34.20	90.54	100.12	---	---	Average

Remark: The “@” means fundamental frequency, it is ignored in this section.

Mode	802.11n-HT20	U-NII Band	2C
		Frequency	TX 5700MHz

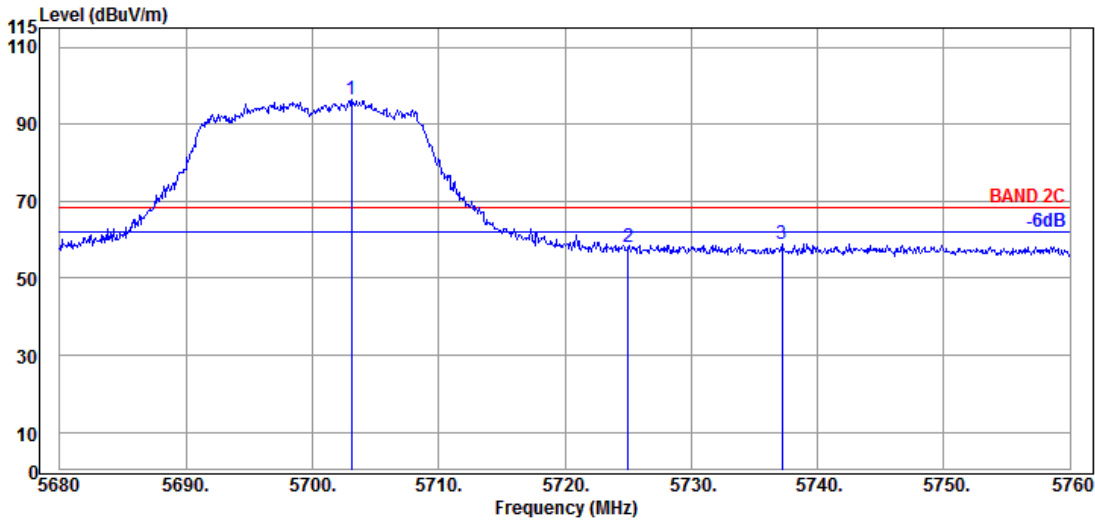

Antenna at Horizontal Polarization

Emission Frequency (MHz)	Antenna Factor (dB/m)	Cable Loss (dB)	Preamp Gain (dB)	Read Level (dBμV)	Emission Level (dBμV/m)	Limits (dBμV/m)	Margin (dB)	Detector
@ 5703.120	34.70	9.18	34.29	86.88	96.47	---	---	Peak
5725.040	34.90	9.20	34.30	48.39	58.19	68.20	10.01	Peak
5737.200	34.90	9.20	34.31	49.24	59.03	68.20	9.17	Peak

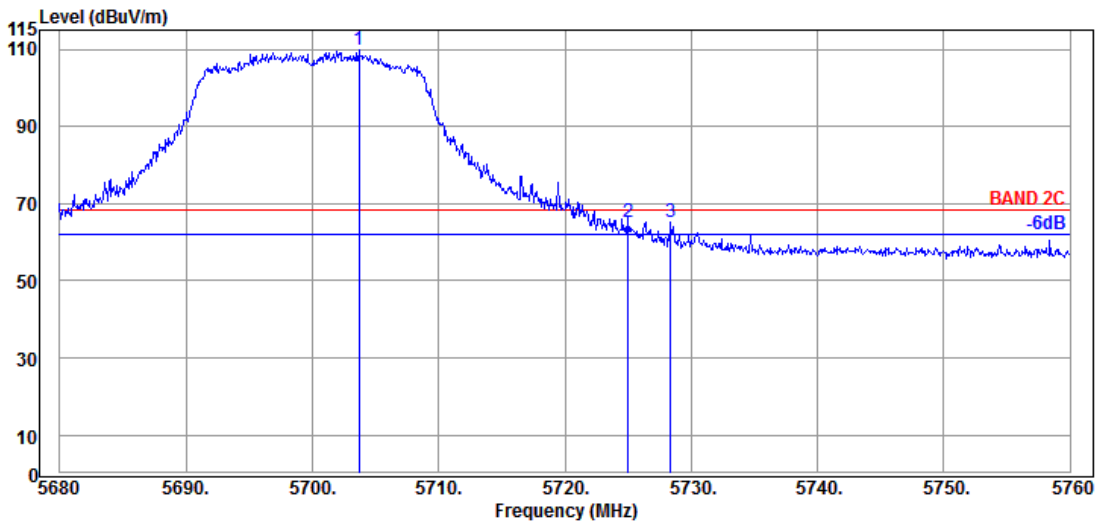

Antenna at Vertical Polarization

Emission Frequency (MHz)	Antenna Factor (dB/m)	Cable Loss (dB)	Preamp Gain (dB)	Read Level (dBμV)	Emission Level (dBμV/m)	Limits (dBμV/m)	Margin (dB)	Detector
@ 5703.680	34.70	9.18	34.29	100.12	109.71	---	---	Peak
5725.040	34.90	9.20	34.30	55.27	65.07	68.20	3.13	Peak
5728.400	34.90	9.20	34.31	55.58	65.37	68.20	2.83	Peak

Remark: The “@” means fundamental frequency, it is ignored in this section.

Mode	802.11n-HT20	U-NII Band	2C
		Frequency	TX 5720MHz

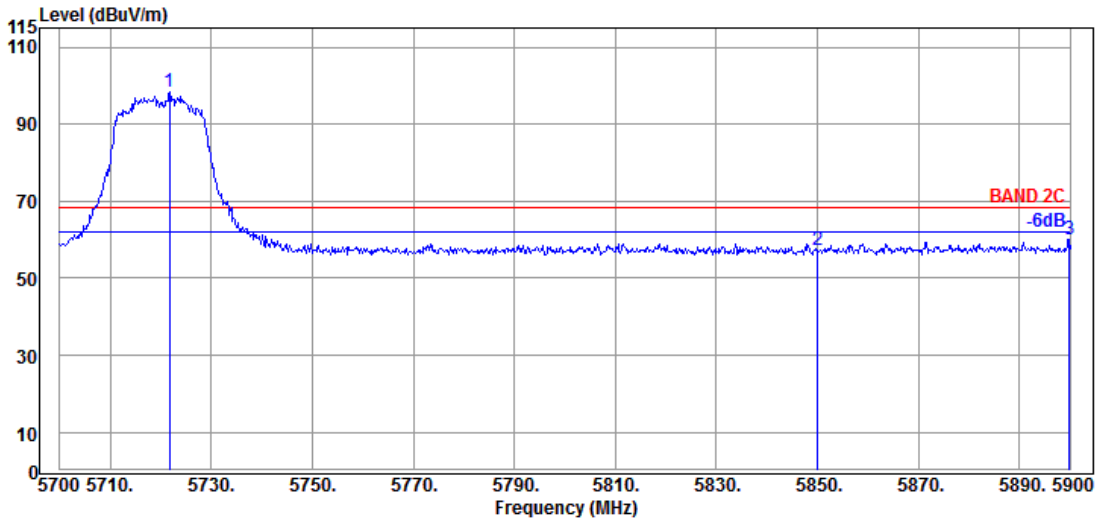

Antenna at Horizontal Polarization

Emission Frequency (MHz)	Antenna Factor (dB/m)	Cable Loss (dB)	Preamp Gain (dB)	Read Level (dBμV)	Emission Level (dBμV/m)	Limits (dBμV/m)	Margin (dB)	Detector
@ 5716.000	34.80	9.19	34.30	99.80	109.49	---	---	Peak
5850.000	35.40	9.25	34.36	46.54	56.83	68.20	11.37	Peak
5887.000	35.67	9.27	34.38	48.71	59.27	68.20	8.93	Peak

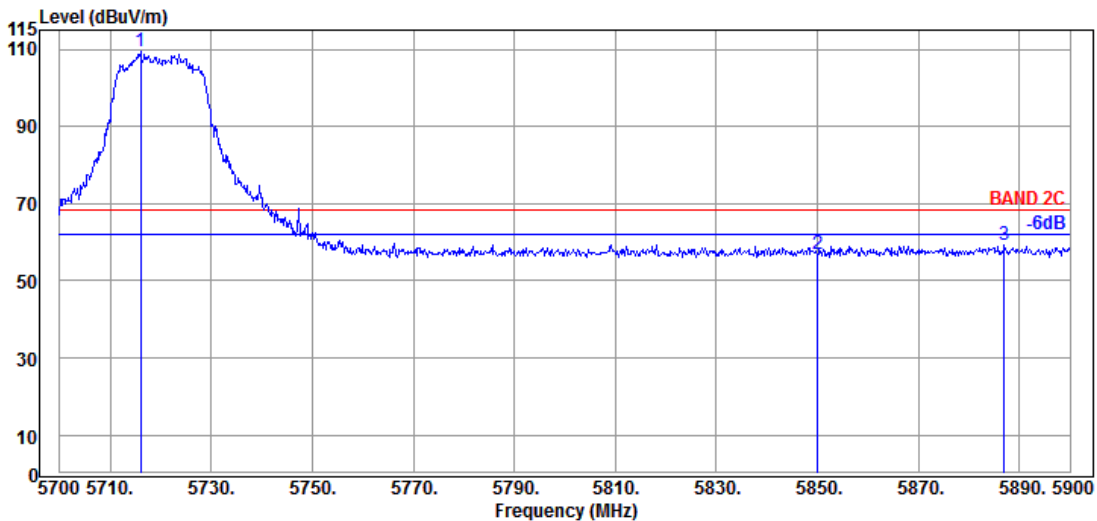

Antenna at Vertical Polarization

Emission Frequency (MHz)	Antenna Factor (dB/m)	Cable Loss (dB)	Preamp Gain (dB)	Read Level (dBμV)	Emission Level (dBμV/m)	Limits (dBμV/m)	Margin (dB)	Detector
@ 5716.000	34.80	9.19	34.30	99.80	109.49	---	---	Peak
5850.000	35.40	9.25	34.36	46.54	56.83	68.20	11.37	Peak
5887.000	35.67	9.27	34.38	48.71	59.27	68.20	8.93	Peak

Remark: The “@” means fundamental frequency, it is ignored in this section.

Mode	802.11n-HT20	U-NII Band	2C
		Frequency	TX 5720MHz

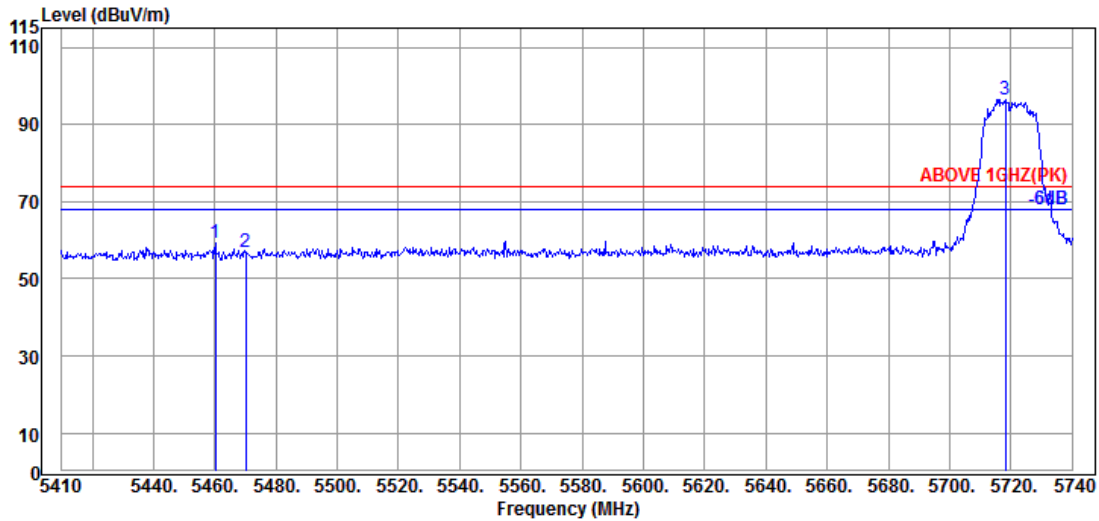

Antenna at Horizontal Polarization

Emission Frequency (MHz)	Antenna Factor (dB/m)	Cable Loss (dB)	Preamplifier Gain (dB)	Read Level (dBμV)	Emission Level (dBμV/m)	Limits (dBμV/m)	Margin (dB)	Detector
5460.160	34.60	9.05	34.21	49.86	59.30	74.00	14.70	Peak
5470.060	34.63	9.06	34.21	47.30	56.78	74.00	17.22	Peak
@ 5718.220	34.80	9.19	34.30	86.91	96.60	---	---	Peak

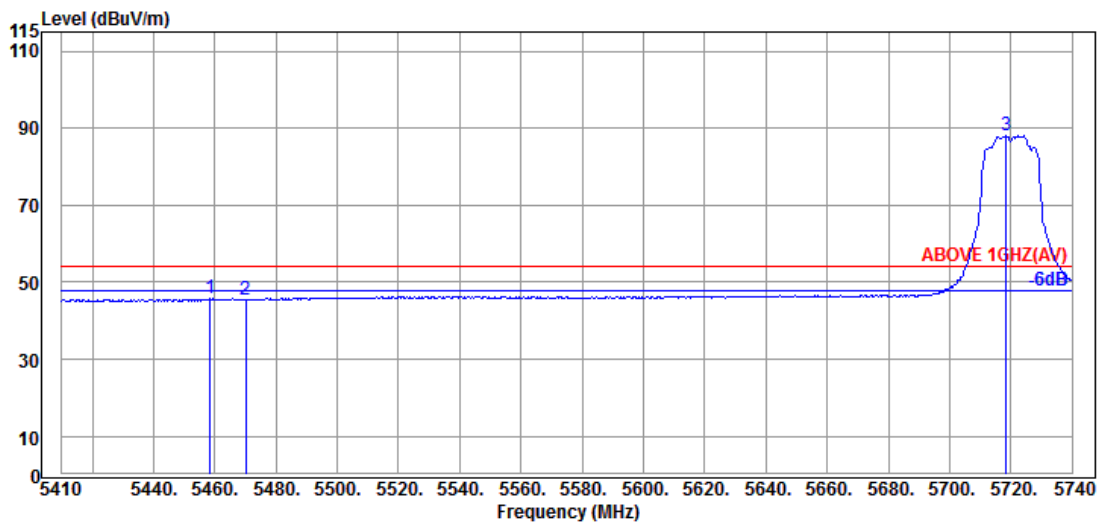

Antenna at Horizontal Polarization

Emission Frequency (MHz)	Antenna Factor (dB/m)	Cable Loss (dB)	Preamplifier Gain (dB)	Read Level (dBμV)	Emission Level (dBμV/m)	Limits (dBμV/m)	Margin (dB)	Detector
5458.510	34.60	9.05	34.21	36.23	45.67	54.00	8.33	Average
5470.060	34.63	9.06	34.21	36.03	45.51	54.00	8.49	Average
@ 5718.550	34.80	9.19	34.30	78.33	88.02	---	---	Average

Remark: The “@” means fundamental frequency, it is ignored in this section.

Mode	802.11n-HT20	U-NII Band	2C
		Frequency	TX 5720MHz

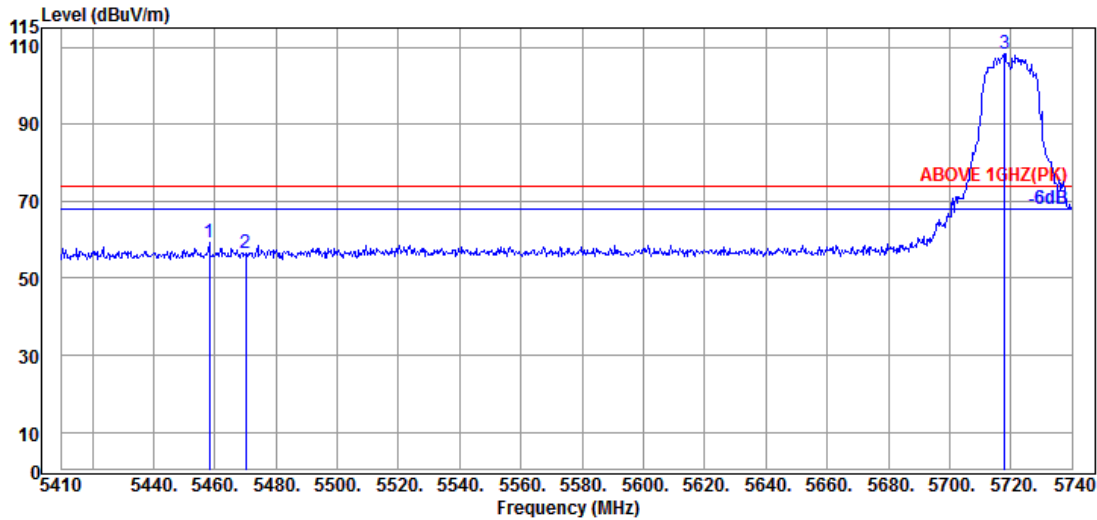

Antenna at Vertical Polarization

Emission Frequency (MHz)	Antenna Factor (dB/m)	Cable Loss (dB)	Preamp Gain (dB)	Read Level (dBμV)	Emission Level (dBUV/m)	Limits (dBUV/m)	Margin (dB)	Detector
5458.180	34.60	9.05	34.21	49.66	59.10	74.00	14.90	Peak
5470.060	34.63	9.06	34.21	46.94	56.42	74.00	17.58	Peak
@ 5717.890	34.80	9.19	34.30	98.71	108.40	---	---	Peak

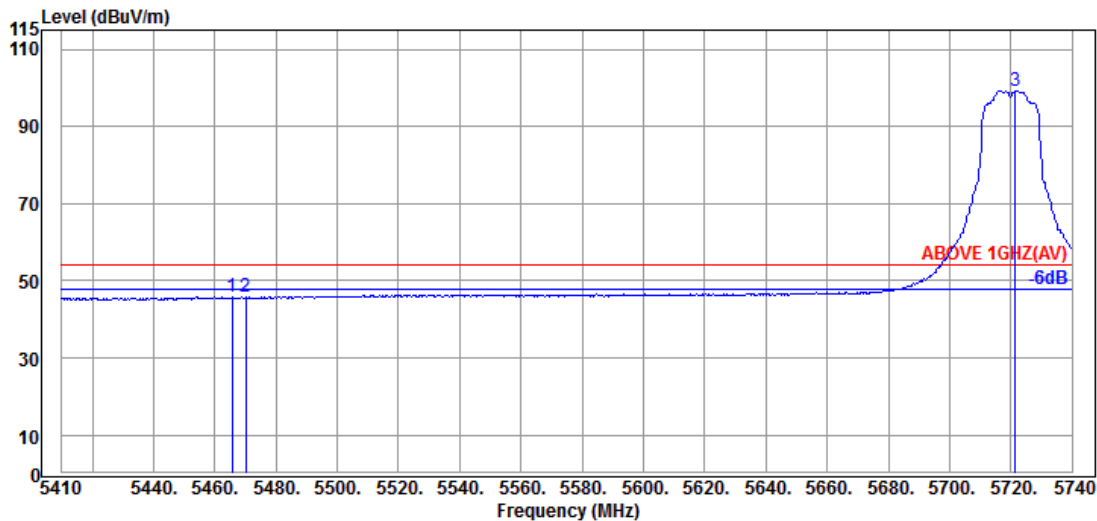

Antenna at Vertical Polarization

Emission Frequency (MHz)	Antenna Factor (dB/m)	Cable Loss (dB)	Preamp Gain (dB)	Read Level (dBμV)	Emission Level (dBUV/m)	Limits (dBUV/m)	Margin (dB)	Detector
5465.770	34.63	9.06	34.21	36.53	46.01	54.00	7.99	Average
5470.060	34.63	9.06	34.21	36.39	45.87	54.00	8.13	Average
@ 5721.520	34.80	9.19	34.30	89.58	99.27	---	---	Average

Remark: The “@” means fundamental frequency, it is ignored in this section.

Mode	802.11n-HT20	U-NII Band	3
		Frequency	TX 5745MHz

Antenna at Horizontal Polarization

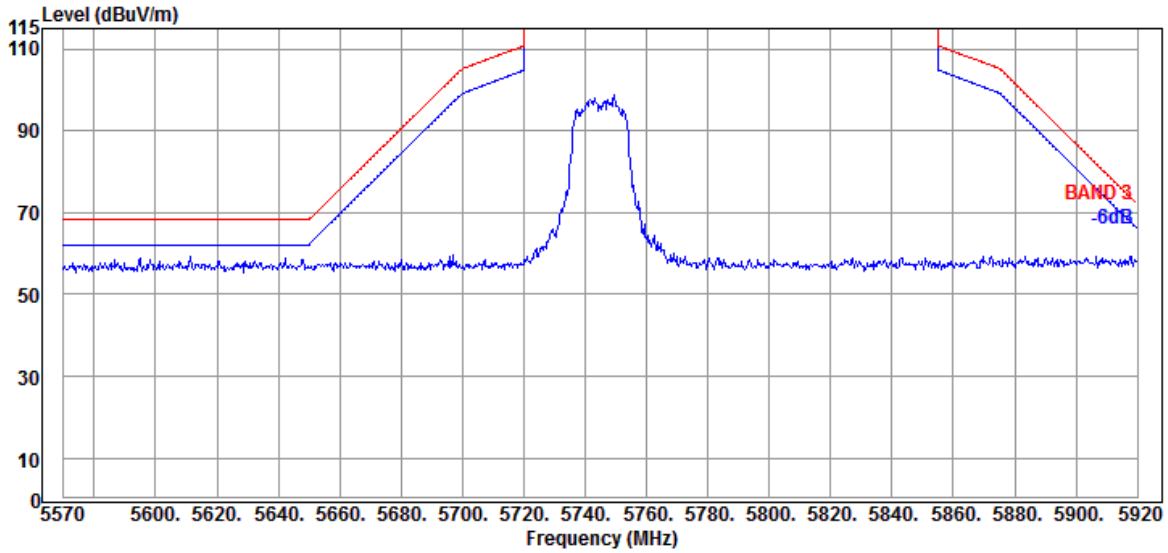

Antenna at Vertical Polarization

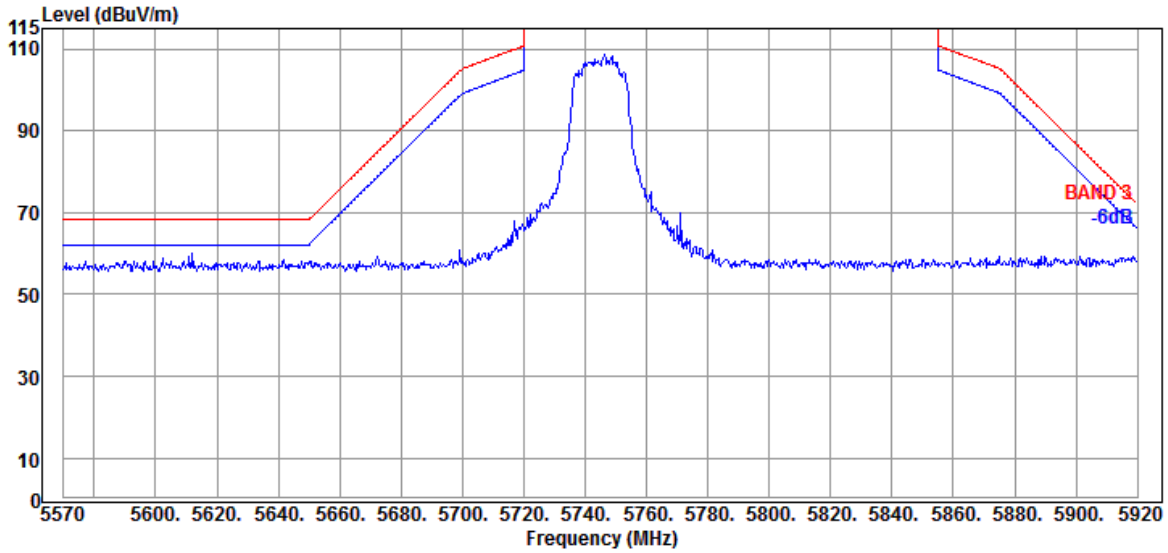

Mode	802.11n-HT20	U-NII Band	3
		Frequency	TX 5825MHz

Antenna at Horizontal Polarization

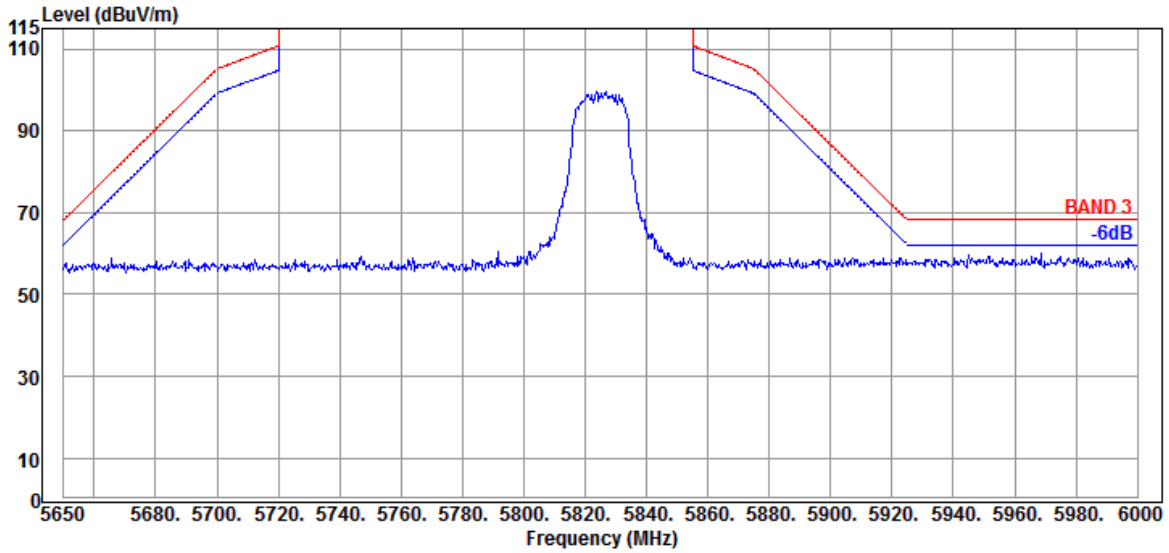

Antenna at Vertical Polarization

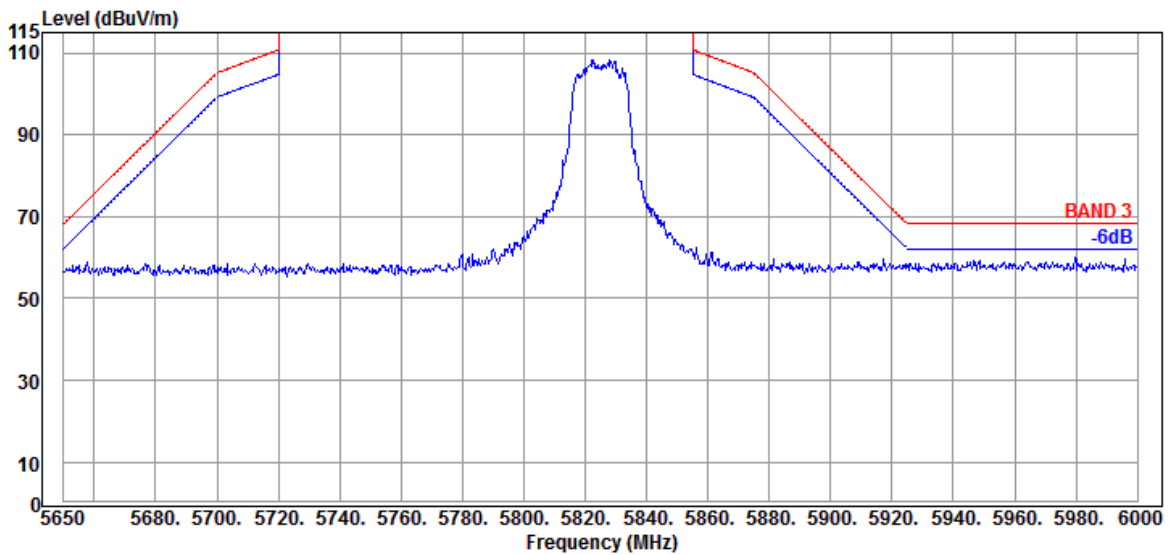

Mode	802.11n-HT40	U-NII Band	1
		Frequency	TX 5190MHz

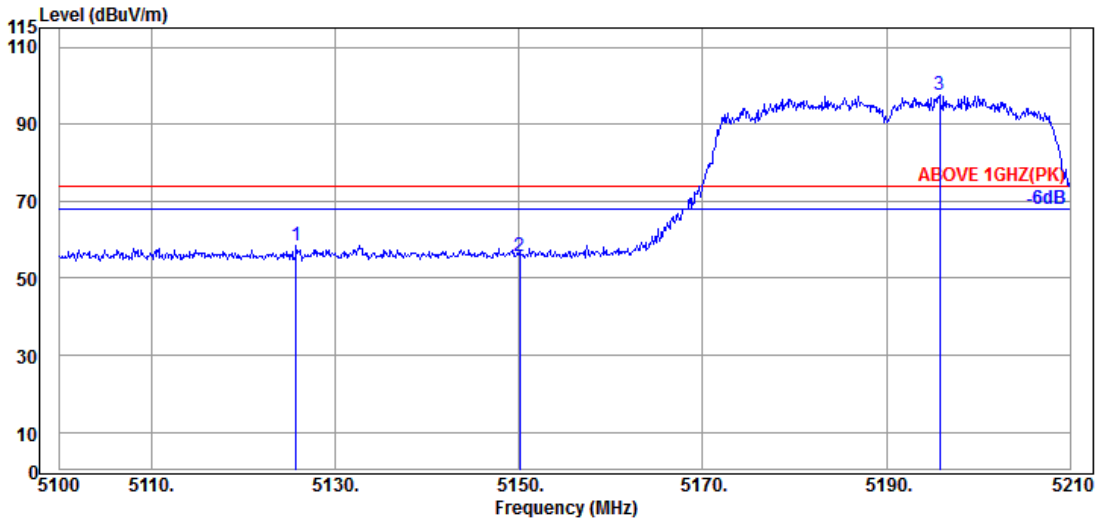

Antenna at Horizontal Polarization

Emission Frequency (MHz)	Antenna Factor (dB/m)	Cable Loss (dB)	Preamp Gain (dB)	Read Level (dBμV)	Emission Level (dBμV/m)	Limits (dBμV/m)	Margin (dB)	Detector
5125.740	34.30	8.87	34.34	49.54	58.37	74.00	15.63	Peak
5150.050	34.50	8.88	34.34	46.52	55.56	74.00	18.44	Peak
@ 5195.810	34.70	8.91	34.32	88.21	97.50	---	---	Peak

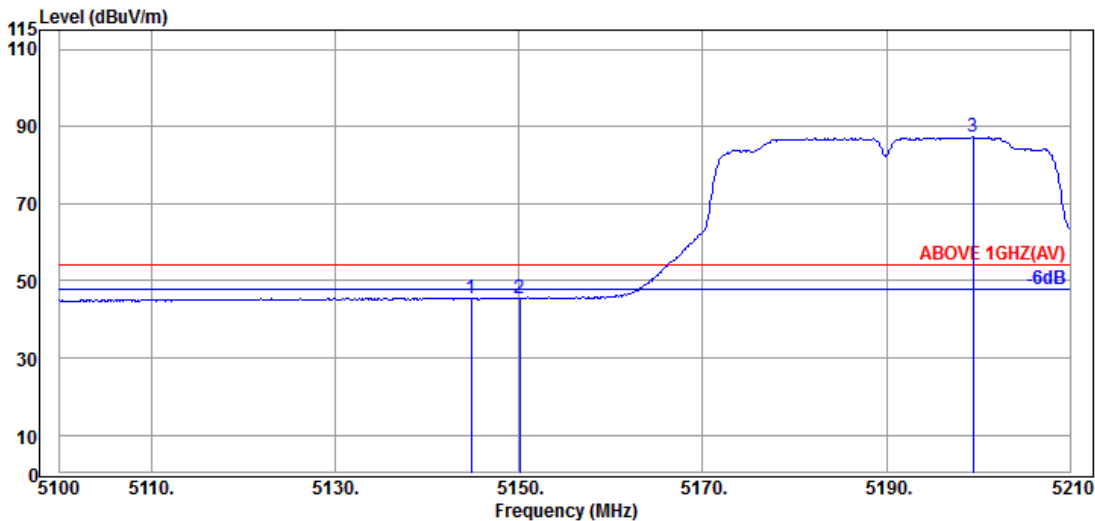

Antenna at Horizontal Polarization

Emission Frequency (MHz)	Antenna Factor (dB/m)	Cable Loss (dB)	Preamp Gain (dB)	Read Level (dBμV)	Emission Level (dBμV/m)	Limits (dBμV/m)	Margin (dB)	Detector
5144.770	34.50	8.88	34.34	36.55	45.59	54.00	8.41	Average
5150.050	34.50	8.88	34.34	36.37	45.41	54.00	8.59	Average
@ 5199.440	34.70	8.91	34.32	77.97	87.26	---	---	Average

Remark: The “@” means fundamental frequency, it is ignored in this section.

Mode	802.11n-HT40	U-NII Band	1
		Frequency	TX 5190MHz

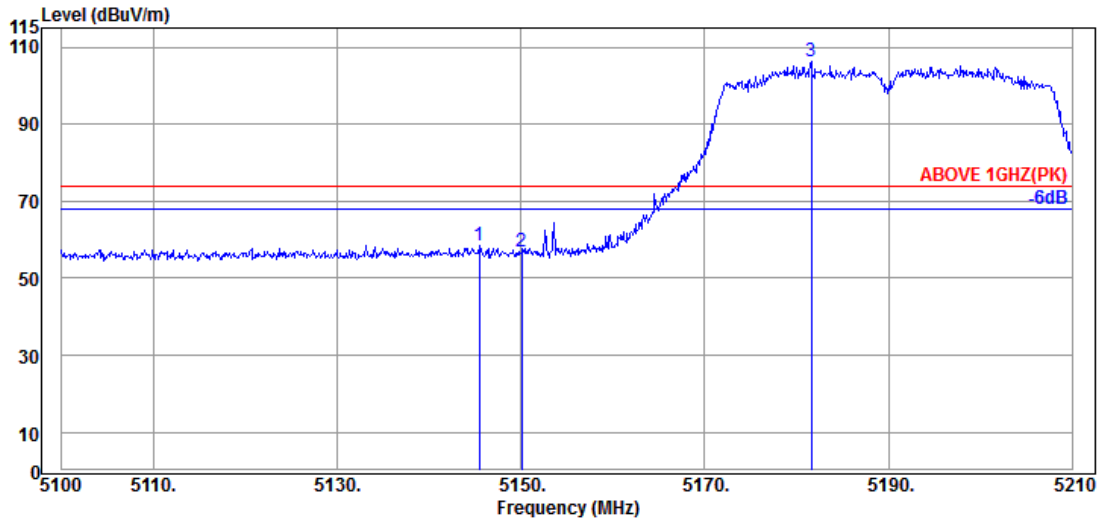

Antenna at Vertical Polarization

Emission Frequency (MHz)	Antenna Factor (dB/m)	Cable Loss (dB)	Preamp Gain (dB)	Read Level (dBμV)	Emission Level (dBμV/m)	Limits (dBμV/m)	Margin (dB)	Detector
5145.430	34.50	8.88	34.34	49.49	58.53	74.00	15.47	Peak
5150.050	34.50	8.88	34.34	47.68	56.72	74.00	17.28	Peak
@ 5181.620	34.63	8.90	34.32	97.18	106.39	---	---	Peak

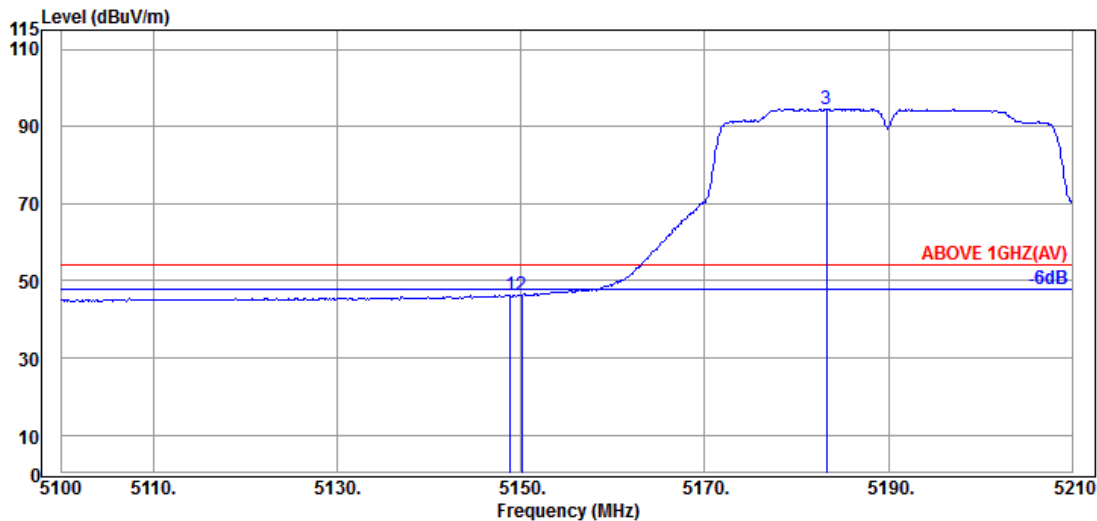

Antenna at Vertical Polarization

Emission Frequency (MHz)	Antenna Factor (dB/m)	Cable Loss (dB)	Preamp Gain (dB)	Read Level (dBμV)	Emission Level (dBμV/m)	Limits (dBμV/m)	Margin (dB)	Detector
5148.840	34.50	8.88	34.34	37.17	46.21	54.00	7.79	Average
5150.050	34.50	8.88	34.34	37.17	46.21	54.00	7.79	Average
@ 5183.270	34.63	8.90	34.32	85.29	94.50	---	---	Average

Remark: The “@” means fundamental frequency, it is ignored in this section.

Mode	802.11n-HT40	U-NII Band	2A
		Frequency	TX 5310MHz

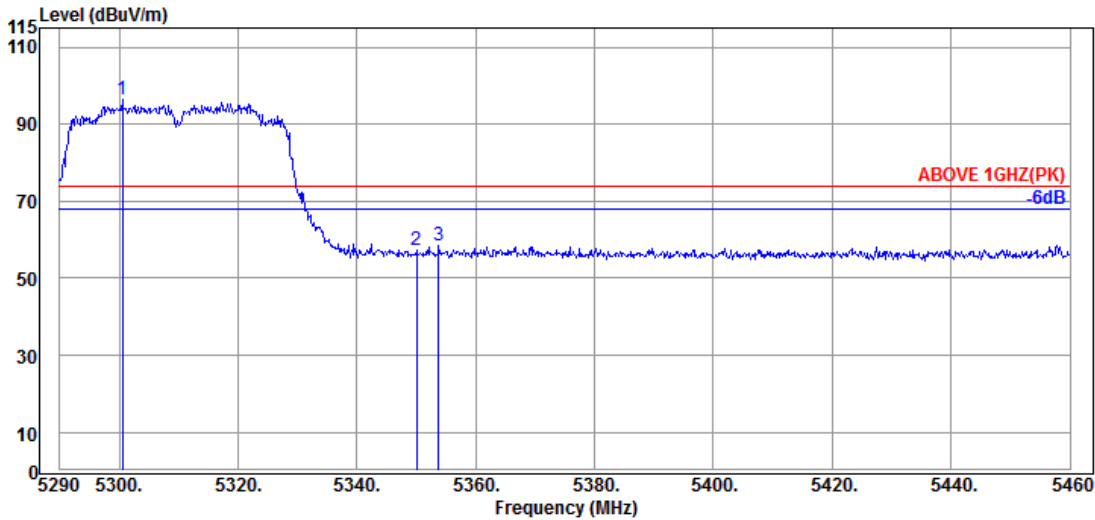

Antenna at Horizontal Polarization

Emission Frequency (MHz)	Antenna Factor (dB/m)	Cable Loss (dB)	Preamp Gain (dB)	Read Level (dBμV)	Emission Level (dBUV/m)	Limits (dBUV/m)	Margin (dB)	Detector
@ 5300.540	34.40	8.97	34.28	87.30	96.39	---	---	Peak
5350.010	34.90	8.99	34.26	47.51	57.14	74.00	16.86	Peak
5353.750	34.90	8.99	34.26	48.77	58.40	74.00	15.60	Peak

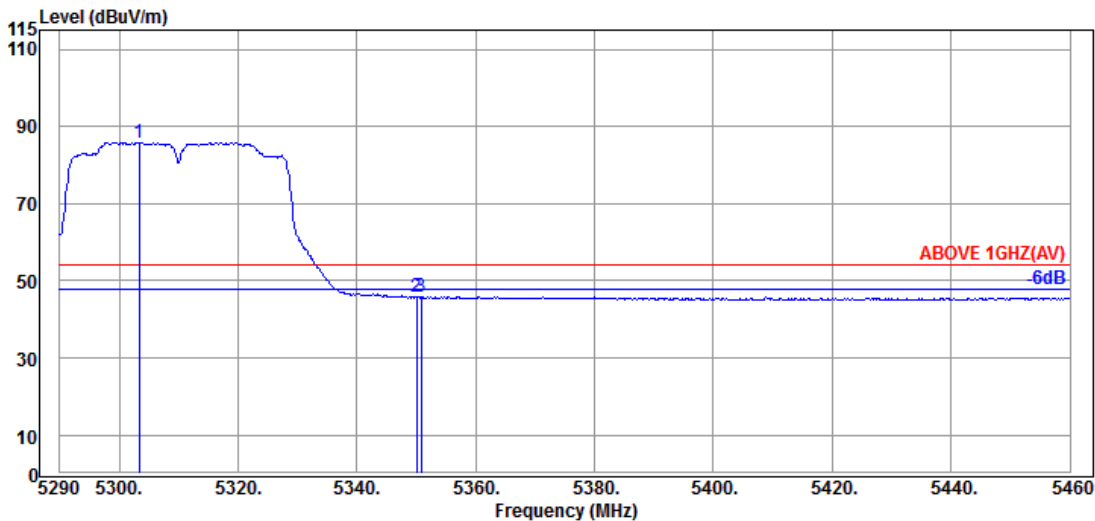

Antenna at Horizontal Polarization

Emission Frequency (MHz)	Antenna Factor (dB/m)	Cable Loss (dB)	Preamp Gain (dB)	Read Level (dBμV)	Emission Level (dBUV/m)	Limits (dBUV/m)	Margin (dB)	Detector
@ 5303.430	34.40	8.97	34.28	76.86	85.95	---	---	Average
5350.010	34.90	8.99	34.26	36.18	45.81	54.00	8.19	Average
5350.860	34.90	8.99	34.26	36.22	45.85	54.00	8.15	Average

Remark: The “@” means fundamental frequency, it is ignored in this section.

Mode	802.11n-HT40	U-NII Band	2A
		Frequency	TX 5310MHz

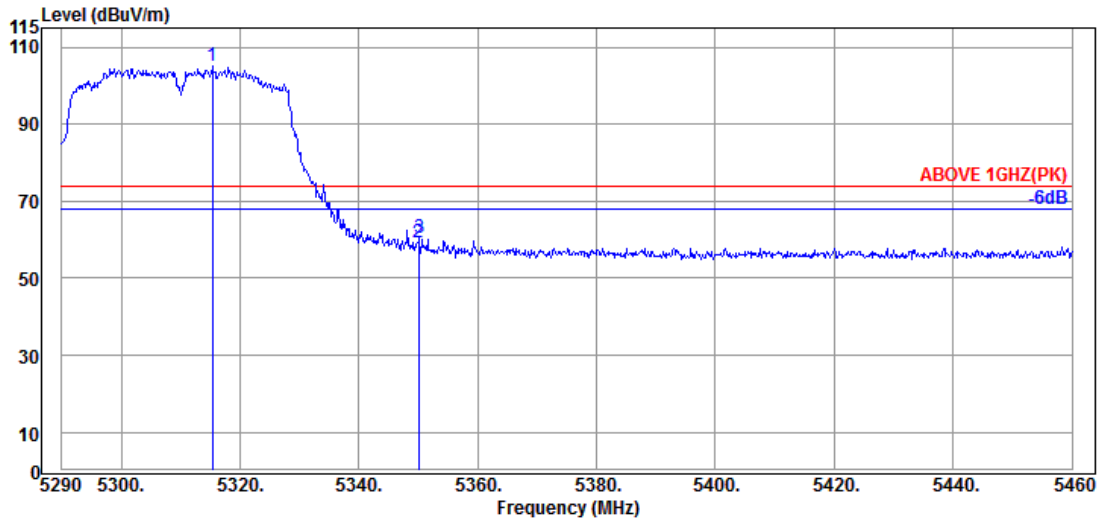

Antenna at Vertical Polarization

Emission Frequency (MHz)	Antenna Factor (dB/m)	Cable Loss (dB)	Preamp Gain (dB)	Read Level (dBμV)	Emission Level (dBμV/m)	Limits (dBμV/m)	Margin (dB)	Detector
@ 5315.330	34.57	8.98	34.27	95.89	105.17	---	---	Peak
5350.010	34.90	8.99	34.26	49.56	59.19	74.00	14.81	Peak
5350.180	34.90	8.99	34.26	50.80	60.43	74.00	13.57	Peak

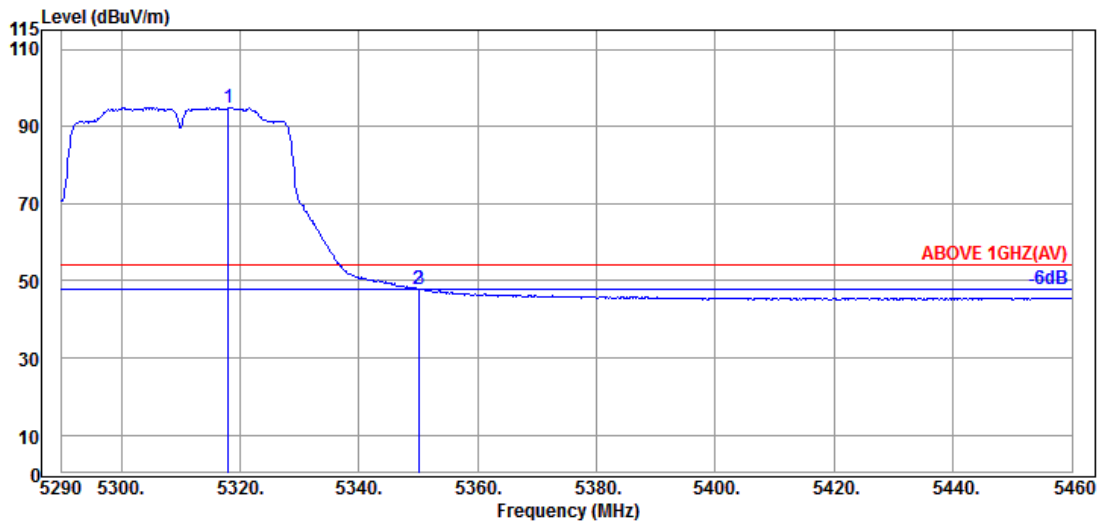

Antenna at Vertical Polarization

Emission Frequency (MHz)	Antenna Factor (dB/m)	Cable Loss (dB)	Preamp Gain (dB)	Read Level (dBμV)	Emission Level (dBμV/m)	Limits (dBμV/m)	Margin (dB)	Detector
@ 5318.050	34.57	8.98	34.27	85.74	95.02	---	---	Average
5350.010	34.90	8.99	34.26	38.14	47.77	54.00	6.23	Average
5350.180	34.90	8.99	34.26	38.25	47.88	54.00	6.12	Average

Remark: The “@” means fundamental frequency, it is ignored in this section.

Mode	802.11n-HT40	U-NII Band	2C
		Frequency	TX 5510MHz

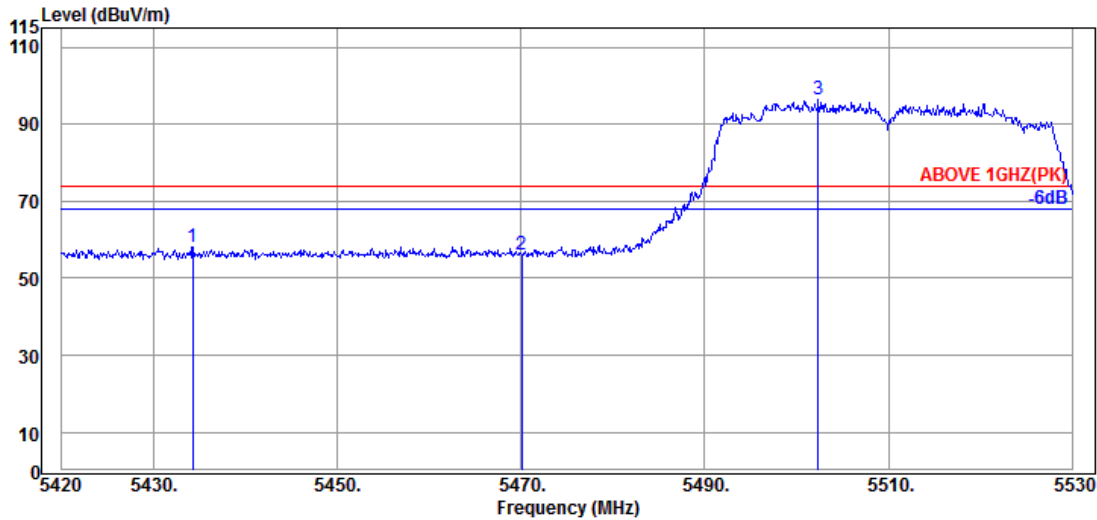

Antenna at Horizontal Polarization

Emission Frequency (MHz)	Antenna Factor (dB/m)	Cable Loss (dB)	Preamp Gain (dB)	Read Level (dBμV)	Emission Level (dBμV/m)	Limits (dBμV/m)	Margin (dB)	Detector
5434.300	34.65	9.04	34.22	48.79	58.26	74.00	15.74	Peak
5470.050	34.63	9.06	34.21	46.69	56.17	74.00	17.83	Peak
@ 5502.390	34.70	9.08	34.20	86.97	96.55	---	---	Peak

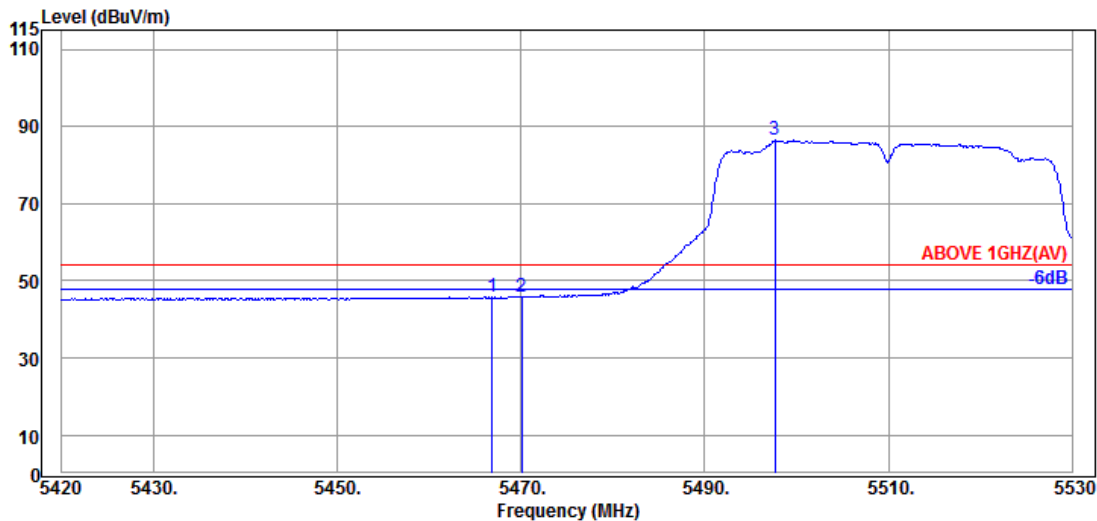

Antenna at Horizontal Polarization

Emission Frequency (MHz)	Antenna Factor (dB/m)	Cable Loss (dB)	Preamp Gain (dB)	Read Level (dBμV)	Emission Level (dBμV/m)	Limits (dBμV/m)	Margin (dB)	Detector
5466.860	34.63	9.06	34.21	36.34	45.82	54.00	8.18	Average
5470.050	34.63	9.06	34.21	36.28	45.76	54.00	8.24	Average
@ 5497.660	34.70	9.08	34.20	76.92	86.50	---	---	Average

Remark: The “@” means fundamental frequency, it is ignored in this section.

Mode	802.11n-HT40	U-NII Band	2C
		Frequency	TX 5510MHz

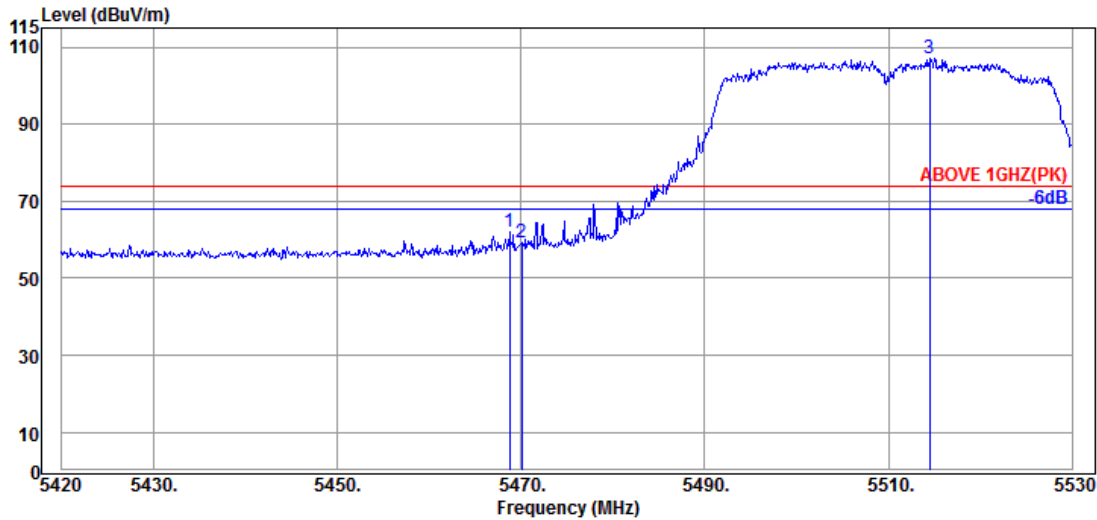

Antenna at Vertical Polarization

Emission Frequency (MHz)	Antenna Factor (dB/m)	Cable Loss (dB)	Preamp Gain (dB)	Read Level (dBμV)	Emission Level (dBμV/m)	Limits (dBμV/m)	Margin (dB)	Detector
5468.730	34.63	9.06	34.21	52.68	62.16	74.00	11.84	Peak
5470.050	34.63	9.06	34.21	49.74	59.22	74.00	14.78	Peak
@ 5514.490	34.70	9.09	34.21	97.52	107.10	---	---	Peak

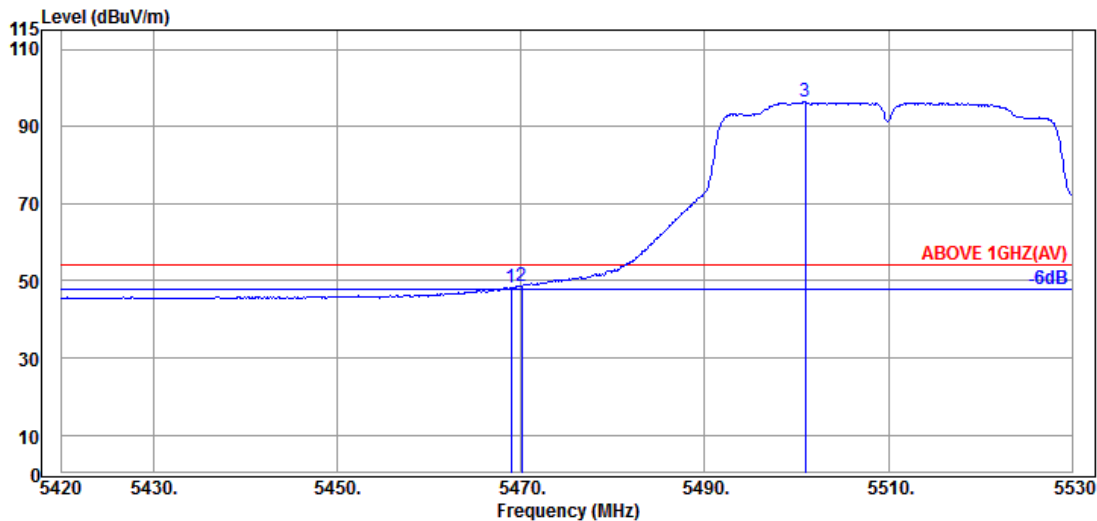

Antenna at Vertical Polarization

Emission Frequency (MHz)	Antenna Factor (dB/m)	Cable Loss (dB)	Preamp Gain (dB)	Read Level (dBμV)	Emission Level (dBμV/m)	Limits (dBμV/m)	Margin (dB)	Detector
5468.950	34.63	9.06	34.21	38.84	48.32	54.00	5.68	Average
5470.050	34.63	9.06	34.21	39.10	48.58	54.00	5.42	Average
@ 5500.960	34.70	9.08	34.20	87.03	96.61	---	---	Average

Remark: The "@" means fundamental frequency, it is ignored in this section.

Mode	802.11n-HT40	U-NII Band	2C
		Frequency	TX 5670MHz

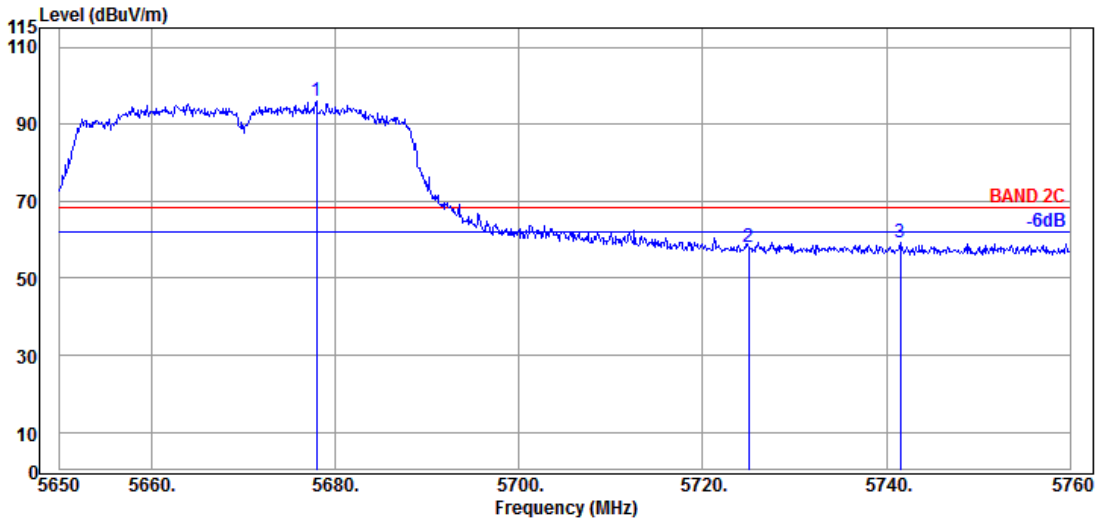

Antenna at Horizontal Polarization

Emission Frequency (MHz)	Antenna Factor (dB/m)	Cable Loss (dB)	Preamp Gain (dB)	Read Level (dBμV)	Emission Level (dBμV/m)	Limits (dBμV/m)	Margin (dB)	Detector
@ 5677.940	34.63	9.17	34.29	86.42	95.93	---	---	Peak
5725.020	34.90	9.20	34.30	48.17	57.97	68.20	10.23	Peak
5741.520	35.00	9.20	34.31	49.48	59.37	68.20	8.83	Peak

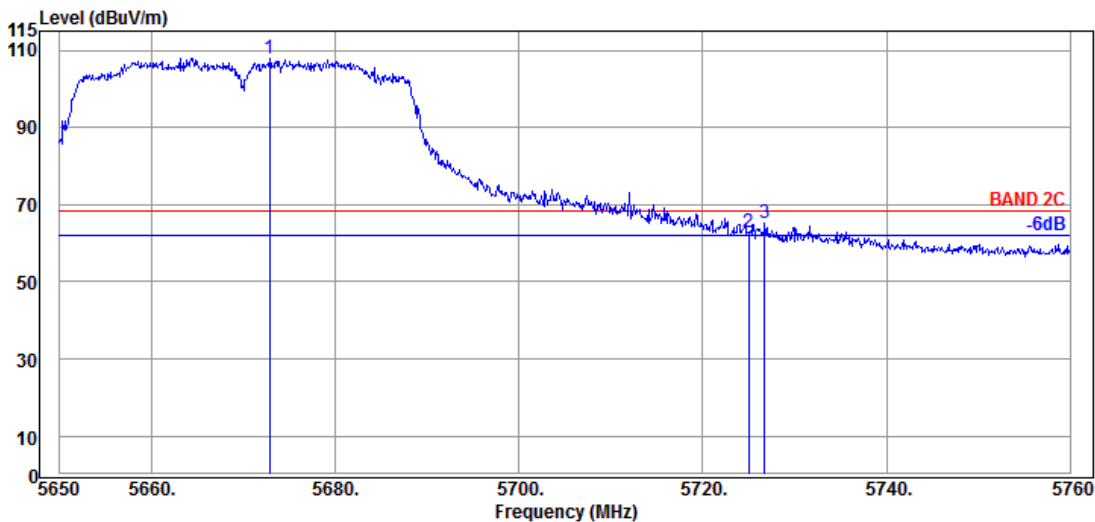

Antenna at Vertical Polarization

Emission Frequency (MHz)	Antenna Factor (dB/m)	Cable Loss (dB)	Preamp Gain (dB)	Read Level (dBμV)	Emission Level (dBμV/m)	Limits (dBμV/m)	Margin (dB)	Detector
@ 5672.880	34.63	9.17	34.29	98.48	107.99	---	---	Peak
5725.020	34.90	9.20	34.30	52.98	62.78	68.20	5.42	Peak
5726.780	34.90	9.20	34.31	55.39	65.18	68.20	3.02	Peak

Remark: The “@” means fundamental frequency, it is ignored in this section.

Mode	802.11n-HT40	U-NII Band	2C
		Frequency	TX 5710MHz

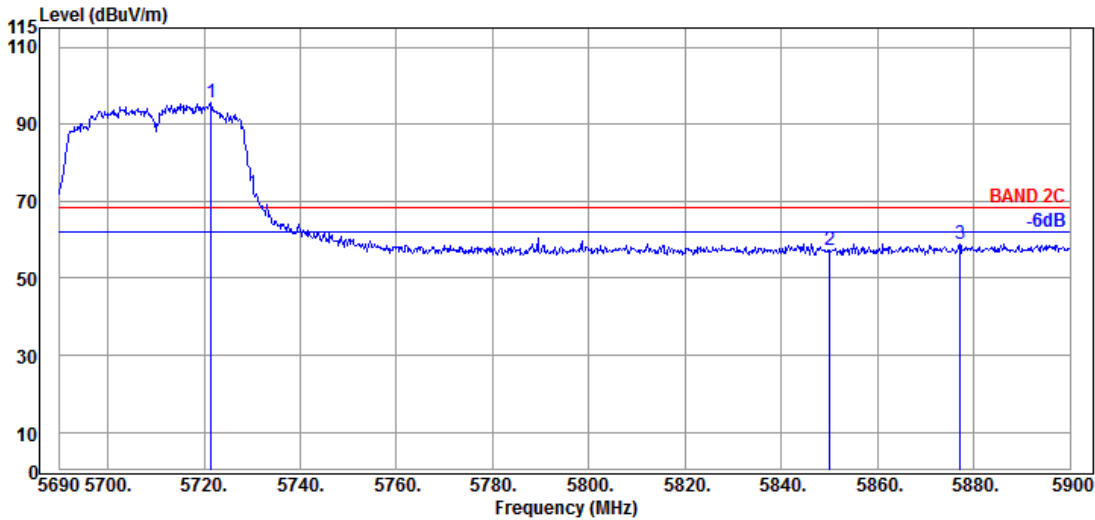

Antenna at Horizontal Polarization

Emission Frequency (MHz)	Antenna Factor (dB/m)	Cable Loss (dB)	Preamp Gain (dB)	Read Level (dBμV)	Emission Level (dBμV/m)	Limits (dBμV/m)	Margin (dB)	Detector
@ 5721.500	34.80	9.19	34.30	86.08	95.77	---	---	Peak
5850.020	35.40	9.25	34.36	47.08	57.37	68.20	10.83	Peak
5877.110	35.67	9.27	34.37	48.14	58.71	68.20	9.49	Peak

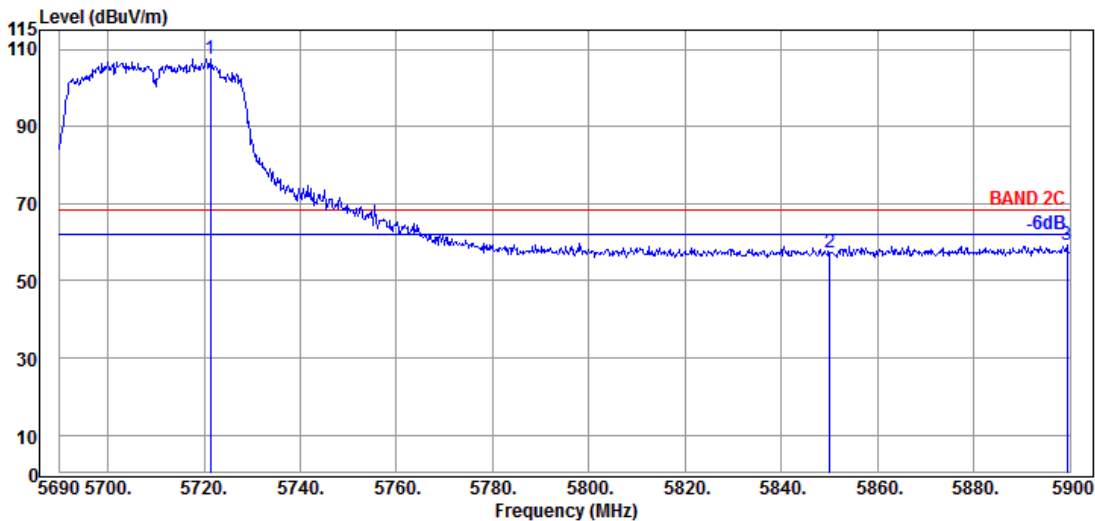

Antenna at Vertical Polarization

Emission Frequency (MHz)	Antenna Factor (dB/m)	Cable Loss (dB)	Preamp Gain (dB)	Read Level (dBμV)	Emission Level (dBμV/m)	Limits (dBμV/m)	Margin (dB)	Detector
@ 5721.290	34.80	9.19	34.30	97.99	107.68	---	---	Peak
5850.020	35.40	9.25	34.36	46.88	57.17	68.20	11.03	Peak
5899.370	35.80	9.28	34.39	48.64	59.33	68.20	8.87	Peak

Remark: The “@” means fundamental frequency, it is ignored in this section.

Mode	802.11n-HT40	U-NII Band	2C
		Frequency	TX 5710MHz

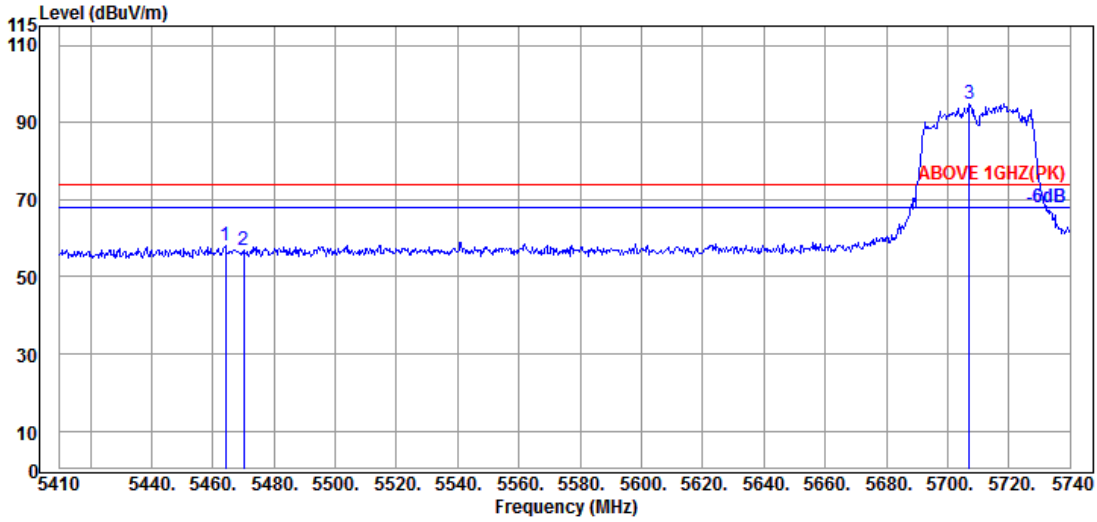

Antenna at Horizontal Polarization

Emission Frequency (MHz)	Antenna Factor (dB/m)	Cable Loss (dB)	Preamplifier Gain (dB)	Read Level (dBμV)	Emission Level (dBμV/m)	Limits (dBμV/m)	Margin (dB)	Detector
5464.120	34.63	9.06	34.21	48.68	58.16	74.00	15.84	Peak
5470.060	34.63	9.06	34.21	47.52	57.00	74.00	17.00	Peak
@ 5707.000	34.80	9.19	34.29	85.23	94.93	---	---	Peak

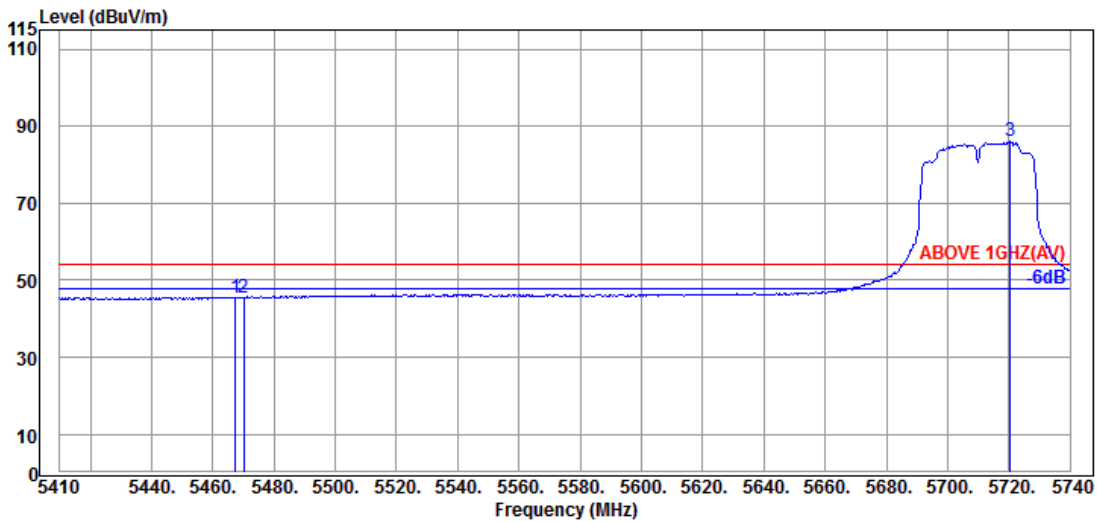

Antenna at Horizontal Polarization

Emission Frequency (MHz)	Antenna Factor (dB/m)	Cable Loss (dB)	Preamplifier Gain (dB)	Read Level (dBμV)	Emission Level (dBμV/m)	Limits (dBμV/m)	Margin (dB)	Detector
5467.420	34.63	9.06	34.21	36.12	45.60	54.00	8.40	Average
5470.060	34.63	9.06	34.21	35.98	45.46	54.00	8.54	Average
@ 5720.530	34.80	9.19	34.30	76.27	85.96	---	---	Average

Remark: The “@” means fundamental frequency, it is ignored in this section.

Mode	802.11n-HT40	U-NII Band	2C
		Frequency	TX 5710MHz

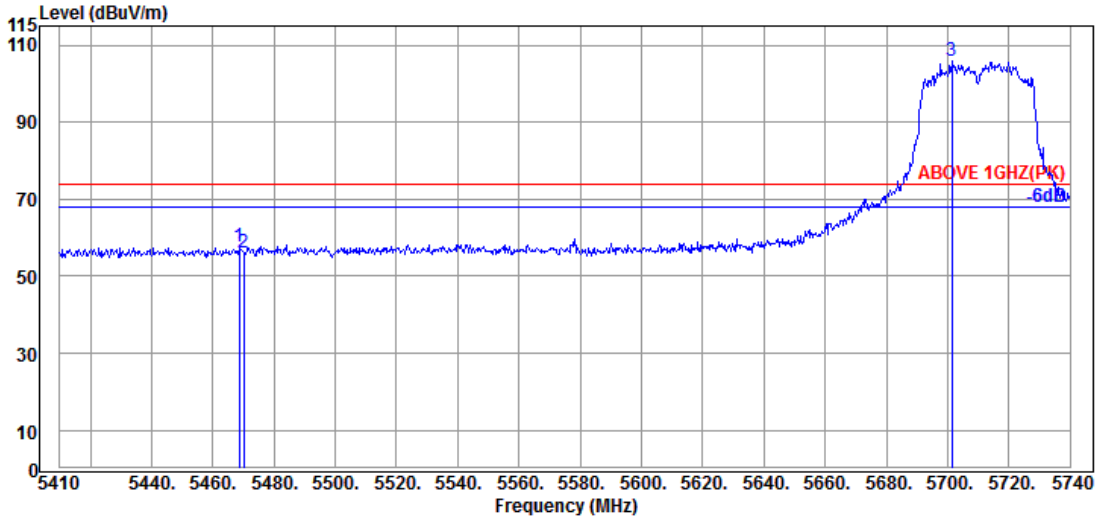

Antenna at Vertical Polarization

Emission Frequency (MHz)	Antenna Factor (dB/m)	Cable Loss (dB)	Preamp Gain (dB)	Read Level (dBμV)	Emission Level (dBμV/m)	Limits (dBμV/m)	Margin (dB)	Detector
5468.740	34.63	9.06	34.21	48.33	57.81	74.00	16.19	Peak
5470.060	34.63	9.06	34.21	46.48	55.96	74.00	18.04	Peak
@ 5701.390	34.70	9.18	34.29	96.30	105.89	---	---	Peak

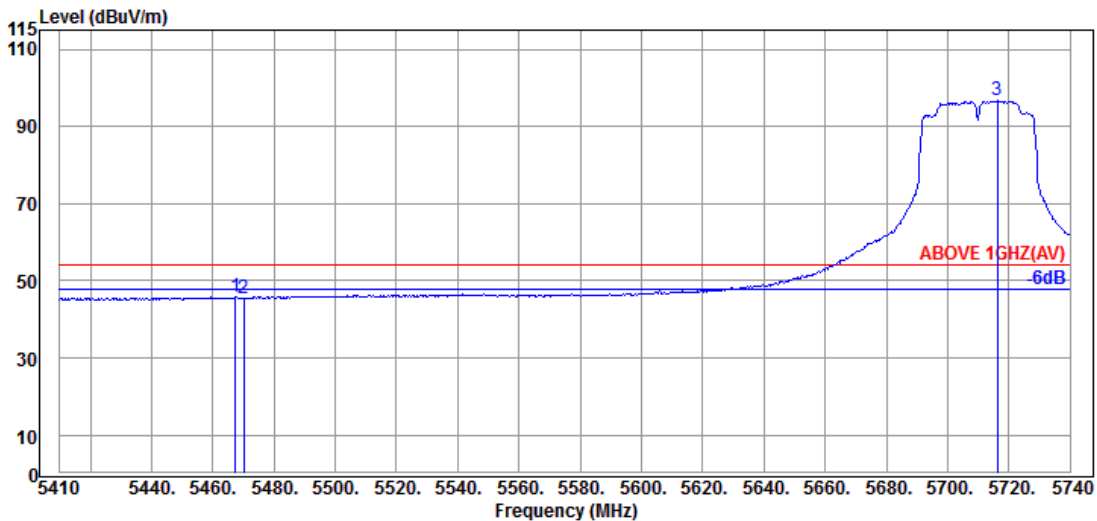

Antenna at Vertical Polarization

Emission Frequency (MHz)	Antenna Factor (dB/m)	Cable Loss (dB)	Preamp Gain (dB)	Read Level (dBμV)	Emission Level (dBμV/m)	Limits (dBμV/m)	Margin (dB)	Detector
5467.420	34.63	9.06	34.21	36.32	45.80	54.00	8.20	Average
5470.060	34.63	9.06	34.21	35.96	45.44	54.00	8.56	Average
@ 5716.240	34.80	9.19	34.30	87.11	96.80	---	---	Average

Remark: The “@” means fundamental frequency, it is ignored in this section.

Mode	802.11n-HT40	U-NII Band	3
		Frequency	TX 5755MHz

Antenna at Horizontal Polarization

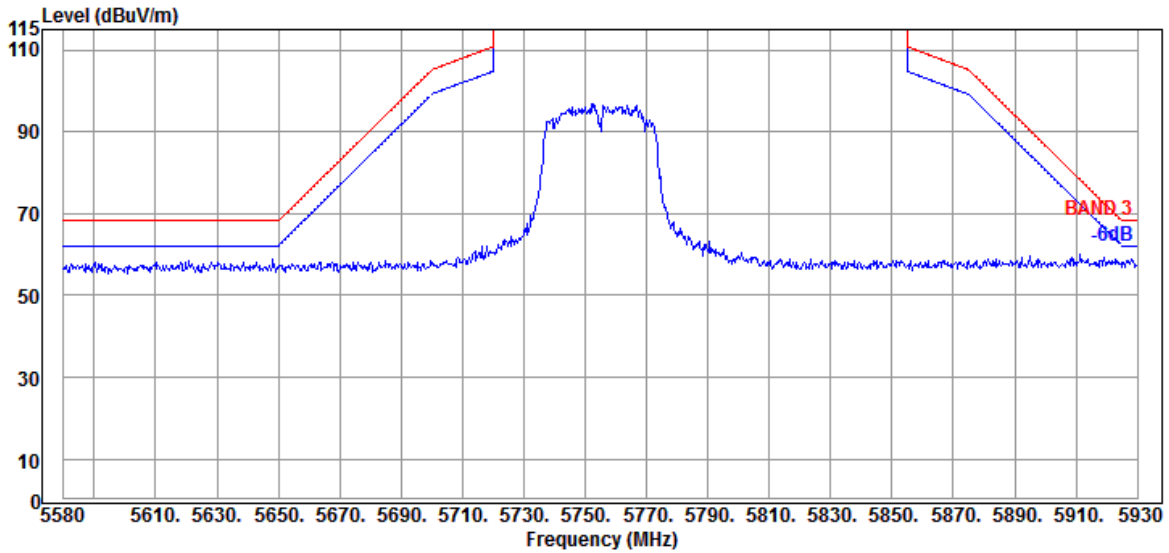

Antenna at Vertical Polarization

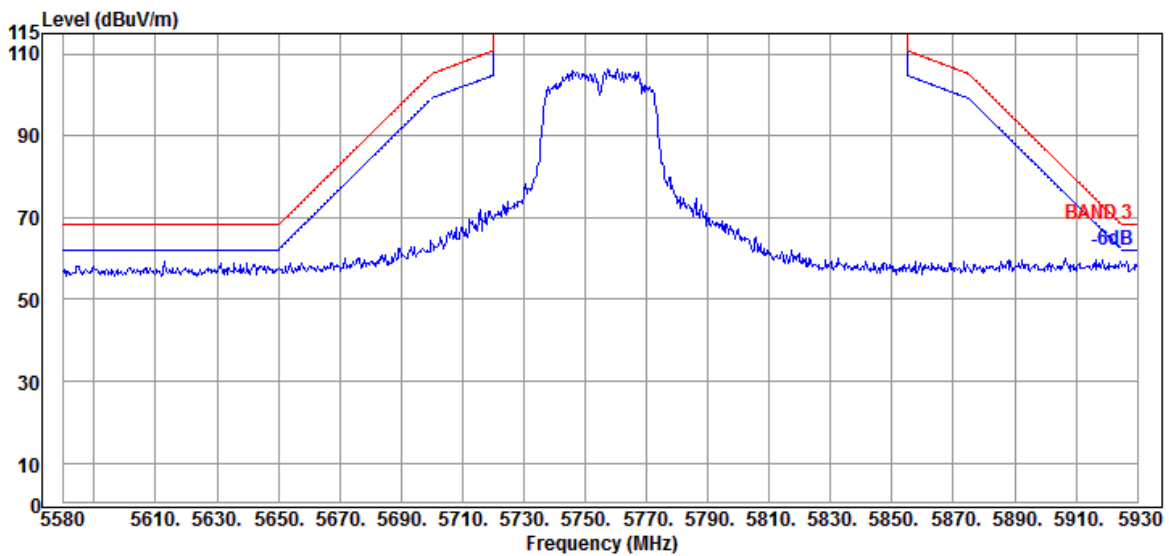

Mode	802.11n-HT40	U-NII Band	3
		Frequency	TX 5795MHz

Antenna at Horizontal Polarization

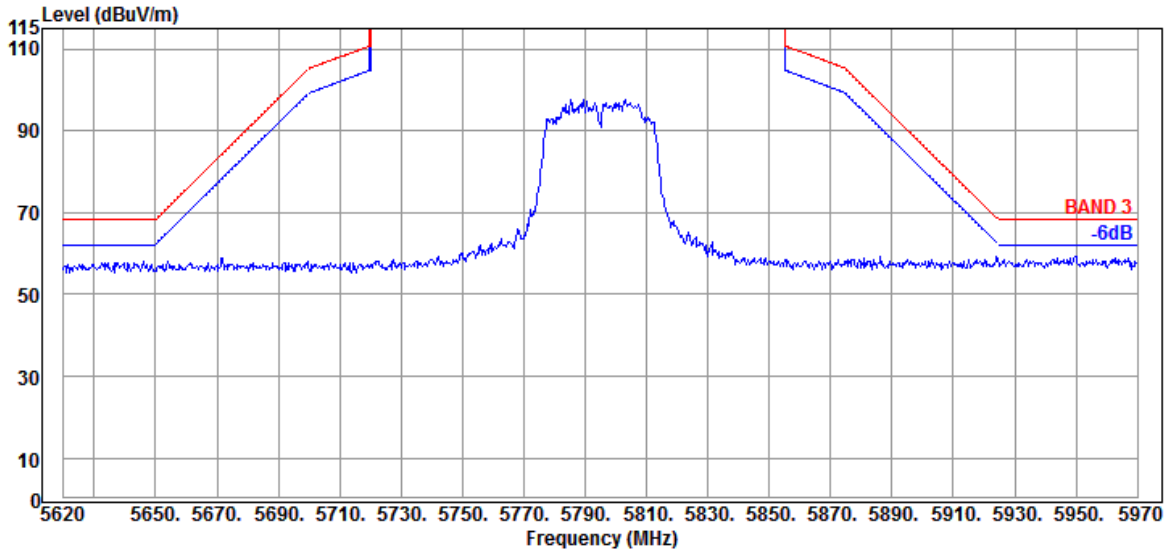

Antenna at Vertical Polarization

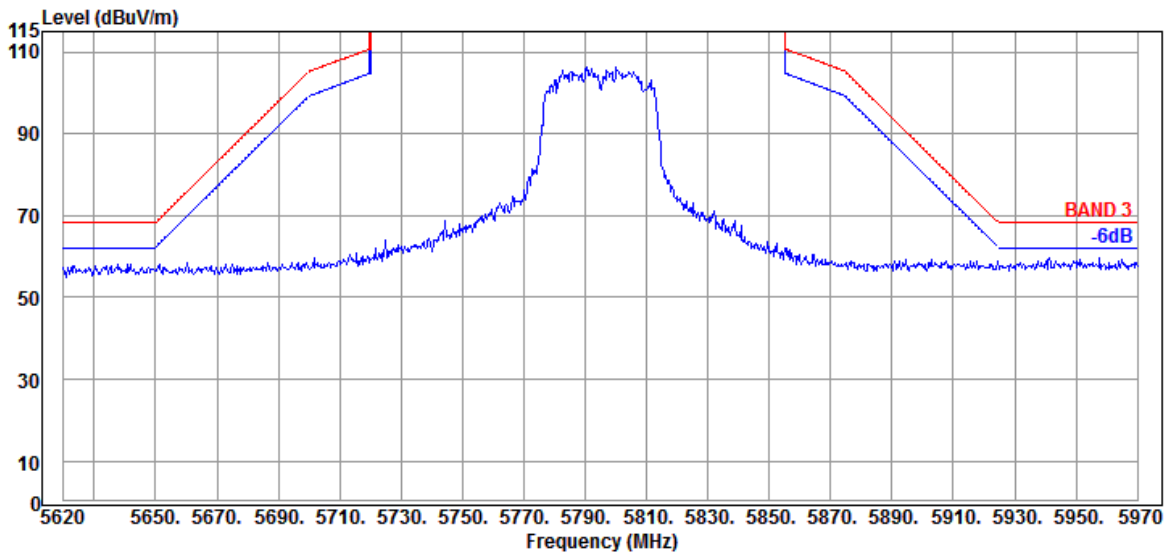

Mode	802.11ac-VHT80	U-NII Band	1
		Frequency	TX 5210MHz

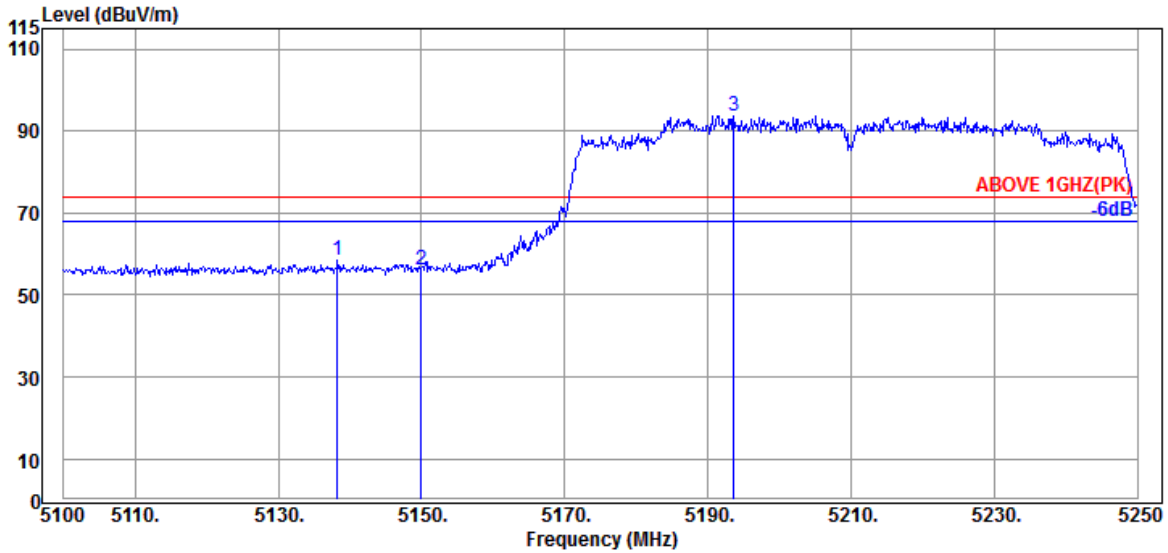

Antenna at Horizontal Polarization

Emission Frequency (MHz)	Antenna Factor (dB/m)	Cable Loss (dB)	Preamplifier Gain (dB)	Read Level (dBμV)	Emission Level (dBμV/m)	Limits (dBμV/m)	Margin (dB)	Detector
5138.250	34.40	8.88	34.34	49.44	58.38	74.00	15.62	Peak
5149.950	34.50	8.88	34.34	47.03	56.07	74.00	17.93	Peak
@ 5193.600	34.70	8.91	34.32	84.53	93.82	---	---	Peak

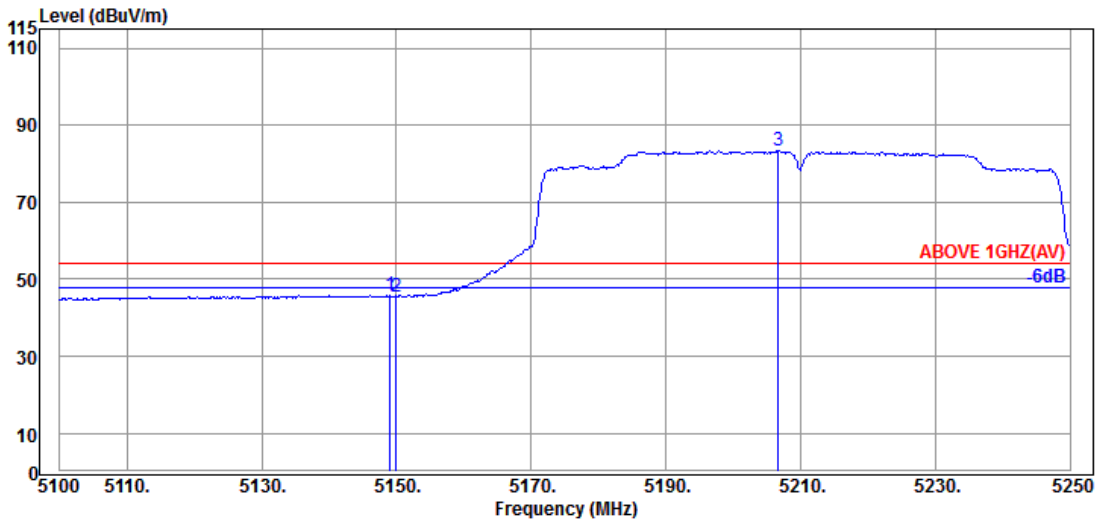

Antenna at Horizontal Polarization

Emission Frequency (MHz)	Antenna Factor (dB/m)	Cable Loss (dB)	Preamplifier Gain (dB)	Read Level (dBμV)	Emission Level (dBμV/m)	Limits (dBμV/m)	Margin (dB)	Detector
5149.050	34.50	8.88	34.34	36.69	45.73	54.00	8.27	Average
5149.950	34.50	8.88	34.34	36.52	45.56	54.00	8.44	Average
@ 5206.650	34.65	8.92	34.32	74.14	83.39	---	---	Average

Remark: The “@” means fundamental frequency, it is ignored in this section.

Mode	802.11ac-VHT80	U-NII Band	1
		Frequency	TX 5210MHz

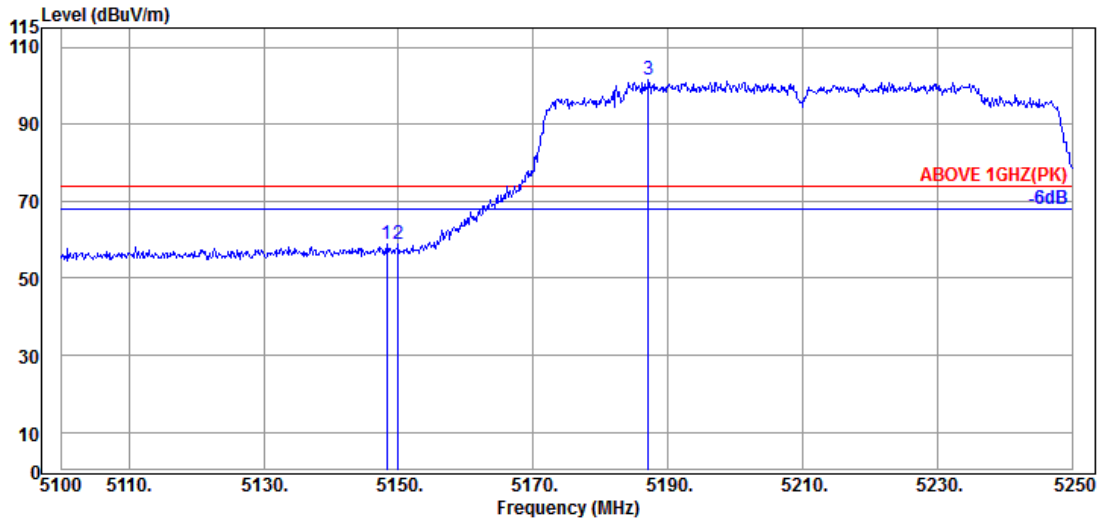

Antenna at Vertical Polarization

Emission Frequency (MHz)	Antenna Factor (dB/m)	Cable Loss (dB)	Preamp Gain (dB)	Read Level (dBμV)	Emission Level (dBμV/m)	Limits (dBμV/m)	Margin (dB)	Detector
5148.300	34.50	8.88	34.34	49.76	58.80	74.00	15.20	Peak
5149.950	34.50	8.88	34.34	49.81	58.85	74.00	15.15	Peak
@ 5187.150	34.70	8.91	34.32	92.26	101.55	---	---	Peak

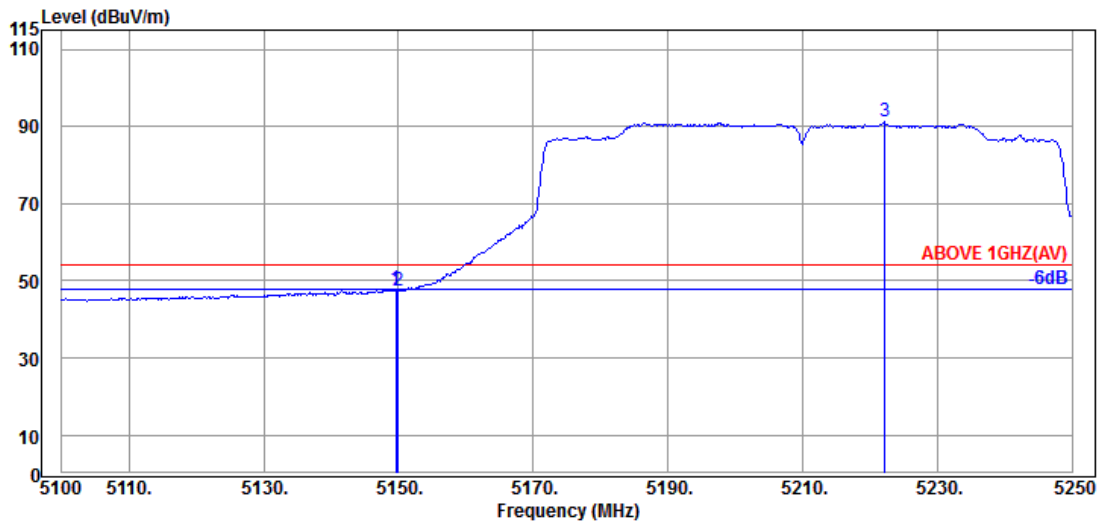

Antenna at Vertical Polarization

Emission Frequency (MHz)	Antenna Factor (dB/m)	Cable Loss (dB)	Preamp Gain (dB)	Read Level (dBμV)	Emission Level (dBμV/m)	Limits (dBμV/m)	Margin (dB)	Detector
5149.650	34.50	8.88	34.34	38.60	47.64	54.00	6.36	Average
5149.950	34.50	8.88	34.34	38.29	47.33	54.00	6.67	Average
@ 5222.250	34.60	8.93	34.31	81.88	91.10	---	---	Average

Remark: The “@” means fundamental frequency, it is ignored in this section.

Mode	802.11ac-VHT80	U-NII Band	2A
		Frequency	TX 5290MHz

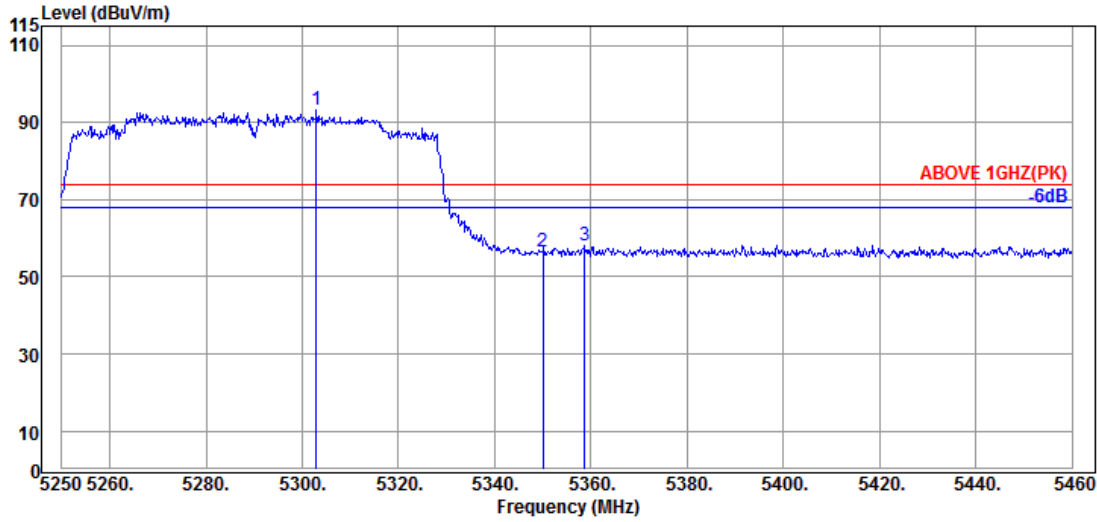

Antenna at Horizontal Polarization

Emission Frequency (MHz)	Antenna Factor (dB/m)	Cable Loss (dB)	Preamp Gain (dB)	Read Level (dBμV)	Emission Level (dBμV/m)	Limits (dBμV/m)	Margin (dB)	Detector
@ 5302.920	34.40	8.97	34.28	83.99	93.08	---	---	Peak
5349.960	34.90	8.99	34.26	46.99	56.62	74.00	17.38	Peak
5358.780	34.87	9.00	34.26	48.42	58.03	74.00	15.97	Peak

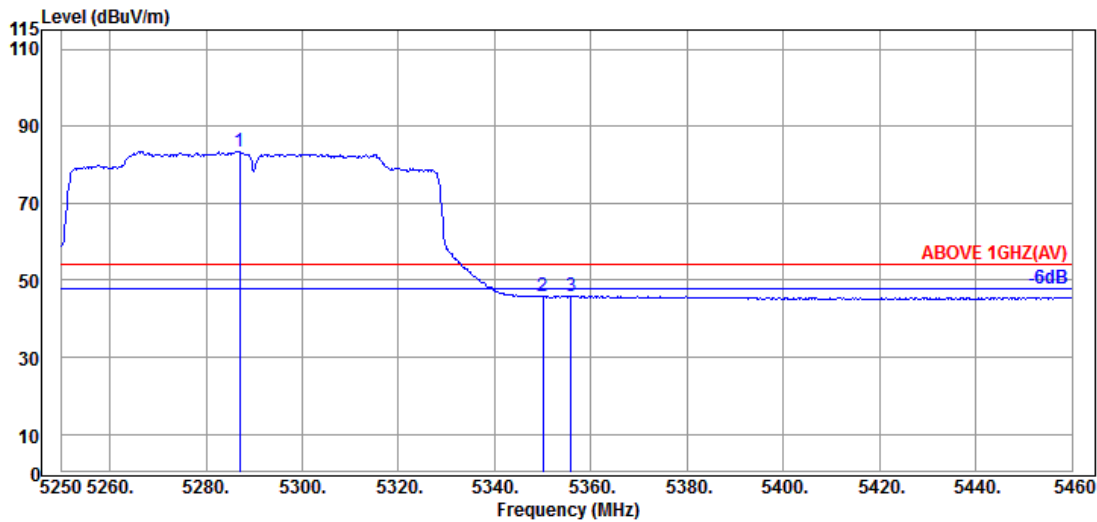

Antenna at Horizontal Polarization

Emission Frequency (MHz)	Antenna Factor (dB/m)	Cable Loss (dB)	Preamp Gain (dB)	Read Level (dBμV)	Emission Level (dBμV/m)	Limits (dBμV/m)	Margin (dB)	Detector
@ 5286.960	34.43	8.96	34.28	74.46	83.57	---	---	Average
5349.960	34.90	8.99	34.26	36.06	45.69	54.00	8.31	Average
5355.840	34.87	9.00	34.26	36.40	46.01	54.00	7.99	Average

Remark: The “@” means fundamental frequency, it is ignored in this section.

Mode	802.11ac-VHT80	U-NII Band	2A
		Frequency	TX 5290MHz

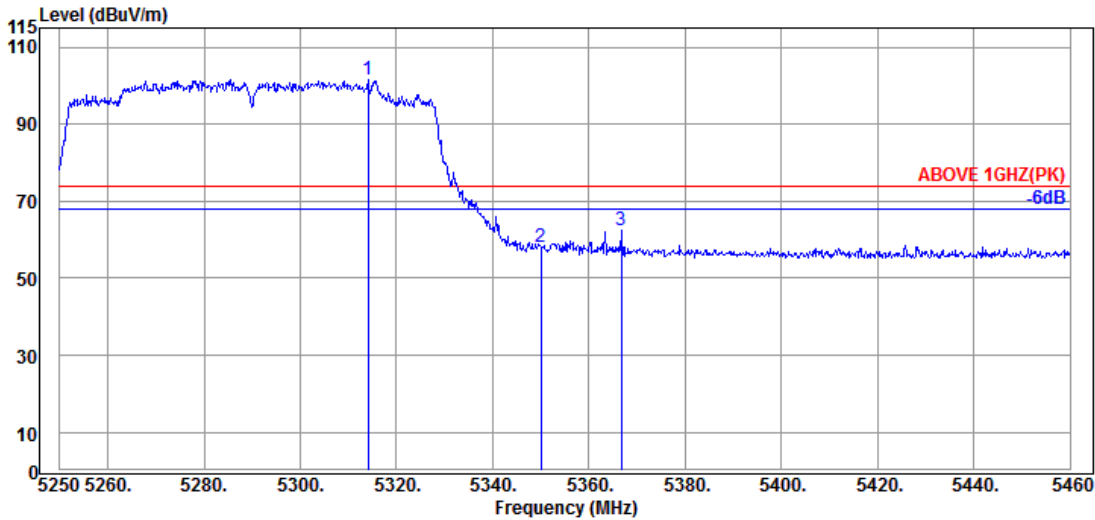

Antenna at Vertical Polarization

Emission Frequency (MHz)	Antenna Factor (dB/m)	Cable Loss (dB)	Preamp Gain (dB)	Read Level (dBμV)	Emission Level (dBμV/m)	Limits (dBμV/m)	Margin (dB)	Detector
@ 5314.050	34.57	8.98	34.27	92.29	101.57	---	---	Peak
5349.960	34.90	8.99	34.26	48.36	57.99	74.00	16.01	Peak
5366.760	34.87	9.00	34.25	52.74	62.36	74.00	11.64	Peak

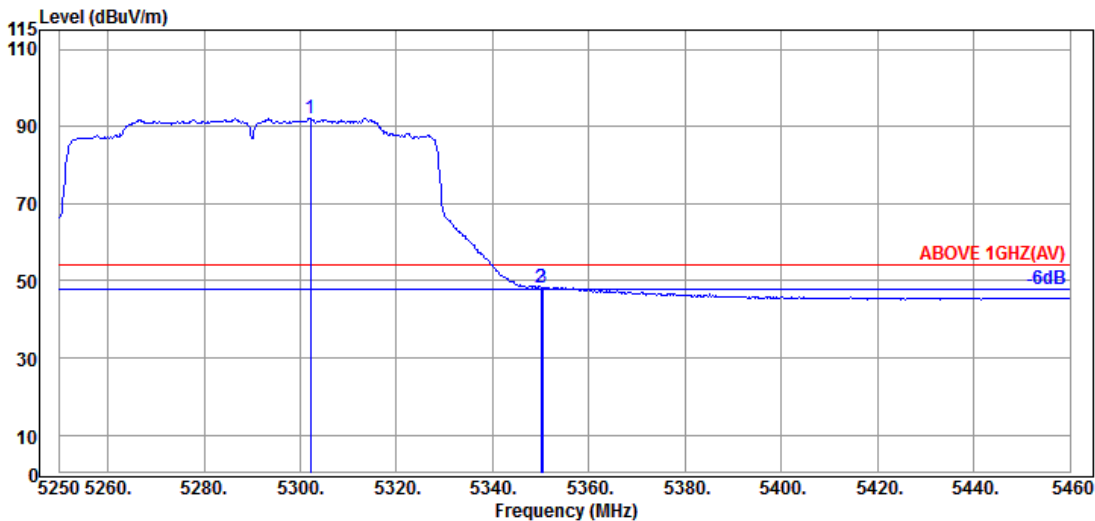

Antenna at Vertical Polarization

Emission Frequency (MHz)	Antenna Factor (dB/m)	Cable Loss (dB)	Preamp Gain (dB)	Read Level (dBμV)	Emission Level (dBμV/m)	Limits (dBμV/m)	Margin (dB)	Detector
@ 5302.080	34.40	8.97	34.28	83.05	92.14	---	---	Average
5349.960	34.90	8.99	34.26	38.70	48.33	54.00	5.67	Average
5350.380	34.90	8.99	34.26	38.70	48.33	54.00	5.67	Average

Remark: The “@” means fundamental frequency, it is ignored in this section.

Mode	802.11ac-VHT80	U-NII Band	2C
		Frequency	TX 5530MHz

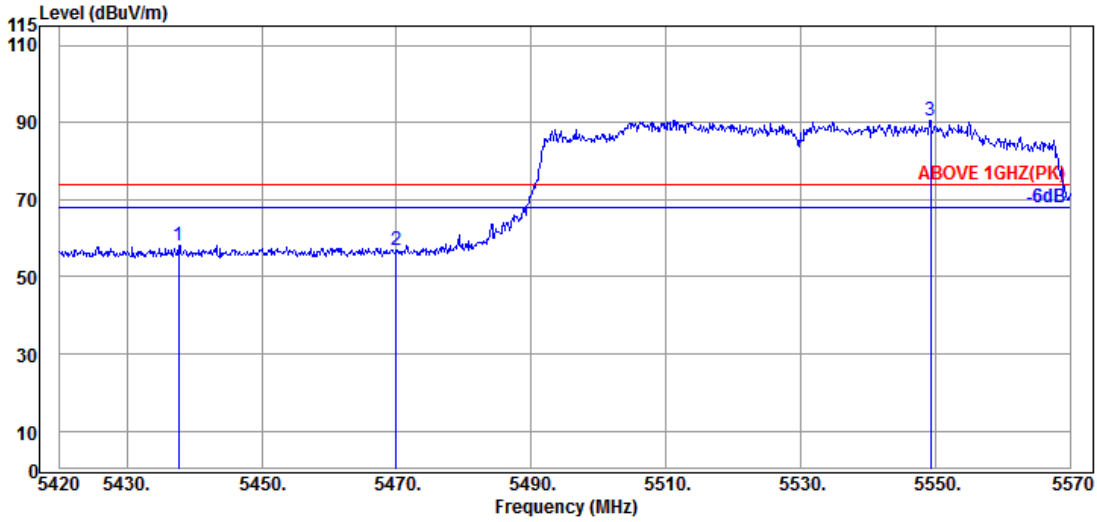

Antenna at Horizontal Polarization

Emission Frequency (MHz)	Antenna Factor (dB/m)	Cable Loss (dB)	Preamplifier Gain (dB)	Read Level (dBμV)	Emission Level (dBμV/m)	Limits (dBμV/m)	Margin (dB)	Detector
5437.700	34.65	9.04	34.22	48.64	58.11	74.00	15.89	Peak
5469.950	34.63	9.06	34.21	47.33	56.81	74.00	17.19	Peak
@ 5549.300	34.70	9.10	34.23	81.03	90.60	---	---	Peak

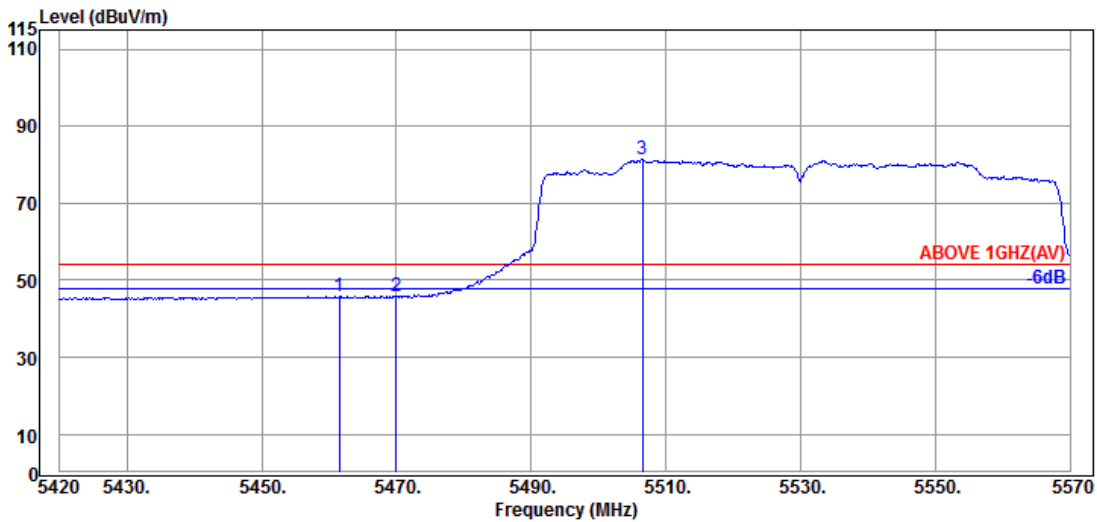

Antenna at Horizontal Polarization

Emission Frequency (MHz)	Antenna Factor (dB/m)	Cable Loss (dB)	Preamplifier Gain (dB)	Read Level (dBμV)	Emission Level (dBμV/m)	Limits (dBμV/m)	Margin (dB)	Detector
5461.550	34.60	9.05	34.21	36.50	45.94	54.00	8.06	Average
5469.950	34.63	9.06	34.21	36.21	45.69	54.00	8.31	Average
@ 5506.550	34.70	9.08	34.21	71.92	81.49	---	---	Average

Remark: The “@” means fundamental frequency, it is ignored in this section.

Mode	802.11ac-VHT80	U-NII Band	2C
		Frequency	TX 5530MHz

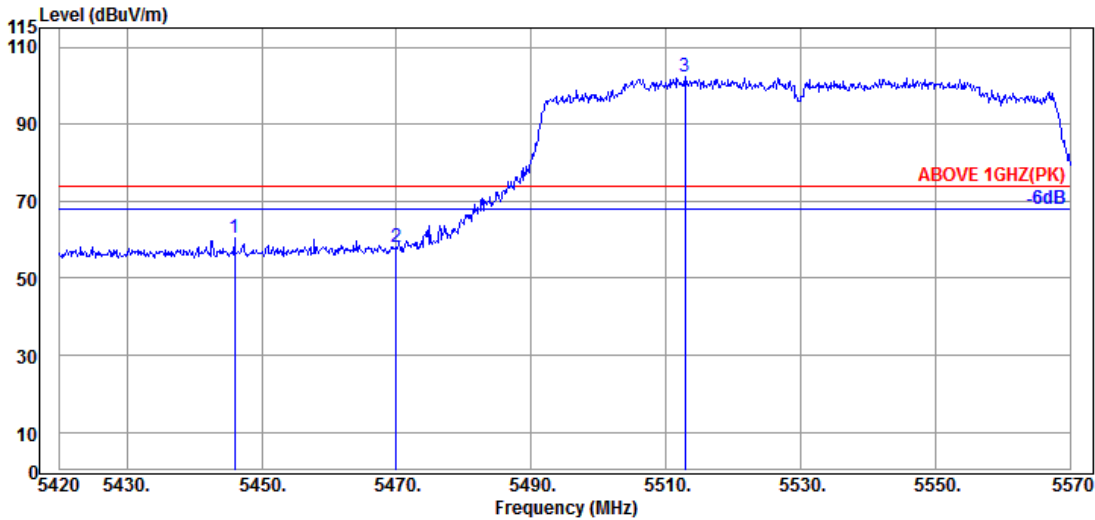

Antenna at Vertical Polarization

Emission Frequency (MHz)	Antenna Factor (dB/m)	Cable Loss (dB)	Preamplifier Gain (dB)	Read Level (dBμV)	Emission Level (dBμV/m)	Limits (dBμV/m)	Margin (dB)	Detector
5445.950	34.65	9.04	34.22	50.81	60.28	74.00	13.72	Peak
5469.950	34.63	9.06	34.21	48.43	57.91	74.00	16.09	Peak
@ 5512.850	34.70	9.09	34.21	92.69	102.27	---	---	Peak

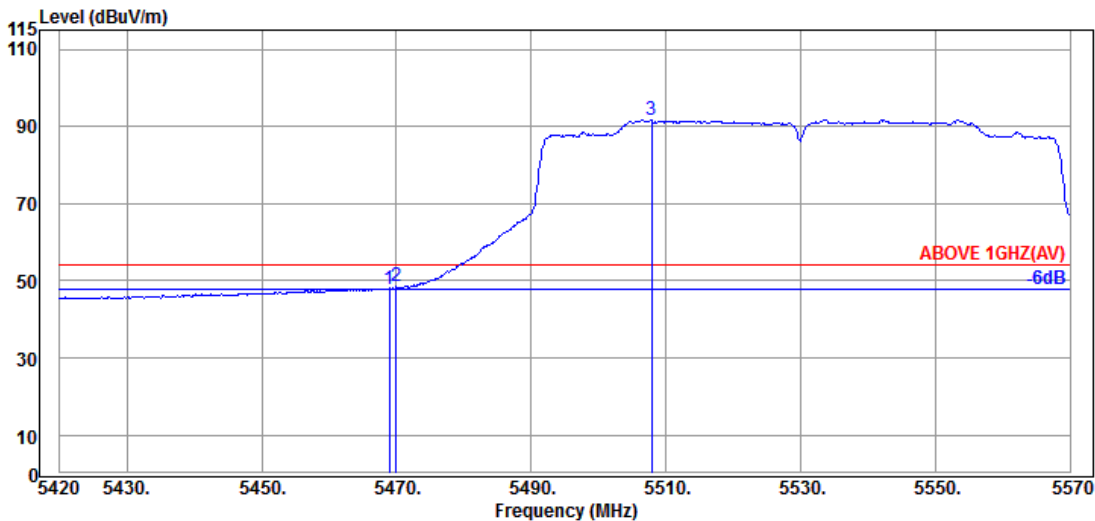

Antenna at Vertical Polarization

Emission Frequency (MHz)	Antenna Factor (dB/m)	Cable Loss (dB)	Preamplifier Gain (dB)	Read Level (dBμV)	Emission Level (dBμV/m)	Limits (dBμV/m)	Margin (dB)	Detector
5468.900	34.63	9.06	34.21	38.50	47.98	54.00	6.02	Average
5469.950	34.63	9.06	34.21	38.97	48.45	54.00	5.55	Average
@ 5507.900	34.70	9.08	34.21	82.12	91.69	---	---	Average

Remark: The "@" means fundamental frequency, it is ignored in this section.

Mode	802.11ac-VHT80	U-NII Band	2C
		Frequency	TX 5610MHz

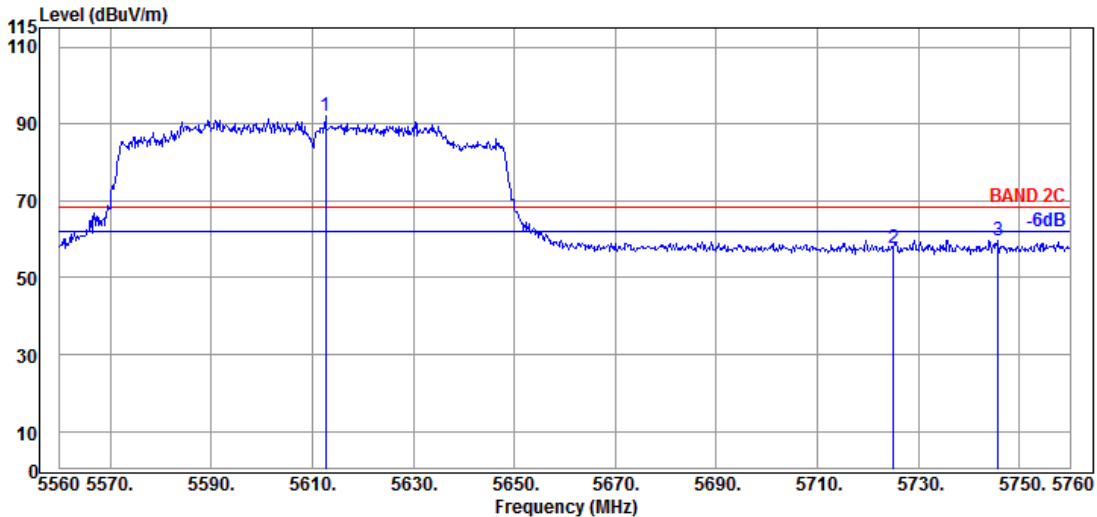

Antenna at Horizontal Polarization

Emission Frequency (MHz)	Antenna Factor (dB/m)	Cable Loss (dB)	Preamplifier Gain (dB)	Read Level (dBμV)	Emission Level (dBμV/m)	Limits (dBμV/m)	Margin (dB)	Detector
@ 5612.600	34.43	9.14	34.25	82.63	91.95	---	---	Peak
5725.000	34.90	9.20	34.30	47.99	57.79	68.20	10.41	Peak
5745.800	35.00	9.20	34.32	49.86	59.74	68.20	8.46	Peak

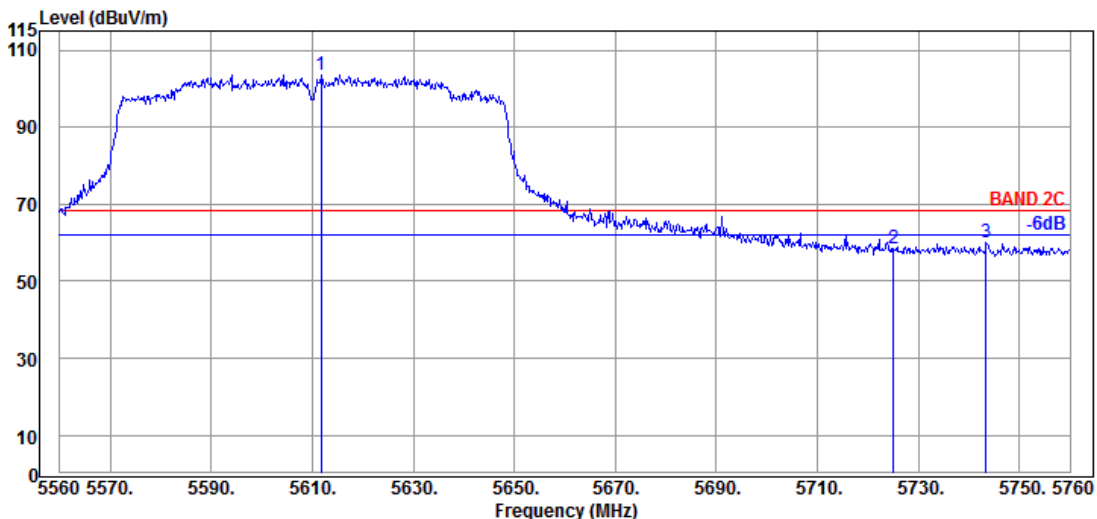

Antenna at Vertical Polarization

Emission Frequency (MHz)	Antenna Factor (dB/m)	Cable Loss (dB)	Preamplifier Gain (dB)	Read Level (dBμV)	Emission Level (dBμV/m)	Limits (dBμV/m)	Margin (dB)	Detector
@ 5611.800	34.43	9.14	34.25	94.28	103.60	---	---	Peak
5725.000	34.90	9.20	34.30	48.67	58.47	68.20	9.73	Peak
5743.400	35.00	9.20	34.31	50.03	59.92	68.20	8.28	Peak

Remark: The “@” means fundamental frequency, it is ignored in this section.

Mode	802.11ac-VHT80	U-NII Band	2C
		Frequency	TX 5690MHz

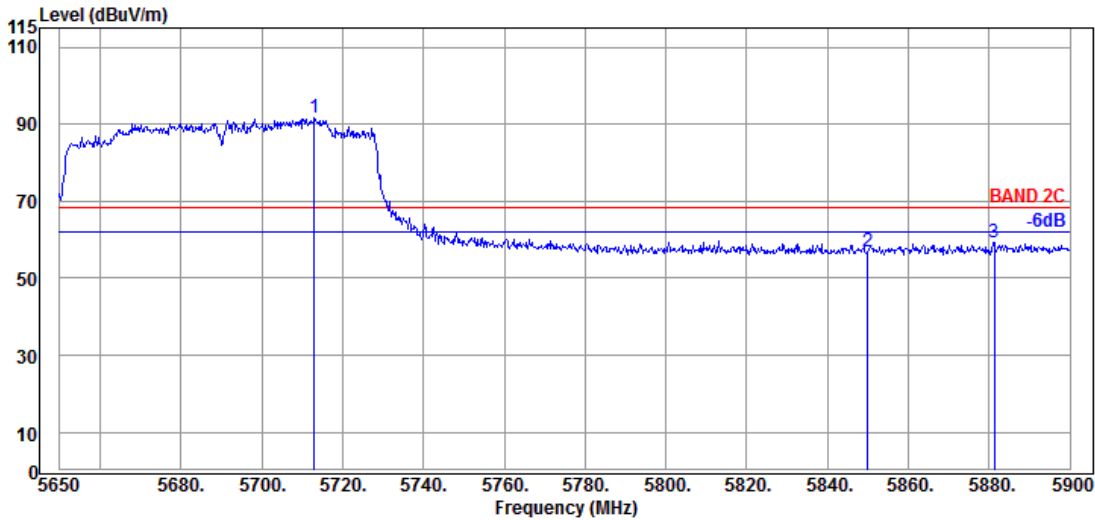

Antenna at Horizontal Polarization

Emission Frequency (MHz)	Antenna Factor (dB/m)	Cable Loss (dB)	Preamp Gain (dB)	Read Level (dBμV)	Emission Level (dBμV/m)	Limits (dBμV/m)	Margin (dB)	Detector
@ 5713.000	34.80	9.19	34.30	81.86	91.55	---	---	Peak
5850.000	35.40	9.25	34.36	46.73	57.02	68.20	11.18	Peak
5881.250	35.67	9.27	34.38	48.67	59.23	68.20	8.97	Peak

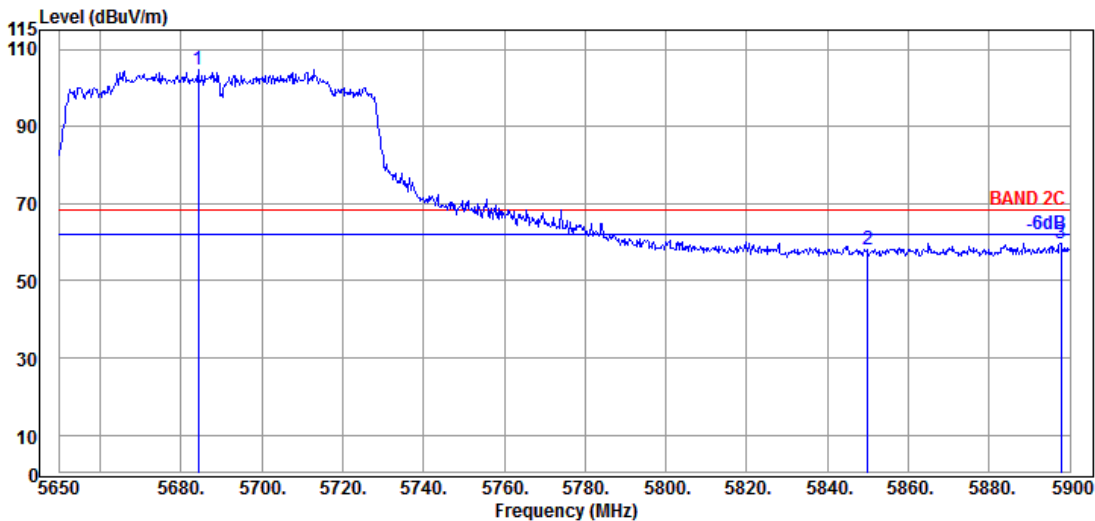

Antenna at Vertical Polarization

Emission Frequency (MHz)	Antenna Factor (dB/m)	Cable Loss (dB)	Preamp Gain (dB)	Read Level (dBμV)	Emission Level (dBμV/m)	Limits (dBμV/m)	Margin (dB)	Detector
@ 5684.250	34.63	9.17	34.29	95.09	104.60	---	---	Peak
5850.000	35.40	9.25	34.36	47.80	58.09	68.20	10.11	Peak
5897.750	35.80	9.28	34.38	49.13	59.83	68.20	8.37	Peak

Remark: The “@” means fundamental frequency, it is ignored in this section.

Mode	802.11ac-VHT80	U-NII Band	2C
		Frequency	TX 5690MHz

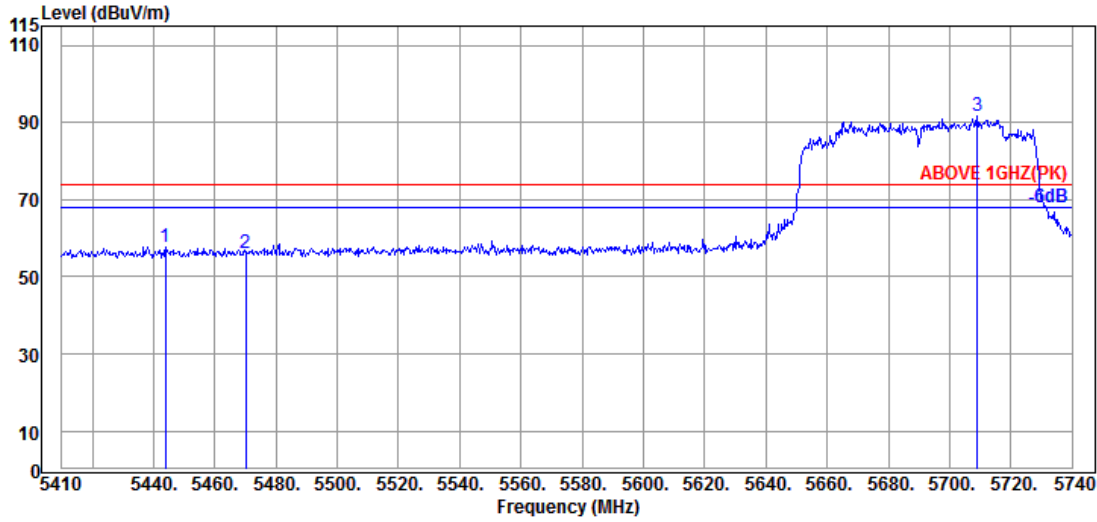

Antenna at Horizontal Polarization

Emission Frequency (MHz)	Antenna Factor (dB/m)	Cable Loss (dB)	Preamp Gain (dB)	Read Level (dBμV)	Emission Level (dBμV/m)	Limits (dBμV/m)	Margin (dB)	Detector
5443.990	34.65	9.04	34.22	48.39	57.86	74.00	16.14	Peak
5470.060	34.63	9.06	34.21	46.67	56.15	74.00	17.85	Peak
@ 5708.980	34.80	9.19	34.30	82.03	91.72	---	---	Peak

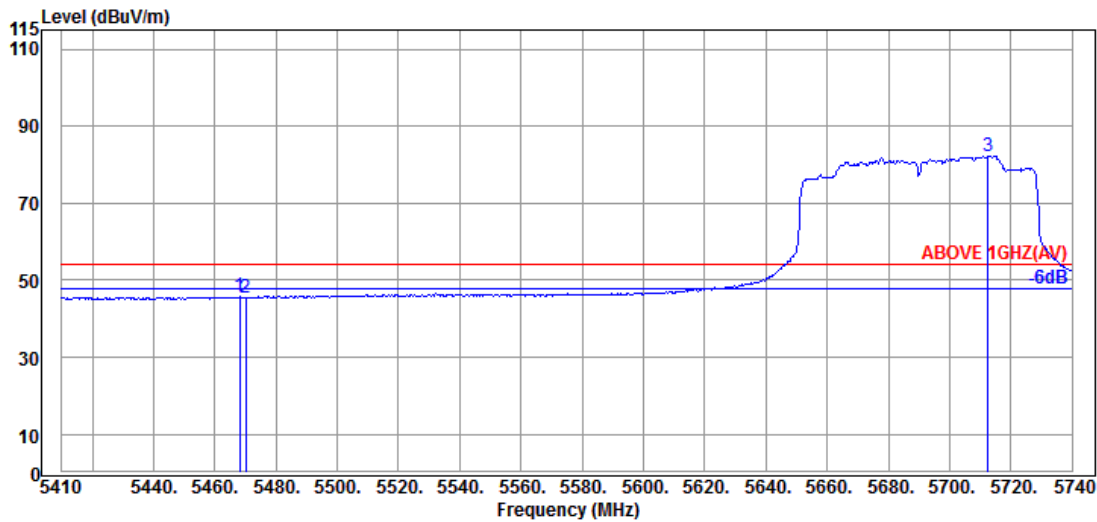

Antenna at Horizontal Polarization

Emission Frequency (MHz)	Antenna Factor (dB/m)	Cable Loss (dB)	Preamp Gain (dB)	Read Level (dBμV)	Emission Level (dBμV/m)	Limits (dBμV/m)	Margin (dB)	Detector
5468.080	34.63	9.06	34.21	36.24	45.72	54.00	8.28	Average
5470.060	34.63	9.06	34.21	36.00	45.48	54.00	8.52	Average
@ 5712.610	34.80	9.19	34.30	72.62	82.31	---	---	Average

Remark: The "@" means fundamental frequency, it is ignored in this section.

Mode	802.11ac-VHT80	U-NII Band	2C
		Frequency	TX 5690MHz

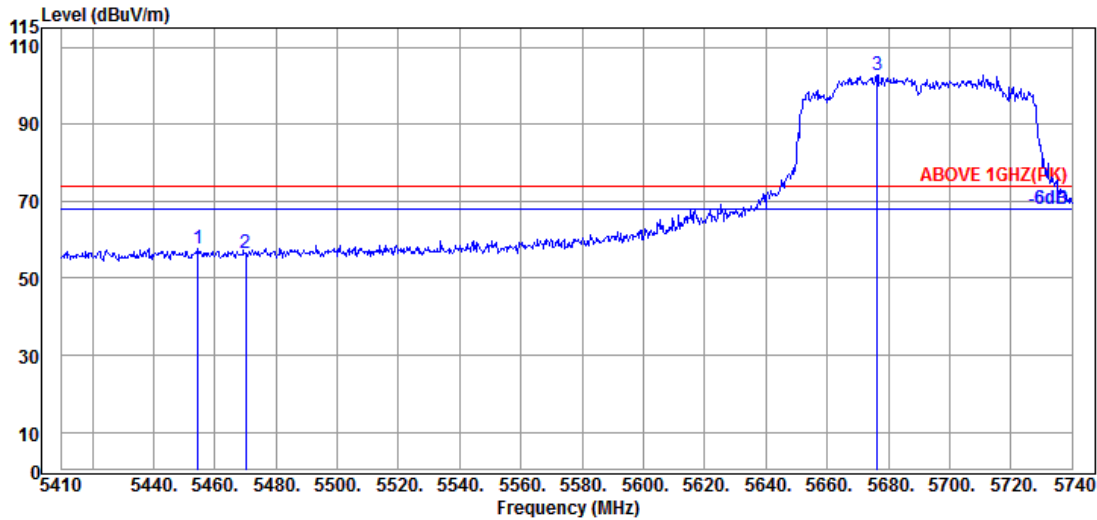

Antenna at Vertical Polarization

Emission Frequency (MHz)	Antenna Factor (dB/m)	Cable Loss (dB)	Preamp Gain (dB)	Read Level (dBμV)	Emission Level (dBμV/m)	Limits (dBμV/m)	Margin (dB)	Detector
5454.550	34.60	9.05	34.21	48.30	57.74	74.00	16.26	Peak
5470.060	34.63	9.06	34.21	47.05	56.53	74.00	17.47	Peak
@ 5676.310	34.63	9.17	34.29	93.38	102.89	---	---	Peak

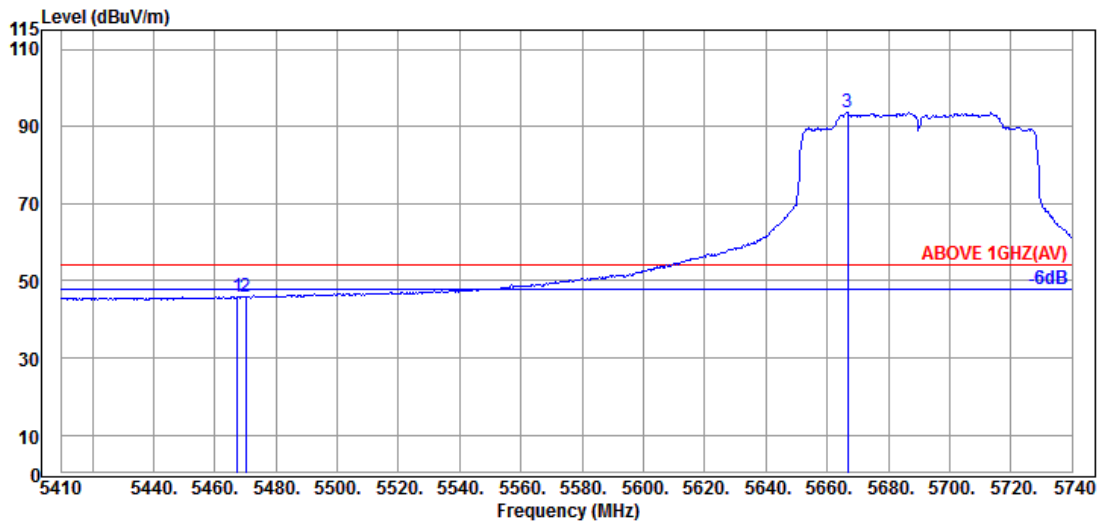

Antenna at Vertical Polarization

Emission Frequency (MHz)	Antenna Factor (dB/m)	Cable Loss (dB)	Preamp Gain (dB)	Read Level (dBμV)	Emission Level (dBμV/m)	Limits (dBμV/m)	Margin (dB)	Detector
5467.420	34.63	9.06	34.21	36.44	45.92	54.00	8.08	Average
5470.060	34.63	9.06	34.21	36.23	45.71	54.00	8.29	Average
@ 5666.740	34.57	9.16	34.28	84.17	93.62	---	---	Average

Remark: The "@" means fundamental frequency, it is ignored in this section.

Mode	802.11ac-VHT80	U-NII Band	3
		Frequency	TX 5775MHz

Antenna at Horizontal Polarization

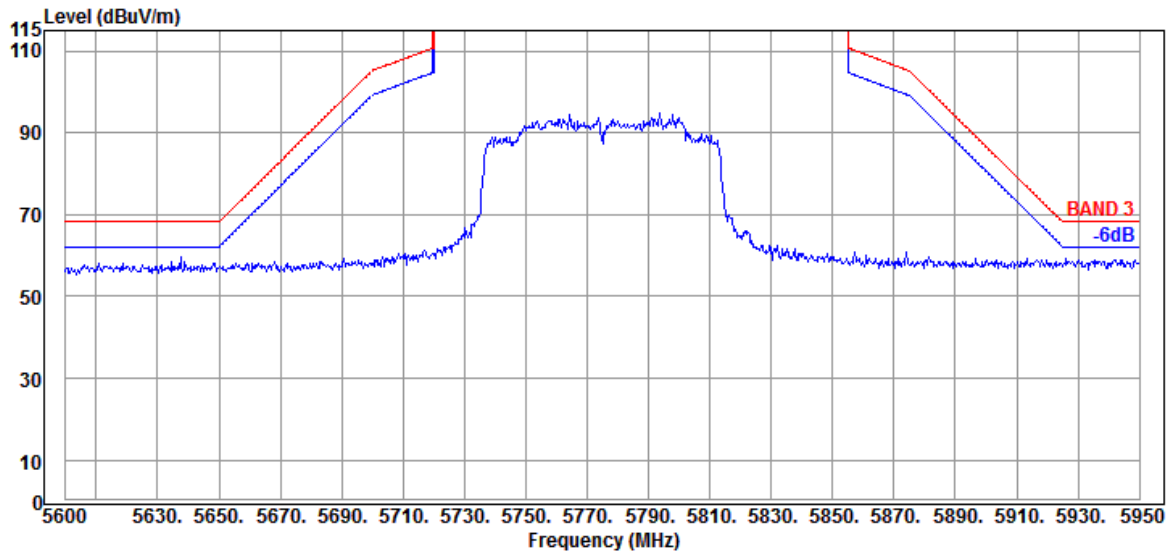

Antenna at Vertical Polarization

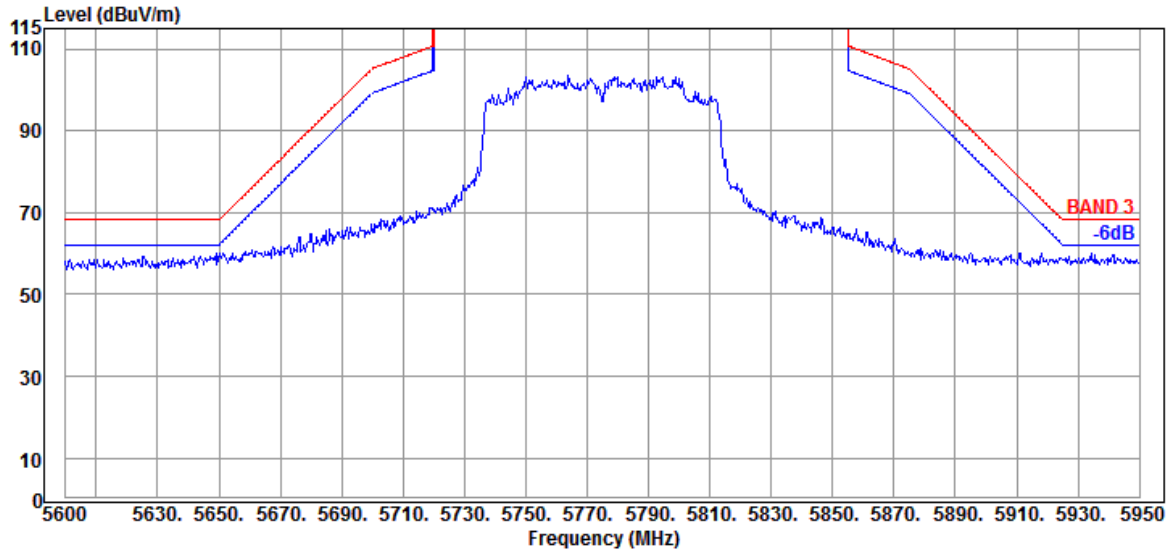

Mode	802.11ac-VH160	U-NII Band	1 & 2A
		Frequency	TX 5250MHz

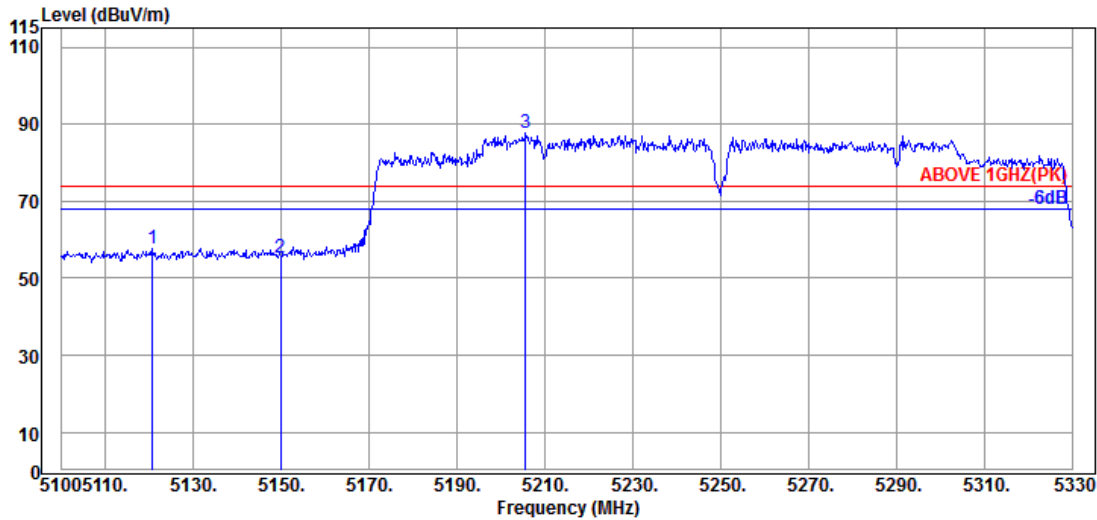

Antenna at Horizontal Polarization

Emission Frequency (MHz)	Antenna Factor (dB/m)	Cable Loss (dB)	Preamp Gain (dB)	Read Level (dBμV)	Emission Level (dBμV/m)	Limits (dBμV/m)	Margin (dB)	Detector
5120.700	34.30	8.87	34.35	49.04	57.86	74.00	16.14	Peak
5149.910	34.50	8.88	34.34	46.46	55.50	74.00	18.50	Peak
@ 5205.570	34.65	8.92	34.32	78.49	87.74	---	---	Peak

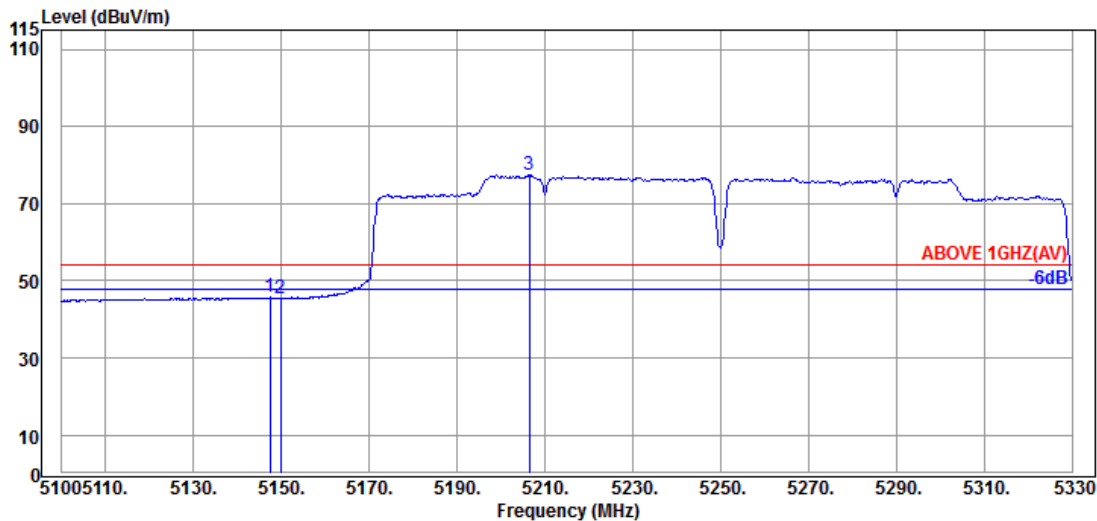

Antenna at Horizontal Polarization

Emission Frequency (MHz)	Antenna Factor (dB/m)	Cable Loss (dB)	Preamp Gain (dB)	Read Level (dBμV)	Emission Level (dBμV/m)	Limits (dBμV/m)	Margin (dB)	Detector
5147.380	34.50	8.88	34.34	36.69	45.73	54.00	8.27	Average
5149.910	34.50	8.88	34.34	36.41	45.45	54.00	8.55	Average
@ 5206.490	34.65	8.92	34.32	68.21	77.46	---	---	Average

Remark: The “@” means fundamental frequency, it is ignored in this section.

Mode	802.11ac-VH160	U-NII Band	1 & 2A
		Frequency	TX 5250MHz

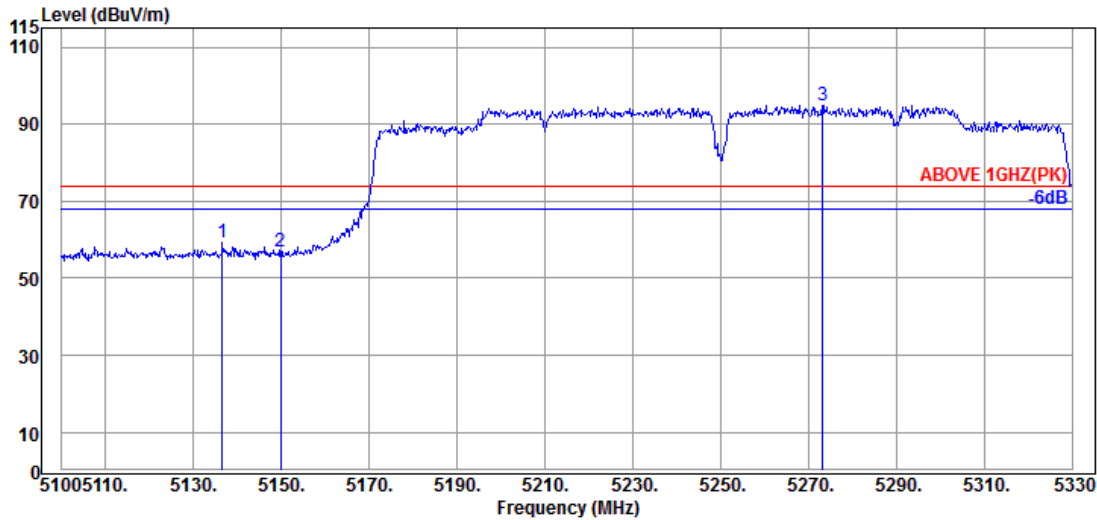

Antenna at Vertical Polarization

Emission Frequency (MHz)	Antenna Factor (dB/m)	Cable Loss (dB)	Preamp Gain (dB)	Read Level (dBμV)	Emission Level (dBμV/m)	Limits (dBμV/m)	Margin (dB)	Detector
5136.570	34.40	8.88	34.34	50.38	59.32	74.00	14.68	Peak
5149.910	34.50	8.88	34.34	48.06	57.10	74.00	16.90	Peak
@ 5273.190	34.47	8.95	34.29	85.88	95.01	---	---	Peak

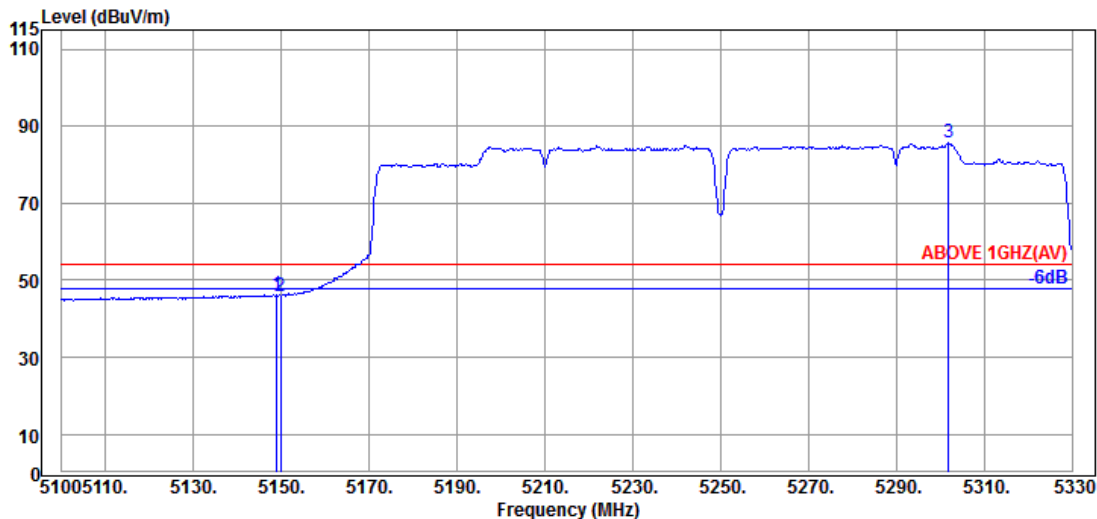

Antenna at Vertical Polarization

Emission Frequency (MHz)	Antenna Factor (dB/m)	Cable Loss (dB)	Preamp Gain (dB)	Read Level (dBμV)	Emission Level (dBμV/m)	Limits (dBμV/m)	Margin (dB)	Detector
5148.990	34.50	8.88	34.34	37.11	46.15	54.00	7.85	Average
5149.910	34.50	8.88	34.34	36.78	45.82	54.00	8.18	Average
@ 5301.940	34.40	8.97	34.28	76.55	85.64	---	---	Average

Remark: The “@” means fundamental frequency, it is ignored in this section.

Mode	802.11ac-VH160	U-NII Band	1 & 2A
		Frequency	TX 5250MHz

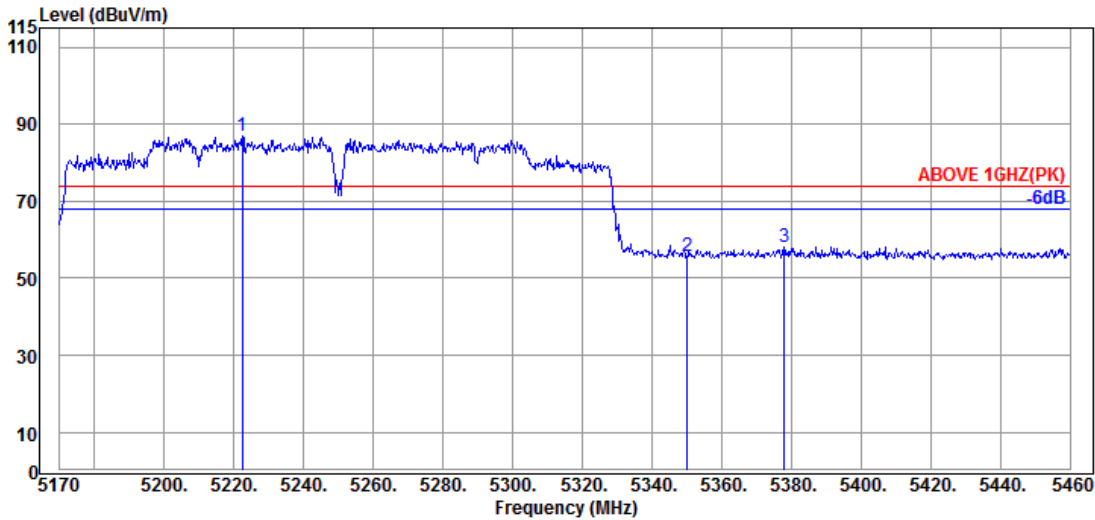

Antenna at Horizontal Polarization

Emission Frequency (MHz)	Antenna Factor (dB/m)	Cable Loss (dB)	Preamp Gain (dB)	Read Level (dBμV)	Emission Level (dBμV/m)	Limits (dBμV/m)	Margin (dB)	Detector
@ 5222.490	34.60	8.93	34.31	77.69	86.91	---	---	Peak
5350.090	34.90	8.99	34.26	46.10	55.73	74.00	18.27	Peak
5377.930	34.83	9.01	34.25	48.53	58.12	74.00	15.88	Peak

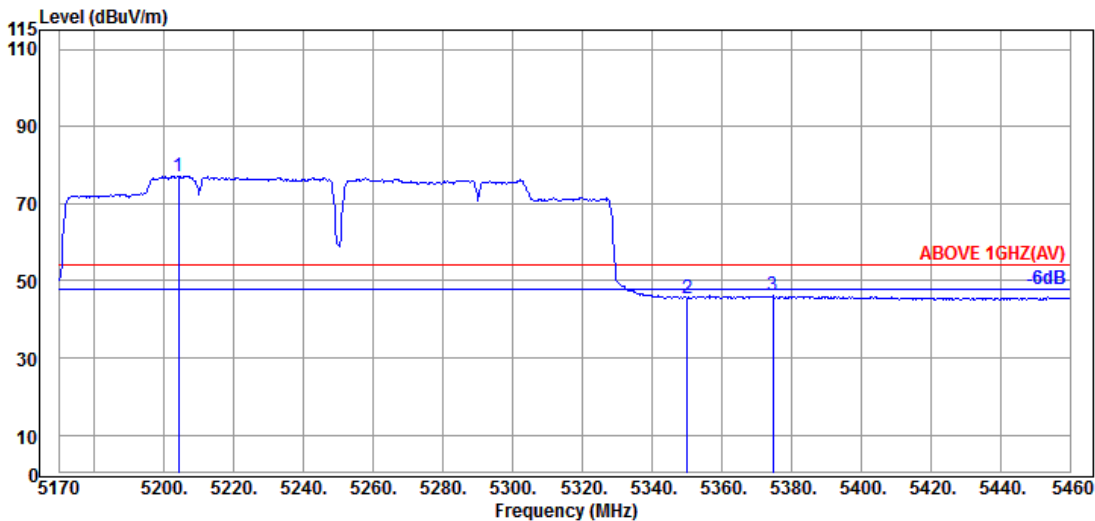

Antenna at Horizontal Polarization

Emission Frequency (MHz)	Antenna Factor (dB/m)	Cable Loss (dB)	Preamp Gain (dB)	Read Level (dBμV)	Emission Level (dBμV/m)	Limits (dBμV/m)	Margin (dB)	Detector
@ 5204.220	34.65	8.92	34.32	67.92	77.17	---	---	Average
5350.090	34.90	8.99	34.26	35.94	45.57	54.00	8.43	Average
5374.740	34.83	9.01	34.25	36.51	46.10	54.00	7.90	Average

Remark: The “@” means fundamental frequency, it is ignored in this section.

Mode	802.11ac-VH160	U-NII Band	1 & 2A
		Frequency	TX 5250MHz

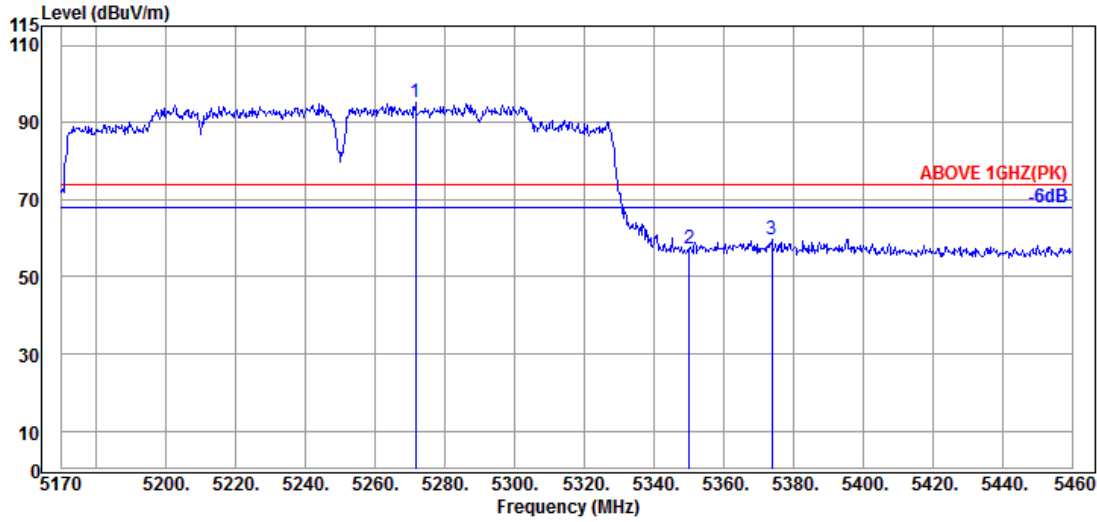

Antenna at Vertical Polarization

Emission Frequency (MHz)	Antenna Factor (dB/m)	Cable Loss (dB)	Preamplifier Gain (dB)	Read Level (dBμV)	Emission Level (dBμV/m)	Limits (dBμV/m)	Margin (dB)	Detector
@ 5271.500	34.47	8.95	34.29	86.00	95.13	---	---	Peak
5350.090	34.90	8.99	34.26	47.66	57.29	74.00	16.71	Peak
5373.870	34.83	9.01	34.25	50.18	59.77	74.00	14.23	Peak

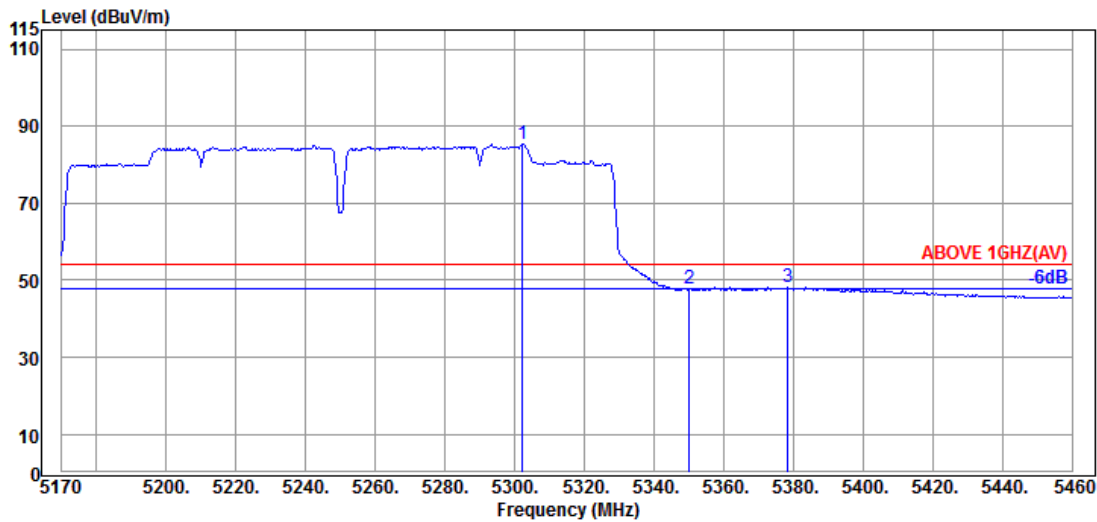

Antenna at Vertical Polarization

Emission Frequency (MHz)	Antenna Factor (dB/m)	Cable Loss (dB)	Preamplifier Gain (dB)	Read Level (dBμV)	Emission Level (dBμV/m)	Limits (dBμV/m)	Margin (dB)	Detector
@ 5302.240	34.40	8.97	34.28	76.30	85.39	---	---	Average
5350.090	34.90	8.99	34.26	38.07	47.70	54.00	6.30	Average
5378.510	34.83	9.01	34.25	38.48	48.07	54.00	5.93	Average

Remark: The “@” means fundamental frequency, it is ignored in this section.

Mode	802.11ac-VHT160	U-NII Band	2C
		Frequency	TX 5570MHz

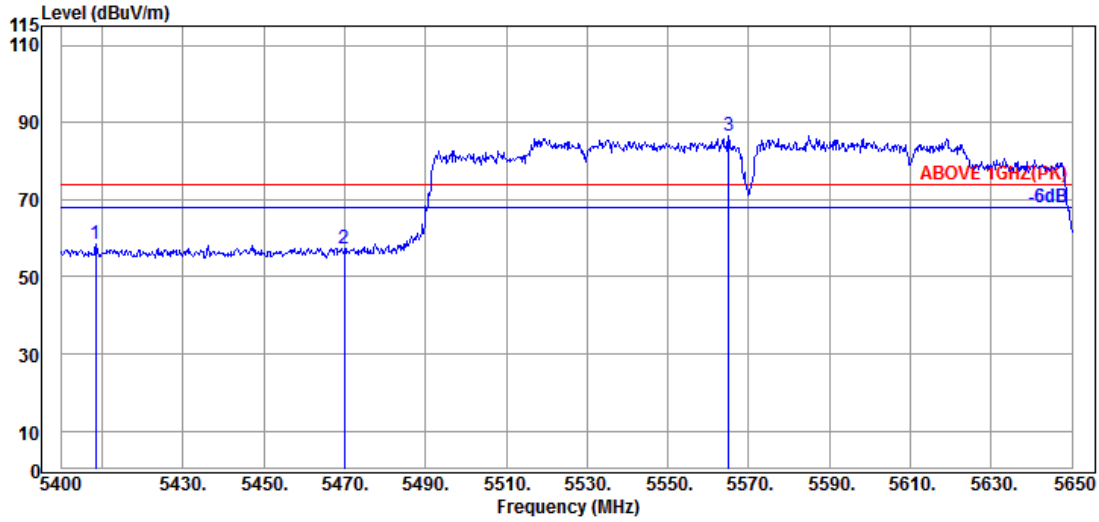

Antenna at Horizontal Polarization

Emission Frequency (MHz)	Antenna Factor (dB/m)	Cable Loss (dB)	Preamp Gain (dB)	Read Level (dBμV)	Emission Level (dBμV/m)	Limits (dBμV/m)	Margin (dB)	Detector
5408.500	34.75	9.03	34.23	48.78	58.33	74.00	15.67	Peak
5470.000	34.63	9.06	34.21	47.93	57.41	74.00	16.59	Peak
@ 5565.000	34.60	9.11	34.23	77.19	86.67	---	---	Peak

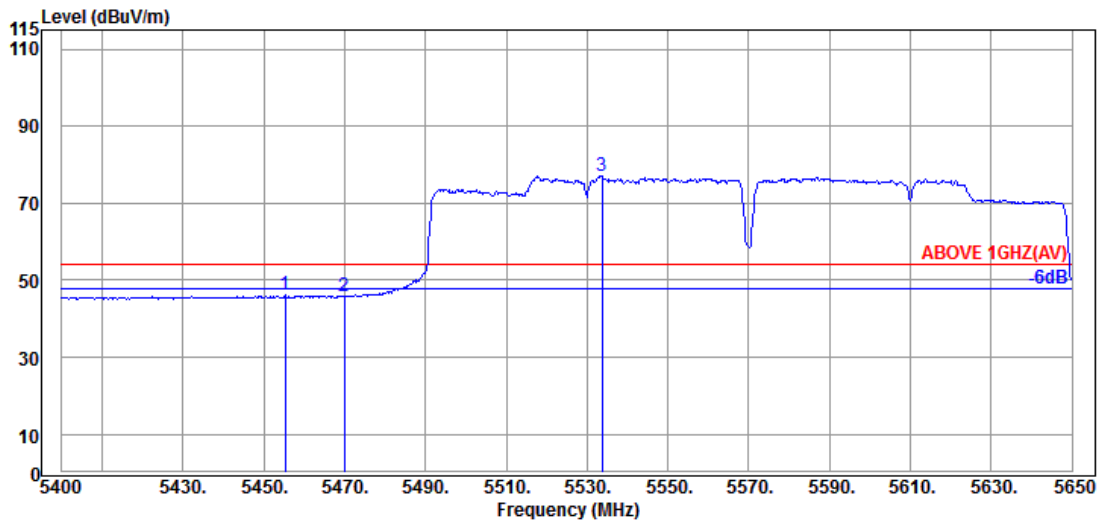

Antenna at Horizontal Polarization

Emission Frequency (MHz)	Antenna Factor (dB/m)	Cable Loss (dB)	Preamp Gain (dB)	Read Level (dBμV)	Emission Level (dBμV/m)	Limits (dBμV/m)	Margin (dB)	Detector
5455.250	34.60	9.05	34.21	36.60	46.04	54.00	7.96	Average
5470.000	34.63	9.06	34.21	36.22	45.70	54.00	8.30	Average
@ 5533.750	34.70	9.09	34.22	67.50	77.07	---	---	Average

Remark: The “@” means fundamental frequency, it is ignored in this section.

Mode	802.11ac-VHT160	U-NII Band	2C
		Frequency	TX 5570MHz

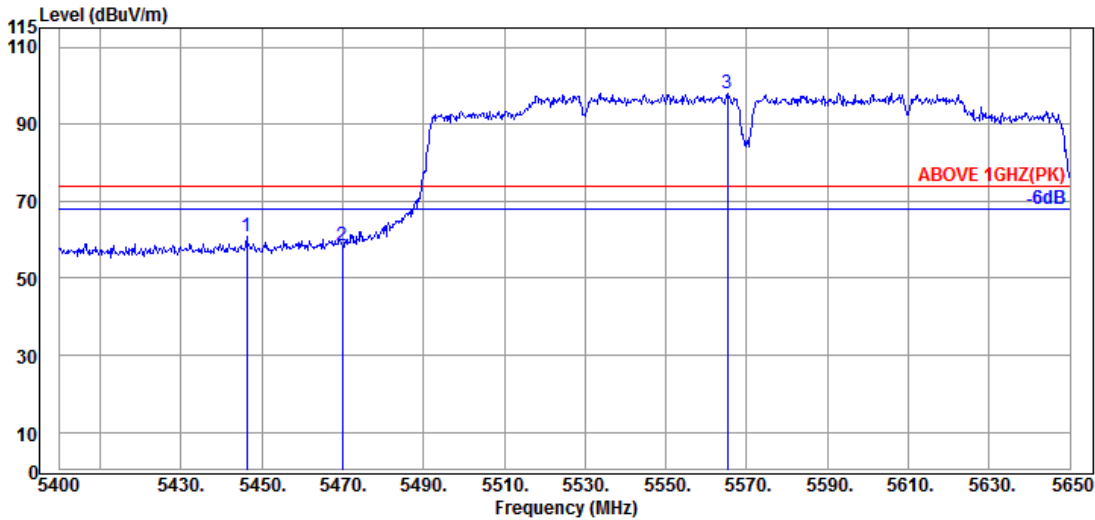

Antenna at Vertical Polarization

Emission Frequency (MHz)	Antenna Factor (dB/m)	Cable Loss (dB)	Preamplifier Gain (dB)	Read Level (dBμV)	Emission Level (dBμV/m)	Limits (dBμV/m)	Margin (dB)	Detector
5446.250	34.65	9.04	34.22	51.49	60.96	74.00	13.04	Peak
5470.000	34.63	9.06	34.21	49.05	58.53	74.00	15.47	Peak
@ 5565.250	34.60	9.11	34.23	88.44	97.92	---	---	Peak

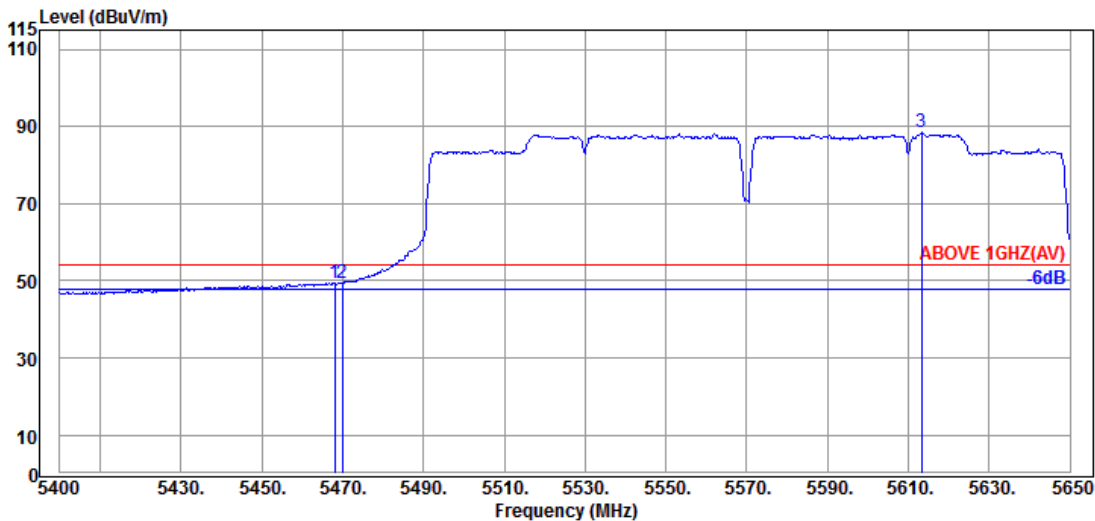

Antenna at Vertical Polarization

Emission Frequency (MHz)	Antenna Factor (dB/m)	Cable Loss (dB)	Preamplifier Gain (dB)	Read Level (dBμV)	Emission Level (dBμV/m)	Limits (dBμV/m)	Margin (dB)	Detector
5468.000	34.63	9.06	34.21	39.99	49.47	54.00	4.53	Average
5470.000	34.63	9.06	34.21	40.02	49.50	54.00	4.50	Average
@ 5613.250	34.43	9.14	34.25	79.06	88.38	---	---	Average

Remark: The “@” means fundamental frequency, it is ignored in this section.

Mode	802.11ac-VH160	U-NII Band	2C
		Frequency	TX 5570MHz

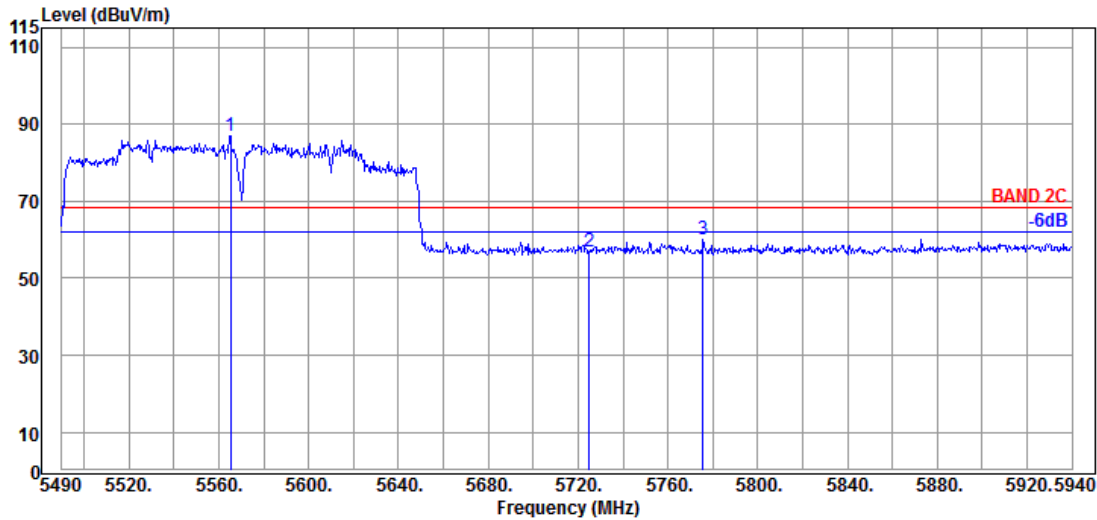

Antenna at Horizontal Polarization

Emission Frequency (MHz)	Antenna Factor (dB/m)	Cable Loss (dB)	Preamp Gain (dB)	Read Level (dBμV)	Emission Level (dBμV/m)	Limits (dBμV/m)	Margin (dB)	Detector
@ 5565.150	34.60	9.11	34.23	77.54	87.02	---	---	Peak
5724.900	34.90	9.20	34.30	47.11	56.91	68.20	11.29	Peak
5775.750	35.07	9.22	34.33	49.97	59.93	68.20	8.27	Peak

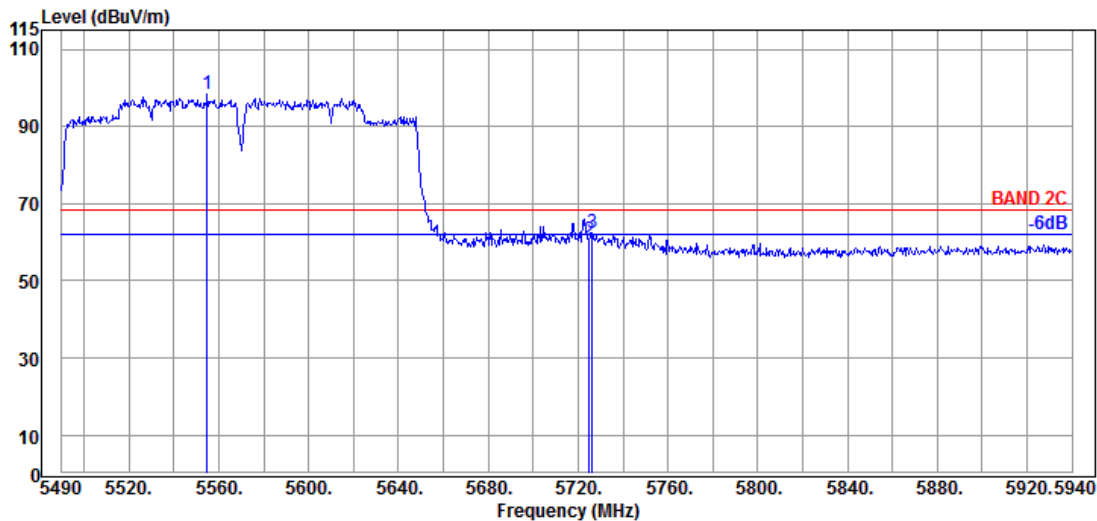

Antenna at Vertical Polarization

Emission Frequency (MHz)	Antenna Factor (dB/m)	Cable Loss (dB)	Preamp Gain (dB)	Read Level (dBμV)	Emission Level (dBμV/m)	Limits (dBμV/m)	Margin (dB)	Detector
@ 5554.800	34.70	9.10	34.23	88.77	98.34	---	---	Peak
5724.900	34.90	9.20	34.30	50.78	60.58	68.20	7.62	Peak
5726.250	34.90	9.20	34.30	52.84	62.64	68.20	5.56	Peak

Remark: The “@” means fundamental frequency, it is ignored in this section.

Mode	802.11ax-HE20	U-NII Band	1
		Frequency	TX 5180MHz

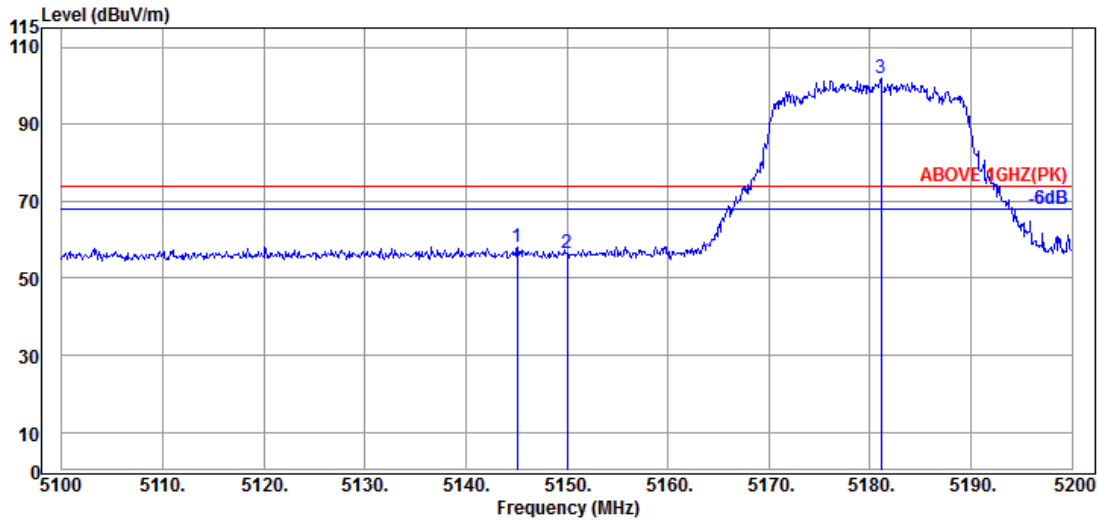

Antenna at Horizontal Polarization

Emission Frequency (MHz)	Antenna Factor (dB/m)	Cable Loss (dB)	Preamp Gain (dB)	Read Level (dBμV)	Emission Level (dBμV/m)	Limits (dBμV/m)	Margin (dB)	Detector
5145.100	34.50	8.88	34.34	49.17	58.21	74.00	15.79	Peak
5150.000	34.50	8.88	34.34	47.46	56.50	74.00	17.50	Peak
@ 5181.100	34.63	8.90	34.32	92.83	102.04	---	---	Peak

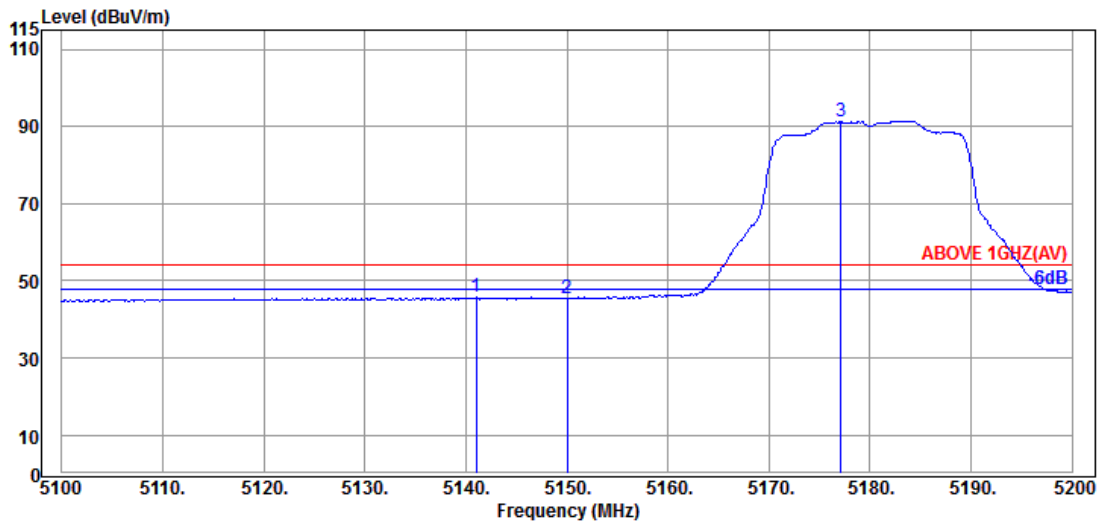

Antenna at Horizontal Polarization

Emission Frequency (MHz)	Antenna Factor (dB/m)	Cable Loss (dB)	Preamp Gain (dB)	Read Level (dBμV)	Emission Level (dBμV/m)	Limits (dBμV/m)	Margin (dB)	Detector
5141.000	34.40	8.88	34.34	36.77	45.71	54.00	8.29	Average
5150.000	34.50	8.88	34.34	36.39	45.43	54.00	8.57	Average
@ 5177.100	34.63	8.90	34.32	82.18	91.39	---	---	Average

Remark: The “@” means fundamental frequency, it is ignored in this section.

Mode	802.11ax-HE20	U-NII Band	1
		Frequency	TX 5180MHz

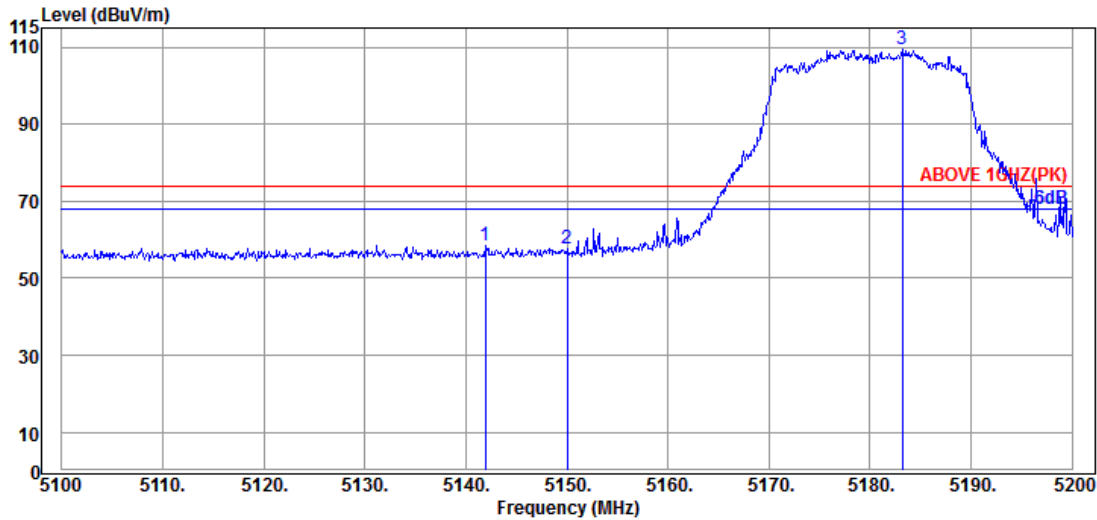

Antenna at Vertical Polarization

Emission Frequency (MHz)	Antenna Factor (dB/m)	Cable Loss (dB)	Preamp Gain (dB)	Read Level (dBμV)	Emission Level (dBμV/m)	Limits (dBμV/m)	Margin (dB)	Detector
5141.900	34.50	8.88	34.34	49.47	58.51	74.00	15.49	Peak
5150.000	34.50	8.88	34.34	48.49	57.53	74.00	16.47	Peak
@ 5183.200	34.63	8.90	34.32	100.25	109.46	---	---	Peak

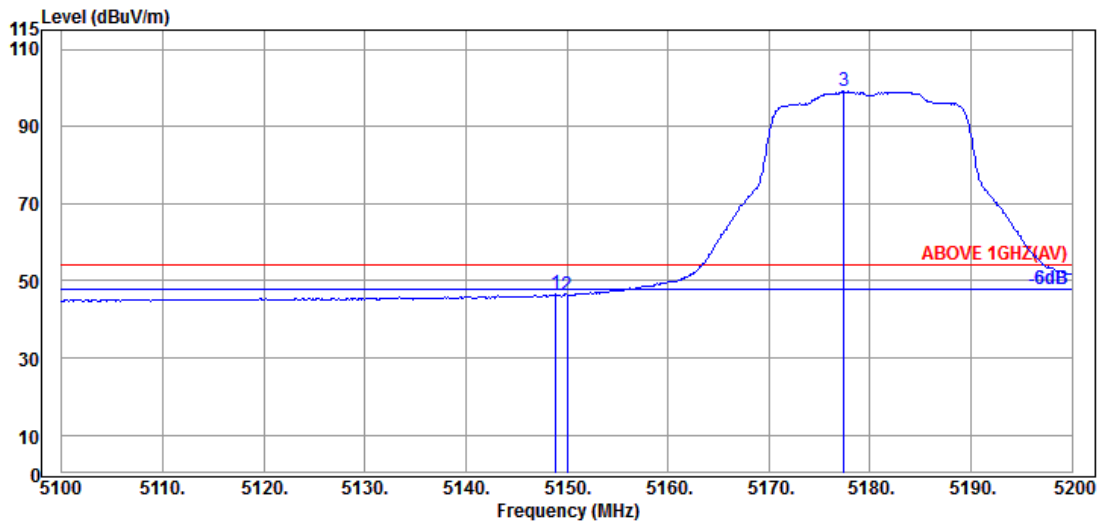

Antenna at Vertical Polarization

Emission Frequency (MHz)	Antenna Factor (dB/m)	Cable Loss (dB)	Preamp Gain (dB)	Read Level (dBμV)	Emission Level (dBμV/m)	Limits (dBμV/m)	Margin (dB)	Detector
5148.900	34.50	8.88	34.34	37.43	46.47	54.00	7.53	Average
5150.000	34.50	8.88	34.34	37.27	46.31	54.00	7.69	Average
@ 5177.400	34.63	8.90	34.32	89.88	99.09	---	---	Average

Remark: The “@” means fundamental frequency, it is ignored in this section.

Mode	802.11ax-HE20	U-NII Band	2A
		Frequency	TX 5320MHz

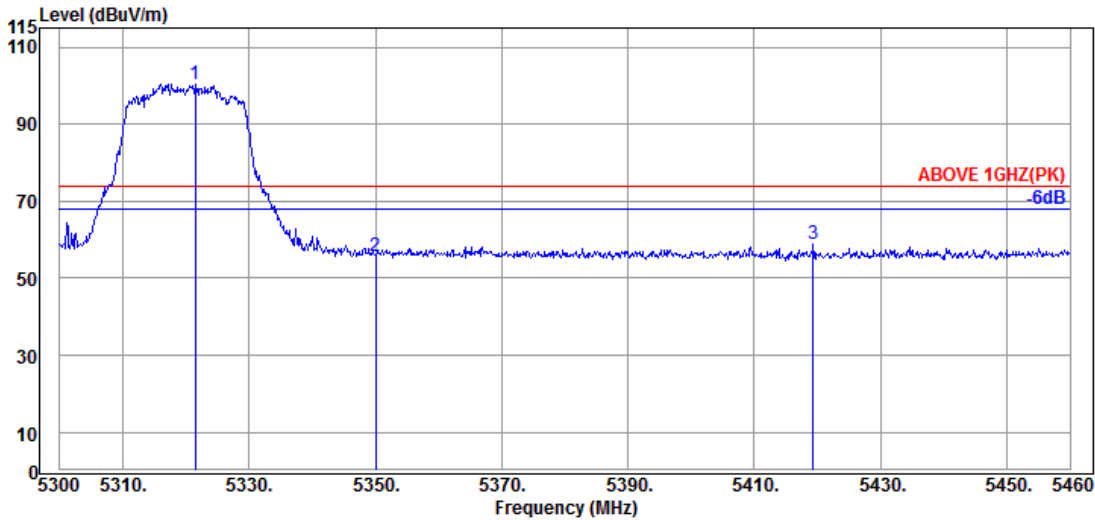

Antenna at Horizontal Polarization

Emission Frequency (MHz)	Antenna Factor (dB/m)	Cable Loss (dB)	Preamp Gain (dB)	Read Level (dBμV)	Emission Level (dBμV/m)	Limits (dBμV/m)	Margin (dB)	Detector
@ 5321.440	34.57	8.98	34.27	91.23	100.51	---	---	Peak
5350.080	34.90	8.99	34.26	46.21	55.84	74.00	18.16	Peak
5419.360	34.70	9.04	34.23	49.41	58.92	74.00	15.08	Peak

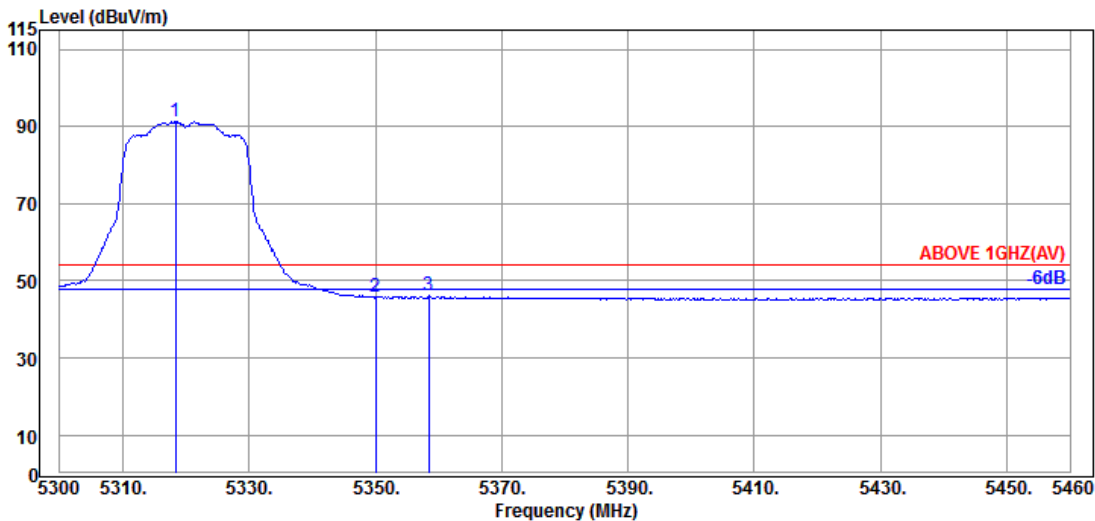

Antenna at Horizontal Polarization

Emission Frequency (MHz)	Antenna Factor (dB/m)	Cable Loss (dB)	Preamp Gain (dB)	Read Level (dBμV)	Emission Level (dBμV/m)	Limits (dBμV/m)	Margin (dB)	Detector
@ 5318.400	34.57	8.98	34.27	82.12	91.40	---	---	Average
5350.080	34.90	8.99	34.26	36.13	45.76	54.00	8.24	Average
5358.400	34.87	9.00	34.26	36.48	46.09	54.00	7.91	Average

Remark: The “@” means fundamental frequency, it is ignored in this section.

Mode	802.11ax-HE20	U-NII Band	2A
		Frequency	TX 5320MHz

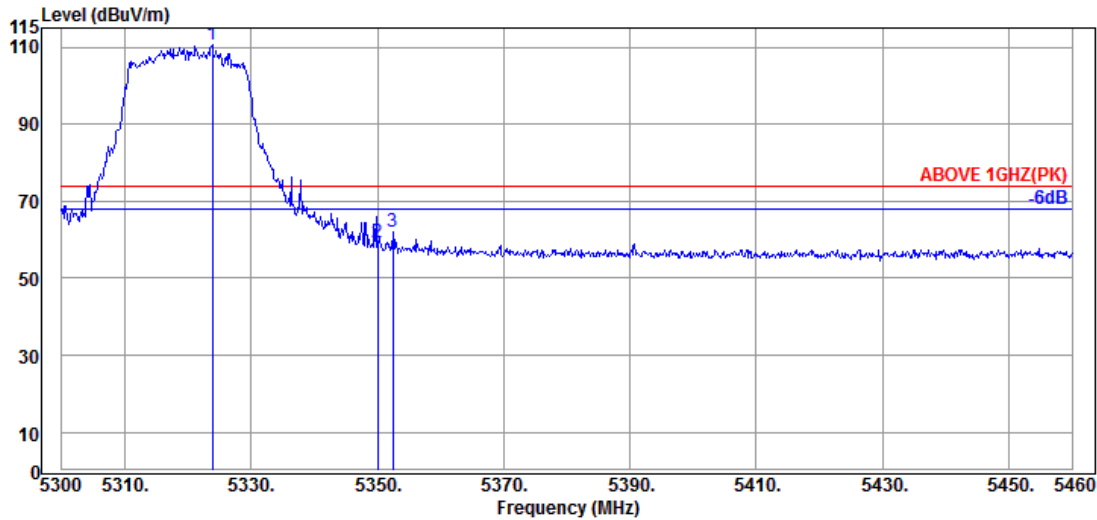

Antenna at Vertical Polarization

Emission Frequency (MHz)	Antenna Factor (dB/m)	Cable Loss (dB)	Preamplifier Gain (dB)	Read Level (dBμV)	Emission Level (dBμV/m)	Limits (dBμV/m)	Margin (dB)	Detector
@ 5323.840	34.73	8.99	34.27	101.21	110.66	---	---	Peak
5350.080	34.90	8.99	34.26	49.52	59.15	74.00	14.85	Peak
5352.480	34.90	8.99	34.26	52.37	62.00	74.00	12.00	Peak

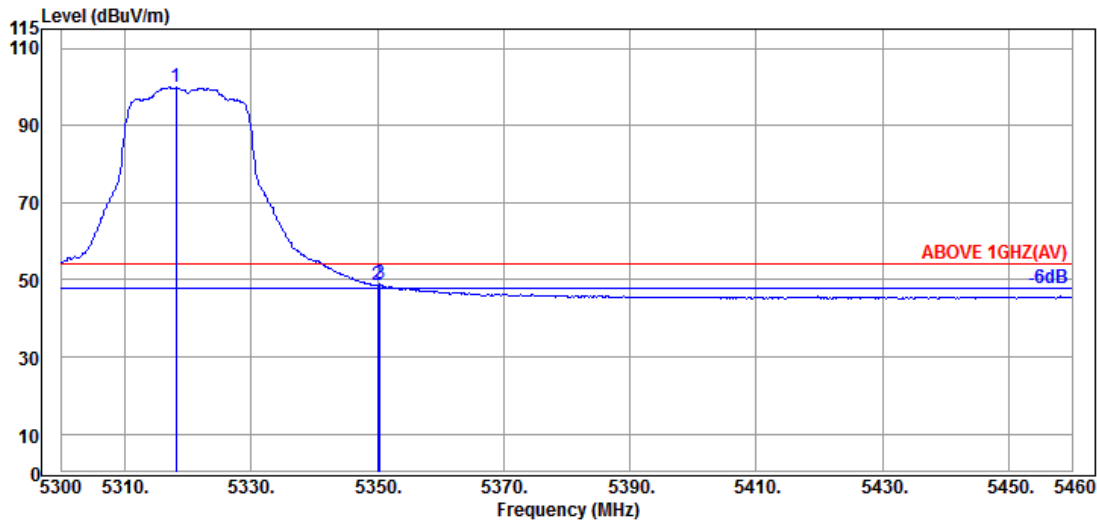

Antenna at Vertical Polarization

Emission Frequency (MHz)	Antenna Factor (dB/m)	Cable Loss (dB)	Preamplifier Gain (dB)	Read Level (dBμV)	Emission Level (dBμV/m)	Limits (dBμV/m)	Margin (dB)	Detector
@ 5318.080	34.57	8.98	34.27	90.76	100.04	---	---	Average
5350.080	34.90	8.99	34.26	38.81	48.44	54.00	5.56	Average
5350.400	34.90	8.99	34.26	39.26	48.89	54.00	5.11	Average

Remark: The “@” means fundamental frequency, it is ignored in this section.

Mode	802.11ax-HE20	U-NII Band	2C
		Frequency	TX 5500MHz

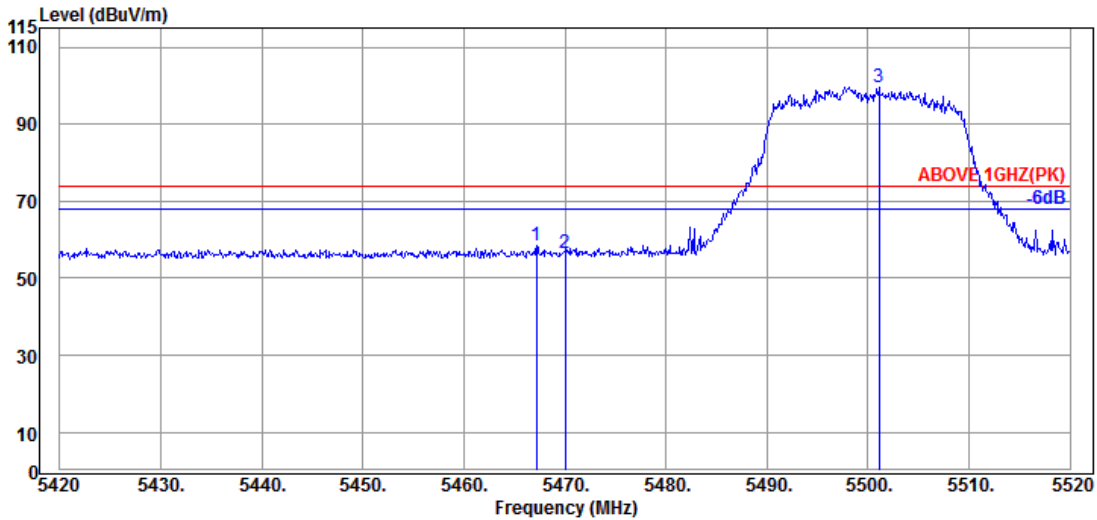

Antenna at Horizontal Polarization

Emission Frequency (MHz)	Antenna Factor (dB/m)	Cable Loss (dB)	Preamp Gain (dB)	Read Level (dBμV)	Emission Level (dBμV/m)	Limits (dBμV/m)	Margin (dB)	Detector
5467.200	34.63	9.06	34.21	48.82	58.30	74.00	15.70	Peak
5470.000	34.63	9.06	34.21	46.98	56.46	74.00	17.54	Peak
@ 5501.100	34.70	9.08	34.20	90.14	99.72	---	---	Peak

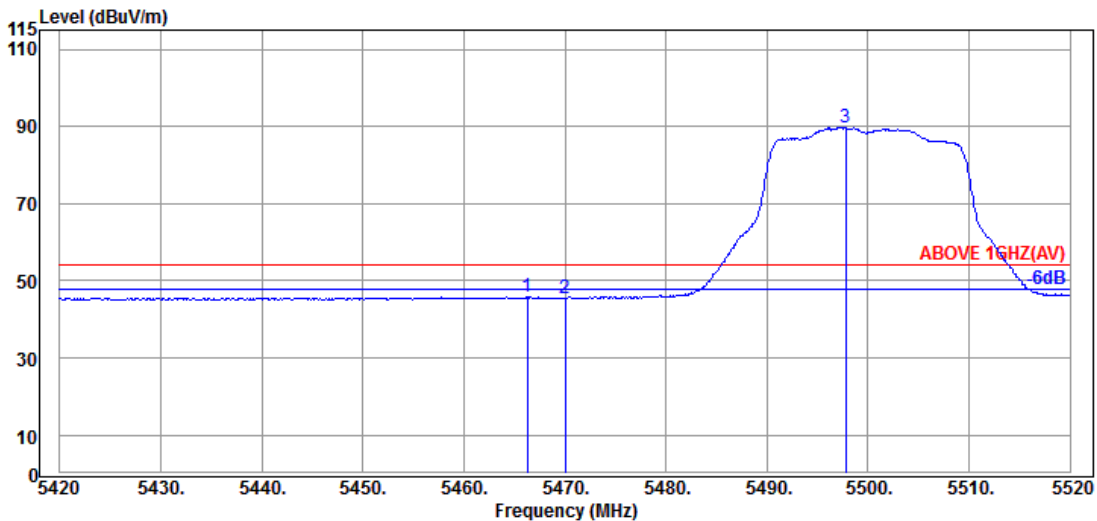

Antenna at Horizontal Polarization

Emission Frequency (MHz)	Antenna Factor (dB/m)	Cable Loss (dB)	Preamp Gain (dB)	Read Level (dBμV)	Emission Level (dBμV/m)	Limits (dBμV/m)	Margin (dB)	Detector
5466.300	34.63	9.06	34.21	36.40	45.88	54.00	8.12	Average
5470.000	34.63	9.06	34.21	36.04	45.52	54.00	8.48	Average
@ 5497.800	34.70	9.08	34.20	80.12	89.70	---	---	Average

Remark: The “@” means fundamental frequency, it is ignored in this section.

Mode	802.11ax-HE20	U-NII Band	2C
		Frequency	TX 5500MHz

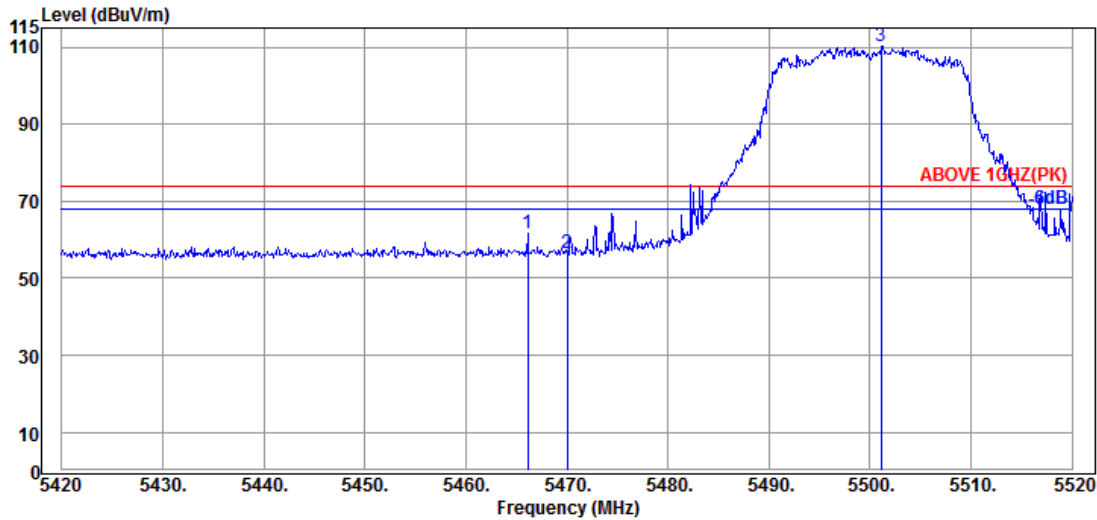

Antenna at Vertical Polarization

Emission Frequency (MHz)	Antenna Factor (dB/m)	Cable Loss (dB)	Preamp Gain (dB)	Read Level (dBμV)	Emission Level (dBμV/m)	Limits (dBμV/m)	Margin (dB)	Detector
5466.100	34.63	9.06	34.21	52.18	61.66	74.00	12.34	Peak
5470.000	34.63	9.06	34.21	47.19	56.67	74.00	17.33	Peak
@ 5501.100	34.70	9.08	34.20	100.73	110.31	---	---	Peak

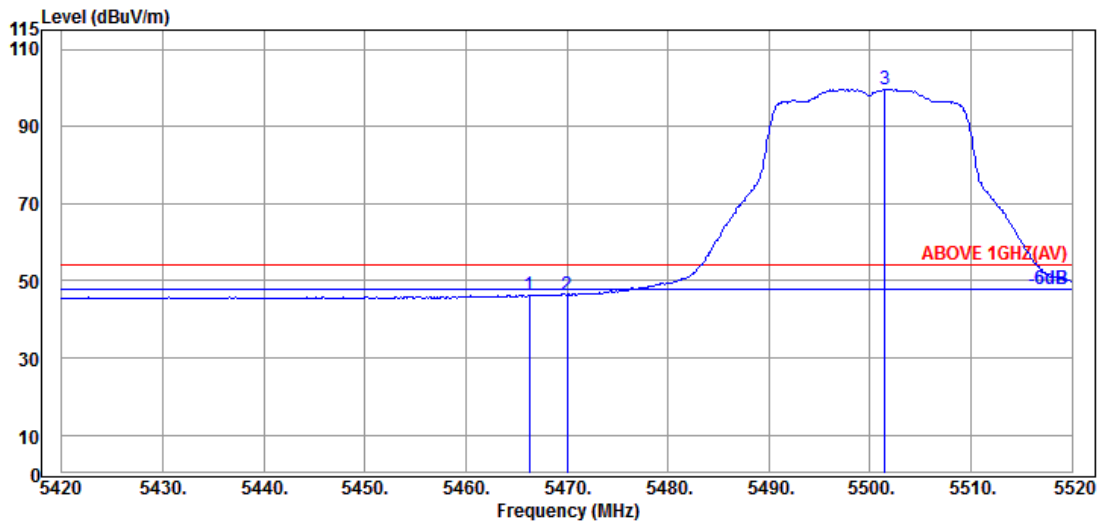

Antenna at Vertical Polarization

Emission Frequency (MHz)	Antenna Factor (dB/m)	Cable Loss (dB)	Preamp Gain (dB)	Read Level (dBμV)	Emission Level (dBμV/m)	Limits (dBμV/m)	Margin (dB)	Detector
5466.300	34.63	9.06	34.21	36.95	46.43	54.00	7.57	Average
5470.000	34.63	9.06	34.21	36.86	46.34	54.00	7.66	Average
@ 5501.500	34.70	9.08	34.20	90.16	99.74	---	---	Average

Remark: The “@” means fundamental frequency, it is ignored in this section.

Mode	802.11ax-HE20	U-NII Band	2C
		Frequency	TX 5700MHz

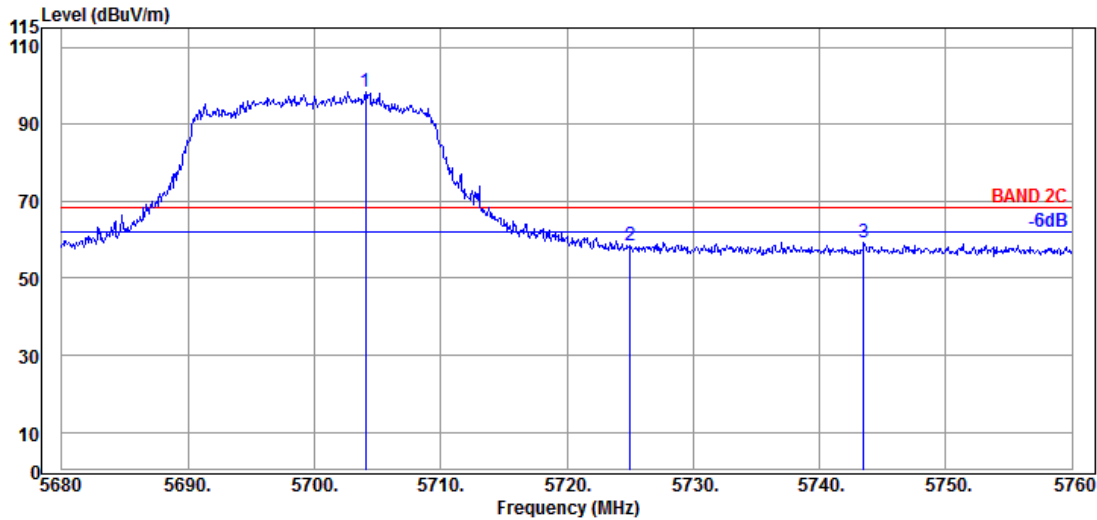

Antenna at Horizontal Polarization

Emission Frequency (MHz)	Antenna Factor (dB/m)	Cable Loss (dB)	Preamp Gain (dB)	Read Level (dBμV)	Emission Level (dBμV/m)	Limits (dBμV/m)	Margin (dB)	Detector
@ 5704.080	34.70	9.18	34.29	88.82	98.41	---	---	Peak
5725.040	34.90	9.20	34.30	48.71	58.51	68.20	9.69	Peak
5743.520	35.00	9.20	34.31	49.49	59.38	68.20	8.82	Peak

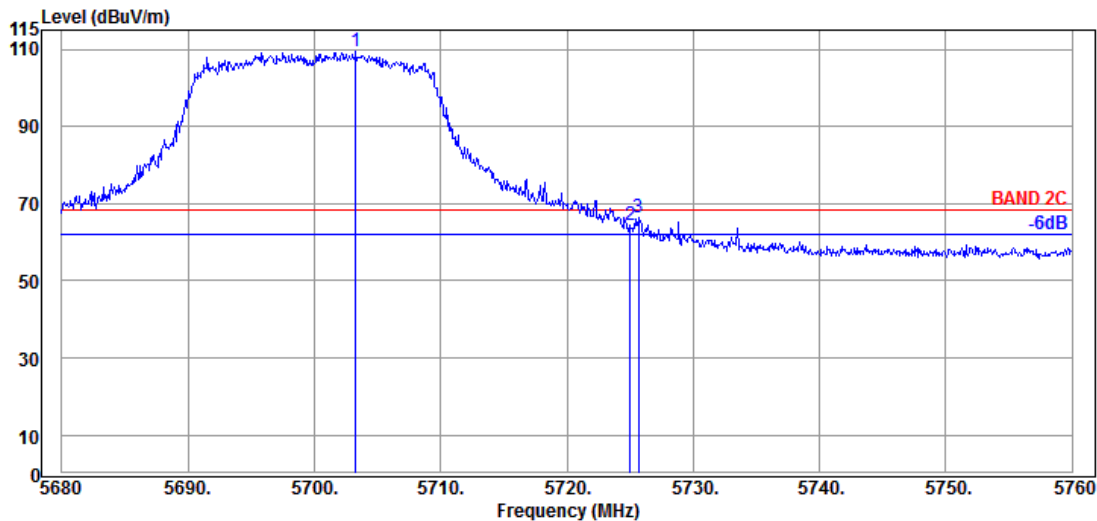

Antenna at Vertical Polarization

Emission Frequency (MHz)	Antenna Factor (dB/m)	Cable Loss (dB)	Preamp Gain (dB)	Read Level (dBμV)	Emission Level (dBμV/m)	Limits (dBμV/m)	Margin (dB)	Detector
@ 5703.280	34.70	9.18	34.29	99.76	109.35	---	---	Peak
5725.040	34.90	9.20	34.30	54.74	64.54	68.20	3.66	Peak
5725.680	34.90	9.20	34.30	56.70	66.50	68.20	1.70	Peak

Remark: The “@” means fundamental frequency, it is ignored in this section.

Mode	802.11ax-HE20	U-NII Band	2C
		Frequency	TX 5720MHz

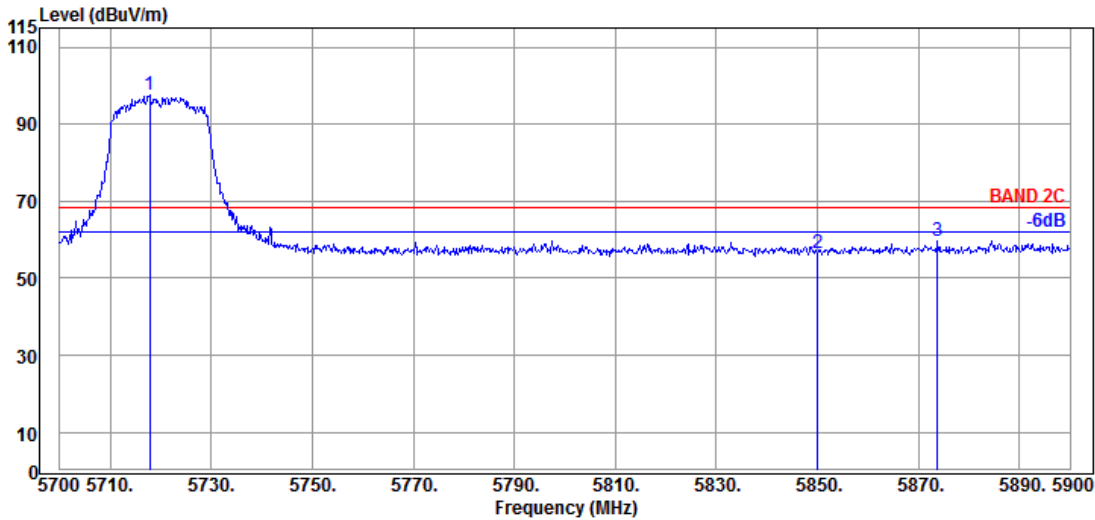

Antenna at Horizontal Polarization

Emission Frequency (MHz)	Antenna Factor (dB/m)	Cable Loss (dB)	Preamp Gain (dB)	Read Level (dBμV)	Emission Level (dBμV/m)	Limits (dBμV/m)	Margin (dB)	Detector
@ 5717.800	34.80	9.19	34.30	88.00	97.69	---	---	Peak
5850.000	35.40	9.25	34.36	46.42	56.71	68.20	11.49	Peak
5873.800	35.67	9.27	34.37	48.95	59.52	68.20	8.68	Peak

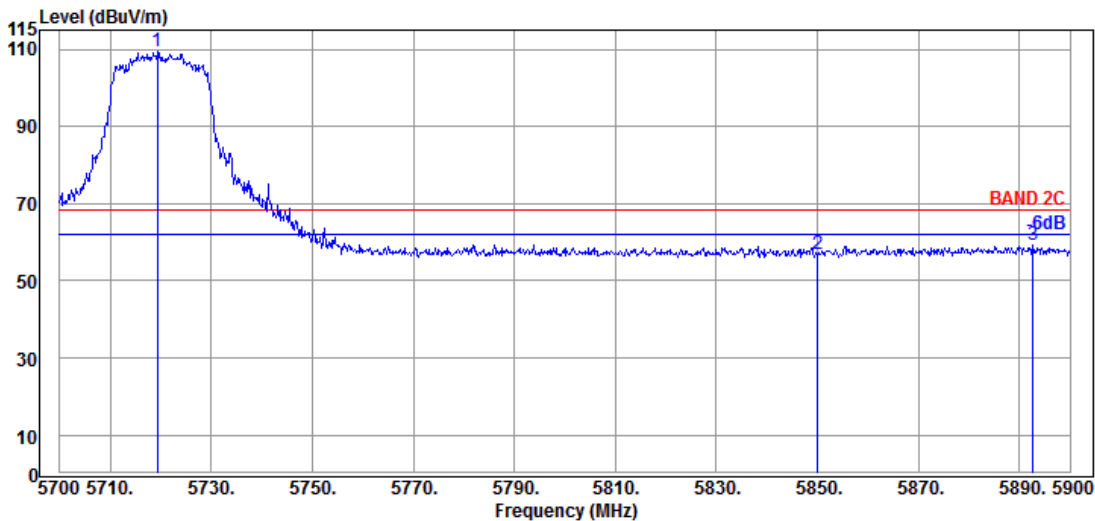

Antenna at Vertical Polarization

Emission Frequency (MHz)	Antenna Factor (dB/m)	Cable Loss (dB)	Preamp Gain (dB)	Read Level (dBμV)	Emission Level (dBμV/m)	Limits (dBμV/m)	Margin (dB)	Detector
@ 5719.400	34.80	9.19	34.30	99.68	109.37	---	---	Peak
5850.000	35.40	9.25	34.36	46.78	57.07	68.20	11.13	Peak
5892.600	35.80	9.28	34.38	48.49	59.19	68.20	9.01	Peak

Remark: The “@” means fundamental frequency, it is ignored in this section.

Mode	802.11ax-HE20	U-NII Band	2C
		Frequency	TX 5720MHz

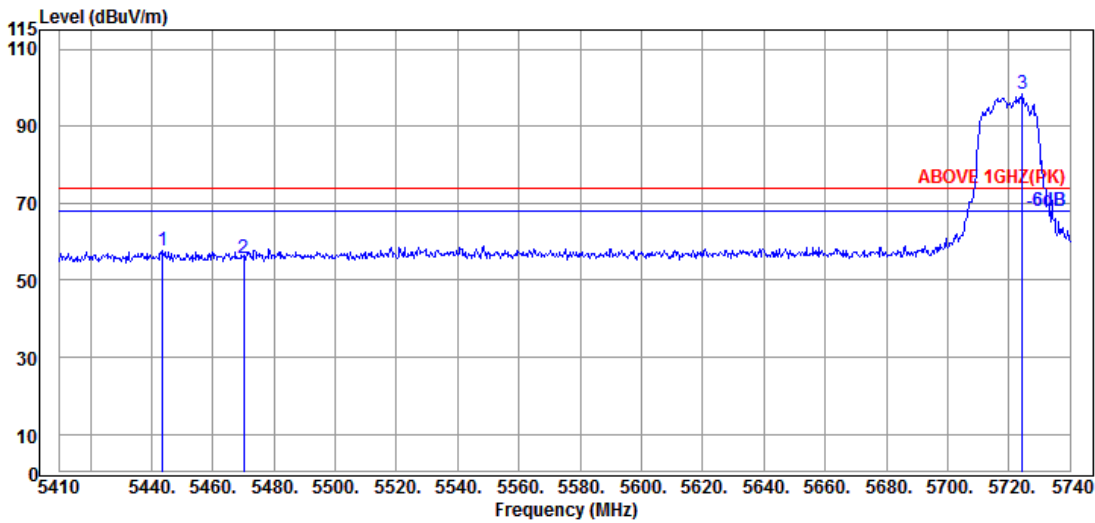

Antenna at Horizontal Polarization

Emission Frequency (MHz)	Antenna Factor (dB/m)	Cable Loss (dB)	Preamplifier Gain (dB)	Read Level (dBμV)	Emission Level (dBμV/m)	Limits (dBμV/m)	Margin (dB)	Detector
5443.660	34.65	9.04	34.22	48.10	57.57	74.00	16.43	Peak
5470.060	34.63	9.06	34.21	46.33	55.81	74.00	18.19	Peak
@ 5724.490	34.90	9.20	34.30	88.44	98.24	---	---	Peak

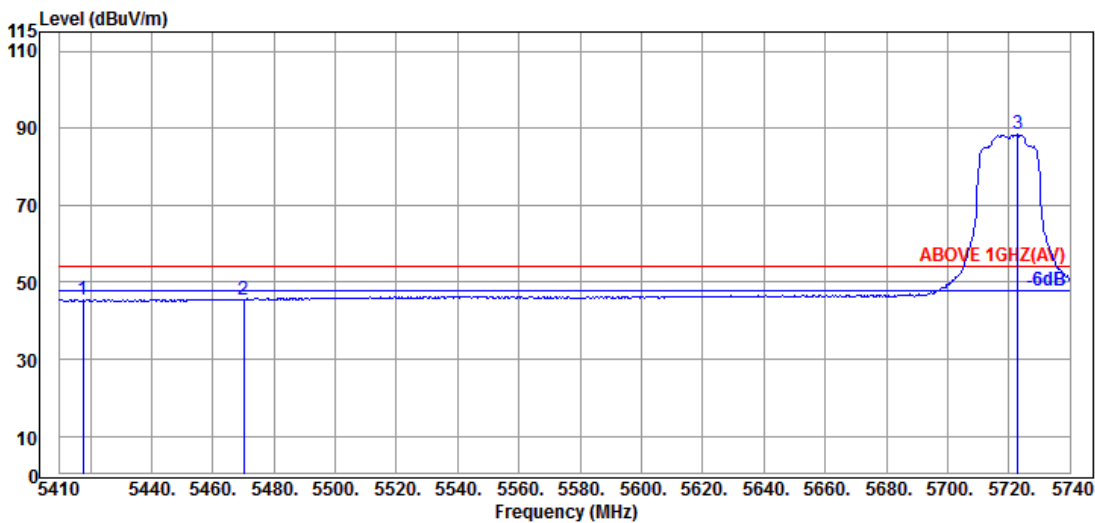

Antenna at Horizontal Polarization

Emission Frequency (MHz)	Antenna Factor (dB/m)	Cable Loss (dB)	Preamplifier Gain (dB)	Read Level (dBμV)	Emission Level (dBμV/m)	Limits (dBμV/m)	Margin (dB)	Detector
5417.590	34.70	9.04	34.23	36.12	45.63	54.00	8.37	Average
5470.060	34.63	9.06	34.21	36.04	45.52	54.00	8.48	Average
@ 5722.840	34.90	9.20	34.30	78.56	88.36	---	---	Average

Remark: The “@” means fundamental frequency, it is ignored in this section.

Mode	802.11ax-HE20	U-NII Band	2C
		Frequency	TX 5720MHz

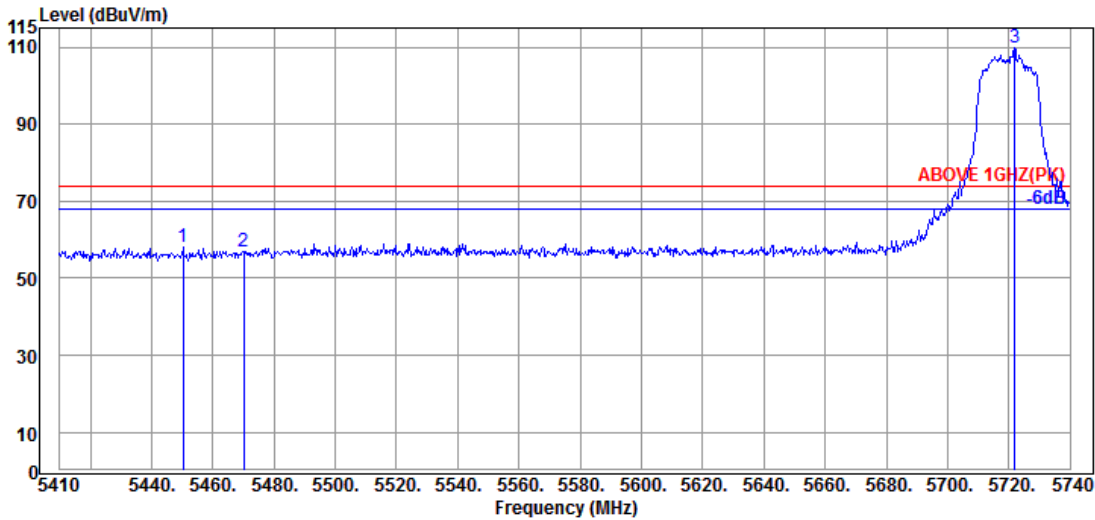

Antenna at Vertical Polarization

Emission Frequency (MHz)	Antenna Factor (dB/m)	Cable Loss (dB)	Preamp Gain (dB)	Read Level (dBμV)	Emission Level (dBμV/m)	Limits (dBμV/m)	Margin (dB)	Detector
5450.260	34.60	9.05	34.22	48.71	58.14	74.00	15.86	Peak
5470.060	34.63	9.06	34.21	47.62	57.10	74.00	16.90	Peak
@ 5721.850	34.80	9.19	34.30	100.19	109.88	---	---	Peak

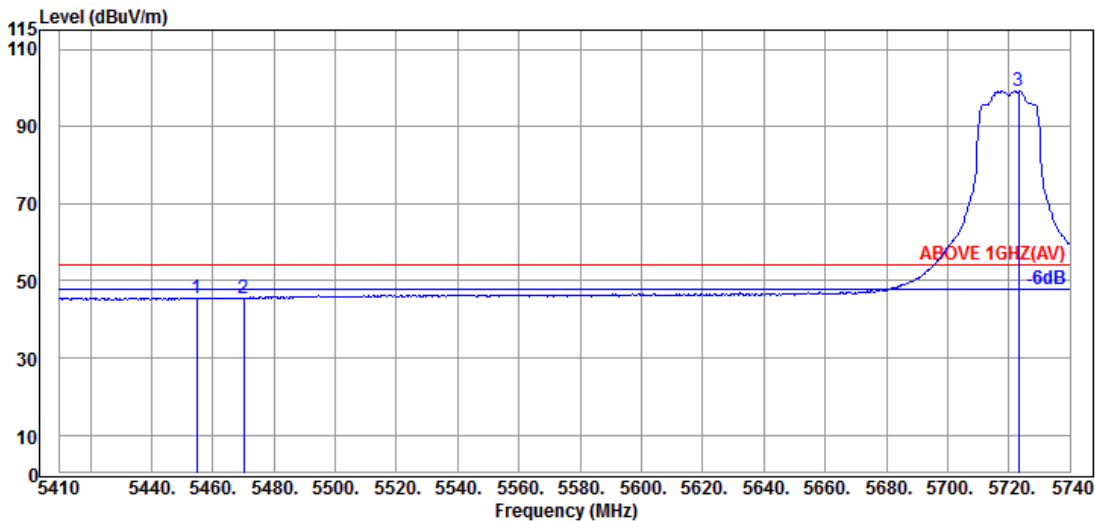

Antenna at Vertical Polarization

Emission Frequency (MHz)	Antenna Factor (dB/m)	Cable Loss (dB)	Preamp Gain (dB)	Read Level (dBμV)	Emission Level (dBμV/m)	Limits (dBμV/m)	Margin (dB)	Detector
5454.880	34.60	9.05	34.21	36.20	45.64	54.00	8.36	Average
5470.060	34.63	9.06	34.21	36.03	45.51	54.00	8.49	Average
@ 5723.170	34.90	9.20	34.30	89.28	99.08	---	---	Average

Remark: The “@” means fundamental frequency, it is ignored in this section.

Mode	802.11ac-HE20	U-NII Band	3
		Frequency	TX 5745MHz

Antenna at Horizontal Polarization

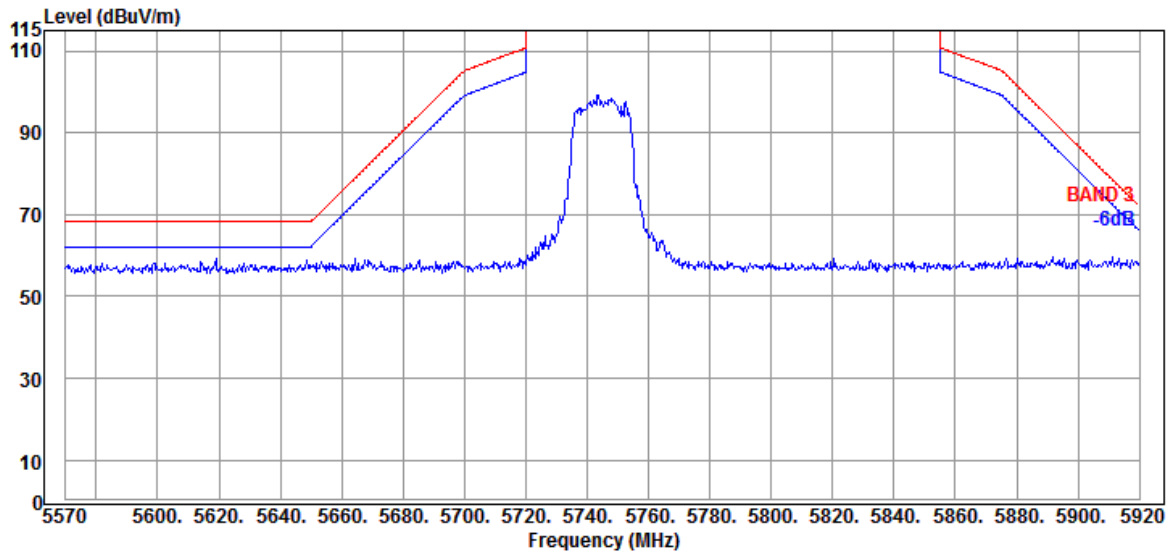

Antenna at Vertical Polarization

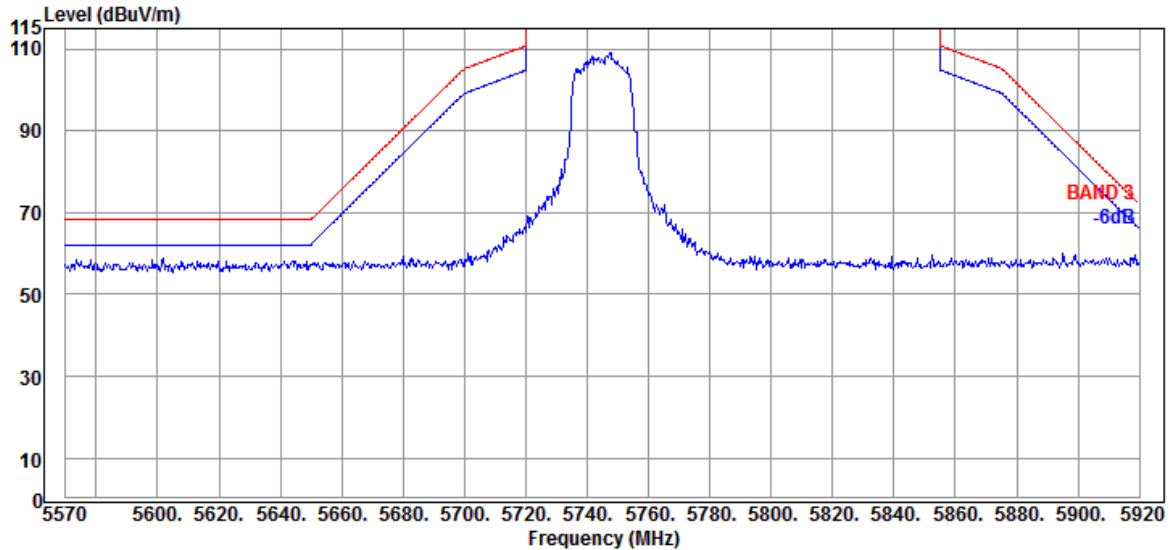

Mode	802.11ac-HE20	U-NII Band	3
		Frequency	TX 5825MHz

Antenna at Horizontal Polarization

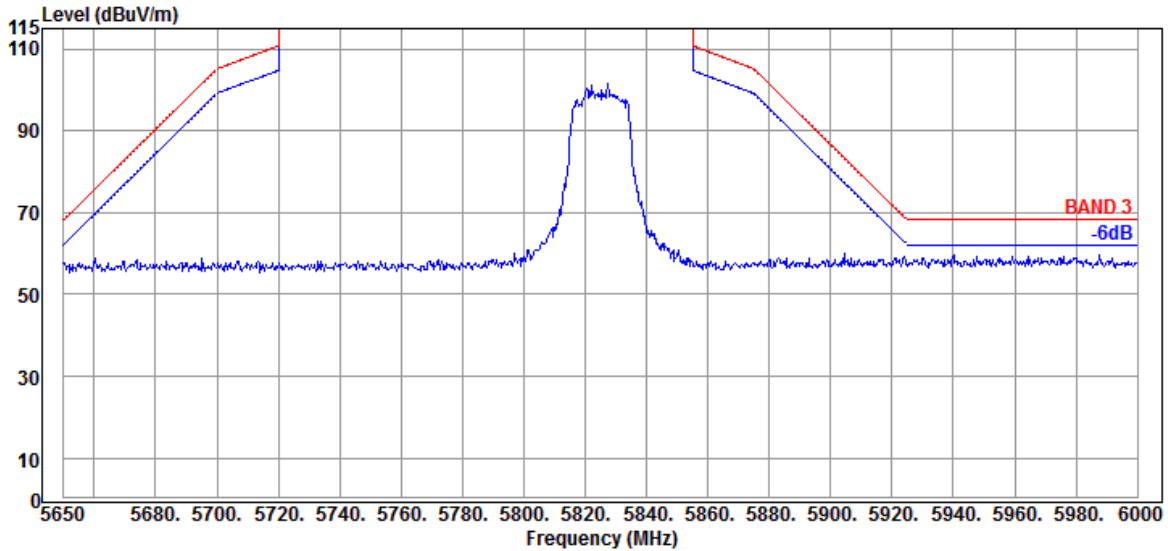

Antenna at Vertical Polarization

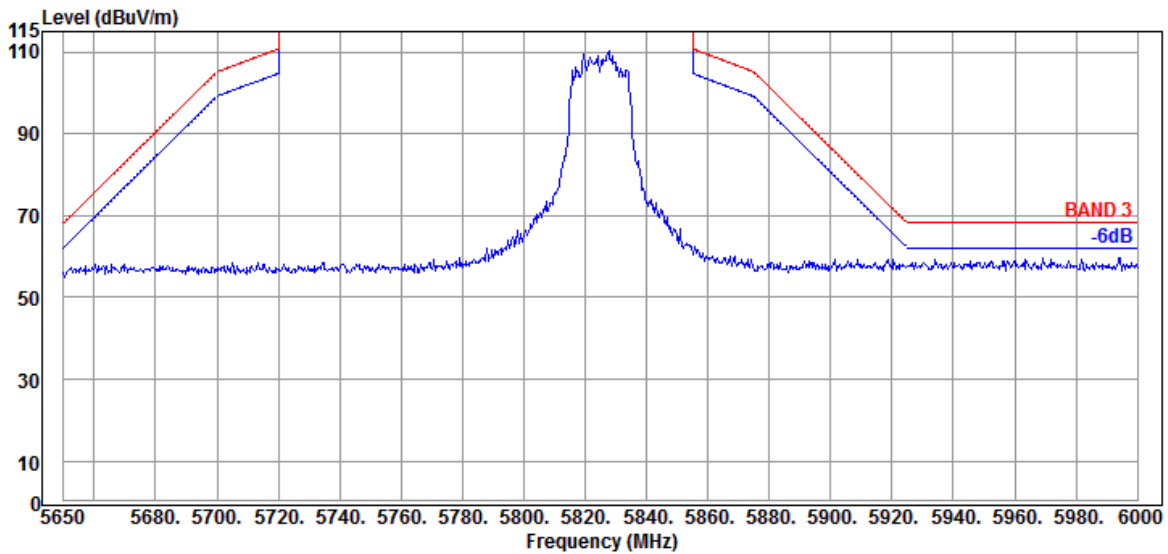

Mode	802.11ax-HE40	U-NII Band	1
		Frequency	TX 5190MHz

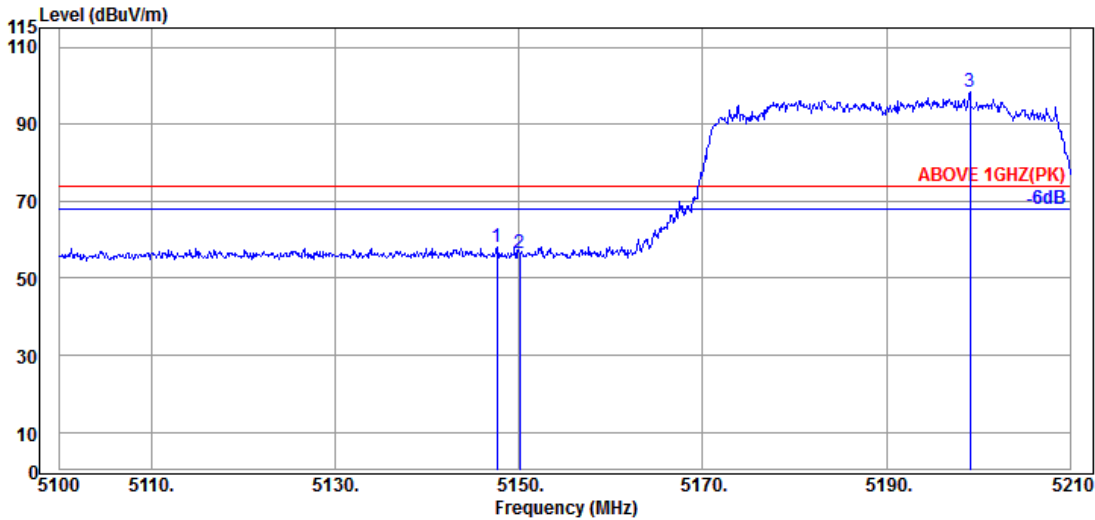

Antenna at Horizontal Polarization

Emission Frequency (MHz)	Antenna Factor (dB/m)	Cable Loss (dB)	Preamp Gain (dB)	Read Level (dBμV)	Emission Level (dBμV/m)	Limits (dBμV/m)	Margin (dB)	Detector
5147.630	34.50	8.88	34.34	49.13	58.17	74.00	15.83	Peak
5150.050	34.50	8.88	34.34	47.63	56.67	74.00	17.33	Peak
@ 5199.110	34.70	8.91	34.32	89.03	98.32	---	---	Peak

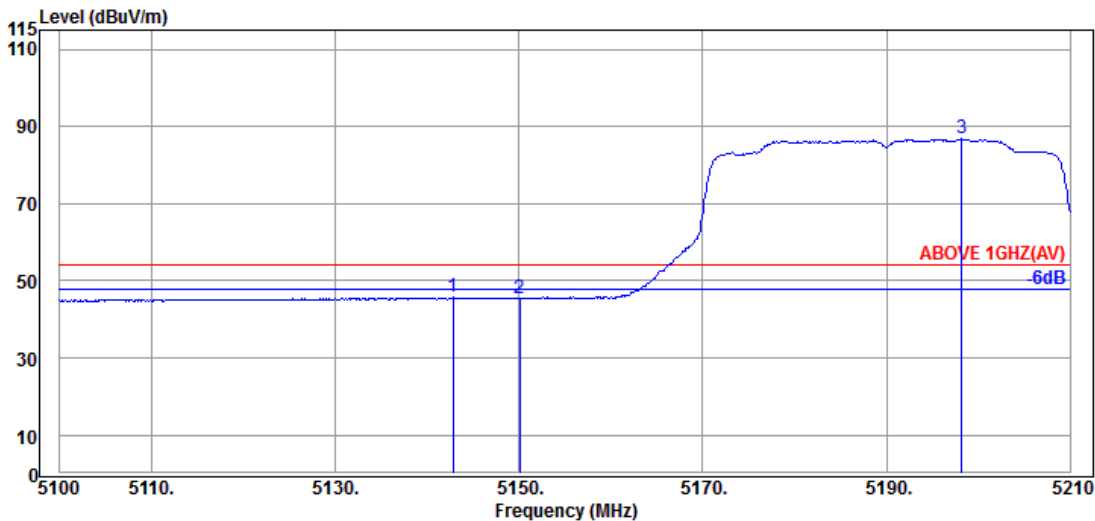

Antenna at Horizontal Polarization

Emission Frequency (MHz)	Antenna Factor (dB/m)	Cable Loss (dB)	Preamp Gain (dB)	Read Level (dBμV)	Emission Level (dBμV/m)	Limits (dBμV/m)	Margin (dB)	Detector
5142.790	34.50	8.88	34.34	36.64	45.68	54.00	8.32	Average
5150.050	34.50	8.88	34.34	36.52	45.56	54.00	8.44	Average
@ 5198.230	34.70	8.91	34.32	77.46	86.75	---	---	Average

Remark: The “@” means fundamental frequency, it is ignored in this section.

Mode	802.11ax-HE40	U-NII Band	1
		Frequency	TX 5190MHz

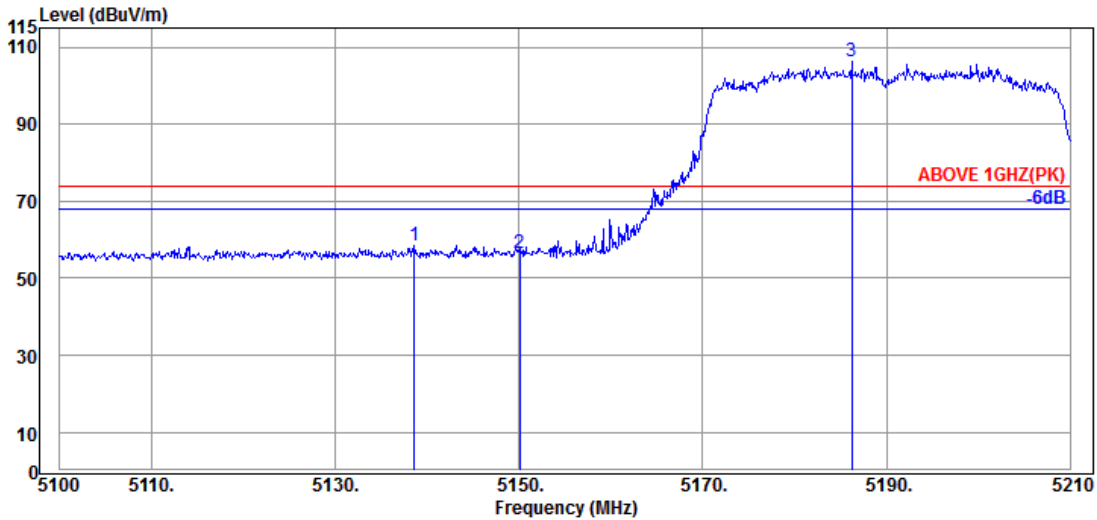

Antenna at Vertical Polarization

Emission Frequency (MHz)	Antenna Factor (dB/m)	Cable Loss (dB)	Preamp Gain (dB)	Read Level (dBμV)	Emission Level (dBμV/m)	Limits (dBμV/m)	Margin (dB)	Detector
5138.610	34.40	8.88	34.34	49.60	58.54	74.00	15.46	Peak
5150.050	34.50	8.88	34.34	47.53	56.57	74.00	17.43	Peak
@ 5186.240	34.63	8.90	34.32	96.92	106.13	---	---	Peak

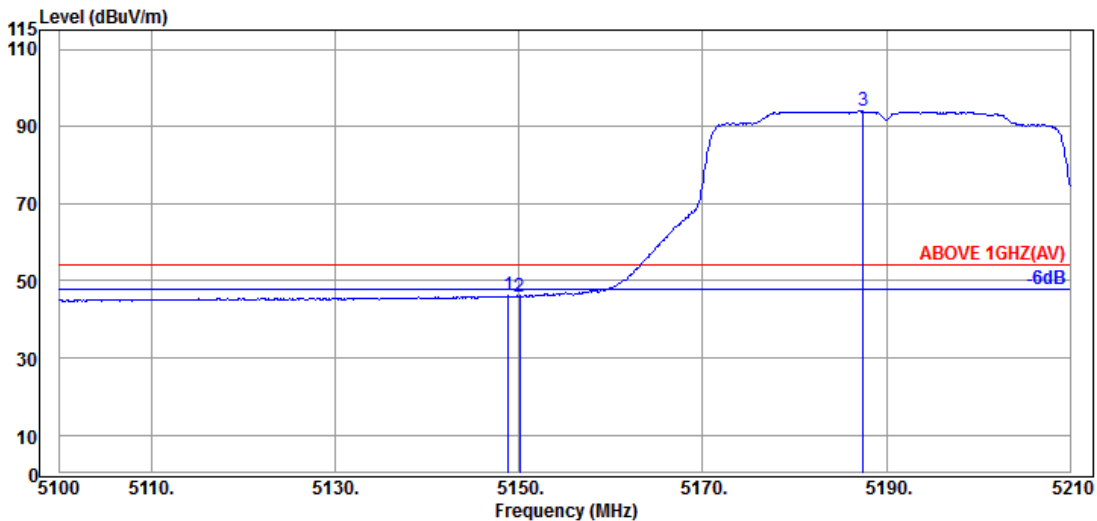

Antenna at Vertical Polarization

Emission Frequency (MHz)	Antenna Factor (dB/m)	Cable Loss (dB)	Preamp Gain (dB)	Read Level (dBμV)	Emission Level (dBμV/m)	Limits (dBμV/m)	Margin (dB)	Detector
5148.840	34.50	8.88	34.34	37.12	46.16	54.00	7.84	Average
5150.050	34.50	8.88	34.34	36.90	45.94	54.00	8.06	Average
@ 5187.450	34.70	8.91	34.32	84.68	93.97	---	---	Average

Remark: The “@” means fundamental frequency, it is ignored in this section.

Mode	802.11ax-HE40	U-NII Band	2A
		Frequency	TX 5310MHz

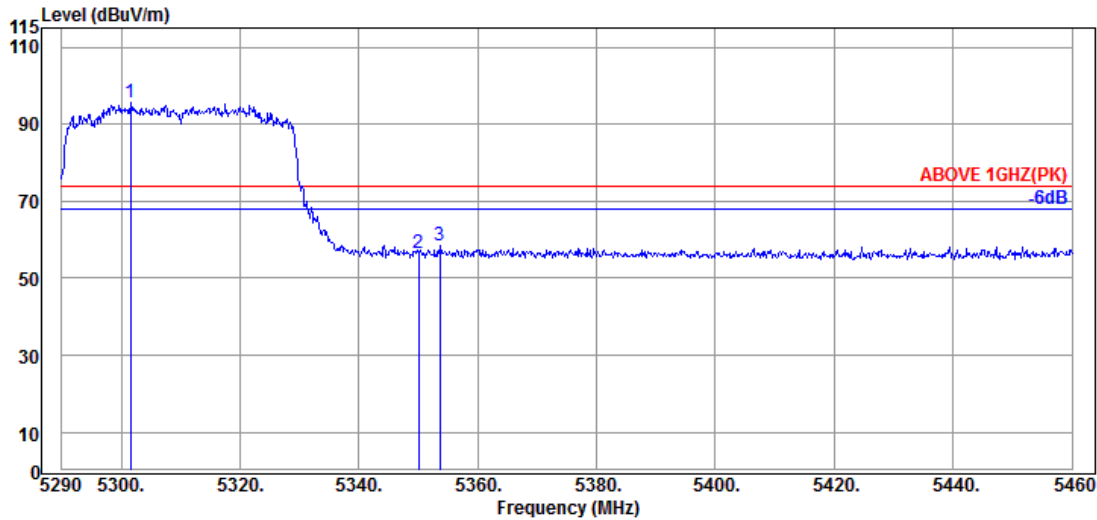

Antenna at Horizontal Polarization

Emission Frequency (MHz)	Antenna Factor (dB/m)	Cable Loss (dB)	Preamp Gain (dB)	Read Level (dBμV)	Emission Level (dBUV/m)	Limits (dBUV/m)	Margin (dB)	Detector
@ 5301.560	34.40	8.97	34.28	86.42	95.51	---	---	Peak
5350.010	34.90	8.99	34.26	46.89	56.52	74.00	17.48	Peak
5353.580	34.90	8.99	34.26	48.72	58.35	74.00	15.65	Peak

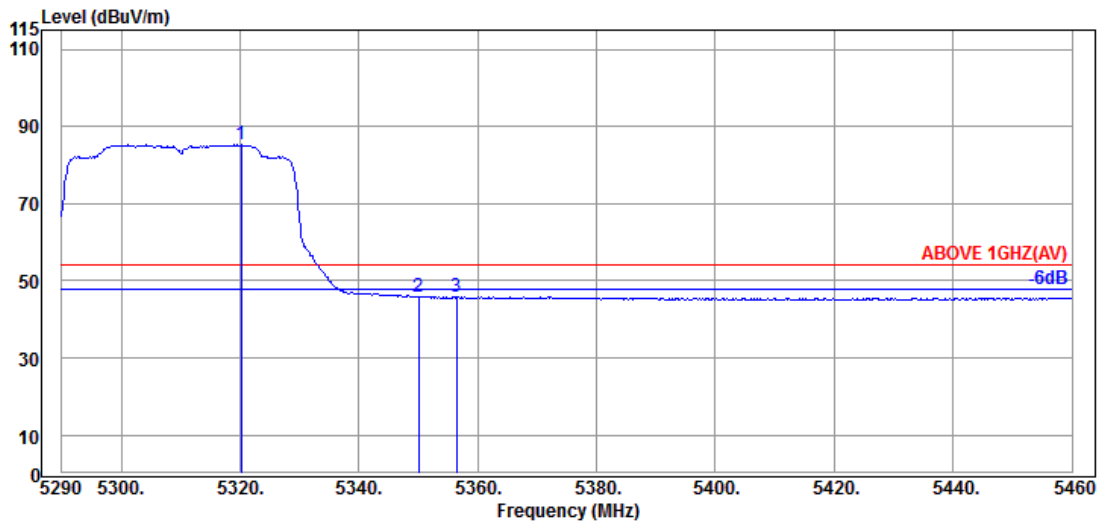

Antenna at Horizontal Polarization

Emission Frequency (MHz)	Antenna Factor (dB/m)	Cable Loss (dB)	Preamp Gain (dB)	Read Level (dBμV)	Emission Level (dBUV/m)	Limits (dBUV/m)	Margin (dB)	Detector
@ 5320.260	34.57	8.98	34.27	75.98	85.26	---	---	Average
5350.010	34.90	8.99	34.26	36.18	45.81	54.00	8.19	Average
5356.470	34.87	9.00	34.26	36.28	45.89	54.00	8.11	Average

Remark: The “@” means fundamental frequency, it is ignored in this section.

Mode	802.11ax-HE40	U-NII Band	2A
		Frequency	TX 5310MHz

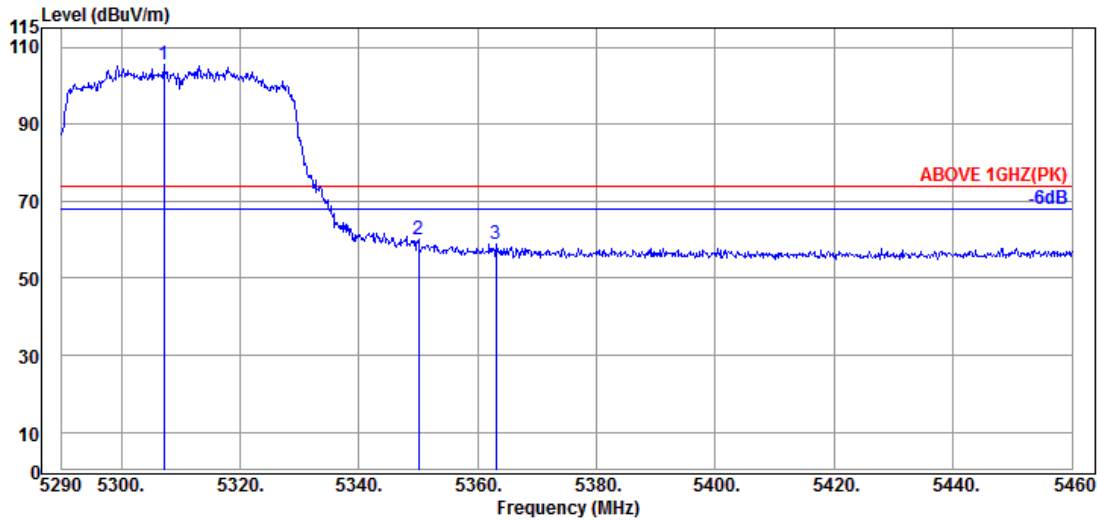

Antenna at Vertical Polarization

Emission Frequency (MHz)	Antenna Factor (dB/m)	Cable Loss (dB)	Preamp Gain (dB)	Read Level (dBμV)	Emission Level (dBμV/m)	Limits (dBμV/m)	Margin (dB)	Detector
@ 5307.170	34.40	8.97	34.28	96.32	105.41	---	---	Peak
5350.010	34.90	8.99	34.26	50.24	59.87	74.00	14.13	Peak
5363.100	34.87	9.00	34.25	49.32	58.94	74.00	15.06	Peak

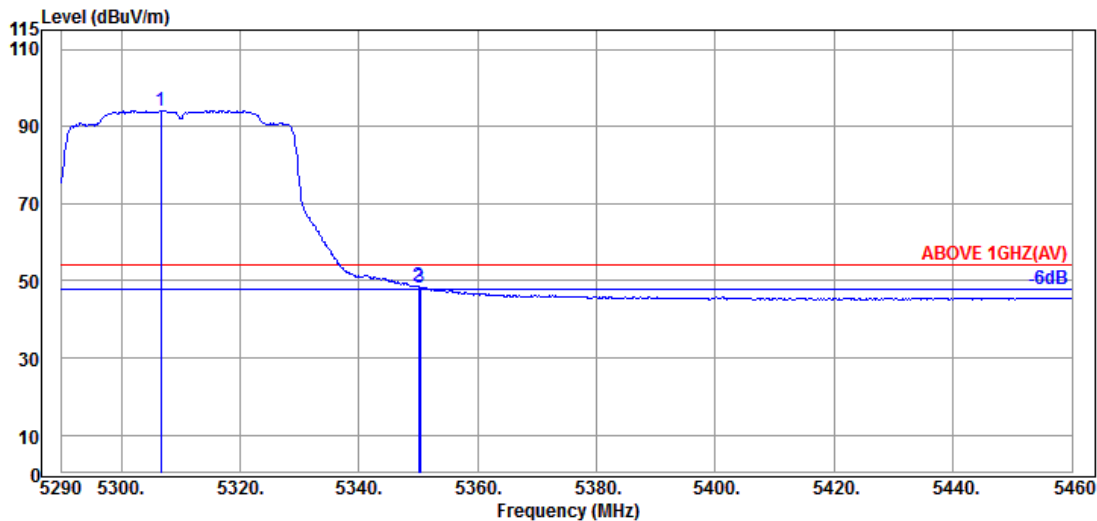

Antenna at Vertical Polarization

Emission Frequency (MHz)	Antenna Factor (dB/m)	Cable Loss (dB)	Preamp Gain (dB)	Read Level (dBμV)	Emission Level (dBμV/m)	Limits (dBμV/m)	Margin (dB)	Detector
@ 5306.660	34.40	8.97	34.28	85.11	94.20	---	---	Average
5350.010	34.90	8.99	34.26	38.92	48.55	54.00	5.45	Average
5350.350	34.90	8.99	34.26	38.63	48.26	54.00	5.74	Average

Remark: The “@” means fundamental frequency, it is ignored in this section.

Mode	802.11ax-HE40	U-NII Band	2C
		Frequency	TX 5510MHz

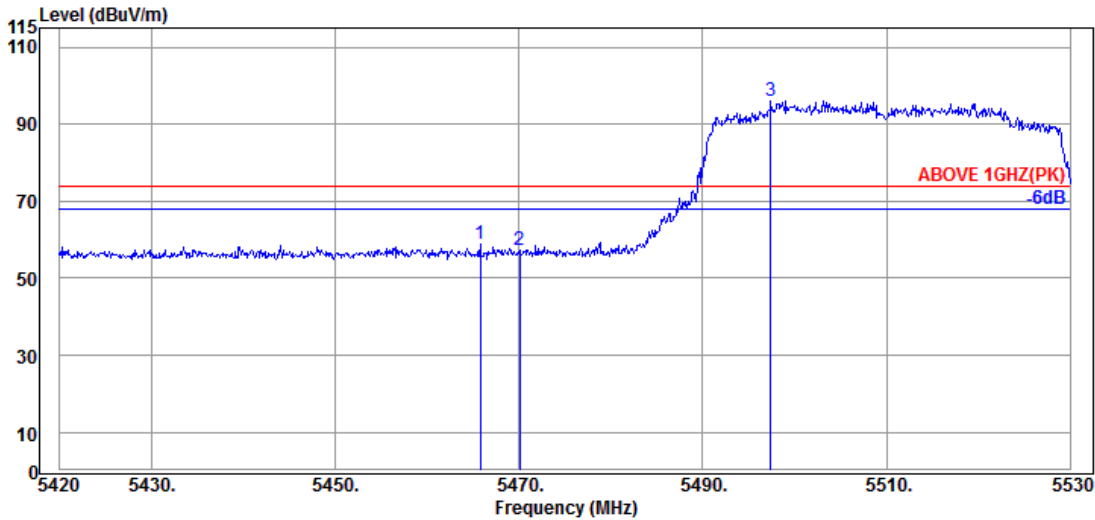

Antenna at Horizontal Polarization

Emission Frequency (MHz)	Antenna Factor (dB/m)	Cable Loss (dB)	Preamp Gain (dB)	Read Level (dBμV)	Emission Level (dBμV/m)	Limits (dBμV/m)	Margin (dB)	Detector
5465.760	34.63	9.06	34.21	49.39	58.87	74.00	15.13	Peak
5470.050	34.63	9.06	34.21	47.98	57.46	74.00	16.54	Peak
@ 5497.440	34.70	9.08	34.20	86.38	95.96	---	---	Peak

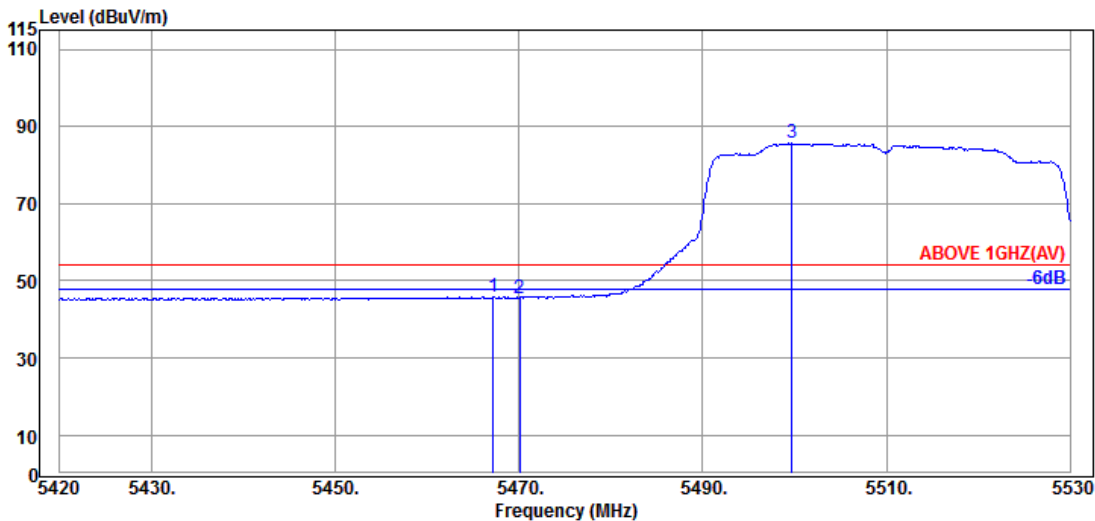

Antenna at Horizontal Polarization

Emission Frequency (MHz)	Antenna Factor (dB/m)	Cable Loss (dB)	Preamp Gain (dB)	Read Level (dBμV)	Emission Level (dBμV/m)	Limits (dBμV/m)	Margin (dB)	Detector
5467.190	34.63	9.06	34.21	36.31	45.79	54.00	8.21	Average
5470.050	34.63	9.06	34.21	36.08	45.56	54.00	8.44	Average
@ 5499.750	34.70	9.08	34.20	76.04	85.62	---	---	Average

Remark: The “@” means fundamental frequency, it is ignored in this section.

Mode	802.11ax-HE40	U-NII Band	2C
		Frequency	TX 5510MHz

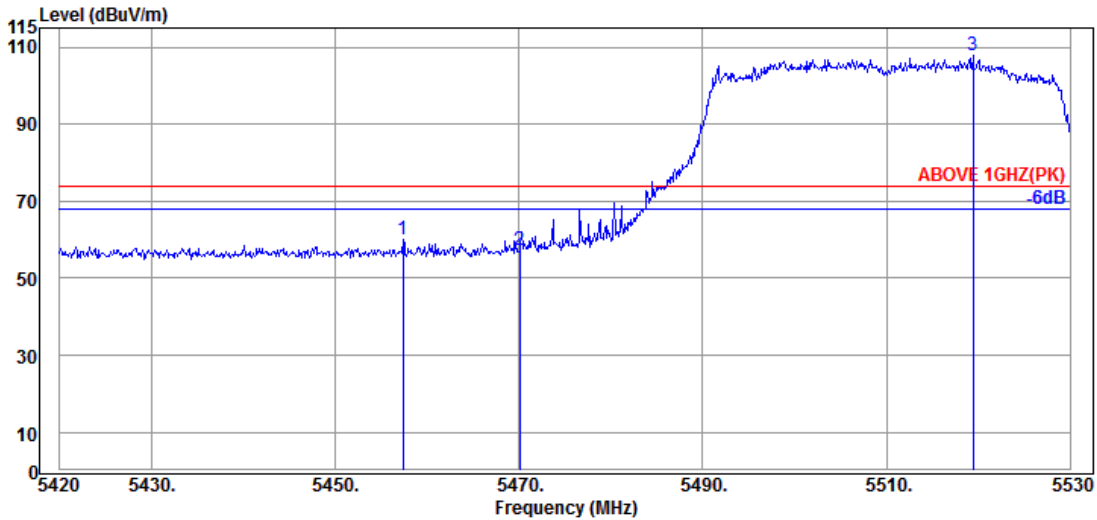

Antenna at Vertical Polarization

Emission Frequency (MHz)	Antenna Factor (dB/m)	Cable Loss (dB)	Preamp Gain (dB)	Read Level (dBμV)	Emission Level (dBμV/m)	Limits (dBμV/m)	Margin (dB)	Detector
5457.400	34.60	9.05	34.21	50.60	60.04	74.00	13.96	Peak
5470.050	34.63	9.06	34.21	47.80	57.28	74.00	16.72	Peak
@ 5519.440	34.70	9.09	34.21	98.15	107.73	---	---	Peak

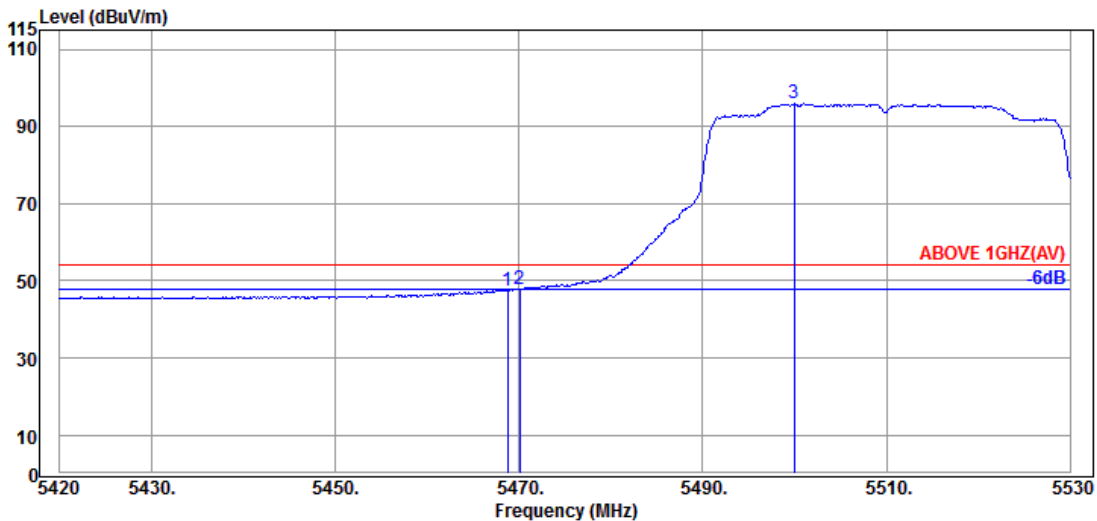

Antenna at Vertical Polarization

Emission Frequency (MHz)	Antenna Factor (dB/m)	Cable Loss (dB)	Preamp Gain (dB)	Read Level (dBμV)	Emission Level (dBμV/m)	Limits (dBμV/m)	Margin (dB)	Detector
5468.730	34.63	9.06	34.21	38.10	47.58	54.00	6.42	Average
5470.050	34.63	9.06	34.21	38.43	47.91	54.00	6.09	Average
@ 5499.970	34.70	9.08	34.20	86.31	95.89	---	---	Average

Remark: The “@” means fundamental frequency, it is ignored in this section.

Mode	802.11ax-HE40	U-NII Band	2C
		Frequency	TX 5670MHz

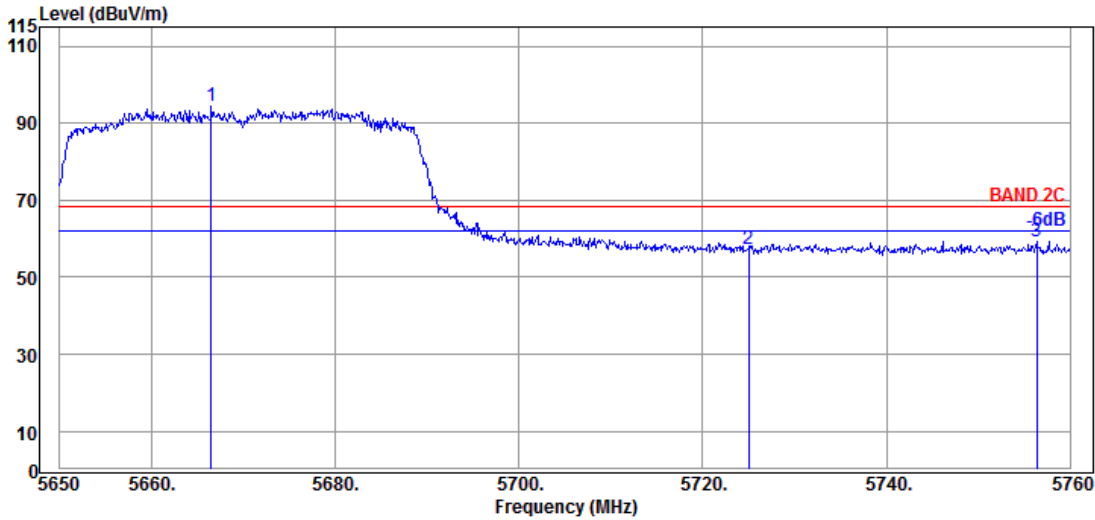

Antenna at Horizontal Polarization

Emission Frequency (MHz)	Antenna Factor (dB/m)	Cable Loss (dB)	Preamp Gain (dB)	Read Level (dBμV)	Emission Level (dBμV/m)	Limits (dBμV/m)	Margin (dB)	Detector
@ 5666.500	34.57	9.16	34.28	84.90	94.35	---	---	Peak
5725.020	34.90	9.20	34.30	47.36	57.16	68.20	11.04	Peak
5756.370	35.03	9.21	34.32	49.39	59.31	68.20	8.89	Peak

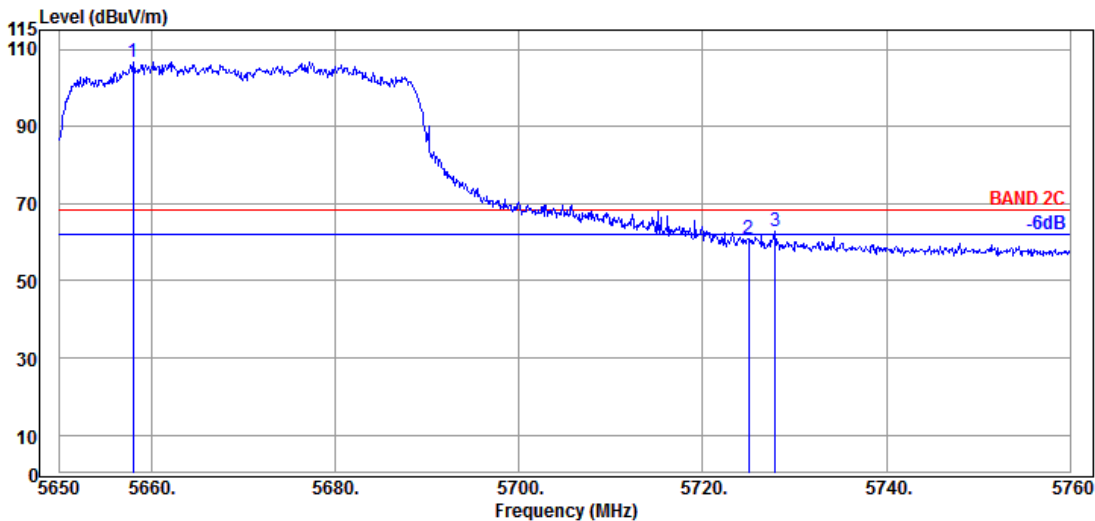

Antenna at Vertical Polarization

Emission Frequency (MHz)	Antenna Factor (dB/m)	Cable Loss (dB)	Preamp Gain (dB)	Read Level (dBμV)	Emission Level (dBμV/m)	Limits (dBμV/m)	Margin (dB)	Detector
@ 5658.030	34.57	9.16	34.28	97.29	106.74	---	---	Peak
5725.020	34.90	9.20	34.30	51.06	60.86	68.20	7.34	Peak
5727.880	34.90	9.20	34.31	53.06	62.85	68.20	5.35	Peak

Remark: The “@” means fundamental frequency, it is ignored in this section.

Mode	802.11ax-HE40	U-NII Band	2C
		Frequency	TX 5710MHz

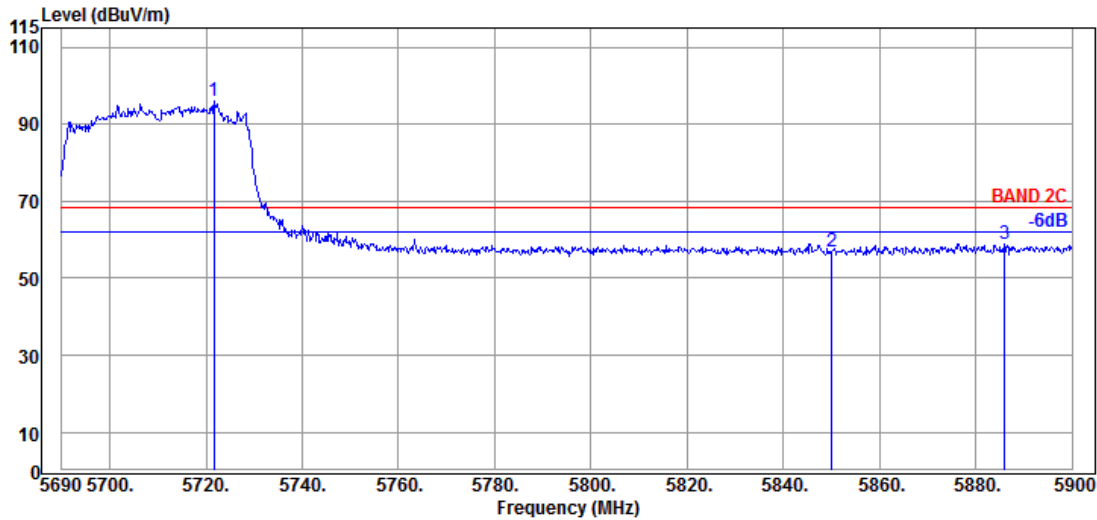

Antenna at Horizontal Polarization

Emission Frequency (MHz)	Antenna Factor (dB/m)	Cable Loss (dB)	Preamp Gain (dB)	Read Level (dBμV)	Emission Level (dBμV/m)	Limits (dBμV/m)	Margin (dB)	Detector
@ 5721.710	34.80	9.19	34.30	86.24	95.93	---	---	Peak
5850.020	35.40	9.25	34.36	46.45	56.74	68.20	11.46	Peak
5885.930	35.67	9.27	34.38	48.23	58.79	68.20	9.41	Peak

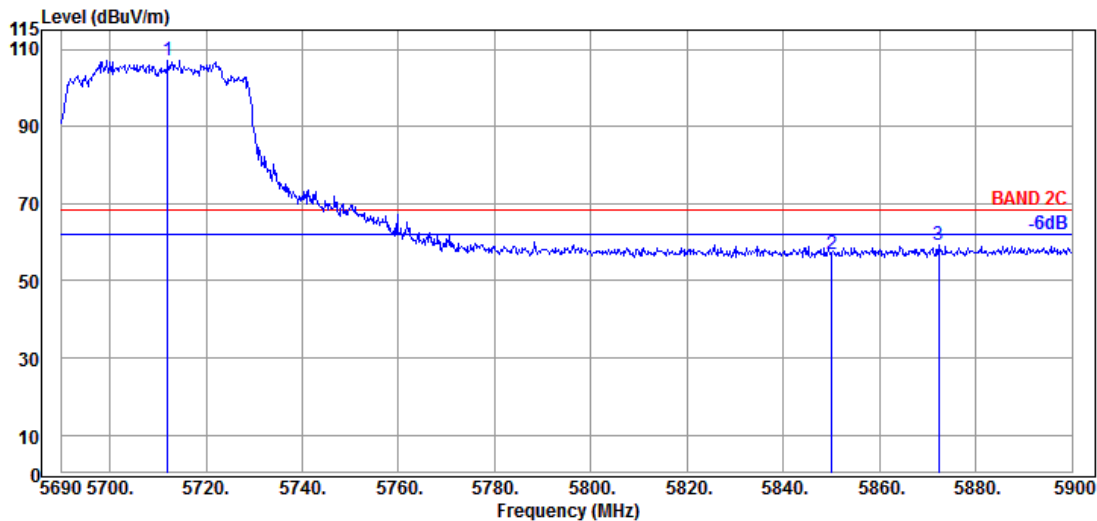

Antenna at Vertical Polarization

Emission Frequency (MHz)	Antenna Factor (dB/m)	Cable Loss (dB)	Preamp Gain (dB)	Read Level (dBμV)	Emission Level (dBμV/m)	Limits (dBμV/m)	Margin (dB)	Detector
@ 5712.050	34.80	9.19	34.30	97.33	107.02	---	---	Peak
5850.020	35.40	9.25	34.36	46.54	56.83	68.20	11.37	Peak
5872.280	35.53	9.26	34.37	48.70	59.12	68.20	9.08	Peak

Remark: The “@” means fundamental frequency, it is ignored in this section.

Mode	802.11ax-HE40	U-NII Band	2C
		Frequency	TX 5710MHz

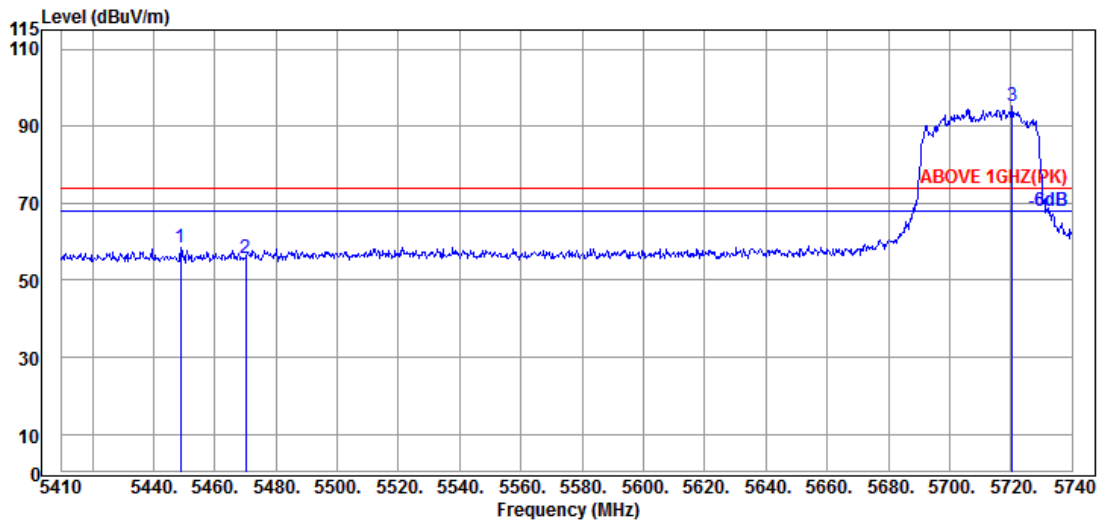

Antenna at Horizontal Polarization

Emission Frequency (MHz)	Antenna Factor (dB/m)	Cable Loss (dB)	Preamplifier Gain (dB)	Read Level (dBμV)	Emission Level (dBμV/m)	Limits (dBμV/m)	Margin (dB)	Detector
5448.940	34.60	9.05	34.22	49.13	58.56	74.00	15.44	Peak
5470.060	34.63	9.06	34.21	46.24	55.72	74.00	18.28	Peak
@ 5720.530	34.80	9.19	34.30	85.61	95.30	---	---	Peak

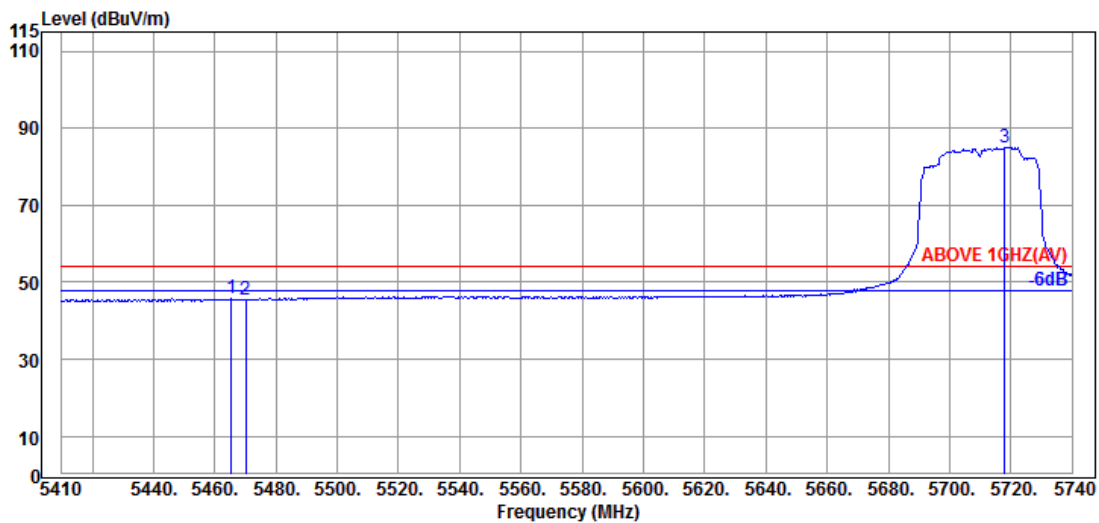

Antenna at Horizontal Polarization

Emission Frequency (MHz)	Antenna Factor (dB/m)	Cable Loss (dB)	Preamplifier Gain (dB)	Read Level (dBμV)	Emission Level (dBμV/m)	Limits (dBμV/m)	Margin (dB)	Detector
5465.440	34.63	9.06	34.21	36.21	45.69	54.00	8.31	Average
5470.060	34.63	9.06	34.21	35.92	45.40	54.00	8.60	Average
@ 5717.890	34.80	9.19	34.30	75.28	84.97	---	---	Average

Remark: The “@” means fundamental frequency, it is ignored in this section.

Mode	802.11ax-HE40	U-NII Band	2C
		Frequency	TX 5710MHz

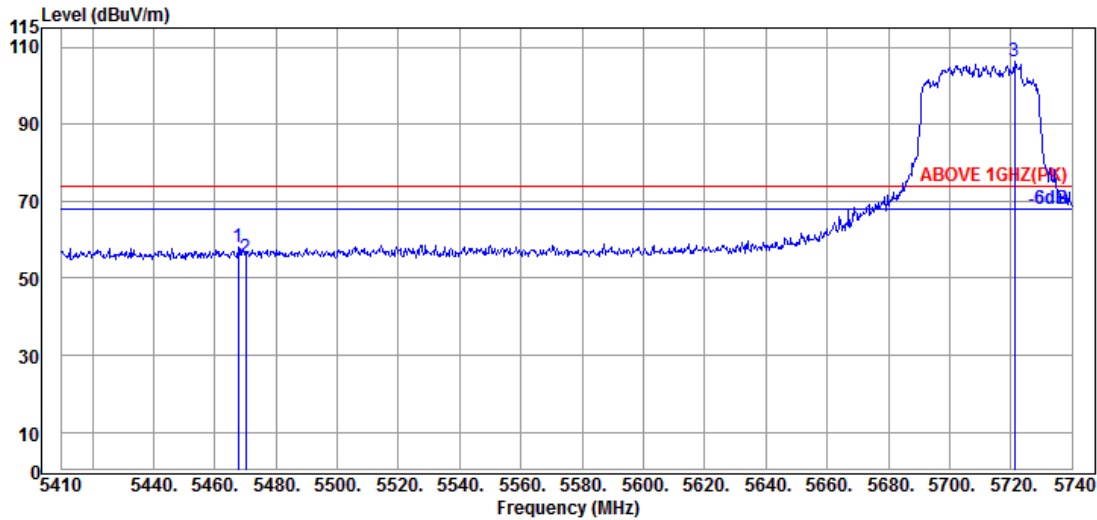

Antenna at Vertical Polarization

Emission Frequency (MHz)	Antenna Factor (dB/m)	Cable Loss (dB)	Preamp Gain (dB)	Read Level (dBμV)	Emission Level (dBμV/m)	Limits (dBμV/m)	Margin (dB)	Detector
5467.750	34.63	9.06	34.21	48.64	58.12	74.00	15.88	Peak
5470.060	34.63	9.06	34.21	45.96	55.44	74.00	18.56	Peak
@ 5721.190	34.80	9.19	34.30	96.71	106.40	---	---	Peak

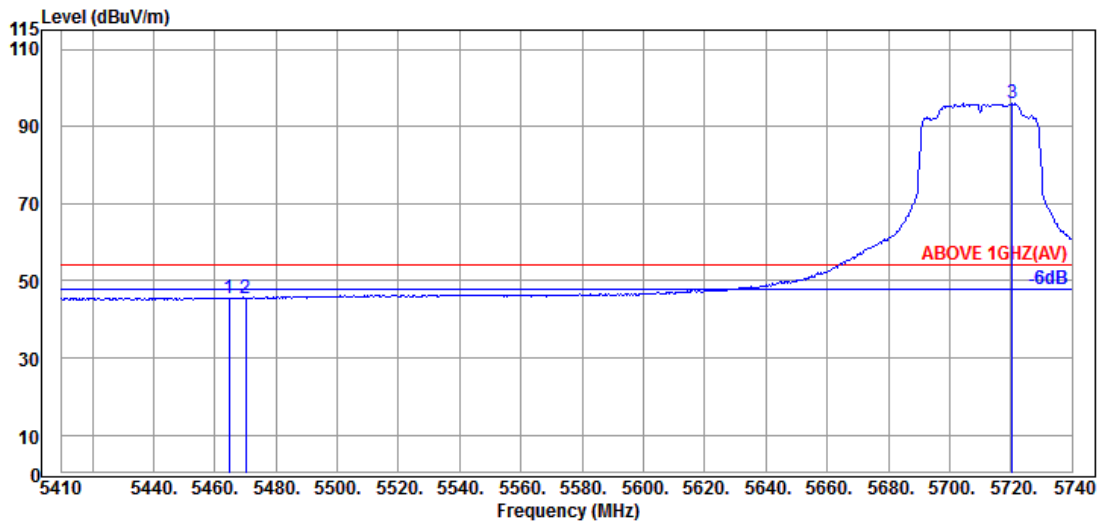

Antenna at Vertical Polarization

Emission Frequency (MHz)	Antenna Factor (dB/m)	Cable Loss (dB)	Preamp Gain (dB)	Read Level (dBμV)	Emission Level (dBμV/m)	Limits (dBμV/m)	Margin (dB)	Detector
5464.780	34.63	9.06	34.21	36.11	45.59	54.00	8.41	Average
5470.060	34.63	9.06	34.21	36.12	45.60	54.00	8.40	Average
@ 5720.530	34.80	9.19	34.30	86.39	96.08	---	---	Average

Remark: The “@” means fundamental frequency, it is ignored in this section.

Mode	802.11ax-HE40	U-NII Band	3
		Frequency	TX 5755MHz

Antenna at Horizontal Polarization

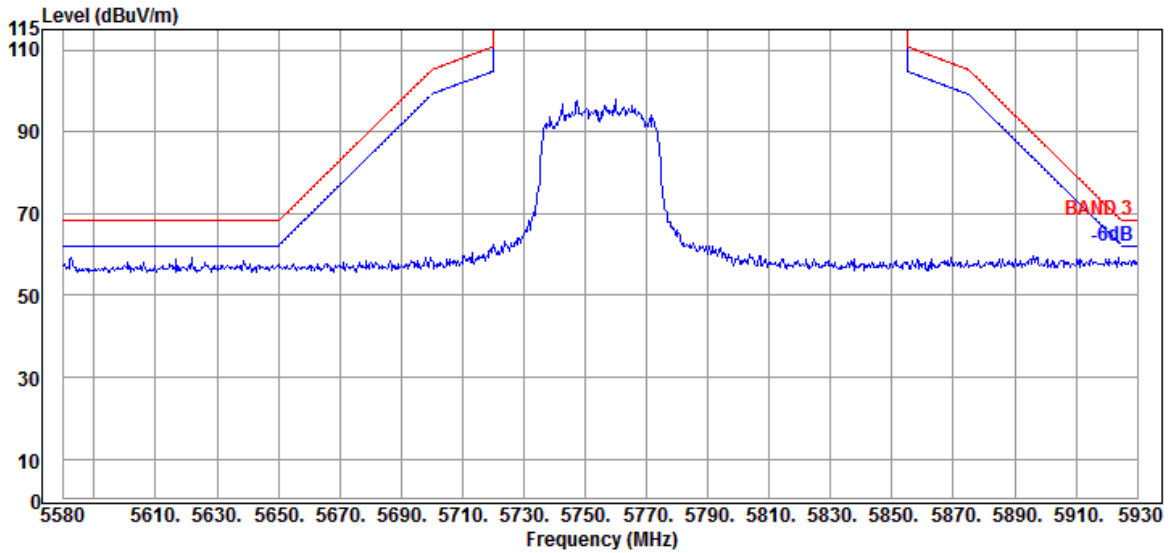

Antenna at Vertical Polarization

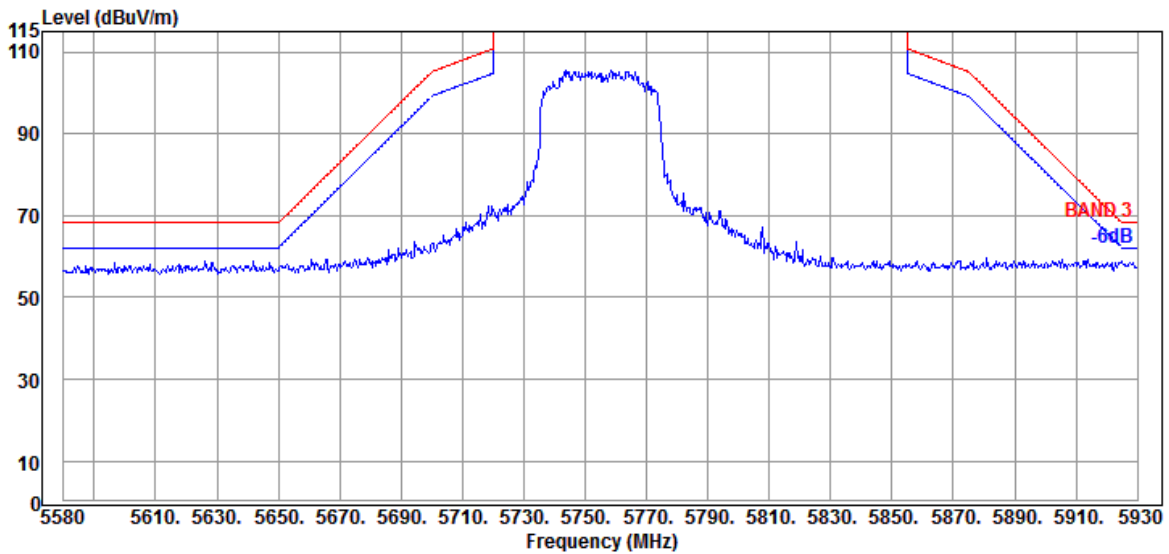

Mode	802.11ax-HE40	U-NII Band	3
		Frequency	TX 5795MHz

Antenna at Horizontal Polarization

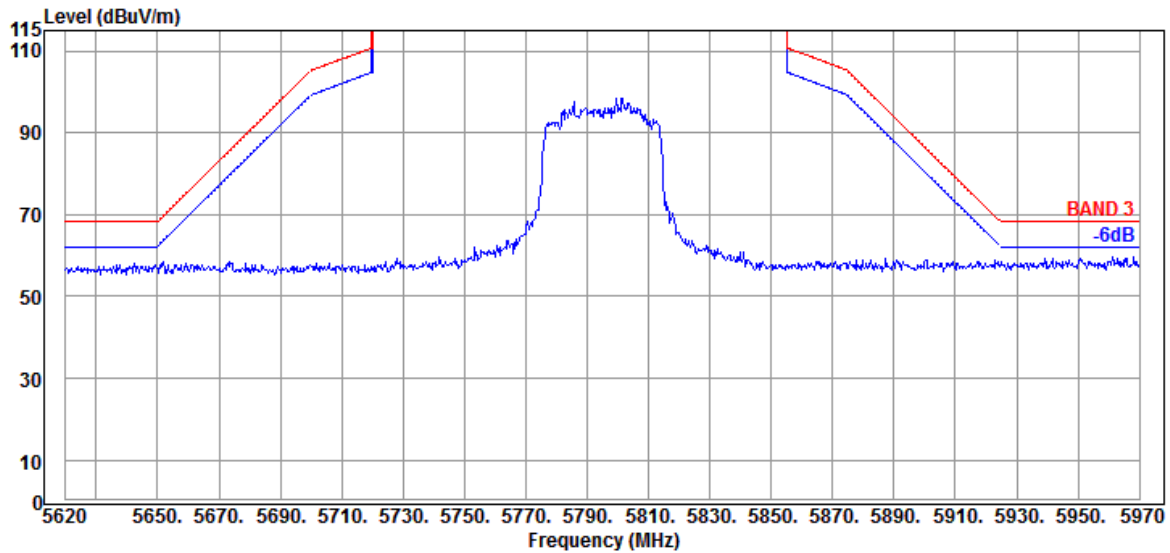

Antenna at Vertical Polarization

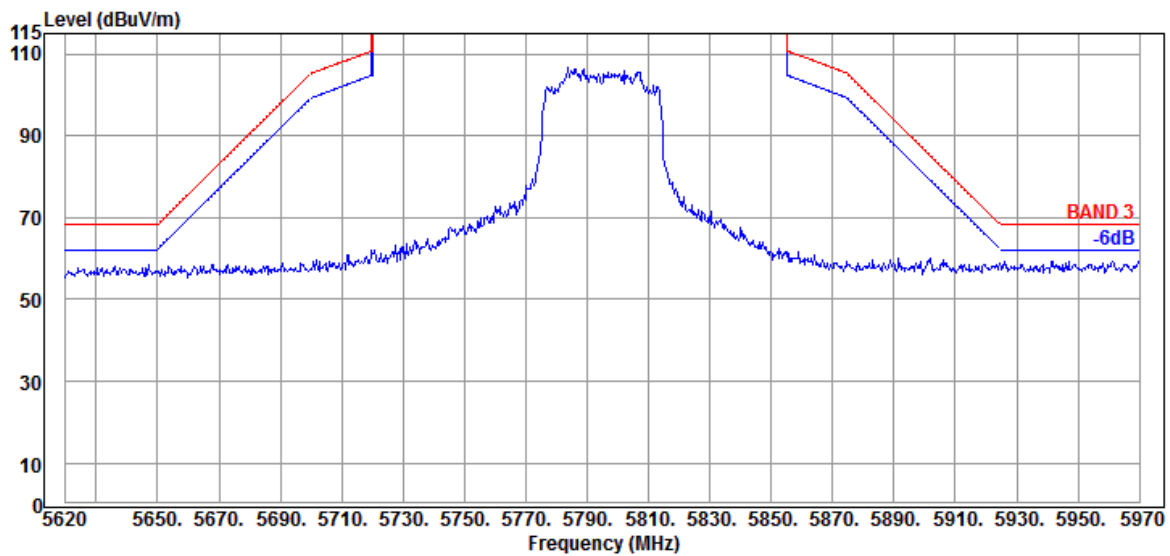

Mode	802.11ax-HE80	U-NII Band	1
		Frequency	TX 5210MHz

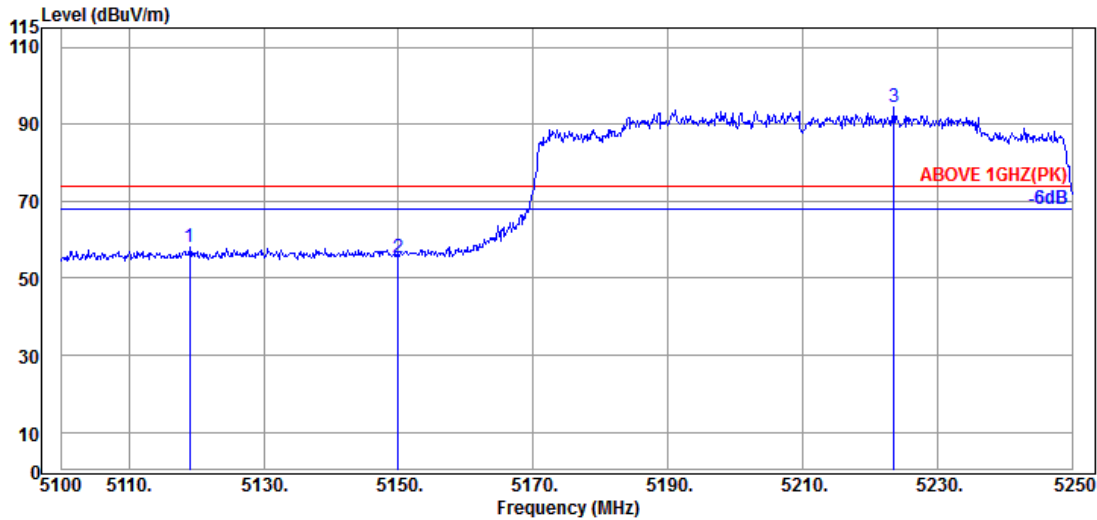

Antenna at Horizontal Polarization

Emission Frequency (MHz)	Antenna Factor (dB/m)	Cable Loss (dB)	Preamplifier Gain (dB)	Read Level (dBμV)	Emission Level (dBμV/m)	Limits (dBμV/m)	Margin (dB)	Detector
5119.050	34.30	8.87	34.35	49.12	57.94	74.00	16.06	Peak
5149.950	34.50	8.88	34.34	46.21	55.25	74.00	18.75	Peak
@ 5223.600	34.60	8.93	34.31	85.09	94.31	---	---	Peak

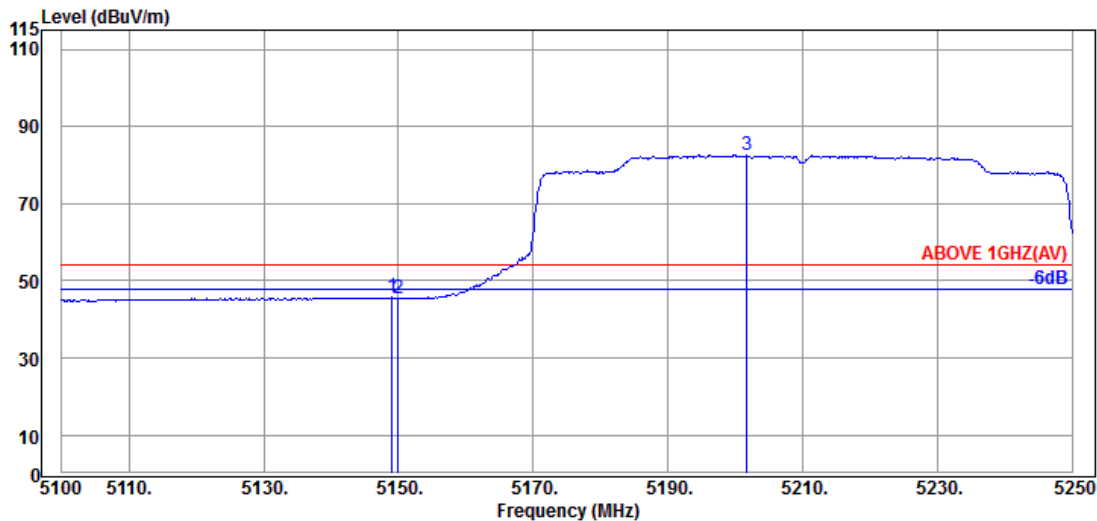

Antenna at Horizontal Polarization

Emission Frequency (MHz)	Antenna Factor (dB/m)	Cable Loss (dB)	Preamplifier Gain (dB)	Read Level (dBμV)	Emission Level (dBμV/m)	Limits (dBμV/m)	Margin (dB)	Detector
5149.050	34.50	8.88	34.34	36.64	45.68	54.00	8.32	Average
5149.950	34.50	8.88	34.34	36.47	45.51	54.00	8.49	Average
@ 5201.700	34.65	8.92	34.32	73.25	82.50	---	---	Average

Remark: The "@" means fundamental frequency, it is ignored in this section.

Mode	802.11ax-HE80	U-NII Band	1
		Frequency	TX 5210MHz

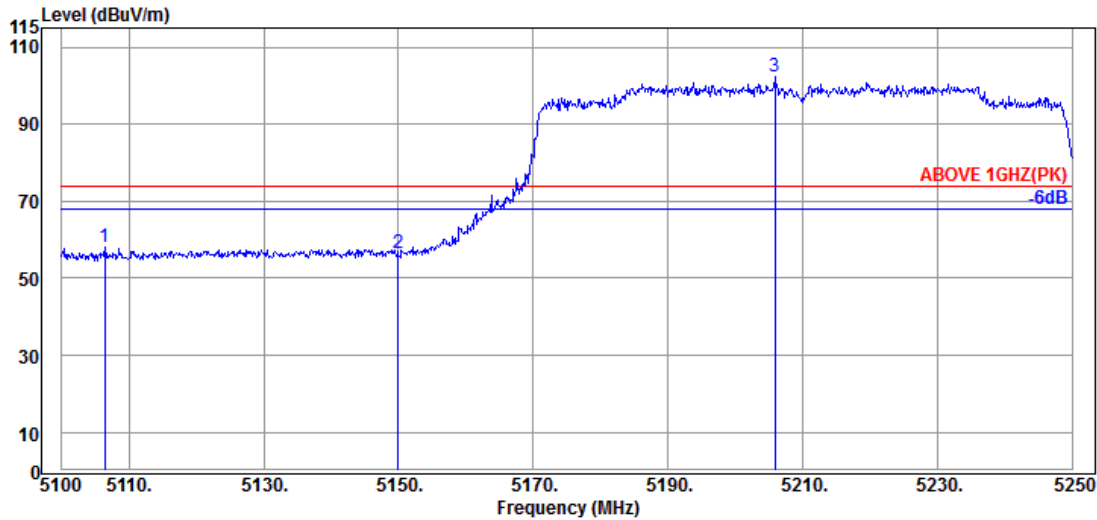

Antenna at Vertical Polarization

Emission Frequency (MHz)	Antenna Factor (dB/m)	Cable Loss (dB)	Preamp Gain (dB)	Read Level (dBμV)	Emission Level (dBμV/m)	Limits (dBμV/m)	Margin (dB)	Detector
5106.450	34.20	8.86	34.35	49.23	57.94	74.00	16.06	Peak
5149.950	34.50	8.88	34.34	47.67	56.71	74.00	17.29	Peak
@ 5205.900	34.65	8.92	34.32	93.04	102.29	---	---	Peak

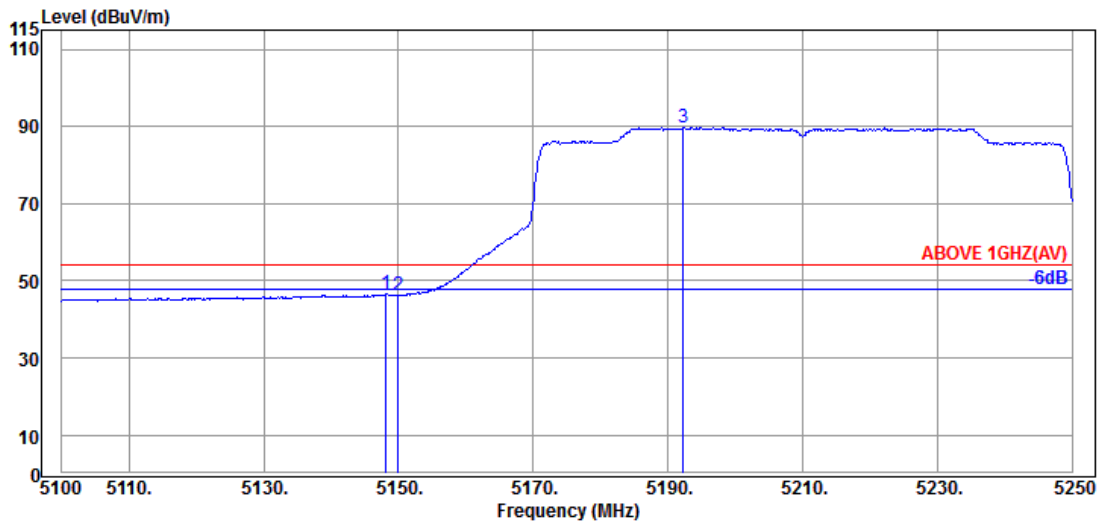

Antenna at Vertical Polarization

Emission Frequency (MHz)	Antenna Factor (dB/m)	Cable Loss (dB)	Preamp Gain (dB)	Read Level (dBμV)	Emission Level (dBμV/m)	Limits (dBμV/m)	Margin (dB)	Detector
5148.150	34.50	8.88	34.34	37.48	46.52	54.00	7.48	Average
5149.950	34.50	8.88	34.34	37.21	46.25	54.00	7.75	Average
@ 5192.250	34.70	8.91	34.32	80.38	89.67	---	---	Average

Remark: The “@” means fundamental frequency, it is ignored in this section.

Mode	802.11ax-HE80	U-NII Band	2A
		Frequency	TX 5290MHz

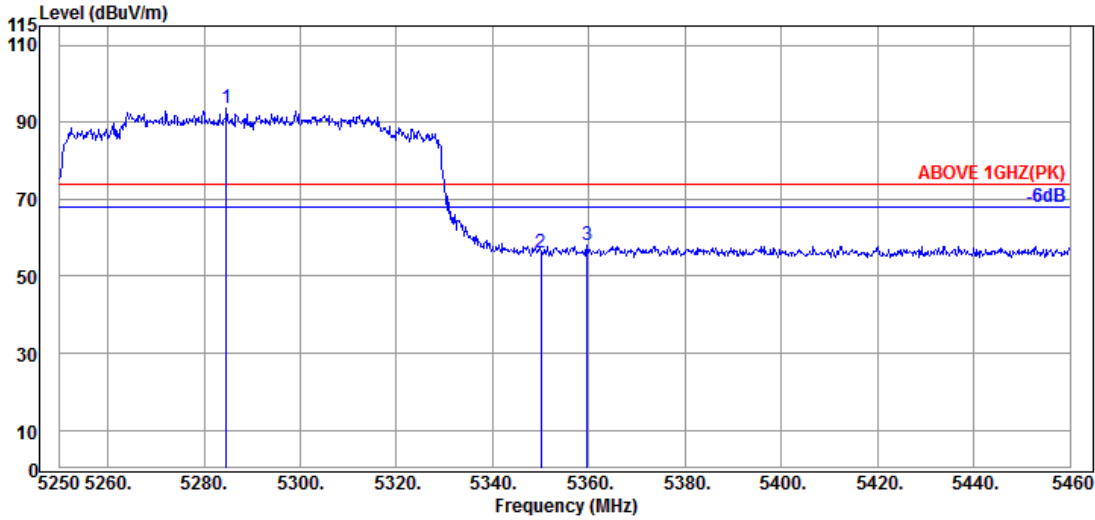

Antenna at Horizontal Polarization

Emission Frequency (MHz)	Antenna Factor (dB/m)	Cable Loss (dB)	Preamp Gain (dB)	Read Level (dBμV)	Emission Level (dBμV/m)	Limits (dBμV/m)	Margin (dB)	Detector
@ 5284.650	34.43	8.96	34.28	84.44	93.55	---	---	Peak
5349.960	34.90	8.99	34.26	46.54	56.17	74.00	17.83	Peak
5359.620	34.87	9.00	34.26	48.44	58.05	74.00	15.95	Peak

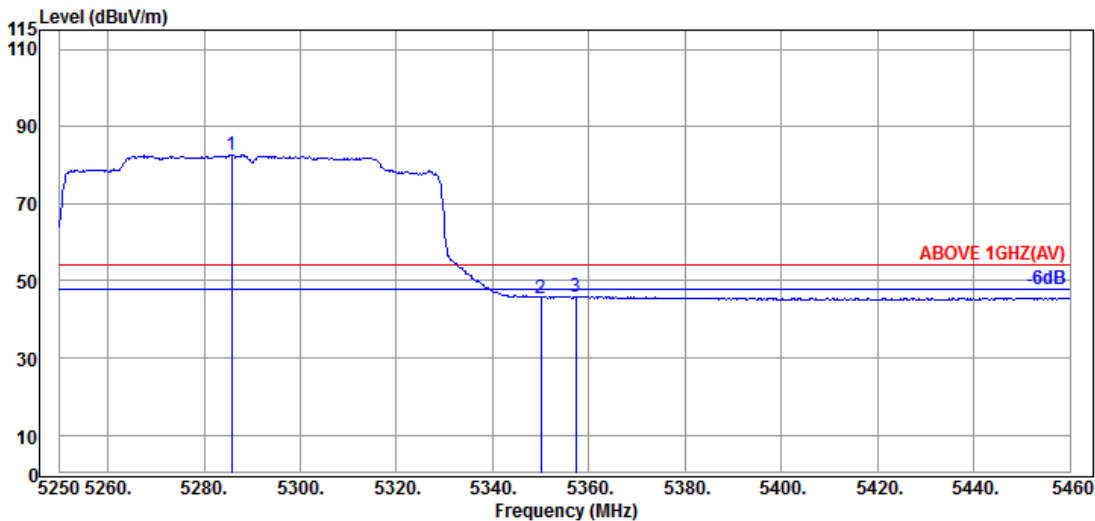

Antenna at Horizontal Polarization

Emission Frequency (MHz)	Antenna Factor (dB/m)	Cable Loss (dB)	Preamp Gain (dB)	Read Level (dBμV)	Emission Level (dBμV/m)	Limits (dBμV/m)	Margin (dB)	Detector
@ 5285.700	34.43	8.96	34.28	73.42	82.53	---	---	Average
5349.960	34.90	8.99	34.26	35.99	45.62	54.00	8.38	Average
5357.310	34.87	9.00	34.26	36.34	45.95	54.00	8.05	Average

Remark: The “@” means fundamental frequency, it is ignored in this section.

Mode	802.11ax-HE80	U-NII Band	2A
		Frequency	TX 5290MHz

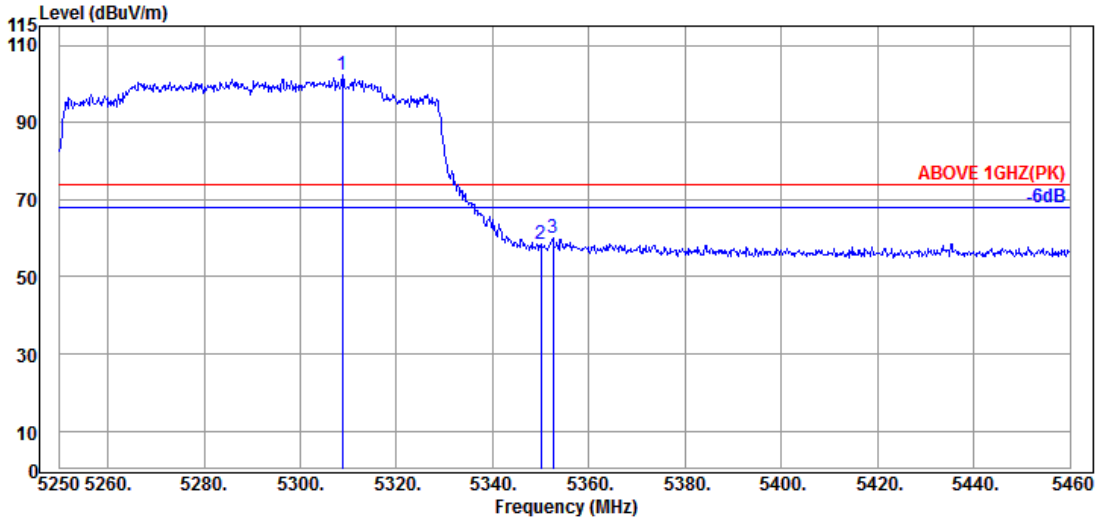

Antenna at Vertical Polarization

Emission Frequency (MHz)	Antenna Factor (dB/m)	Cable Loss (dB)	Preamp Gain (dB)	Read Level (dBμV)	Emission Level (dBμV/m)	Limits (dBμV/m)	Margin (dB)	Detector
@ 5308.800	34.57	8.98	34.28	93.03	102.30	---	---	Peak
5349.960	34.90	8.99	34.26	48.94	58.57	74.00	15.43	Peak
5352.480	34.90	8.99	34.26	50.30	59.93	74.00	14.07	Peak

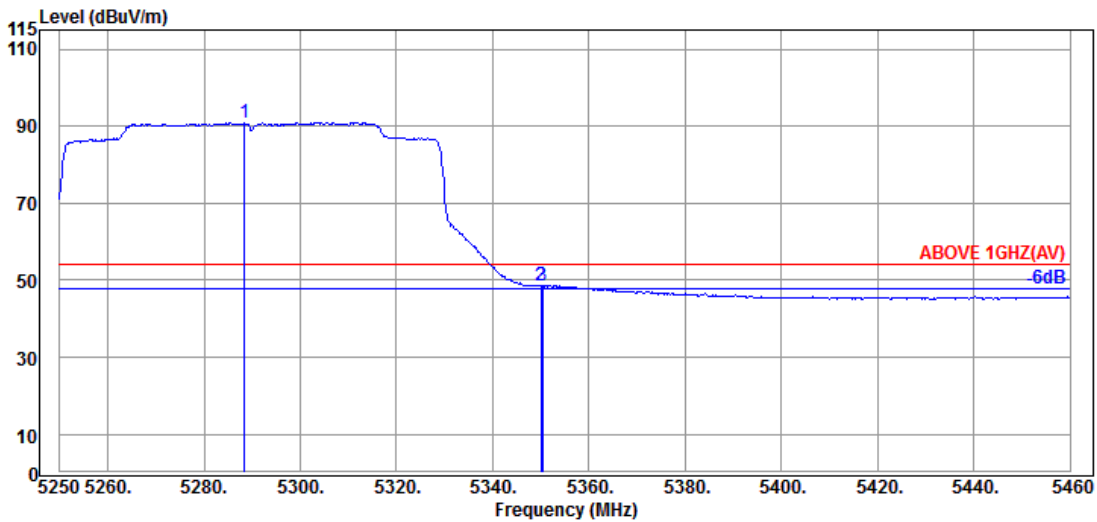

Antenna at Vertical Polarization

Emission Frequency (MHz)	Antenna Factor (dB/m)	Cable Loss (dB)	Preamp Gain (dB)	Read Level (dBμV)	Emission Level (dBμV/m)	Limits (dBμV/m)	Margin (dB)	Detector
@ 5288.430	34.43	8.96	34.28	81.84	90.95	---	---	Average
5349.960	34.90	8.99	34.26	38.99	48.62	54.00	5.38	Average
5350.380	34.90	8.99	34.26	39.12	48.75	54.00	5.25	Average

Remark: The “@” means fundamental frequency, it is ignored in this section.

Mode	802.11ax-HE80	U-NII Band	2C
		Frequency	TX 5530MHz

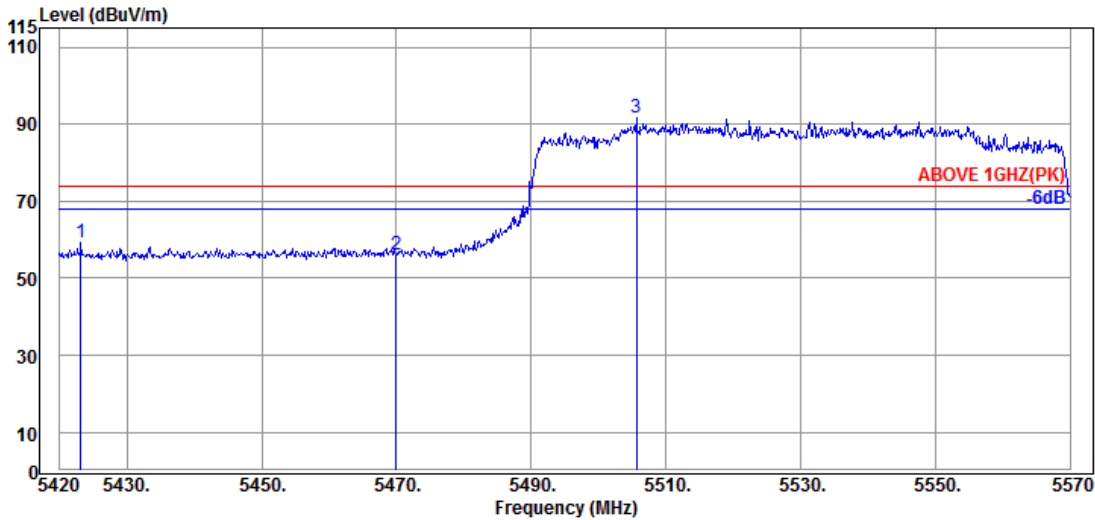

Antenna at Horizontal Polarization

Emission Frequency (MHz)	Antenna Factor (dB/m)	Cable Loss (dB)	Preamp Gain (dB)	Read Level (dBμV)	Emission Level (dBμV/m)	Limits (dBμV/m)	Margin (dB)	Detector
5423.150	34.70	9.04	34.23	49.64	59.15	74.00	14.85	Peak
5469.950	34.63	9.06	34.21	46.60	56.08	74.00	17.92	Peak
@ 5505.650	34.70	9.08	34.21	82.12	91.69	---	---	Peak

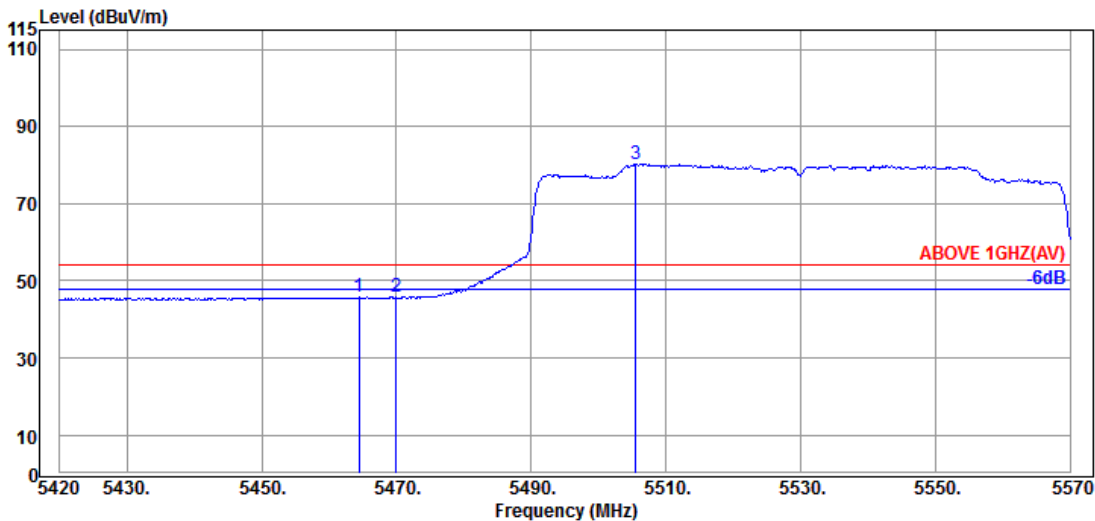

Antenna at Horizontal Polarization

Emission Frequency (MHz)	Antenna Factor (dB/m)	Cable Loss (dB)	Preamp Gain (dB)	Read Level (dBμV)	Emission Level (dBμV/m)	Limits (dBμV/m)	Margin (dB)	Detector
5464.400	34.63	9.06	34.21	36.24	45.72	54.00	8.28	Average
5469.950	34.63	9.06	34.21	36.23	45.71	54.00	8.29	Average
@ 5505.500	34.70	9.08	34.20	70.70	80.28	---	---	Average

Remark: The “@” means fundamental frequency, it is ignored in this section.

Mode	802.11ax-HE80	U-NII Band	2C
		Frequency	TX 5530MHz

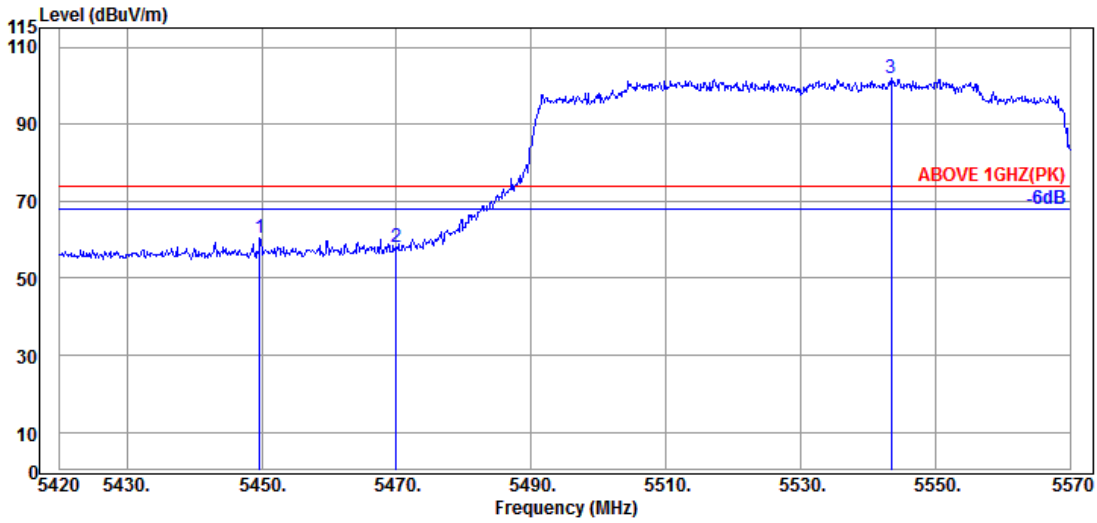

Antenna at Vertical Polarization

Emission Frequency (MHz)	Antenna Factor (dB/m)	Cable Loss (dB)	Preamplifier Gain (dB)	Read Level (dBμV)	Emission Level (dBμV/m)	Limits (dBμV/m)	Margin (dB)	Detector
5449.700	34.60	9.05	34.22	51.08	60.51	74.00	13.49	Peak
5469.950	34.63	9.06	34.21	48.81	58.29	74.00	15.71	Peak
@ 5543.450	34.70	9.10	34.23	92.51	102.08	---	---	Peak

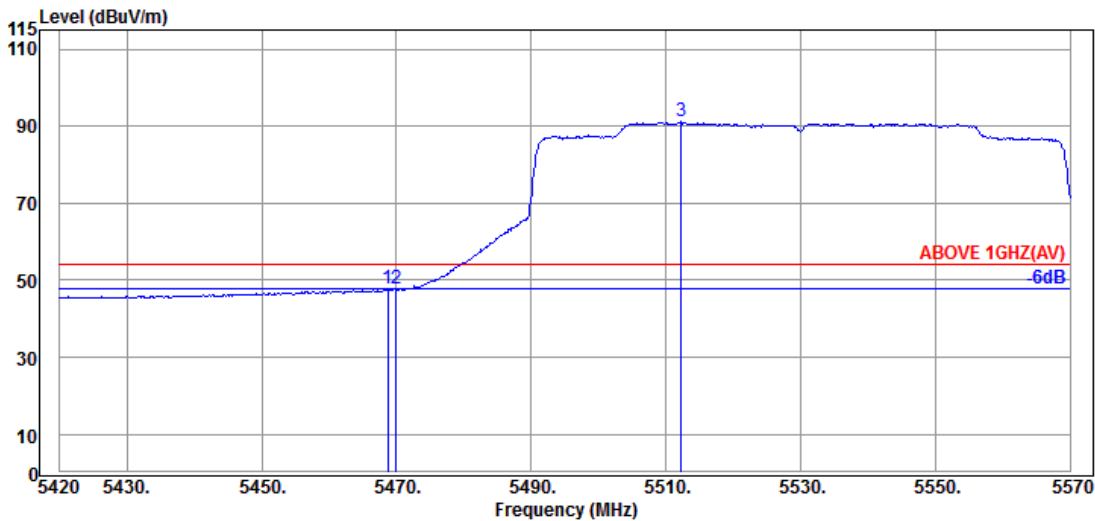

Antenna at Vertical Polarization

Emission Frequency (MHz)	Antenna Factor (dB/m)	Cable Loss (dB)	Preamplifier Gain (dB)	Read Level (dBμV)	Emission Level (dBμV/m)	Limits (dBμV/m)	Margin (dB)	Detector
5468.750	34.63	9.06	34.21	38.24	47.72	54.00	6.28	Average
5469.950	34.63	9.06	34.21	38.36	47.84	54.00	6.16	Average
@ 5512.250	34.70	9.09	34.21	81.53	91.11	---	---	Average

Remark: The “@” means fundamental frequency, it is ignored in this section.

Mode	802.11ax-HE80	U-NII Band	2C
		Frequency	TX 5610MHz

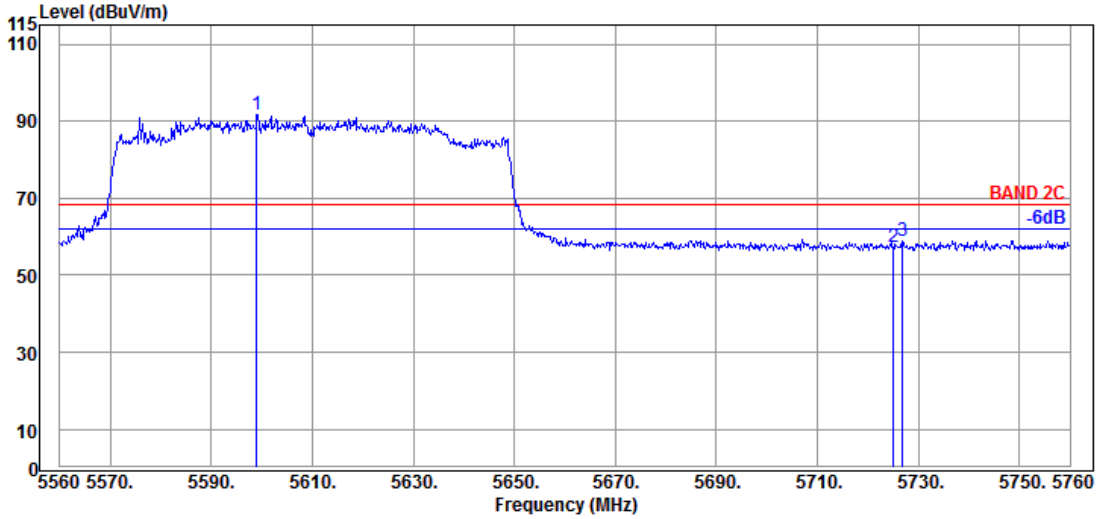

Antenna at Horizontal Polarization

Emission Frequency (MHz)	Antenna Factor (dB/m)	Cable Loss (dB)	Preamp Gain (dB)	Read Level (dBμV)	Emission Level (dBμV/m)	Limits (dBμV/m)	Margin (dB)	Detector
@ 5599.000	34.40	9.13	34.25	82.42	91.70	---	---	Peak
5725.000	34.90	9.20	34.30	47.31	57.11	68.20	11.09	Peak
5726.800	34.90	9.20	34.31	49.29	59.08	68.20	9.12	Peak

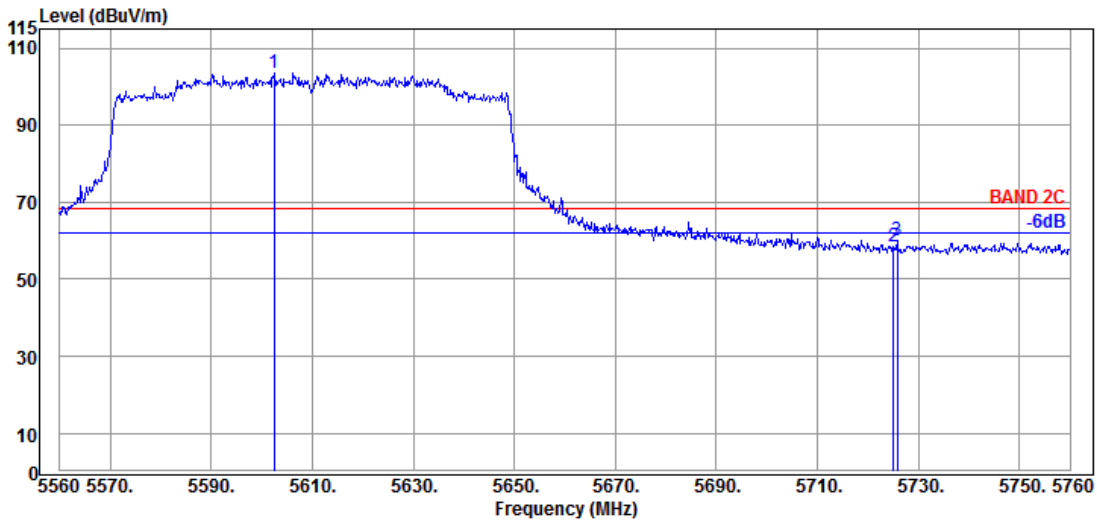

Antenna at Vertical Polarization

Emission Frequency (MHz)	Antenna Factor (dB/m)	Cable Loss (dB)	Preamp Gain (dB)	Read Level (dBμV)	Emission Level (dBμV/m)	Limits (dBμV/m)	Margin (dB)	Detector
@ 5602.400	34.40	9.13	34.25	94.23	103.51	---	---	Peak
5725.000	34.90	9.20	34.30	48.55	58.35	68.20	9.85	Peak
5725.800	34.90	9.20	34.30	50.14	59.94	68.20	8.26	Peak

Remark: The “@” means fundamental frequency, it is ignored in this section.

Mode	802.11ax-HE80	U-NII Band	2C
		Frequency	TX 5690MHz

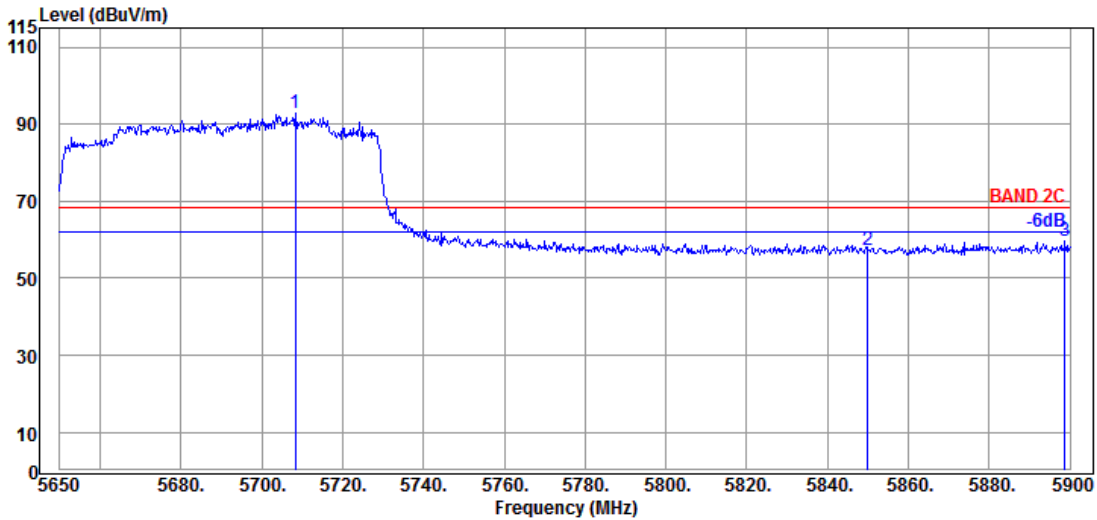

Antenna at Horizontal Polarization

Emission Frequency (MHz)	Antenna Factor (dB/m)	Cable Loss (dB)	Preamplifier Gain (dB)	Read Level (dBμV)	Emission Level (dBμV/m)	Limits (dBμV/m)	Margin (dB)	Detector
@ 5708.250	34.80	9.19	34.30	83.09	92.78	---	---	Peak
5850.000	35.40	9.25	34.36	47.11	57.40	68.20	10.80	Peak
5898.750	35.80	9.28	34.39	48.84	59.53	68.20	8.67	Peak

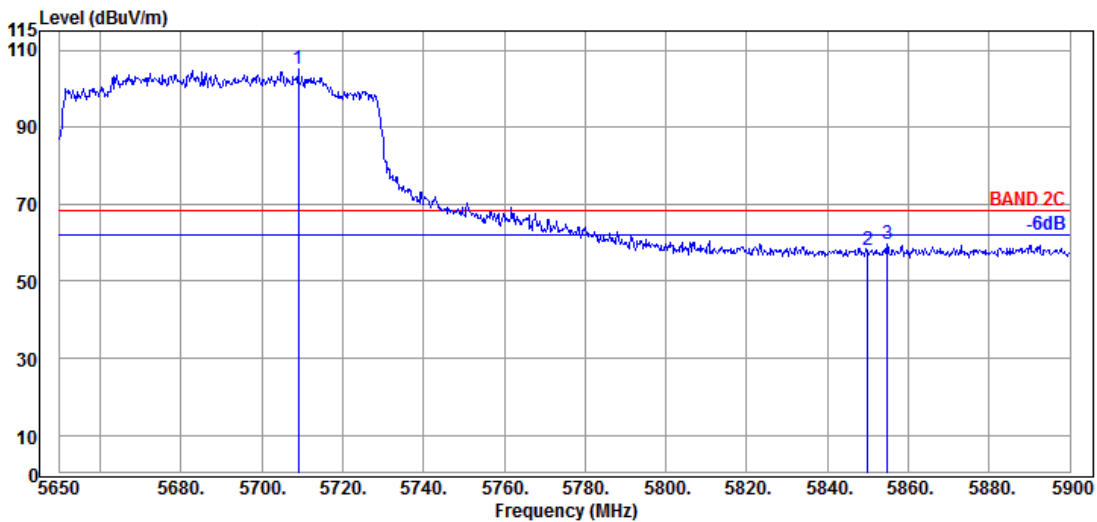

Antenna at Vertical Polarization

Emission Frequency (MHz)	Antenna Factor (dB/m)	Cable Loss (dB)	Preamplifier Gain (dB)	Read Level (dBμV)	Emission Level (dBμV/m)	Limits (dBμV/m)	Margin (dB)	Detector
@ 5709.000	34.80	9.19	34.30	95.31	105.00	---	---	Peak
5850.000	35.40	9.25	34.36	47.84	58.13	68.20	10.07	Peak
5854.750	35.40	9.25	34.36	49.39	59.68	68.20	8.52	Peak

Remark: The “@” means fundamental frequency, it is ignored in this section.

Mode	802.11ax-HE80	U-NII Band	2C
		Frequency	TX 5690MHz

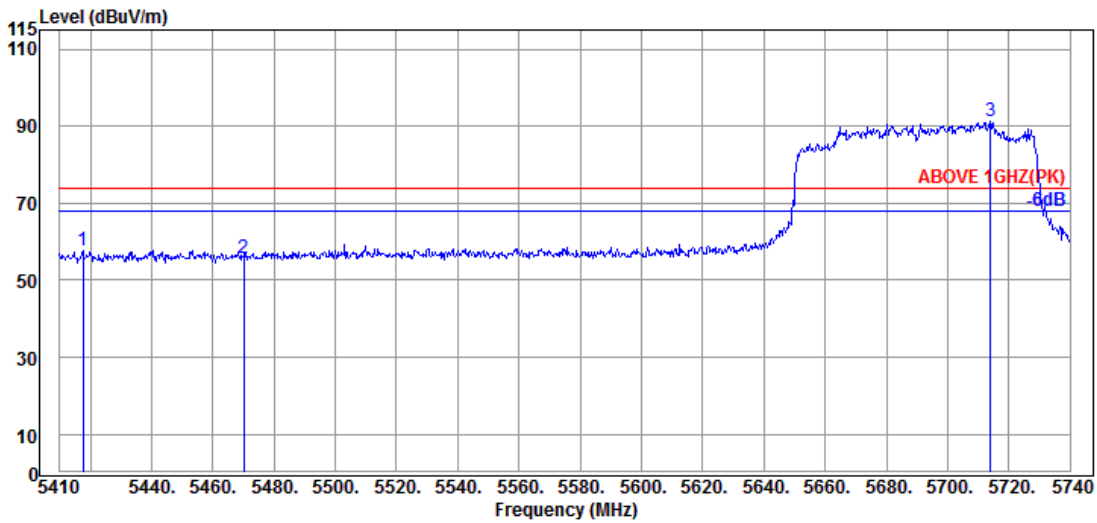

Antenna at Horizontal Polarization

Emission Frequency (MHz)	Antenna Factor (dB/m)	Cable Loss (dB)	Preamplifier Gain (dB)	Read Level (dBμV)	Emission Level (dBμV/m)	Limits (dBμV/m)	Margin (dB)	Detector
5417.590	34.70	9.04	34.23	48.17	57.68	74.00	16.32	Peak
5470.060	34.63	9.06	34.21	46.29	55.77	74.00	18.23	Peak
@ 5713.930	34.80	9.19	34.30	81.54	91.23	---	---	Peak

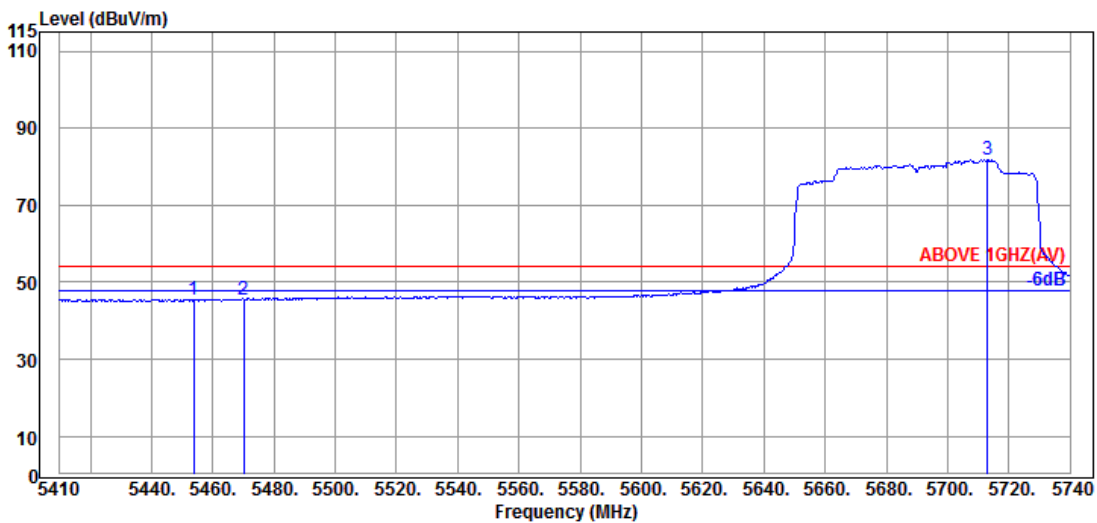

Antenna at Horizontal Polarization

Emission Frequency (MHz)	Antenna Factor (dB/m)	Cable Loss (dB)	Preamplifier Gain (dB)	Read Level (dBμV)	Emission Level (dBμV/m)	Limits (dBμV/m)	Margin (dB)	Detector
5453.890	34.60	9.05	34.21	36.14	45.58	54.00	8.42	Average
5470.060	34.63	9.06	34.21	35.94	45.42	54.00	8.58	Average
@ 5712.940	34.80	9.19	34.30	72.19	81.88	---	---	Average

Remark: The “@” means fundamental frequency, it is ignored in this section.

Mode	802.11ax-HE80	U-NII Band	2C
		Frequency	TX 5690MHz

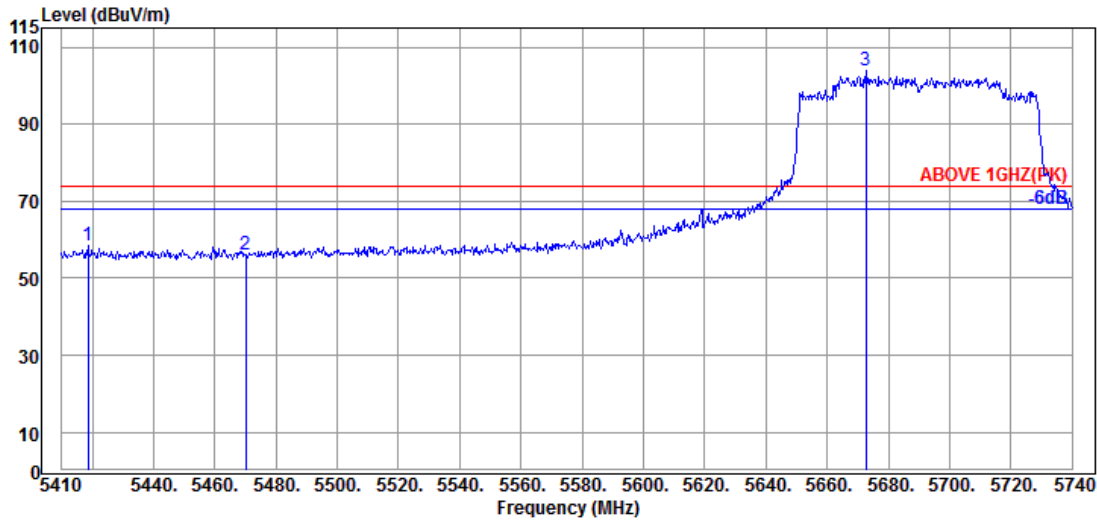

Antenna at Vertical Polarization

Emission Frequency (MHz)	Antenna Factor (dB/m)	Cable Loss (dB)	Preamp Gain (dB)	Read Level (dBμV)	Emission Level (dBUV/m)	Limits (dBUV/m)	Margin (dB)	Detector
5418.580	34.70	9.04	34.23	48.86	58.37	74.00	15.63	Peak
5470.060	34.63	9.06	34.21	46.63	56.11	74.00	17.89	Peak
@ 5672.680	34.57	9.16	34.29	94.35	103.79	---	---	Peak

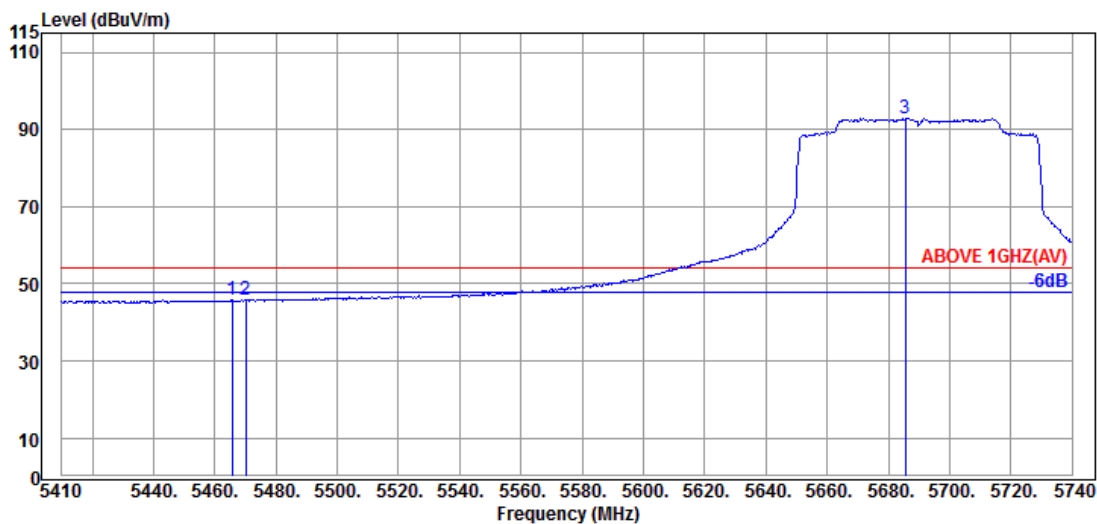

Antenna at Vertical Polarization

Emission Frequency (MHz)	Antenna Factor (dB/m)	Cable Loss (dB)	Preamp Gain (dB)	Read Level (dBμV)	Emission Level (dBUV/m)	Limits (dBUV/m)	Margin (dB)	Detector
5465.770	34.63	9.06	34.21	36.31	45.79	54.00	8.21	Average
5470.060	34.63	9.06	34.21	36.25	45.73	54.00	8.27	Average
@ 5685.550	34.63	9.17	34.29	83.35	92.86	---	---	Average

Remark: The “@” means fundamental frequency, it is ignored in this section.

Mode	802.11ac-HE80	U-NII Band	3
		Frequency	TX 5775MHz

Antenna at Horizontal Polarization

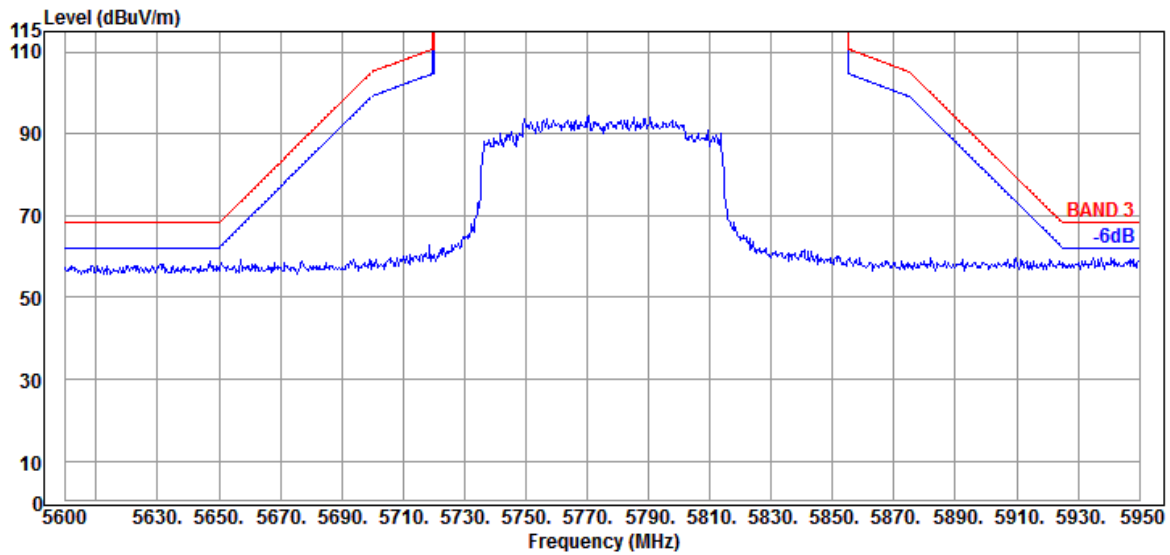

Antenna at Vertical Polarization

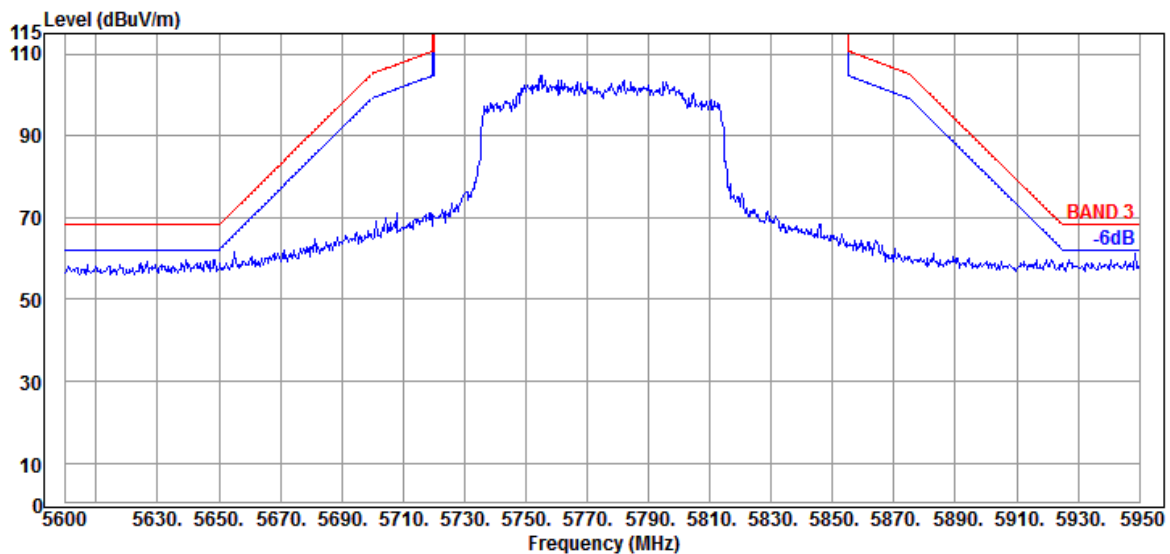

Mode	802.11ax-HE160	U-NII Band	1 & 2A
		Frequency	TX 5250MHz

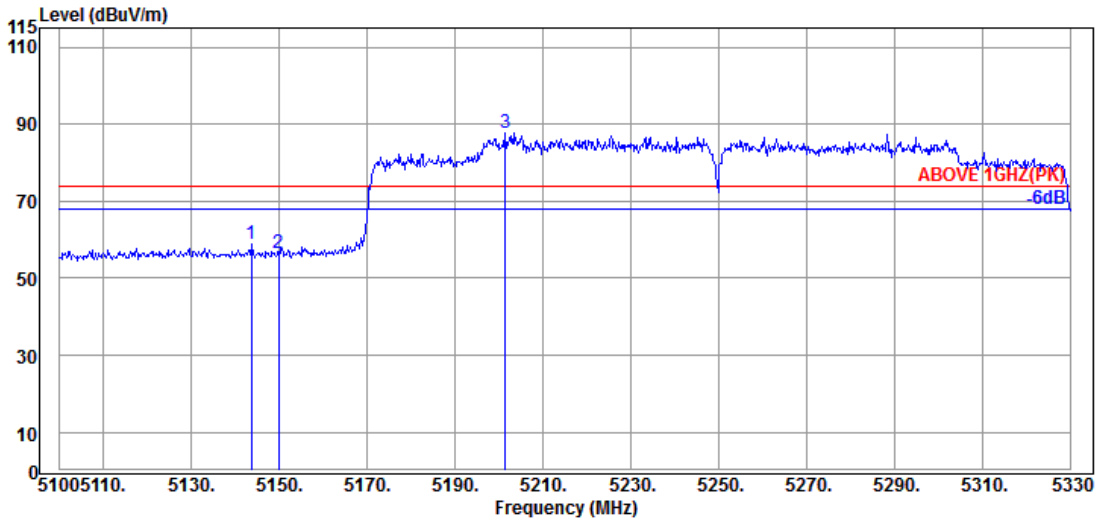

Antenna at Horizontal Polarization

Emission Frequency (MHz)	Antenna Factor (dB/m)	Cable Loss (dB)	Preamplifier Gain (dB)	Read Level (dBμV)	Emission Level (dBμV/m)	Limits (dBμV/m)	Margin (dB)	Detector
5143.700	34.50	8.88	34.34	50.00	59.04	74.00	14.96	Peak
5149.910	34.50	8.88	34.34	47.32	56.36	74.00	17.64	Peak
@ 5201.430	34.70	8.91	34.32	78.55	87.84	---	---	Peak

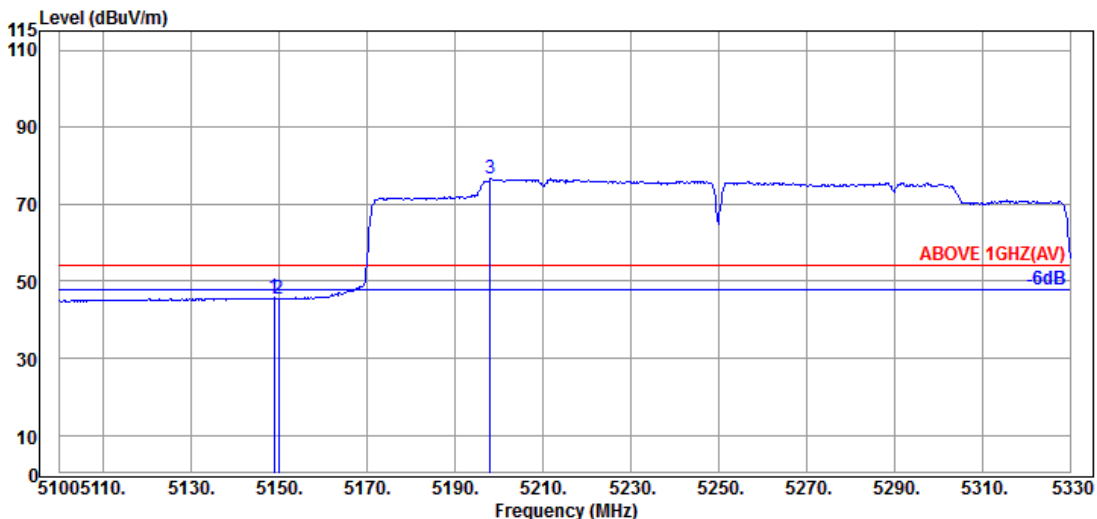

Antenna at Horizontal Polarization

Emission Frequency (MHz)	Antenna Factor (dB/m)	Cable Loss (dB)	Preamplifier Gain (dB)	Read Level (dBμV)	Emission Level (dBμV/m)	Limits (dBμV/m)	Margin (dB)	Detector
5148.760	34.50	8.88	34.34	36.64	45.68	54.00	8.32	Average
5149.910	34.50	8.88	34.34	36.41	45.45	54.00	8.55	Average
@ 5197.980	34.70	8.91	34.32	67.28	76.57	---	---	Average

Remark: The “@” means fundamental frequency, it is ignored in this section.

Mode	802.11ax-HE160	U-NII Band	I & 2A
		Frequency	TX 5250MHz

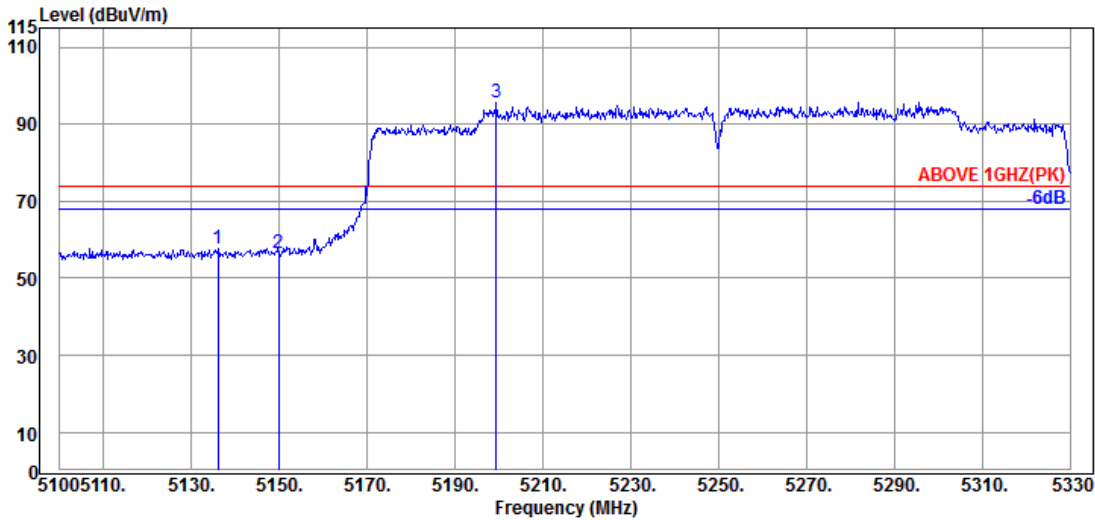

Antenna at Vertical Polarization

Emission Frequency (MHz)	Antenna Factor (dB/m)	Cable Loss (dB)	Preamp Gain (dB)	Read Level (dBμV)	Emission Level (dBUV/m)	Limits (dBUV/m)	Margin (dB)	Detector
5136.110	34.40	8.88	34.34	48.95	57.89	74.00	16.11	Peak
5149.910	34.50	8.88	34.34	47.49	56.53	74.00	17.47	Peak
@ 5199.360	34.70	8.91	34.32	86.43	95.72	---	---	Peak

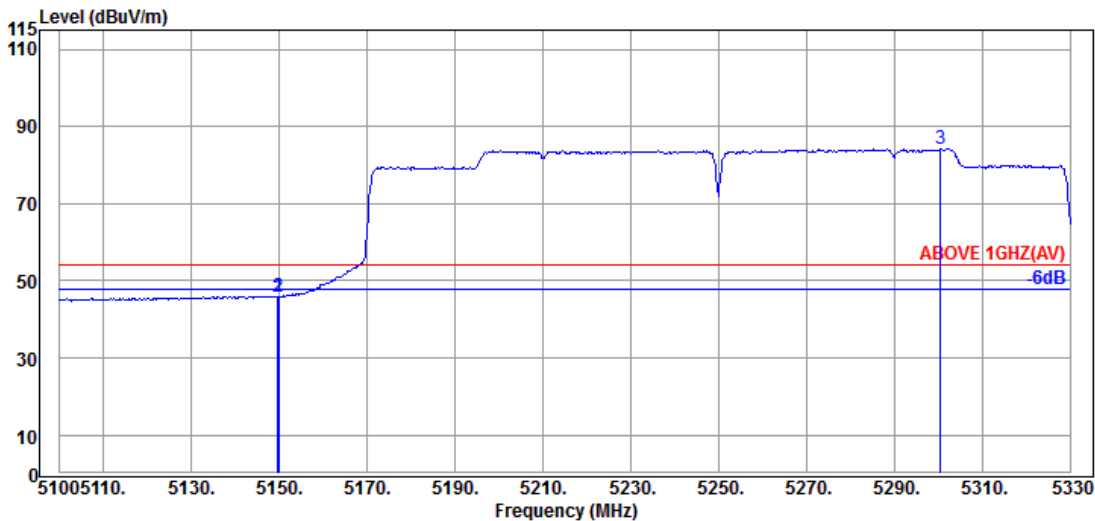

Antenna at Vertical Polarization

Emission Frequency (MHz)	Antenna Factor (dB/m)	Cable Loss (dB)	Preamp Gain (dB)	Read Level (dBμV)	Emission Level (dBUV/m)	Limits (dBUV/m)	Margin (dB)	Detector
5149.680	34.50	8.88	34.34	36.92	45.96	54.00	8.04	Average
5149.910	34.50	8.88	34.34	36.82	45.86	54.00	8.14	Average
@ 5300.560	34.40	8.97	34.28	75.20	84.29	---	---	Average

Remark: The “@” means fundamental frequency, it is ignored in this section.

Mode	802.11ax-HE160	U-NII Band	1 & 2A
		Frequency	TX 5250MHz

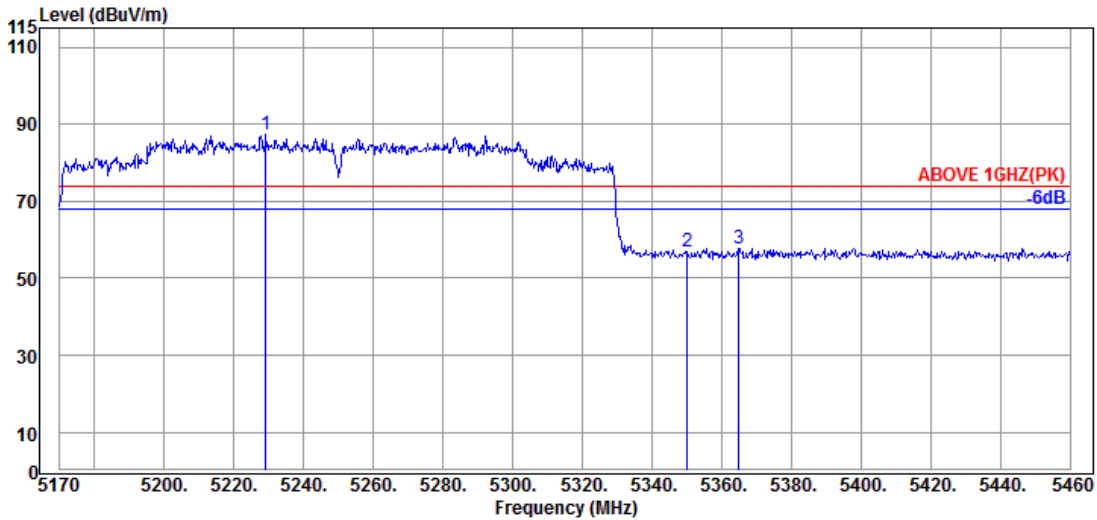

Antenna at Horizontal Polarization

Emission Frequency (MHz)	Antenna Factor (dB/m)	Cable Loss (dB)	Preamp Gain (dB)	Read Level (dBμV)	Emission Level (dBμV/m)	Limits (dBμV/m)	Margin (dB)	Detector
@ 5229.160	34.60	8.93	34.30	77.98	87.21	---	---	Peak
5350.090	34.90	8.99	34.26	47.42	57.05	74.00	16.95	Peak
5364.880	34.87	9.00	34.25	48.08	57.70	74.00	16.30	Peak

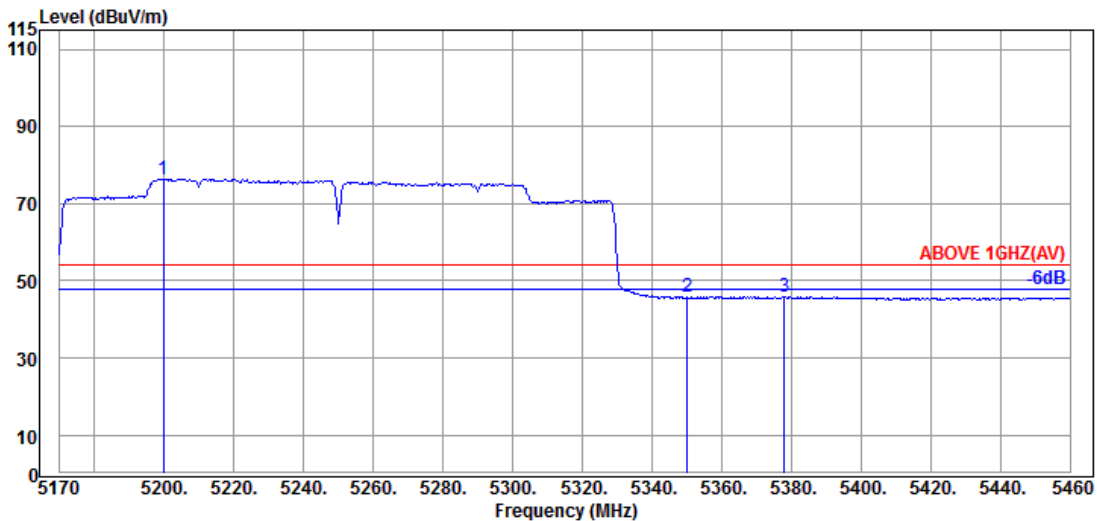

Antenna at Horizontal Polarization

Emission Frequency (MHz)	Antenna Factor (dB/m)	Cable Loss (dB)	Preamp Gain (dB)	Read Level (dBμV)	Emission Level (dBμV/m)	Limits (dBμV/m)	Margin (dB)	Detector
@ 5199.870	34.70	8.91	34.32	67.15	76.44	---	---	Average
5350.090	34.90	8.99	34.26	36.07	45.70	54.00	8.30	Average
5377.930	34.83	9.01	34.25	36.27	45.86	54.00	8.14	Average

Remark: The “@” means fundamental frequency, it is ignored in this section.

Mode	802.11ax-HE160	U-NII Band	1 & 2A
		Frequency	TX 5250MHz

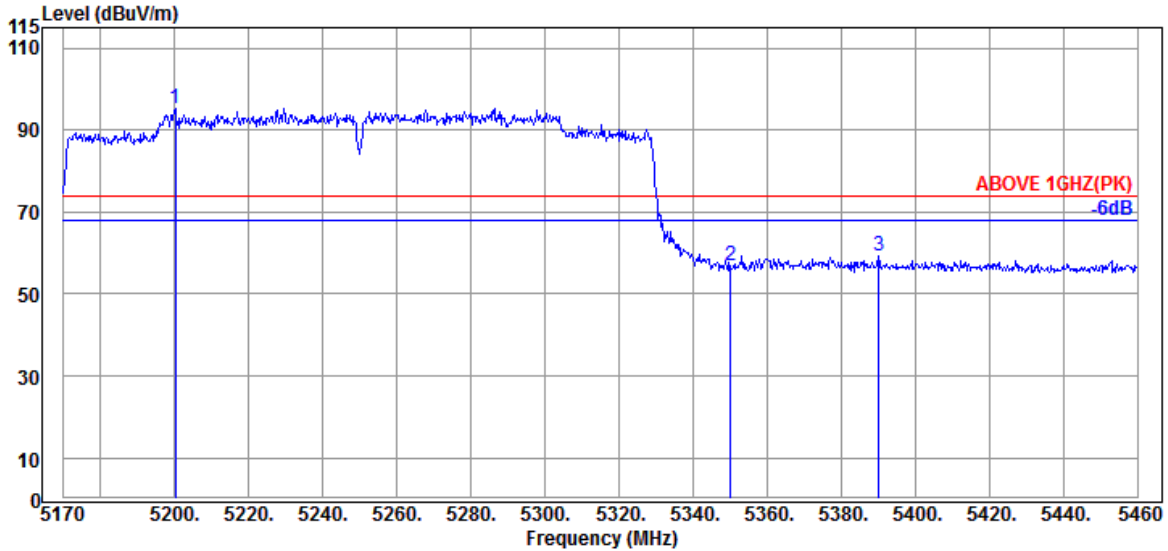

Antenna at Vertical Polarization

Emission Frequency (MHz)	Antenna Factor (dB/m)	Cable Loss (dB)	Preamp Gain (dB)	Read Level (dBμV)	Emission Level (dBμV/m)	Limits (dBμV/m)	Margin (dB)	Detector
@ 5200.160	34.70	8.91	34.32	86.11	95.40	---	---	Peak
5350.090	34.90	8.99	34.26	47.41	57.04	74.00	16.96	Peak
5390.110	34.80	9.02	34.24	49.65	59.23	74.00	14.77	Peak

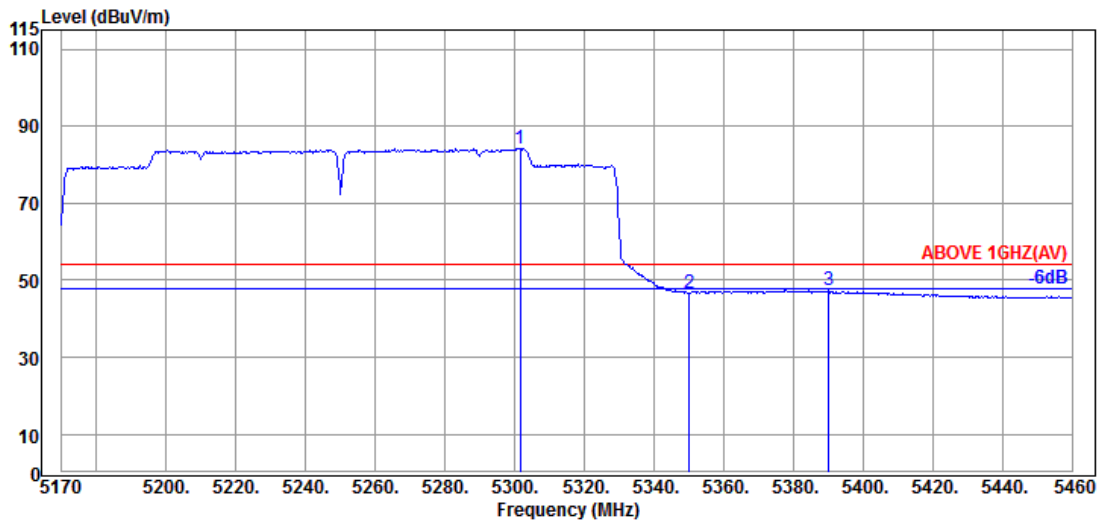

Antenna at Vertical Polarization

Emission Frequency (MHz)	Antenna Factor (dB/m)	Cable Loss (dB)	Preamp Gain (dB)	Read Level (dBμV)	Emission Level (dBμV/m)	Limits (dBμV/m)	Margin (dB)	Detector
@ 5301.660	34.40	8.97	34.28	75.11	84.20	---	---	Average
5350.090	34.90	8.99	34.26	37.03	46.66	54.00	7.34	Average
5390.110	34.80	9.02	34.24	37.75	47.33	54.00	6.67	Average

Remark: The “@” means fundamental frequency, it is ignored in this section.

Mode	802.11ax-HE160	U-NII Band	2C
		Frequency	TX 5570MHz

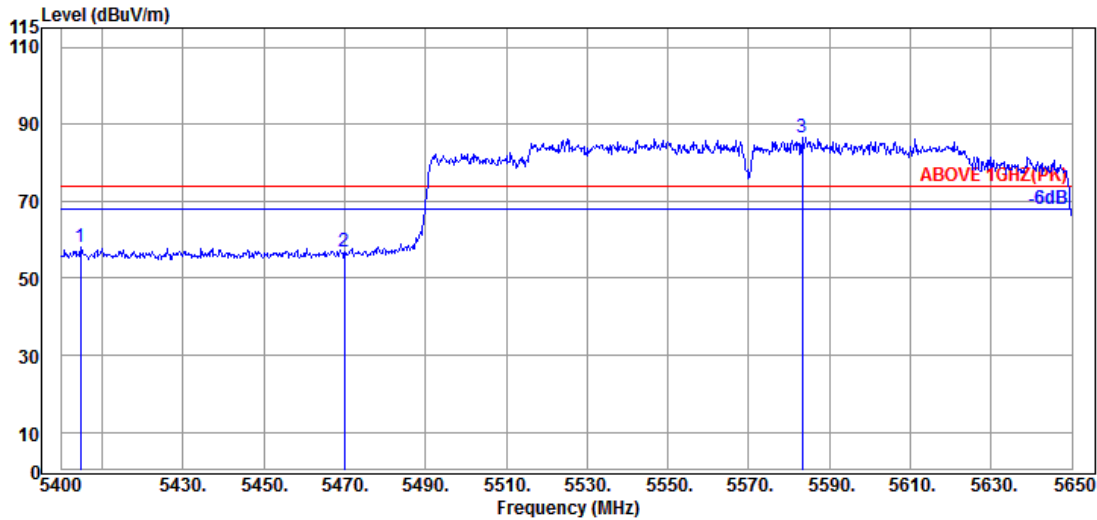

Antenna at Horizontal Polarization

Emission Frequency (MHz)	Antenna Factor (dB/m)	Cable Loss (dB)	Preamp Gain (dB)	Read Level (dBμV)	Emission Level (dBμV/m)	Limits (dBμV/m)	Margin (dB)	Detector
5404.750	34.75	9.03	34.23	48.48	58.03	74.00	15.97	Peak
5470.000	34.63	9.06	34.21	47.27	56.75	74.00	17.25	Peak
@ 5583.250	34.50	9.12	34.24	77.36	86.74	---	---	Peak

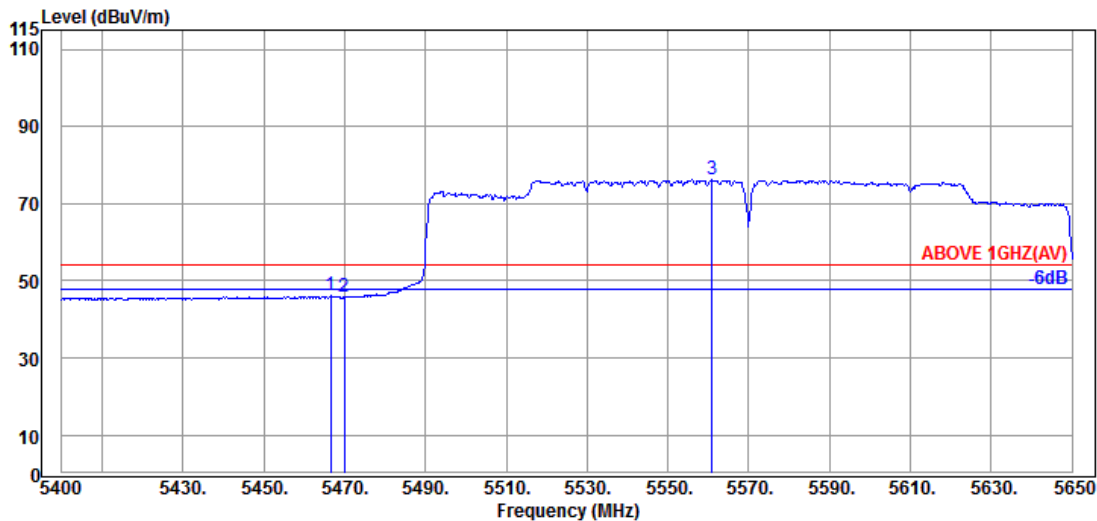

Antenna at Horizontal Polarization

Emission Frequency (MHz)	Antenna Factor (dB/m)	Cable Loss (dB)	Preamp Gain (dB)	Read Level (dBμV)	Emission Level (dBμV/m)	Limits (dBμV/m)	Margin (dB)	Detector
5466.500	34.63	9.06	34.21	36.56	46.04	54.00	7.96	Average
5470.000	34.63	9.06	34.21	36.37	45.85	54.00	8.15	Average
@ 5561.000	34.60	9.11	34.23	66.62	76.10	---	---	Average

Remark: The “@” means fundamental frequency, it is ignored in this section.

Mode	802.11ax-HE160	U-NII Band	2C
		Frequency	TX 5570MHz

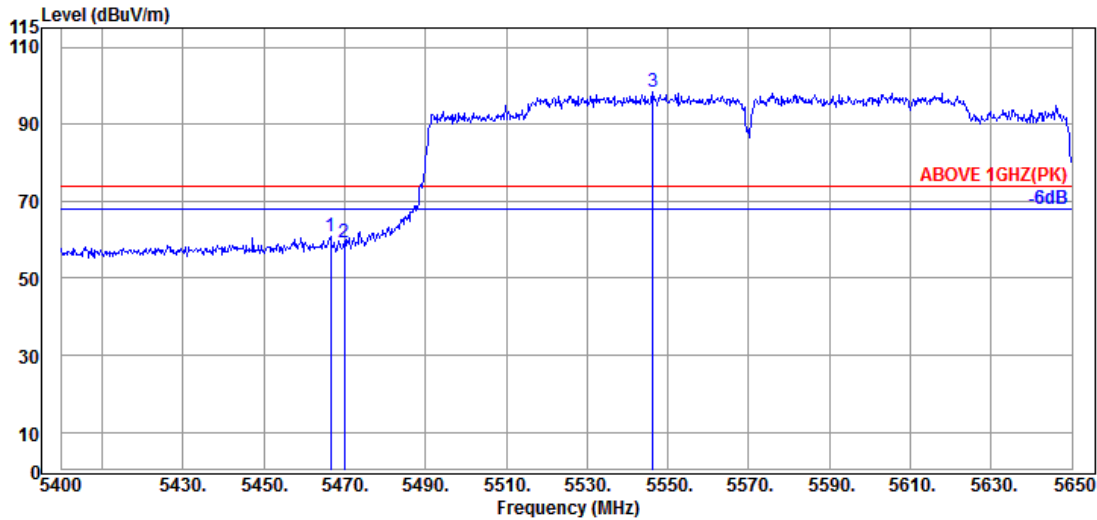

Antenna at Vertical Polarization

Emission Frequency (MHz)	Antenna Factor (dB/m)	Cable Loss (dB)	Preamplifier Gain (dB)	Read Level (dBμV)	Emission Level (dBμV/m)	Limits (dBμV/m)	Margin (dB)	Detector
5466.500	34.63	9.06	34.21	51.24	60.72	74.00	13.28	Peak
5470.000	34.63	9.06	34.21	49.79	59.27	74.00	14.73	Peak
@ 5546.250	34.70	9.10	34.23	88.74	98.31	---	---	Peak

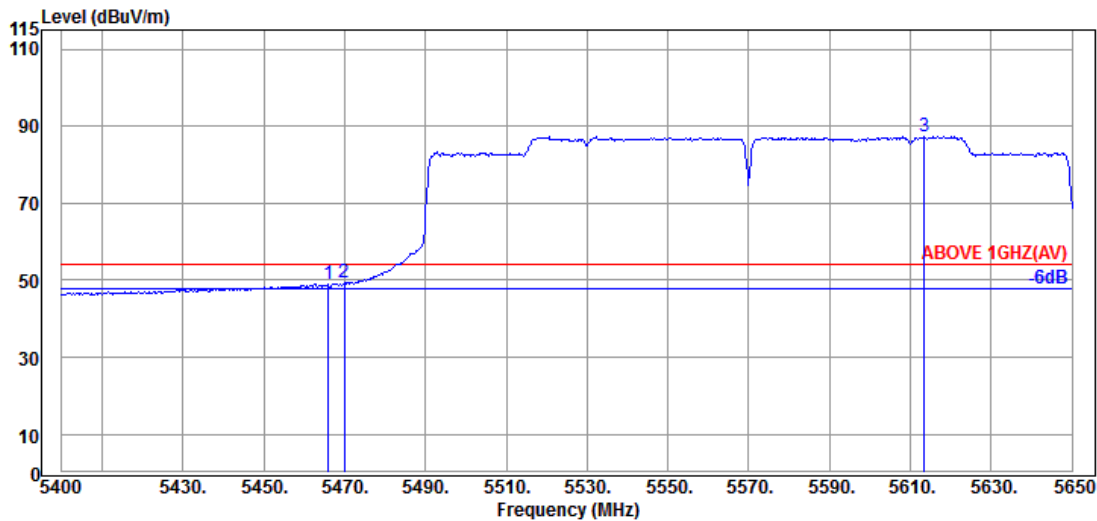

Antenna at Vertical Polarization

Emission Frequency (MHz)	Antenna Factor (dB/m)	Cable Loss (dB)	Preamplifier Gain (dB)	Read Level (dBμV)	Emission Level (dBμV/m)	Limits (dBμV/m)	Margin (dB)	Detector
5466.000	34.63	9.06	34.21	39.50	48.98	54.00	5.02	Average
5470.000	34.63	9.06	34.21	39.76	49.24	54.00	4.76	Average
@ 5613.500	34.43	9.14	34.25	77.97	87.29	---	---	Average

Remark: The “@” means fundamental frequency, it is ignored in this section.

Mode	802.11ax-HE160	U-NII Band	2C
		Frequency	TX 5570MHz

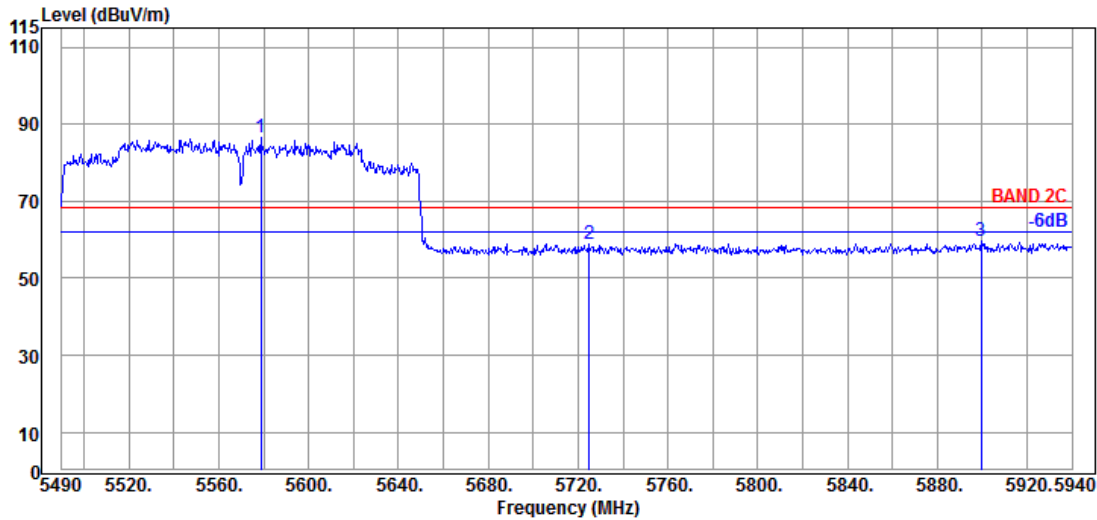

Antenna at Horizontal Polarization

Emission Frequency (MHz)	Antenna Factor (dB/m)	Cable Loss (dB)	Preamp Gain (dB)	Read Level (dBμV)	Emission Level (dBμV/m)	Limits (dBμV/m)	Margin (dB)	Detector
@ 5578.650	34.50	9.12	34.24	77.19	86.57	---	---	Peak
5724.900	34.90	9.20	34.30	49.12	58.92	68.20	9.28	Peak
5899.500	35.80	9.28	34.39	48.92	59.61	68.20	8.59	Peak

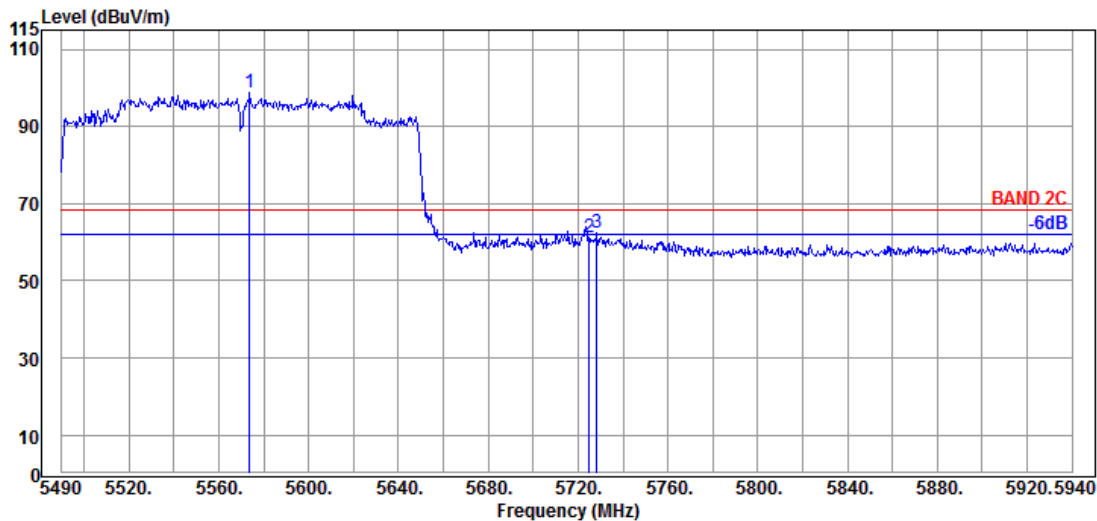

Antenna at Vertical Polarization

Emission Frequency (MHz)	Antenna Factor (dB/m)	Cable Loss (dB)	Preamp Gain (dB)	Read Level (dBμV)	Emission Level (dBμV/m)	Limits (dBμV/m)	Margin (dB)	Detector
@ 5573.700	34.60	9.11	34.23	89.42	98.90	---	---	Peak
5724.900	34.90	9.20	34.30	51.40	61.20	68.20	7.00	Peak
5728.500	34.90	9.20	34.31	52.52	62.31	68.20	5.89	Peak

Remark: The “@” means fundamental frequency, it is ignored in this section.

Mode	802.11ax-HE20	U-NII Band	1
RU Configuration	26/0	Frequency	TX 5180MHz

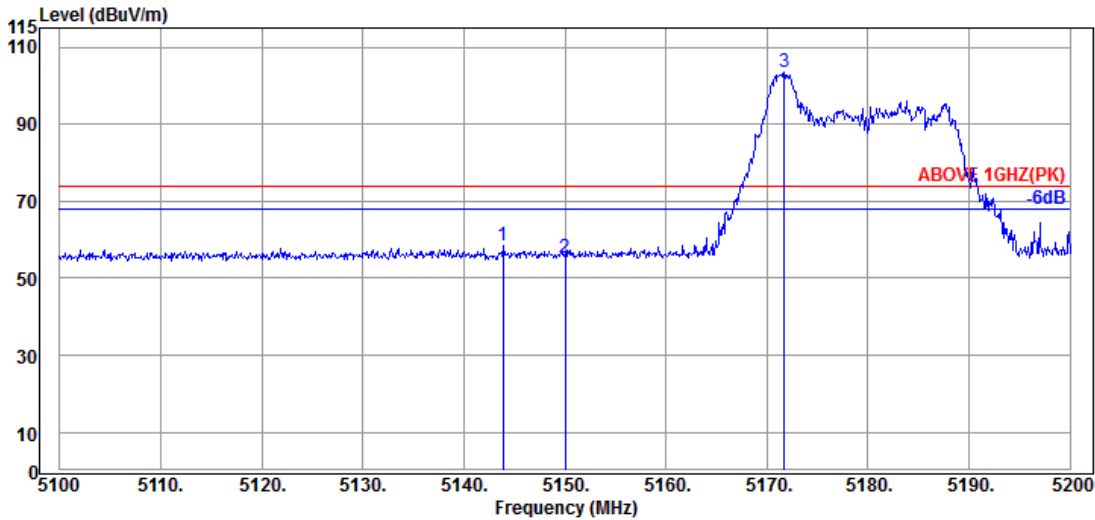

Antenna at Horizontal Polarization

Emission Frequency (MHz)	Antenna Factor (dB/m)	Cable Loss (dB)	Preamp Gain (dB)	Read Level (dBμV)	Emission Level (dBUV/m)	Limits (dBUV/m)	Margin (dB)	Detector
5143.900	34.50	8.88	34.34	49.36	58.40	74.00	15.60	Peak
5150.000	34.50	8.88	34.34	46.30	55.34	74.00	18.66	Peak
@ 5171.700	34.63	8.90	34.33	94.40	103.60	---	---	Peak

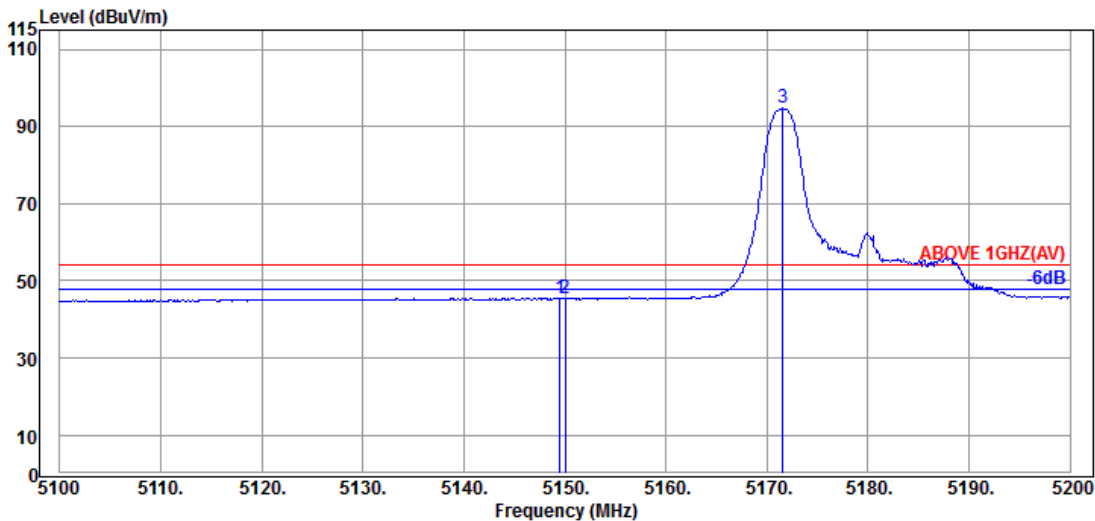

Antenna at Horizontal Polarization

Emission Frequency (MHz)	Antenna Factor (dB/m)	Cable Loss (dB)	Preamp Gain (dB)	Read Level (dBμV)	Emission Level (dBUV/m)	Limits (dBUV/m)	Margin (dB)	Detector
5149.500	34.50	8.88	34.34	36.48	45.52	54.00	8.48	Average
5150.000	34.50	8.88	34.34	36.29	45.33	54.00	8.67	Average
@ 5171.600	34.63	8.90	34.33	85.63	94.83	---	---	Average

Remark: The “@” means fundamental frequency, it is ignored in this section.

Mode	802.11ax-HE20	U-NII Band	1
RU Configuration	26/0	Frequency	TX 5180MHz

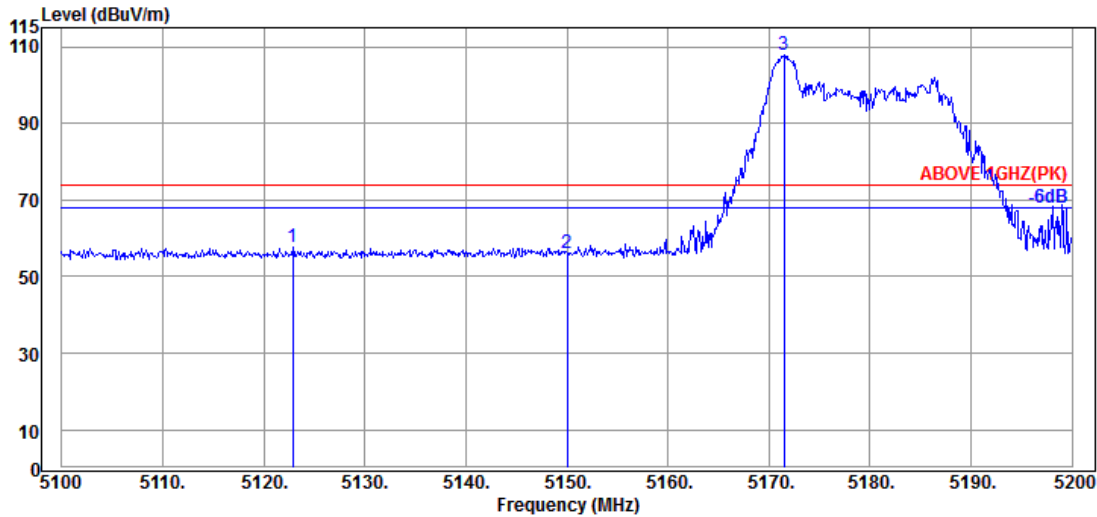

Antenna at Vertical Polarization

Emission Frequency (MHz)	Antenna Factor (dB/m)	Cable Loss (dB)	Preamplifier Gain (dB)	Read Level (dBμV)	Emission Level (dBμV/m)	Limits (dBμV/m)	Margin (dB)	Detector
5122.900	34.30	8.87	34.34	48.88	57.71	74.00	16.29	Peak
5150.000	34.50	8.88	34.34	47.09	56.13	74.00	17.87	Peak
@ 5171.500	34.57	8.89	34.33	98.62	107.75	---	---	Peak

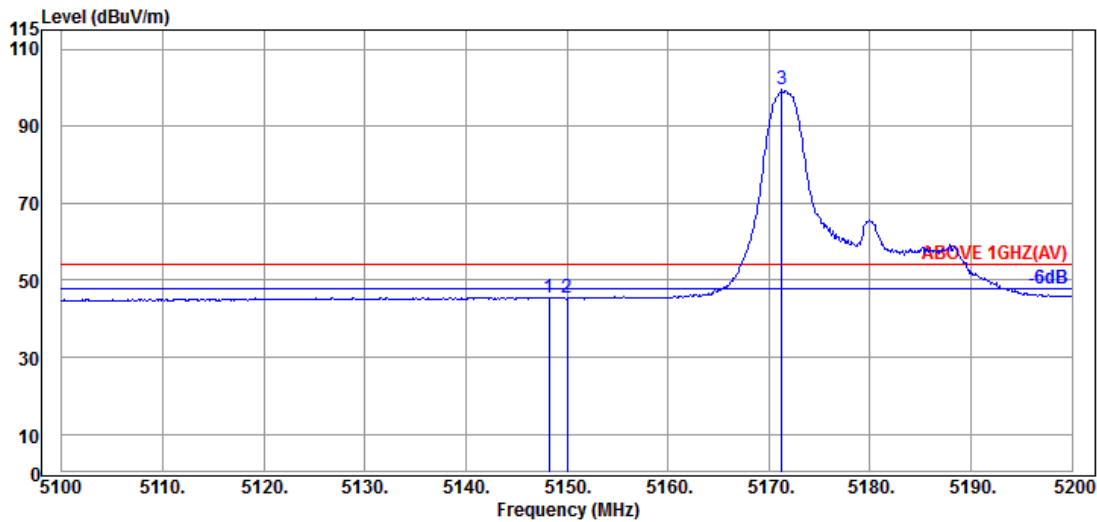

Antenna at Vertical Polarization

Emission Frequency (MHz)	Antenna Factor (dB/m)	Cable Loss (dB)	Preamplifier Gain (dB)	Read Level (dBμV)	Emission Level (dBμV/m)	Limits (dBμV/m)	Margin (dB)	Detector
5148.200	34.50	8.88	34.34	36.51	45.55	54.00	8.45	Average
5150.000	34.50	8.88	34.34	36.23	45.27	54.00	8.73	Average
@ 5171.300	34.57	8.89	34.33	90.34	99.47	---	---	Average

Remark: The “@” means fundamental frequency, it is ignored in this section.

Mode	802.11ax-HE20	U-NII Band	1
RU Configuration	52/37	Frequency	TX 5180MHz

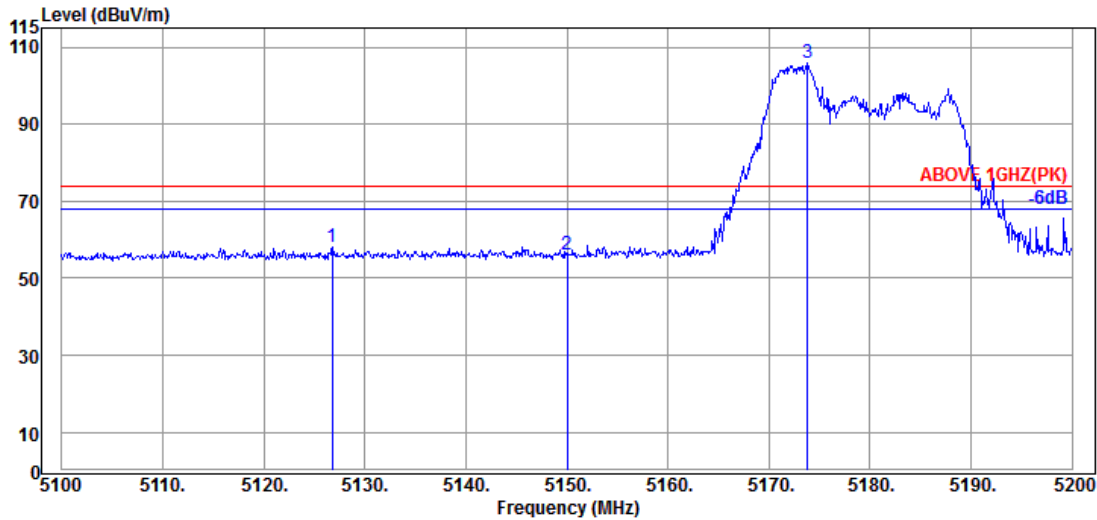

Antenna at Horizontal Polarization

Emission Frequency (MHz)	Antenna Factor (dB/m)	Cable Loss (dB)	Preamp Gain (dB)	Read Level (dBμV)	Emission Level (dBμV/m)	Limits (dBμV/m)	Margin (dB)	Detector
5126.800	34.30	8.87	34.34	49.41	58.24	74.00	15.76	Peak
5150.000	34.50	8.88	34.34	47.25	56.29	74.00	17.71	Peak
@ 5173.800	34.63	8.90	34.32	96.71	105.92	---	---	Peak

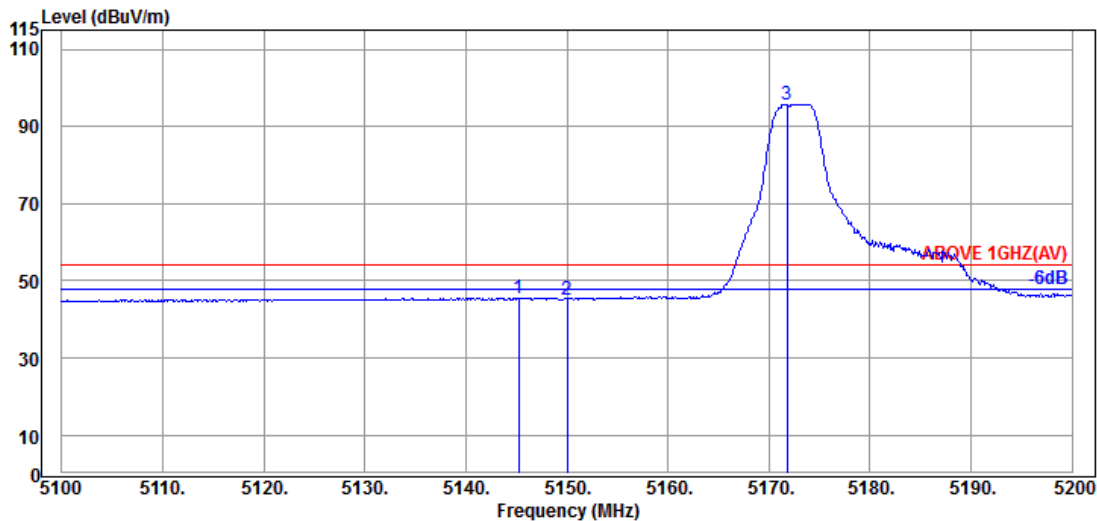

Antenna at Horizontal Polarization

Emission Frequency (MHz)	Antenna Factor (dB/m)	Cable Loss (dB)	Preamp Gain (dB)	Read Level (dBμV)	Emission Level (dBμV/m)	Limits (dBμV/m)	Margin (dB)	Detector
5145.200	34.50	8.88	34.34	36.49	45.53	54.00	8.47	Average
5150.000	34.50	8.88	34.34	36.18	45.22	54.00	8.78	Average
@ 5171.800	34.63	8.90	34.33	86.58	95.78	---	---	Average

Remark: The “@” means fundamental frequency, it is ignored in this section.

Mode	802.11ax-HE20	U-NII Band	1
RU Configuration	52/37	Frequency	TX 5180MHz

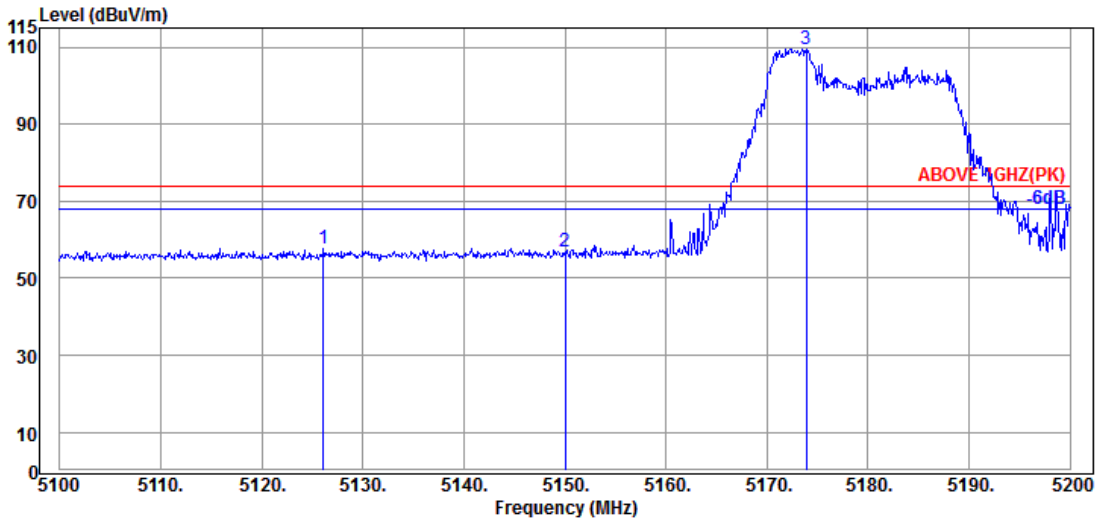

Antenna at Vertical Polarization

Emission Frequency (MHz)	Antenna Factor (dB/m)	Cable Loss (dB)	Preamp Gain (dB)	Read Level (dBμV)	Emission Level (dBμV/m)	Limits (dBμV/m)	Margin (dB)	Detector
5126.100	34.30	8.87	34.34	49.05	57.88	74.00	16.12	Peak
5150.000	34.50	8.88	34.34	47.78	56.82	74.00	17.18	Peak
@ 5173.900	34.63	8.90	34.32	100.44	109.65	---	---	Peak

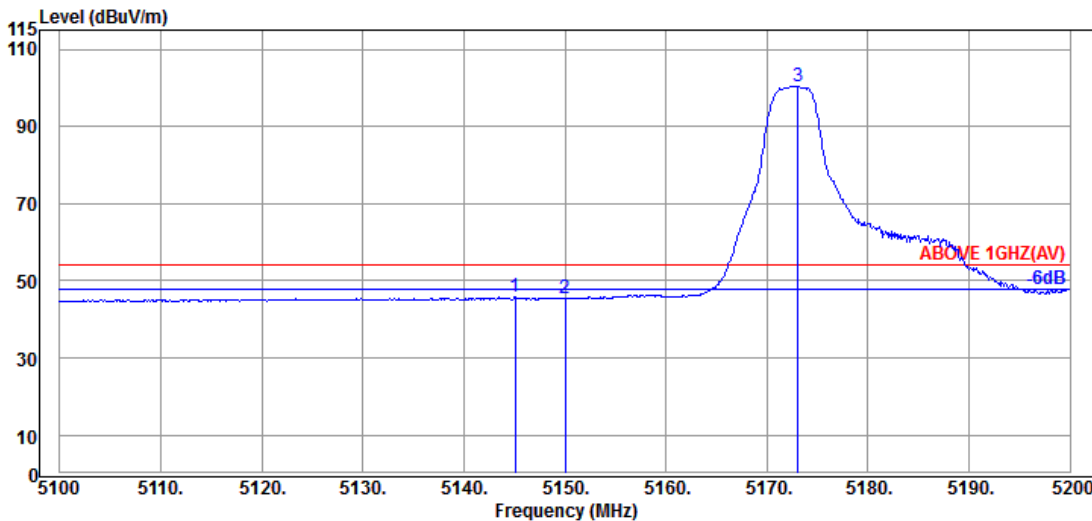

Antenna at Vertical Polarization

Emission Frequency (MHz)	Antenna Factor (dB/m)	Cable Loss (dB)	Preamp Gain (dB)	Read Level (dBμV)	Emission Level (dBμV/m)	Limits (dBμV/m)	Margin (dB)	Detector
5145.100	34.50	8.88	34.34	36.67	45.71	54.00	8.29	Average
5150.000	34.50	8.88	34.34	36.53	45.57	54.00	8.43	Average
@ 5173.100	34.63	8.90	34.33	91.25	100.45	---	---	Average

Remark: The “@” means fundamental frequency, it is ignored in this section.

Mode	802.11ax-HE20	U-NII Band	1
RU Configuration	106/53	Frequency	TX 5180MHz

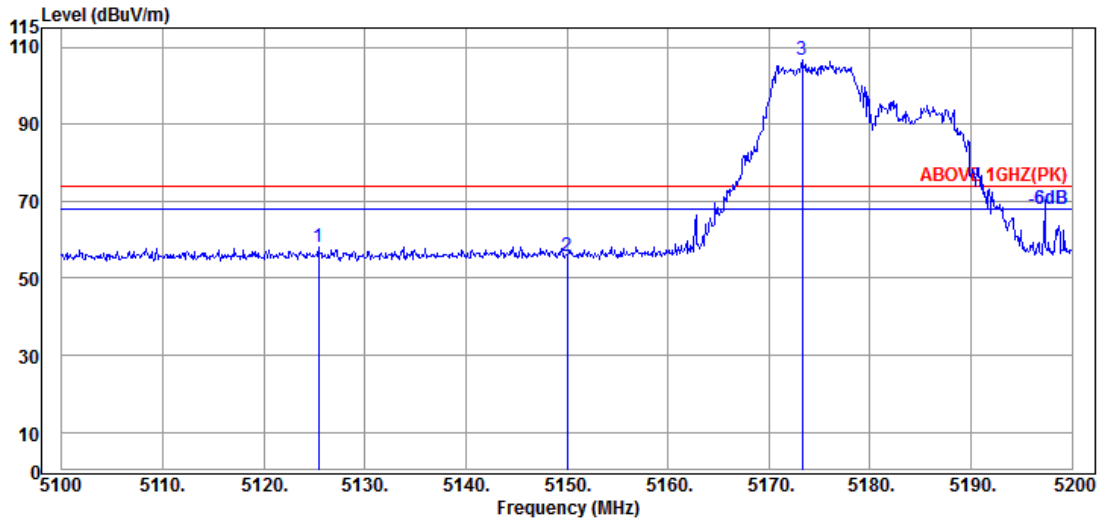

Antenna at Horizontal Polarization

Emission Frequency (MHz)	Antenna Factor (dB/m)	Cable Loss (dB)	Preamp Gain (dB)	Read Level (dBμV)	Emission Level (dBμV/m)	Limits (dBμV/m)	Margin (dB)	Detector
5125.400	34.30	8.87	34.34	49.27	58.10	74.00	15.90	Peak
5150.000	34.50	8.88	34.34	46.66	55.70	74.00	18.30	Peak
@ 5173.300	34.63	8.90	34.32	97.42	106.63	---	---	Peak

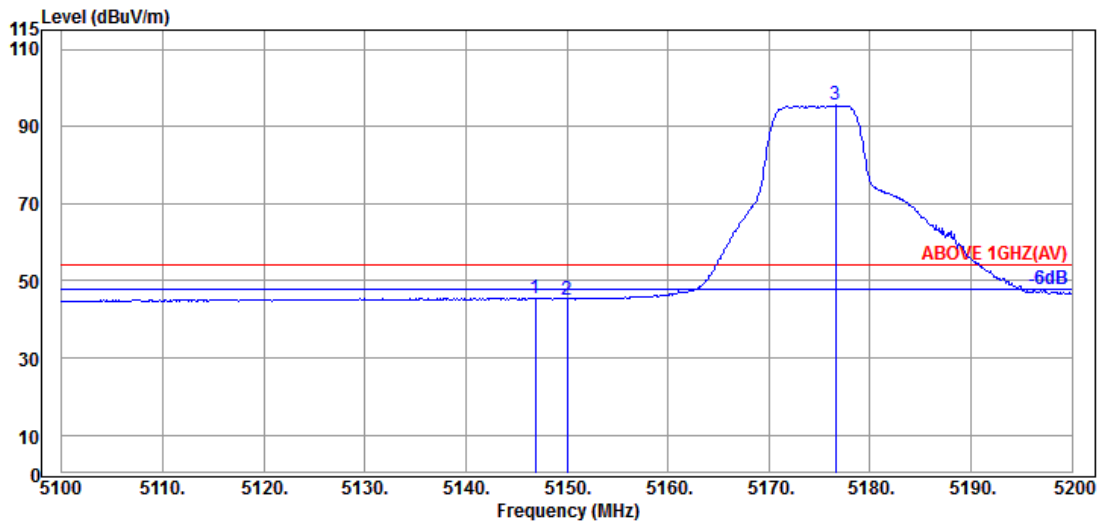

Antenna at Horizontal Polarization

Emission Frequency (MHz)	Antenna Factor (dB/m)	Cable Loss (dB)	Preamp Gain (dB)	Read Level (dBμV)	Emission Level (dBμV/m)	Limits (dBμV/m)	Margin (dB)	Detector
5146.900	34.50	8.88	34.34	36.57	45.61	54.00	8.39	Average
5150.000	34.50	8.88	34.34	36.16	45.20	54.00	8.80	Average
@ 5176.600	34.63	8.90	34.32	86.30	95.51	---	---	Average

Remark: The “@” means fundamental frequency, it is ignored in this section.

Mode	802.11ax-HE20	U-NII Band	1
RU Configuration	106/53	Frequency	TX 5180MHz

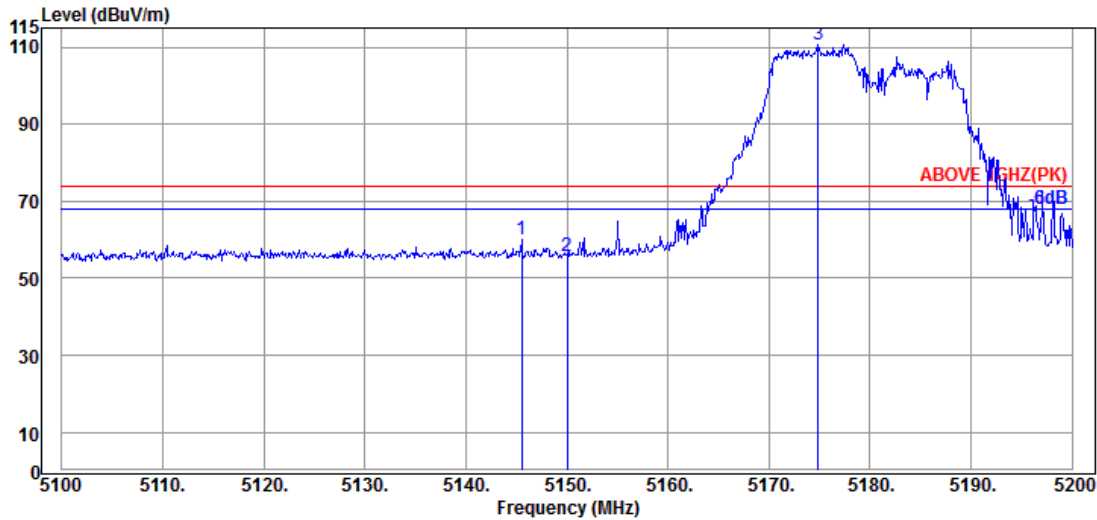

Antenna at Vertical Polarization

Emission Frequency (MHz)	Antenna Factor (dB/m)	Cable Loss (dB)	Preamp Gain (dB)	Read Level (dBμV)	Emission Level (dBμV/m)	Limits (dBμV/m)	Margin (dB)	Detector
5145.500	34.50	8.88	34.34	51.01	60.05	74.00	13.95	Peak
5150.000	34.50	8.88	34.34	46.81	55.85	74.00	18.15	Peak
@ 5174.900	34.63	8.90	34.32	101.50	110.71	---	---	Peak

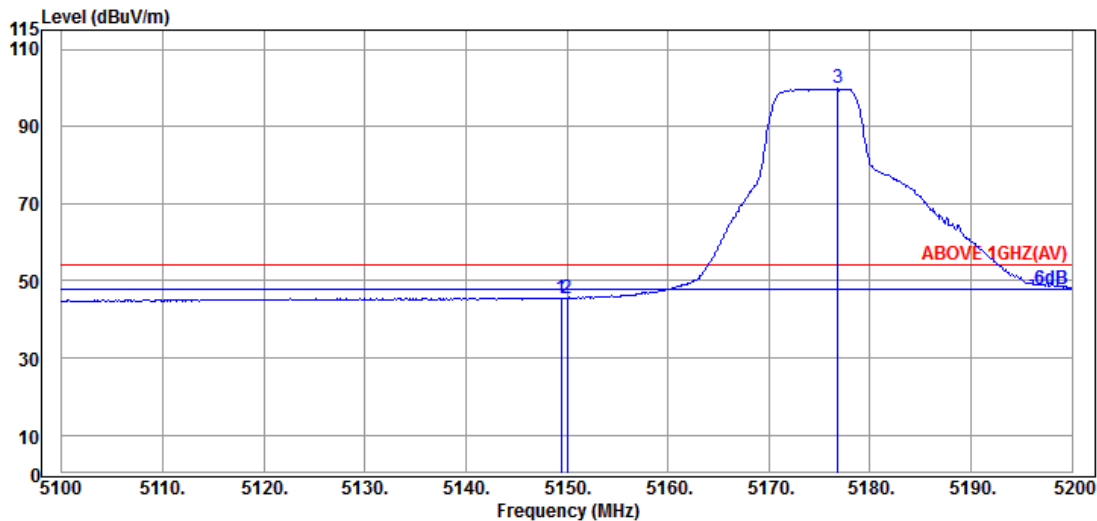

Antenna at Vertical Polarization

Emission Frequency (MHz)	Antenna Factor (dB/m)	Cable Loss (dB)	Preamp Gain (dB)	Read Level (dBμV)	Emission Level (dBμV/m)	Limits (dBμV/m)	Margin (dB)	Detector
5149.400	34.50	8.88	34.34	36.58	45.62	54.00	8.38	Average
5150.000	34.50	8.88	34.34	36.49	45.53	54.00	8.47	Average
@ 5176.800	34.63	8.90	34.32	90.62	99.83	---	---	Average

Remark: The “@” means fundamental frequency, it is ignored in this section.

Mode	802.11ax-HE20	U-NII Band	2A
RU Configuration	26/8	Frequency	TX 5320MHz

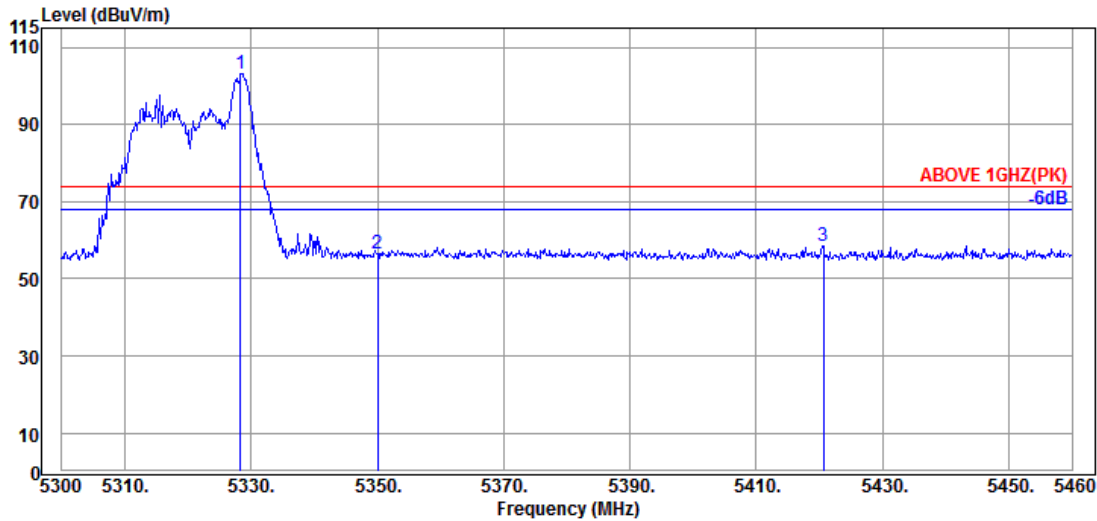

Antenna at Horizontal Polarization

Emission Frequency (MHz)	Antenna Factor (dB/m)	Cable Loss (dB)	Preamplifier Gain (dB)	Read Level (dBμV)	Emission Level (dBμV/m)	Limits (dBμV/m)	Margin (dB)	Detector
@ 5328.320	34.73	8.99	34.26	93.82	103.28	---	---	Peak
5350.080	34.90	8.99	34.26	46.68	56.31	74.00	17.69	Peak
5420.640	34.70	9.04	34.23	49.10	58.61	74.00	15.39	Peak

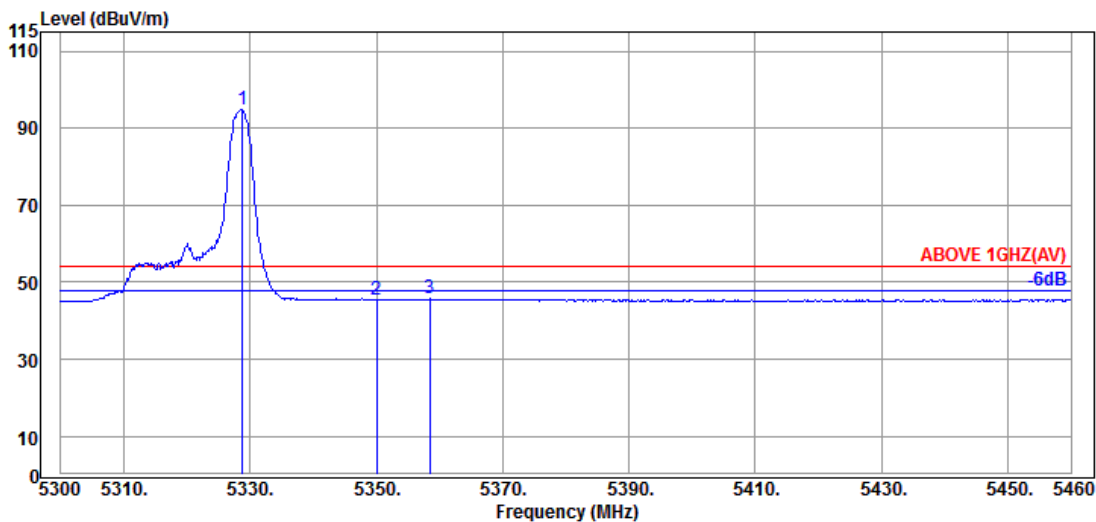

Antenna at Horizontal Polarization

Emission Frequency (MHz)	Antenna Factor (dB/m)	Cable Loss (dB)	Preamplifier Gain (dB)	Read Level (dBμV)	Emission Level (dBμV/m)	Limits (dBμV/m)	Margin (dB)	Detector
@ 5328.800	34.73	8.99	34.26	85.40	94.86	---	---	Average
5350.080	34.90	8.99	34.26	35.83	45.46	54.00	8.54	Average
5358.400	34.87	9.00	34.26	36.05	45.66	54.00	8.34	Average

Remark: The “@” means fundamental frequency, it is ignored in this section.

Mode	802.11ax-HE20	U-NII Band	2A
RU Configuration	26/8	Frequency	TX 5320MHz

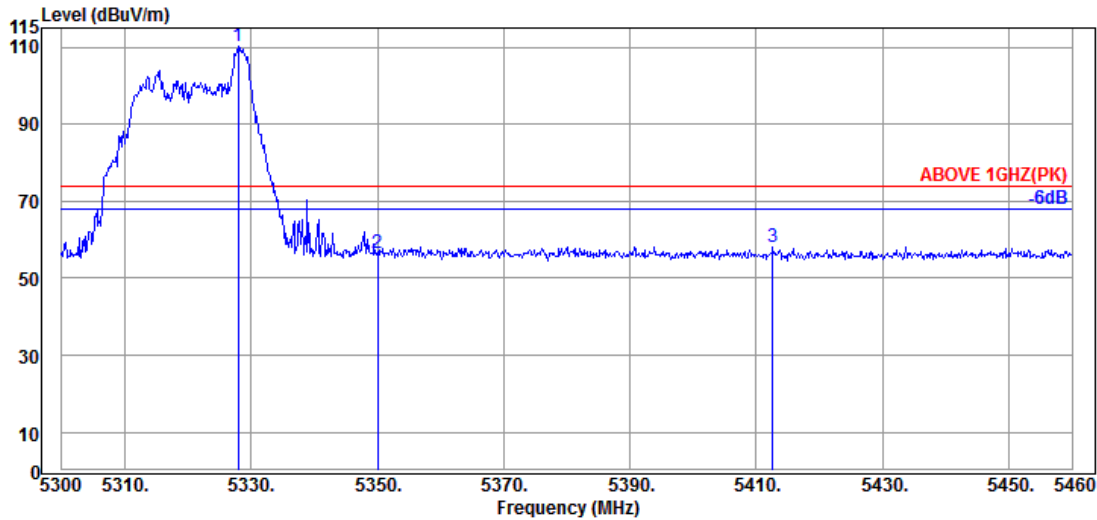

Antenna at Vertical Polarization

Emission Frequency (MHz)	Antenna Factor (dB/m)	Cable Loss (dB)	Preamp Gain (dB)	Read Level (dBμV)	Emission Level (dBμV/m)	Limits (dBμV/m)	Margin (dB)	Detector
@ 5328.000	34.73	8.99	34.27	100.73	110.18	---	---	Peak
5350.080	34.90	8.99	34.26	46.81	56.44	74.00	17.56	Peak
5412.640	34.75	9.03	34.23	48.73	58.28	74.00	15.72	Peak

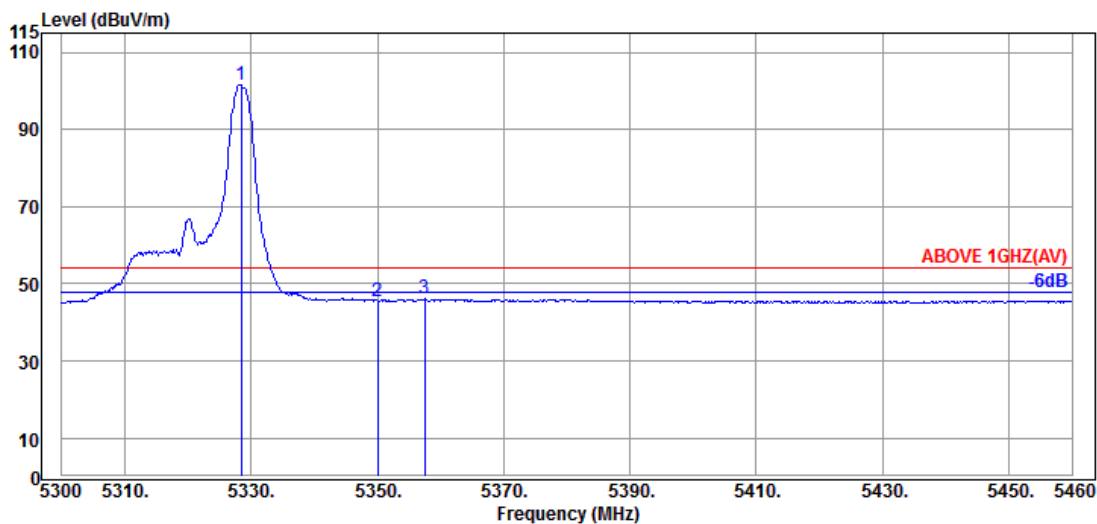

Antenna at Vertical Polarization

Emission Frequency (MHz)	Antenna Factor (dB/m)	Cable Loss (dB)	Preamp Gain (dB)	Read Level (dBμV)	Emission Level (dBμV/m)	Limits (dBμV/m)	Margin (dB)	Detector
@ 5328.480	34.73	8.99	34.26	92.14	101.60	---	---	Average
5350.080	34.90	8.99	34.26	36.00	45.63	54.00	8.37	Average
5357.440	34.87	9.00	34.26	36.49	46.10	54.00	7.90	Average

Remark: The “@” means fundamental frequency, it is ignored in this section.

Mode	802.11ax-HE20	U-NII Band	2A
RU Configuration	52/40	Frequency	TX 5320MHz

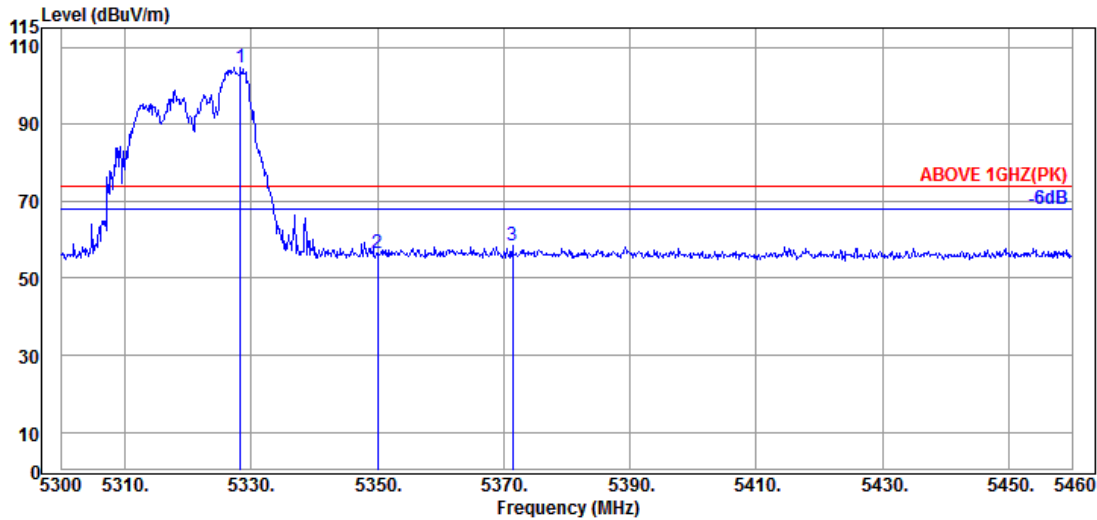

Antenna at Horizontal Polarization

Emission Frequency (MHz)	Antenna Factor (dB/m)	Cable Loss (dB)	Preamplifier Gain (dB)	Read Level (dBμV)	Emission Level (dBμV/m)	Limits (dBμV/m)	Margin (dB)	Detector
@ 5328.320	34.73	8.99	34.26	95.14	104.60	---	---	Peak
5350.080	34.90	8.99	34.26	46.77	56.40	74.00	17.60	Peak
5371.360	34.83	9.01	34.25	48.87	58.46	74.00	15.54	Peak

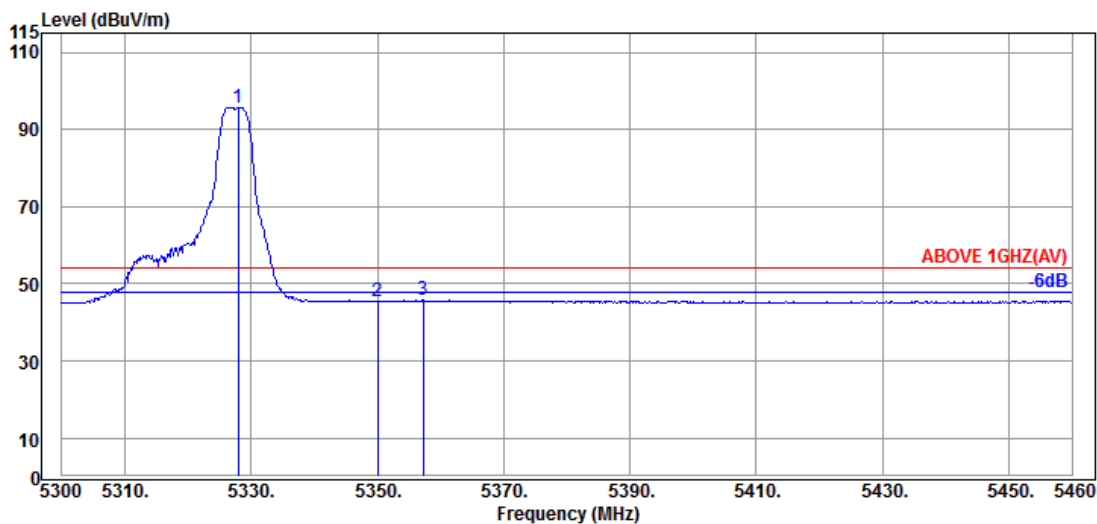

Antenna at Horizontal Polarization

Emission Frequency (MHz)	Antenna Factor (dB/m)	Cable Loss (dB)	Preamplifier Gain (dB)	Read Level (dBμV)	Emission Level (dBμV/m)	Limits (dBμV/m)	Margin (dB)	Detector
@ 5328.000	34.73	8.99	34.27	86.34	95.79	---	---	Average
5350.080	34.90	8.99	34.26	35.77	45.40	54.00	8.60	Average
5357.280	34.87	9.00	34.26	36.21	45.82	54.00	8.18	Average

Remark: The “@” means fundamental frequency, it is ignored in this section.

Mode	802.11ax-HE20	U-NII Band	2A
RU Configuration	52/40	Frequency	TX 5320MHz

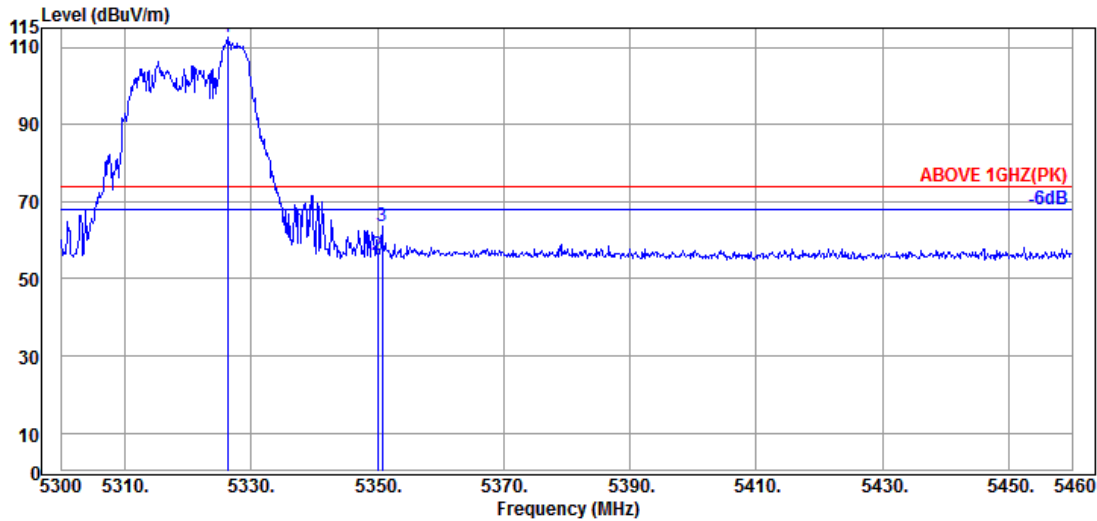

Antenna at Vertical Polarization

Emission Frequency (MHz)	Antenna Factor (dB/m)	Cable Loss (dB)	Preamplifier Gain (dB)	Read Level (dBμV)	Emission Level (dBμV/m)	Limits (dBμV/m)	Margin (dB)	Detector
@ 5326.240	34.73	8.99	34.27	103.01	112.46	---	---	Peak
5350.080	34.90	8.99	34.26	46.49	56.12	74.00	17.88	Peak
5350.720	34.90	8.99	34.26	54.07	63.70	74.00	10.30	Peak

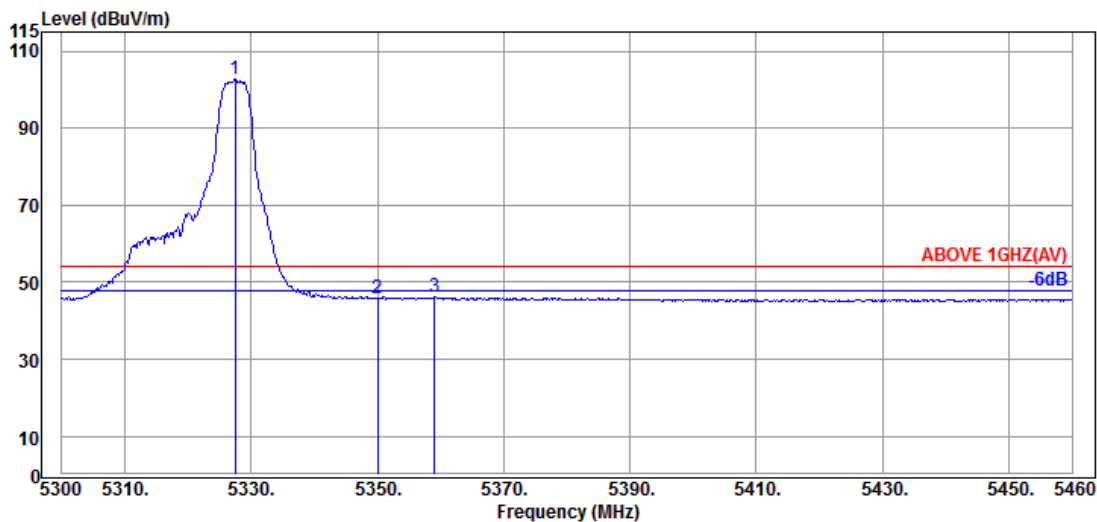

Antenna at Vertical Polarization

Emission Frequency (MHz)	Antenna Factor (dB/m)	Cable Loss (dB)	Preamplifier Gain (dB)	Read Level (dBμV)	Emission Level (dBμV/m)	Limits (dBμV/m)	Margin (dB)	Detector
@ 5327.520	34.73	8.99	34.27	93.37	102.82	---	---	Average
5350.080	34.90	8.99	34.26	36.25	45.88	54.00	8.12	Average
5359.040	34.87	9.00	34.26	36.52	46.13	54.00	7.87	Average

Remark: The “@” means fundamental frequency, it is ignored in this section.

Mode	802.11ax-HE20	U-NII Band	2A
RU Configuration	106/54	Frequency	TX 5320MHz

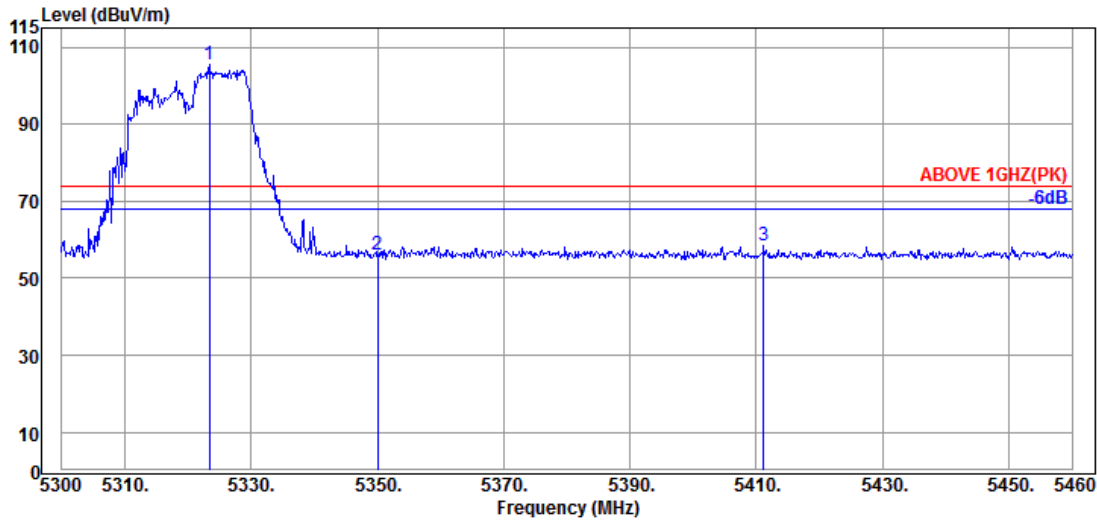

Antenna at Horizontal Polarization

Emission Frequency (MHz)	Antenna Factor (dB/m)	Cable Loss (dB)	Preamp Gain (dB)	Read Level (dBμV)	Emission Level (dBμV/m)	Limits (dBμV/m)	Margin (dB)	Detector
@ 5323.360	34.73	8.99	34.27	96.14	105.59	---	---	Peak
5350.080	34.90	8.99	34.26	46.51	56.14	74.00	17.86	Peak
5411.200	34.75	9.03	34.23	48.77	58.32	74.00	15.68	Peak

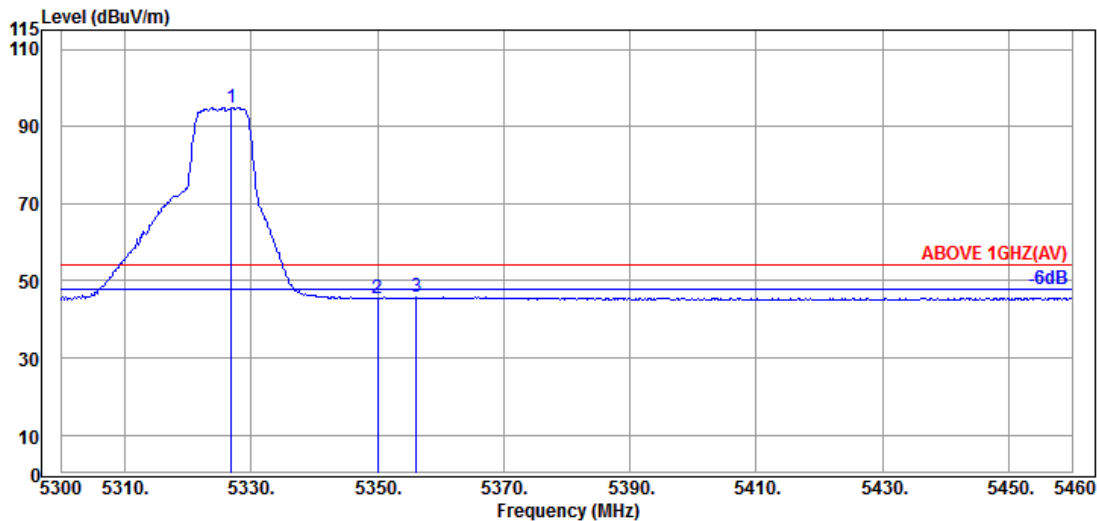

Antenna at Horizontal Polarization

Emission Frequency (MHz)	Antenna Factor (dB/m)	Cable Loss (dB)	Preamp Gain (dB)	Read Level (dBμV)	Emission Level (dBμV/m)	Limits (dBμV/m)	Margin (dB)	Detector
@ 5326.880	34.73	8.99	34.27	85.38	94.83	---	---	Average
5350.080	34.90	8.99	34.26	35.72	45.35	54.00	8.65	Average
5356.160	34.87	9.00	34.26	36.09	45.70	54.00	8.30	Average

Remark: The “@” means fundamental frequency, it is ignored in this section.

Mode	802.11ax-HE20	U-NII Band	2A
RU Configuration	106/54	Frequency	TX 5320MHz

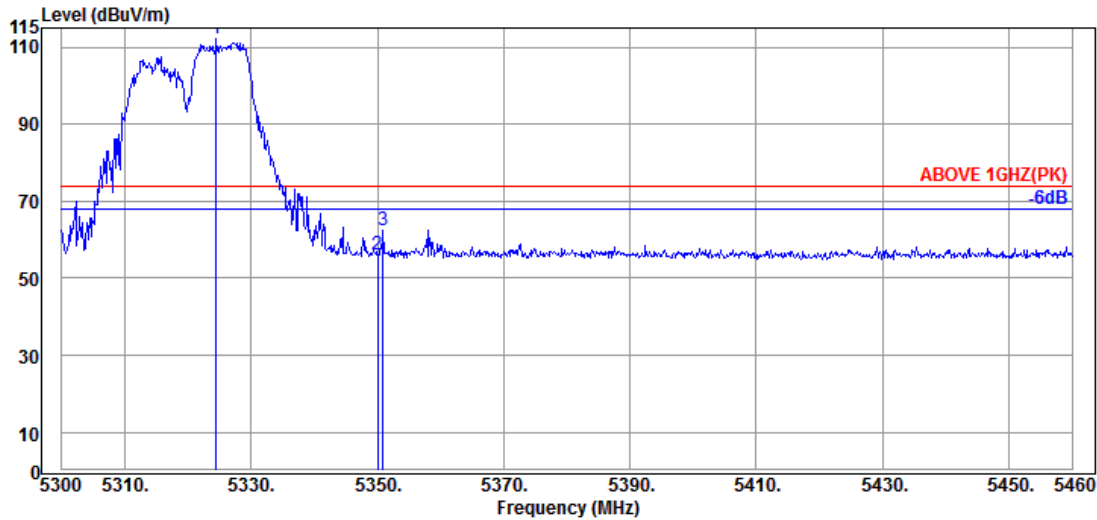

Antenna at Vertical Polarization

Emission Frequency (MHz)	Antenna Factor (dB/m)	Cable Loss (dB)	Preamp Gain (dB)	Read Level (dBμV)	Emission Level (dBμV/m)	Limits (dBμV/m)	Margin (dB)	Detector
@ 5324.480	34.73	8.99	34.27	102.88	112.33	---	---	Peak
5350.080	34.90	8.99	34.26	46.61	56.24	74.00	17.76	Peak
5350.880	34.90	8.99	34.26	52.68	62.31	74.00	11.69	Peak

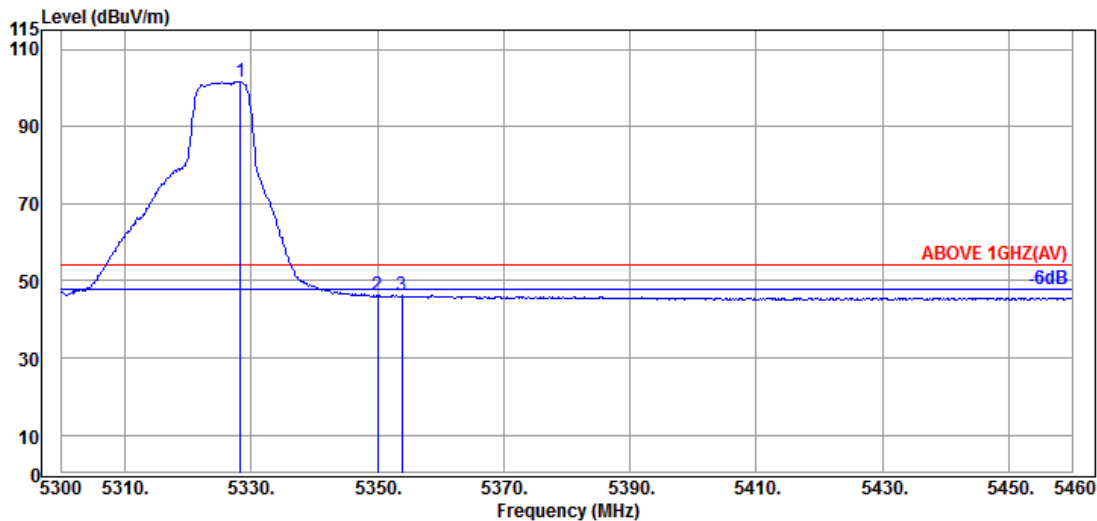

Antenna at Vertical Polarization

Emission Frequency (MHz)	Antenna Factor (dB/m)	Cable Loss (dB)	Preamp Gain (dB)	Read Level (dBμV)	Emission Level (dBμV/m)	Limits (dBμV/m)	Margin (dB)	Detector
@ 5328.320	34.73	8.99	34.26	92.14	101.60	---	---	Average
5350.080	34.90	8.99	34.26	36.53	46.16	54.00	7.84	Average
5353.920	34.90	8.99	34.26	36.54	46.17	54.00	7.83	Average

Remark: The “@” means fundamental frequency, it is ignored in this section.

Mode	802.11ax-HE20	U-NII Band	2C
RU Configuration	26/0	Frequency	TX 5500MHz

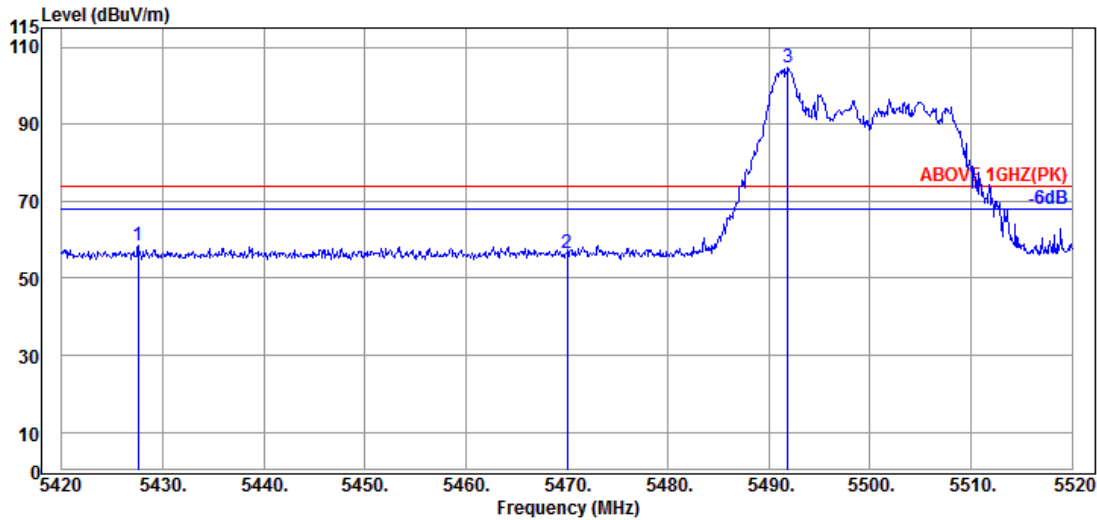

Antenna at Horizontal Polarization

Emission Frequency (MHz)	Antenna Factor (dB/m)	Cable Loss (dB)	Preamp Gain (dB)	Read Level (dBμV)	Emission Level (dBμV/m)	Limits (dBμV/m)	Margin (dB)	Detector
5427.600	34.70	9.04	34.23	48.85	58.36	74.00	15.64	Peak
5470.000	34.63	9.06	34.21	47.03	56.51	74.00	17.49	Peak
@ 5491.900	34.67	9.07	34.20	95.14	104.68	---	---	Peak

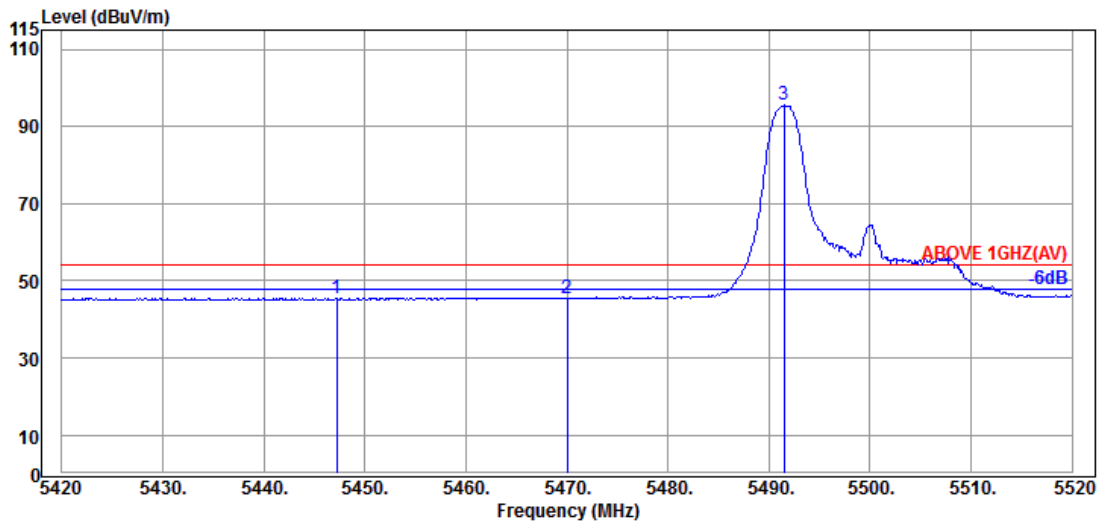

Antenna at Horizontal Polarization

Emission Frequency (MHz)	Antenna Factor (dB/m)	Cable Loss (dB)	Preamp Gain (dB)	Read Level (dBμV)	Emission Level (dBμV/m)	Limits (dBμV/m)	Margin (dB)	Detector
5447.200	34.65	9.04	34.22	36.12	45.59	54.00	8.41	Average
5470.000	34.63	9.06	34.21	35.94	45.42	54.00	8.58	Average
@ 5491.500	34.67	9.07	34.20	86.12	95.66	---	---	Average

Remark: The “@” means fundamental frequency, it is ignored in this section.

Mode	802.11ax-HE20	U-NII Band	2C
RU Configuration	26/0	Frequency	TX 5500MHz

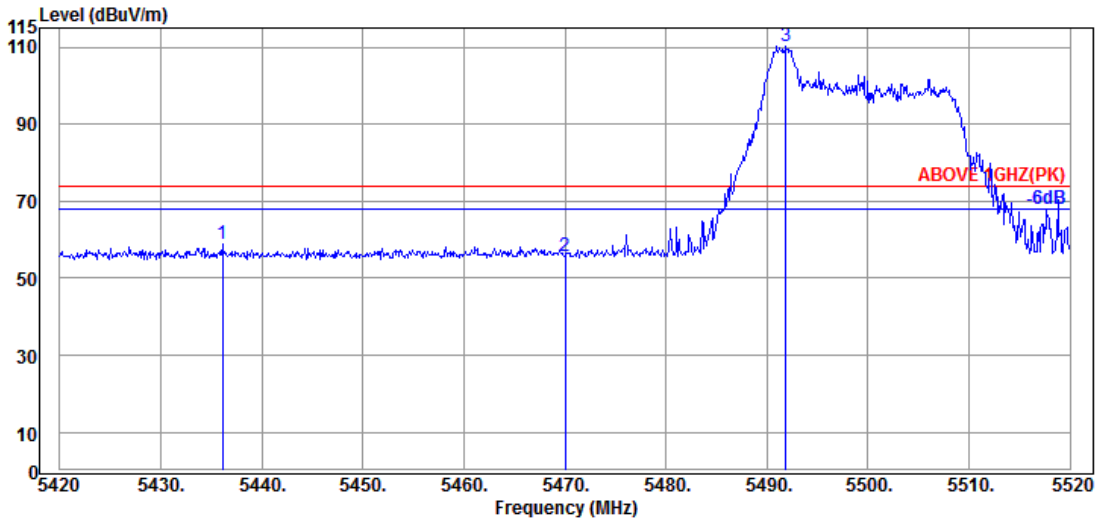

Antenna at Vertical Polarization

Emission Frequency (MHz)	Antenna Factor (dB/m)	Cable Loss (dB)	Preamp Gain (dB)	Read Level (dBμV)	Emission Level (dBμV/m)	Limits (dBμV/m)	Margin (dB)	Detector
5436.100	34.65	9.04	34.22	49.38	58.85	74.00	15.15	Peak
5470.000	34.63	9.06	34.21	46.35	55.83	74.00	18.17	Peak
@ 5491.900	34.67	9.07	34.20	100.89	110.43	---	---	Peak

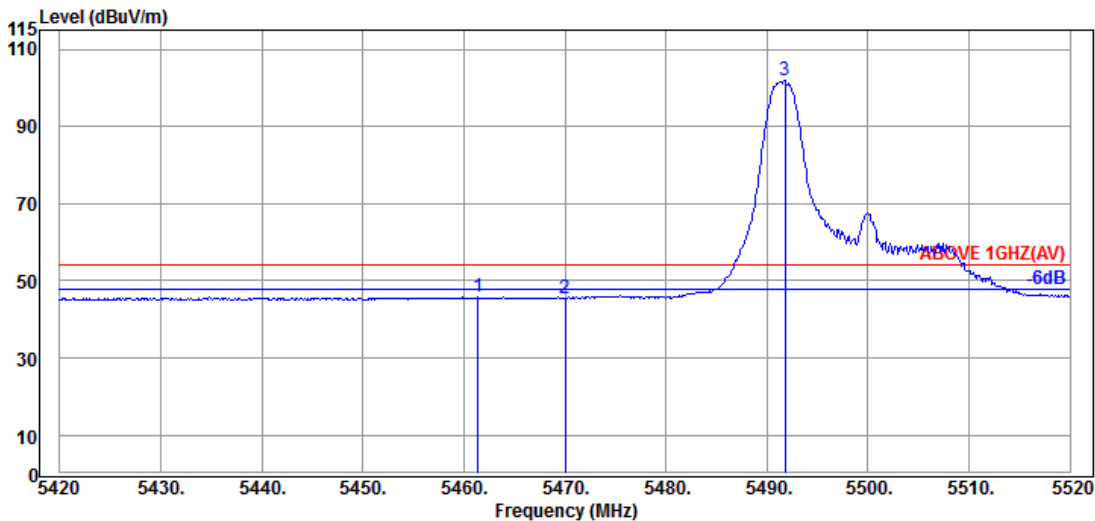

Antenna at Vertical Polarization

Emission Frequency (MHz)	Antenna Factor (dB/m)	Cable Loss (dB)	Preamp Gain (dB)	Read Level (dBμV)	Emission Level (dBμV/m)	Limits (dBμV/m)	Margin (dB)	Detector
5461.400	34.60	9.05	34.21	36.23	45.67	54.00	8.33	Average
5470.000	34.63	9.06	34.21	35.95	45.43	54.00	8.57	Average
@ 5491.800	34.67	9.07	34.20	92.49	102.03	---	---	Average

Remark: The “@” means fundamental frequency, it is ignored in this section..

Mode	802.11ax-HE20	U-NII Band	2C
RU Configuration	52/37	Frequency	TX 5500MHz

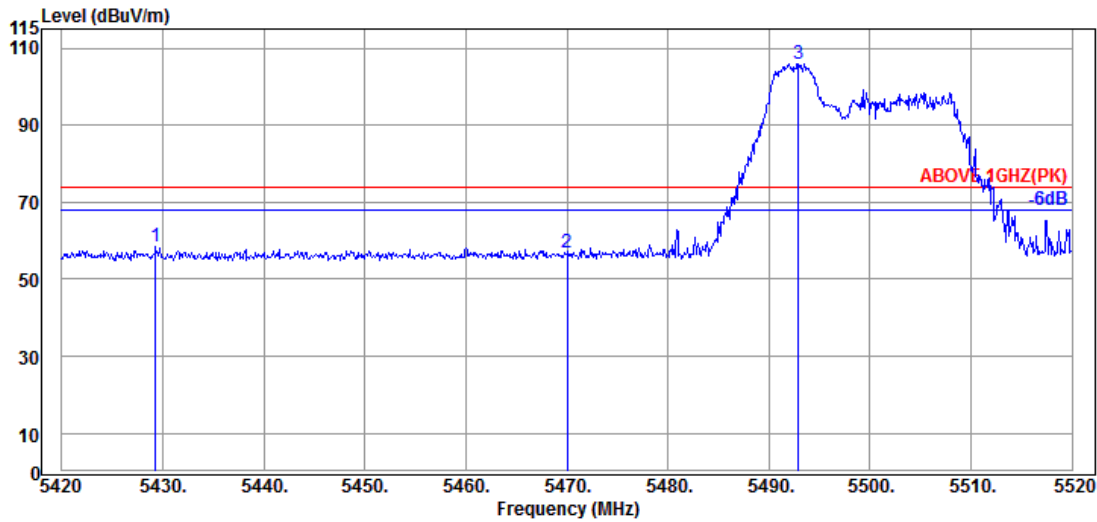

Antenna at Horizontal Polarization

Emission Frequency (MHz)	Antenna Factor (dB/m)	Cable Loss (dB)	Preamplifier Gain (dB)	Read Level (dBμV)	Emission Level (dBμV/m)	Limits (dBμV/m)	Margin (dB)	Detector
5429.300	34.70	9.04	34.23	48.89	58.40	74.00	15.60	Peak
5470.000	34.63	9.06	34.21	47.32	56.80	74.00	17.20	Peak
@ 5492.900	34.67	9.07	34.20	96.50	106.04	---	---	Peak

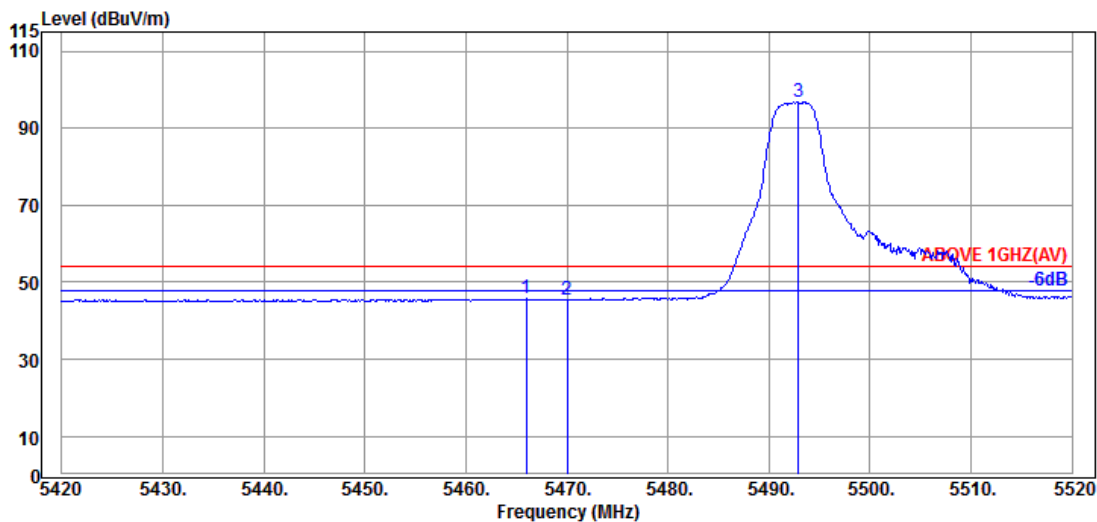

Antenna at Horizontal Polarization

Emission Frequency (MHz)	Antenna Factor (dB/m)	Cable Loss (dB)	Preamplifier Gain (dB)	Read Level (dBμV)	Emission Level (dBμV/m)	Limits (dBμV/m)	Margin (dB)	Detector
5466.000	34.63	9.06	34.21	36.19	45.67	54.00	8.33	Average
5470.000	34.63	9.06	34.21	35.98	45.46	54.00	8.54	Average
@ 5492.900	34.67	9.07	34.20	87.27	96.81	---	---	Average

Remark: The “@” means fundamental frequency, it is ignored in this section.

Mode	802.11ax-HE20	U-NII Band	2C
RU Configuration	52/37	Frequency	TX 5500MHz

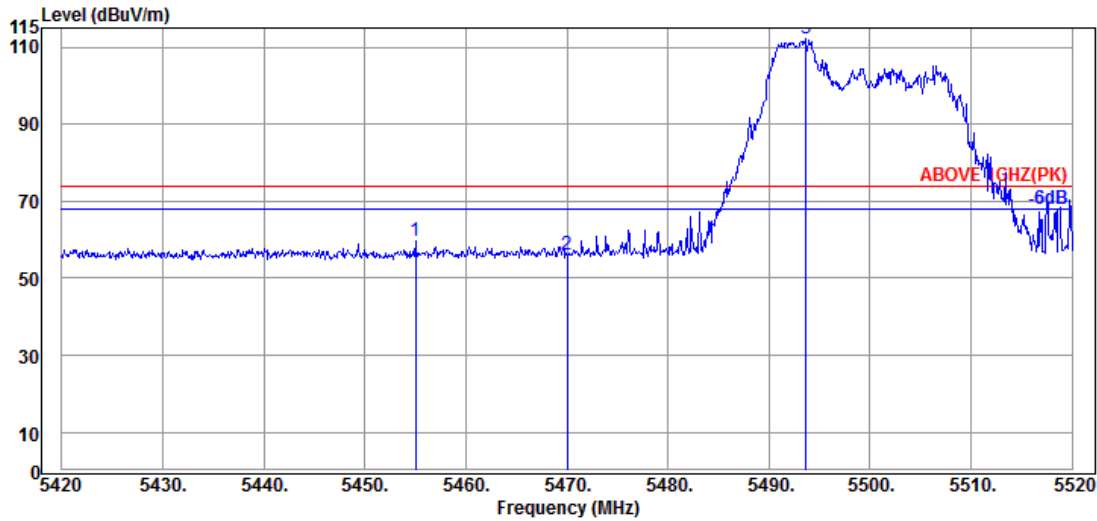

Antenna at Vertical Polarization

Emission Frequency (MHz)	Antenna Factor (dB/m)	Cable Loss (dB)	Preamplifier Gain (dB)	Read Level (dBμV)	Emission Level (dBμV/m)	Limits (dBμV/m)	Margin (dB)	Detector
5455.000	34.60	9.05	34.21	50.20	59.64	74.00	14.36	Peak
5470.000	34.63	9.06	34.21	46.80	56.28	74.00	17.72	Peak
@ 5493.700	34.67	9.07	34.20	102.53	112.07	---	---	Peak

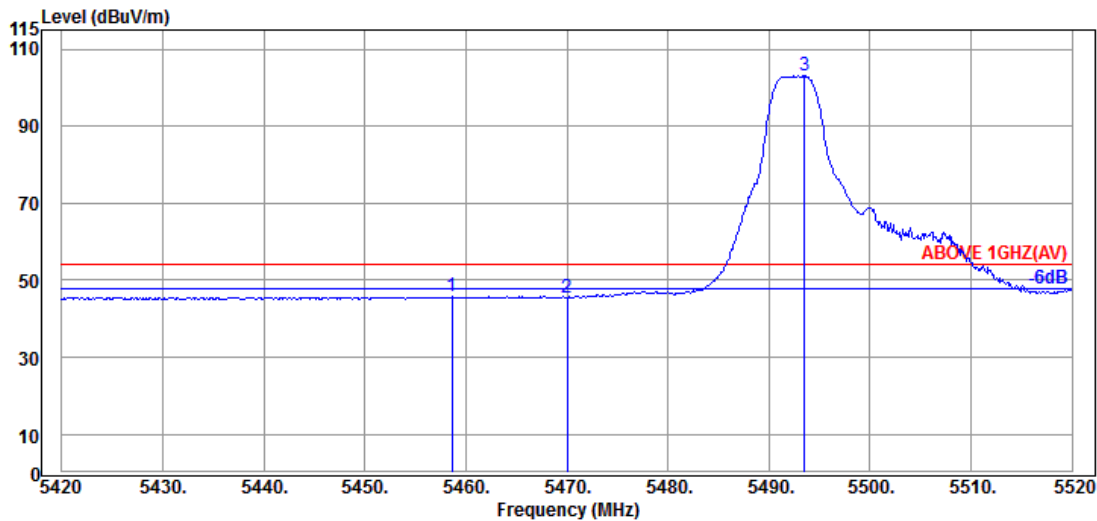

Antenna at Vertical Polarization

Emission Frequency (MHz)	Antenna Factor (dB/m)	Cable Loss (dB)	Preamplifier Gain (dB)	Read Level (dBμV)	Emission Level (dBμV/m)	Limits (dBμV/m)	Margin (dB)	Detector
5458.600	34.60	9.05	34.21	36.30	45.74	54.00	8.26	Average
5470.000	34.63	9.06	34.21	36.10	45.58	54.00	8.42	Average
@ 5493.500	34.67	9.07	34.20	93.61	103.15	---	---	Average

Remark: The “@” means fundamental frequency, it is ignored in this section.

Mode	802.11ax-HE20	U-NII Band	2C
RU Configuration	106/53	Frequency	TX 5500MHz

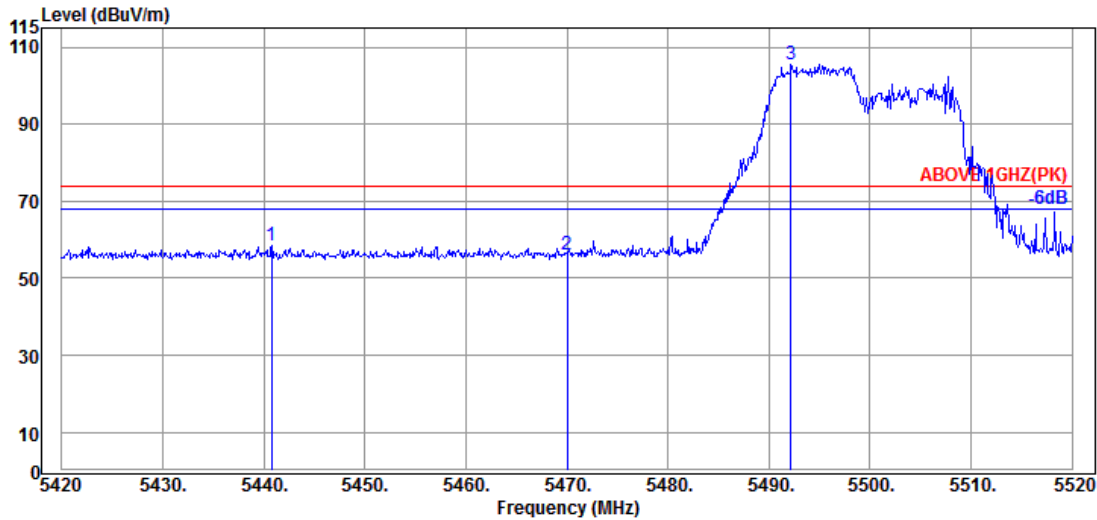

Antenna at Horizontal Polarization

Emission Frequency (MHz)	Antenna Factor (dB/m)	Cable Loss (dB)	Preamp Gain (dB)	Read Level (dBμV)	Emission Level (dBμV/m)	Limits (dBμV/m)	Margin (dB)	Detector
5440.800	34.65	9.04	34.22	49.13	58.60	74.00	15.40	Peak
5470.000	34.63	9.06	34.21	46.51	55.99	74.00	18.01	Peak
@ 5492.200	34.67	9.07	34.20	95.87	105.41	---	---	Peak

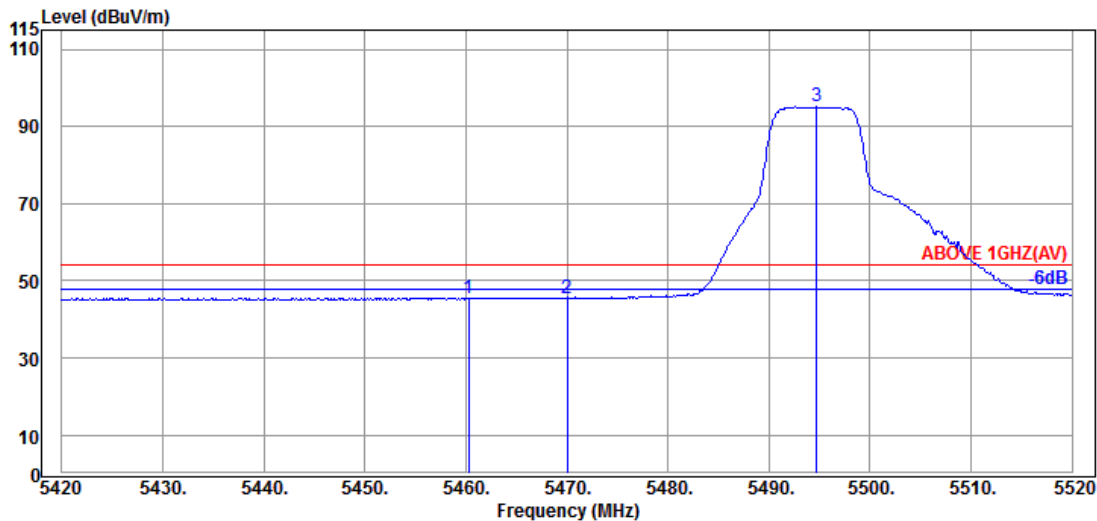

Antenna at Horizontal Polarization

Emission Frequency (MHz)	Antenna Factor (dB/m)	Cable Loss (dB)	Preamp Gain (dB)	Read Level (dBμV)	Emission Level (dBμV/m)	Limits (dBμV/m)	Margin (dB)	Detector
5460.300	34.60	9.05	34.21	36.19	45.63	54.00	8.37	Average
5470.000	34.63	9.06	34.21	35.98	45.46	54.00	8.54	Average
@ 5494.700	34.67	9.07	34.20	85.52	95.06	---	---	Average

Remark: The “@” means fundamental frequency, it is ignored in this section.

Mode	802.11ax-HE20	U-NII Band	2C
RU Configuration	106/53	Frequency	TX 5500MHz

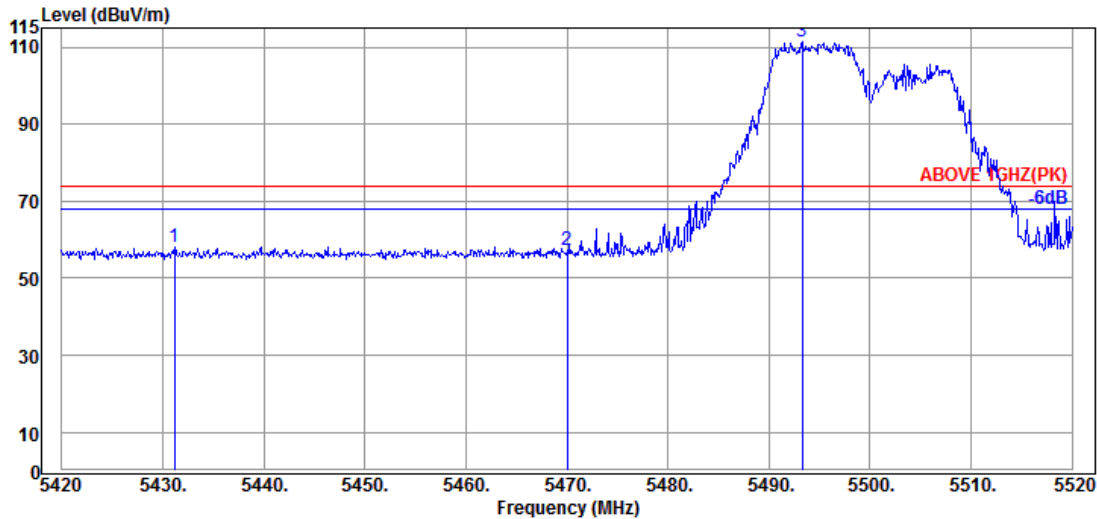

Antenna at Vertical Polarization

Emission Frequency (MHz)	Antenna Factor (dB/m)	Cable Loss (dB)	Preamp Gain (dB)	Read Level (dBUV)	Emission Level (dBUV/m)	Limits (dBUV/m)	Margin (dB)	Detector
5431.200	34.70	9.04	34.23	48.77	58.28	74.00	15.72	Peak
5470.000	34.63	9.06	34.21	48.02	57.50	74.00	16.50	Peak
@ 5493.300	34.67	9.07	34.20	102.06	111.60	---	---	Peak

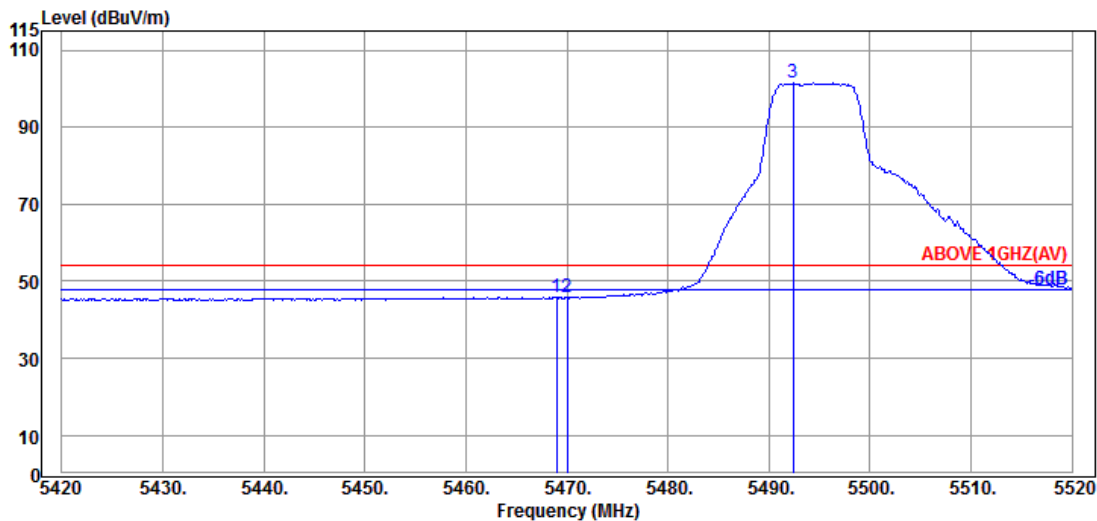

Antenna at Vertical Polarization

Emission Frequency (MHz)	Antenna Factor (dB/m)	Cable Loss (dB)	Preamp Gain (dB)	Read Level (dBUV)	Emission Level (dBUV/m)	Limits (dBUV/m)	Margin (dB)	Detector
5469.000	34.63	9.06	34.21	36.37	45.85	54.00	8.15	Average
5470.000	34.63	9.06	34.21	36.36	45.84	54.00	8.16	Average
@ 5492.400	34.67	9.07	34.20	92.06	101.60	---	---	Average

Remark: The "@" means fundamental frequency, it is ignored in this section.

Mode	802.11ax-HE20	U-NII Band	2C
RU Configuration	26/8	Frequency	TX 5700MHz

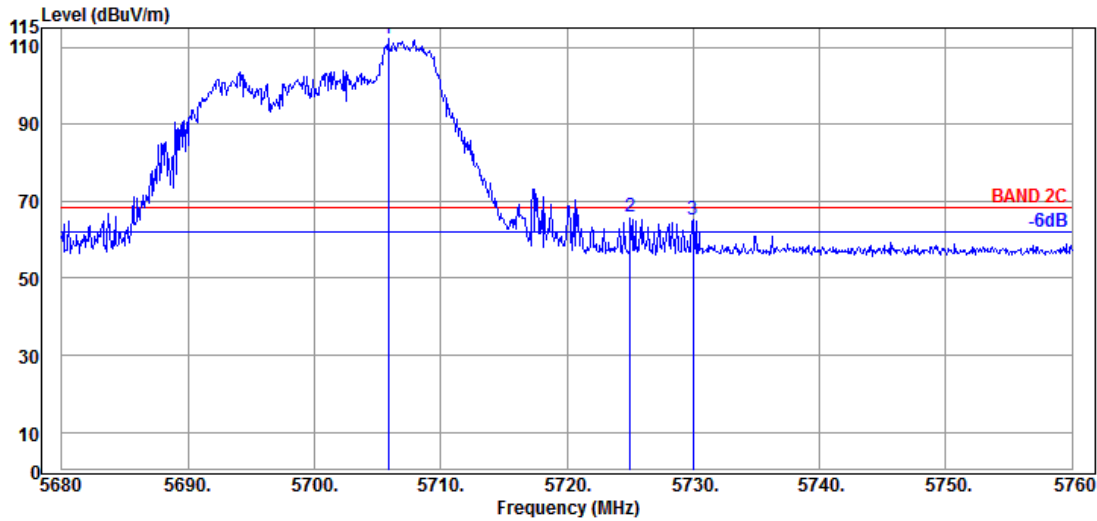

Antenna at Horizontal Polarization

Emission Frequency (MHz)	Antenna Factor (dB/m)	Cable Loss (dB)	Preamplifier Gain (dB)	Read Level (dBμV)	Emission Level (dBμV/m)	Limits (dBμV/m)	Margin (dB)	Detector
@ 5705.840	34.80	9.19	34.29	102.39	112.09	---	---	Peak
5725.040	34.90	9.20	34.30	56.39	66.19	68.20	2.01	Peak
5730.000	34.90	9.20	34.31	55.51	65.30	68.20	2.90	Peak

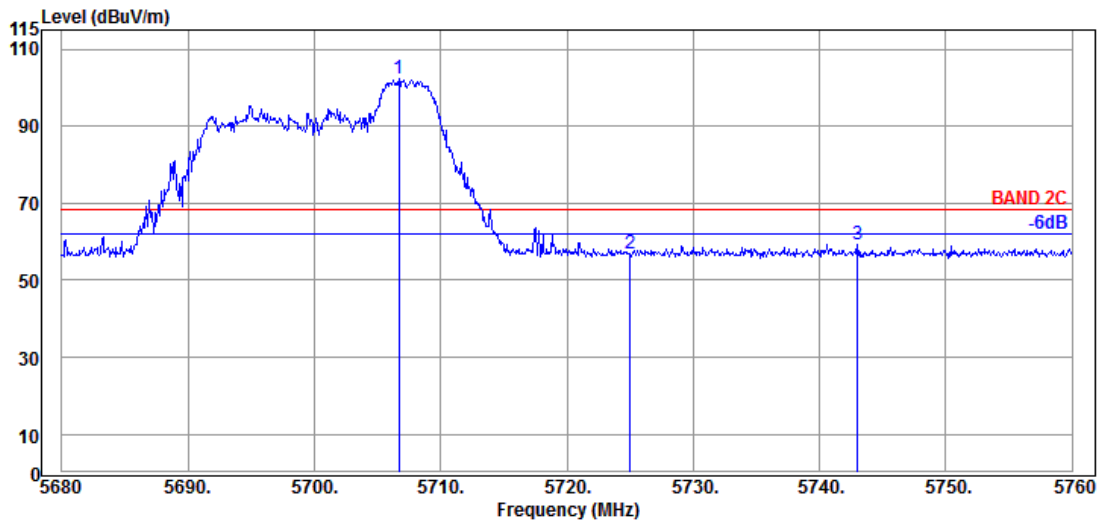

Antenna at Vertical Polarization

Emission Frequency (MHz)	Antenna Factor (dB/m)	Cable Loss (dB)	Preamplifier Gain (dB)	Read Level (dBμV)	Emission Level (dBμV/m)	Limits (dBμV/m)	Margin (dB)	Detector
@ 5706.720	34.80	9.19	34.29	92.75	102.45	---	---	Peak
5725.040	34.90	9.20	34.30	47.02	56.82	68.20	11.38	Peak
5743.040	35.00	9.20	34.31	49.55	59.44	68.20	8.76	Peak

Remark: The “@” means fundamental frequency, it is ignored in this section.

Mode	802.11ax-HE20	U-NII Band	2C
RU Configuration	52/40	Frequency	TX 5700MHz

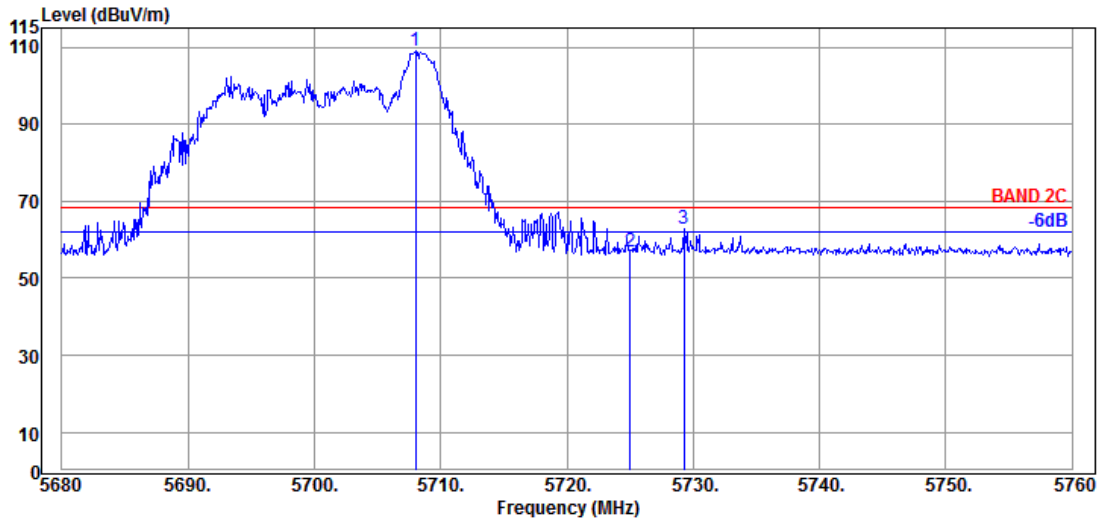

Antenna at Horizontal Polarization

Emission Frequency (MHz)	Antenna Factor (dB/m)	Cable Loss (dB)	Preamplifier Gain (dB)	Read Level (dBμV)	Emission Level (dBμV/m)	Limits (dBμV/m)	Margin (dB)	Detector
@ 5708.000	34.80	9.19	34.30	99.30	108.99	---	---	Peak
5725.040	34.90	9.20	34.30	47.07	56.87	68.20	11.33	Peak
5729.280	34.90	9.20	34.31	52.99	62.78	68.20	5.42	Peak

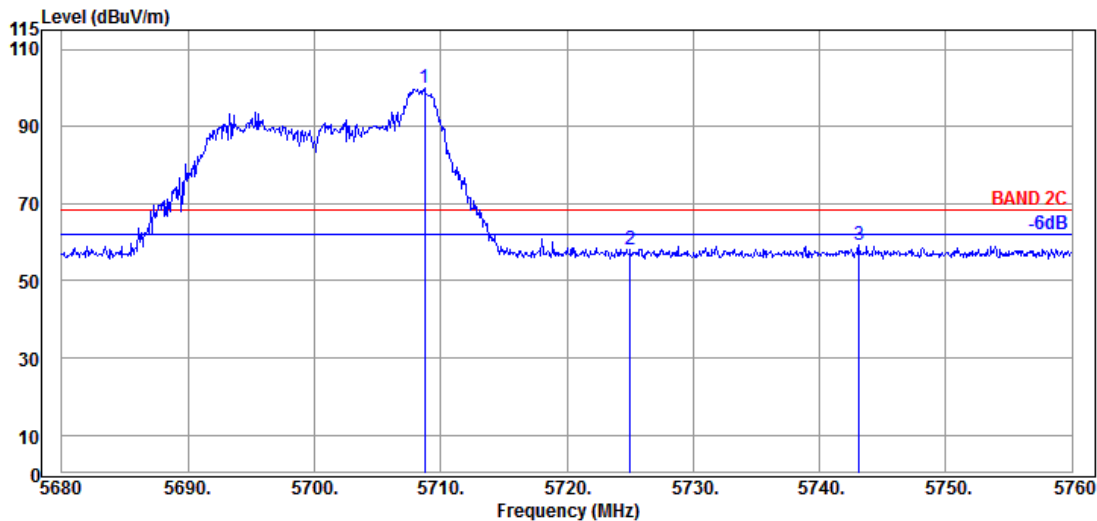

Antenna at Vertical Polarization

Emission Frequency (MHz)	Antenna Factor (dB/m)	Cable Loss (dB)	Preamplifier Gain (dB)	Read Level (dBμV)	Emission Level (dBμV/m)	Limits (dBμV/m)	Margin (dB)	Detector
@ 5708.720	34.80	9.19	34.30	90.13	99.82	---	---	Peak
5725.040	34.90	9.20	34.30	48.34	58.14	68.20	10.06	Peak
5743.120	35.00	9.20	34.31	49.34	59.23	68.20	8.97	Peak

Remark: The “@” means fundamental frequency, it is ignored in this section.

Mode	802.11ax-HE20	U-NII Band	2C
RU Configuration	106/54	Frequency	TX 5700MHz

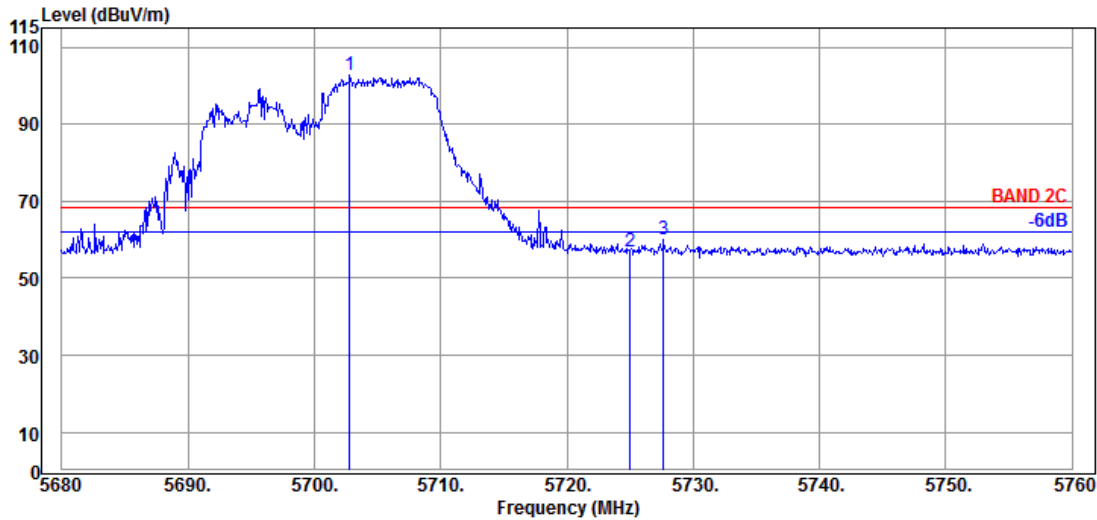

Antenna at Horizontal Polarization

Emission Frequency (MHz)	Antenna Factor (dB/m)	Cable Loss (dB)	Preamplifier Gain (dB)	Read Level (dBμV)	Emission Level (dBUV/m)	Limits (dBUV/m)	Margin (dB)	Detector
@ 5702.800	34.70	9.18	34.29	93.24	102.83	---	---	Peak
5725.040	34.90	9.20	34.30	46.91	56.71	68.20	11.49	Peak
5727.680	34.90	9.20	34.31	50.13	59.92	68.20	8.28	Peak

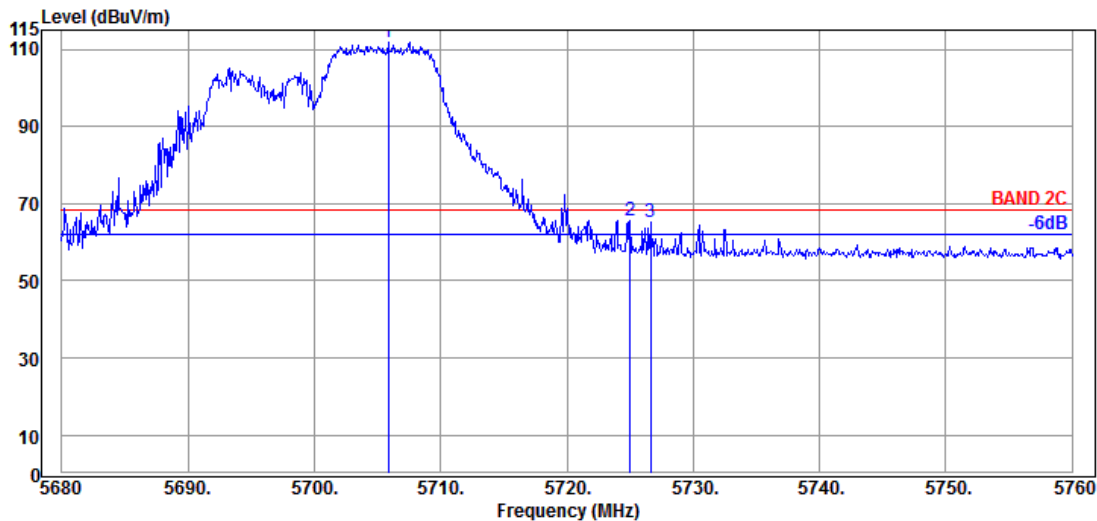

Antenna at Vertical Polarization

Emission Frequency (MHz)	Antenna Factor (dB/m)	Cable Loss (dB)	Preamplifier Gain (dB)	Read Level (dBμV)	Emission Level (dBUV/m)	Limits (dBUV/m)	Margin (dB)	Detector
@ 5705.840	34.80	9.19	34.29	102.11	111.81	---	---	Peak
5725.040	34.90	9.20	34.30	55.83	65.63	68.20	2.57	Peak
5726.640	34.90	9.20	34.31	55.34	65.13	68.20	3.07	Peak

Remark: The “@” means fundamental frequency, it is ignored in this section.

Mode	802.11ax-HE20	U-NII Band	3
RU Configuration	26/0	Frequency	TX 5745MHz

Antenna at Horizontal Polarization

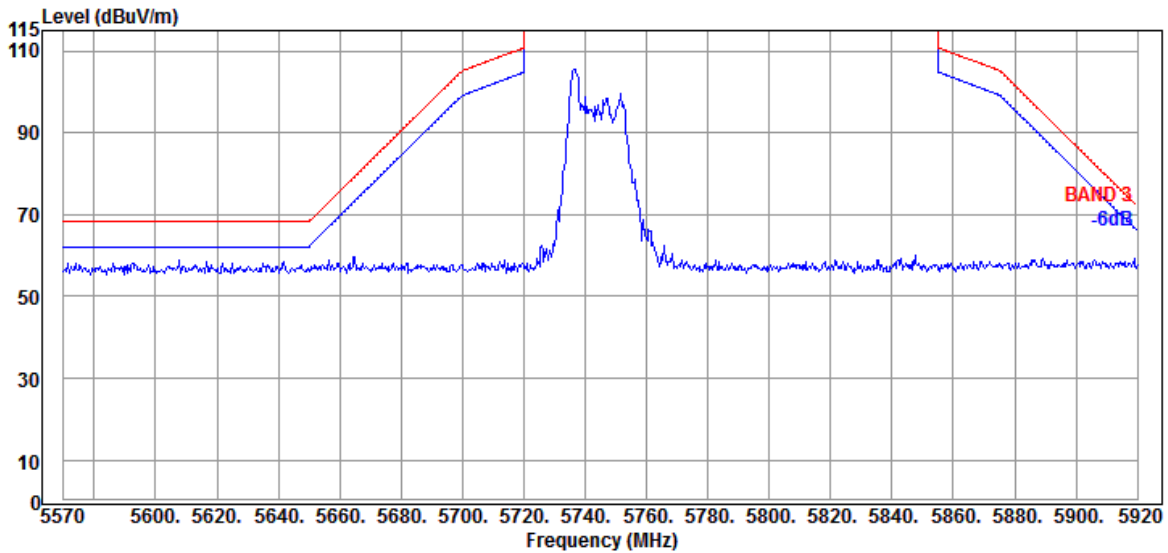

Antenna at Vertical Polarization

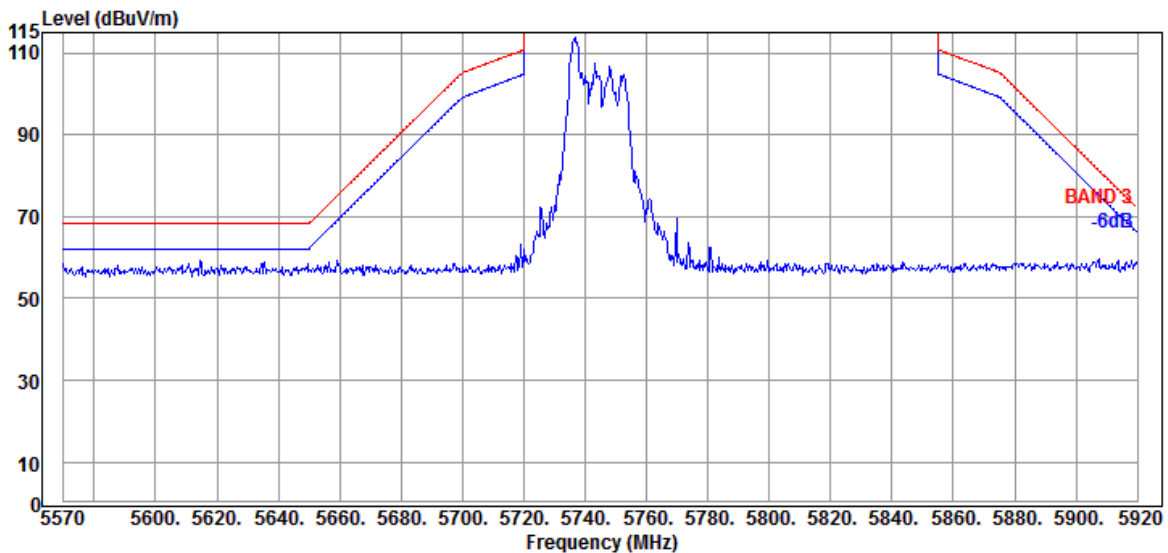

Mode	802.11ax-HE20	U-NII Band	3
RU Configuration	52/37	Frequency	TX 5745MHz

Antenna at Horizontal Polarization

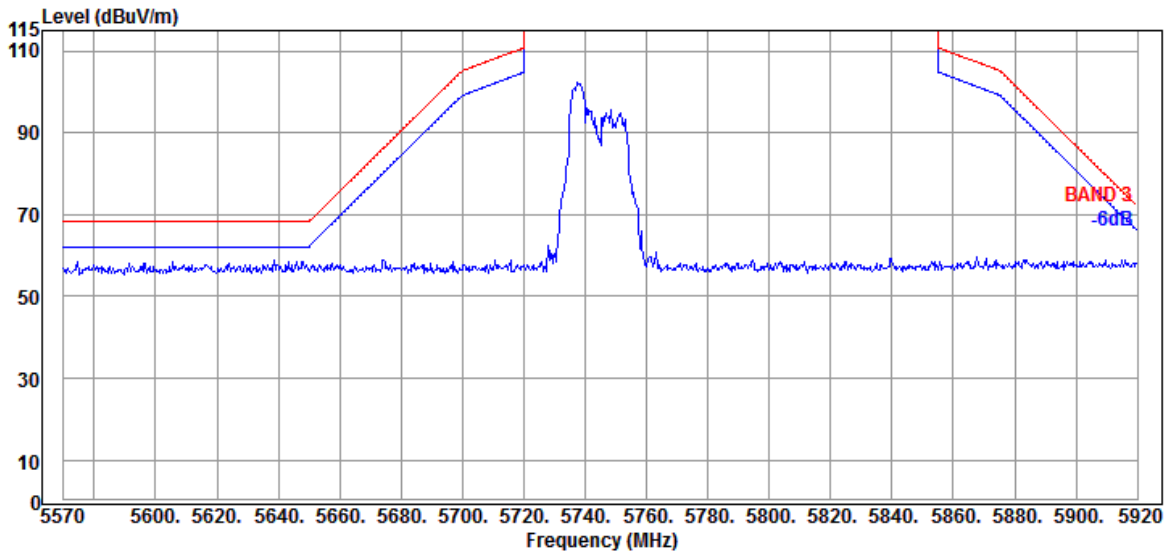

Antenna at Vertical Polarization

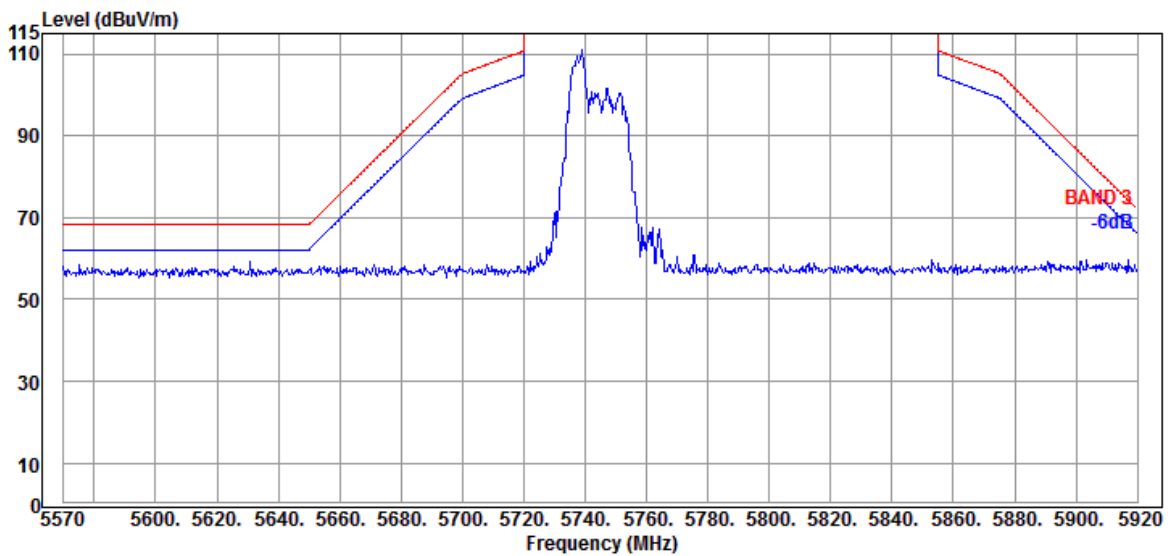

Mode	802.11ax-HE20	U-NII Band	3
RU Configuration	106/53	Frequency	TX 5745MHz

Antenna at Horizontal Polarization

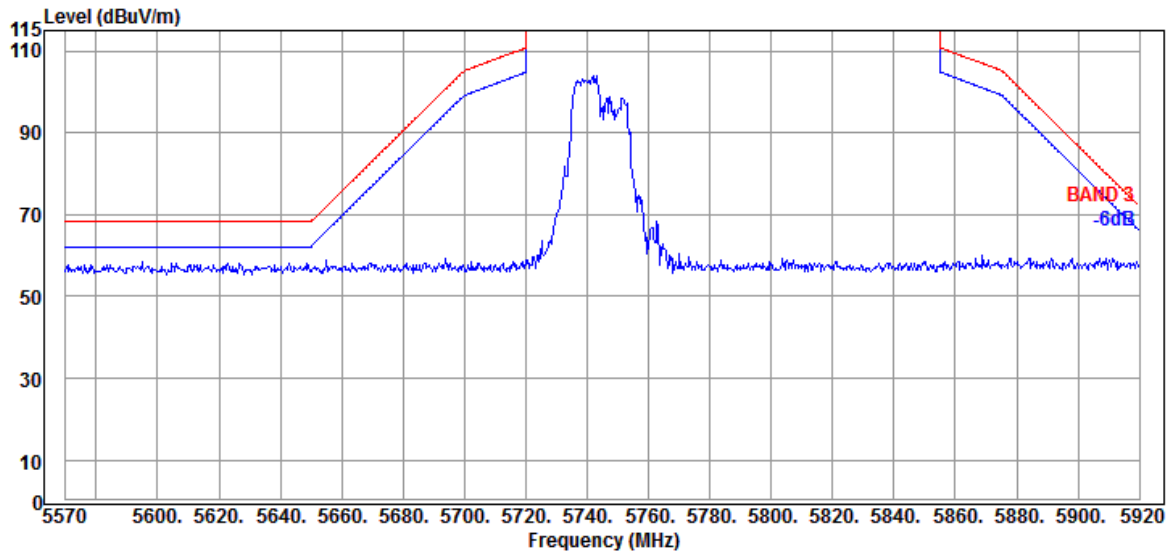

Antenna at Vertical Polarization

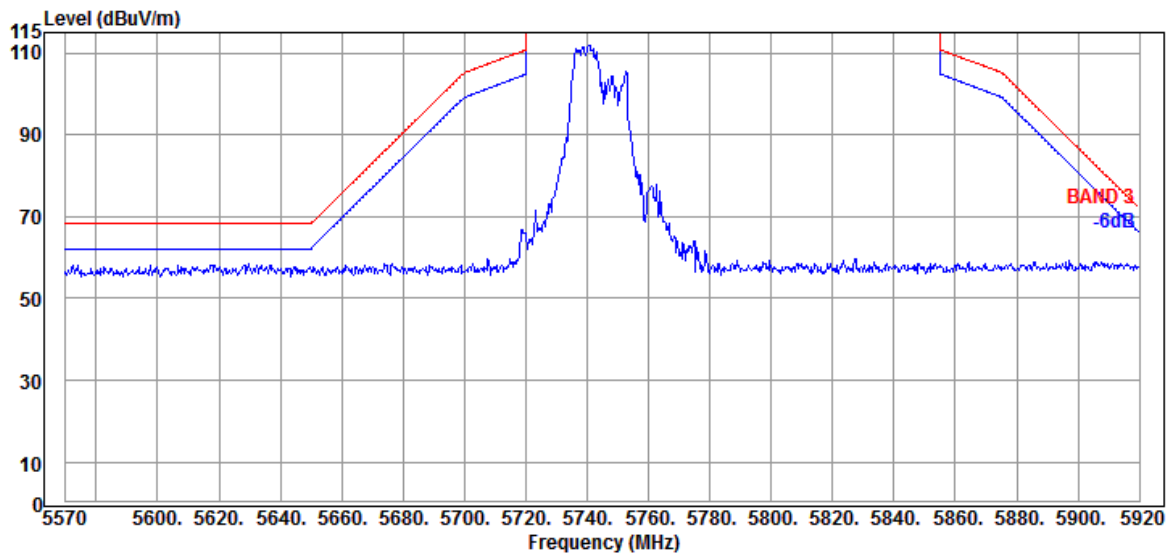

Mode	802.11ax-HE20	U-NII Band	3
RU Configuration	26/8	Frequency	TX 5825MHz

Antenna at Horizontal Polarization

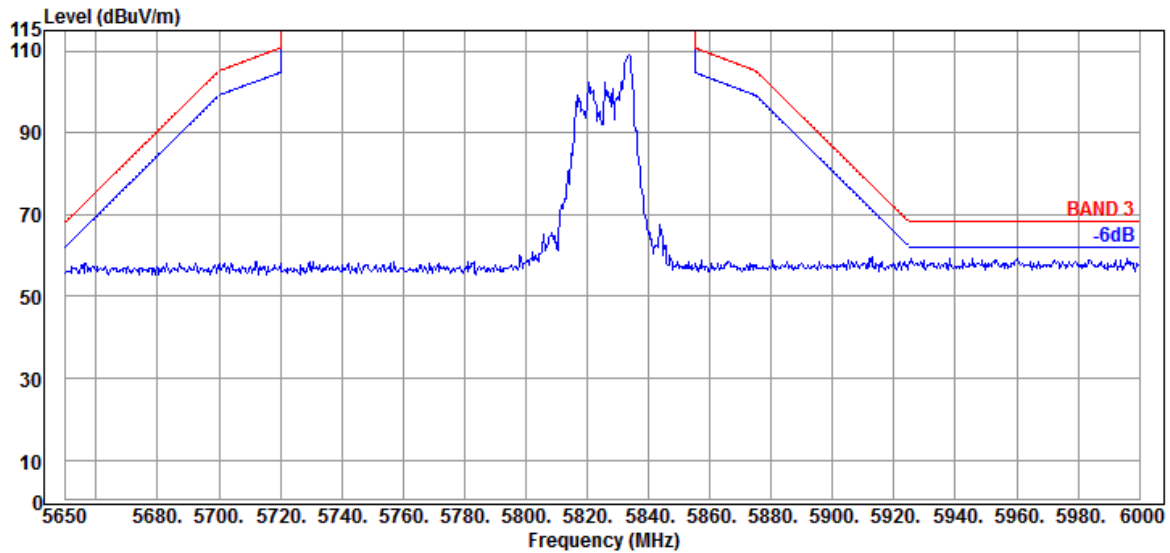

Antenna at Vertical Polarization

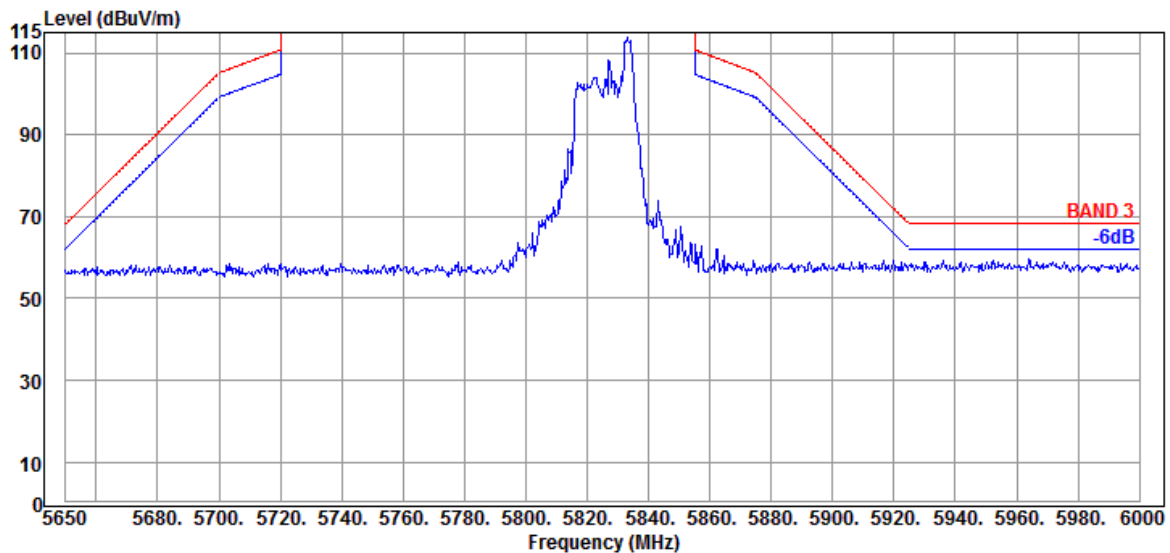

Mode	802.11ax-HE20	U-NII Band	3
RU Configuration	52/40	Frequency	TX 5825MHz

Antenna at Horizontal Polarization

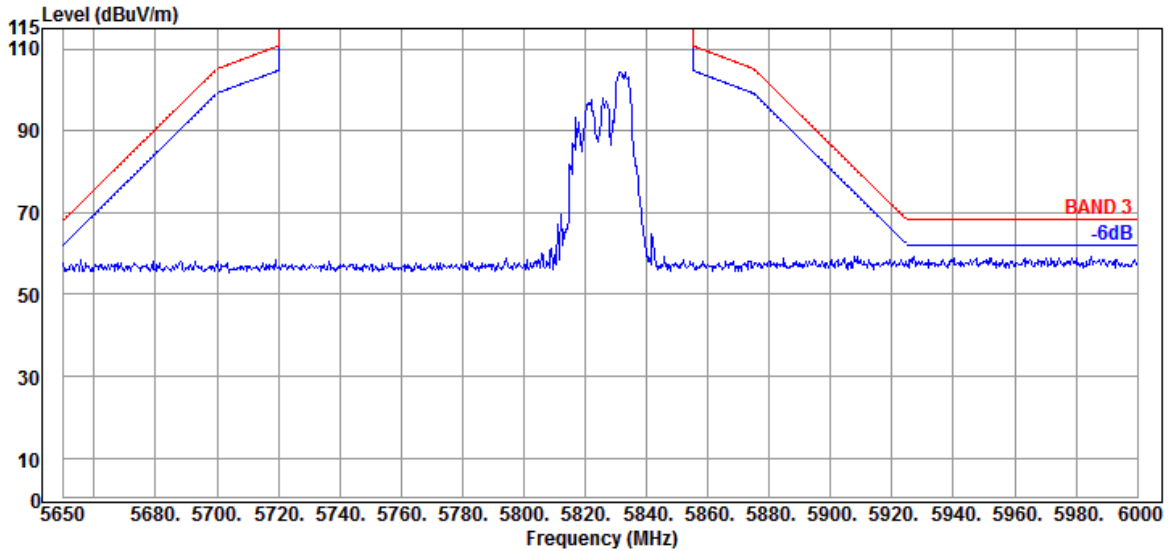

Antenna at Vertical Polarization

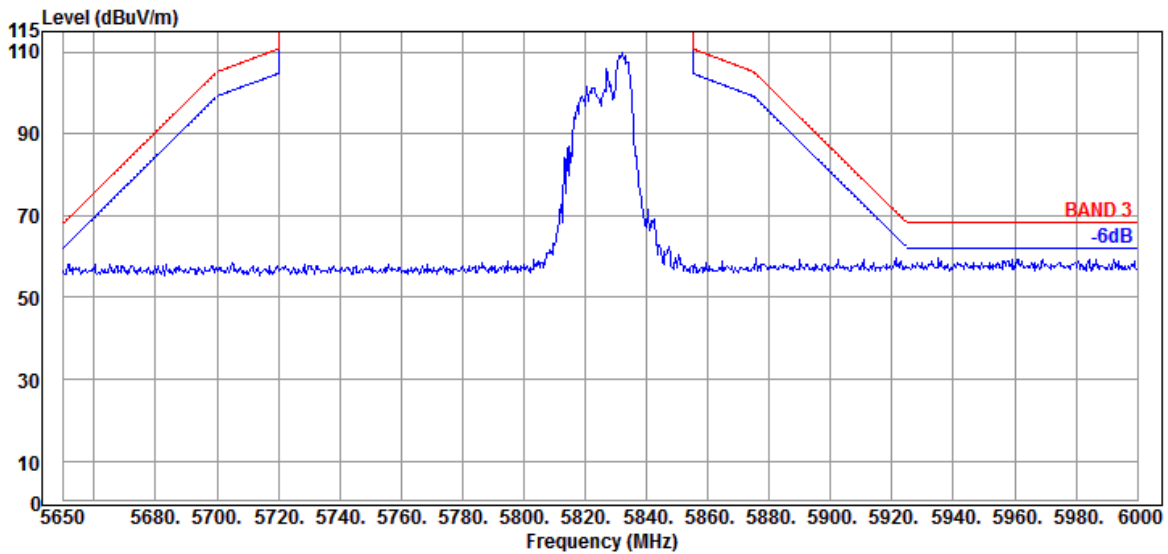

Mode	802.11ax-HE20	U-NII Band	3
RU Configuration	106/54	Frequency	TX 5825MHz

Antenna at Horizontal Polarization

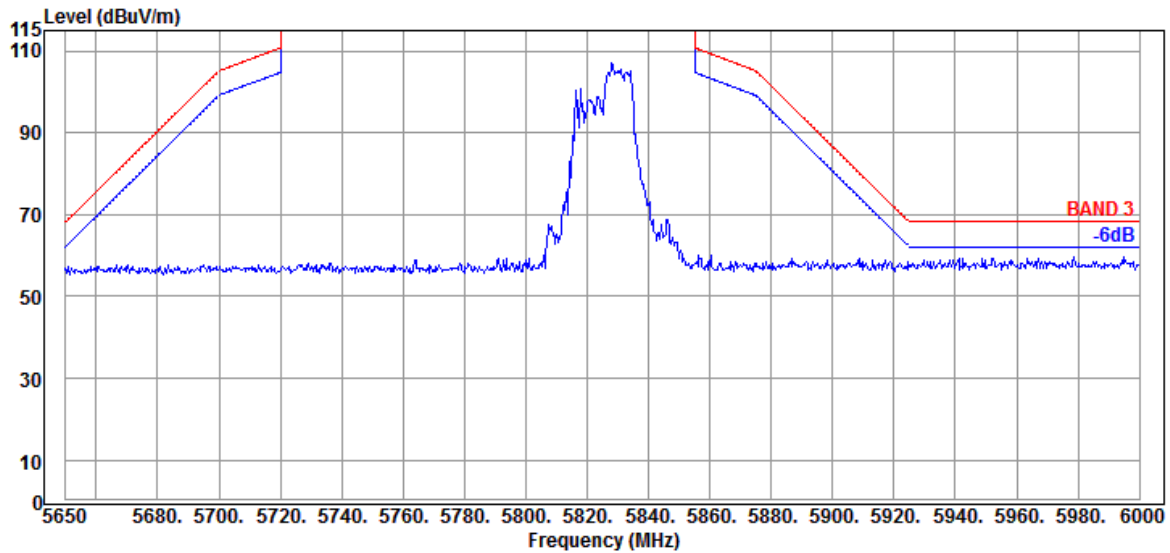

Antenna at Vertical Polarization

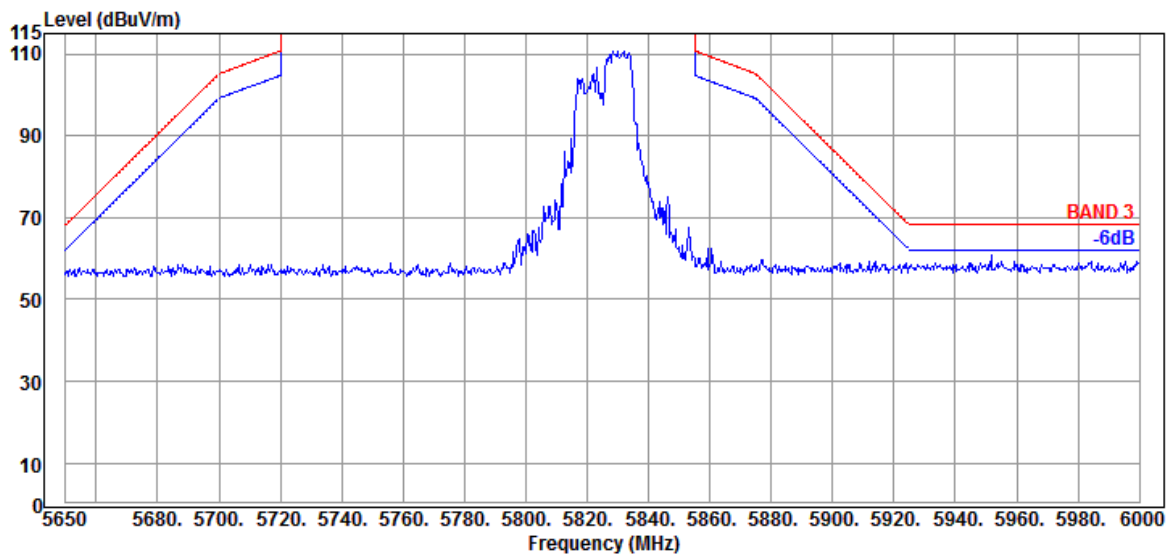

Mode	802.11ax-HE40	U-NII Band	1
RU Configuration	242/61	Frequency	TX 5190MHz

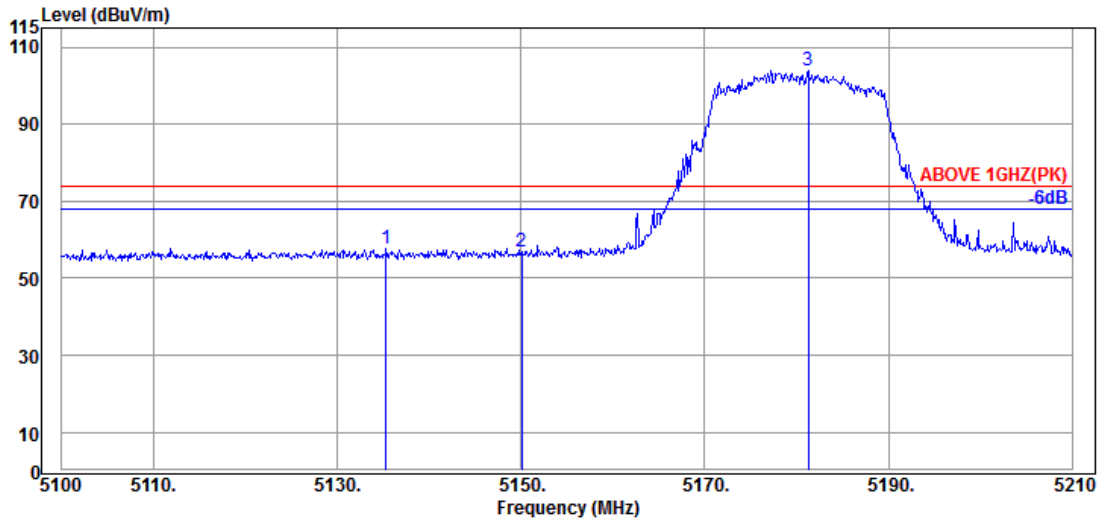

Antenna at Horizontal Polarization

Emission Frequency (MHz)	Antenna Factor (dB/m)	Cable Loss (dB)	Preamplifier Gain (dB)	Read Level (dBμV)	Emission Level (dBUV/m)	Limits (dBUV/m)	Margin (dB)	Detector
5135.310	34.40	8.88	34.34	48.75	57.69	74.00	16.31	Peak
5150.050	34.50	8.88	34.34	47.85	56.89	74.00	17.11	Peak
@ 5181.290	34.63	8.90	34.32	94.68	103.89	---	---	Peak

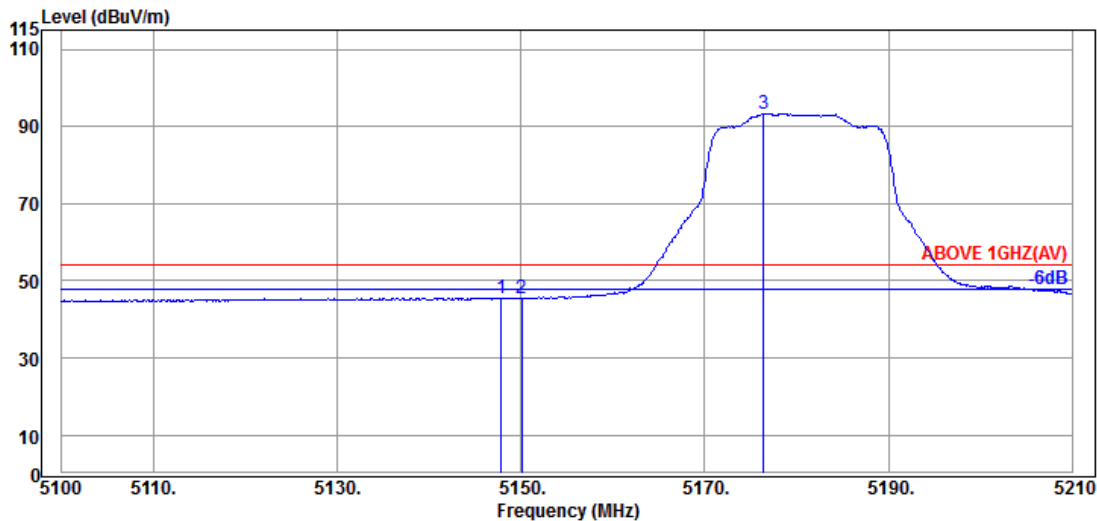

Antenna at Horizontal Polarization

Emission Frequency (MHz)	Antenna Factor (dB/m)	Cable Loss (dB)	Preamplifier Gain (dB)	Read Level (dBμV)	Emission Level (dBUV/m)	Limits (dBUV/m)	Margin (dB)	Detector
5147.850	34.50	8.88	34.34	36.56	45.60	54.00	8.40	Average
5150.050	34.50	8.88	34.34	36.52	45.56	54.00	8.44	Average
@ 5176.450	34.63	8.90	34.32	84.23	93.44	---	---	Average

Remark: The “@” means fundamental frequency, it is ignored in this section.

Mode	802.11ax-HE40	U-NII Band	1
RU Configuration	242/61	Frequency	TX 5190MHz

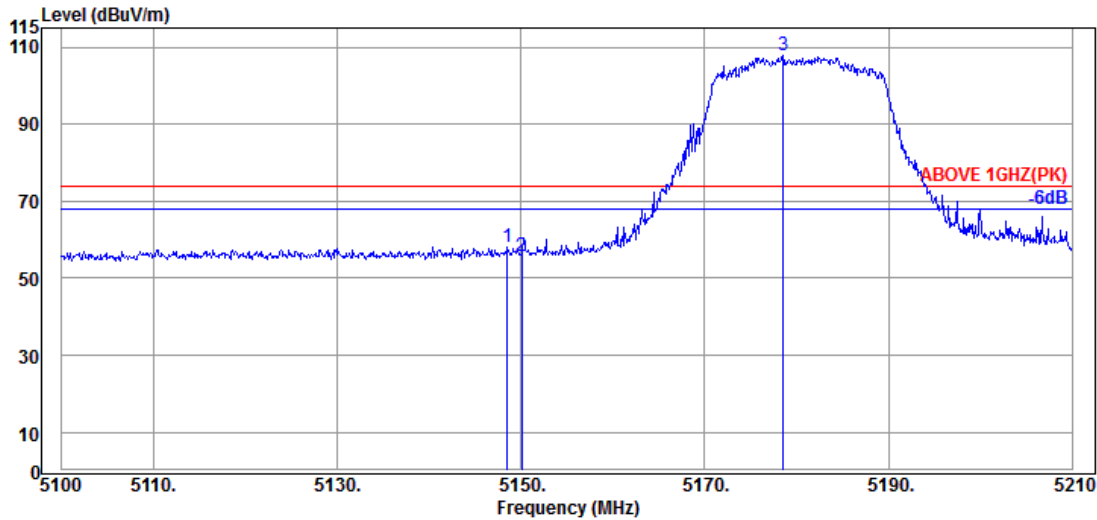

Antenna at Vertical Polarization

Emission Frequency (MHz)	Antenna Factor (dB/m)	Cable Loss (dB)	Preamp Gain (dB)	Read Level (dBμV)	Emission Level (dBμV/m)	Limits (dBμV/m)	Margin (dB)	Detector
5148.510	34.50	8.88	34.34	49.10	58.14	74.00	15.86	Peak
5150.050	34.50	8.88	34.34	46.50	55.54	74.00	18.46	Peak
@ 5178.540	34.63	8.90	34.32	98.64	107.85	---	---	Peak

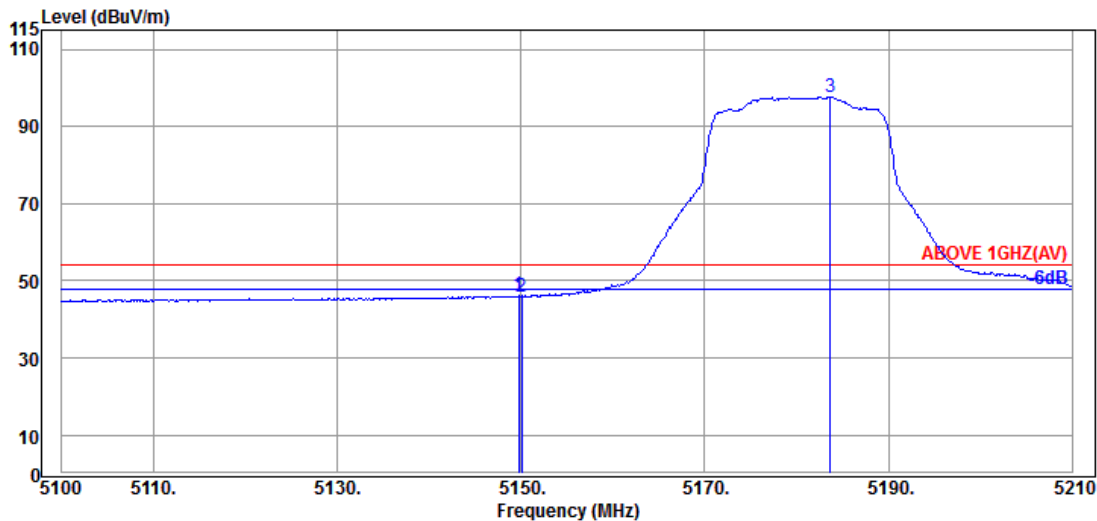

Antenna at Vertical Polarization

Emission Frequency (MHz)	Antenna Factor (dB/m)	Cable Loss (dB)	Preamp Gain (dB)	Read Level (dBμV)	Emission Level (dBμV/m)	Limits (dBμV/m)	Margin (dB)	Detector
5149.720	34.50	8.88	34.34	37.03	46.07	54.00	7.93	Average
5150.050	34.50	8.88	34.34	36.89	45.93	54.00	8.07	Average
@ 5183.710	34.63	8.90	34.32	88.46	97.67	---	---	Average

Remark: The “@” means fundamental frequency, it is ignored in this section.

Mode	802.11ax-HE40	U-NII Band	2A
RU Configuration	242/62	Frequency	TX 5310MHz

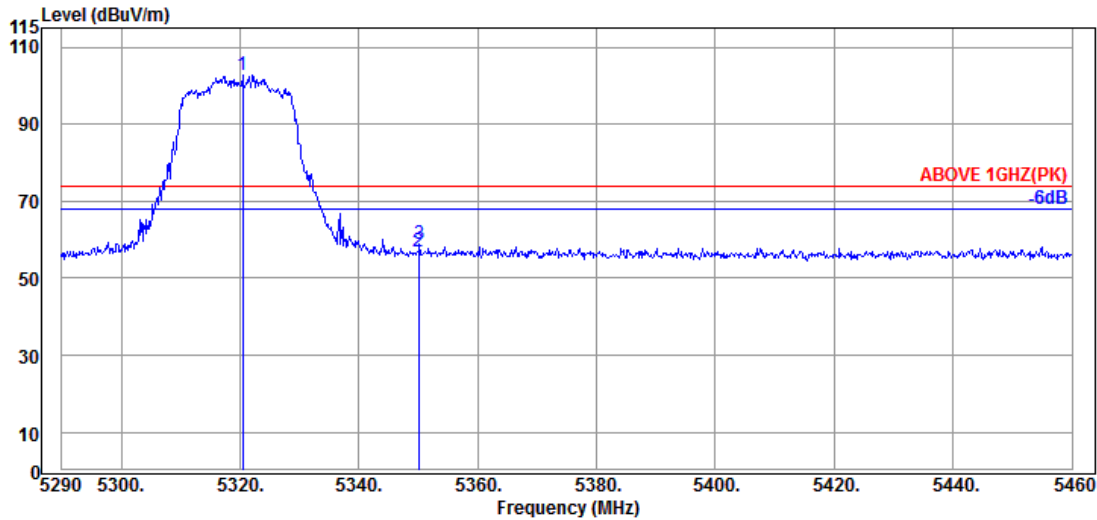

Antenna at Horizontal Polarization

Emission Frequency (MHz)	Antenna Factor (dB/m)	Cable Loss (dB)	Preamp Gain (dB)	Read Level (dBμV)	Emission Level (dBμV/m)	Limits (dBμV/m)	Margin (dB)	Detector
@ 5320.430	34.57	8.98	34.27	93.43	102.71	---	---	Peak
5350.010	34.90	8.99	34.26	47.18	56.81	74.00	17.19	Peak
5350.180	34.90	8.99	34.26	49.06	58.69	74.00	15.31	Peak

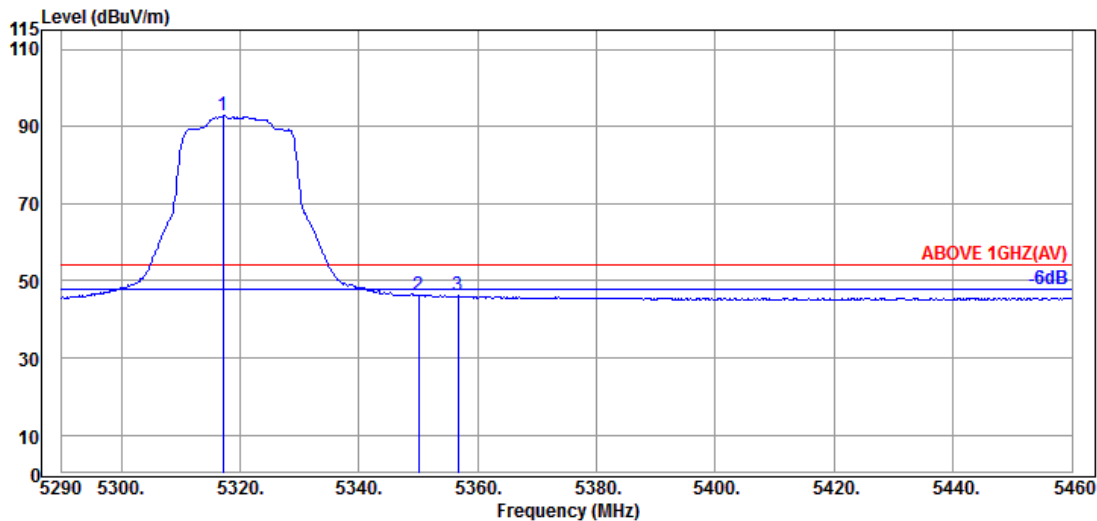

Antenna at Horizontal Polarization

Emission Frequency (MHz)	Antenna Factor (dB/m)	Cable Loss (dB)	Preamp Gain (dB)	Read Level (dBμV)	Emission Level (dBμV/m)	Limits (dBμV/m)	Margin (dB)	Detector
@ 5317.200	34.57	8.98	34.27	83.46	92.74	---	---	Average
5350.010	34.90	8.99	34.26	36.66	46.29	54.00	7.71	Average
5356.640	34.87	9.00	34.26	36.69	46.30	54.00	7.70	Average

Remark: The “@” means fundamental frequency, it is ignored in this section.

Mode	802.11ax-HE40	U-NII Band	2A
RU Configuration	242/62	Frequency	TX 5310MHz

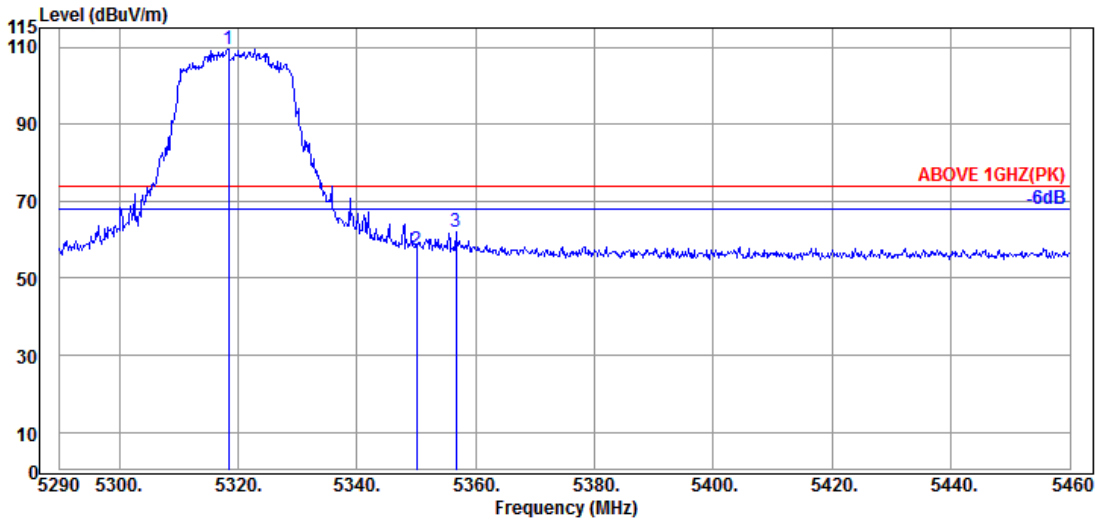

Antenna at Vertical Polarization

Emission Frequency (MHz)	Antenna Factor (dB/m)	Cable Loss (dB)	Preamp Gain (dB)	Read Level (dBμV)	Emission Level (dBμV/m)	Limits (dBμV/m)	Margin (dB)	Detector
@ 5318.390	34.57	8.98	34.27	100.16	109.44	---	---	Peak
5350.010	34.90	8.99	34.26	47.86	57.49	74.00	16.51	Peak
5356.640	34.87	9.00	34.26	52.59	62.20	74.00	11.80	Peak

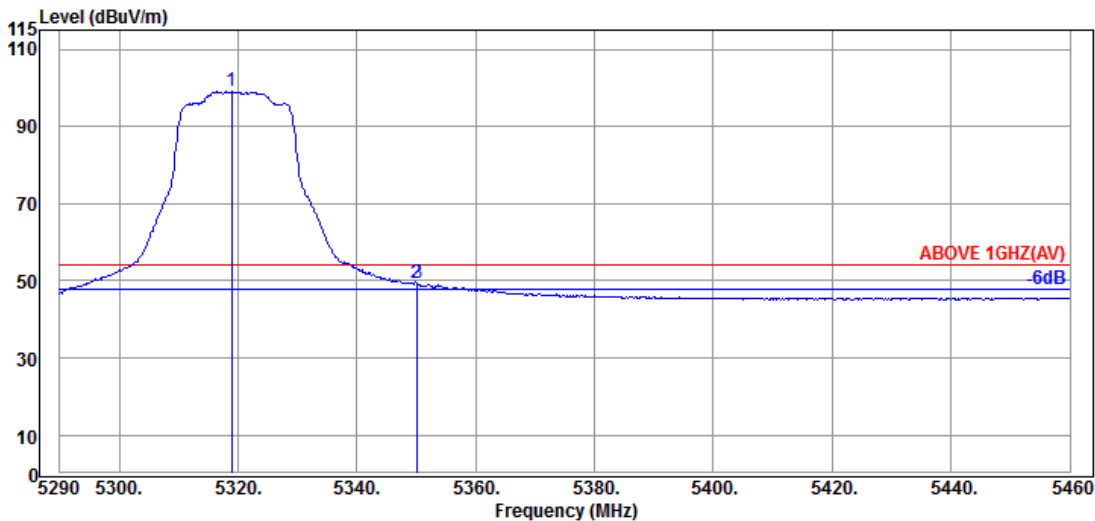

Antenna at Vertical Polarization

Emission Frequency (MHz)	Antenna Factor (dB/m)	Cable Loss (dB)	Preamp Gain (dB)	Read Level (dBμV)	Emission Level (dBμV/m)	Limits (dBμV/m)	Margin (dB)	Detector
@ 5318.900	34.57	8.98	34.27	89.85	99.13	---	---	Average
5350.010	34.90	8.99	34.26	39.85	49.48	54.00	4.52	Average
5350.180	34.90	8.99	34.26	39.71	49.34	54.00	4.66	Average

Remark: The “@” means fundamental frequency, it is ignored in this section.

Mode	802.11ax-HE40	U-NII Band	2C
RU Configuration	242/61	Frequency	TX 5510MHz

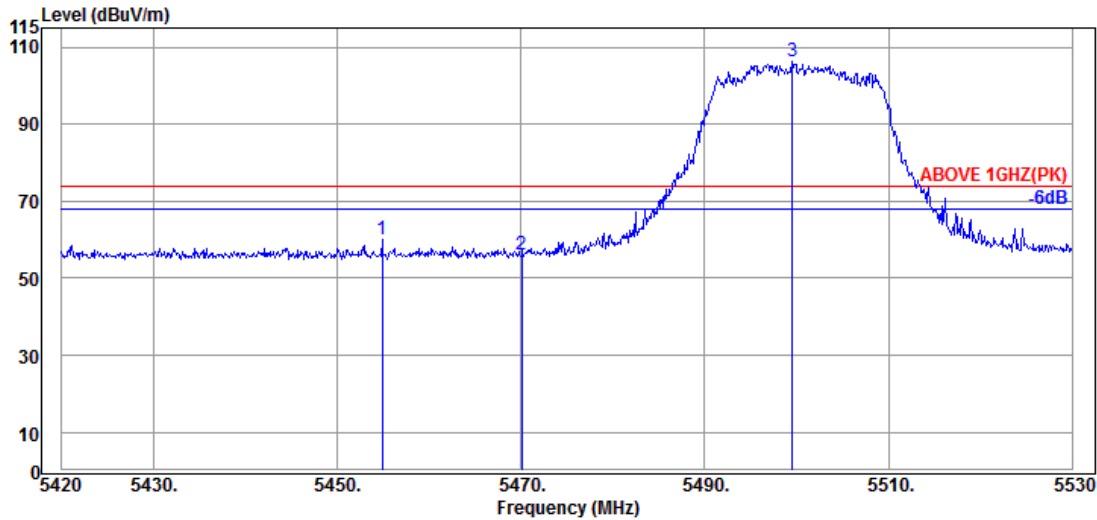

Antenna at Horizontal Polarization

Emission Frequency (MHz)	Antenna Factor (dB/m)	Cable Loss (dB)	Preamp Gain (dB)	Read Level (dBμV)	Emission Level (dBμV/m)	Limits (dBμV/m)	Margin (dB)	Detector
5454.870	34.60	9.05	34.21	50.55	59.99	74.00	14.01	Peak
5470.050	34.63	9.06	34.21	46.59	56.07	74.00	17.93	Peak
@ 5499.530	34.70	9.08	34.20	96.89	106.47	---	---	Peak

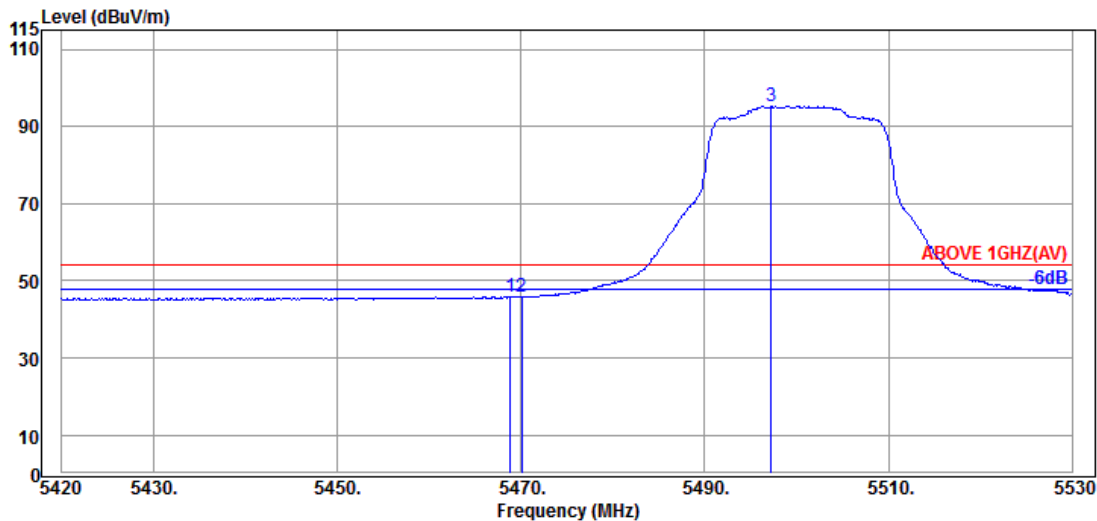

Antenna at Horizontal Polarization

Emission Frequency (MHz)	Antenna Factor (dB/m)	Cable Loss (dB)	Preamp Gain (dB)	Read Level (dBμV)	Emission Level (dBμV/m)	Limits (dBμV/m)	Margin (dB)	Detector
5468.840	34.63	9.06	34.21	36.47	45.95	54.00	8.05	Average
5470.050	34.63	9.06	34.21	36.31	45.79	54.00	8.21	Average
@ 5497.220	34.70	9.08	34.20	85.69	95.27	---	---	Average

Remark: The “@” means fundamental frequency, it is ignored in this section.

Mode	802.11ax-HE40	U-NII Band	2C
RU Configuration	242/61	Frequency	TX 5510MHz

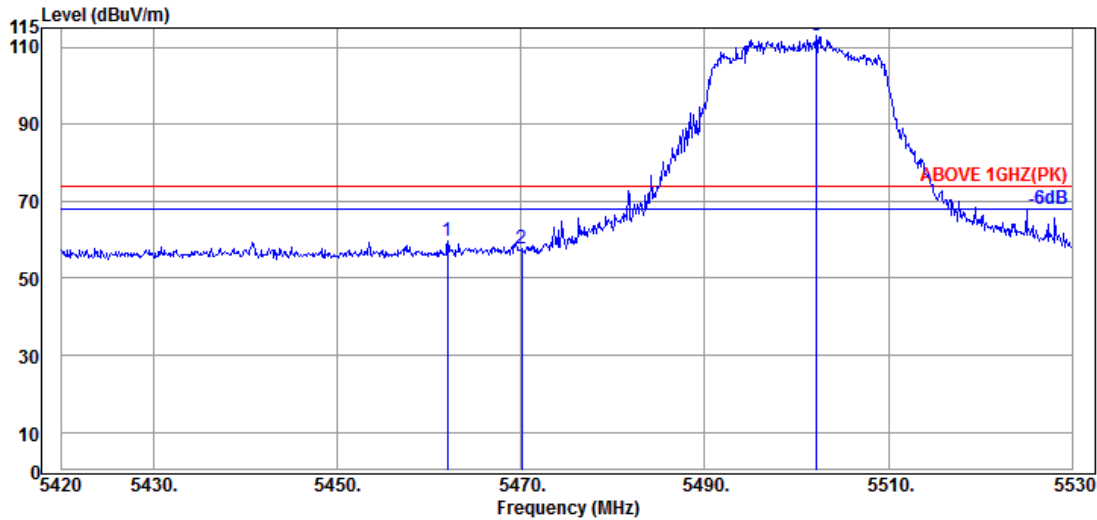

Antenna at Vertical Polarization

Emission Frequency (MHz)	Antenna Factor (dB/m)	Cable Loss (dB)	Preamp Gain (dB)	Read Level (dBμV)	Emission Level (dBUV/m)	Limits (dBUV/m)	Margin (dB)	Detector
5462.020	34.60	9.05	34.21	50.25	59.69	74.00	14.31	Peak
5470.050	34.63	9.06	34.21	48.20	57.68	74.00	16.32	Peak
@ 5502.170	34.70	9.08	34.20	103.31	112.89	---	---	Peak

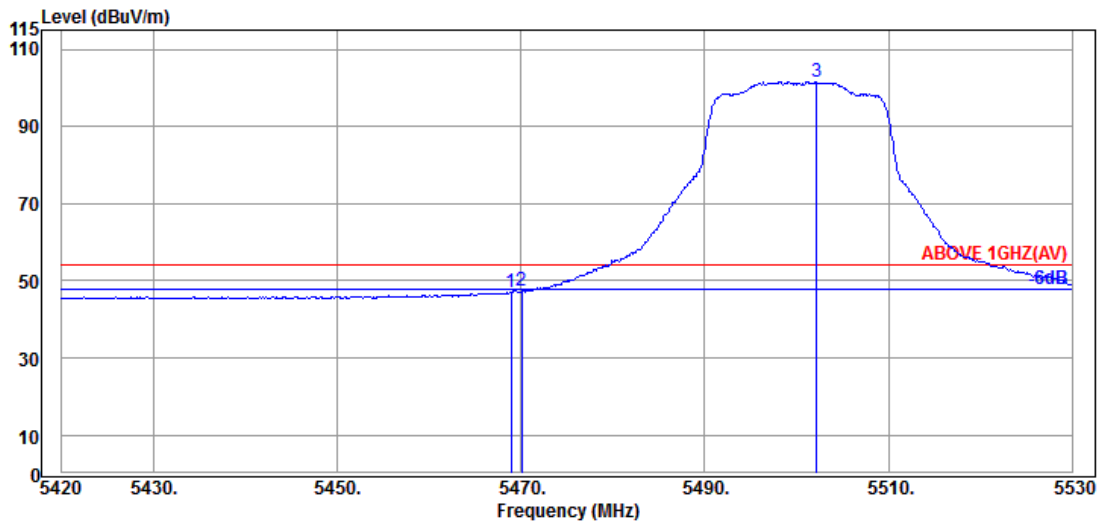

Antenna at Vertical Polarization

Emission Frequency (MHz)	Antenna Factor (dB/m)	Cable Loss (dB)	Preamp Gain (dB)	Read Level (dBμV)	Emission Level (dBUV/m)	Limits (dBUV/m)	Margin (dB)	Detector
5468.950	34.63	9.06	34.21	37.59	47.07	54.00	6.93	Average
5470.050	34.63	9.06	34.21	37.76	47.24	54.00	6.76	Average
@ 5502.170	34.70	9.08	34.20	91.95	101.53	---	---	Average

Remark: The “@” means fundamental frequency, it is ignored in this section.

Mode	802.11ax-HE40	U-NII Band	2C
RU Configuration	242/62	Frequency	TX 5670MHz

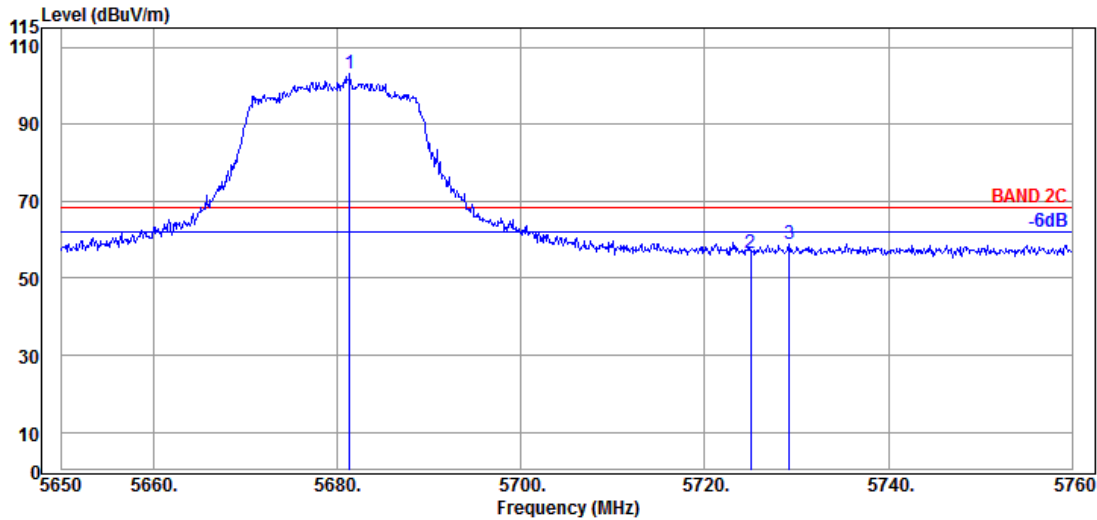

Antenna at Horizontal Polarization

Emission Frequency (MHz)	Antenna Factor (dB/m)	Cable Loss (dB)	Preamp Gain (dB)	Read Level (dBμV)	Emission Level (dBμV/m)	Limits (dBμV/m)	Margin (dB)	Detector
@ 5681.350	34.63	9.17	34.29	93.63	103.14	---	---	Peak
5725.020	34.90	9.20	34.30	46.67	56.47	68.20	11.73	Peak
5729.200	34.90	9.20	34.31	49.11	58.90	68.20	9.30	Peak

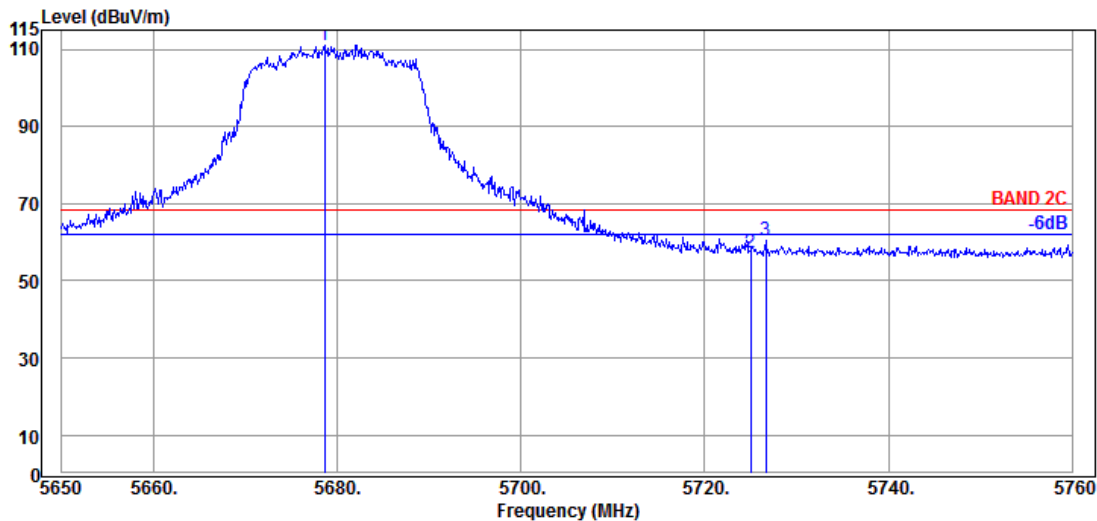

Antenna at Vertical Polarization

Emission Frequency (MHz)	Antenna Factor (dB/m)	Cable Loss (dB)	Preamp Gain (dB)	Read Level (dBμV)	Emission Level (dBμV/m)	Limits (dBμV/m)	Margin (dB)	Detector
@ 5678.600	34.63	9.17	34.29	101.56	111.07	---	---	Peak
5725.020	34.90	9.20	34.30	47.39	57.19	68.20	11.01	Peak
5726.670	34.90	9.20	34.31	50.80	60.59	68.20	7.61	Peak

Remark: The "@" means fundamental frequency, it is ignored in this section.

Mode	802.11ax-HE40	U-NII Band	3
RU Configuration	242/61	Frequency	TX 5755MHz

Antenna at Horizontal Polarization

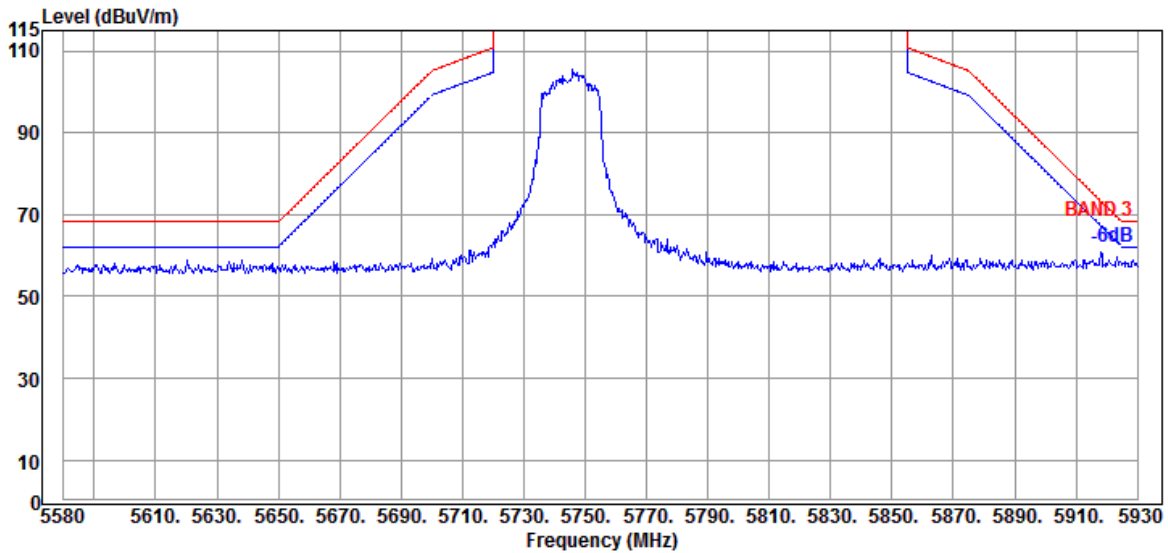

Antenna at Vertical Polarization

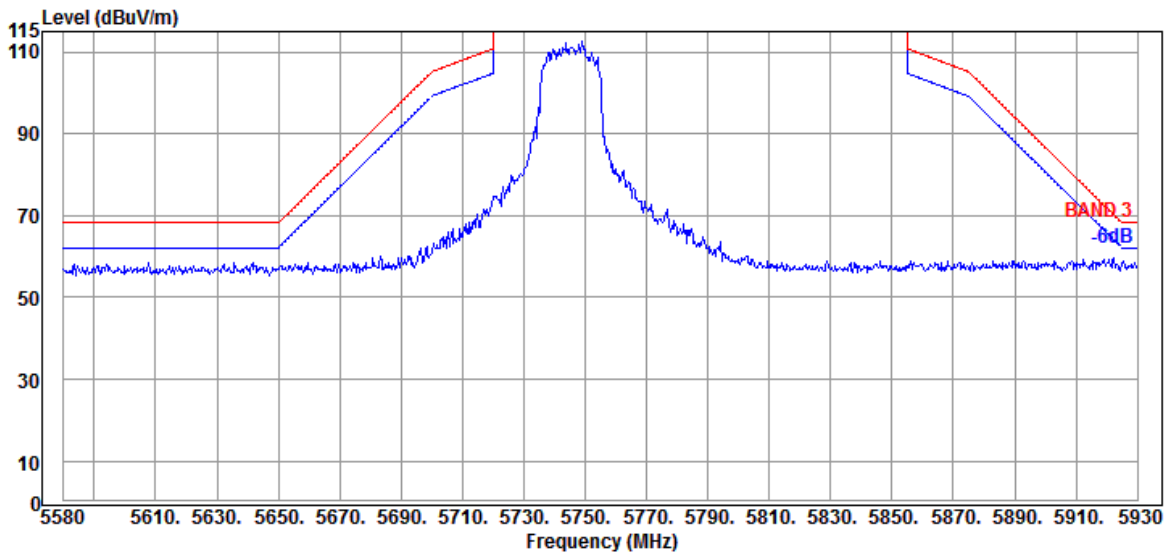

Mode	802.11ax-HE40	U-NII Band	3
RU Configuration	242/62	Frequency	TX 5795MHz

Antenna at Horizontal Polarization

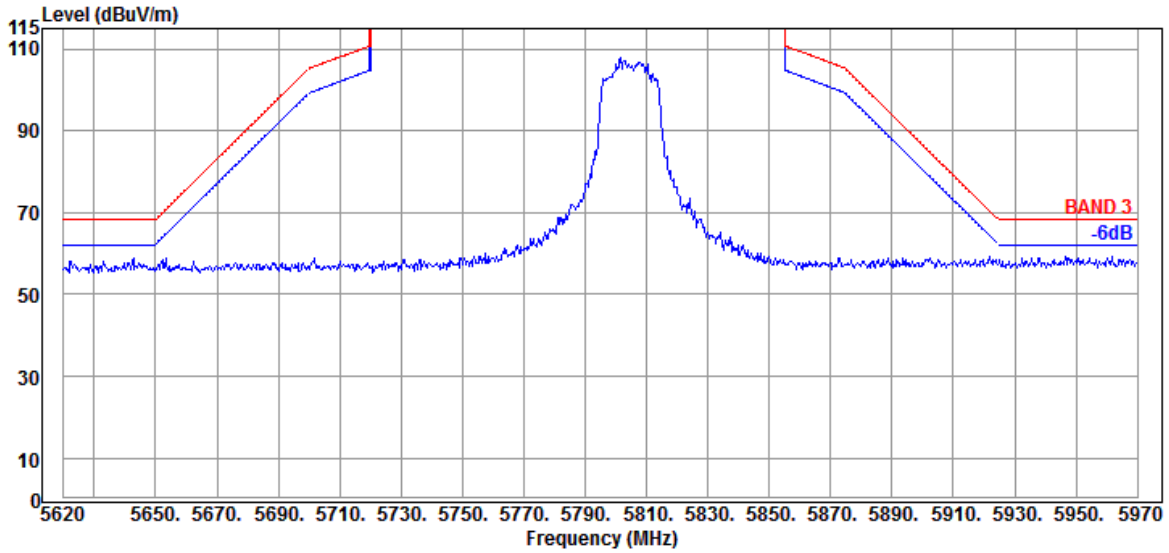

Antenna at Vertical Polarization

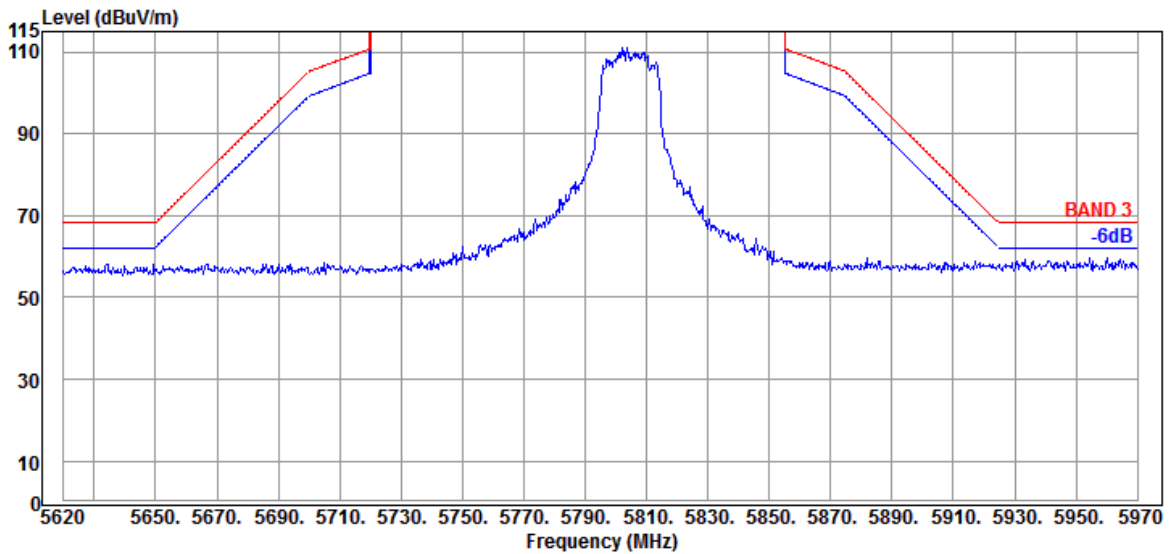

Mode	802.11ax-HE80	U-NII Band	1
RU Configuration	484/65	Frequency	TX 5210MHz

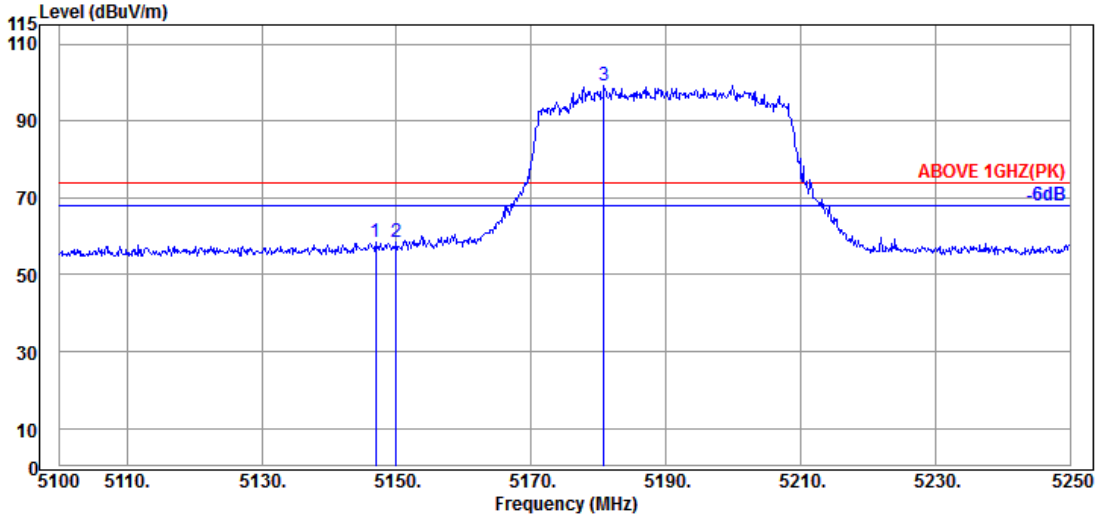

Antenna at Horizontal Polarization

Emission Frequency (MHz)	Antenna Factor (dB/m)	Cable Loss (dB)	Preamplifier Gain (dB)	Read Level (dBμV)	Emission Level (dBμV/m)	Limits (dBμV/m)	Margin (dB)	Detector
5146.950	34.50	8.88	34.34	49.31	58.35	74.00	15.65	Peak
5149.950	34.50	8.88	34.34	49.27	58.31	74.00	15.69	Peak
@ 5180.850	34.63	8.90	34.32	90.05	99.26	---	---	Peak

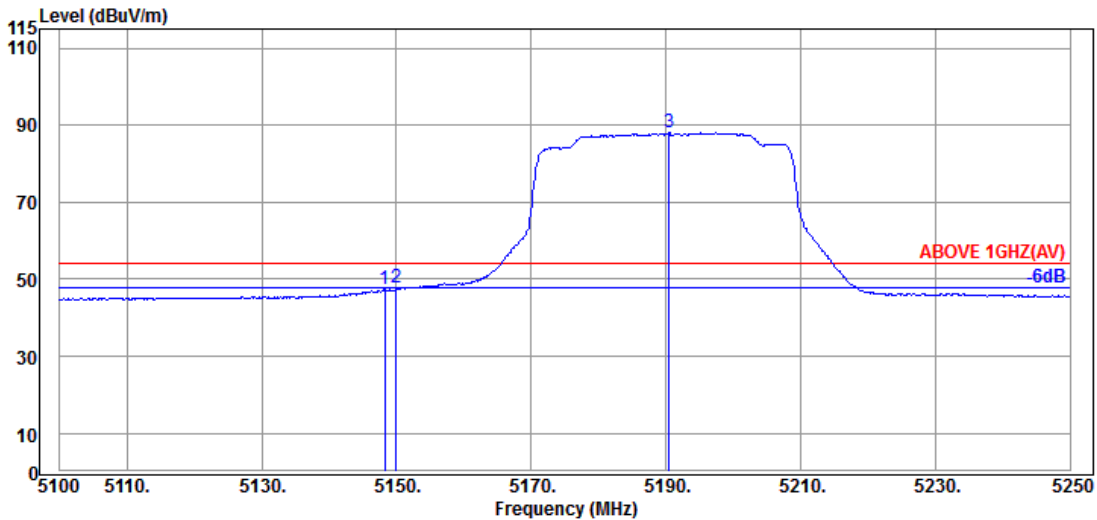

Antenna at Horizontal Polarization

Emission Frequency (MHz)	Antenna Factor (dB/m)	Cable Loss (dB)	Preamplifier Gain (dB)	Read Level (dBμV)	Emission Level (dBμV/m)	Limits (dBμV/m)	Margin (dB)	Detector
5148.300	34.50	8.88	34.34	38.32	47.36	54.00	6.64	Average
5149.950	34.50	8.88	34.34	38.59	47.63	54.00	6.37	Average
@ 5190.450	34.70	8.91	34.32	78.78	88.07	---	---	Average

Remark: The “@” means fundamental frequency, it is ignored in this section.

Mode	802.11ax-HE80	U-NII Band	1
RU Configuration	484/65	Frequency	TX 5210MHz

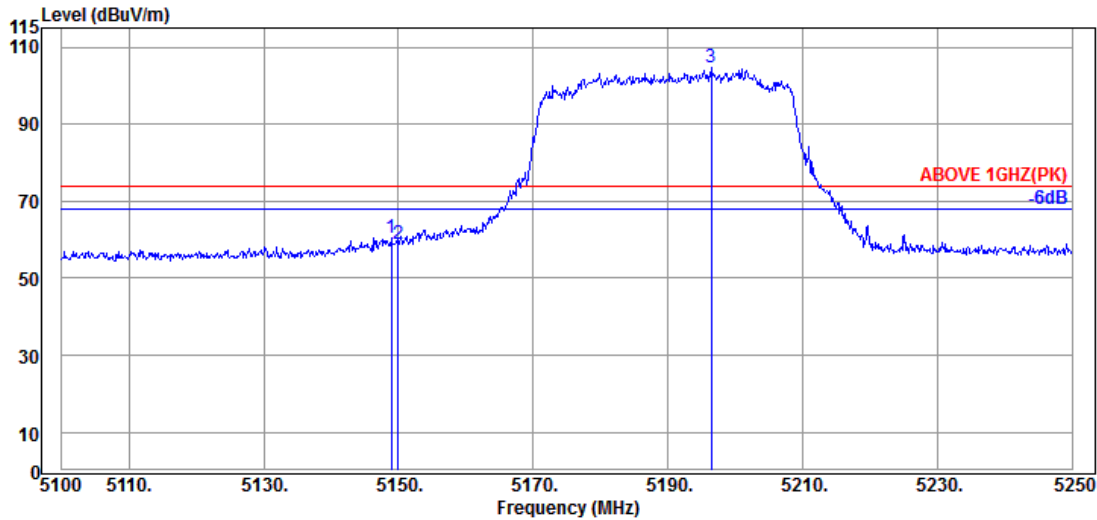

Antenna at Vertical Polarization

Emission Frequency (MHz)	Antenna Factor (dB/m)	Cable Loss (dB)	Preamp Gain (dB)	Read Level (dBμV)	Emission Level (dBμV/m)	Limits (dBμV/m)	Margin (dB)	Detector
5148.900	34.50	8.88	34.34	51.48	60.52	74.00	13.48	Peak
5149.950	34.50	8.88	34.34	49.89	58.93	74.00	15.07	Peak
@ 5196.450	34.70	8.91	34.32	95.48	104.77	---	---	Peak

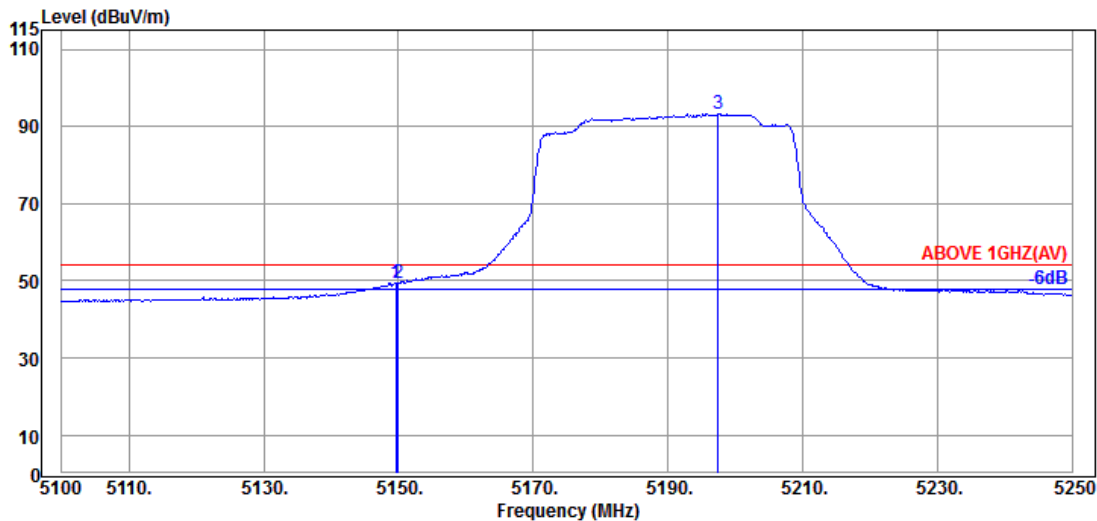

Antenna at Vertical Polarization

Emission Frequency (MHz)	Antenna Factor (dB/m)	Cable Loss (dB)	Preamp Gain (dB)	Read Level (dBμV)	Emission Level (dBμV/m)	Limits (dBμV/m)	Margin (dB)	Detector
5149.650	34.50	8.88	34.34	40.40	49.44	54.00	4.56	Average
5149.950	34.50	8.88	34.34	40.36	49.40	54.00	4.60	Average
@ 5197.500	34.70	8.91	34.32	83.93	93.22	---	---	Average

Remark: The “@” means fundamental frequency, it is ignored in this section.

Mode	802.11ax-HE80	U-NII Band	2A
RU Configuration	484/66	Frequency	TX 5290MHz

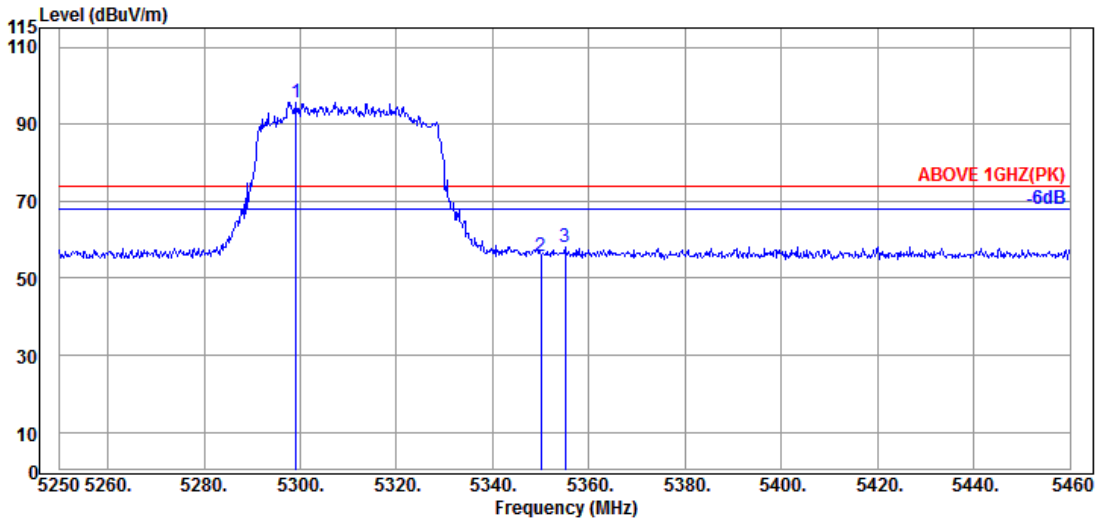

Antenna at Horizontal Polarization

Emission Frequency (MHz)	Antenna Factor (dB/m)	Cable Loss (dB)	Preamp Gain (dB)	Read Level (dBμV)	Emission Level (dBμV/m)	Limits (dBμV/m)	Margin (dB)	Detector
@ 5299.140	34.40	8.97	34.28	86.55	95.64	---	---	Peak
5349.960	34.90	8.99	34.26	46.21	55.84	74.00	18.16	Peak
5355.000	34.87	9.00	34.26	48.52	58.13	74.00	15.87	Peak

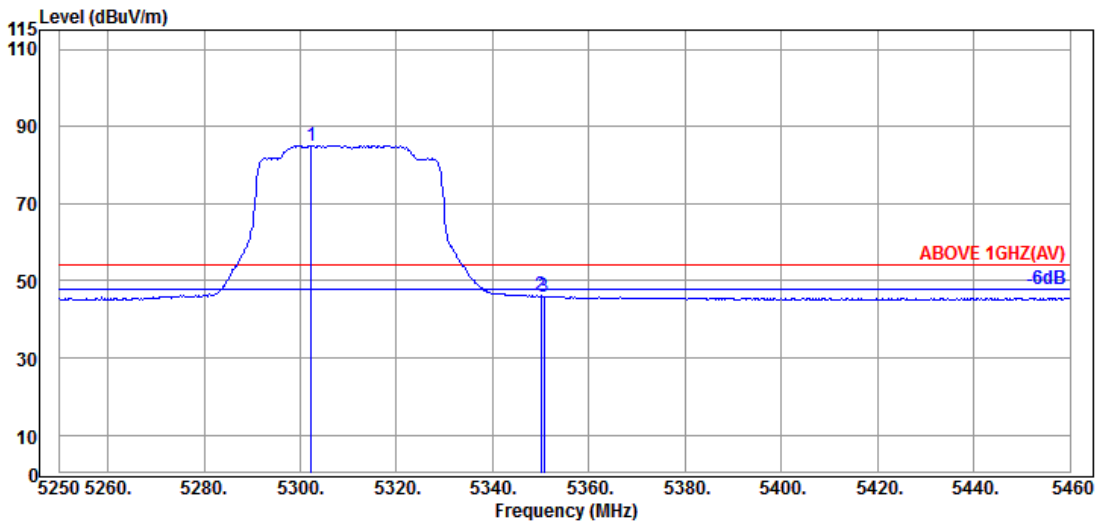

Antenna at Horizontal Polarization

Emission Frequency (MHz)	Antenna Factor (dB/m)	Cable Loss (dB)	Preamp Gain (dB)	Read Level (dBμV)	Emission Level (dBμV/m)	Limits (dBμV/m)	Margin (dB)	Detector
@ 5302.290	34.40	8.97	34.28	76.06	85.15	---	---	Average
5349.960	34.90	8.99	34.26	36.47	46.10	54.00	7.90	Average
5350.590	34.90	8.99	34.26	36.39	46.02	54.00	7.98	Average

Remark: The “@” means fundamental frequency, it is ignored in this section.

Mode	802.11ax-HE80	U-NII Band	2A
RU Configuration	484/66	Frequency	TX 5290MHz

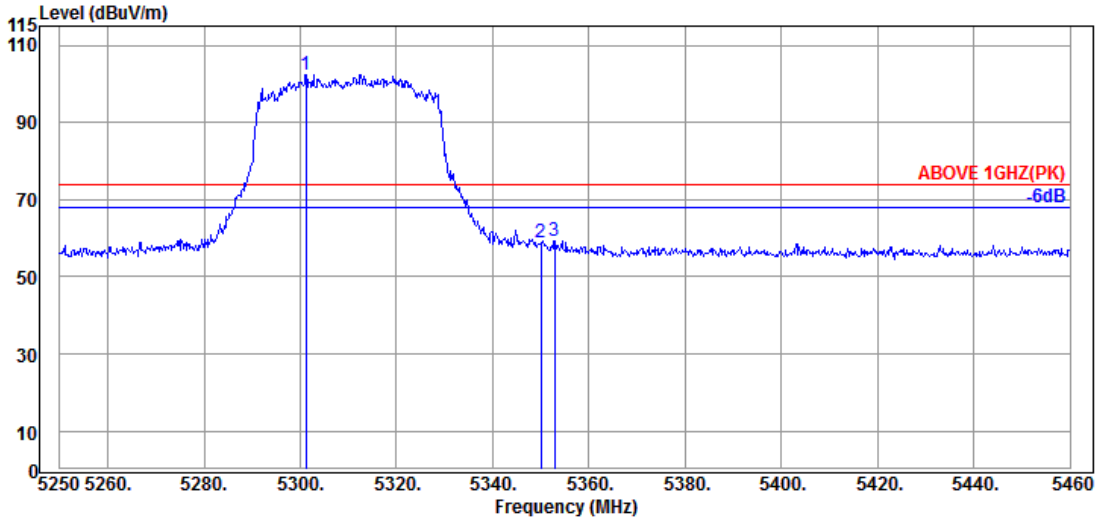

Antenna at Vertical Polarization

Emission Frequency (MHz)	Antenna Factor (dB/m)	Cable Loss (dB)	Preamplifier Gain (dB)	Read Level (dBμV)	Emission Level (dBμV/m)	Limits (dBμV/m)	Margin (dB)	Detector
@ 5301.240	34.40	8.97	34.28	93.33	102.42	---	---	Peak
5349.960	34.90	8.99	34.26	49.16	58.79	74.00	15.21	Peak
5352.900	34.90	8.99	34.26	49.79	59.42	74.00	14.58	Peak

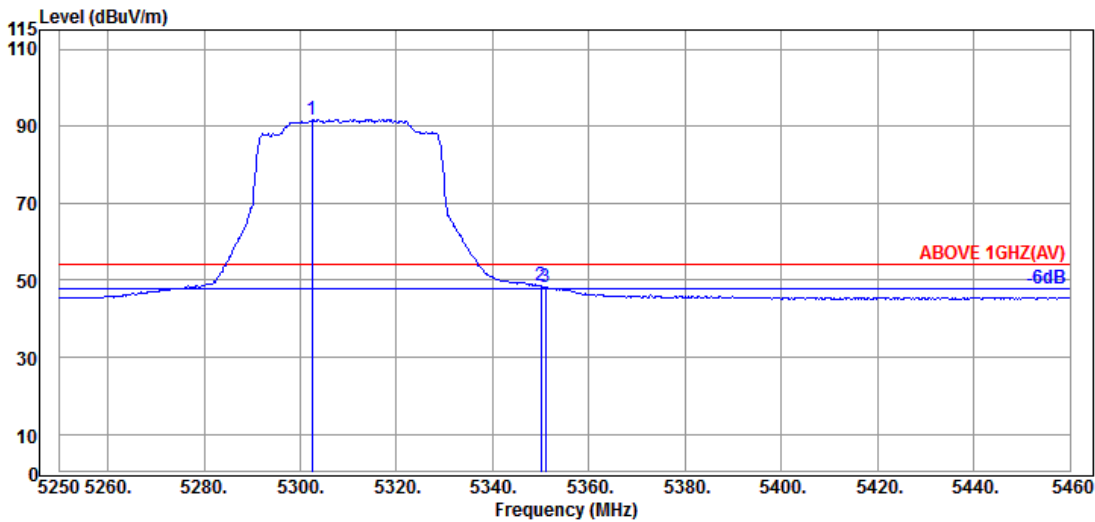

Antenna at Vertical Polarization

Emission Frequency (MHz)	Antenna Factor (dB/m)	Cable Loss (dB)	Preamplifier Gain (dB)	Read Level (dBμV)	Emission Level (dBμV/m)	Limits (dBμV/m)	Margin (dB)	Detector
@ 5302.500	34.40	8.97	34.28	82.62	91.71	---	---	Average
5349.960	34.90	8.99	34.26	39.00	48.63	54.00	5.37	Average
5351.010	34.90	8.99	34.26	38.71	48.34	54.00	5.66	Average

Remark: The “@” means fundamental frequency, it is ignored in this section.

Mode	802.11ax-HE80	U-NII Band	2C
RU Configuration	484/65	Frequency	TX 5530MHz

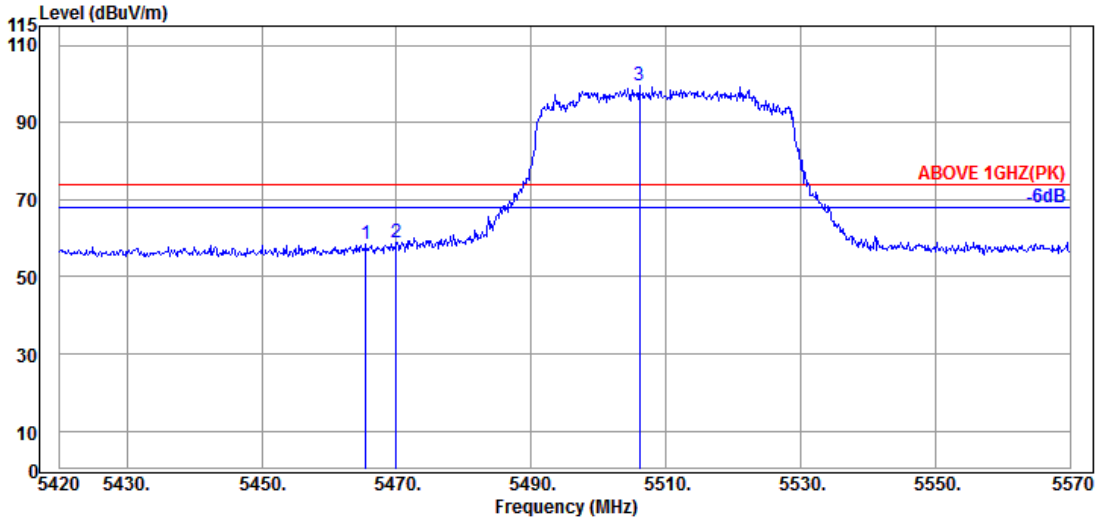

Antenna at Horizontal Polarization

Emission Frequency (MHz)	Antenna Factor (dB/m)	Cable Loss (dB)	Preamplifier Gain (dB)	Read Level (dBμV)	Emission Level (dBμV/m)	Limits (dBμV/m)	Margin (dB)	Detector
5465.450	34.63	9.06	34.21	48.89	58.37	74.00	15.63	Peak
5469.950	34.63	9.06	34.21	49.50	58.98	74.00	15.02	Peak
@ 5506.100	34.70	9.08	34.21	90.07	99.64	---	---	Peak

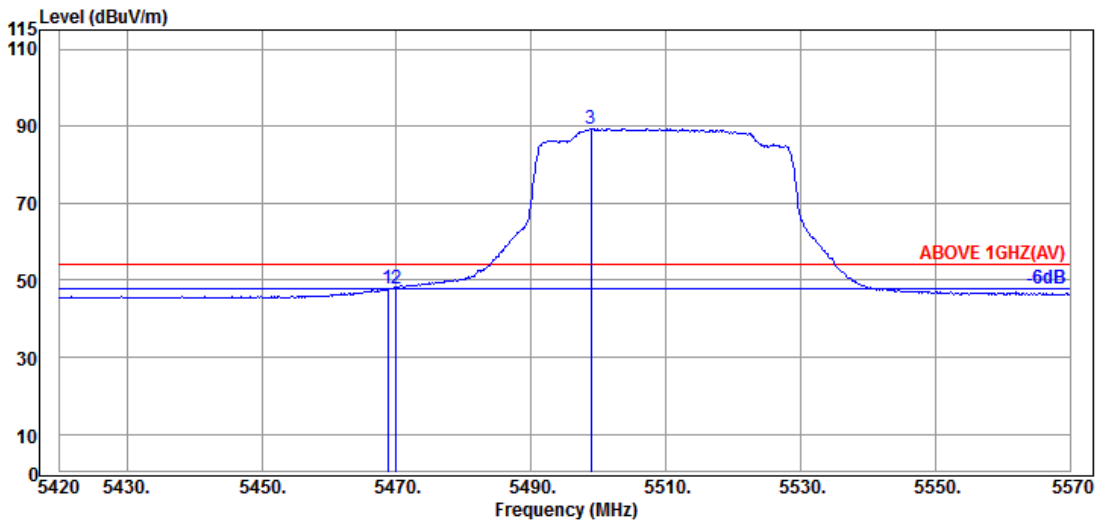

Antenna at Horizontal Polarization

Emission Frequency (MHz)	Antenna Factor (dB/m)	Cable Loss (dB)	Preamplifier Gain (dB)	Read Level (dBμV)	Emission Level (dBμV/m)	Limits (dBμV/m)	Margin (dB)	Detector
5468.750	34.63	9.06	34.21	38.28	47.76	54.00	6.24	Average
5469.950	34.63	9.06	34.21	38.28	47.76	54.00	6.24	Average
@ 5498.900	34.70	9.08	34.20	79.76	89.34	---	---	Average

Remark: The “@” means fundamental frequency, it is ignored in this section.

Mode	802.11ax-HE80	U-NII Band	2C
RU Configuration	484/65	Frequency	TX 5530MHz

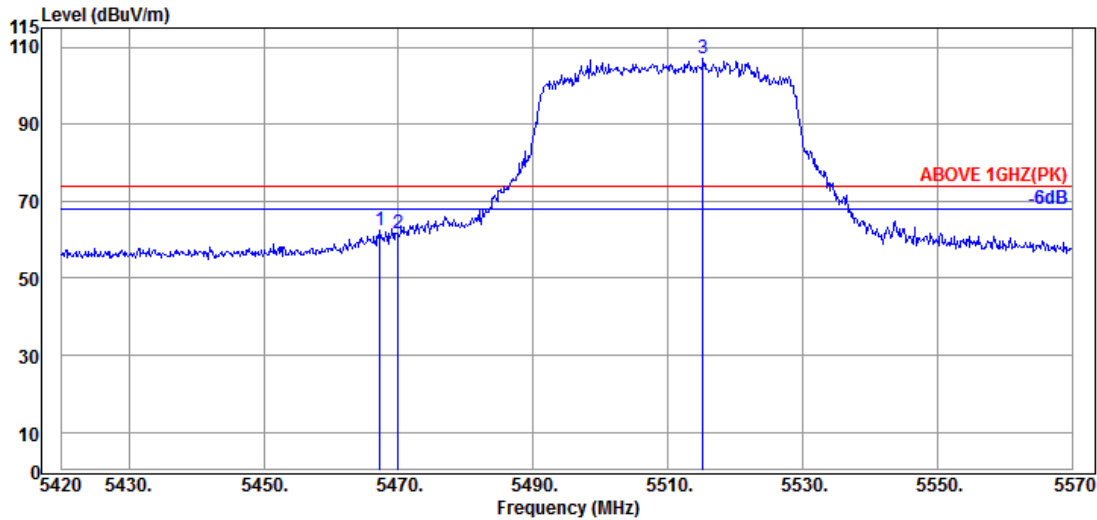

Antenna at Vertical Polarization

Emission Frequency (MHz)	Antenna Factor (dB/m)	Cable Loss (dB)	Preamp Gain (dB)	Read Level (dBμV)	Emission Level (dBμV/m)	Limits (dBμV/m)	Margin (dB)	Detector
5467.250	34.63	9.06	34.21	53.00	62.48	74.00	11.52	Peak
5469.950	34.63	9.06	34.21	52.34	61.82	74.00	12.18	Peak
@ 5515.250	34.70	9.09	34.21	97.36	106.94	---	---	Peak

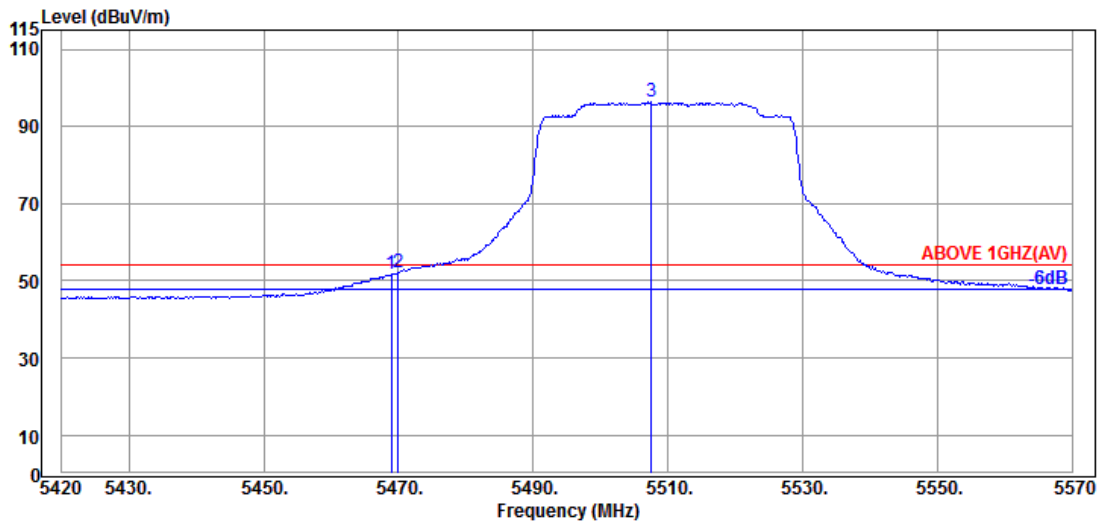

Antenna at Vertical Polarization

Emission Frequency (MHz)	Antenna Factor (dB/m)	Cable Loss (dB)	Preamp Gain (dB)	Read Level (dBμV)	Emission Level (dBμV/m)	Limits (dBμV/m)	Margin (dB)	Detector
5468.900	34.63	9.06	34.21	42.36	51.84	54.00	2.16	Average
5469.950	34.63	9.06	34.21	42.49	51.97	54.00	2.03	Average
@ 5507.600	34.70	9.08	34.21	86.71	96.28	---	---	Average

Remark: The “@” means fundamental frequency, it is ignored in this section.

Mode	802.11ax-HE80	U-NII Band	2C
RU Configuration	484/66	Frequency	TX 5610MHz

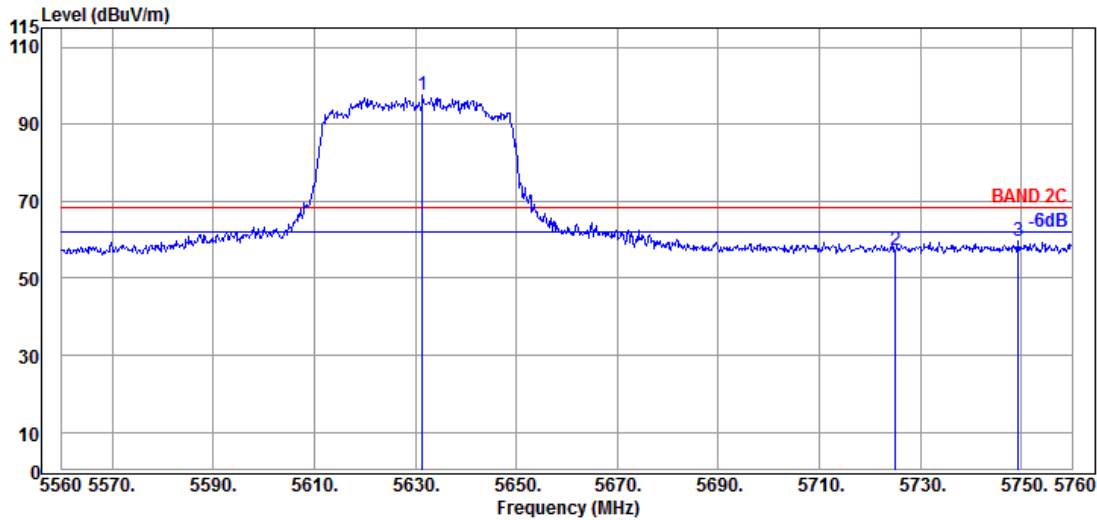

Antenna at Horizontal Polarization

Emission Frequency (MHz)	Antenna Factor (dB/m)	Cable Loss (dB)	Preamplifier Gain (dB)	Read Level (dBμV)	Emission Level (dBμV/m)	Limits (dBμV/m)	Margin (dB)	Detector
@ 5631.400	34.47	9.14	34.26	88.26	97.61	---	---	Peak
5725.000	34.90	9.20	34.30	47.62	57.42	68.20	10.78	Peak
5749.400	35.00	9.20	34.32	49.85	59.73	68.20	8.47	Peak

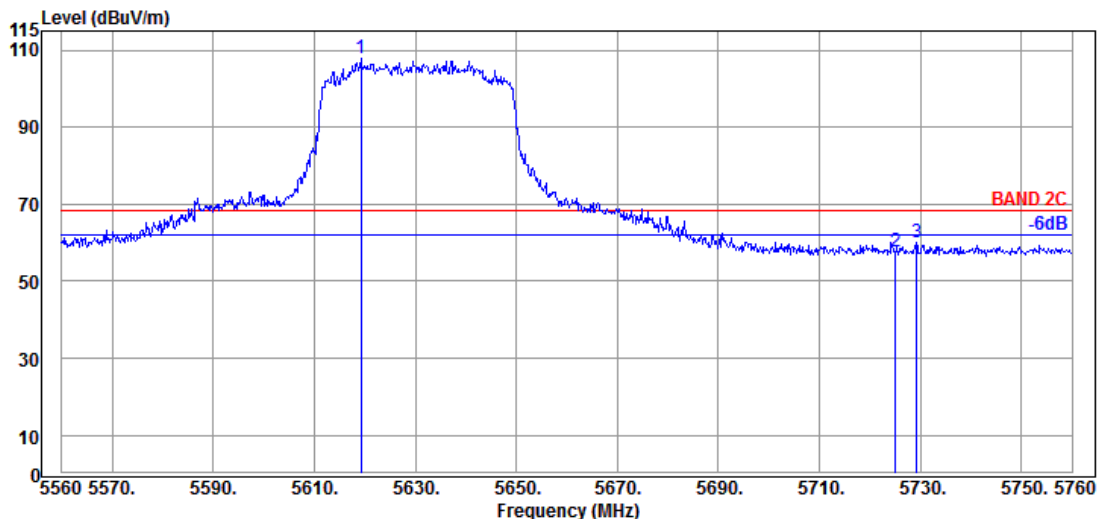

Antenna at Vertical Polarization

Emission Frequency (MHz)	Antenna Factor (dB/m)	Cable Loss (dB)	Preamplifier Gain (dB)	Read Level (dBμV)	Emission Level (dBμV/m)	Limits (dBμV/m)	Margin (dB)	Detector
@ 5619.200	34.43	9.14	34.26	98.44	107.75	---	---	Peak
5725.000	34.90	9.20	34.30	47.95	57.75	68.20	10.45	Peak
5729.200	34.90	9.20	34.31	50.10	59.89	68.20	8.31	Peak

Remark: The “@” means fundamental frequency, it is ignored in this section.

Mode	802.11ax-HE80	U-NII Band	3
RU Configuration	484/65	Frequency	TX 5775MHz

Antenna at Horizontal Polarization

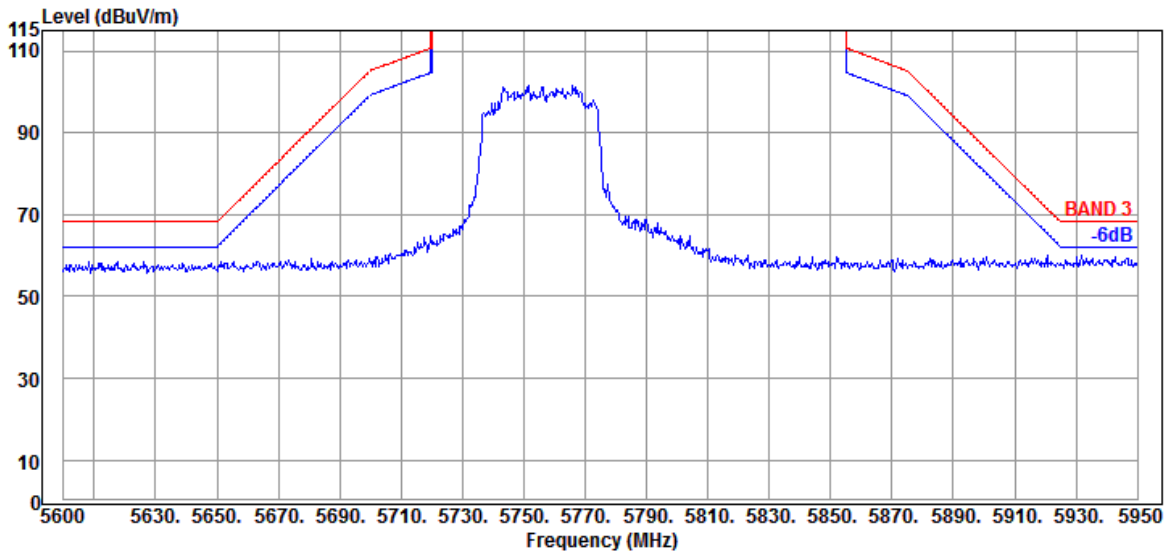

Antenna at Vertical Polarization

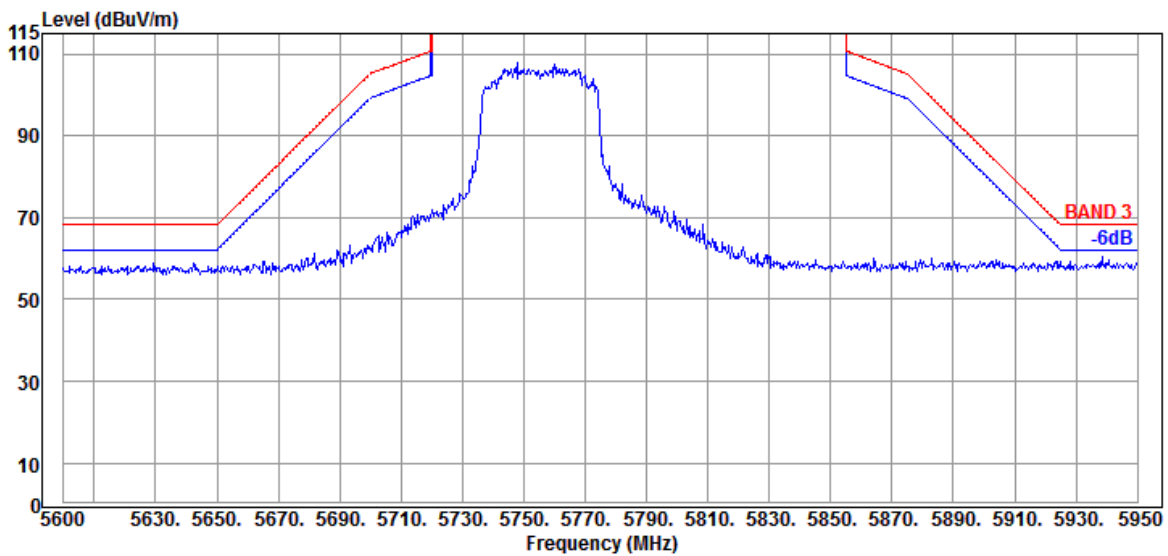

Mode	802.11ax-HE80	U-NII Band	3
RU Configuration	484/66	Frequency	TX 5775MHz

Antenna at Horizontal Polarization

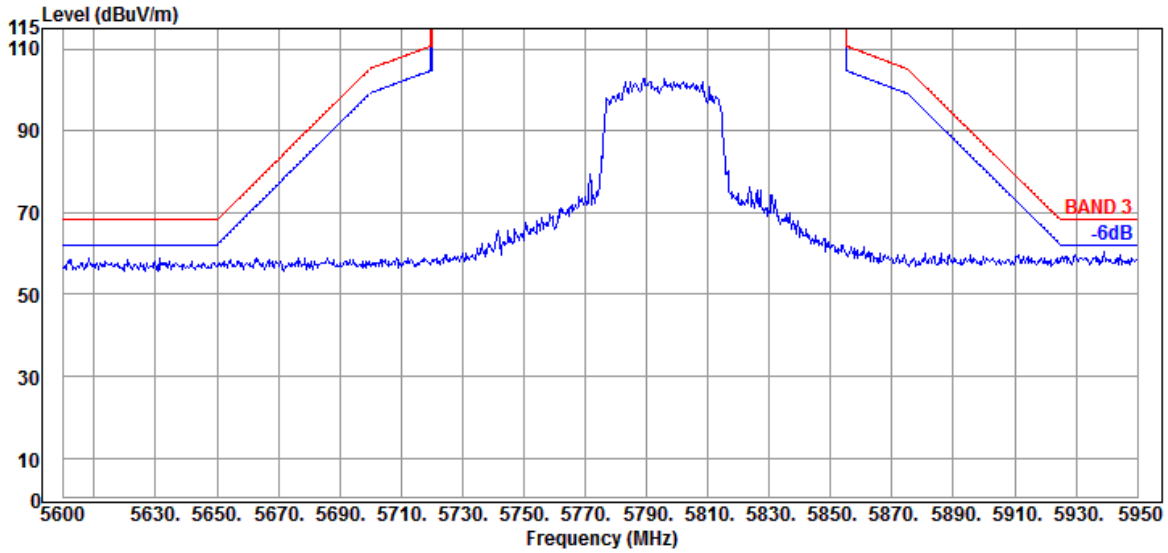

Antenna at Vertical Polarization

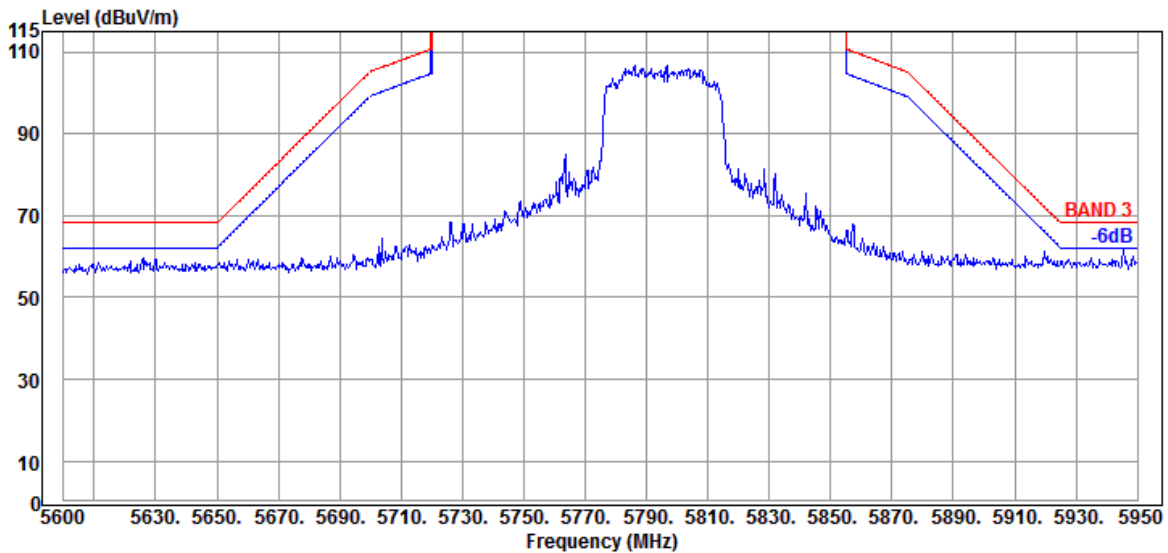

Mode	802.11ax-HE160	U-NII Band	1 & 2A
RU Configuration	996/67	Frequency	TX 5250MHz

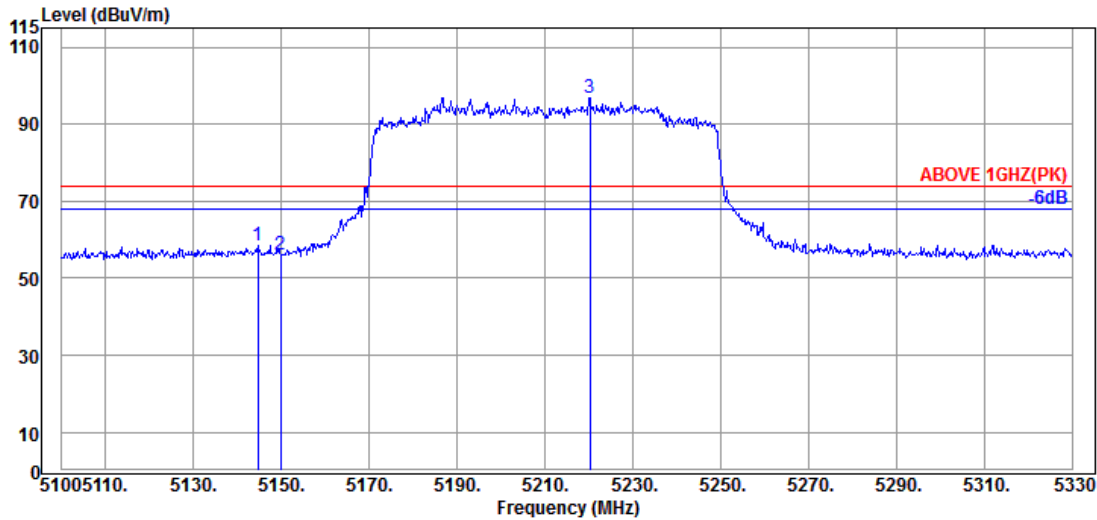

Antenna at Horizontal Polarization

Emission Frequency (MHz)	Antenna Factor (dB/m)	Cable Loss (dB)	Preamp Gain (dB)	Read Level (dBμV)	Emission Level (dBμV/m)	Limits (dBμV/m)	Margin (dB)	Detector
5144.620	34.50	8.88	34.34	49.43	58.47	74.00	15.53	Peak
5149.910	34.50	8.88	34.34	47.13	56.17	74.00	17.83	Peak
@ 5220.290	34.60	8.93	34.31	87.57	96.79	---	---	Peak

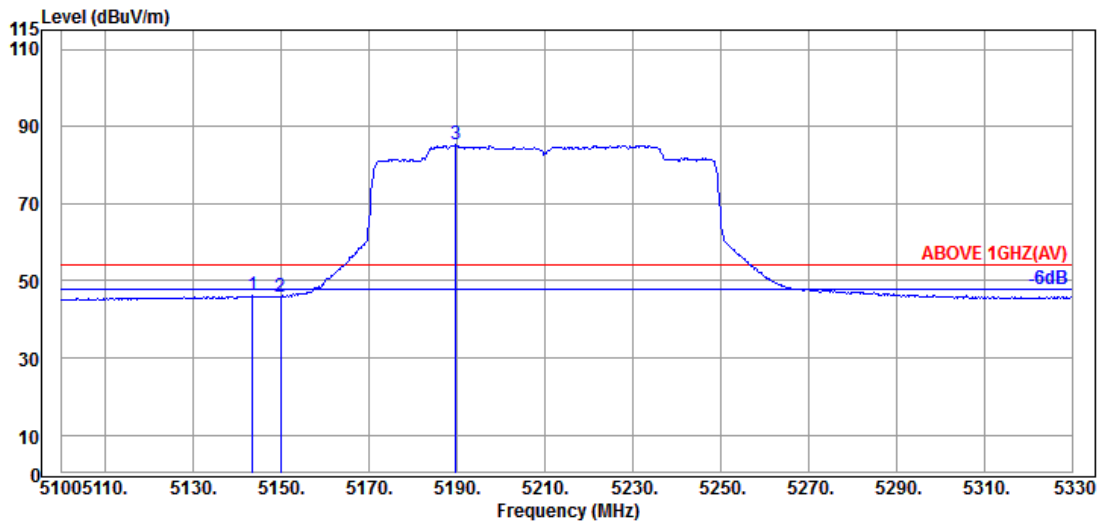

Antenna at Horizontal Polarization

Emission Frequency (MHz)	Antenna Factor (dB/m)	Cable Loss (dB)	Preamp Gain (dB)	Read Level (dBμV)	Emission Level (dBμV/m)	Limits (dBμV/m)	Margin (dB)	Detector
5143.470	34.50	8.88	34.34	37.04	46.08	54.00	7.92	Average
5149.910	34.50	8.88	34.34	36.79	45.83	54.00	8.17	Average
@ 5189.700	34.70	8.91	34.32	75.91	85.20	---	---	Average

Remark: The “@” means fundamental frequency, it is ignored in this section.

Mode	802.11ax-HE160	U-NII Band	1 & 2A
RU Configuration	996/67	Frequency	TX 5250MHz

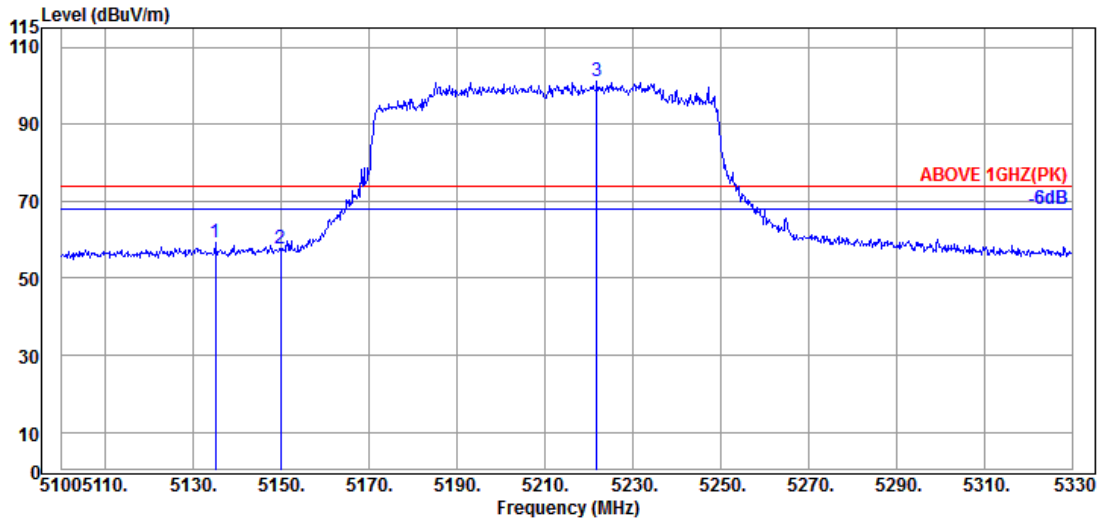

Antenna at Vertical Polarization

Emission Frequency (MHz)	Antenna Factor (dB/m)	Cable Loss (dB)	Preamplifier Gain (dB)	Read Level (dBμV)	Emission Level (dBμV/m)	Limits (dBμV/m)	Margin (dB)	Detector
5134.960	34.40	8.88	34.34	50.34	59.28	74.00	14.72	Peak
5149.910	34.50	8.88	34.34	48.66	57.70	74.00	16.30	Peak
@ 5221.900	34.60	8.93	34.31	91.77	100.99	---	---	Peak

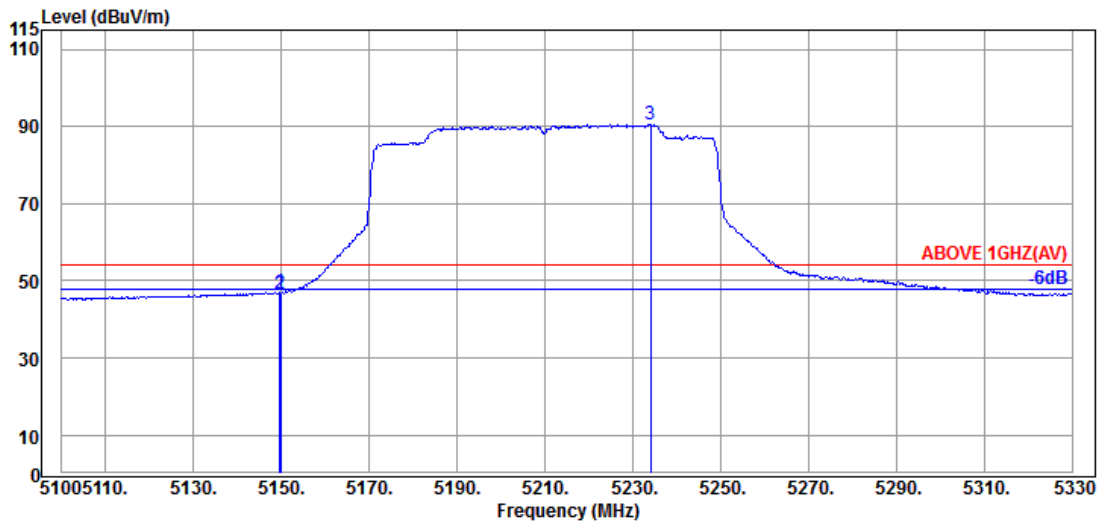

Antenna at Vertical Polarization

Emission Frequency (MHz)	Antenna Factor (dB/m)	Cable Loss (dB)	Preamplifier Gain (dB)	Read Level (dBμV)	Emission Level (dBμV/m)	Limits (dBμV/m)	Margin (dB)	Detector
5149.680	34.50	8.88	34.34	37.90	46.94	54.00	7.06	Average
5149.910	34.50	8.88	34.34	37.73	46.77	54.00	7.23	Average
@ 5234.090	34.55	8.93	34.30	81.34	90.52	---	---	Average

Remark: The “@” means fundamental frequency, it is ignored in this section.

Mode	802.11ax-HE160	U-NII Band	1 & 2A
RU Configuration	996/S67	Frequency	TX 5250MHz

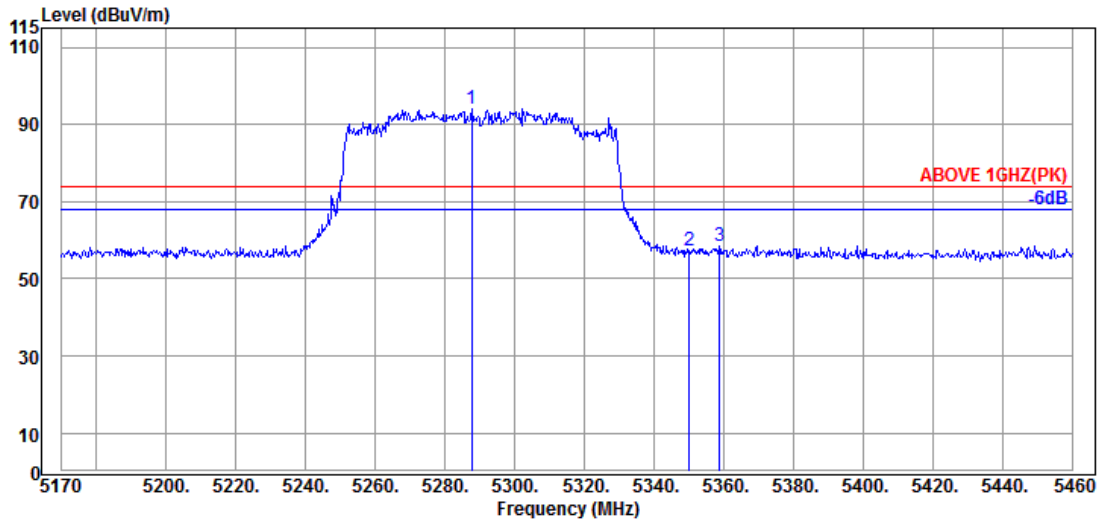

Antenna at Horizontal Polarization

Emission Frequency (MHz)	Antenna Factor (dB/m)	Cable Loss (dB)	Preamplifier Gain (dB)	Read Level (dBμV)	Emission Level (dBμV/m)	Limits (dBμV/m)	Margin (dB)	Detector
@ 5287.740	34.43	8.96	34.28	85.11	94.22	---	---	Peak
5350.090	34.90	8.99	34.26	47.63	57.26	74.00	16.74	Peak
5358.790	34.87	9.00	34.26	48.87	58.48	74.00	15.52	Peak

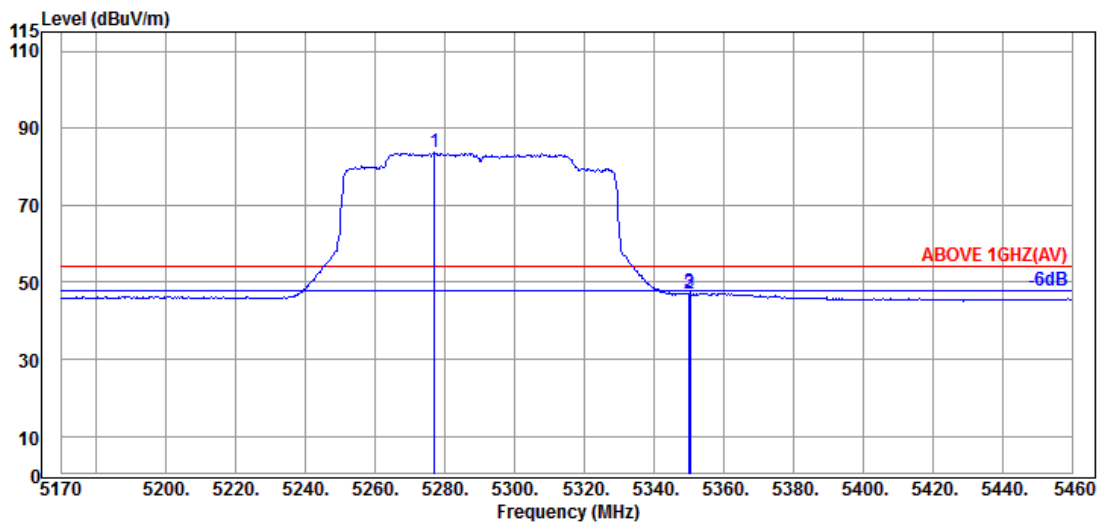

Antenna at Horizontal Polarization

Emission Frequency (MHz)	Antenna Factor (dB/m)	Cable Loss (dB)	Preamplifier Gain (dB)	Read Level (dBμV)	Emission Level (dBμV/m)	Limits (dBμV/m)	Margin (dB)	Detector
@ 5277.010	34.47	8.95	34.28	74.47	83.61	---	---	Average
5350.090	34.90	8.99	34.26	37.44	47.07	54.00	6.93	Average
5350.380	34.90	8.99	34.26	37.73	47.36	54.00	6.64	Average

Remark: The “@” means fundamental frequency, it is ignored in this section.

Mode	802.11ax-HE160	U-NII Band	1 & 2A
RU Configuration	996/S67	Frequency	TX 5250MHz

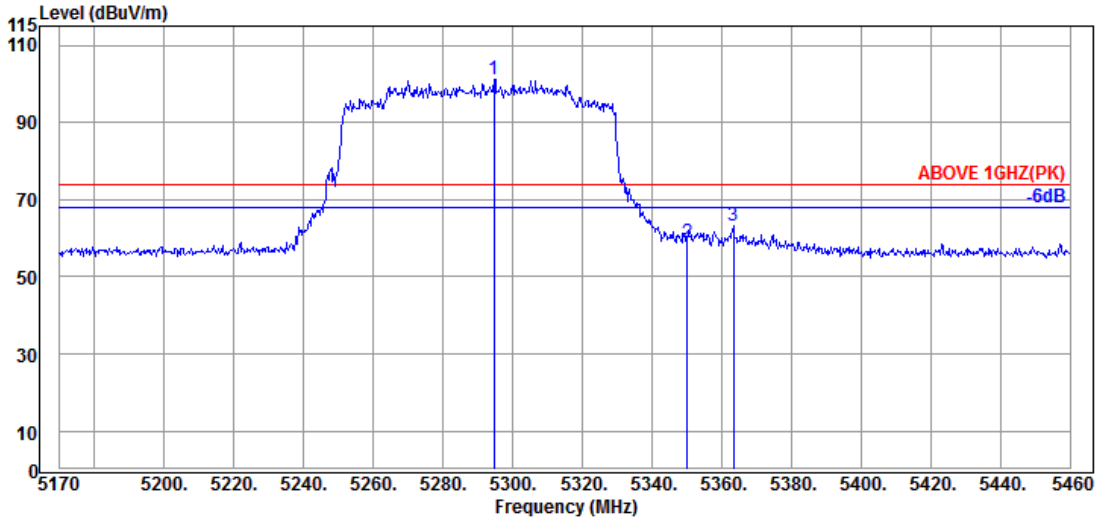

Antenna at Vertical Polarization

Emission Frequency (MHz)	Antenna Factor (dB/m)	Cable Loss (dB)	Preamplifier Gain (dB)	Read Level (dBμV)	Emission Level (dBμV/m)	Limits (dBμV/m)	Margin (dB)	Detector
@ 5294.700	34.40	8.97	34.28	91.96	101.05	---	---	Peak
5350.090	34.90	8.99	34.26	49.42	59.05	74.00	14.95	Peak
5363.430	34.87	9.00	34.25	53.76	63.38	74.00	10.62	Peak

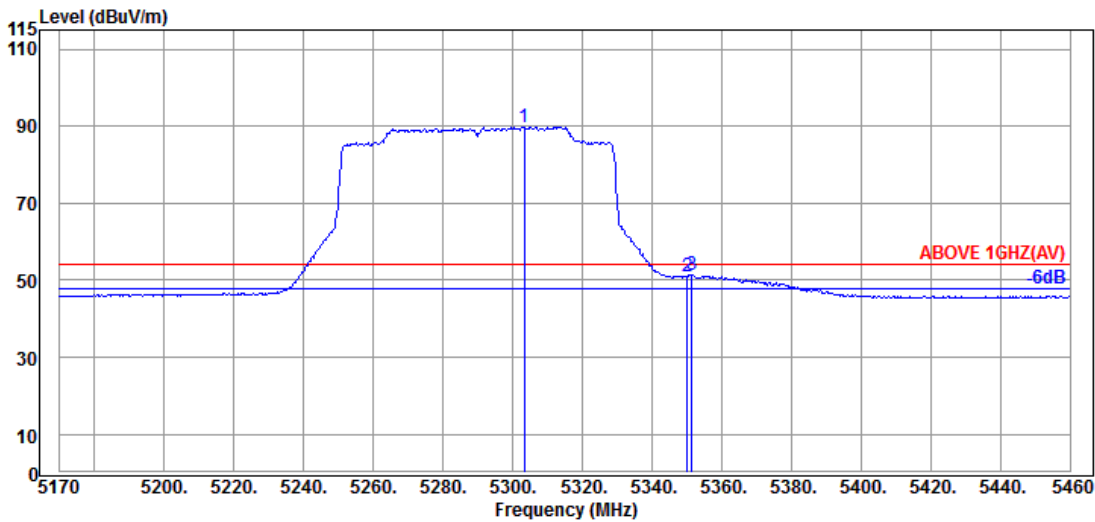

Antenna at Vertical Polarization

Emission Frequency (MHz)	Antenna Factor (dB/m)	Cable Loss (dB)	Preamplifier Gain (dB)	Read Level (dBμV)	Emission Level (dBμV/m)	Limits (dBμV/m)	Margin (dB)	Detector
@ 5303.400	34.40	8.97	34.28	80.78	89.87	---	---	Average
5350.090	34.90	8.99	34.26	41.32	50.95	54.00	3.05	Average
5351.540	34.90	8.99	34.26	41.87	51.50	54.00	2.50	Average

Remark: The “@” means fundamental frequency, it is ignored in this section.

Mode	802.11ax-HE160	U-NII Band	2C
RU Configuration	996/67	Frequency	TX 5570MHz

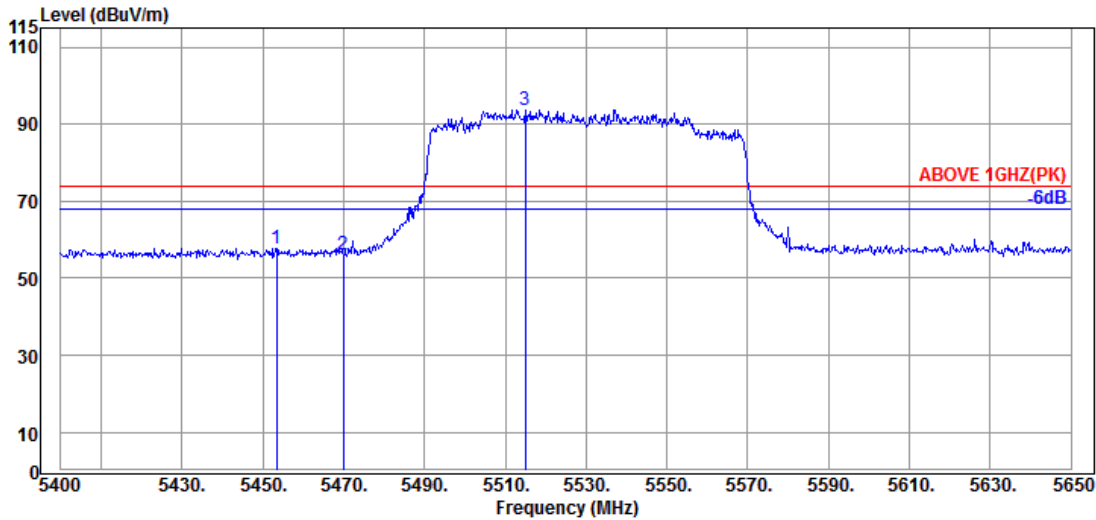

Antenna at Horizontal Polarization

Emission Frequency (MHz)	Antenna Factor (dB/m)	Cable Loss (dB)	Preamplifier Gain (dB)	Read Level (dBμV)	Emission Level (dBμV/m)	Limits (dBμV/m)	Margin (dB)	Detector
5453.500	34.60	9.05	34.21	48.42	57.86	74.00	16.14	Peak
5470.000	34.63	9.06	34.21	46.51	55.99	74.00	18.01	Peak
@ 5515.000	34.70	9.09	34.21	84.24	93.82	---	---	Peak

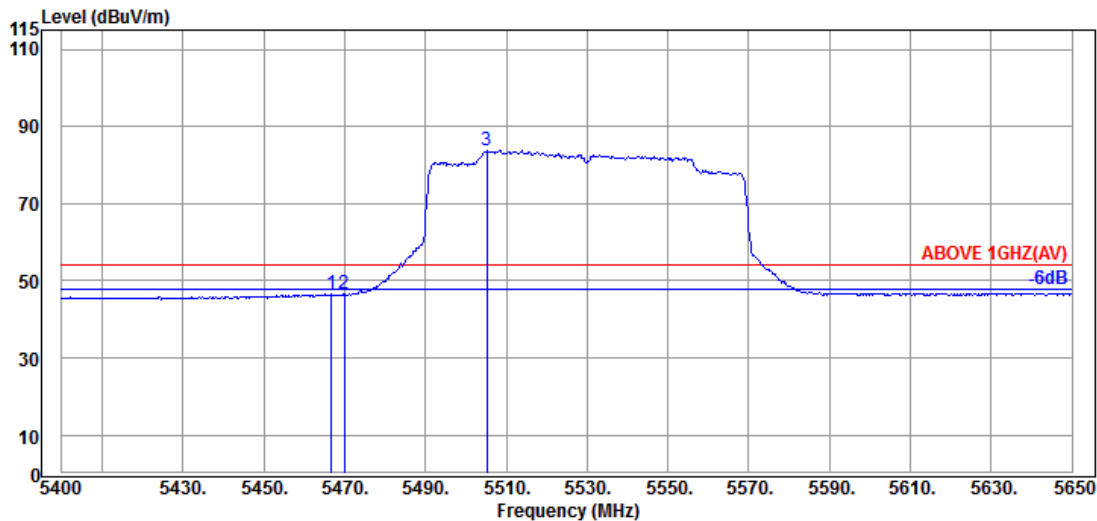

Antenna at Horizontal Polarization

Emission Frequency (MHz)	Antenna Factor (dB/m)	Cable Loss (dB)	Preamplifier Gain (dB)	Read Level (dBμV)	Emission Level (dBμV/m)	Limits (dBμV/m)	Margin (dB)	Detector
5466.750	34.63	9.06	34.21	37.07	46.55	54.00	7.45	Average
5470.000	34.63	9.06	34.21	36.97	46.45	54.00	7.55	Average
@ 5505.250	34.70	9.08	34.20	74.18	83.76	---	---	Average

Remark: The “@” means fundamental frequency, it is ignored in this section.

Mode	802.11ax-HE160	U-NII Band	2C
RU Configuration	996/67	Frequency	TX 5570MHz

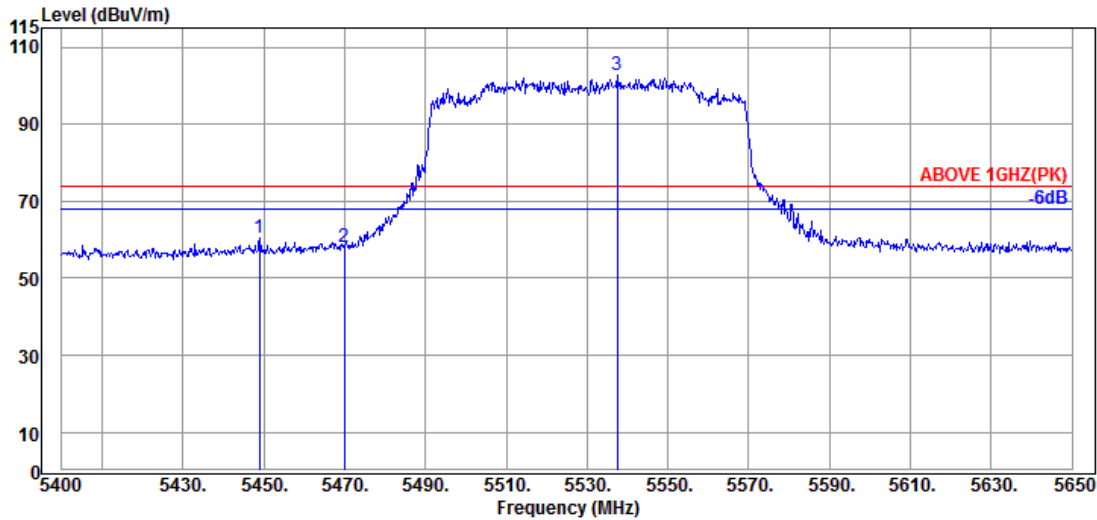

Antenna at Vertical Polarization

Emission Frequency (MHz)	Antenna Factor (dB/m)	Cable Loss (dB)	Preamp Gain (dB)	Read Level (dBμV)	Emission Level (dBμV/m)	Limits (dBμV/m)	Margin (dB)	Detector
5449.000	34.60	9.05	34.22	51.00	60.43	74.00	13.57	Peak
5470.000	34.63	9.06	34.21	48.79	58.27	74.00	15.73	Peak
@ 5537.500	34.70	9.09	34.22	93.26	102.83	---	---	Peak

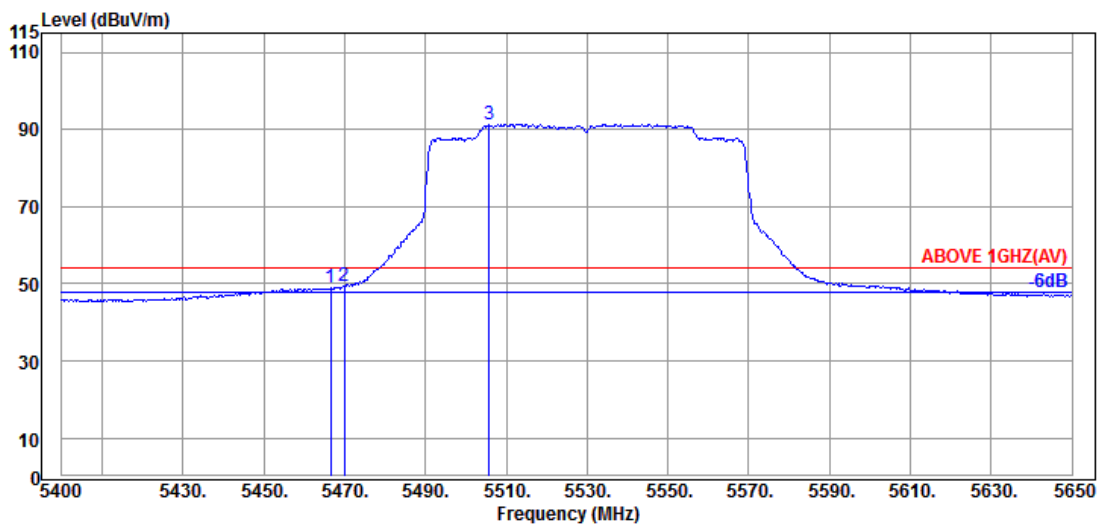

Antenna at Vertical Polarization

Emission Frequency (MHz)	Antenna Factor (dB/m)	Cable Loss (dB)	Preamp Gain (dB)	Read Level (dBμV)	Emission Level (dBμV/m)	Limits (dBμV/m)	Margin (dB)	Detector
5466.500	34.63	9.06	34.21	39.54	49.02	54.00	4.98	Average
5470.000	34.63	9.06	34.21	39.99	49.47	54.00	4.53	Average
@ 5505.750	34.70	9.08	34.21	81.90	91.47	---	---	Average

Remark: The “@” means fundamental frequency, it is ignored in this section.

Mode	802.11ax-HE160	U-NII Band	2C
RU Configuration	996/S67	Frequency	TX 5570MHz

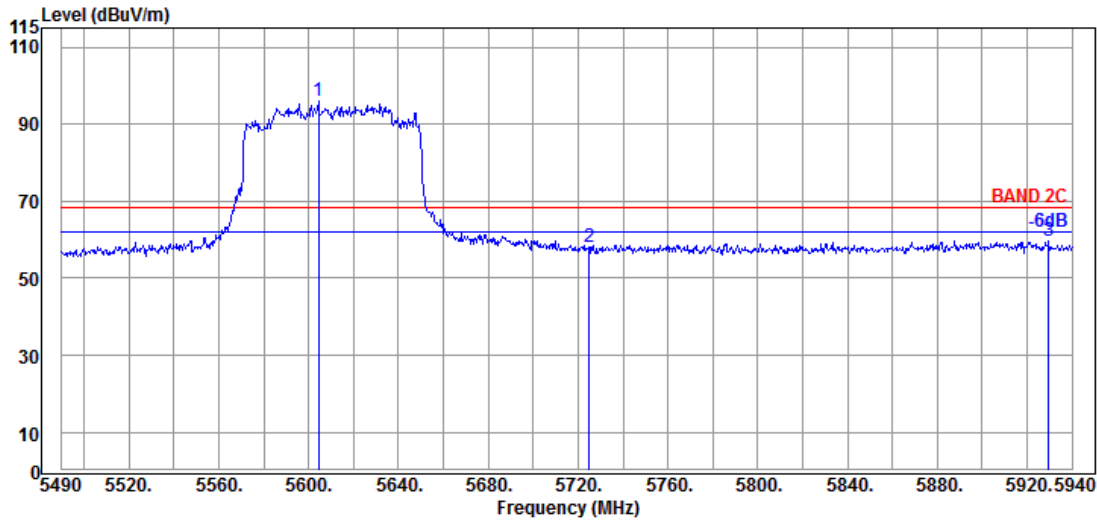

Antenna at Horizontal Polarization

Emission Frequency (MHz)	Antenna Factor (dB/m)	Cable Loss (dB)	Preamplifier Gain (dB)	Read Level (dBμV)	Emission Level (dBμV/m)	Limits (dBμV/m)	Margin (dB)	Detector
@ 5604.300	34.40	9.13	34.25	86.72	96.00	---	---	Peak
5724.900	34.90	9.20	34.30	48.13	57.93	68.20	10.27	Peak
5929.650	35.73	9.30	34.40	48.95	59.58	68.20	8.62	Peak

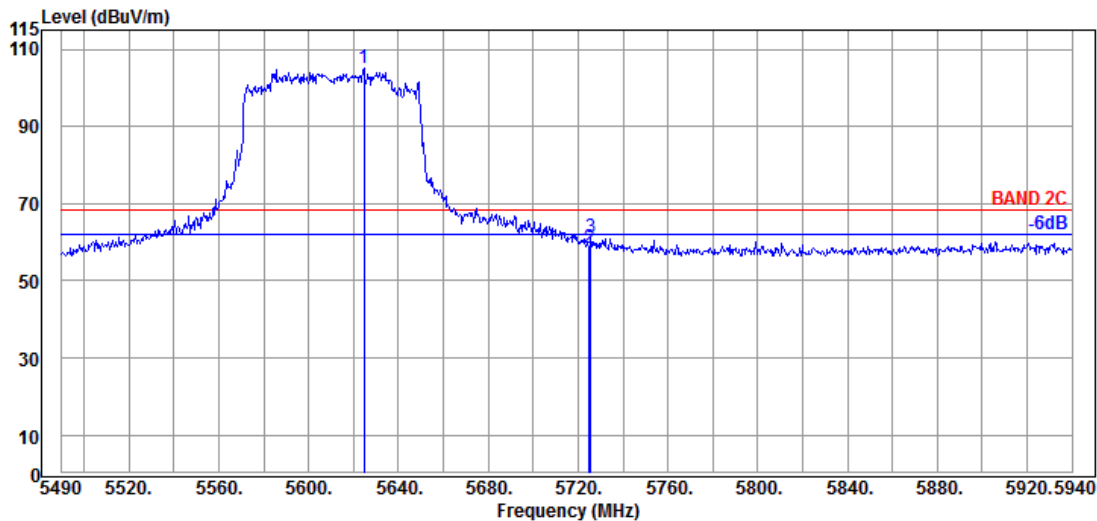

Antenna at Vertical Polarization

Emission Frequency (MHz)	Antenna Factor (dB/m)	Cable Loss (dB)	Preamplifier Gain (dB)	Read Level (dBμV)	Emission Level (dBμV/m)	Limits (dBμV/m)	Margin (dB)	Detector
@ 5624.550	34.47	9.14	34.26	95.68	105.03	---	---	Peak
5724.900	34.90	9.20	34.30	48.65	58.45	68.20	9.75	Peak
5725.800	34.90	9.20	34.30	51.28	61.08	68.20	7.12	Peak

Remark: The “@” means fundamental frequency, it is ignored in this section.

A.2.2 Emissions outside the frequency band

The emissions (up to 40GHz) not reported for there is no emission be found.

Mode	802.11a	U-NII Band	1
		Frequency	TX 5180MHz

Antenna at Horizontal Polarization

Emission Frequency (MHz)	Antenna Factor (dB/m)	Cable Loss (dB)	Preamp Gain (dB)	Read Level (dBμV)	Emission Level (dBμV/m)	Limits (dBμV/m)	Margin (dB)	Detector
10360.000	37.60	12.61	34.79	32.55	47.97	54.00	6.03	Peak

Antenna at Vertical Polarization

Emission Frequency (MHz)	Antenna Factor (dB/m)	Cable Loss (dB)	Preamp Gain (dB)	Read Level (dBμV)	Emission Level (dBμV/m)	Limits (dBμV/m)	Margin (dB)	Detector
10360.000	37.60	12.61	34.79	32.88	48.30	54.00	5.70	Peak

Mode	802.11a	U-NII Band	2A
		Frequency	TX 5320MHz

Antenna at Horizontal Polarization

Emission Frequency (MHz)	Antenna Factor (dB/m)	Cable Loss (dB)	Preamp Gain (dB)	Read Level (dBμV)	Emission Level (dBμV/m)	Limits (dBμV/m)	Margin (dB)	Detector
10640.000	37.97	12.82	34.60	31.16	47.35	54.00	6.65	Peak

Antenna at Vertical Polarization

Emission Frequency (MHz)	Antenna Factor (dB/m)	Cable Loss (dB)	Preamp Gain (dB)	Read Level (dBμV)	Emission Level (dBμV/m)	Limits (dBμV/m)	Margin (dB)	Detector
10640.000	37.97	12.82	34.60	31.17	47.36	54.00	6.64	Peak

Mode	802.11a	U-NII Band	2C
		Frequency	TX 5500MHz

Antenna at Horizontal Polarization

Emission Frequency (MHz)	Antenna Factor (dB/m)	Cable Loss (dB)	Preamplifier Gain (dB)	Read Level (dBμV)	Emission Level (dBμV/m)	Limits (dBμV/m)	Margin (dB)	Detector
11000.000	38.10	13.09	34.51	31.97	48.65	54.00	5.35	Peak

Antenna at Vertical Polarization

Emission Frequency (MHz)	Antenna Factor (dB/m)	Cable Loss (dB)	Preamplifier Gain (dB)	Read Level (dBμV)	Emission Level (dBμV/m)	Limits (dBμV/m)	Margin (dB)	Detector
11000.000	38.10	13.09	34.51	31.03	47.71	54.00	6.29	Peak

Mode	802.11a	U-NII Band	2C
		Frequency	TX 5720MHz

Antenna at Horizontal Polarization

Emission Frequency (MHz)	Antenna Factor (dB/m)	Cable Loss (dB)	Preamplifier Gain (dB)	Read Level (dBμV)	Emission Level (dBμV/m)	Limits (dBμV/m)	Margin (dB)	Detector
11440.000	38.37	13.55	34.52	29.75	47.15	54.00	6.85	Peak

Antenna at Vertical Polarization

Emission Frequency (MHz)	Antenna Factor (dB/m)	Cable Loss (dB)	Preamplifier Gain (dB)	Read Level (dBμV)	Emission Level (dBμV/m)	Limits (dBμV/m)	Margin (dB)	Detector
11440.000	38.37	13.55	34.52	30.81	48.21	54.00	5.79	Peak

Mode	802.11a	U-NII Band	3
		Frequency	TX 5785MHz

Antenna at Horizontal Polarization

Emission Frequency (MHz)	Antenna Factor (dB/m)	Cable Loss (dB)	Preamplifier Gain (dB)	Read Level (dBμV)	Emission Level (dBμV/m)	Limits (dBμV/m)	Margin (dB)	Detector
11570.000	38.43	13.69	34.54	31.00	48.58	54.00	5.42	Peak

Antenna at Vertical Polarization

Emission Frequency (MHz)	Antenna Factor (dB/m)	Cable Loss (dB)	Preamplifier Gain (dB)	Read Level (dBμV)	Emission Level (dBμV/m)	Limits (dBμV/m)	Margin (dB)	Detector
11570.000	38.43	13.69	34.54	32.00	49.58	54.00	4.42	Peak

Mode	802.11n-HT20	U-NII Band	1
		Frequency	TX 5200MHz

Antenna at Horizontal Polarization

Emission Frequency (MHz)	Antenna Factor (dB/m)	Cable Loss (dB)	Preamplifier Gain (dB)	Read Level (dBμV)	Emission Level (dBμV/m)	Limits (dBμV/m)	Margin (dB)	Detector
10400.000	37.60	12.64	34.73	31.51	47.02	54.00	6.98	Peak

Antenna at Vertical Polarization

Emission Frequency (MHz)	Antenna Factor (dB/m)	Cable Loss (dB)	Preamplifier Gain (dB)	Read Level (dBμV)	Emission Level (dBμV/m)	Limits (dBμV/m)	Margin (dB)	Detector
10400.000	37.60	12.64	34.73	32.06	47.57	54.00	6.43	Peak

Mode	802.11n-HT20	U-NII Band	2A
		Frequency	TX 5320MHz

Antenna at Horizontal Polarization

Emission Frequency (MHz)	Antenna Factor (dB/m)	Cable Loss (dB)	Preamplifier Gain (dB)	Read Level (dBμV)	Emission Level (dBμV/m)	Limits (dBμV/m)	Margin (dB)	Detector
10640.000	37.97	12.82	34.60	30.73	46.92	54.00	7.08	Peak

Antenna at Vertical Polarization

Emission Frequency (MHz)	Antenna Factor (dB/m)	Cable Loss (dB)	Preamplifier Gain (dB)	Read Level (dBμV)	Emission Level (dBμV/m)	Limits (dBμV/m)	Margin (dB)	Detector
10640.000	37.97	12.82	34.60	31.72	47.91	54.00	6.09	Peak

Mode	802.11n-HT20	U-NII Band	2C
		Frequency	TX 5500MHz

Antenna at Horizontal Polarization

Emission Frequency (MHz)	Antenna Factor (dB/m)	Cable Loss (dB)	Preamplifier Gain (dB)	Read Level (dBμV)	Emission Level (dBμV/m)	Limits (dBμV/m)	Margin (dB)	Detector
11000.000	38.10	13.09	34.51	30.30	46.98	54.00	7.02	Peak

Antenna at Vertical Polarization

Emission Frequency (MHz)	Antenna Factor (dB/m)	Cable Loss (dB)	Preamplifier Gain (dB)	Read Level (dBμV)	Emission Level (dBμV/m)	Limits (dBμV/m)	Margin (dB)	Detector
11000.000	38.10	13.09	34.51	30.47	47.15	54.00	6.85	Peak

Mode	802.11n-HT20	U-NII Band	2C
		Frequency	TX 5720MHz

Antenna at Horizontal Polarization

Emission Frequency (MHz)	Antenna Factor (dB/m)	Cable Loss (dB)	Preamplifier Gain (dB)	Read Level (dBμV)	Emission Level (dBμV/m)	Limits (dBμV/m)	Margin (dB)	Detector
11440.000	38.37	13.55	34.52	30.03	47.43	54.00	6.57	Peak

Antenna at Vertical Polarization

Emission Frequency (MHz)	Antenna Factor (dB/m)	Cable Loss (dB)	Preamplifier Gain (dB)	Read Level (dBμV)	Emission Level (dBμV/m)	Limits (dBμV/m)	Margin (dB)	Detector
11440.000	38.37	13.55	34.52	30.59	47.99	54.00	6.01	Peak

Mode	802.11n-HT20	U-NII Band	3
		Frequency	TX 5825MHz

Antenna at Horizontal Polarization

Emission Frequency (MHz)	Antenna Factor (dB/m)	Cable Loss (dB)	Preamplifier Gain (dB)	Read Level (dBμV)	Emission Level (dBμV/m)	Limits (dBμV/m)	Margin (dB)	Detector
11650.000	38.43	13.76	34.56	29.71	47.34	54.00	6.66	Peak

Antenna at Vertical Polarization

Emission Frequency (MHz)	Antenna Factor (dB/m)	Cable Loss (dB)	Preamplifier Gain (dB)	Read Level (dBμV)	Emission Level (dBμV/m)	Limits (dBμV/m)	Margin (dB)	Detector
11650.000	38.43	13.76	34.56	29.94	47.57	54.00	6.43	Peak

Mode	802.11n-HT40	U-NII Band	1
		Frequency	TX 5230MHz

Antenna at Horizontal Polarization

Emission Frequency (MHz)	Antenna Factor (dB/m)	Cable Loss (dB)	Preamplifier Gain (dB)	Read Level (dB μ V)	Emission Level (dB μ V/m)	Limits (dB μ V/m)	Margin (dB)	Detector
10460.000	37.70	12.68	34.70	32.07	47.75	54.00	6.25	Peak

Antenna at Vertical Polarization

Emission Frequency (MHz)	Antenna Factor (dB/m)	Cable Loss (dB)	Preamplifier Gain (dB)	Read Level (dB μ V)	Emission Level (dB μ V/m)	Limits (dB μ V/m)	Margin (dB)	Detector
10460.000	37.70	12.68	34.70	31.41	47.09	54.00	6.91	Peak

Mode	802.11n-HT40	U-NII Band	2A
		Frequency	TX 5270MHz

Antenna at Horizontal Polarization

Emission Frequency (MHz)	Antenna Factor (dB/m)	Cable Loss (dB)	Preamplifier Gain (dB)	Read Level (dB μ V)	Emission Level (dB μ V/m)	Limits (dB μ V/m)	Margin (dB)	Detector
10540.000	37.83	12.75	34.63	30.82	46.77	54.00	7.23	Peak

Antenna at Vertical Polarization

Emission Frequency (MHz)	Antenna Factor (dB/m)	Cable Loss (dB)	Preamplifier Gain (dB)	Read Level (dB μ V)	Emission Level (dB μ V/m)	Limits (dB μ V/m)	Margin (dB)	Detector
10540.000	37.83	12.75	34.63	31.22	47.17	54.00	6.83	Peak

Mode	802.11n-HT40	U-NII Band	2C
		Frequency	TX 5550MHz

Antenna at Horizontal Polarization

Emission Frequency (MHz)	Antenna Factor (dB/m)	Cable Loss (dB)	Preamplifier Gain (dB)	Read Level (dB μ V)	Emission Level (dB μ V/m)	Limits (dB μ V/m)	Margin (dB)	Detector
11100.000	38.10	13.19	34.51	29.85	46.63	54.00	7.37	Peak

Antenna at Vertical Polarization

Emission Frequency (MHz)	Antenna Factor (dB/m)	Cable Loss (dB)	Preamplifier Gain (dB)	Read Level (dB μ V)	Emission Level (dB μ V/m)	Limits (dB μ V/m)	Margin (dB)	Detector
11100.000	38.10	13.19	34.51	30.93	47.71	54.00	6.29	Peak

Mode	802.11n-HT40	U-NII Band	2C
		Frequency	TX 5710MHz

Antenna at Horizontal Polarization

Emission Frequency (MHz)	Antenna Factor (dB/m)	Cable Loss (dB)	Preamplifier Gain (dB)	Read Level (dBμV)	Emission Level (dBμV/m)	Limits (dBμV/m)	Margin (dB)	Detector
11420.000	38.37	13.55	34.52	29.99	47.39	54.00	6.61	Peak

Antenna at Vertical Polarization

Emission Frequency (MHz)	Antenna Factor (dB/m)	Cable Loss (dB)	Preamplifier Gain (dB)	Read Level (dBμV)	Emission Level (dBμV/m)	Limits (dBμV/m)	Margin (dB)	Detector
11420.000	38.37	13.55	34.52	30.09	47.49	54.00	6.51	Peak

Mode	802.11n-HT40	U-NII Band	3
		Frequency	TX 5795MHz

Antenna at Horizontal Polarization

Emission Frequency (MHz)	Antenna Factor (dB/m)	Cable Loss (dB)	Preamplifier Gain (dB)	Read Level (dBμV)	Emission Level (dBμV/m)	Limits (dBμV/m)	Margin (dB)	Detector
11590.000	38.40	13.72	34.55	29.98	47.55	54.00	6.45	Peak

Antenna at Vertical Polarization

Emission Frequency (MHz)	Antenna Factor (dB/m)	Cable Loss (dB)	Preamplifier Gain (dB)	Read Level (dBμV)	Emission Level (dBμV/m)	Limits (dBμV/m)	Margin (dB)	Detector
11590.000	38.40	13.72	34.55	31.10	48.67	54.00	5.33	Peak

Mode	802.11ac-VHT80	U-NII Band	1
		Frequency	TX 5210MHz

Antenna at Horizontal Polarization

Emission Frequency (MHz)	Antenna Factor (dB/m)	Cable Loss (dB)	Preamplifier Gain (dB)	Read Level (dBμV)	Emission Level (dBμV/m)	Limits (dBμV/m)	Margin (dB)	Detector
10420.000	37.65	12.66	34.73	31.44	47.02	54.00	6.98	Peak

Antenna at Vertical Polarization

Emission Frequency (MHz)	Antenna Factor (dB/m)	Cable Loss (dB)	Preamplifier Gain (dB)	Read Level (dBμV)	Emission Level (dBμV/m)	Limits (dBμV/m)	Margin (dB)	Detector
10420.000	37.65	12.66	34.73	31.96	47.54	54.00	6.46	Peak

Mode	802.11ac-VHT80	U-NII Band	2A
		Frequency	TX 5290MHz

Antenna at Horizontal Polarization

Emission Frequency (MHz)	Antenna Factor (dB/m)	Cable Loss (dB)	Preamplifier Gain (dB)	Read Level (dBμV)	Emission Level (dBμV/m)	Limits (dBμV/m)	Margin (dB)	Detector
10580.000	37.87	12.77	34.62	30.90	46.92	54.00	7.08	Peak

Antenna at Vertical Polarization

Emission Frequency (MHz)	Antenna Factor (dB/m)	Cable Loss (dB)	Preamplifier Gain (dB)	Read Level (dBμV)	Emission Level (dBμV/m)	Limits (dBμV/m)	Margin (dB)	Detector
10580.000	37.87	12.77	34.62	30.52	46.54	54.00	7.46	Peak

Mode	802.11ac-VHT80	U-NII Band	2C
		Frequency	TX 5610MHz

Antenna at Horizontal Polarization

Emission Frequency (MHz)	Antenna Factor (dB/m)	Cable Loss (dB)	Preamplifier Gain (dB)	Read Level (dBμV)	Emission Level (dBμV/m)	Limits (dBμV/m)	Margin (dB)	Detector
11220.000	38.20	13.30	34.51	31.06	48.05	54.00	5.95	Peak

Antenna at Vertical Polarization

Emission Frequency (MHz)	Antenna Factor (dB/m)	Cable Loss (dB)	Preamplifier Gain (dB)	Read Level (dBμV)	Emission Level (dBμV/m)	Limits (dBμV/m)	Margin (dB)	Detector
11220.000	38.20	13.30	34.51	29.41	46.40	54.00	7.60	Peak

Mode	802.11ac-VHT80	U-NII Band	2C
		Frequency	TX 5690MHz

Antenna at Horizontal Polarization

Emission Frequency (MHz)	Antenna Factor (dB/m)	Cable Loss (dB)	Preamplifier Gain (dB)	Read Level (dBμV)	Emission Level (dBμV/m)	Limits (dBμV/m)	Margin (dB)	Detector
11380.000	38.30	13.48	34.52	30.05	47.31	54.00	6.69	Peak

Antenna at Vertical Polarization

Emission Frequency (MHz)	Antenna Factor (dB/m)	Cable Loss (dB)	Preamplifier Gain (dB)	Read Level (dBμV)	Emission Level (dBμV/m)	Limits (dBμV/m)	Margin (dB)	Detector
11380.000	38.30	13.48	34.52	30.17	47.43	54.00	6.57	Peak

Mode	802.11ac-VHT80	U-NII Band	3
		Frequency	TX 5775MHz

Antenna at Horizontal Polarization

Emission Frequency (MHz)	Antenna Factor (dB/m)	Cable Loss (dB)	Preamplifier Gain (dB)	Read Level (dBμV)	Emission Level (dBμV/m)	Limits (dBμV/m)	Margin (dB)	Detector
11550.000	38.47	13.65	34.54	30.04	47.62	54.00	6.38	Peak

Antenna at Vertical Polarization

Emission Frequency (MHz)	Antenna Factor (dB/m)	Cable Loss (dB)	Preamplifier Gain (dB)	Read Level (dBμV)	Emission Level (dBμV/m)	Limits (dBμV/m)	Margin (dB)	Detector
11550.000	38.47	13.65	34.54	29.78	47.36	54.00	6.64	Peak

Mode	802.11ac-VHT160	U-NII Band	1/2A
		Frequency	TX 5250MHz

Antenna at Horizontal Polarization

Emission Frequency (MHz)	Antenna Factor (dB/m)	Cable Loss (dB)	Preamplifier Gain (dB)	Read Level (dBμV)	Emission Level (dBμV/m)	Limits (dBμV/m)	Margin (dB)	Detector
10500.000	37.80	12.73	34.64	30.46	46.35	54.00	7.65	Peak

Antenna at Vertical Polarization

Emission Frequency (MHz)	Antenna Factor (dB/m)	Cable Loss (dB)	Preamplifier Gain (dB)	Read Level (dBμV)	Emission Level (dBμV/m)	Limits (dBμV/m)	Margin (dB)	Detector
10500.000	37.80	12.73	34.64	30.77	46.66	54.00	7.34	Peak

Mode	802.11ac-VHT160	U-NII Band	2C
		Frequency	TX 5570MHz

Antenna at Horizontal Polarization

Emission Frequency (MHz)	Antenna Factor (dB/m)	Cable Loss (dB)	Preamplifier Gain (dB)	Read Level (dBμV)	Emission Level (dBμV/m)	Limits (dBμV/m)	Margin (dB)	Detector
11140.000	38.13	13.23	34.51	29.88	46.73	54.00	7.27	Peak

Antenna at Vertical Polarization

Emission Frequency (MHz)	Antenna Factor (dB/m)	Cable Loss (dB)	Preamplifier Gain (dB)	Read Level (dBμV)	Emission Level (dBμV/m)	Limits (dBμV/m)	Margin (dB)	Detector
11140.000	38.13	13.23	34.51	30.56	47.41	54.00	6.59	Peak

Mode	802.11ax-HE20	U-NII Band	1
		Frequency	TX 5200MHz

Antenna at Horizontal Polarization

Emission Frequency (MHz)	Antenna Factor (dB/m)	Cable Loss (dB)	Preamp Gain (dB)	Read Level (dBμV)	Emission Level (dBμV/m)	Limits (dBμV/m)	Margin (dB)	Detector
10400.000	37.60	12.64	34.73	30.87	46.38	54.00	7.62	Peak

Antenna at Vertical Polarization

Emission Frequency (MHz)	Antenna Factor (dB/m)	Cable Loss (dB)	Preamp Gain (dB)	Read Level (dBμV)	Emission Level (dBμV/m)	Limits (dBμV/m)	Margin (dB)	Detector
10400.000	37.60	12.64	34.73	30.85	46.36	54.00	7.64	Peak

Mode	802.11ax-HE20	U-NII Band	2A
		Frequency	TX 5320MHz

Antenna at Horizontal Polarization

Emission Frequency (MHz)	Antenna Factor (dB/m)	Cable Loss (dB)	Preamp Gain (dB)	Read Level (dBμV)	Emission Level (dBμV/m)	Limits (dBμV/m)	Margin (dB)	Detector
10640.000	37.97	12.82	34.60	30.37	46.56	54.00	7.44	Peak

Antenna at Vertical Polarization

Emission Frequency (MHz)	Antenna Factor (dB/m)	Cable Loss (dB)	Preamp Gain (dB)	Read Level (dBμV)	Emission Level (dBμV/m)	Limits (dBμV/m)	Margin (dB)	Detector
10640.000	37.97	12.82	34.60	30.74	46.93	54.00	7.07	Peak

Mode	802.11ax-HE20	U-NII Band	2C
		Frequency	TX 5500MHz

Antenna at Horizontal Polarization

Emission Frequency (MHz)	Antenna Factor (dB/m)	Cable Loss (dB)	Preamplifier Gain (dB)	Read Level (dBμV)	Emission Level (dBμV/m)	Limits (dBμV/m)	Margin (dB)	Detector
11000.000	38.10	13.09	34.51	29.87	46.55	54.00	7.45	Peak

Antenna at Vertical Polarization

Emission Frequency (MHz)	Antenna Factor (dB/m)	Cable Loss (dB)	Preamplifier Gain (dB)	Read Level (dBμV)	Emission Level (dBμV/m)	Limits (dBμV/m)	Margin (dB)	Detector
11000.000	38.10	13.09	34.51	30.01	46.69	54.00	7.31	Peak

Mode	802.11ax-HE20	U-NII Band	2C
		Frequency	TX 5720MHz

Antenna at Horizontal Polarization

Emission Frequency (MHz)	Antenna Factor (dB/m)	Cable Loss (dB)	Preamplifier Gain (dB)	Read Level (dBμV)	Emission Level (dBμV/m)	Limits (dBμV/m)	Margin (dB)	Detector
11440.000	38.37	13.55	34.52	29.62	47.02	54.00	6.98	Peak

Antenna at Vertical Polarization

Emission Frequency (MHz)	Antenna Factor (dB/m)	Cable Loss (dB)	Preamplifier Gain (dB)	Read Level (dBμV)	Emission Level (dBμV/m)	Limits (dBμV/m)	Margin (dB)	Detector
11440.000	38.37	13.55	34.52	29.72	47.12	54.00	6.88	Peak

Mode	802.11ax-HE20	U-NII Band	3
		Frequency	TX 5825MHz

Antenna at Horizontal Polarization

Emission Frequency (MHz)	Antenna Factor (dB/m)	Cable Loss (dB)	Preamplifier Gain (dB)	Read Level (dBμV)	Emission Level (dBμV/m)	Limits (dBμV/m)	Margin (dB)	Detector
11650.000	38.43	13.76	34.56	29.96	47.59	54.00	6.41	Peak

Antenna at Vertical Polarization

Emission Frequency (MHz)	Antenna Factor (dB/m)	Cable Loss (dB)	Preamplifier Gain (dB)	Read Level (dBμV)	Emission Level (dBμV/m)	Limits (dBμV/m)	Margin (dB)	Detector
11650.000	38.43	13.76	34.56	29.69	47.32	54.00	6.68	Peak

Mode	802.11ax-HE40	U-NII Band	1
		Frequency	TX 5230MHz

Antenna at Horizontal Polarization

Emission Frequency (MHz)	Antenna Factor (dB/m)	Cable Loss (dB)	Preamp Gain (dB)	Read Level (dBμV)	Emission Level (dBμV/m)	Limits (dBμV/m)	Margin (dB)	Detector
10460.000	37.70	12.68	34.70	30.38	46.06	54.00	7.94	Peak

Antenna at Vertical Polarization

Emission Frequency (MHz)	Antenna Factor (dB/m)	Cable Loss (dB)	Preamp Gain (dB)	Read Level (dBμV)	Emission Level (dBμV/m)	Limits (dBμV/m)	Margin (dB)	Detector
10460.000	37.70	12.68	34.70	31.46	47.14	54.00	6.86	Peak

Mode	802.11ax-HE40	U-NII Band	2A
		Frequency	TX 5270MHz

Antenna at Horizontal Polarization

Emission Frequency (MHz)	Antenna Factor (dB/m)	Cable Loss (dB)	Preamp Gain (dB)	Read Level (dBμV)	Emission Level (dBμV/m)	Limits (dBμV/m)	Margin (dB)	Detector
10540.000	37.83	12.75	34.63	30.47	46.42	54.00	7.58	Peak

Antenna at Vertical Polarization

Emission Frequency (MHz)	Antenna Factor (dB/m)	Cable Loss (dB)	Preamp Gain (dB)	Read Level (dBμV)	Emission Level (dBμV/m)	Limits (dBμV/m)	Margin (dB)	Detector
10540.000	37.83	12.75	34.63	30.94	46.89	54.00	7.11	Peak

Mode	802.11ax-HE40	U-NII Band	2C
		Frequency	TX 5550MHz

Antenna at Horizontal Polarization

Emission Frequency (MHz)	Antenna Factor (dB/m)	Cable Loss (dB)	Preamplifier Gain (dB)	Read Level (dBμV)	Emission Level (dBμV/m)	Limits (dBμV/m)	Margin (dB)	Detector
11100.000	38.10	13.19	34.51	29.68	46.46	54.00	7.54	Peak

Antenna at Vertical Polarization

Emission Frequency (MHz)	Antenna Factor (dB/m)	Cable Loss (dB)	Preamplifier Gain (dB)	Read Level (dBμV)	Emission Level (dBμV/m)	Limits (dBμV/m)	Margin (dB)	Detector
11100.000	38.10	13.19	34.51	30.65	47.43	54.00	6.57	Peak

Mode	802.11ax-HE40	U-NII Band	2C
		Frequency	TX 5710MHz

Antenna at Horizontal Polarization

Emission Frequency (MHz)	Antenna Factor (dB/m)	Cable Loss (dB)	Preamplifier Gain (dB)	Read Level (dBμV)	Emission Level (dBμV/m)	Limits (dBμV/m)	Margin (dB)	Detector
11420.000	38.37	13.55	34.52	29.66	47.06	54.00	6.94	Peak

Antenna at Vertical Polarization

Emission Frequency (MHz)	Antenna Factor (dB/m)	Cable Loss (dB)	Preamplifier Gain (dB)	Read Level (dBμV)	Emission Level (dBμV/m)	Limits (dBμV/m)	Margin (dB)	Detector
11420.000	38.37	13.55	34.52	29.77	47.17	54.00	6.83	Peak

Mode	802.11ax-HE40	U-NII Band	3
		Frequency	TX 5795MHz

Antenna at Horizontal Polarization

Emission Frequency (MHz)	Antenna Factor (dB/m)	Cable Loss (dB)	Preamplifier Gain (dB)	Read Level (dBμV)	Emission Level (dBμV/m)	Limits (dBμV/m)	Margin (dB)	Detector
11590.000	38.40	13.72	34.55	30.68	48.25	54.00	5.75	Peak

Antenna at Vertical Polarization

Emission Frequency (MHz)	Antenna Factor (dB/m)	Cable Loss (dB)	Preamplifier Gain (dB)	Read Level (dBμV)	Emission Level (dBμV/m)	Limits (dBμV/m)	Margin (dB)	Detector
11590.000	38.40	13.72	34.55	30.17	47.74	54.00	6.26	Peak

Mode	802.11ax-HE80	U-NII Band	1
		Frequency	TX 5210MHz

Antenna at Horizontal Polarization

Emission Frequency (MHz)	Antenna Factor (dB/m)	Cable Loss (dB)	Preamplifier Gain (dB)	Read Level (dBμV)	Emission Level (dBμV/m)	Limits (dBμV/m)	Margin (dB)	Detector
10420.000	37.65	12.66	34.73	30.75	46.33	54.00	7.67	Peak

Antenna at Vertical Polarization

Emission Frequency (MHz)	Antenna Factor (dB/m)	Cable Loss (dB)	Preamplifier Gain (dB)	Read Level (dBμV)	Emission Level (dBμV/m)	Limits (dBμV/m)	Margin (dB)	Detector
10420.000	37.65	12.66	34.73	30.38	45.96	54.00	8.04	Peak

Mode	802.11ax-HE80	U-NII Band	2A
		Frequency	TX 5290MHz

Antenna at Horizontal Polarization

Emission Frequency (MHz)	Antenna Factor (dB/m)	Cable Loss (dB)	Preamplifier Gain (dB)	Read Level (dBμV)	Emission Level (dBμV/m)	Limits (dBμV/m)	Margin (dB)	Detector
10580.000	37.87	12.77	34.62	30.89	46.91	54.00	7.09	Peak

Antenna at Vertical Polarization

Emission Frequency (MHz)	Antenna Factor (dB/m)	Cable Loss (dB)	Preamplifier Gain (dB)	Read Level (dBμV)	Emission Level (dBμV/m)	Limits (dBμV/m)	Margin (dB)	Detector
10580.000	37.87	12.77	34.62	31.05	47.07	54.00	6.93	Peak

Mode	802.11ax-HE80	U-NII Band	2C
		Frequency	TX 5610MHz

Antenna at Horizontal Polarization

Emission Frequency (MHz)	Antenna Factor (dB/m)	Cable Loss (dB)	Preamplifier Gain (dB)	Read Level (dBμV)	Emission Level (dBμV/m)	Limits (dBμV/m)	Margin (dB)	Detector
11220.000	38.20	13.30	34.51	29.20	46.19	54.00	7.81	Peak

Antenna at Vertical Polarization

Emission Frequency (MHz)	Antenna Factor (dB/m)	Cable Loss (dB)	Preamplifier Gain (dB)	Read Level (dBμV)	Emission Level (dBμV/m)	Limits (dBμV/m)	Margin (dB)	Detector
11220.000	38.20	13.30	34.51	29.07	46.06	54.00	7.94	Peak

Mode	802.11ax-HE80	U-NII Band	2C
		Frequency	TX 5690MHz

Antenna at Horizontal Polarization

Emission Frequency (MHz)	Antenna Factor (dB/m)	Cable Loss (dB)	Preamplifier Gain (dB)	Read Level (dB μ V)	Emission Level (dB μ V/m)	Limits (dB μ V/m)	Margin (dB)	Detector
11380.000	38.30	13.48	34.52	28.92	46.18	54.00	7.82	Peak

Antenna at Vertical Polarization

Emission Frequency (MHz)	Antenna Factor (dB/m)	Cable Loss (dB)	Preamplifier Gain (dB)	Read Level (dB μ V)	Emission Level (dB μ V/m)	Limits (dB μ V/m)	Margin (dB)	Detector
11380.000	38.30	13.48	34.52	29.39	46.65	54.00	7.35	Peak

Mode	802.11ax-HE80	U-NII Band	3
		Frequency	TX 5775MHz

Antenna at Horizontal Polarization

Emission Frequency (MHz)	Antenna Factor (dB/m)	Cable Loss (dB)	Preamplifier Gain (dB)	Read Level (dB μ V)	Emission Level (dB μ V/m)	Limits (dB μ V/m)	Margin (dB)	Detector
11550.000	38.47	13.65	34.54	29.71	47.29	54.00	6.71	Peak

Antenna at Vertical Polarization

Emission Frequency (MHz)	Antenna Factor (dB/m)	Cable Loss (dB)	Preamplifier Gain (dB)	Read Level (dB μ V)	Emission Level (dB μ V/m)	Limits (dB μ V/m)	Margin (dB)	Detector
11550.000	38.47	13.65	34.54	29.84	47.42	54.00	6.58	Peak

Mode	802.11ax-HE160	U-NII Band	1/2A
		Frequency	TX 5250MHz

Antenna at Horizontal Polarization

Emission Frequency (MHz)	Antenna Factor (dB/m)	Cable Loss (dB)	Preamplifier Gain (dB)	Read Level (dBμV)	Emission Level (dBμV/m)	Limits (dBμV/m)	Margin (dB)	Detector
10500.000	37.80	12.73	34.64	30.80	46.69	54.00	7.31	Peak

Antenna at Vertical Polarization

Emission Frequency (MHz)	Antenna Factor (dB/m)	Cable Loss (dB)	Preamplifier Gain (dB)	Read Level (dBμV)	Emission Level (dBμV/m)	Limits (dBμV/m)	Margin (dB)	Detector
10500.000	37.80	12.73	34.64	29.92	45.81	54.00	8.19	Peak

Mode	802.11ax-HE160	U-NII Band	2C
		Frequency	TX 5570MHz

Antenna at Horizontal Polarization

Emission Frequency (MHz)	Antenna Factor (dB/m)	Cable Loss (dB)	Preamplifier Gain (dB)	Read Level (dBμV)	Emission Level (dBμV/m)	Limits (dBμV/m)	Margin (dB)	Detector
11140.000	38.13	13.23	34.51	30.02	46.87	54.00	7.13	Peak

Antenna at Vertical Polarization

Emission Frequency (MHz)	Antenna Factor (dB/m)	Cable Loss (dB)	Preamplifier Gain (dB)	Read Level (dBμV)	Emission Level (dBμV/m)	Limits (dBμV/m)	Margin (dB)	Detector
11140.000	38.13	13.23	34.51	29.24	46.09	54.00	7.91	Peak

A.2.3 Emissions in Non-restricted Frequency Bands

Pursuant to KDB 789033 D02 General UNII Test Procedures New Rules v02r01 that emission levels below the 15.209 general radiated emissions limits is not required.