

# FCC Radio Test Report

## FCC ID: BEJNT-14T90S

**Report No.** : BTL-FCCP-6-2308T045  
**Equipment** : Notebook Computer  
**Model Name** : 14T90S, 14TD90S, 14TG90S, 14TB90S, 14TW90S, 14TN90S, 14T90S\* (\* can be 0 to 9 or A to Z or blank denoting buyer request)  
**Brand Name** : LG  
**Applicant** : LG Electronics USA, Inc.  
**Address** : 111 Sylvan Avenue, North Building, Englewood Cliffs, New Jersey 07632, United States

**Equipment Class** : 6XD - 15E 6 GHz Low Power Indoor Client  
**Radio Function** : U-NII 6 GHz (U-NII 5, U-NII 6, U-NII 7, U-NII 8)  
**FCC Rule Part(s)** : FCC CFR Title 47, Part 15, Subpart E (15.407)  
**Measurement Procedure(s)** : ANSI C63.10-2013

**Date of Receipt** : 2023/8/15  
**Date of Test** : 2023/8/25 ~ 2023/9/6  
**Issued Date** : 2023/10/11

The above equipment has been tested and found in compliance with the requirement of the above standards by BTL Inc.

**Prepared by** :

  
Jerry Chuang, Supervisor

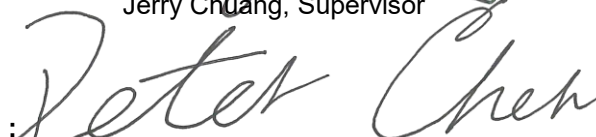

**Approved by** :

  
Peter Chen, Vice Manager

**BTL Inc.**

No.18, Ln. 171, Sec. 2, Jiuzong Rd., Neihu Dist., Taipei City 114, Taiwan

Tel: +886-2-2657-3299 Fax: +886-2-2657-3331 Web: www.newbtl.com Service mail: btl\_qa@newbtl.com

**Declaration**

**BTL** represents to the client that testing is done in accordance with standard procedures as applicable and that test instruments used has been calibrated with standards traceable to international standard(s) and/or national standard(s).

**BTL's** reports apply only to the specific samples tested under conditions. It is manufacture's responsibility to ensure that additional production units of this model are manufactured with the identical electrical and mechanical components. **BTL** shall have no liability for any declarations, inferences or generalizations drawn by the client or others from **BTL** issued reports.

This report is the confidential property of the client. As a mutual protection to the clients, the public and ourselves, the test report shall not be reproduced, except in full, without our written approval.

**BTL's** laboratory quality assurance procedures are in compliance with the **ISO/IEC 17025** requirements, and accredited by the conformity assessment authorities listed in this test report.

**BTL** is not responsible for the sampling stage, so the results only apply to the sample as received.

The information, data and test plan are provided by manufacturer which may affect the validity of results, so it is manufacturer's responsibility to ensure that the apparatus meets the essential requirements of applied standards and in all the possible configurations as representative of its intended use.

**Limitation**

For the use of the authority's logo is limited unless the Test Standard(s)/Scope(s)/Item(s) mentioned in this test report is (are) included in the conformity assessment authorities acceptance respective.

Please note that the measurement uncertainty is provided for informational purpose only and are not use in determining the Pass/Fail results.

**CONTENTS**

CONTENTS	3
REVISION HISTORY	5
1 SUMMARY OF TEST RESULTS	6
1.1 TEST FACILITY	7
1.2 MEASUREMENT UNCERTAINTY	7
1.3 TEST ENVIRONMENT CONDITIONS	7
1.4 DUTY CYCLE	8
2 GENERAL INFORMATION	9
2.1 EUT INFORMATION	9
2.2 TEST MODES	13
2.3 TESTED CONFIGURATION DIAGRAM	14
2.4 SUPPORT UNITS	15
3 MAXIMUM E.I.R.P. TEST	16
3.1 LIMITS	16
3.2 TEST PROCEDURE	16
3.3 DEVIATION FROM TEST STANDARD	18
3.4 TEST SETUP	18
3.5 EUT OPERATING CONDITIONS	18
3.6 TEST RESULT	18
4 MAXIMUM TRANSMITTER CHANNEL BANDWIDTH TEST	19
4.1 LIMITS	19
4.2 TEST PROCEDURE	19
4.3 DEVIATION FROM TEST STANDARD	20
4.4 TEST SETUP	20
4.5 EUT OPERATING CONDITIONS	20
4.6 TEST RESULT	20
5 MAXIMUM POWER SPECTRAL DENSITY TEST	21
5.1 LIMITS	21
5.2 TEST PROCEDURE	21
5.3 DEVIATION FROM TEST STANDARD	22
5.4 TEST SETUP	22
5.5 EUT OPERATING CONDITIONS	22
5.6 TEST RESULT	22
6 UNDESIRABLE EMISSIONS TEST	23
6.1 LIMITS	23
6.2 TEST PROCEDURE	24
6.3 DEVIATION FROM TEST STANDARD	25
6.4 TEST SETUP	25
6.5 EUT OPERATING CONDITIONS	26
6.6 TEST RESULT – BELOW 30 MHZ	26
6.7 TEST RESULT – 30 MHZ TO 1 GHZ	26
6.8 TEST RESULT – ABOVE 1 GHZ	26
7 IN-BAND EMISSION (MASK) TEST	27
7.1 LIMITS	27
7.2 TEST PROCEDURE	27
7.3 DEVIATION FROM TEST STANDARD	28

7.4	TEST SETUP	28
7.5	EUT OPERATING CONDITIONS	28
7.6	TEST RESULT	28
8	AC POWER LINE CONDUCTED EMISSIONS TEST	29
8.1	LIMITS	29
8.2	TEST PROCEDURE	29
8.3	DEVIATION FROM TEST STANDARD	30
8.4	TEST SETUP	30
8.5	EUT OPERATING CONDITIONS	30
8.6	TEST RESULT	30
9	CONTENTION-BASED PROTOCOL TEST	31
9.1	LIMITS	31
9.2	TEST PROCEDURE	31
9.3	DEVIATION FROM TEST STANDARD	32
9.4	TEST SETUP	33
9.5	EUT OPERATING CONDITIONS	33
9.6	TEST RESULT	33
10	LIST OF MEASURING EQUIPMENTS	34
11	EUT TEST PHOTOS	35
12	EUT PHOTOS	35
APPENDIX A	MAXIMUM E.I.R.P.	36
APPENDIX B	MAXIMUM TRANSMITTER CHANNEL BANDWIDTH	41
APPENDIX C	MAXIMUM POWER SPECTRAL DENSIT	57
APPENDIX D	UNDESIRABLE EMISSIONS - 30 MHZ TO 1 GHZ	90
APPENDIX E	UNDESIRABLE EMISSIONS - ABOVE 1 GHZ	93
APPENDIX F	IN-BAND EMISSION (MASK)	204
APPENDIX G	AC POWER LINE CONDUCTED EMISSIONS	227
APPENDIX H	CONTENTION-BASED PROTOCOL	232

**REVISION HISTORY**

Report No.	Version	Description	Issued Date	Note
BTL-FCCP-6-2308T045	R00	Original Report.	2023/9/27	Invalid
BTL-FCCP-6-2308T045	R01	Revised report to address TCB's comments.	2023/10/11	Valid

## 1 SUMMARY OF TEST RESULTS

Test procedures according to the technical standards.

Standard(s) Section	Description	Test Result	Judgement	Remark
15.407(a)	Maximum e.i.r.p.	APPENDIX A	Pass	-----
15.203 15.407(a)	Antenna requirement	-----	Pass	-----
15.407(a)	Maximum transmitter channel bandwidth	APPENDIX B	Pass	-----
15.407(a)	Maximum power spectral density	APPENDIX C	Pass	-----
15.407(b) 15.209 15.407(b) 15.205	Undesirable emissions and Restricted bands of operation	APPENDIX D APPENDIX E	Pass	-----
15.407(b)	In-band emission (Mask)	APPENDIX F	Pass	-----
15.407(b)	AC power line conducted emissions	APPENDIX G	Pass	-----
15.407(d)	Contention-based protocol	APPENDIX H	Pass	<b>NOTE (2)</b>

**NOTE:**

- (1) "N/A" denotes test is not applicable in this Test Report.
- (2) Contention-Based Protocol Uses conducted method for testing.
- (3) The report format version is TP.1.1.1.

### 1.1 TEST FACILITY

The test locations stated below are under the TAF Accreditation Number 0659.

The test location(s) used to collect the test data in this report are:

No. 68-1, Ln. 169, Sec. 2, Datong Rd., Xizhi Dist., New Taipei City 221, Taiwan  
(FCC DN: TW0659)

C05       CB08       CB11       SR10       SR11

No. 72, Ln. 169, Sec. 2, Datong Rd., Xizhi Dist., New Taipei City 221, Taiwan  
(FCC DN: TW0659)

C06       CB21       CB22

### 1.2 MEASUREMENT UNCERTAINTY

The reported uncertainty of measurement  $y \pm U$ , where expanded uncertainty  $U$  is based on a standard uncertainty multiplied by a coverage factor of  $k = 2$ , providing a level of confidence of approximately **95 %**.

The measurement instrumentation uncertainty considerations contained in CISPR 16-4-2. The BTL measurement uncertainty is less than the CISPR 16-4-2  $U_{\text{cispr}}$  requirement.

#### A. Conducted test:

Test Item	U (dB)
Maximum e.i.r.p.	0.3669
Maximum transmitter channel bandwidth	0.5332
Maximum power spectral density	0.6590
In-band emission (Mask)	-
Contention-based protocol	-

#### B. Undesirable emissions test:

Test Site	Measurement Frequency Range	U (dB)
CB21	0.03 GHz ~ 0.2 GHz	4.17
	0.2 GHz ~ 1 GHz	4.72
	1 GHz ~ 6 GHz	5.21
	6 GHz ~ 18 GHz	5.51
	18 GHz ~ 26 GHz	3.69
	26 GHz ~ 40 GHz	4.23

#### C. AC power line conducted emissions test:

Test Site	Method	Measurement Frequency Range	U (dB)
C05	CISPR	150 kHz ~ 30MHz	3.44

#### NOTE:

Unless specifically mentioned, the uncertainty of measurement has not been taken into account to declare the compliance or non-compliance to the specification.

### 1.3 TEST ENVIRONMENT CONDITIONS

Test Item	Environment Condition	Test Voltage	Tested by
Maximum e.i.r.p.	27.3 °C, 41 %	AC 120V	Jerry Chuang
Maximum transmitter channel bandwidth	27.3 °C, 41 %	AC 120V	Jerry Chuang
Maximum power spectral density	27.3 °C, 41 %	AC 120V	Jerry Chuang
Undesirable emissions below 1 GHz	Refer to data	AC 120V	Mark Wang
Undesirable emissions above 1 GHz	Refer to data	AC 120V	Mark Wang
In-band emission (Mask)	27.3 °C, 41 %	AC 120V	Jerry Chuang
AC power line conducted emissions	21 °C, 52 %	AC 120V	Cora Lin
Contention-based protocol	26.9 °C, 47 %	AC 120V	Jerry Chuang

## 1.4 DUTY CYCLE

If duty cycle is  $\geq 98\%$ , duty factor is not required.

If duty cycle is  $< 98\%$ , duty factor shall be considered.

Remark	Delta 1			Delta 2	On Time/Period	10 log(1/Duty Cycle)	1/On Time (B)
Mode	ON (ms)	Numbers (ON)	On Time (B) (ms)	Period (ON+OFF) (ms)	Duty Cycle (%)	Duty Factor (dB)	1/B Minimum VBW (kHz)
IEEE 802.11ax (HE20)	5.120	1	5.120	5.160	99.22%	0.03	0.010
IEEE 802.11ax (HE40)	7.925	1	7.925	7.965	99.50%	0.02	0.010
IEEE 802.11ax (HE80)	2.580	1	2.580	2.640	97.73%	0.10	0.388
IEEE 802.11ax (HE160)	2.600	1	2.600	2.650	98.11%	0.08	0.010

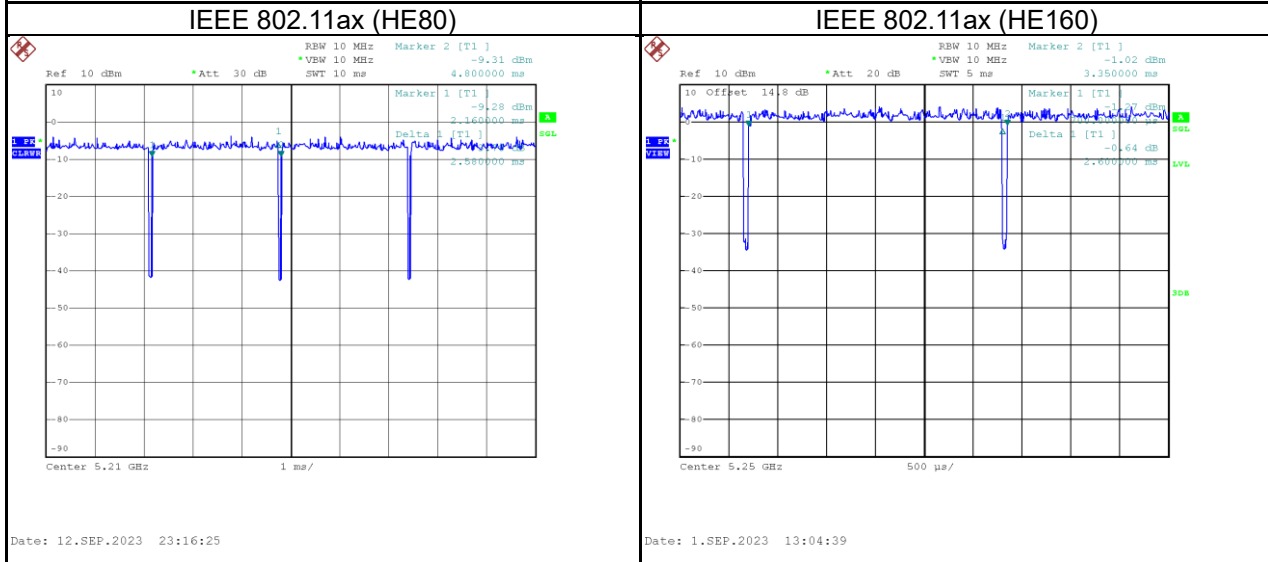
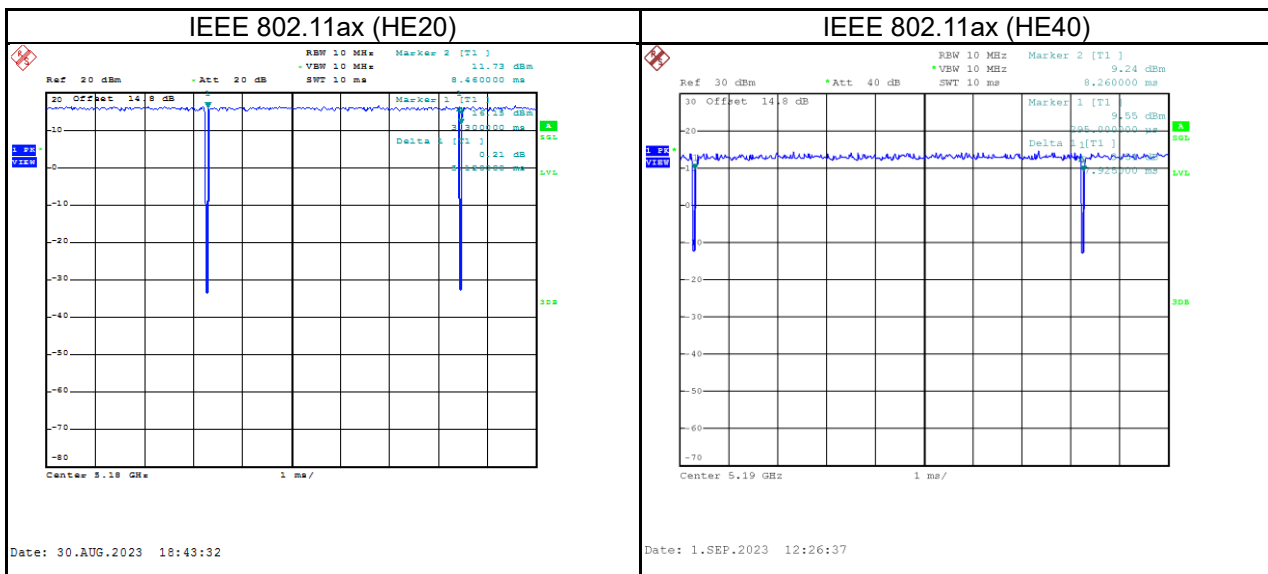



## 2 GENERAL INFORMATION

### 2.1 EUT INFORMATION

Equipment	Notebook Computer
Model Name	14T90S, 14TD90S, 14TG90S, 14TB90S, 14TW90S, 14TN90S, 14T90S* (* can be 0 to 9 or A to Z or blank denoting buyer request)
Brand Name	LG
Model Difference	Different model distribute to different area.
Power Source	DC voltage supplied from AC/DC Adapter.
Power Rating	20V --- 3.25A
Power Adapter Power Rating	Input: 100-240V~ 1.6A, 50-60Hz Output: 5.0Vdc 3.0A 15.0W or 9.0Vdc 3.0A 27.0W or 15.0Vdc 3.0A 45.0W or 20.0Vdc 3.25A 65.0W (PPS) 5.0V-20.0Vdc 3.25A Max 65.0W
Products Covered	LG / LP65WFC20P-NJ
Frequency Range	U-NII 5: 5925 MHz ~ 6425 MHz U-NII 6: 6425 MHz ~ 6525 MHz U-NII 7: 6525 MHz ~ 6875 MHz U-NII 8: 6875 MHz ~ 7125 MHz
Operation Frequency	UNII-5: 5955 MHz ~ 6435 MHz UNII-6: 6435 MHz ~ 6515 MHz UNII-7: 6525 MHz ~ 6875 MHz UNII-8: 6895 MHz ~ 7115 MHz
Modulation Technology	OFDMA
Transfer Rate	IEEE 802.11ax: up to 2402 Mbps
Maximum E.I.R.P. for UNII-5	IEEE 802.11ax (HE20): 6.10 dBm (0.0041 W) IEEE 802.11ax (HE40): 9.35 dBm (0.0086 W) IEEE 802.11ax (HE80): 11.84 dBm (0.0153 W) IEEE 802.11ax (HE160): 14.59 dBm (0.0288 W)
Maximum E.I.R.P. for UNII-6	IEEE 802.11ax (HE20): 6.10 dBm (0.0041 W) IEEE 802.11ax (HE40): 9.08 dBm (0.0081 W) IEEE 802.11ax (HE80): 11.56 dBm (0.0143 W) IEEE 802.11ax (HE160): 14.52 dBm (0.0283 W)
Maximum E.I.R.P. for UNII-7	IEEE 802.11ax (HE20): 5.31 dBm (0.0034 W) IEEE 802.11ax (HE40): 9.04 dBm (0.0080 W) IEEE 802.11ax (HE80): 11.08 dBm (0.0128 W) IEEE 802.11ax (HE160): 13.78 dBm (0.0239 W)
Maximum E.I.R.P. for UNII-8	IEEE 802.11ax (HE20): 5.34 dBm (0.0034 W) IEEE 802.11ax (HE40): 8.59 dBm (0.0072 W) IEEE 802.11ax (HE80): 11.09 dBm (0.0128 W) IEEE 802.11ax (HE160): 13.73 dBm (0.0236 W)
Test Software Version	DRTU V03544.22.200.0
Test Model	14T90S
Sample Status	Engineering Sample
EUT Modification(s)	N/A

**NOTE:**

- (1) The above EUT information is declared by manufacturer and for more detailed features description, please refers to the manufacturer's specifications or user's manual.

## (2) Channel List:

UNII-5							
IEEE 802.11ax (HE20)		IEEE 802.11ax (HE40)		IEEE 802.11ax (HE80)		IEEE 802.11ax (HE160)	
Channel	Frequency (MHz)	Channel	Frequency (MHz)	Channel	Frequency (MHz)	Channel	Frequency (MHz)
1	5955	3	5965	7	5985	15	6025
5	5975	11	6005	23	6065	47	6185
9	5995	19	6045	39	6145	79	6345
13	6015	27	6085	55	6225		
17	6035	35	6125	71	6305		
21	6055	43	6165	87	6385		
25	6075	51	6205				
29	6095	59	6245				
33	6115	67	6285				
37	6135	75	6325				
41	6155	83	6365				
45	6175	91	6405				
49	6195						
53	6215						
57	6235						
61	6255						
65	6275						
69	6295						
73	6315						
77	6335						
81	6355						
85	6375						
89	6395						
93	6415						

UNII-6							
IEEE 802.11ax (HE20)		IEEE 802.11ax (HE40)		IEEE 802.11ax (HE80)		IEEE 802.11ax (HE160)	
Channel	Frequency (MHz)	Channel	Frequency (MHz)	Channel	Frequency (MHz)	Channel	Frequency (MHz)
97	6435	99	6445	103	6465	111	6505
101	6455	107	6485				
105	6475						
109	6495						
113	6515						

UNII-7							
IEEE 802.11ax (HE20)		IEEE 802.11ax (HE40)		IEEE 802.11ax (HE80)		IEEE 802.11ax (HE160)	
Channel	Frequency (MHz)	Channel	Frequency (MHz)	Channel	Frequency (MHz)	Channel	Frequency (MHz)
117	6535	115	6525	119	6545	143	6665
121	6555	123	6565	135	6625	175	6825
125	6575	131	6605	151	6705		
129	6595	139	6645	167	6785		
133	6615	147	6685	183	6865		
137	6635	155	6725				
141	6655	163	6765				
145	6675	171	6805				
149	6695	179	6845				
153	6715						
157	6735						
161	6755						
165	6775						
169	6795						
173	6815						
177	6835						
181	6855						

UNII-8							
IEEE 802.11ax (HE20)		IEEE 802.11ax (HE40)		IEEE 802.11ax (HE80)		IEEE 802.11ax (HE160)	
Channel	Frequency (MHz)	Channel	Frequency (MHz)	Channel	Frequency (MHz)	Channel	Frequency (MHz)
185	6875	187	6885	199	6945	207	6985
189	6895	195	6925	215	7025		
193	6915	203	6965				
197	6935	211	7005				
201	6955	219	7045				
205	6975	227	7085				
209	6995						
213	7015						
217	7035						
221	7055						
225	7075						
229	7095						
233	7115						

(3) Table for Filed Antenna:

NB:

Ant.	Brand	Part number	Type	Frequency Range (MHz)	Gain (dBi)
Main	Pulse	DQ602118000	PIFA	5925-6425	1.10
				6425-6525	-1.20
				6525-6875	-0.35
				6875-7125	-0.35
Aux	Pulse	DQ602118000	PIFA	5925-6425	0.66
				6425-6525	-0.34
				6525-6875	0.75
				6875-7125	0.17

Ant.	Brand	Part number	Type	Frequency Range (MHz)	Gain (dBi)
Main	CHILISIN	DQ600111501	PIFA	5925-6425	0.97
				6425-6525	-1.44
				6525-6875	-0.67
				6875-7125	-0.99
Aux	CHILISIN	DQ600111501	PIFA	5925-6425	0.39
				6425-6525	-0.53
				6525-6875	0.47
				6875-7125	0.09

TB:

Ant.	Brand	Part number	Type	Frequency Range (MHz)	Gain (dBi)
Main	Pulse	DQ602118000	PIFA	5925-6425	0.10
				6425-6525	-1.82
				6525-6875	-1.29
				6875-7125	-1.14
Aux	Pulse	DQ602118000	PIFA	5925-6425	0.57
				6425-6525	-0.44
				6525-6875	-0.29
				6875-7125	1.50

Ant.	Brand	Part number	Type	Frequency Range (MHz)	Gain (dBi)
Main	CHILISIN	DQ600111501	PIFA	5925-6425	-0.28
				6425-6525	-1.87
				6525-6875	-1.44
				6875-7125	-1.30
Aux	CHILISIN	DQ600111501	PIFA	5925-6425	0.35
				6425-6525	-0.87
				6525-6875	-0.43
				6875-7125	1.13

CDD Directional Gain = Antenna Gain + Array Gain, Array Gain = 0 dB for NANT ≤ 4; Beamforming Directional Gain = Antenna Gain + 10\*log (NANT/NSS).

(5) The above Antenna information are derived from the antenna data sheet provided by manufacturer and for more detailed features description, please refer to the manufacturer's specifications, the laboratory shall not be held responsible.

(6) Operating Mode and Antenna Configuration

TX Mode	Operating Mode	2TX
IEEE 802.11ax (HE20)		V (Main+ Aux)
IEEE 802.11ax (HE40)		V (Main+ Aux)
IEEE 802.11ax (HE80)		V (Main+ Aux)
IEEE 802.11ax (HE160)		V (Main+ Aux)

## 2.2 TEST MODES

Test Items	Test mode	Channel	Note
AC power line conducted emissions	Normal/Idle	-	-
Undesirable emissions (below 1GHz)	IEEE 802.11ax (HE20)	233	-
Undesirable emissions (above 1GHz)	IEEE 802.11ax (HE20)	1/93, 97/113 117/181, 185/233	Bandedge
	IEEE 802.11ax (HE40)	3/91, 99/107 115/179, 187/211/227	
	IEEE 802.11ax (HE80)	7/87, 103 119/151, 183/215	
	IEEE 802.11ax (HE160)	15/79, 111 143/175, 207	
Undesirable emissions (above 1GHz)	IEEE 802.11ax (HE20)	1/45/93 97/105/113 117/149/181 185/209/233	Harmonic
	IEEE 802.11ax (HE40)	3/43/91, 99/107/115 123/155/179 187/211/227	
	IEEE 802.11ax (HE80)	7/39/87, 103 119/151/183 199/215	
	IEEE 802.11ax (HE160)	15/47/79, 111 143/175, 207	
Maximum e.i.r.p. & Maximum transmitter channel bandwidth & Maximum power spectral density & In-band emission (Mask)	IEEE 802.11ax (HE20)	1/45/93 97/105/113 117/149/181 185/209/233	-
	IEEE 802.11ax (HE40)	3/43/91, 99/107/115 123/155/179 187/211/227	
	IEEE 802.11ax (HE80)	7/39/87, 103 119/151/183 199/215	
	IEEE 802.11ax (HE160)	15/47/79, 111 143/175, 207	
Contention-based protocol	IEEE 802.11ax (HE20)	37, 101 117, 197	-
	IEEE 802.11ax (HE160)	47, 111 143, 207	

**NOTE:**

- (1) For radiated emission band edge test, both Vertical and Horizontal are evaluated, but only the worst case (Horizontal) is recorded.
- (2) All X, Y and Z axes are evaluated, but only the worst case (X axis) is recorded.
- (3) For IEEE 802.11ax modes, refer to TCB Workshop presentations on October 3, 2018, after evaluated, all testing are performed under fully loaded conditions (Full RU). In the test data, only the partially loaded conditions data are marked with tones.

### 2.3 TESTED CONFIGURATION DIAGRAM

Equipment letters and Cable numbers refer to item numbers described in the tables of clause 2.4.

Undesirable emissions

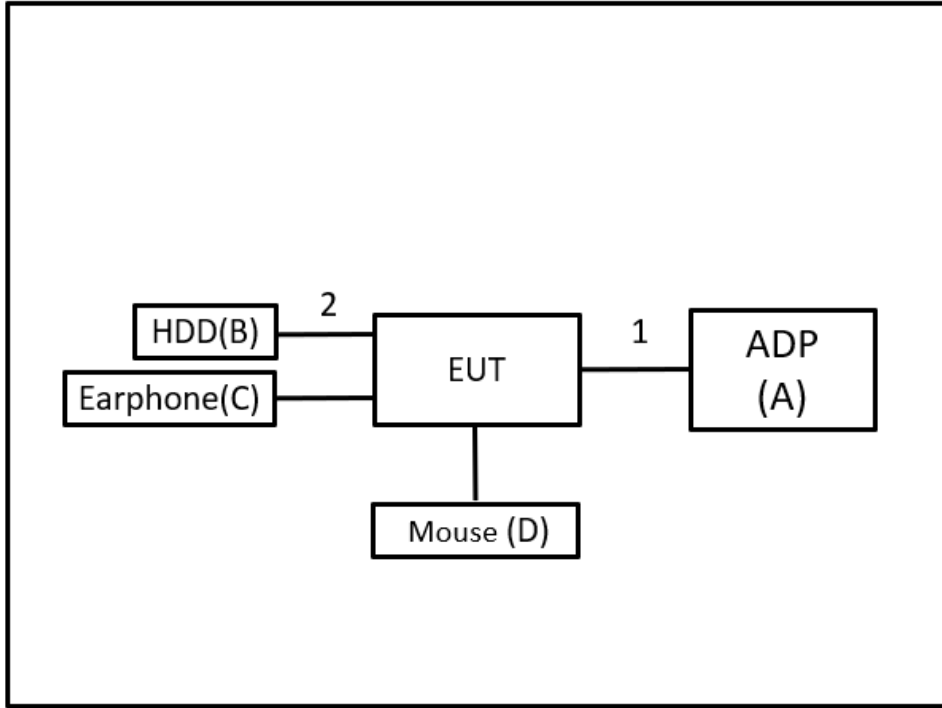

AC power line conducted emissions

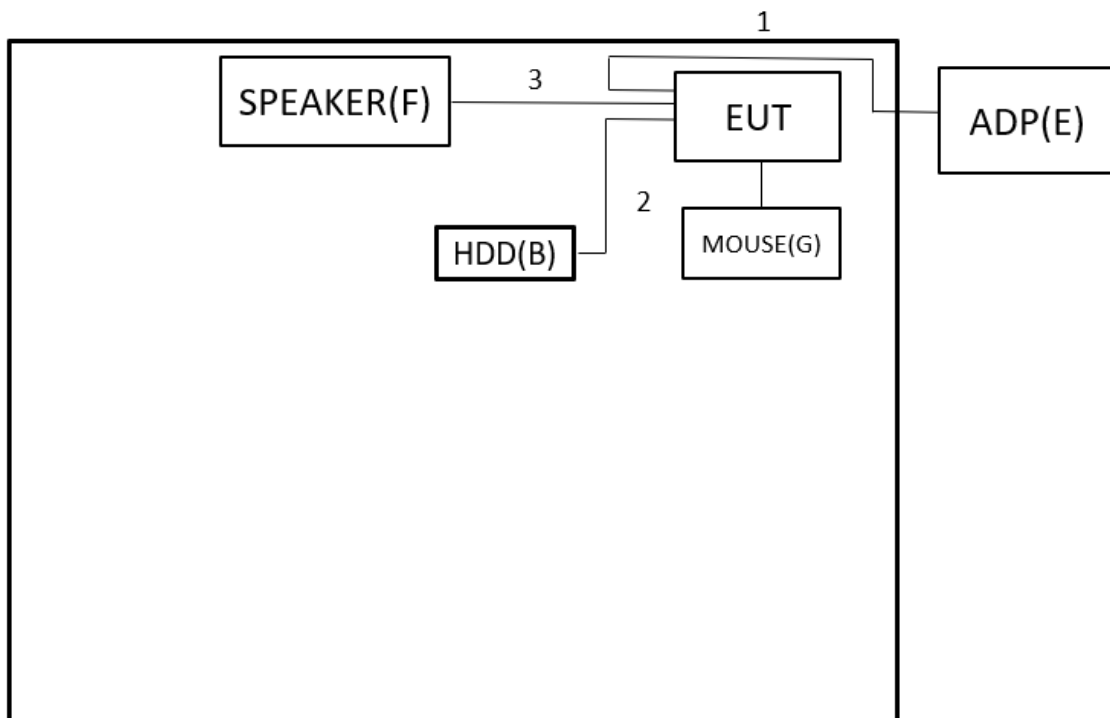

**2.4 SUPPORT UNITS**

Item	Equipment	Brand	Model No.	Series No.	Remarks
A	ADP	LG	LP65WFC209-NJ	N/A	Supplied by test requester
B	HDD	WD	WDBC3C0010BSL-0B	WXQ1A98NRHUU	Furnished by test lab.
C	Ear Phone	HTC	N/A	N/A	Furnished by test lab.
D	Mouse	Lenovo	SM-8823	N/A	Furnished by test lab.
E	ADP	LG	LP65WFC209-NJ	N/A	Supplied by test requester
F	SPEAKER	N/A	BV300S	N/A	Furnished by test lab.
G	Mouse	N/A	N/A	N/A	Furnished by test lab.

Item	Shielded	Ferrite Core	Length	Cable Type	Remarks
1	No	No	2m	USB-C to USB-C cable	Supplied by test requester
2	No	No	0.5m	USB-C to USB-C cable	Furnished by test lab.
3	No	No	1.5m	audio cable	Furnished by test lab.

### 3 MAXIMUM E.I.R.P. TEST

#### 3.1 LIMITS

According to 15.407(a)(4)(5)(6)(7)(8) the limits are as follows:

Equipment Category	Band	Maximum e.i.r.p. Limit
Standard power access point* Fixed client*	U-NII 5 (5.925-6.425 GHz)	36 dBm
	U-NII 7 (6.525-6.875 GHz)	
Indoor access point Subordinate device	U-NII 5 (5.925-6.425 GHz)	30 dBm
	U-NII 6 (6.425-6.525 GHz)	
	U-NII 7 (6.525-6.875 GHz)	
	U-NII 8 (6.875-7.125 GHz)	
Standard power access point client devices	U-NII 5 (5.925-6.425 GHz)	30 dBm and the device must limit its power to no more than 6 dB below its associated standard power access point's authorized transmit power
	U-NII 6 (6.425-6.525 GHz)	
	U-NII 7 (6.525-6.875 GHz)	
	U-NII 8 (6.875-7.125 GHz)	
Indoor access point client devices	U-NII 5 (5.925-6.425 GHz)	24 dBm
	U-NII 6 (6.425-6.525 GHz)	
	U-NII 7 (6.525-6.875 GHz)	
	U-NII 8 (6.875-7.125 GHz)	

\* For outdoor devices, the maximum e.i.r.p. at any elevation angle above 30 degrees as measured from the horizon must not exceed 125 mW (21 dBm).

According to 15.407(a)(11):

The maximum conducted output power must be measured over any interval of continuous transmission using instrumentation calibrated in terms of an rms-equivalent voltage.

#### 3.2 TEST PROCEDURE

Referring to FCC KDB 987594 D02, clause E. and FCC KDB 789033 D02, clause E. 3 Measurement using a Power Meter (PM):

- a. The maximum peak conducted output power was performed in accordance with method of clause E. 3. a) Method PM (Measurement using an RF average power meter):
  - (i) Measurements may be performed using a wideband RF power meter with a thermocouple detector or equivalent if all of the following conditions are satisfied:
    - The EUT is configured to transmit continuously or to transmit with a constant duty cycle.
    - At all times when the EUT is transmitting, it must be transmitting at its maximum power control level.
    - The integration period of the power meter exceeds the repetition period of the transmitted signal by at least a factor of five.
  - (ii) If the transmitter does not transmit continuously, measure the duty cycle,  $x$ , of the transmitter output signal.
  - (iii) Measure the average power of the transmitter. This measurement is an average over both the on and off periods of the transmitter.
  - (iv) Adjust the measurement in dBm by adding  $10 \log(1/x)$  where  $x$  is the duty cycle (e.g.,  $10 \log(1/0.25)$  if the duty cycle is 25%).
- b. The maximum peak conducted output power was performed in accordance with method of clause E. 3. b) Method PM-G (Measurement using a gated RF average power meter):
 

Measurements may be performed using a wideband gated RF power meter provided that the gate parameters are adjusted such that the power is measured only when the EUT is transmitting at its maximum power control level. Since the measurement is made only during the ON time of the transmitter, no duty cycle correction factor is required.



Referring to FCC KDB 987594 D02, clause H. Measurement of emission at elevation angles higher than 30° from horizon:

Note: Elevation angle is defined as 0° is horizontal and 90° is straight-up.

**For fixed infrastructure, not electrically or mechanically steerable beam antenna**

- a. If elevation plane radiation pattern is available:
  - (i) Determine the device intended mounting elevation angle and define 0° reference angle on the elevation plane radiation pattern.
  - (ii) Indicate any radiation pattern between 30° and 90° which has the highest gain.
  - (iii) Calculate the EIRP based on this highest gain and conducted output power.
  - (iv) Compare to the 125 mW limit to establish compliance.
  - (v) Include the elevation pattern data in the application filing with the test report to show how the calculations are made.

Note: For MIMO devices, take the maximum gain of each antenna and apply the guidance in KDB Publication 662911 for calculating the overall gain including directional gain for the maximum EIRP calculation.

- b. If the elevation plane radiation pattern is not available, but the antenna type (such as dipole omnidirectional, Yagi, parabolic, or sector antenna) has a symmetrical elevation plane pattern referenced at the main beam and all lobes on the main beam elevation plane have highest gains, then the following measurement method is acceptable to determine compliance:
  - (i) Determine the device's intended mounting elevation angle referenced to the horizon.
  - (ii) Rotate the EUT antenna by 90° around the main beam axis in a horizontal position to transform the measurement in elevation angle into an azimuth angle and define a 0° reference angle based on the device's intended mounting elevation angle.
  - (iii) Move the test antenna along the horizontal arc, or rotate the turntable with the EUT antenna placed at the center, between 30° and 90° relative to the 0° reference angle, and then continuing down from 90° to 30° on the other side of the pattern, while maintaining the test antenna pointing with constant distance to the EUT antenna. Search for the spot which has the highest measured emission. Both horizontal and vertical polarization shall be investigated to determine the maximum radiated emission level.

Note: Moving the test antenna along the horizontal arc, or rotating the turntable, shall be performed in an angular step size as small as possible, but not larger than 3°.

- (iv) Calculate the EIRP based on the highest measured emission. Compare to the limit of 125 mW to determine compliance.
- (v) The antenna pattern measurements must be included in the filing.

**For All Other Antenna Types**

For all other antenna types (such as patch antennas, array antennas, antennas with irregular radiator shapes, etc.) which have any combination of following characteristics:

- Asymmetrical, complex radiation patterns
- 2-D or 3-D steerable beam
- Portable/mobile, not fixed infrastructure device

Provide the following information in the report:

- a. Describe what type of antenna is used.
- b. Determine by calculation, measurement or simulation, all radiation lobes/beams, which have EIRP higher than 125 mW within a 3-dB elevation beamwidth.
- c. Provide an explanation of how these antenna beams are controlled to be kept below the 30° elevation angle. The explanation should include device installation instructions, mechanical control, electro-mechanical control or software algorithms, if the beams are electrically controlled by software.

**3.3 DEVIATION FROM TEST STANDARD**

No deviation.

**3.4 TEST SETUP****3.5 EUT OPERATING CONDITIONS**

The EUT was programmed to be in continuously transmitting mode.

**3.6 TEST RESULT**

Please refer to the APPENDIX A.

## 4 MAXIMUM TRANSMITTER CHANNEL BANDWIDTH TEST

### 4.1 LIMITS

According to 15.407(a)(10):

The maximum transmitter channel bandwidth for U-NII devices in the 5.925-7.125 GHz band is 320 megahertz.

### 4.2 TEST PROCEDURE

#### For Emission Bandwidth (EBW):

Referring to FCC KDB 987594 D02, clause C. and FCC KDB 789033 D02, clause C. 1. Emission Bandwidth (EBW):

- a) Set RBW = approximately 1% of the emission bandwidth.
- b) Set the VBW > RBW.
- c) Detector = Peak.
- d) Trace mode = max hold.
- e) Measure the maximum width of the emission that is 26 dB down from the maximum of the emission. Compare this with the RBW setting of the analyzer. Readjust RBW and repeat measurement as needed until the RBW/EBW ratio is approximately 1%.

#### For 99% Occupied Bandwidth:

Referring to FCC KDB 987594 D02, clause D. and FCC KDB 789033 D02, clause D. 99% Occupied Bandwidth:

The 99% occupied bandwidth is the frequency bandwidth such that, below its lower and above its upper frequency limits, the mean powers are each equal to 0.5% of the total mean power of the given emission. Measurement of the 99% occupied bandwidth is required only as a condition for using the optional band-edge measurement techniques. Measurements of 99% occupied bandwidth may also optionally be used in lieu of the EBW to define the minimum frequency range over which the spectrum is integrated when measuring maximum conducted output power. However, the EBW must be measured to determine bandwidth dependent limits on maximum conducted output power in accordance with Section 15.407(a).

The following procedure shall be used for measuring (99%) power bandwidth:

1. Set center frequency to the nominal EUT channel center frequency.
2. Set span = 1.5 times to 5.0 times the OBW.
3. Set RBW = 1% to 5% of the OBW
4. Set VBW  $\geq 3 \times$  RBW
5. Video averaging is not permitted. Where practical, a sample detection and single sweep mode shall be used. Otherwise, peak detection and max hold mode (until the trace stabilizes) shall be used.
6. Use the 99% power bandwidth function of the instrument (if available).
7. If the instrument does not have a 99% power bandwidth function, the trace data points are recovered and directly summed in power units. The recovered amplitude data points, beginning at the lowest frequency, are placed in a running sum until 0.5% of the total is reached; that frequency is recorded as the lower frequency. The process is repeated until 99.5% of the total is reached; that frequency is recorded as the upper frequency. The 99% occupied bandwidth is the difference between these two frequencies.

**4.3 DEVIATION FROM TEST STANDARD**

No deviation.

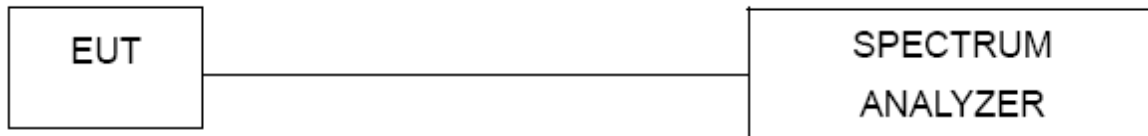
**4.4 TEST SETUP****4.5 EUT OPERATING CONDITIONS**

The EUT was programmed to be in continuously transmitting mode.

**4.6 TEST RESULT**

Please refer to the APPENDIX B.

## 5 MAXIMUM POWER SPECTRAL DENSITY TEST

### 5.1 LIMITS

According to 15.407(a)(4)(5)(6)(7)(8) the limits are as follows:

Equipment Category	Band	Maximum Power Spectral Density (e.i.r.p.) Limit
Standard power access point Fixed client	U-NII 5 (5.925-6.425 GHz)	23 dBm/MHz
	U-NII 7 (6.525-6.875 GHz)	
Indoor access point Subordinate device	U-NII 5 (5.925-6.425 GHz)	5 dBm/MHz
	U-NII 6 (6.425-6.525 GHz)	
	U-NII 7 (6.525-6.875 GHz)	
Standard power access point client devices	U-NII 8 (6.875-7.125 GHz)	17 dBm/MHz
	U-NII 5 (5.925-6.425 GHz)	
	U-NII 6 (6.425-6.525 GHz)	
	U-NII 7 (6.525-6.875 GHz)	
Indoor access point client devices	U-NII 8 (6.875-7.125 GHz)	-1 dBm/MHz
	U-NII 5 (5.925-6.425 GHz)	
	U-NII 6 (6.425-6.525 GHz)	
	U-NII 7 (6.525-6.875 GHz)	

### 5.2 TEST PROCEDURE

Referring to FCC KDB 987594 D02, clause F. and FCC KDB 789033 D02, clause F. Maximum Power Spectral Density (PSD):

Method SA-1 is used.

- a. Set Attenuation = auto.
- b. Span Frequency = Encompass the entire emissions bandwidth (EBW) of the signal.
- c. Set RBW = 1 MHz.
- d. Set VBW > 3 MHz.
- e. Detector = RMS.
- f. Trace mode = max hold.
- g. Sweep time = auto.
- h. Record the maximum value.
- i. Record the maximum value and add  $10 \log(1/\text{duty cycle})$ .
- j. Record the maximum value and add 1 dB.

**5.3 DEVIATION FROM TEST STANDARD**

No deviation.

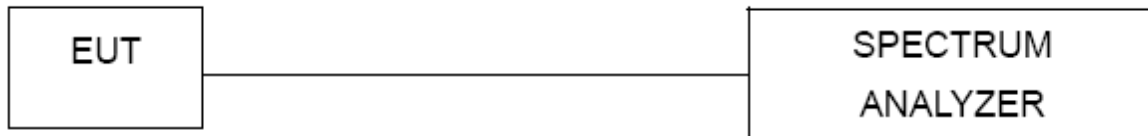
**5.4 TEST SETUP****5.5 EUT OPERATING CONDITIONS**

The EUT was programmed to be in continuously transmitting mode.

**5.6 TEST RESULT**

Please refer to the APPENDIX C.

## 6 UNDESIRABLE EMISSIONS TEST

### 6.1 LIMITS

According to 15.407(b)(6) the limits are as follows:

For transmitters operating within the 5.925-7.125 GHz band: Any emissions outside of the 5.925-7.125 GHz band must not exceed an e.i.r.p. of -27 dBm/MHz.

According to FCC KDB 987594 D02, clause G. Unwanted Emission Measurement:

Use guidance in KDB 789033 for measurements below 1000 MHz and above 1000 MHz. Unwanted emissions outside of restricted bands are measured with a RMS detector. In addition, 15.35(b) applies where the peak emissions must be limited to no more than 20 dB above the average limit

Item	Maximum e.i.r.p. Limit	Maximum field strength Limit @ 3m
Any emissions outside of the 5.925-7.125 GHz band	Peak: -7 dBm/MHz	88.2 dBuV/m
	Average: -27 dBm/MHz	68.2 dBuV/m

Unwanted emissions below 1 GHz must comply with the general field strength limits set forth in § 15.209.

Frequency (MHz)	Field Strength (microvolts/meter)	Measurement Distance (meters)
0.009~0.490	2400/F(kHz)	300
0.490~1.705	24000/F(kHz)	30
1.705~30.0	30	30
30~88	100	3
88~216	150	3
216~960	200	3
960~1000	500	3

According to 15.407(b)(9) the limits are as follows:

Unwanted emissions below 1 GHz must comply with the general field strength limits set forth in § 15.209.

Frequency (MHz)	Field Strength (microvolts/meter)	Measurement Distance (meters)
0.009~0.490	2400/F(kHz)	300
0.490~1.705	24000/F(kHz)	30
1.705~30.0	30	30
30~88	100	3
88~216	150	3
216~960	200	3
960~1000	500	3

**NOTE:**

- (1) e.i.r.p. Limit (dBuV/m at 3m) = Power Limit(dBm) + 95.2. (Referring to FCC KDB 987594 D02, clause G.2.d)(iii))
- (2) Emission level (dBuV/m) = 20log Emission level (uV/m).  
3 m Emission level = 10 m Emission level + 20log(10 m/3 m).

(3) The test result calculated as following:

Measurement Value = Reading Level + Correct Factor

Correct Factor = Antenna Factor + Cable Loss - Amplifier Gain (if use)

Margin Level = Measurement Value - Limit Value

Calculation example:

Reading Level		Correct Factor		Measurement Value
19.11	+	2.11	=	21.22

Measurement Value		Limit Value		Margin Level
21.22	-	68.2	=	-46.98

Spectrum Parameter	Setting
Attenuation	Auto
Start Frequency	1000 MHz
Stop Frequency	10th carrier harmonic
RBW / VBW (Emission in restricted band)	1MHz / 3MHz for Peak, 1MHz / 1/T for Average

Spectrum Parameter	Setting
Attenuation	Auto
Start ~ Stop Frequency	9KHz~90KHz for PK/AVG detector
Start ~ Stop Frequency	90KHz~110KHz for QP detector
Start ~ Stop Frequency	110KHz~490KHz for PK/AVG detector
Start ~ Stop Frequency	490KHz~30MHz for QP detector
Start ~ Stop Frequency	30MHz~1000MHz for QP detector

## 6.2 TEST PROCEDURE

Referring to FCC KDB 987594 D02, clause G. and FCC KDB 789033 D02, clause G. Unwanted Emission Measurement:

For measurements below 30 MHz:

- The EUT was placed on the top of a rotating table 0.8 meters above the ground at a 3 meter chamber room. The table was rotated 360 degrees to determine the position of the highest radiation.
- The EUT was set 3 meters away from the interference-receiving antenna, which was mounted on the top of a variable-height antenna tower.
- Parallel, perpendicular, and ground-parallel orientations of the antenna are set to make the measurement.
- For each suspected emission, the EUT was arranged to its worst case and the rotatable table was turned from 0 degrees to 360 degrees to find the maximum reading.
- The test-receiver system was set to Quasi-Peak Detect Function and Specified Bandwidth with Maximum Hold Mode.

For measurements 30 MHz to 40 GHz:

- The measuring distance of 3 m shall be used for measurements. The EUT was placed on the top of a rotating table 0.8 meter above the ground at a 3 meter semi-anechoic chamber. The table was rotated 360 degrees to determine the position of the highest radiation. (between 30 MHz to 1 GHz)
- The measuring distance of 3 m shall be used for measurements. The EUT was placed on the top of a rotating table 1.5 meter above the ground at a 3 meter semi-anechoic chamber. The table was rotated 360 degrees to determine the position of the highest radiation. (between 1 GHz to 40 GHz)
- The height of the equipment or of the substitution antenna shall be 0.8 m or 1.5 m, the height of the test antenna shall vary between 1 m to 4 m. Both horizontal and vertical polarizations of the antenna are set to make the measurement.
- For each suspected emission, the EUT was arranged to its worst case and then the antenna was tuned to heights find the maximum reading (used Bore sight function).
- The receiver system was set to peak and average detect function and specified bandwidth with maximum hold mode when the test frequency is above 1GHz.



- f. The initial step in collecting radiated emission data is a receiver peak detector mode pre-scanning the measurement frequency range. Significant peaks are then marked and then Quasi Peak detector mode re-measured.
- g. All readings are Peak unless otherwise stated QP in column of Note. Peak denotes that the Peak reading compliance with the QP Limits and then QP Mode measurement didn't perform. (between 30 MHz to 1 GHz)
- h. All readings are Peak Mode value unless otherwise stated AVG in column of Note. If the Peak Mode Measured value compliance with the Peak Limits and lower than AVG Limits, the EUT shall be deemed to meet both Peak & AVG Limits and then only Peak Mode was measured, but AVG Mode didn't perform. (between 30 MHz to 1 GHz)

### 6.3 DEVIATION FROM TEST STANDARD

No deviation.

### 6.4 TEST SETUP

#### 9 kHz to 30 MHz

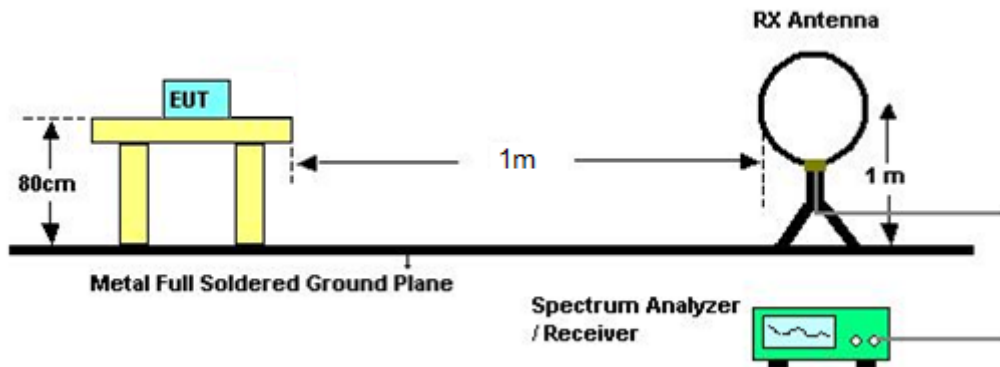

#### 30 MHz to 1 GHz

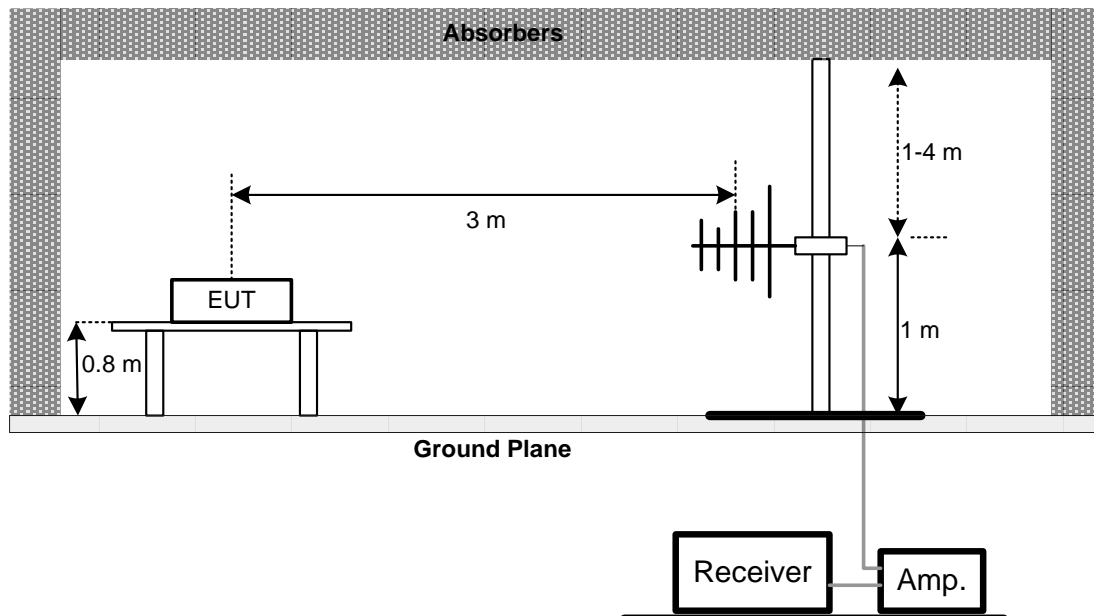

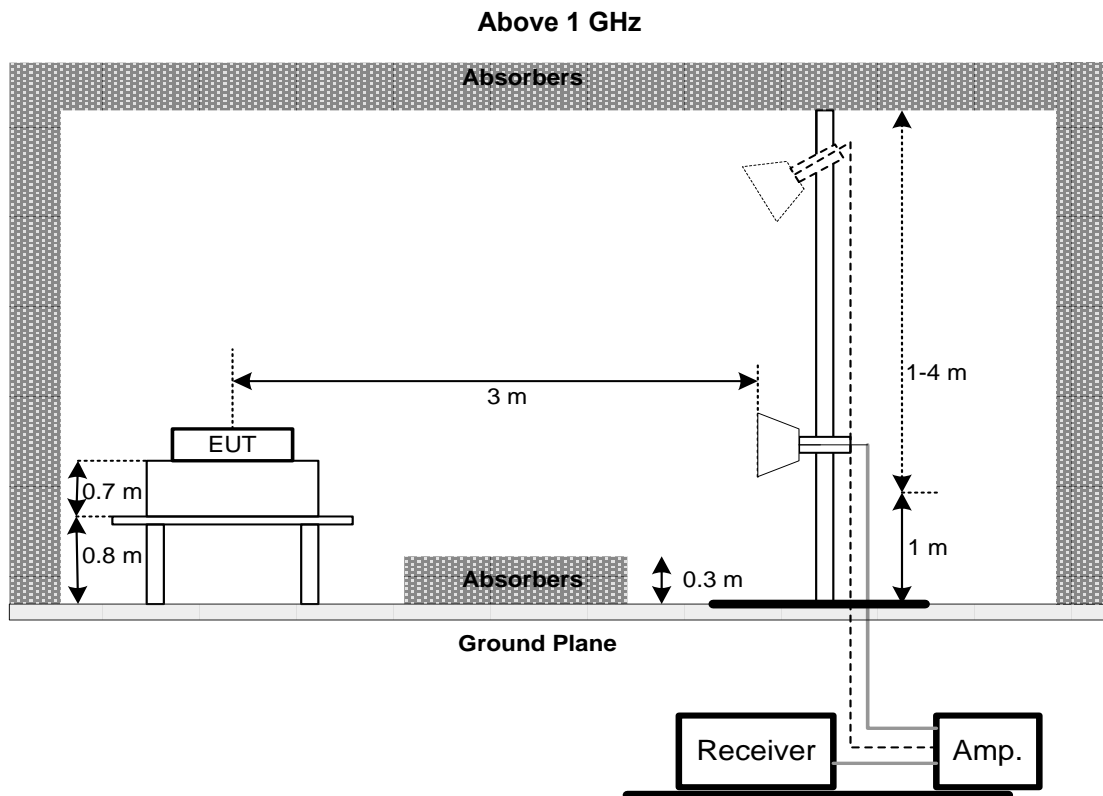

### 6.5 EUT OPERATING CONDITIONS

The EUT was programmed to be in continuously transmitting mode.

**NOTE:**

- (1) Distance extrapolation factor =  $40 \log(\text{specific distance} / \text{test distance})$  (dB).
- (2) Limit line = specific limits (dBuV) + distance extrapolation factor.

### 6.6 TEST RESULT – BELOW 30 MHZ

There were no emissions found below 30 MHz within 20 dB of the limit.

### 6.7 TEST RESULT – 30 MHZ TO 1 GHZ

Please refer to the APPENDIX D.

### 6.8 TEST RESULT – ABOVE 1 GHZ

Please refer to the APPENDIX E.

## 7 IN-BAND EMISSION (MASK) TEST

### 7.1 LIMITS

According to 15.407(b)(7) the limits are as follows:

Item	Test Frequency Range	Power spectral density suppressed Limit
In-Band Emissions (Mask)	at 1 MHz outside of channel edge	20 dB
	at one channel bandwidth from the channel center	28 dB
	at one- and one-half times the channel bandwidth away from channel center	40 dB
	Emissions removed from the channel center by more than one- and one-half times the channel bandwidth	40 dB

At frequencies between one megahertz outside an unlicensed device's channel edge and one channel bandwidth from the center of the channel, the limits must be linearly interpolated between 20 dB and 28 dB suppression, and at frequencies between one and one- and one-half times an unlicensed device's channel bandwidth, the limits must be linearly interpolated between 28 dB and 40 dB suppression.

### 7.2 TEST PROCEDURE

Referring to FCC KDB 987594 D02, clause J. In-Band Emissions:

- a. Connect output of the antenna port to a spectrum analyzer or EMI receiver, with appropriate attenuation, as to not damage the instrumentation.
- b. Set the reference level of the measuring equipment in accordance with procedure 4.1.5.2 of ANSI C63.10-2013.
- c. Measure the 26 dB EBW using the test procedure 12.4.1 of ANSI C63.10-2013. (This will be used to determine the channel edge.)
- d. Measure the power spectral density (which will be used for emissions mask reference) using the following procedure:
  - a) Set the span to encompass the entire 26 dB EBW of the signal.
  - b) Set RBW = same RBW used for 26 dB EBW measurement.
  - c) Set VBW  $\geq 3 \times$  RBW
  - d) Number of points in sweep  $\geq [2 \times \text{span} / \text{RBW}]$ .
  - e) Sweep time = auto.
  - f) Detector = RMS (i.e., power averaging)
  - g) Trace average at least 100 traces in power averaging (rms) mode.
  - h) Use the peak search function on the instrument to find the peak of the spectrum.
- e. For the purposes of developing the emission mask, the channel bandwidth is defined as the 26 dB EBW.
- f. Using the measuring equipment limit line function, develop the emissions mask based on the following requirements. The emissions power spectral density must be reduced below the peak power spectral density (in dB) as follows:
  - g. Suppressed by 20 dB at 1 MHz outside of the channel edge. (The channel edge is defined as the 26-dB point on either side of the carrier center frequency.)
  - h. Suppressed by 28 dB at one channel bandwidth from the channel center.
  - i. Suppressed by 40 dB at one- and one-half times the channel bandwidth from the channel center.
- j. Adjust the span to encompass the entire mask as necessary.
- k. Clear trace.
- l. Trace average at least 100 traces in power averaging (rms) mode.
- m. Adjust the reference level as necessary so that the crest of the channel touches the top of the emission mask.

**7.3 DEVIATION FROM TEST STANDARD**

No deviation.

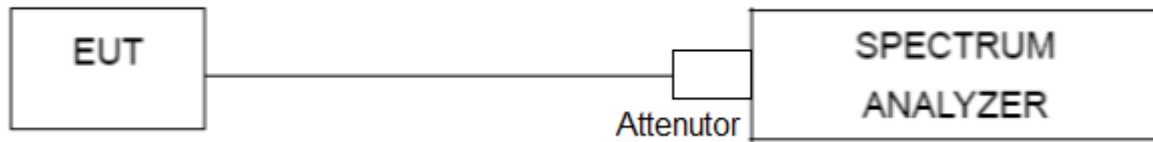
**7.4 TEST SETUP****7.5 EUT OPERATING CONDITIONS**

The EUT was programmed to be in continuously transmitting mode.

**7.6 TEST RESULT**

Please refer to the APPENDIX F.

## 8 AC POWER LINE CONDUCTED EMISSIONS TEST

### 8.1 LIMITS

According to 15.407(b)(9) the limits are as follows:

Frequency (MHz)	Limit (dB $\mu$ V)	
	Quasi-peak	Average
0.15 - 0.5	66 - 56 *	56 - 46 *
0.50 - 5.0	56	46
5.0 - 30.0	60	50

NOTE:

- (1) The tighter limit applies at the band edges.
- (2) The limit of " \* " marked band means the limitation decreases linearly with the logarithm of the frequency in the range.
- (3) The test result calculated as following:  
 Measurement Value = Reading Level + Correct Factor  
 Correct Factor = Insertion Loss + Cable Loss + Attenuator Factor (if use)  
 Margin Level = Measurement Value – Limit Value  
 Calculation example:

Reading Level		Correct Factor		Measurement Value
38.22	+	3.45	=	41.67

Measurement Value		Limit Value		Margin Level
41.67	-	60	=	-18.33

The following table is the setting of the receiver.

Receiver Parameter	Setting
Attenuation	10 dB
Start Frequency	0.15 MHz
Stop Frequency	30 MHz
IF Bandwidth	9 KHz

### 8.2 TEST PROCEDURE

- a. The EUT was placed 0.8 m above the horizontal ground plane with the EUT being connected to the power mains through a line impedance stabilization network (LISN).  
 All other support equipment were powered from an additional LISN(s).  
 The LISN provides 50 Ohm/50uH of impedance for the measuring instrument.
- b. Interconnecting cables that hang closer than 40 cm to the ground plane shall be folded back and forth in the center forming a bundle to keep the cable above 40 cm.
- c. Excess I/O cables that are not connected to a peripheral shall be bundled in the center.  
 The end of the cable will be terminated, using the correct terminating impedance.  
 The overall length shall not exceed 1 m.
- d. The LISN is spaced at least 80 cm from the nearest part of the EUT chassis.
- e. For the actual test configuration, please refer to the related Item – EUT TEST PHOTOS.

NOTE:

- (1) In the results, each reading is marked as Peak, QP or AVG per the detector used.  
 BW=9 kHz (6 dB Bandwidth)
- (2) All readings are Peak unless otherwise stated QP or AVG in column of Note. Both the QP and the AVG readings must be less than the limit for compliance.

### 8.3 DEVIATION FROM TEST STANDARD

No deviation.

### 8.4 TEST SETUP

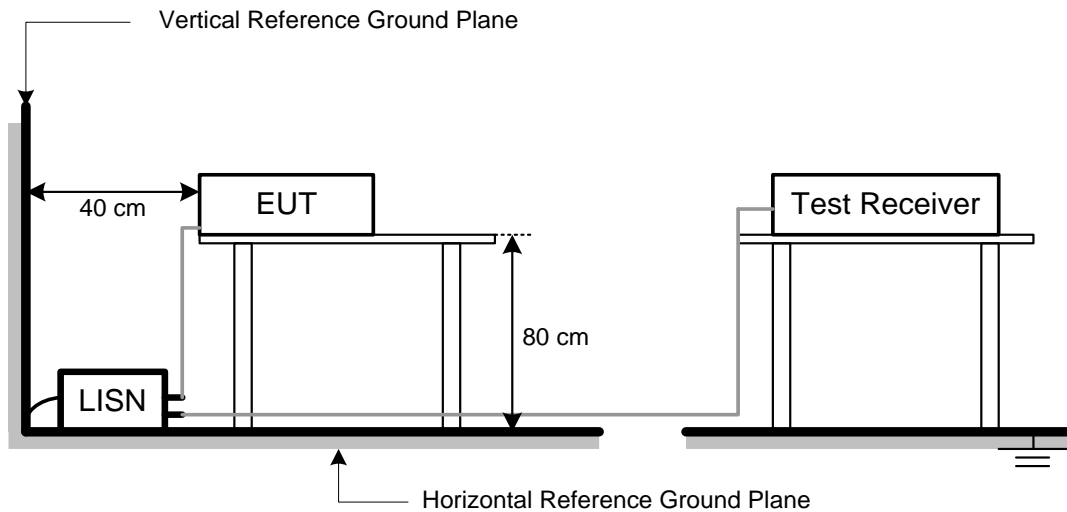

### 8.5 EUT OPERATING CONDITIONS

The EUT was configured for testing in a typical fashion (as a customer would normally use it). The EUT has been programmed to continuously transmit during test. This operating condition was tested and used to collect the included data.

The EUT was programmed to be in continuously transmitting/TX mode.

### 8.6 TEST RESULT

Please refer to the APPENDIX G.

## 9 CONTENTION-BASED PROTOCOL TEST

### 9.1 LIMITS

According to 15.407(d)(6) the limits are as follows:

Indoor access points, subordinate devices and client devices operating in the 5.925-7.125 GHz band must employ a contention-based protocol.

According to FCC KDB 987594 D02, clause I. Contention Based Protocol:

Indoor access points, subordinate devices and client devices operating in the 5.925-7.125 GHz band (herein referred to as unlicensed devices) are required to use technologies that include a contention-based protocol to avoid co-channel interference with incumbent devices sharing the band. To ensure incumbent co-channel operations are detected in a technology-agnostic manner, unlicensed devices are required to detect co-channel radio frequency energy (energy detect) and avoid simultaneous transmission.

Unlicensed low-power indoor devices must detect co-channel radio frequency power that is at least -62 dBm or lower. Upon detection of energy in the band, unlicensed low power indoor devices must vacate the channel (in which incumbent signal is transmitted) and stay off the incumbent channel as long as detected radio frequency power is equal to or greater than the threshold (-62 dBm)<sup>1</sup>. The -62 dBm (or lower) threshold is referenced to a 0 dBi antenna gain.

To ensure incumbent operations are reliably detected in the band, low power indoor devices must detect RF energy throughout their intended operating channel. For example, an 802.11 device that plans to transmit a 40 MHz- wide signal (on a primary 20 MHz channel and a secondary 20 MHz channel) must detect energy throughout the entire 40 MHz channel. Additionally, low-power indoor devices must detect co-channel energy with 90% or greater certainty.

### 9.2 TEST PROCEDURE

Referring to FCC KDB 987594 D02, clause I. Contention Based Protocol:

**Table 1. Criteria to determine number of times detection threshold test may be performed**

<b>If</b>	<b>Number of Tests</b>	<b>Placement of Incumbent Transmission</b>
$BW_{EUT} \leq BW_{Inc}$	Once	Tune incumbent and EUT transmissions ( $f_{c1} = f_{c2}$ )
$BW_{Inc} < BW_{EUT} \leq 2BW_{Inc}$	Once	Incumbent transmission is contained within $BW_{EUT}$
$2BW_{Inc} < BW_{EUT} \leq 4BW_{Inc}$	Twice. Incumbent transmission is contained within $BW_{EUT}$	Incumbent transmission is located as closely as possible to the lower edge and upper edge, respectively, of the EUT channel
$BW_{EUT} > 4BW_{Inc}$	Three times	Incumbent transmission is located as closely as possible to the lower edge of the EUT channel, in the middle of EUT channel, and as closely as possible to the upper edge of the EUT channel

**For Conducted measurement:**

- a. Configure the EUT to transmit with a constant duty cycle.
- b. Set the operating parameters of the EUT including power level, operating frequency, modulation and bandwidth.
- c. Set the signal analyzer center frequency to the nominal EUT channel center frequency. The span range of the signal analyzer shall be between two times and five times the OBW of the EUT. Connect the output port of the EUT to the signal analyzer 2. Ensure that the attenuator 2 provides enough attenuation to not overload the signal analyzer 2 receiver.
- d. Monitoring the signal analyzer 2, verify the EUT is operating and transmitting with the parameters set at step b.
- e. Using an AWGN signal source, generate (but do not transmit, i.e., RF OFF) a 10 MHz-wide AWGN signal. Use Table 1 to determine the center frequency of the 10 MHz AWGN signal relative to the EUT's channel bandwidth and center frequency.
- f. Set the AWGN signal power to an extremely low level (more than 20 dB below the -62 dBm threshold). Connect the AWGN signal source, via a 3-dB splitter, to the signal analyzer 1 and the EUT.
- g. Transmit the AWGN signal (RF ON) and verify its characteristics on the signal analyzer 1.
- h. Monitor the signal analyzer 2 to verify if the AWGN signal has been detected and the EUT has ceased transmission. If the EUT continues to transmit, then incrementally increase the AWGN signal power level until the EUT stops transmitting.
- i. (Including all losses in the RF paths) Determine and record the AWGN signal power level (at the EUT's antenna port) at which the EUT ceased transmission. Repeat the procedure at least 10 times to verify the EUT can detect an AWGN signal with 90% (or better) level of certainty.
- j. Refer to Table 1 to determine number of times the detection threshold testing needs to be repeated. If testing is required more than once, then go back to step e, choose a different center frequency for the AWGN signal and repeat the process.

**For Radiated measurement:**

- a. Using the AWGN signal source, generate (but do not transmit, i.e., RF OFF) a 10 MHz-wide AWGN signal. Use Table 1 to determine the center frequency of the 10 MHz AWGN signal relative to the EUT's channel bandwidth and center frequency.
- b. Connect the AWGN signal source to antenna 1 and transmit the signal (RF ON).
- c. Using signal analyzer 1 and antenna 2, measure the AWGN signal power level. Align antenna 2 and antenna 1 to maximize emission.
- d. Using equation  $P_2 = P_{\text{meas}} + L - G_2$ , correct the measured power  $P_{\text{meas}}$  by the gain of antenna 2,  $G_2$  and all cable losses and attenuations  $L$  to obtain the AWGN signal power level at antenna 2,  $P_2$ .
- e. Set the corrected power  $P_2$  to an extremely low level (more than 20 dB below the -62 dBm threshold).
- f. Place the EUT exactly where antenna 2 was. Configure the EUT to transmit a constant duty cycle.
- g. Set the operating parameters of the EUT including power level, operating frequency, modulation and bandwidth.
- h. Set the signal analyzer 1 center frequency to the nominal EUT channel center frequency. The span range of the signal analyzer shall be between two times and five times the OBW of EUT.
- i. Monitor the signal analyzer 1 to verify if AWGN signal has been detected and EUT has ceased transmission. If the EUT continues to transmit, then incrementally increase the AWGN signal power level until the EUT stops transmitting.
- j. Determine and record the AWGN signal power level at which the EUT ceased transmission. Repeat the procedure at least 10 times to verify the EUT can detect the AWGN signal with 90% (or better) level of certainty.
- k. Refer to Table 1 to determine number of times the detection threshold testing needs to be repeated. If testing is required more than once, then go back to step a, choose a different center frequency for the AWGN signal and repeat the process.

**9.3 DEVIATION FROM TEST STANDARD**

No deviation.



## 9.4 TEST SETUP

For Conducted measurement:

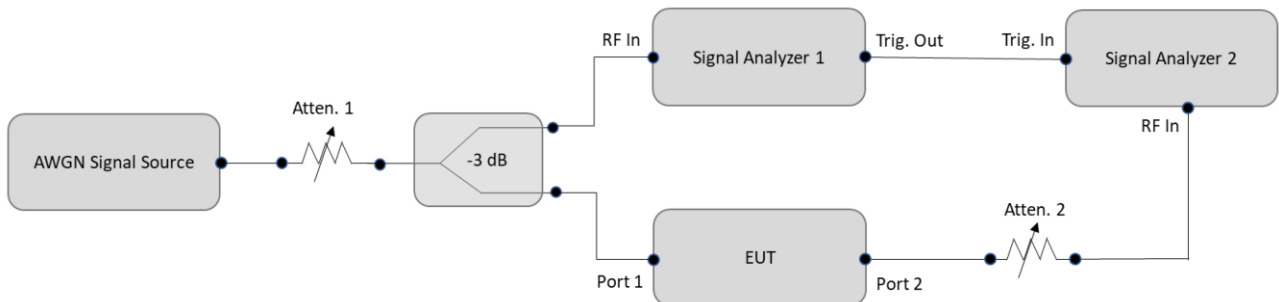

Figure 2. Contention-based protocol test setup, conducted method Step-by-Step Procedure, Conducted Setup

For Radiated measurement:

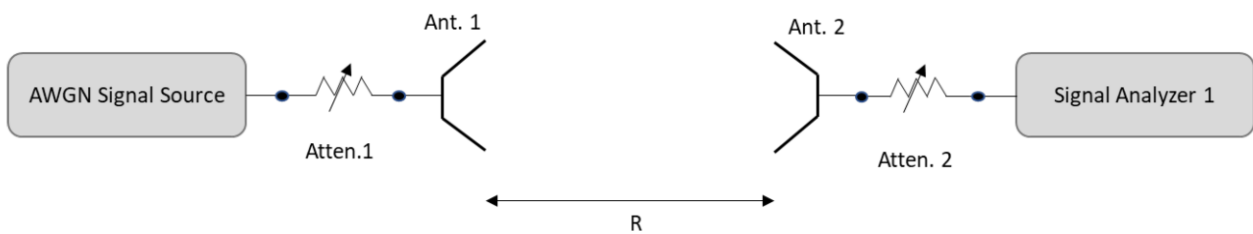

Figure 3. Contention-based protocol test setup, radiated method, power measurement

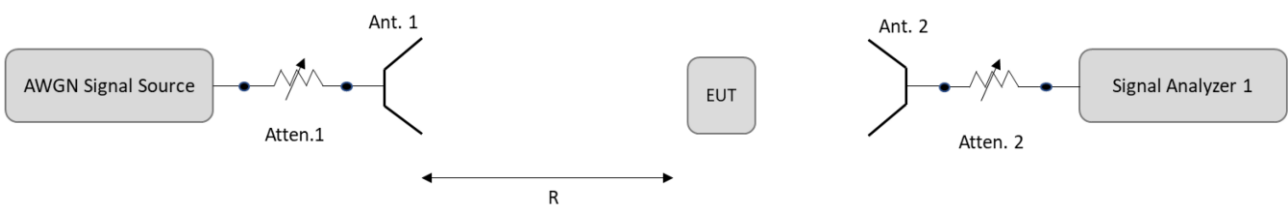

Figure 4. Contention-based protocol test setup, radiated method, detection threshold measurement

## 9.5 EUT OPERATING CONDITIONS

The EUT was Configured to be in normally transmitting mode with a constant duty cycle.

## 9.6 TEST RESULT

Please refer to the APPENDIX H.

## 10 LIST OF MEASURING EQUIPMENTS

Maximum e.i.r.p.						
Item	Kind of Equipment	Manufacturer	Type No.	Serial No.	Calibrated Date	Calibrated Until
1	Power Meter	Anritsu	ML2495A	1128008	2023/5/12	2024/5/11
2	Power Sensor	Anritsu	MA2411B	1126001	2023/5/12	2024/5/11

Maximum transmitter channel bandwidth & Maximum power spectral density & In-band emission (Mask)						
Item	Kind of Equipment	Manufacturer	Type No.	Serial No.	Calibrated Date	Calibrated Until
1	Spectrum Analyzer	Keysight	N9010A	MY56480489	2022/10/19	2023/10/18

Undesirable Emissions						
Item	Kind of Equipment	Manufacturer	Type No.	Serial No.	Calibrated Date	Calibrated Until
1	Preamplifier	EMCI	EMC330N	980850	2022/9/19	2023/9/18
2	Preamplifier	EMCI	EMC118A45SE	980819	2023/3/7	2024/3/6
3	Pre-Amplifier	EMCI	EMC184045SE	980907	2022/9/28	2023/9/27
4	Preamplifier	EMCI	EMC001340	980579	2022/9/30	2023/9/29
5	Test Cable	EMCI	EMC104-SM-1000	180809	2023/7/10	2024/7/9
6	Test Cable	EMCI	EMC104-SM-SM-3000	220322	2023/3/14	2024/3/13
7	Test Cable	EMCI	EMC104-SM-SM-7000	220324	2023/3/14	2024/3/13
8	EXA Signal Analyzer	keysight	N9020B	MY57120120	2023/2/24	2024/2/23
9	Loop Ant	Electro-Metrics	EMCI-LPA600	291	2022/9/19	2023/9/18
10	Horn Antenna	RFSPIN	DRH18-E	211202A18EN	2023/5/12	2024/5/11
11	Horn Ant	Schwarzbeck	BBHA 9170D	1136	2023/5/12	2024/5/11
12	Log-bicon Antenna	Schwarzbeck	VULB9168	1369	2023/5/9	2024/5/8
13	6dB Attenuator	EMCI	EMCI-N-6-06	AT-06001	2023/5/9	2024/5/8
14	Test Cable	EMCI	EMC101G-KM-KM-3000	220329	2023/3/14	2024/3/13
15	Test Cable	EMCI	EMC102-KM-KM-1000	220327	2023/3/14	2024/3/13
16	Measurement Software	EZ	EZ EMC (Version NB-03A1-01)	N/A	N/A	N/A

AC Power Line Conducted Emissions						
Item	Kind of Equipment	Manufacturer	Type No.	Serial No.	Calibrated Date	Calibrated Until
1	TWO-LINE V-NETWORK	R&S	ENV216	101521	2022/9/28	2023/9/27
2	Test Cable	EMCI	EMCCFD300-BM-BMR-5000	220331	2023/3/30	2024/3/29
3	EMI Test Receiver	R&S	ESR 7	101433	2022/11/16	2023/11/15
4	Measurement Software	EZ	EZ EMC (Version NB-03A1-01)	N/A	N/A	N/A

<b>Contention Based Protocol</b>						
Item	Kind of Equipment	Manufacturer	Type No.	Serial No.	Calibrated Date	Calibrated Until
1	MXG Vector Signal Generator	Agilent	N5182B	MY51350711	2023/2/21	2024/2/20
2	Spectrum Analyzer	Keysight	N9010A	MY54200240	2023/6/26	2024/6/24

## 11 EUT TEST PHOTOS

Please refer to document Appendix No.: TP-2308T045-FCCP-1 (APPENDIX-TEST PHOTOS).

## 12 EUT PHOTOS

Please refer to document Appendix No.: EP-2308T045-1 (APPENDIX-EUT PHOTOS).

## APPENDIX A MAXIMUM E.I.R.P.

Test Mode	IEEE 802.11ax (HE20)_ Main Antenna	Tested Date	2023/9/4
-----------	------------------------------------	-------------	----------

Test Frequency (MHz)	Conducted Power (dBm)	Conducted Power (W)	E.I.R.P. (dBm)	E.I.R.P. (W)	E.I.R.P. Limit (dBm)	E.I.R.P. Limit (W)	Result
5955	2.02	0.0016	3.12	0.0021	24.00	0.2512	Pass
6175	1.92	0.0016	3.02	0.0020	24.00	0.2512	Pass
6415	1.76	0.0015	2.86	0.0019	24.00	0.2512	Pass
6435	1.83	0.0015	2.93	0.0020	24.00	0.2512	Pass
6475	1.86	0.0015	2.96	0.0020	24.00	0.2512	Pass
6515	1.92	0.0016	3.02	0.0020	24.00	0.2512	Pass
6535	1.29	0.0013	2.39	0.0017	24.00	0.2512	Pass
6695	1.29	0.0013	2.39	0.0017	24.00	0.2512	Pass
6855	1.33	0.0014	2.43	0.0017	24.00	0.2512	Pass
6875	1.27	0.0013	2.37	0.0017	24.00	0.2512	Pass
6995	1.23	0.0013	2.33	0.0017	24.00	0.2512	Pass
7115	-2.05	0.0006	-0.95	0.0008	24.00	0.2512	Pass

Test Mode	IEEE 802.11ax (HE20)_ Aux Antenna	Tested Date	2023/9/4
-----------	-----------------------------------	-------------	----------

Test Frequency (MHz)	Conducted Power (dBm)	Conducted Power (W)	E.I.R.P. (dBm)	E.I.R.P. (W)	E.I.R.P. Limit (dBm)	E.I.R.P. Limit (W)	Result
5955	1.96	0.0016	3.06	0.0020	24.00	0.2512	Pass
6175	2.05	0.0016	3.15	0.0021	24.00	0.2512	Pass
6415	2.07	0.0016	3.17	0.0021	24.00	0.2512	Pass
6435	2.12	0.0016	3.22	0.0021	24.00	0.2512	Pass
6475	2.12	0.0016	3.22	0.0021	24.00	0.2512	Pass
6515	2.06	0.0016	3.16	0.0021	24.00	0.2512	Pass
6535	1.11	0.0013	2.21	0.0017	24.00	0.2512	Pass
6695	1.11	0.0013	2.21	0.0017	24.00	0.2512	Pass
6855	1.01	0.0013	2.11	0.0016	24.00	0.2512	Pass
6875	1.19	0.0013	2.29	0.0017	24.00	0.2512	Pass
6995	1.21	0.0013	2.31	0.0017	24.00	0.2512	Pass
7115	-2.66	0.0005	-1.56	0.0007	24.00	0.2512	Pass

Test Mode	IEEE 802.11ax (HE20)_ Total	Tested Date	2023/9/4
-----------	-----------------------------	-------------	----------

Test Frequency (MHz)	Conducted Power (dBm)	Conducted Power (W)	E.I.R.P. (dBm)	E.I.R.P. (W)	E.I.R.P. Limit (dBm)	E.I.R.P. Limit (W)	Result
5955	5.00	0.0032	6.10	0.0041	24.00	0.2512	Pass
6175	5.00	0.0032	6.10	0.0041	24.00	0.2512	Pass
6415	4.93	0.0031	6.03	0.0040	24.00	0.2512	Pass
6435	4.99	0.0032	6.09	0.0041	24.00	0.2512	Pass
6475	5.00	0.0032	6.10	0.0041	24.00	0.2512	Pass
6515	5.00	0.0032	6.10	0.0041	24.00	0.2512	Pass
6535	4.21	0.0026	5.31	0.0034	24.00	0.2512	Pass
6695	4.21	0.0026	5.31	0.0034	24.00	0.2512	Pass
6855	4.18	0.0026	5.28	0.0034	24.00	0.2512	Pass
6875	4.24	0.0027	5.34	0.0034	24.00	0.2512	Pass
6995	4.23	0.0026	5.33	0.0034	24.00	0.2512	Pass
7115	0.67	0.0012	1.77	0.0015	24.00	0.2512	Pass

Test Mode	IEEE 802.11ax (HE40)_ Main Antenna	Tested Date	2023/9/4
-----------	------------------------------------	-------------	----------

Test Frequency (MHz)	Conducted Power (dBm)	Conducted Power (W)	E.I.R.P. (dBm)	E.I.R.P. (W)	E.I.R.P. Limit (dBm)	E.I.R.P. Limit (W)	Result
5965	5.38	0.0035	6.48	0.0044	24.00	0.2512	Pass
6165	5.36	0.0034	6.46	0.0044	24.00	0.2512	Pass
6405	5.22	0.0033	6.32	0.0043	24.00	0.2512	Pass
6445	4.91	0.0031	6.01	0.0040	24.00	0.2512	Pass
6485	4.94	0.0031	6.04	0.0040	24.00	0.2512	Pass
6525	5.07	0.0032	6.17	0.0041	24.00	0.2512	Pass
6565	4.49	0.0028	5.59	0.0036	24.00	0.2512	Pass
6725	4.41	0.0028	5.51	0.0036	24.00	0.2512	Pass
6845	4.74	0.0030	5.84	0.0038	24.00	0.2512	Pass
6885	4.57	0.0029	5.67	0.0037	24.00	0.2512	Pass
7005	4.63	0.0029	5.73	0.0037	24.00	0.2512	Pass
7085	4.51	0.0028	5.61	0.0036	24.00	0.2512	Pass

Test Mode	IEEE 802.11ax (HE40)_ Aux Antenna	Tested Date	2023/9/4
-----------	-----------------------------------	-------------	----------

Test Frequency (MHz)	Conducted Power (dBm)	Conducted Power (W)	E.I.R.P. (dBm)	E.I.R.P. (W)	E.I.R.P. Limit (dBm)	E.I.R.P. Limit (W)	Result
5965	5.03	0.0032	6.13	0.0041	24.00	0.2512	Pass
6165	5.12	0.0033	6.22	0.0042	24.00	0.2512	Pass
6405	5.16	0.0033	6.26	0.0042	24.00	0.2512	Pass
6445	5.03	0.0032	6.13	0.0041	24.00	0.2512	Pass
6485	4.97	0.0031	6.07	0.0040	24.00	0.2512	Pass
6525	4.79	0.0030	5.89	0.0039	24.00	0.2512	Pass
6565	4.29	0.0027	5.39	0.0035	24.00	0.2512	Pass
6725	4.33	0.0027	5.43	0.0035	24.00	0.2512	Pass
6845	4.12	0.0026	5.22	0.0033	24.00	0.2512	Pass
6885	4.27	0.0027	5.37	0.0034	24.00	0.2512	Pass
7005	4.32	0.0027	5.42	0.0035	24.00	0.2512	Pass
7085	4.34	0.0027	5.44	0.0035	24.00	0.2512	Pass

Test Mode	IEEE 802.11ax (HE40)_ Total	Tested Date	2023/9/4
-----------	-----------------------------	-------------	----------

Test Frequency (MHz)	Conducted Power (dBm)	Conducted Power (W)	E.I.R.P. (dBm)	E.I.R.P. (W)	E.I.R.P. Limit (dBm)	E.I.R.P. Limit (W)	Result
5965	8.22	0.0066	9.32	0.0086	24.00	0.2512	Pass
6165	8.25	0.0067	9.35	0.0086	24.00	0.2512	Pass
6405	8.20	0.0066	9.30	0.0085	24.00	0.2512	Pass
6445	7.98	0.0063	9.08	0.0081	24.00	0.2512	Pass
6485	7.97	0.0063	9.07	0.0081	24.00	0.2512	Pass
6525	7.94	0.0062	9.04	0.0080	24.00	0.2512	Pass
6565	7.40	0.0055	8.50	0.0071	24.00	0.2512	Pass
6725	7.38	0.0055	8.48	0.0070	24.00	0.2512	Pass
6845	7.45	0.0056	8.55	0.0072	24.00	0.2512	Pass
6885	7.43	0.0055	8.53	0.0071	24.00	0.2512	Pass
7005	7.49	0.0056	8.59	0.0072	24.00	0.2512	Pass
7085	7.44	0.0055	8.54	0.0071	24.00	0.2512	Pass

Test Mode	IEEE 802.11ax (HE80)_ Main Antenna	Tested Date	2023/9/4
-----------	------------------------------------	-------------	----------

Test Frequency (MHz)	Conducted Power (dBm)	Conducted Power (W)	E.I.R.P. (dBm)	E.I.R.P. (W)	E.I.R.P. Limit (dBm)	E.I.R.P. Limit (W)	Result
5985	7.88	0.0061	8.98	0.0079	24.00	0.2512	Pass
6145	7.90	0.0062	9.00	0.0079	24.00	0.2512	Pass
6385	7.50	0.0056	8.60	0.0072	24.00	0.2512	Pass
6465	7.59	0.0057	8.69	0.0074	24.00	0.2512	Pass
6545	7.12	0.0052	8.22	0.0066	24.00	0.2512	Pass
6705	7.06	0.0051	8.16	0.0065	24.00	0.2512	Pass
6865	7.28	0.0053	8.38	0.0069	24.00	0.2512	Pass
6945	7.24	0.0053	8.34	0.0068	24.00	0.2512	Pass
7025	7.12	0.0052	8.22	0.0066	24.00	0.2512	Pass

Test Mode	IEEE 802.11ax (HE80)_ Aux Antenna	Tested Date	2023/9/4
-----------	-----------------------------------	-------------	----------

Test Frequency (MHz)	Conducted Power (dBm)	Conducted Power (W)	E.I.R.P. (dBm)	E.I.R.P. (W)	E.I.R.P. Limit (dBm)	E.I.R.P. Limit (W)	Result
5985	7.57	0.0057	8.67	0.0074	24.00	0.2512	Pass
6145	7.43	0.0055	8.53	0.0071	24.00	0.2512	Pass
6385	7.47	0.0056	8.57	0.0072	24.00	0.2512	Pass
6465	7.31	0.0054	8.41	0.0069	24.00	0.2512	Pass
6545	6.74	0.0047	7.84	0.0061	24.00	0.2512	Pass
6705	6.69	0.0047	7.79	0.0060	24.00	0.2512	Pass
6865	6.63	0.0046	7.73	0.0059	24.00	0.2512	Pass
6945	6.70	0.0047	7.80	0.0060	24.00	0.2512	Pass
7025	6.83	0.0048	7.93	0.0062	24.00	0.2512	Pass

Test Mode	IEEE 802.11ax (HE80)_ Total	Tested Date	2023/9/4
-----------	-----------------------------	-------------	----------

Test Frequency (MHz)	Conducted Power (dBm)	Conducted Power (W)	E.I.R.P. (dBm)	E.I.R.P. (W)	E.I.R.P. Limit (dBm)	E.I.R.P. Limit (W)	Result
5985	10.74	0.0119	11.84	0.0153	24.00	0.2512	Pass
6145	10.68	0.0117	11.78	0.0151	24.00	0.2512	Pass
6385	10.50	0.0112	11.60	0.0145	24.00	0.2512	Pass
6465	10.46	0.0111	11.56	0.0143	24.00	0.2512	Pass
6545	9.94	0.0099	11.04	0.0127	24.00	0.2512	Pass
6705	9.89	0.0097	10.99	0.0126	24.00	0.2512	Pass
6865	9.98	0.0099	11.08	0.0128	24.00	0.2512	Pass
6945	9.99	0.0100	11.09	0.0129	24.00	0.2512	Pass
7025	9.99	0.0100	11.09	0.0129	24.00	0.2512	Pass

Test Mode	IEEE 802.11ax (HE160)_ Main Antenna	Tested Date	2023/9/4
-----------	-------------------------------------	-------------	----------

Test Frequency (MHz)	Conducted Power (dBm)	Conducted Power (W)	E.I.R.P. (dBm)	E.I.R.P. (W)	E.I.R.P. Limit (dBm)	E.I.R.P. Limit (W)	Result
6025	10.53	0.0113	11.63	0.0146	24.00	0.2512	Pass
6185	10.53	0.0113	11.63	0.0146	24.00	0.2512	Pass
6345	10.59	0.0115	11.69	0.0148	24.00	0.2512	Pass
6505	10.53	0.0113	11.63	0.0146	24.00	0.2512	Pass
6665	9.85	0.0097	10.95	0.0124	24.00	0.2512	Pass
6825	9.84	0.0096	10.94	0.0124	24.00	0.2512	Pass
6985	9.83	0.0096	10.93	0.0124	24.00	0.2512	Pass

Test Mode	IEEE 802.11ax (HE160)_ Aux Antenna	Tested Date	2023/9/4
-----------	------------------------------------	-------------	----------

Test Frequency (MHz)	Conducted Power (dBm)	Conducted Power (W)	E.I.R.P. (dBm)	E.I.R.P. (W)	E.I.R.P. Limit (dBm)	E.I.R.P. Limit (W)	Result
6025	10.37	0.0109	11.47	0.0140	24.00	0.2512	Pass
6185	10.41	0.0110	11.51	0.0142	24.00	0.2512	Pass
6345	10.37	0.0109	11.47	0.0140	24.00	0.2512	Pass
6505	10.29	0.0107	11.39	0.0138	24.00	0.2512	Pass
6665	9.48	0.0089	10.58	0.0114	24.00	0.2512	Pass
6825	9.41	0.0087	10.51	0.0112	24.00	0.2512	Pass
6985	9.39	0.0087	10.49	0.0112	24.00	0.2512	Pass

Test Mode	IEEE 802.11ax (HE160)_ Total	Tested Date	2023/9/4
-----------	------------------------------	-------------	----------

Test Frequency (MHz)	Conducted Power (dBm)	Conducted Power (W)	E.I.R.P. (dBm)	E.I.R.P. (W)	E.I.R.P. Limit (dBm)	E.I.R.P. Limit (W)	Result
6025	13.46	0.0222	14.56	0.0286	24.00	0.2512	Pass
6185	13.48	0.0223	14.58	0.0287	24.00	0.2512	Pass
6345	13.49	0.0223	14.59	0.0288	24.00	0.2512	Pass
6505	13.42	0.0220	14.52	0.0283	24.00	0.2512	Pass
6665	12.68	0.0185	13.78	0.0239	24.00	0.2512	Pass
6825	12.64	0.0184	13.74	0.0237	24.00	0.2512	Pass
6985	12.63	0.0183	13.73	0.0236	24.00	0.2512	Pass



## **APPENDIX B MAXIMUM TRANSMITTER CHANNEL BANDWIDTH**

Test Mode | IEEE 802.11ax (HE20)\_ Main Antenna

Test Frequency (MHz)	26 dB Bandwidth (MHz)	99 % Occupied Bandwidth (MHz)	Limit (MHz)	Result
5955	26.72	19.20	320	Pass
6175	26.49	19.15	320	Pass
6415	25.56	19.14	320	Pass

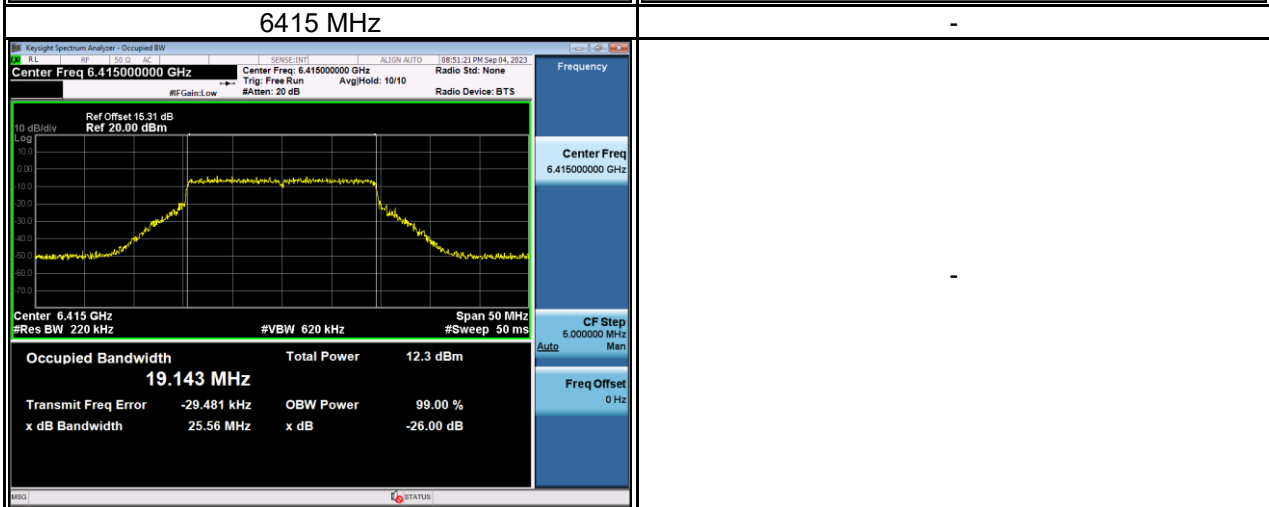
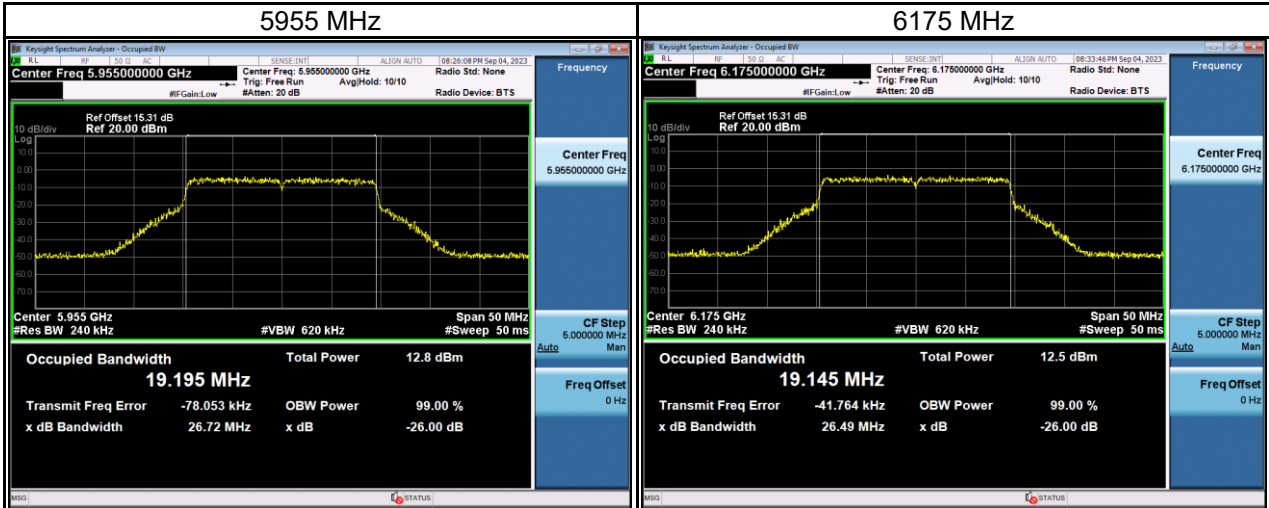

Test Frequency (MHz)	26 dB Bandwidth (MHz)	99 % Occupied Bandwidth (MHz)	Limit (MHz)	Result
6435	26.42	19.12	320	Pass
6475	25.67	19.10	320	Pass
6515	25.41	19.12	320	Pass

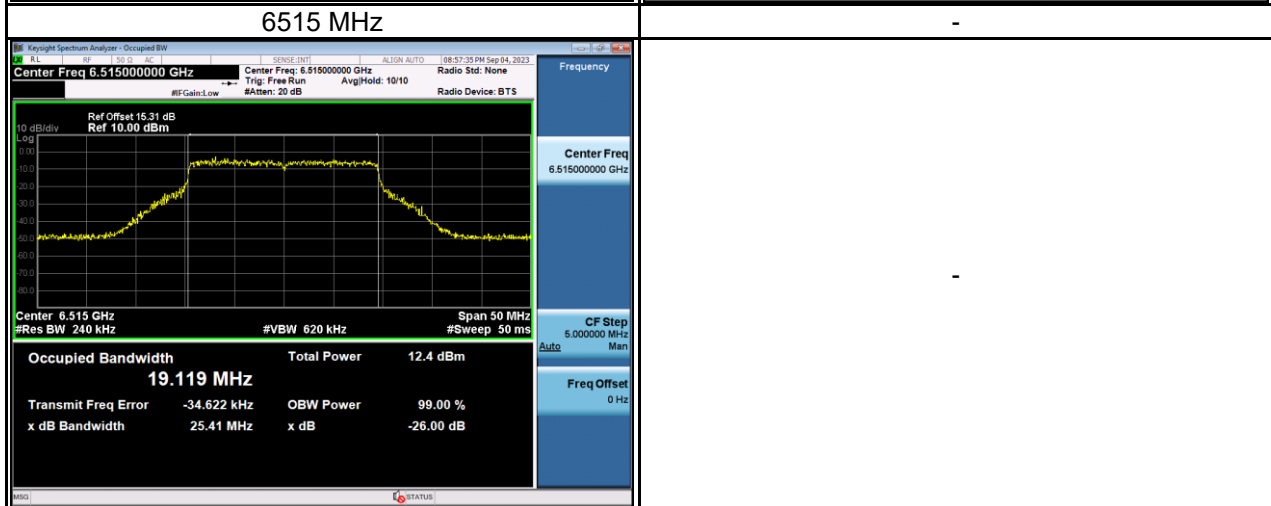
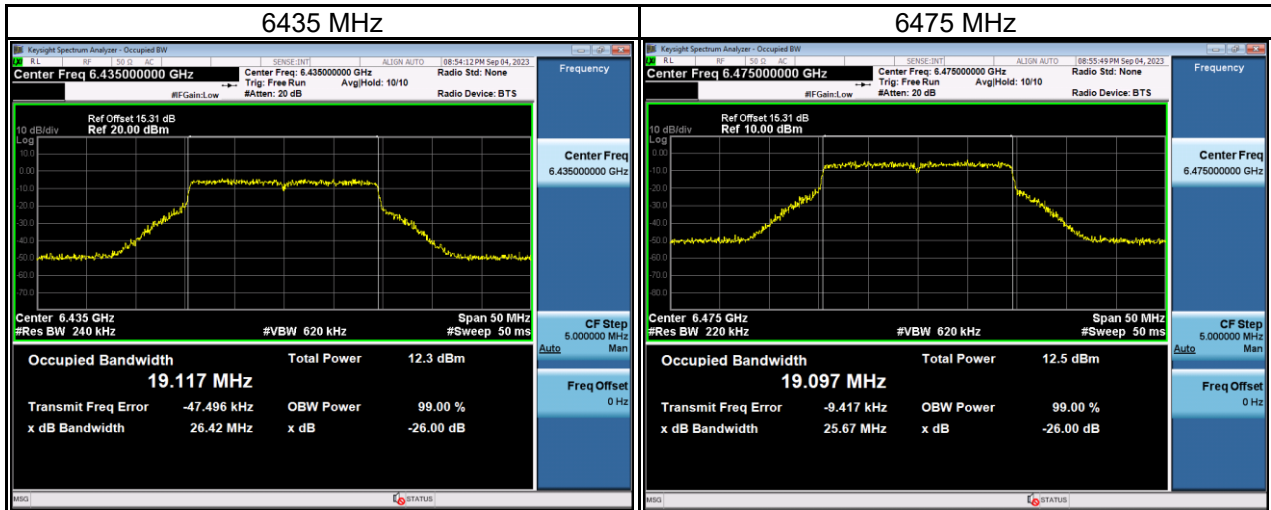

Test Frequency (MHz)	26 dB Bandwidth (MHz)	99 % Occupied Bandwidth (MHz)	Limit (MHz)	Result
6535	25.64	19.15	320	Pass
6695	25.37	19.11	320	Pass
6855	25.93	19.13	320	Pass

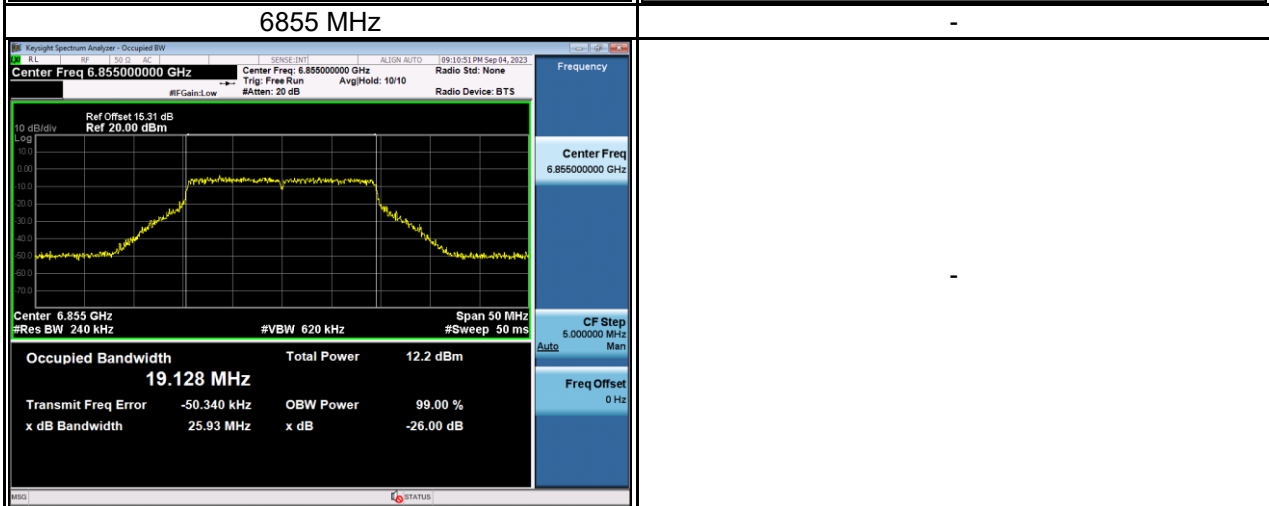
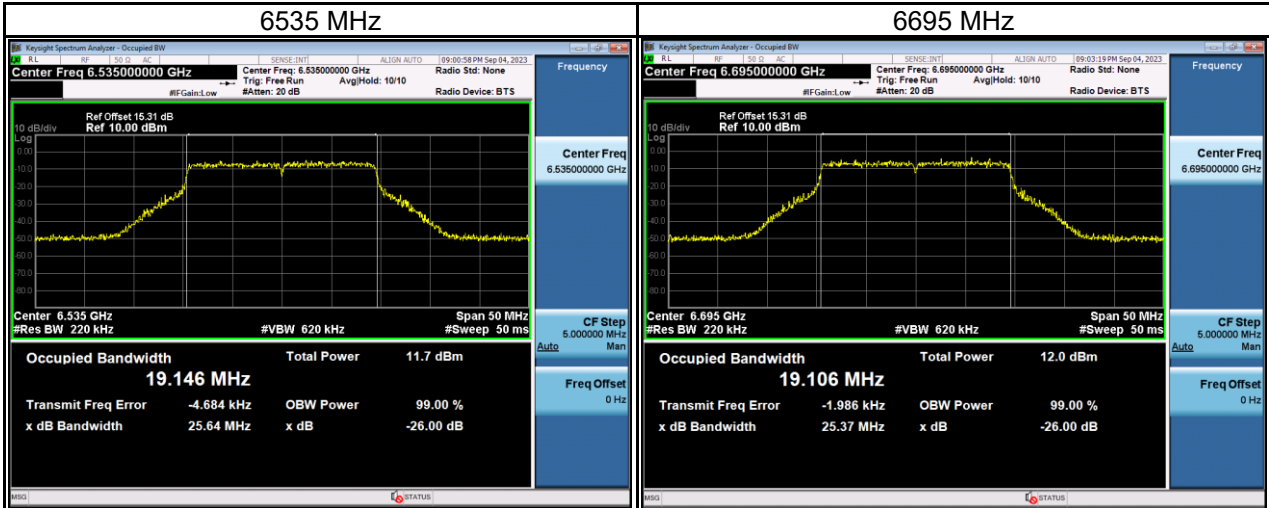

Test Frequency (MHz)	26 dB Bandwidth (MHz)	99 % Occupied Bandwidth (MHz)	Limit (MHz)	Result
6875	25.45	19.13	320	Pass
6995	27.27	19.13	320	Pass
7115	24.48	19.04	320	Pass

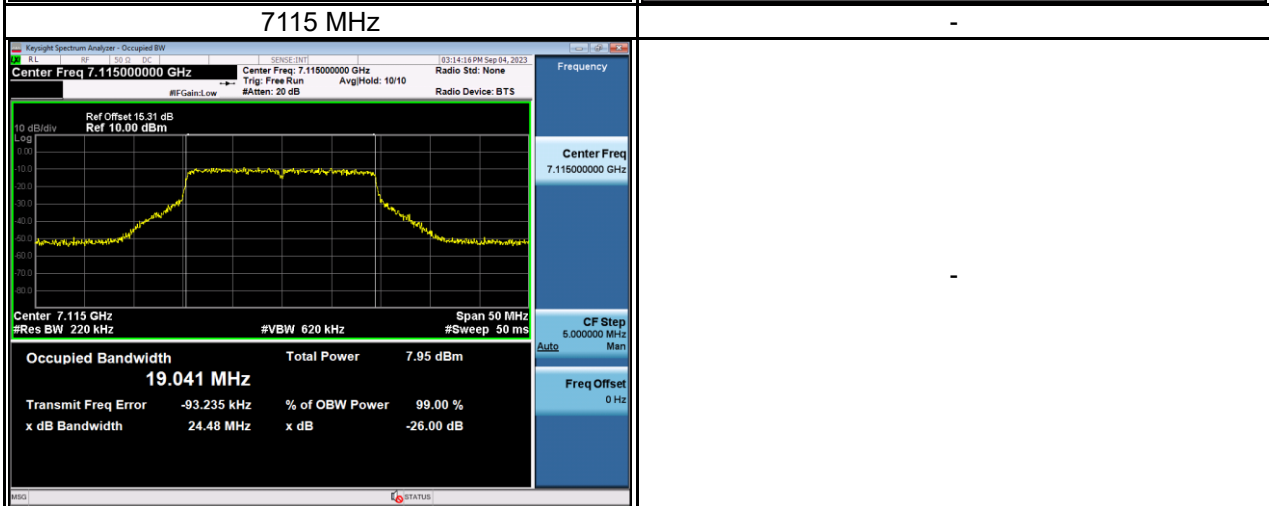
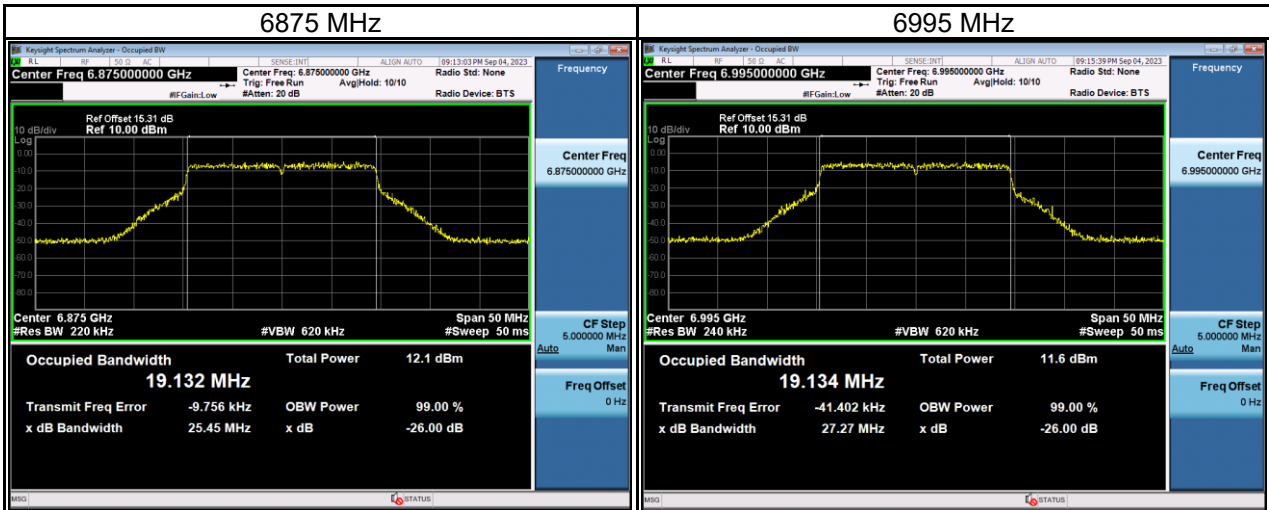

Test Mode | IEEE 802.11ax (HE40)\_ Main Antenna

Test Frequency (MHz)	26 dB Bandwidth (MHz)	99 % Occupied Bandwidth (MHz)	Limit (MHz)	Result
5965	46.74	38.00	320	Pass
6165	47.10	37.91	320	Pass
6405	47.13	37.94	320	Pass

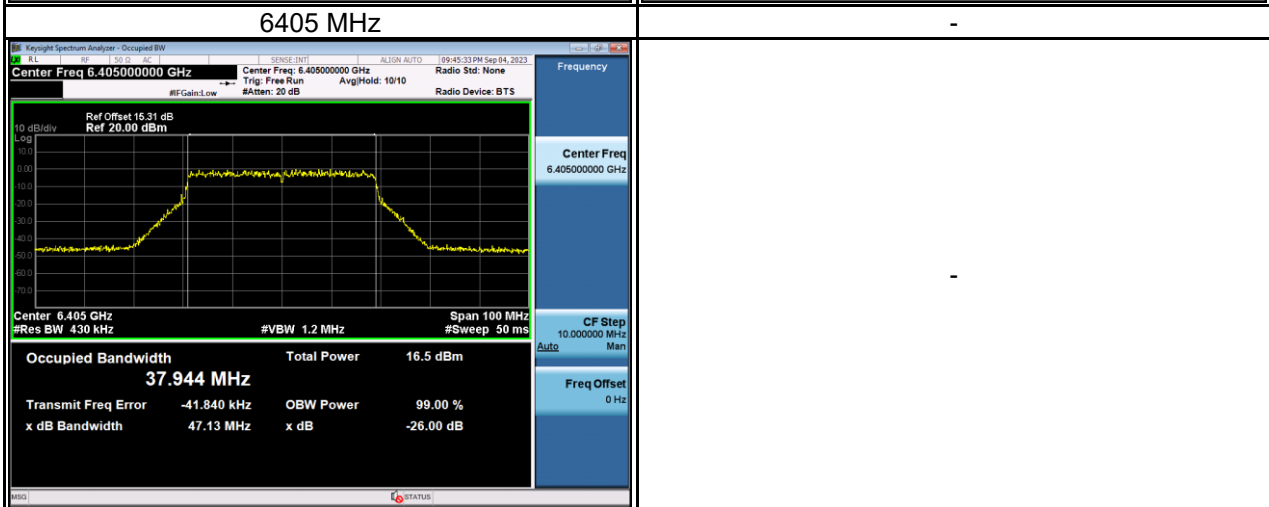
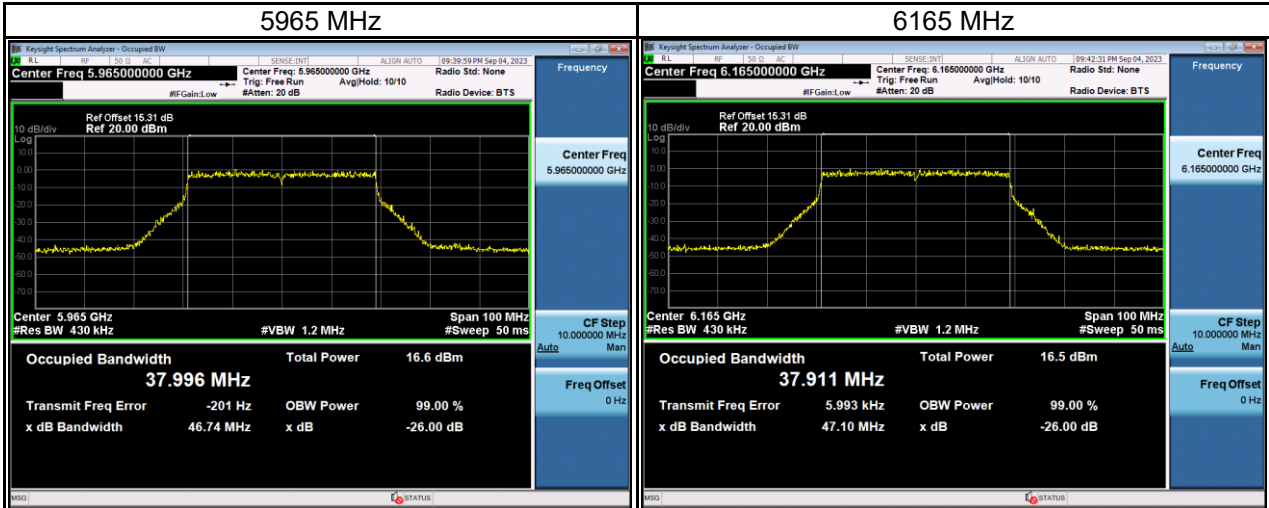

Test Frequency (MHz)	26 dB Bandwidth (MHz)	99 % Occupied Bandwidth (MHz)	Limit (MHz)	Result
6445	46.60	38.02	320	Pass
6485	47.03	37.89	320	Pass

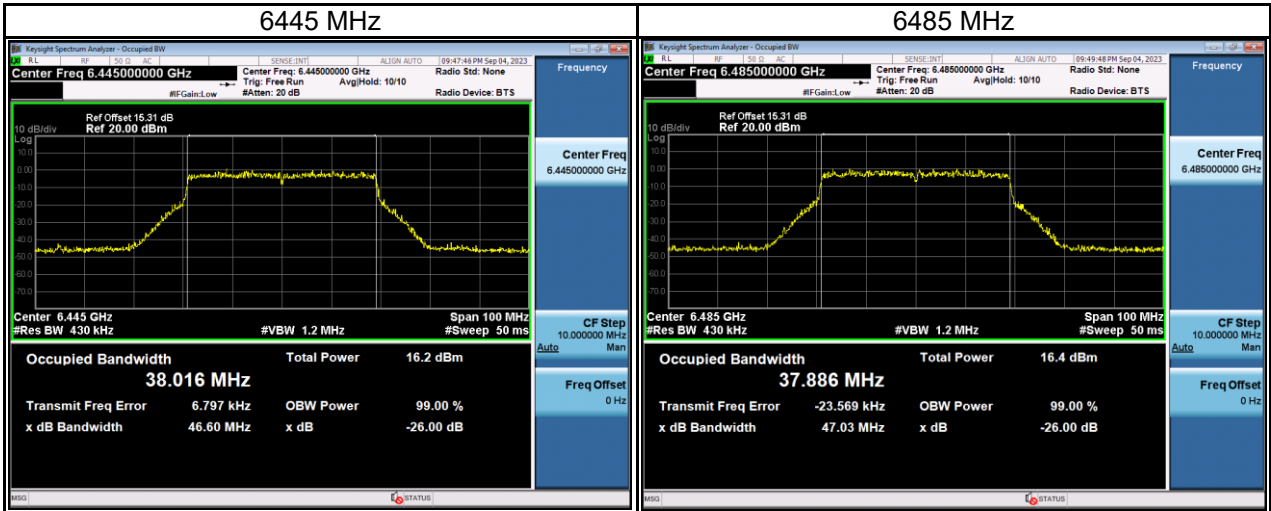

Test Frequency (MHz)	26 dB Bandwidth (MHz)	99 % Occupied Bandwidth (MHz)	Limit (MHz)	Result
6525	46.84	38.05	320	Pass
6565	46.75	37.90	320	Pass
6725	46.83	38.05	320	Pass
6845	45.96	37.92	320	Pass

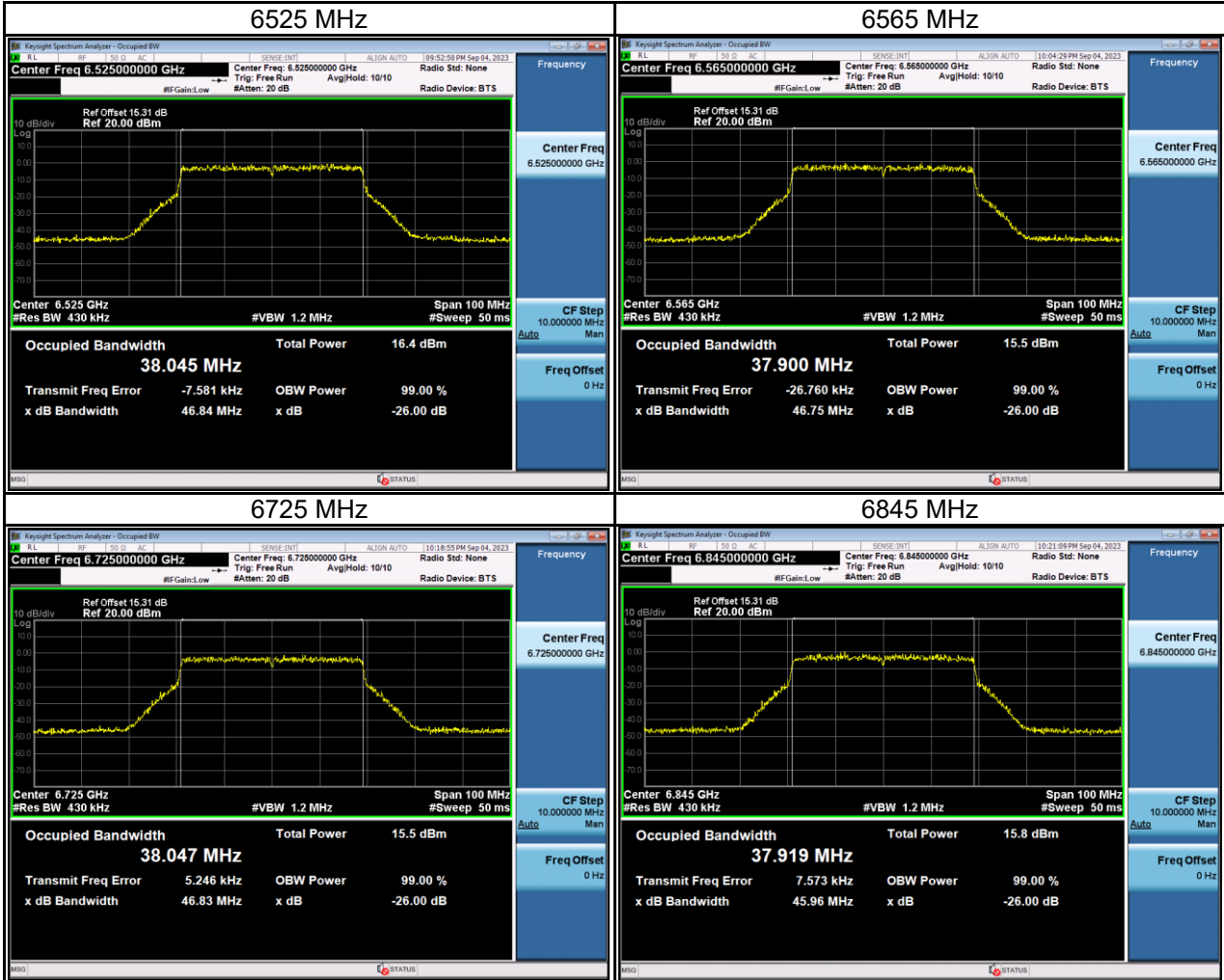



Test Frequency (MHz)	26 dB Bandwidth (MHz)	99 % Occupied Bandwidth (MHz)	Limit (MHz)	Result
6885	47.26	38.00	320	Pass
7005	44.59	37.83	320	Pass
7085	44.73	37.84	320	Pass

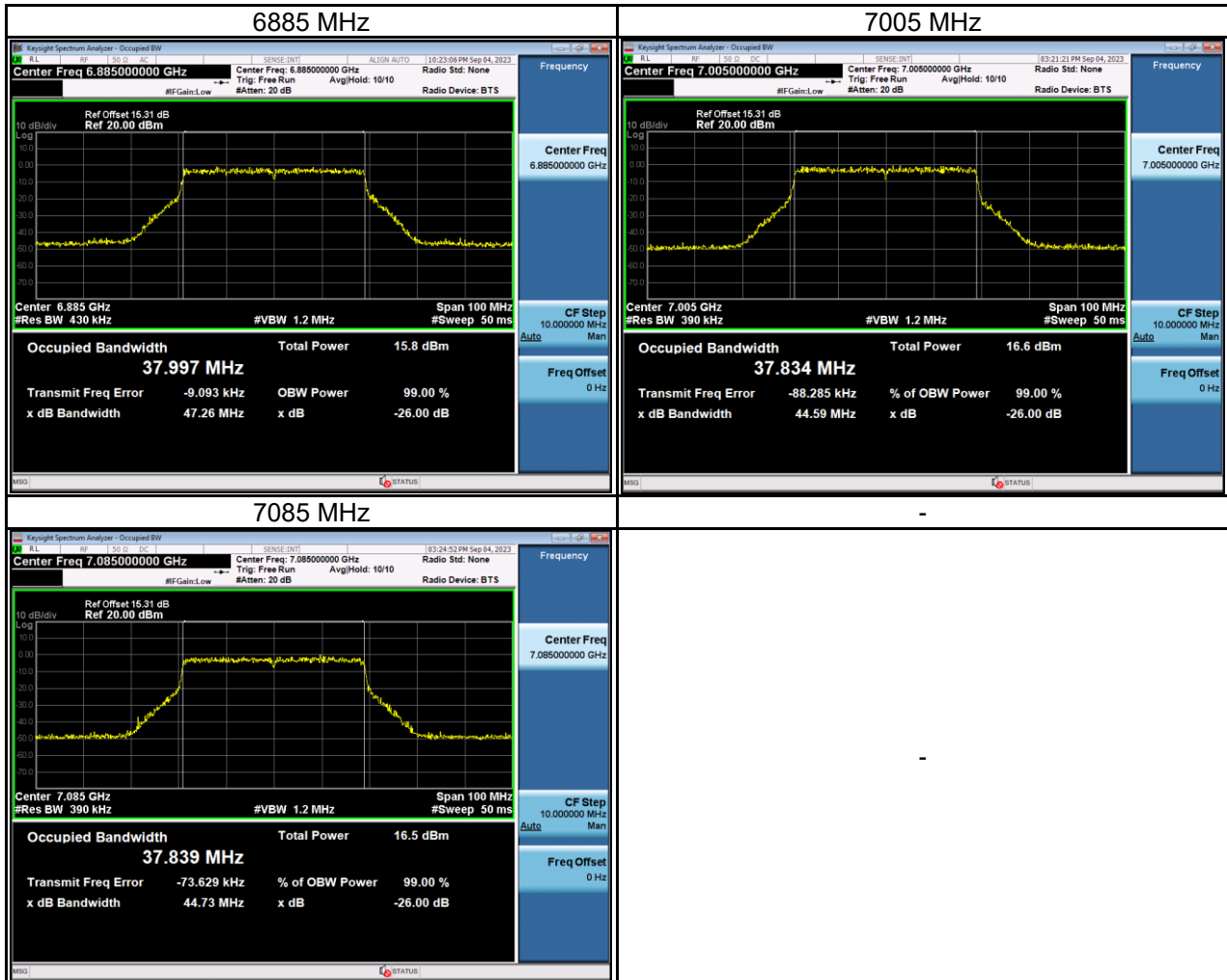

Test Mode | IEEE 802.11ax (HE80)\_ Main Antenna

Test Frequency (MHz)	26 dB Bandwidth (MHz)	99 % Occupied Bandwidth (MHz)	Limit (MHz)	Result
5985	85.79	76.91	320	Pass
6145	85.22	76.42	320	Pass
6385	87.93	76.82	320	Pass

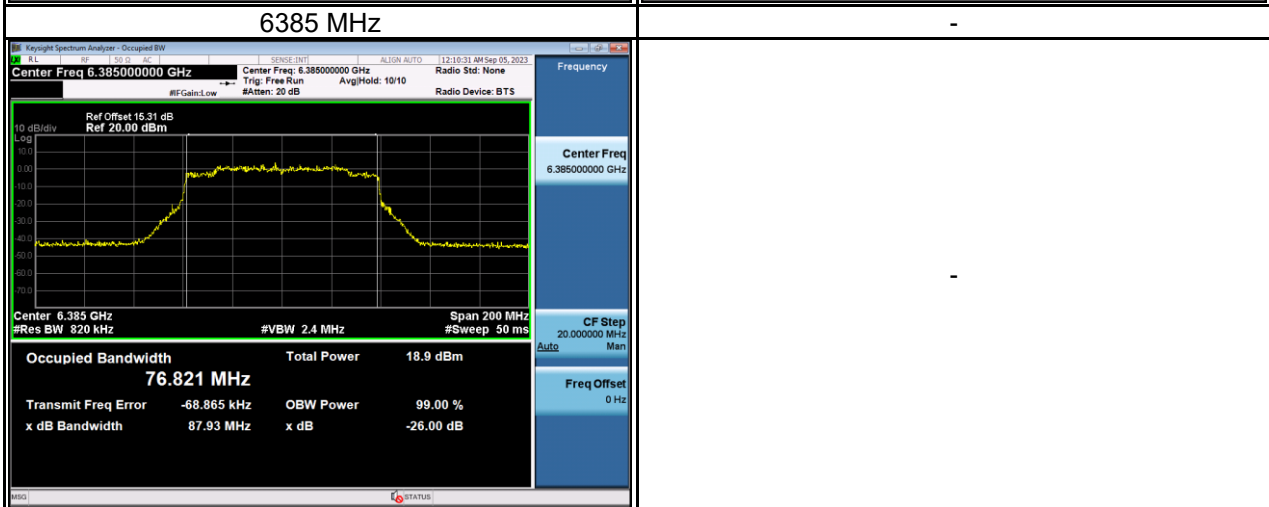
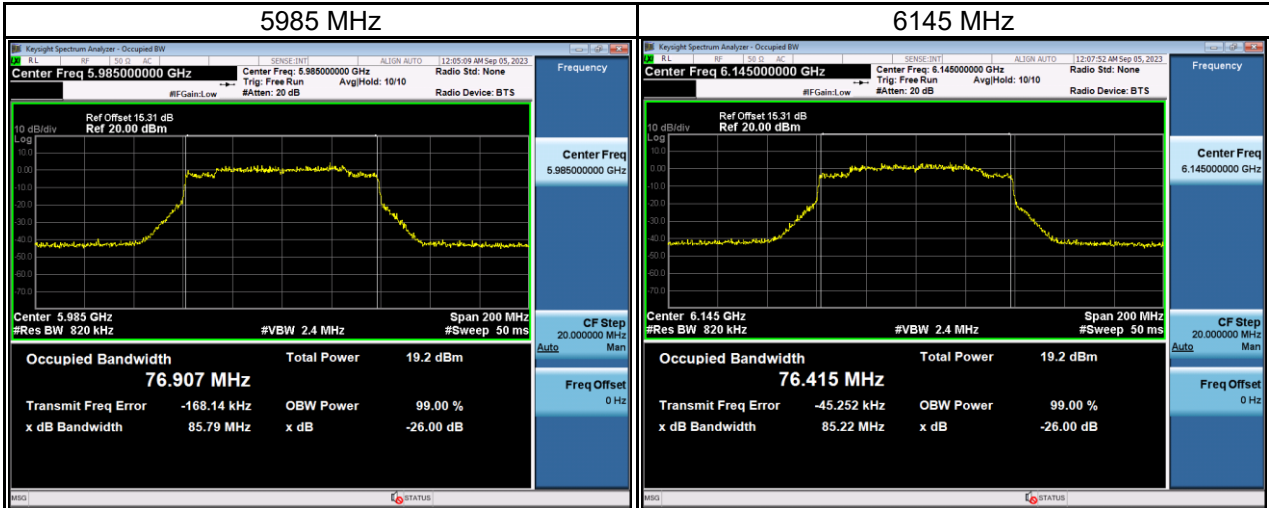

Test Frequency (MHz)	26 dB Bandwidth (MHz)	99 % Occupied Bandwidth (MHz)	Limit (MHz)	Result
6465	86.52	76.60	320	Pass

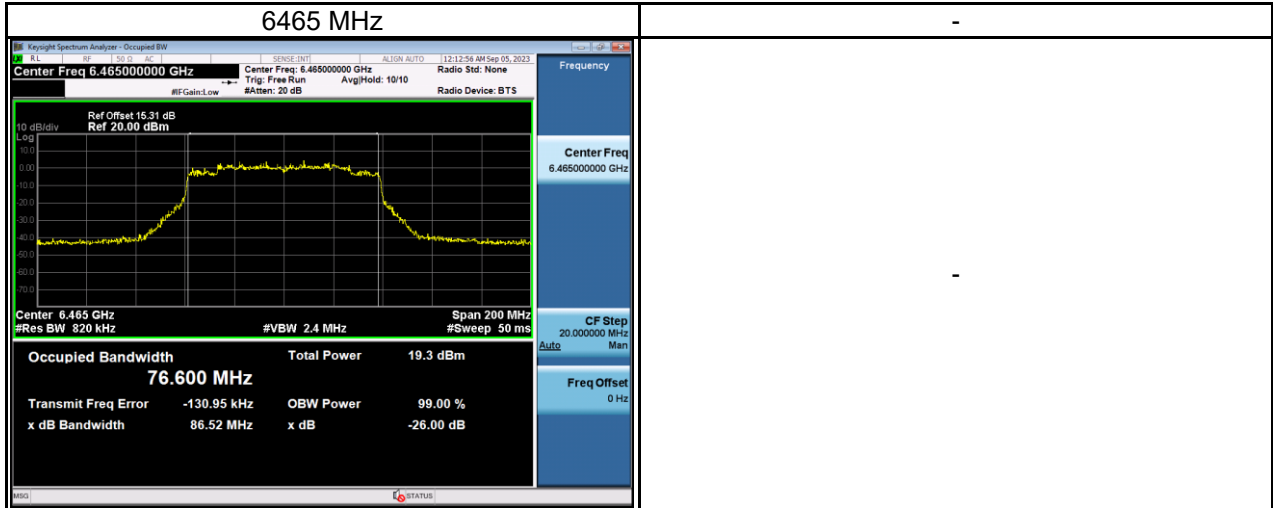

Test Frequency (MHz)	26 dB Bandwidth (MHz)	99 % Occupied Bandwidth (MHz)	Limit (MHz)	Result
6545	84.44	76.45	320	Pass
6705	84.50	76.43	320	Pass
6865	88.72	76.80	320	Pass

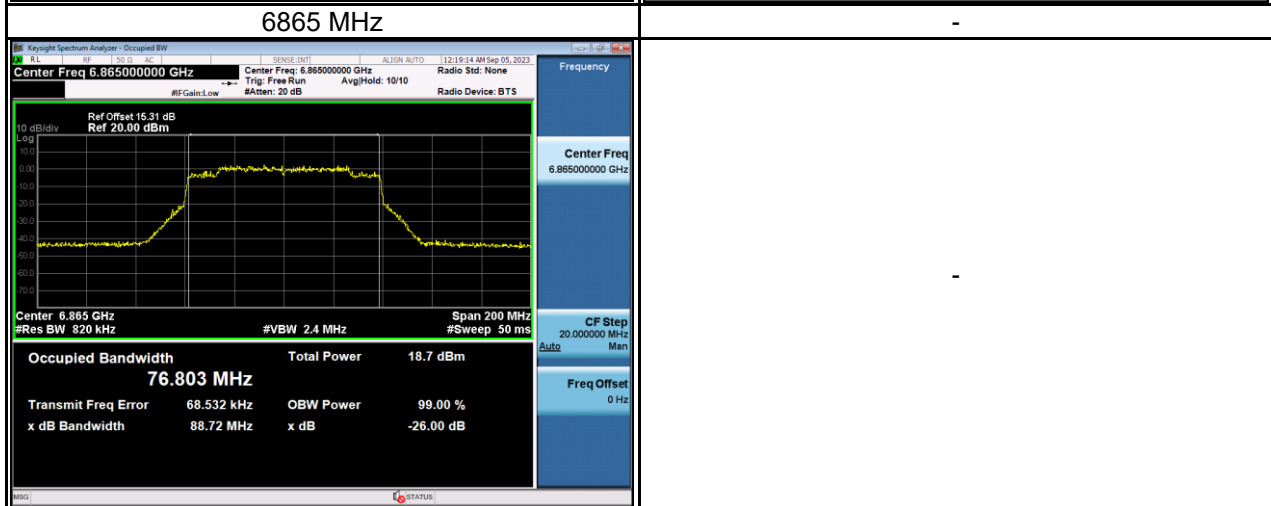
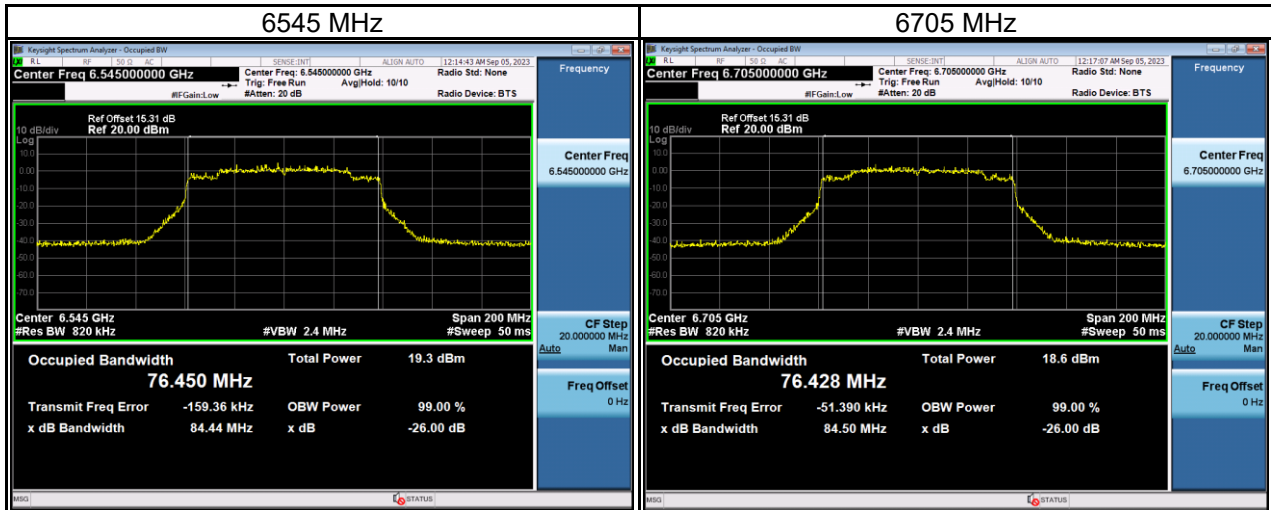

Test Frequency (MHz)	26 dB Bandwidth (MHz)	99 % Occupied Bandwidth (MHz)	Limit (MHz)	Result
6945	86.56	76.68	320	Pass
7025	87.19	76.49	320	Pass

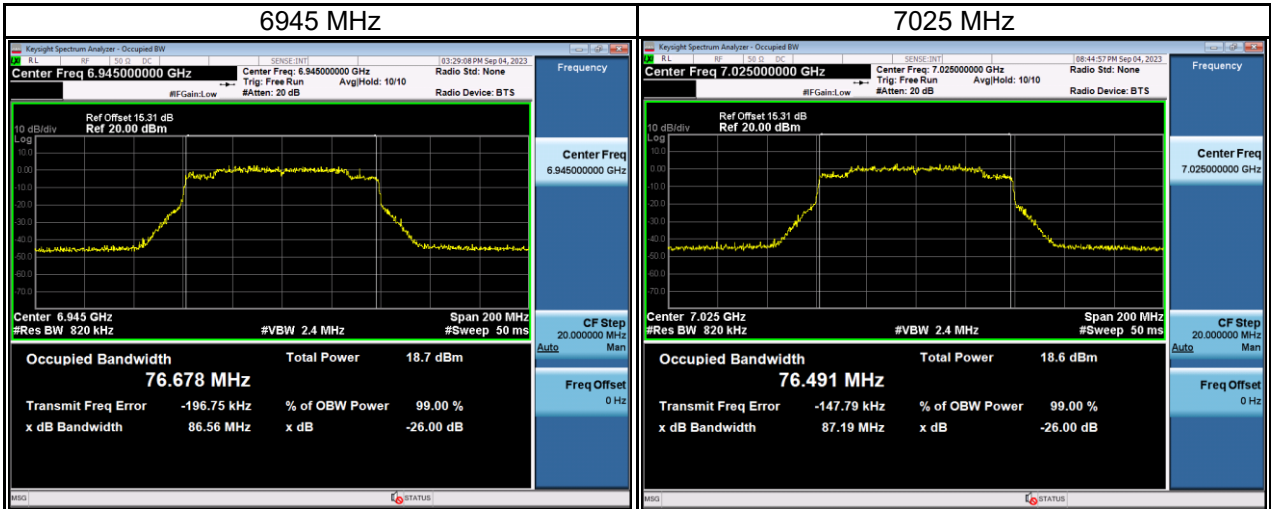

Test Mode | IEEE 802.11ax (HE160)\_ Main Antenna

Test Frequency (MHz)	26 dB Bandwidth (MHz)	99 % Occupied Bandwidth (MHz)	Limit (MHz)	Result
6025	162.90	154.81	320	Pass
6185	163.80	154.34	320	Pass
6345	163.20	154.93	320	Pass

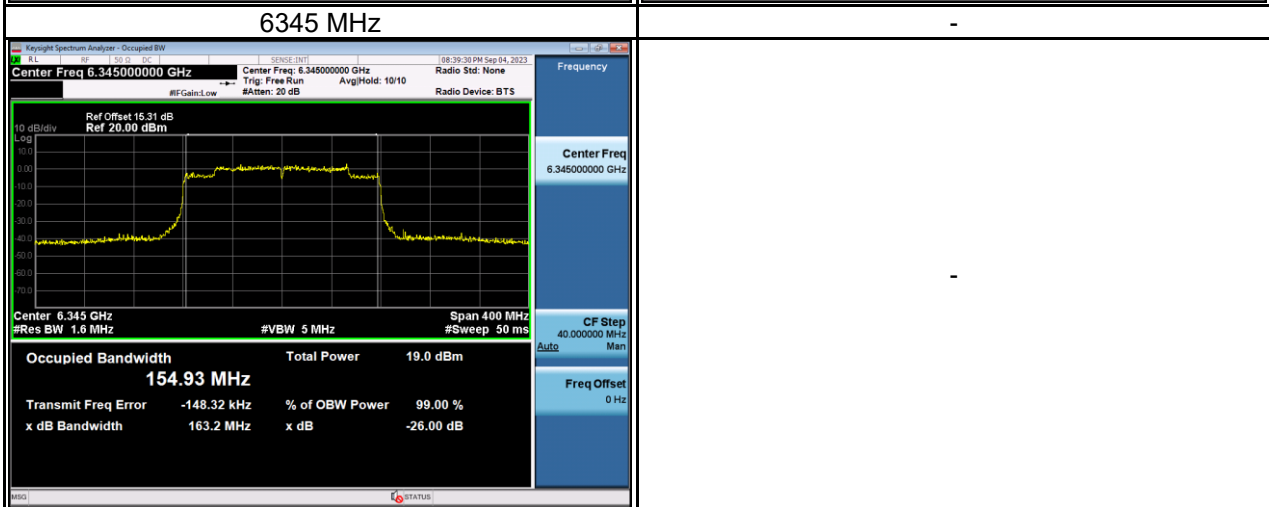
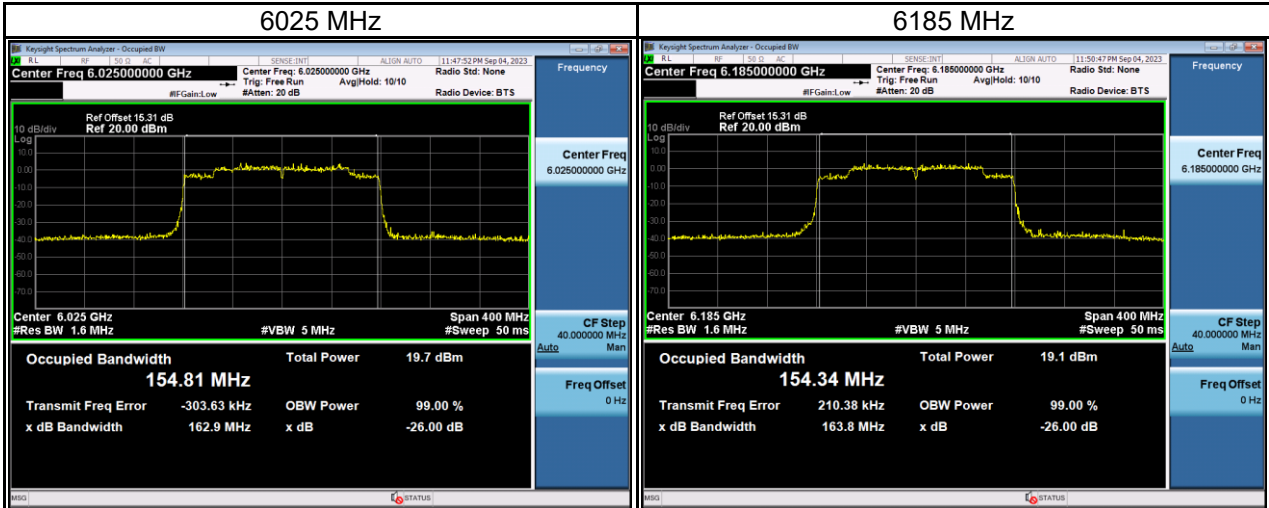

Test Frequency (MHz)	26 dB Bandwidth (MHz)	99 % Occupied Bandwidth (MHz)	Limit (MHz)	Result
6505	162.70	154.38	320	Pass

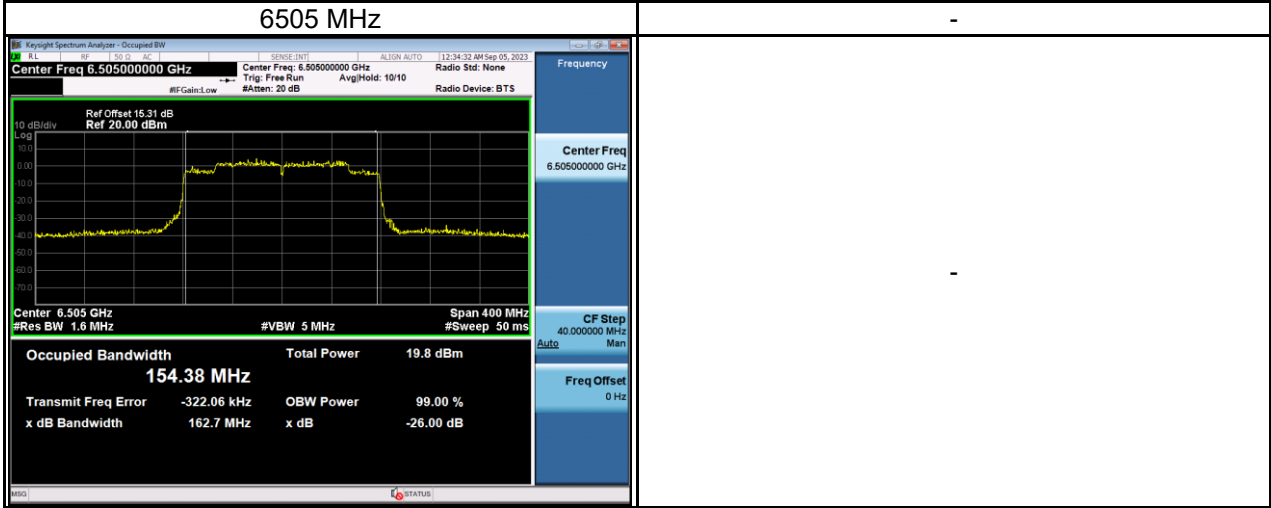

Test Frequency (MHz)	26 dB Bandwidth (MHz)	99 % Occupied Bandwidth (MHz)	Limit (MHz)	Result
6665	163.40	154.20	320	Pass
6825	163.10	154.67	320	Pass

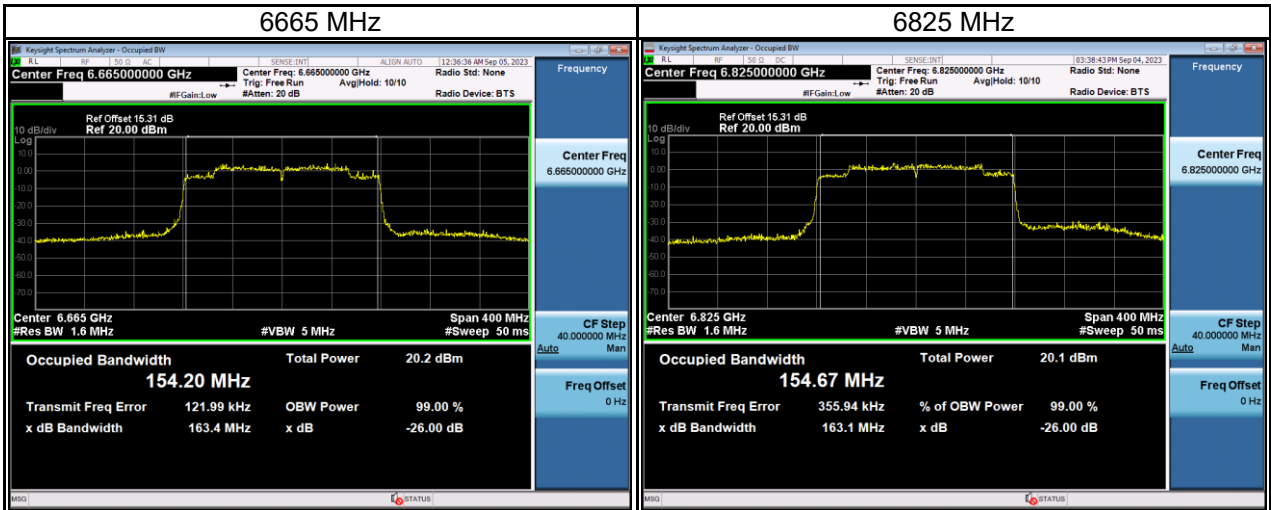

Test Frequency (MHz)	26 dB Bandwidth (MHz)	99 % Occupied Bandwidth (MHz)	Limit (MHz)	Result
6985	163.30	154.80	320	Pass

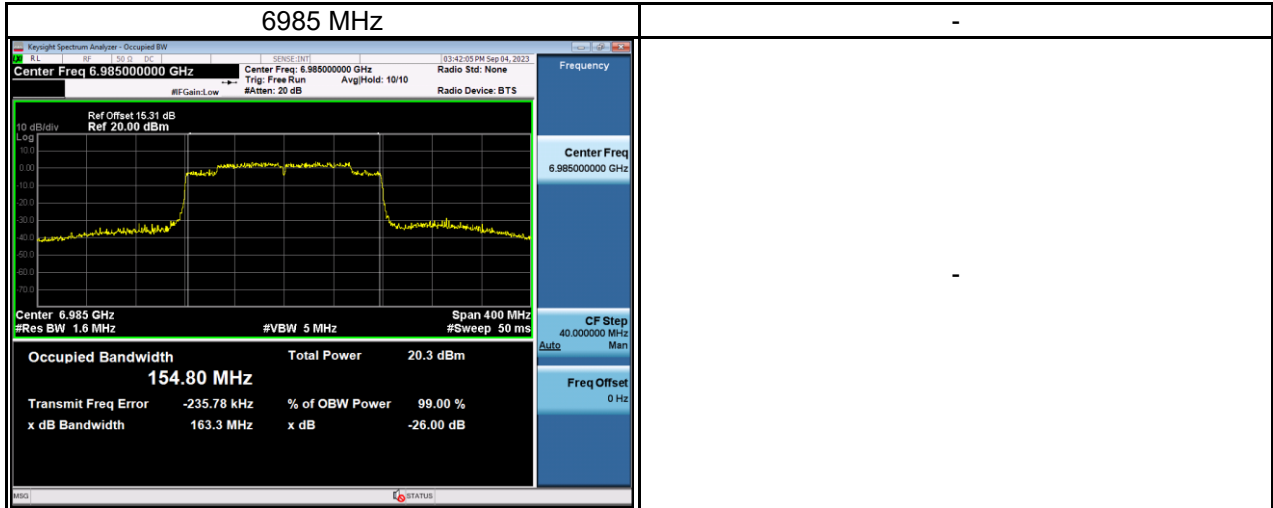



## APPENDIX C MAXIMUM POWER SPECTRAL DENSIT

Test Mode | IEEE 802.11ax (HE20)\_ Main Antenna

Test Frequency (MHz)	e.i.r.p. Spectral Density (dBm/MHz)	Duty Factor (dB)	Calculated e.i.r.p. Spectral Density (dBm/MHz)	Maximum Limit (dBm/MHz)	Result
5955	-6.72	0.03	-6.69	-1.00	Pass
6175	-6.51	0.03	-6.48	-1.00	Pass
6415	-6.30	0.03	-6.27	-1.00	Pass

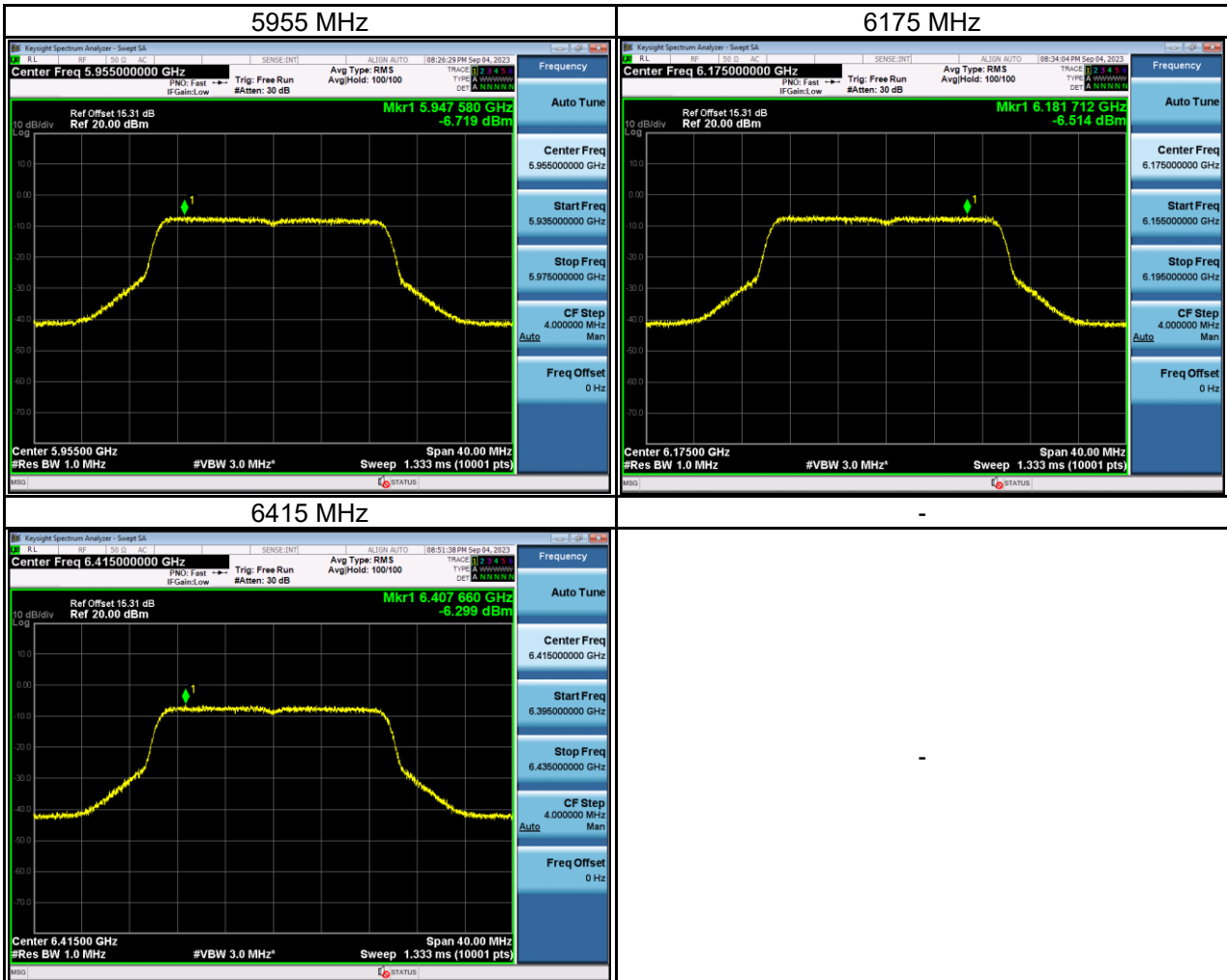

Test Frequency (MHz)	e.i.r.p. Spectral Density (dBm/MHz)	Duty Factor (dB)	Calculated e.i.r.p. Spectral Density (dBm/MHz)	Maximum Limit (dBm/MHz)	Result
6435	-6.48	0.03	-6.44	-1.00	Pass
6475	-6.14	0.03	-6.11	-1.00	Pass
6515	-6.53	0.03	-6.50	-1.00	Pass

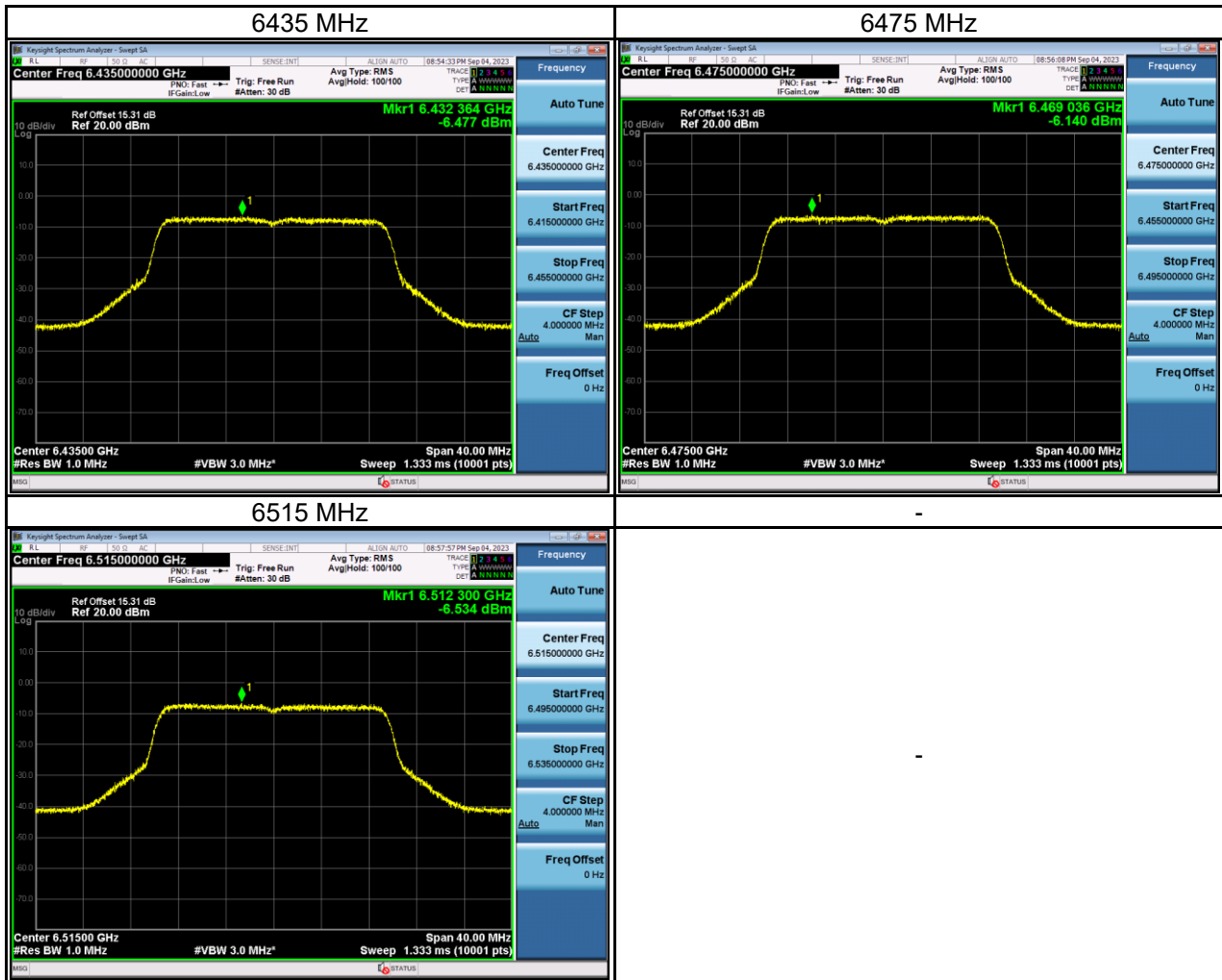

Test Frequency (MHz)	e.i.r.p. Spectral Density (dBm/MHz)	Duty Factor (dB)	Calculated e.i.r.p. Spectral Density (dBm/MHz)	Maximum Limit (dBm/MHz)	Result
6535	-6.81	0.03	-6.78	-1.00	Pass
6695	-6.65	0.03	-6.62	-1.00	Pass
6855	-6.56	0.03	-6.53	-1.00	Pass

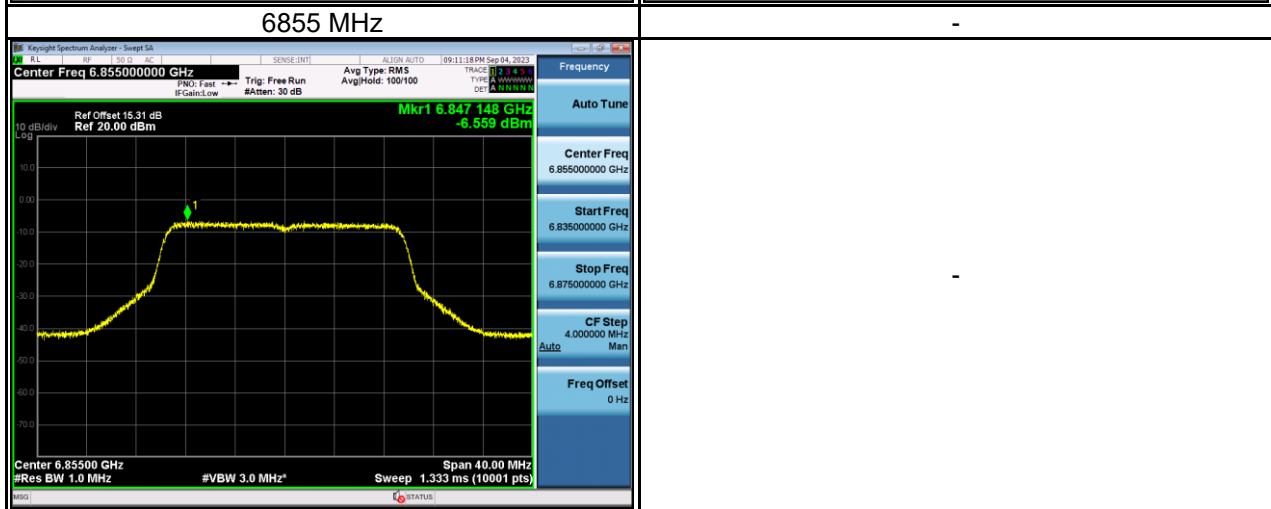
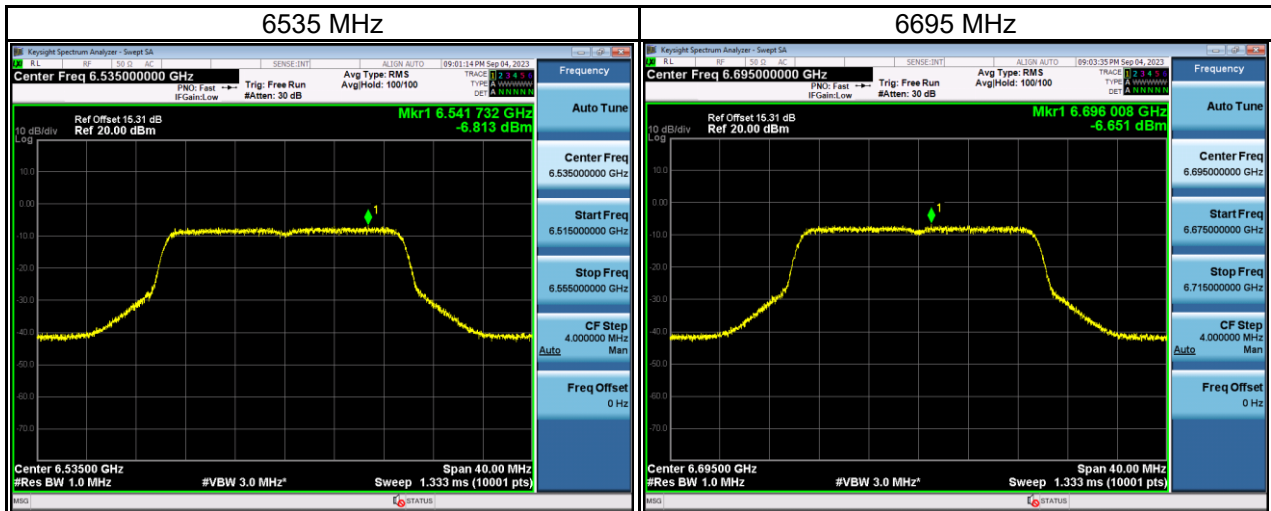

Test Frequency (MHz)	e.i.r.p. Spectral Density (dBm/MHz)	Duty Factor (dB)	Calculated e.i.r.p. Spectral Density (dBm/MHz)	Maximum Limit (dBm/MHz)	Result
6875	-6.57	0.03	-6.54	-1.00	Pass
6995	-7.12	0.03	-7.09	-1.00	Pass
7115	-10.80	0.03	-10.77	-1.00	Pass

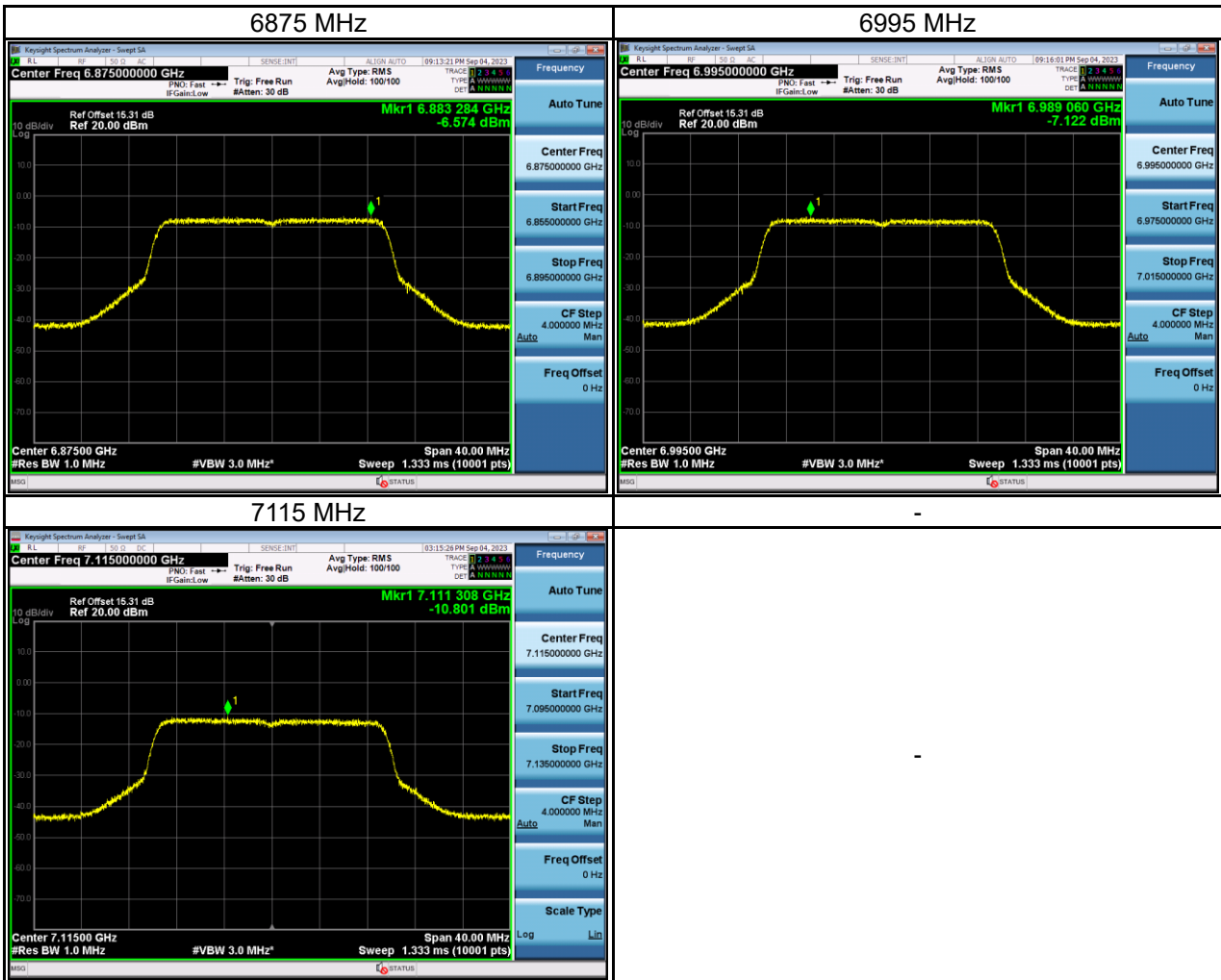

Test Mode | IEEE 802.11ax (HE20)\_ Aux Antenna

Test Frequency (MHz)	e.i.r.p. Spectral Density (dBm/MHz)	Duty Factor (dB)	Calculated e.i.r.p. Spectral Density (dBm/MHz)	Maximum Limit (dBm/MHz)	Result
5955	-6.91	0.03	-6.88	-1.00	Pass
6175	-6.88	0.03	-6.85	-1.00	Pass
6415	-6.19	0.03	-6.16	-1.00	Pass

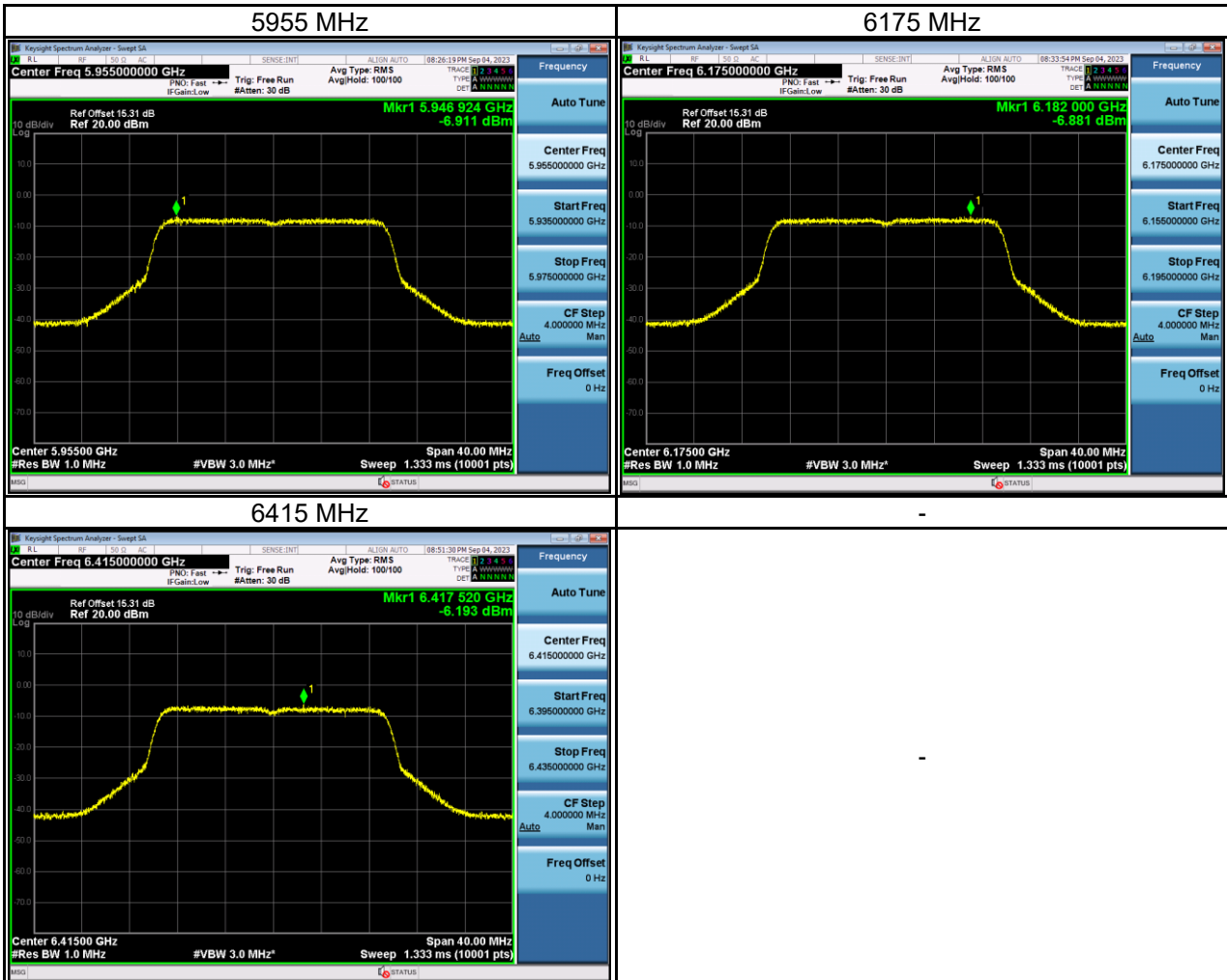

Test Frequency (MHz)	e.i.r.p. Spectral Density (dBm/MHz)	Duty Factor (dB)	Calculated e.i.r.p. Spectral Density (dBm/MHz)	Maximum Limit (dBm/MHz)	Result
6435	-6.20	0.03	-6.16	-1.00	Pass
6475	-6.39	0.03	-6.35	-1.00	Pass
6515	-7.01	0.03	-6.97	-1.00	Pass

