

FCC Radio Test Report

FCC ID: BEJNT-14T90S

Report No. : BTL-FCCP-1-2308T045
Equipment : Notebook Computer
Model Name : 14T90S, 14TD90S, 14TG90S, 14TB90S, 14TW90S, 14TN90S, 14T90S* (* can be 0 to 9 or A to Z or blank denoting buyer request)
Brand Name : LG
Applicant : LG Electronics USA, Inc.
Address : 111 Sylvan Avenue, North Building, Englewood Cliffs, New Jersey 07632, United States

Radio Function : Bluetooth EDR

FCC Rule Part(s) : FCC CFR Title 47, Part 15, Subpart C (15.247)
Measurement Procedure(s) : ANSI C63.10-2013

Date of Receipt : 2023/8/15
Date of Test : 2023/8/24 ~ 2023/9/13
Issued Date : 2023/9/27

The above equipment has been tested and found in compliance with the requirement of the above standards by BTL Inc.

Prepared by

Jerry Chuang, Supervisor

Approved by

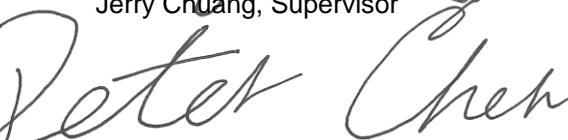
Peter Chen, Vice Manager



BTL Inc.

No.18, Ln. 171, Sec. 2, Jiuzong Rd., Neihu Dist., Taipei City 114, Taiwan

Tel: +886-2-2657-3299 Fax: +886-2-2657-3331 Web: www.newbtl.com Service mail: btl_qa@newbtl.com

Declaration

BTL represents to the client that testing is done in accordance with standard procedures as applicable and that test instruments used has been calibrated with standards traceable to international standard(s) and/or national standard(s).

BTL's reports apply only to the specific samples tested under conditions. It is manufacture's responsibility to ensure that additional production units of this model are manufactured with the identical electrical and mechanical components. **BTL** shall have no liability for any declarations, inferences or generalizations drawn by the client or others from **BTL** issued reports.

This report is the confidential property of the client. As a mutual protection to the clients, the public and ourselves, the test report shall not be reproduced, except in full, without our written approval.

BTL's laboratory quality assurance procedures are in compliance with the **ISO/IEC 17025** requirements, and accredited by the conformity assessment authorities listed in this test report.

BTL is not responsible for the sampling stage, so the results only apply to the sample as received.

The information, data and test plan are provided by manufacturer which may affect the validity of results, so it is manufacturer's responsibility to ensure that the apparatus meets the essential requirements of applied standards and in all the possible configurations as representative of its intended use.

Limitation

For the use of the authority's logo is limited unless the Test Standard(s)/Scope(s)/Item(s) mentioned in this test report is (are) included in the conformity assessment authorities acceptance respective.

Please note that the measurement uncertainty is provided for informational purpose only and are not use in determining the Pass/Fail results.

CONTENTS

REVISION HISTORY	5
1 SUMMARY OF TEST RESULTS	6
1.1 TEST FACILITY	7
1.2 MEASUREMENT UNCERTAINTY	7
1.3 TEST ENVIRONMENT CONDITIONS	8
1.4 DUTY CYCLE	9
2 GENERAL INFORMATION	10
2.1 DESCRIPTION OF EUT	10
2.2 TEST MODES	12
2.3 BLOCK DIAGRAM SHOWING THE CONFIGURATION OF SYSTEM TESTED	13
2.4 SUPPORT UNITS	14
3 AC POWER LINE CONDUCTED EMISSIONS TEST	15
3.1 LIMIT	15
3.2 TEST PROCEDURE	15
3.3 DEVIATION FROM TEST STANDARD	15
3.4 TEST SETUP	16
3.5 TEST RESULT	16
4 RADIATED EMISSIONS TEST	17
4.1 LIMIT	17
4.2 TEST PROCEDURE	18
4.3 DEVIATION FROM TEST STANDARD	18
4.4 TEST SETUP	18
4.5 EUT OPERATING CONDITIONS	19
4.6 TEST RESULT – BELOW 30 MHZ	20
4.7 TEST RESULT – 30 MHZ TO 1 GHZ	20
4.8 TEST RESULT – ABOVE 1 GHZ	20
5 NUMBER OF HOPPING CHANNEL	21
5.1 APPLIED PROCEDURES	21
5.2 TEST PROCEDURE	21
5.3 DEVIATION FROM STANDARD	21
5.4 TEST SETUP	21
5.5 EUT OPERATION CONDITIONS	21
5.6 TEST RESULTS	21
6 AVERAGE TIME OF OCCUPANCY	22
6.1 APPLIED PROCEDURES / LIMIT	22
6.2 TEST PROCEDURE	22
6.3 DEVIATION FROM STANDARD	22
6.4 TEST SETUP	22
6.5 EUT OPERATION CONDITIONS	22
6.6 TEST RESULTS	22
7 HOPPING CHANNEL SEPARATION MEASUREMENT	23
7.1 APPLIED PROCEDURES / LIMIT	23
7.2 TEST PROCEDURE	23
7.3 DEVIATION FROM STANDARD	23
7.4 TEST SETUP	23
7.5 TEST RESULTS	23
8 BANDWIDTH TEST	24

8.1	APPLIED PROCEDURES	24
8.2	TEST PROCEDURE	24
8.3	DEVIATION FROM STANDARD	24
8.4	TEST SETUP	24
8.5	EUT OPERATION CONDITIONS	24
8.6	TEST RESULTS	24
9	OUTPUT POWER TEST	25
9.1	APPLIED PROCEDURES / LIMIT	25
9.2	TEST PROCEDURE	25
9.3	DEVIATION FROM STANDARD	25
9.4	TEST SETUP	25
9.5	EUT OPERATION CONDITIONS	25
9.6	TEST RESULTS	25
10	ANTENNA CONDUCTED SPURIOUS EMISSION	26
10.1	APPLIED PROCEDURES / LIMIT	26
10.2	TEST PROCEDURE	26
10.3	DEVIATION FROM STANDARD	26
10.4	TEST SETUP	26
10.5	EUT OPERATION CONDITIONS	26
10.6	TEST RESULTS	26
11	LIST OF MEASURING EQUIPMENTS	27
12	EUT TEST PHOTO	29
13	EUT PHOTOS	29
APPENDIX A	AC POWER LINE CONDUCTED EMISSIONS	30
APPENDIX B	RADIATED EMISSIONS - 30 MHZ TO 1 GHZ	35
APPENDIX C	RADIATED EMISSIONS - ABOVE 1 GHZ	38
APPENDIX D	NUMBER OF HOPPING CHANNEL	55
APPENDIX E	AVERAGE TIME OF OCCUPANCY	57
APPENDIX F	HOPPING CHANNEL SEPARATION MEASUREMENT	60
APPENDIX G	BANDWIDTH	63
APPENDIX H	OUTPUT POWER	66
APPENDIX I	ANTENNA CONDUCTED SPURIOUS EMISSION	68

REVISION HISTORY

Report No.	Version	Description	Issued Date	Note
BTL-FCCP-1-2308T045	R00	Original Report.	2023/9/27	Valid

1 SUMMARY OF TEST RESULTS

Test procedures according to the technical standards.

Standard(s) Section	Description	Test Result	Judgement	Remark
15.207	AC Power Line Conducted Emissions	APPENDIX A	Pass	-----
15.205 15.209 15.247(d)	Radiated Emissions	APPENDIX B APPENDIX C	Pass	-----
15.247 (a)(1)(iii)	Number of Hopping Frequency	APPENDIX D	Pass	-----
15.247 (a)(1)(iii)	Average Time of Occupancy	APPENDIX E	Pass	-----
15.247 (a)(1)	Hopping Channel Separation	APPENDIX F	Pass	-----
15.247 (a)(1)	Bandwidth	APPENDIX G	Pass	-----
15.247 (b)(1)	Output Power	APPENDIX H	Pass	-----
15.247(d)	Antenna conducted Spurious Emission	APPENDIX I	Pass	-----
15.203	Antenna Requirement	-----	Pass	-----

NOTE:

- (1) "N/A" denotes test is not applicable in this Test Report.
- (2) The report format version is TP.1.1.1.

1.1 TEST FACILITY

The test locations stated below are under the TAF Accreditation Number 0659.

The test location(s) used to collect the test data in this report are:

No. 68-1, Ln. 169, Sec. 2, Datong Rd., Xizhi Dist., New Taipei City 221, Taiwan
(FCC DN: TW0659)

C05 CB08 CB11 SR10 SR11

No. 72, Ln. 169, Sec. 2, Datong Rd., Xizhi Dist., New Taipei City 221, Taiwan
(FCC DN: TW0659)

C06 CB21 CB22

1.2 MEASUREMENT UNCERTAINTY

The reported uncertainty of measurement $y \pm U$, where expanded uncertainty U is based on a standard uncertainty multiplied by a coverage factor of $k = 2$, providing a level of confidence of approximately **95 %**. The measurement instrumentation uncertainty considerations contained in CISPR 16-4-2. The BTL measurement uncertainty is less than the CISPR 16-4-2 U_{cispr} requirement.

A. AC power line conducted emissions test:

Test Site	Method	Measurement Frequency Range	U (dB)
C05	CISPR	150 kHz ~ 30 MHz	3.44

B. Radiated emissions test :

Test Site	Measurement Frequency Range	U (dB)
CB21	0.03 GHz ~ 0.2 GHz	4.17
	0.2 GHz ~ 1 GHz	4.72
	1 GHz ~ 6 GHz	5.21
	6 GHz ~ 18 GHz	5.51
	18 GHz ~ 26 GHz	3.69
	26 GHz ~ 40 GHz	4.23

C. Conducted test :

Test Item	U (dB)
Occupied Bandwidth	0.5338
Output power	0.3659
Conducted Spurious emissions	0.5416
Conducted Band edges	0.5348
Dwell time	0.6606
Channel separation	0.6606
Channel numbers	0.6606

NOTE:

Unless specifically mentioned, the uncertainty of measurement has not been taken into account to declare the compliance or non-compliance to the specification.

1.3 TEST ENVIRONMENT CONDITIONS

Test Item	Environment Condition	Test Voltage	Tested by
AC Power Line Conducted Emissions	21 °C, 52 %	AC 120V	Cora Lin
Radiated emissions below 1 GHz	Refer to data	AC 120V	Mark Wang
Radiated emissions above 1 GHz	Refer to data	AC 120V	Mark Wang
Number of Hopping Frequency	27.3 °C, 41 %	AC 120V	Jerry Chuang
Average Time of Occupancy	27.3 °C, 41 %	AC 120V	Jerry Chuang
Hopping Channel Separation	27.3 °C, 41 %	AC 120V	Jerry Chuang
Bandwidth	27.3 °C, 41 %	AC 120V	Jerry Chuang
Output Power	27.3 °C, 41 %	AC 120V	Jerry Chuang
Antenna conducted Spurious Emission	27.3 °C, 41 %	AC 120V	Jerry Chuang

1.4 DUTY CYCLE

If duty cycle is $\geq 98\%$, duty factor is not required.
 If duty cycle is $< 98\%$, duty factor shall be considered.

Remark	Delta 1			Delta 2		On Time/Period	10 log(1/Duty Cycle)
Mode	ON (ms)	Numbers (ON)	On Time (B) (ms)	Period (ON+OFF) (ms)	Duty Cycle (%)	Duty Factor (dB)	
BT (1 Mbps)	2.900	1	2.900	5.720	50.70%	2.95	
BT (2 Mbps)	2.900	1	2.900	3.780	76.72%	1.15	
BT (3 Mbps)	2.900	1	2.900	6.680	43.41%	3.62	

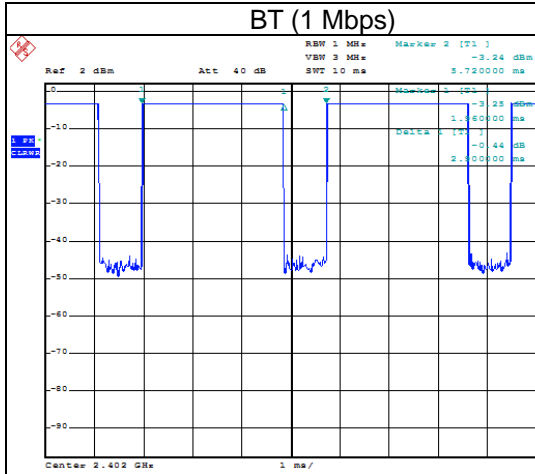

Date: 24.AUG.2023 19:01:55

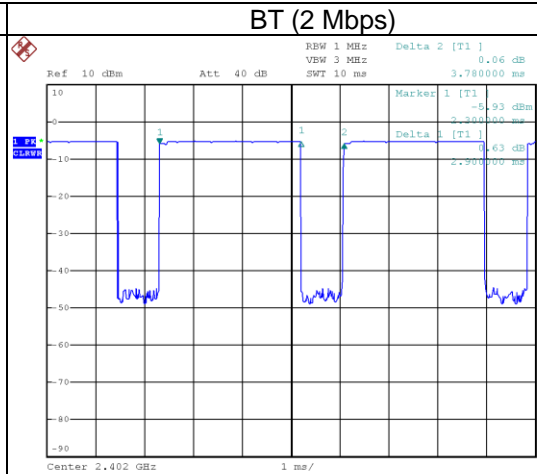

Date: 21.SEP.2023 13:02:15

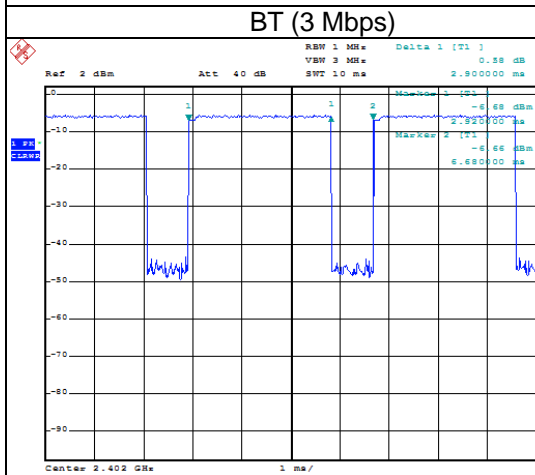

Date: 24.AUG.2023 19:09:34

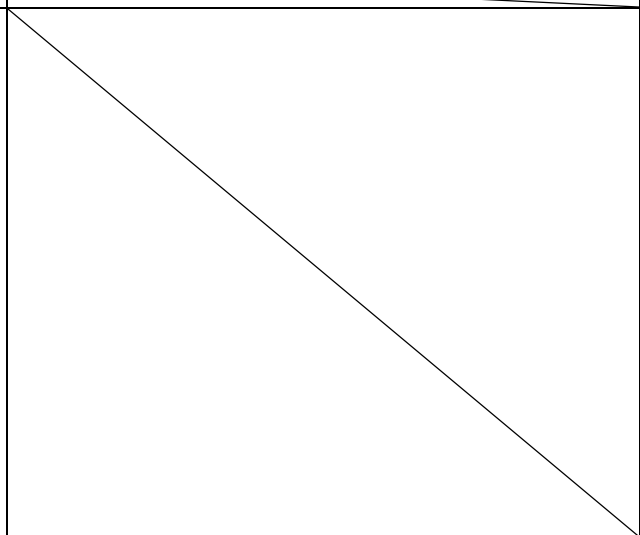

2 GENERAL INFORMATION

2.1 DESCRIPTION OF EUT

Equipment	Notebook Computer
Model Name	14T90S, 14TD90S, 14TG90S, 14TB90S, 14TW90S, 14TN90S, 14T90S* (* can be 0 to 9 or A to Z or blank denoting buyer request)
Brand Name	LG
Model Difference	Different model distribute to different area.
Power Source	DC voltage supplied from AC/DC Adapter.
Power Rating	20V --- 3.25A
Power Adapter Power Rating	Input: 100-240V~ 1.6A, 50-60Hz Output:5.0Vdc 3.0A 15.0W or 9.0Vdc 3.0A 27.0W or 15.0Vdc 3.0A 45.0W or 20.0Vdc 3.25A 65.0W (PPS)5.0V-20.0Vdc 3.25A Max 65.0W
Power Adapter	LG / LP65WFC20P-NJ
Operation Band	2400 MHz ~ 2483.5 MHz
Operation Frequency	2402 MHz ~ 2480 MHz
Modulation Type	GFSK, $\pi/4$ -DQPSK, 8DPSK
Modulation Technology	FHSS
Transfer Rate	1 Mbps, 2 Mbps, 3Mbps
Output Power Max.	1 Mbps: 9.63 dBm (0.0092 W) 2 Mbps: 7.64 dBm (0.0058 W) 3 Mbps: 7.76 dBm (0.0060 W)
Test Software Version	DRTU Version: 22.21090.0.0-OEM.DRTU.13120
Test Model	14T90S
Sample Status	Engineering Sample
EUT Modification(s)	N/A

NOTE:

- (1) The above EUT information is declared by manufacturer and for more detailed features description, please refers to the manufacturer's specifications or user's manual.

(2) Channel List:

Channel	Frequency (MHz)	Channel	Frequency (MHz)	Channel	Frequency (MHz)
00	2402	27	2429	54	2456
01	2403	28	2430	55	2457
02	2404	29	2431	56	2458
03	2405	30	2432	57	2459
04	2406	31	2433	58	2460
05	2407	32	2434	59	2461
06	2408	33	2435	60	2462
07	2409	34	2436	61	2463
08	2410	35	2437	62	2464
09	2411	36	2438	63	2465
10	2412	37	2439	64	2466
11	2413	38	2440	65	2467
12	2414	39	2441	66	2468
13	2415	40	2442	67	2469
14	2416	41	2443	68	2470
15	2417	42	2444	69	2471
16	2418	43	2445	70	2472
17	2419	44	2446	71	2473
18	2420	45	2447	72	2474
19	2421	46	2448	73	2475
20	2422	47	2449	74	2476
21	2423	48	2450	75	2477
22	2424	49	2451	76	2478
23	2425	50	2452	77	2479
24	2426	51	2453	78	2480
25	2427	52	2454		
26	2428	53	2455		

(3) Table for Filed Antenna:

NB:

Ant.	Brand	Part number	Type	Frequency Range (MHz)	Gain (dBi)
Aux	Pulse	DQ602118000	PIFA	2400-2483.5	2.96

Ant.	Brand	Part number	Type	Frequency Range (MHz)	Gain (dBi)
Aux	CHILISIN	DQ600111501	PIFA	2400-2483.5	1.39

TB:

Ant.	Brand	Part number	Type	Frequency Range (MHz)	Gain (dBi)
Aux	Pulse	DQ602118000	PIFA	2400-2483.5	1.91

Ant.	Brand	Part number	Type	Frequency Range (MHz)	Gain (dBi)
Aux	CHILISIN	DQ600111501	PIFA	2400-2483.5	1.48

- (4) The above Antenna information are derived from the antenna data sheet provided by manufacturer and for more detailed features description, please refer to the manufacturer's specifications, the laboratory shall not be held responsible.

2.2 TEST MODES

Test Items	Test mode	Channel	Note
AC power line conducted emissions	Normal/Idle	-	-
Transmitter Radiated Emissions (below 1GHz)	1 Mbps	39	-
Transmitter Radiated Emissions (above 1GHz)	1/3 Mbps	00/78	Bandedge
	1/3 Mbps	00/39/78	Harmonic
Number of Hopping Frequency	1/3 Mbps	00~78	-
Average Time of Occupancy	1/3 Mbps	00/39/78	-
Hopping Channel Separation	1/3 Mbps	00/39/78	-
Bandwidth	1/3 Mbps	00/39/78	-
Peak Output Power	1/2/3 Mbps	00/39/78	-
Antenna conducted Spurious Emission	1/3 Mbps	00/39/78	-

NOTE:

- (1) For radiated emission band edge test, both Vertical and Horizontal are evaluated, but only the worst case (Horizontal) is recorded.
- (2) All X, Y and Z axes are evaluated, but only the worst case (X axis) is recorded.

2.3 BLOCK DIAGRAM SHOWING THE CONFIGURATION OF SYSTEM TESTED

Equipment letters and Cable numbers refer to item numbers described in the tables of clause 2.4.

AC power line conducted emissions

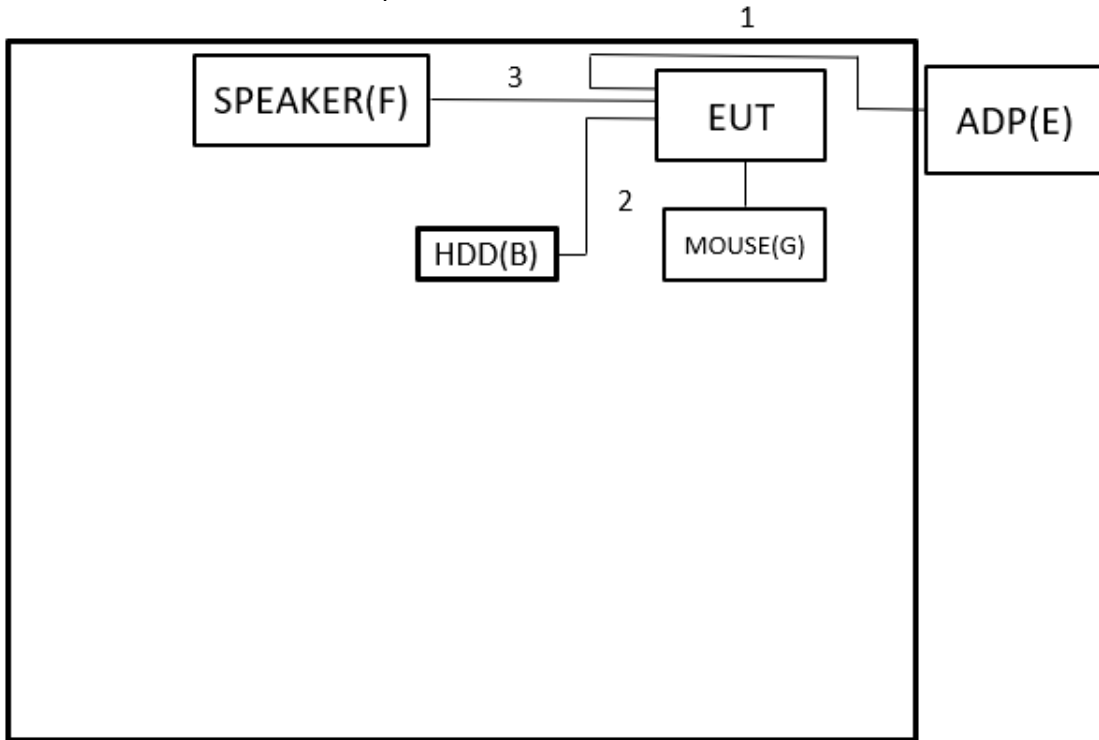

Radiated Emissions

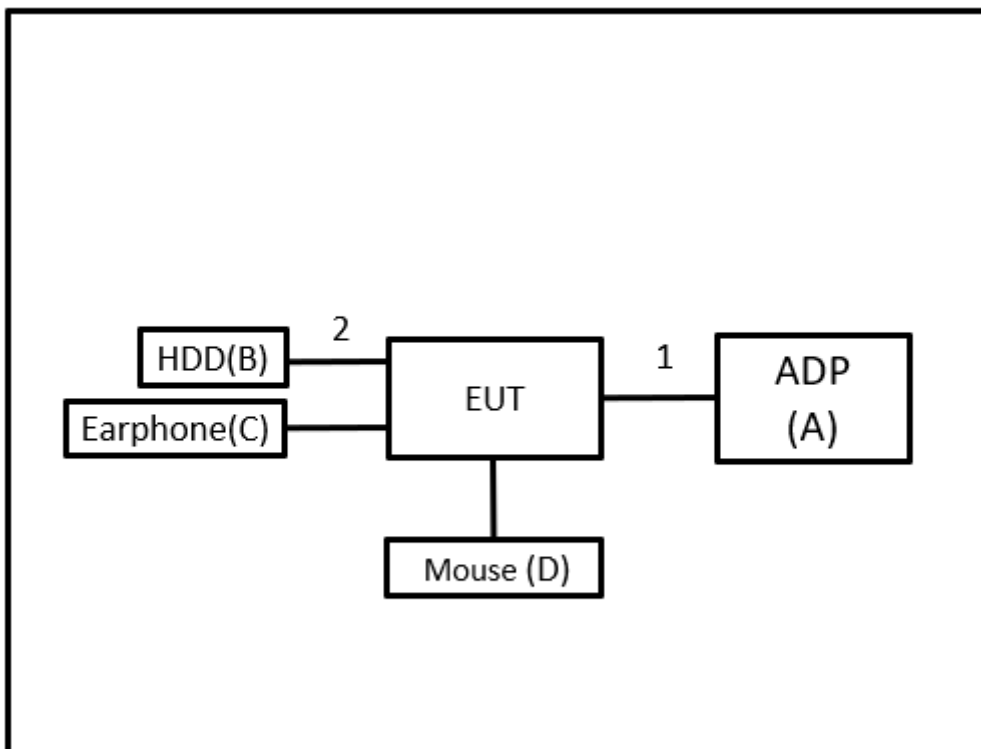

2.4 SUPPORT UNITS

Item	Equipment	Brand	Model No.	Series No.	Remarks
A	ADP	LG	LP65WFC209-NJ	N/A	Supplied by test requester
B	HDD	WD	WDBC3C0010BSL-0B	WXQ1A98NRHUU	Furnished by test lab.
C	Ear Phone	HTC	N/A	N/A	Furnished by test lab.
D	Mouse	Lenovo	SM-8823	N/A	Furnished by test lab.
E	ADP	LG	LP65WFC209-NJ	N/A	Supplied by test requester
F	SPEAKER	N/A	BV300S	N/A	Furnished by test lab.
G	Mouse	N/A	N/A	N/A	Furnished by test lab.

Item	Shielded	Ferrite Core	Length	Cable Type	Remarks
1	No	No	2m	USB-C to USB-C cable	Supplied by test requester
2	No	No	0.5m	USB-C to USB-C cable	Furnished by test lab.
3	No	No	1.5m	audio cable	Furnished by test lab.

3 AC POWER LINE CONDUCTED EMISSIONS TEST

3.1 LIMIT

Frequency (MHz)	Limit (dB μ V)	
	Quasi-peak	Average
0.15 - 0.5	66 - 56 *	56 - 46 *
0.50 - 5.0	56	46
5.0 - 30.0	60	50

NOTE:

- (1) The tighter limit applies at the band edges.
- (2) The limit of " * " marked band means the limitation decreases linearly with the logarithm of the frequency in the range.
- (3) The test result calculated as following:
 Measurement Value = Reading Level + Correct Factor
 Correct Factor = Insertion Loss + Cable Loss + Attenuator Factor (if use)
 Margin Level = Measurement Value – Limit Value
 Calculation example:

Reading Level		Correct Factor		Measurement Value
38.22	+	3.45	=	41.67

Measurement Value		Limit Value		Margin Level
41.67	-	60	=	-18.33

The following table is the setting of the receiver.

Receiver Parameter	Setting
Attenuation	10 dB
Start Frequency	0.15 MHz
Stop Frequency	30 MHz
IF Bandwidth	9 KHz

3.2 TEST PROCEDURE

- a. The EUT was placed 0.8 m above the horizontal ground plane with the EUT being connected to the power mains through a line impedance stabilization network (LISN).
 All other support equipment were powered from an additional LISN(s).
 The LISN provides 50 Ohm/50uH of impedance for the measuring instrument.
- b. Interconnecting cables that hang closer than 40 cm to the ground plane shall be folded back and forth in the center forming a bundle to keep the cable above 40 cm.
- c. Excess I/O cables that are not connected to a peripheral shall be bundled in the center.
 The end of the cable will be terminated, using the correct terminating impedance.
 The overall length shall not exceed 1 m.
- d. The LISN is spaced at least 80 cm from the nearest part of the EUT chassis.
- e. For the actual test configuration, please refer to the related Item - EUT TEST PHOTO.

NOTE:

- (1) In the results, each reading is marked as Peak, QP or AVG per the detector used.
 BW=9 kHz (6 dB Bandwidth)
- (2) All readings are Peak unless otherwise stated QP or AVG in column of Note. Both the QP and the AVG readings must be less than the limit for compliance.

3.3 DEVIATION FROM TEST STANDARD

No deviation.

3.4 TEST SETUP

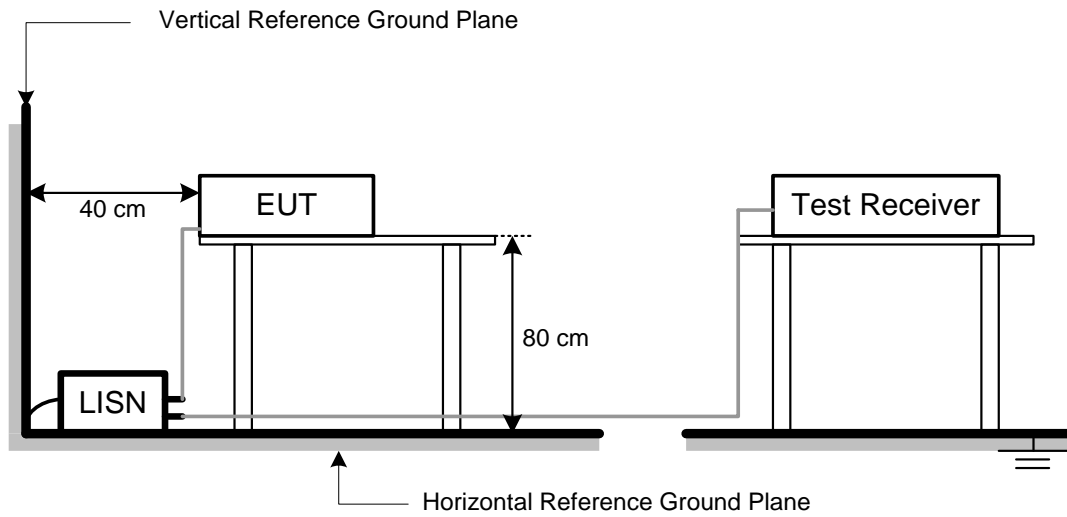

3.5 TEST RESULT

Please refer to the APPENDIX A.

4 RADIATED EMISSIONS TEST

4.1 LIMIT

In case the emission fall within the restricted band specified on 15.205, then the 15.209 limit in the table below has to be followed.

LIMITS OF RADIATED EMISSIONS MEASUREMENT (9 kHz to 1000 MHz)

Frequency (MHz)	Field Strength (microvolts/meter)	Measurement Distance (meters)
0.009~0.490	2400/F(KHz)	300
0.490~1.705	24000/F(KHz)	30
1.705~30.0	30	30
30~88	100	3
88~216	150	3
216~960	200	3
960~1000	500	3

LIMITS OF RADIATED EMISSIONS MEASUREMENT (Above 1000 MHz)

Frequency (MHz)	Radiated Emissions (dBuV/m)		Measurement Distance (meters)
	Peak	Average	
Above 1000	74	54	3

NOTE:

- (1) The limit for radiated test was performed according to FCC CFR Title 47, Part 15, Subpart C.
- (2) The tighter limit applies at the band edges.
- (3) Emission level (dBuV/m)=20log Emission level (uV/m).
- (4) The test result calculated as following:

Measurement Value = Reading Level + Correct Factor

Correct Factor = Antenna Factor + Cable Loss - Amplifier Gain(if use)

Margin Level = Measurement Value - Limit Value

Calculation example:

Reading Level		Correct Factor		Measurement Value
35.45	+	-11.37	=	24.08

Measurement Value		Limit Value		Margin Level
24.08	-	40	=	-15.92

Spectrum Parameter	Setting
Attenuation	Auto
Start Frequency	1000 MHz
Stop Frequency	10th carrier harmonic
RBW / VBW (Emission in restricted band)	1MHz / 3MHz for Peak, 1MHz / 1/T for Average

Mode	VBW(Hz)
BT (1M)	360
BT (2M)	360
BT (3M)	360

Spectrum Parameter	Setting
Attenuation	Auto
Start ~ Stop Frequency	9KHz~90KHz for PK/AVG detector
Start ~ Stop Frequency	90KHz~110KHz for QP detector
Start ~ Stop Frequency	110KHz~490KHz for PK/AVG detector
Start ~ Stop Frequency	490KHz~30MHz for QP detector
Start ~ Stop Frequency	30MHz~1000MHz for QP detector

4.2 TEST PROCEDURE

- a. The measuring distance of 3 m shall be used for measurements. The EUT was placed on the top of a rotating table 0.8 meter above the ground at a 3 meter semi-anechoic chamber. The table was rotated 360 degrees to determine the position of the highest radiation.(below 1GHz)
- b. The measuring distance of 3 m shall be used for measurements. The EUT was placed on the top of a rotating table 1.5 meter above the ground at a 3 meter semi-anechoic chamber. The table was rotated 360 degrees to determine the position of the highest radiation.(above 1GHz)
- c. The height of the equipment or of the substitution antenna shall be 0.8 m or 1.5 m, the height of the test antenna shall vary between 1 m to 4 m. Both horizontal and vertical polarizations of the antenna are set to make the measurement.
- d. For each suspected emission, the EUT was arranged to its worst case and then the antenna was tuned to heights find the maximum reading (used Bore sight function).
- e. The receiver system was set to peak and average detect function and specified bandwidth with maximum hold mode when the test frequency is above 1GHz.
- f. The initial step in collecting radiated emission data is a receiver peak detector mode pre-scanning the measurement frequency range. Significant peaks are then marked and then Quasi Peak detector mode re-measured.
- g. All readings are Peak unless otherwise stated QP in column of Note. Peak denotes that the Peak reading complies with the QP Limits and then QP Mode measurement didn't perform. (below 1GHz)
- h. All readings are Peak Mode value unless otherwise stated AVG in column of Note. If the Peak Mode Measured value complies with the Peak Limits and lower than AVG Limits, the EUT shall be deemed to meet both Peak & AVG Limits and then only Peak Mode was measured, but AVG Mode didn't perform. (above 1GHz)
- i. For the actual test configuration, please refer to the related Item – EUT TEST PHOTO.

4.3 DEVIATION FROM TEST STANDARD

No deviation.

4.4 TEST SETUP

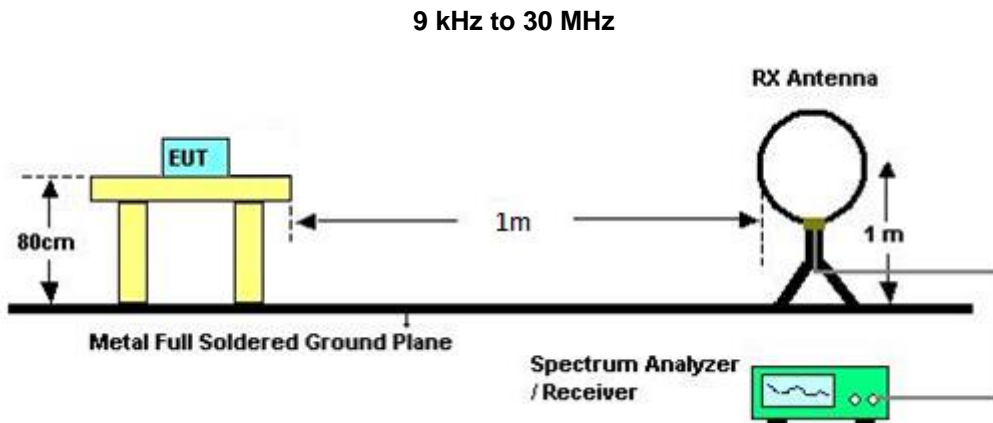

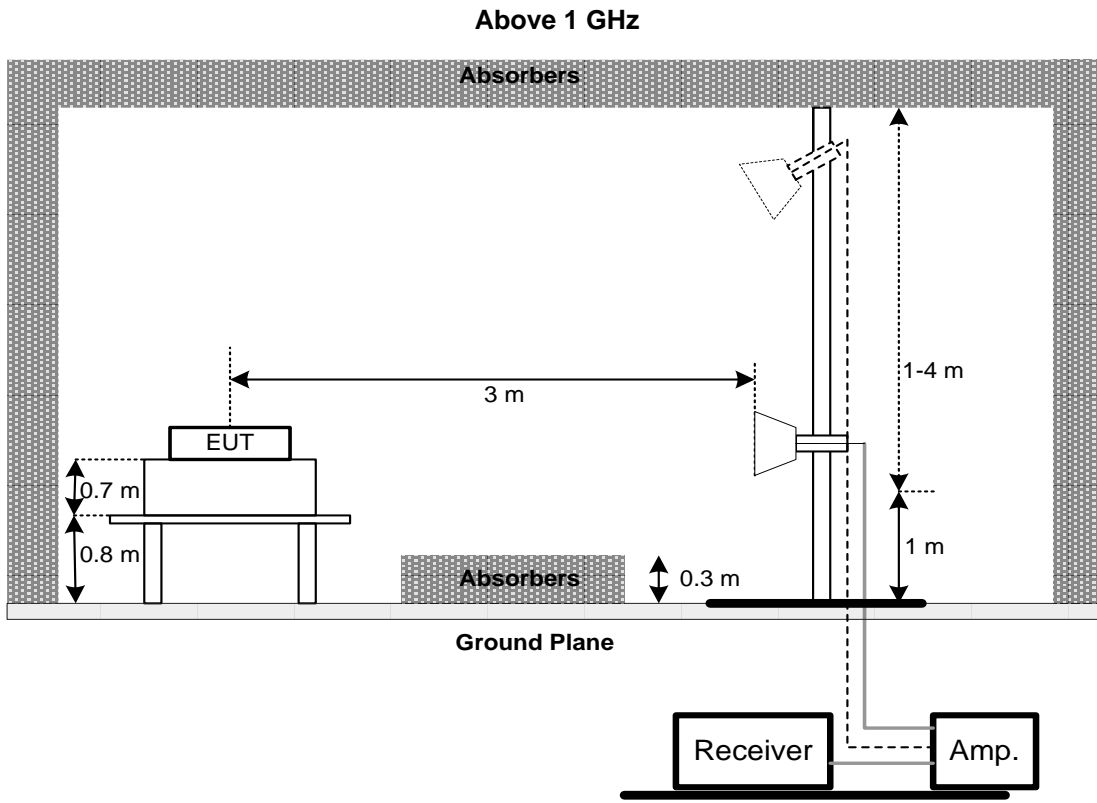
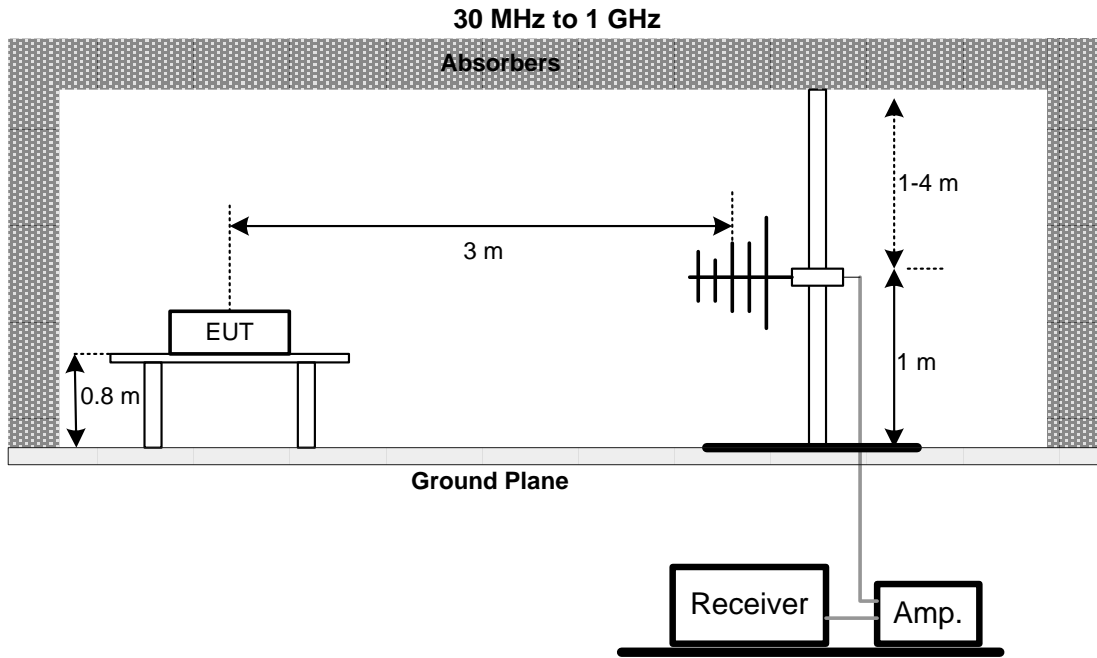

4.5 EUT OPERATING CONDITIONS

The EUT was programmed to be in continuously transmitting mode.

4.6 TEST RESULT – BELOW 30 MHZ

There were no emissions found below 30 MHz within 20 dB of the limit.

4.7 TEST RESULT – 30 MHZ TO 1 GHZ

Please refer to the APPENDIX B.

4.8 TEST RESULT – ABOVE 1 GHZ

Please refer to the APPENDIX C.

NOTE:

- (1) No limit: This is fundamental signal, the judgment is not applicable.
For fundamental signal judgment was referred to Peak output test.

5 NUMBER OF HOPPING CHANNEL

5.1 APPLIED PROCEDURES

Section	Test Item	Frequency Range (MHz)	Result
15.247(a)(1)(iii)	Number of Hopping Channel	2400-2483.5	PASS

Spectrum Parameters	Setting
Attenuation	Auto
Span Frequency	> Operating Frequency Range
RBW	100 KHz
VBW	100 KHz
Detector	Peak
Trace	Max Hold
Sweep Time	Auto

5.2 TEST PROCEDURE

- a. The EUT was directly connected to the spectrum analyzer and antenna output port as show in the block diagram below,
- b. Spectrum Setting: RBW=100KHz, VBW=100KHz, Sweep time = Auto.

5.3 DEVIATION FROM STANDARD

No deviation.

5.4 TEST SETUP



5.5 EUT OPERATION CONDITIONS

The EUT tested system was configured as the statements of 3.5 unless otherwise a special operating condition is specified in the follows during the testing.

5.6 TEST RESULTS

Please refer to the APPENDIX D.

6 AVERAGE TIME OF OCCUPANCY

6.1 APPLIED PROCEDURES / LIMIT

Section	Test Item	Limit	Frequency Range (MHz)	Result
15.247(a)(1)(iii)	Average Time of Occupancy	0.4sec	2400-2483.5	PASS

6.2 TEST PROCEDURE

- a. The transmitter output (antenna port) was connected to the spectrum analyzer
- b. Set RBW of spectrum analyzer to 1MHz and VBW to 1MHz.
- c. Use a video trigger with the trigger level set to enable triggering only on full pulses.
- d. Sweep Time is more than once pulse time.
- e. Set the center frequency on any frequency would be measure and set the frequency span to zero span.
- f. Measure the maximum time duration of one single pulse.
- g. Set the EUT for DH5, DH3 and DH1 packet transmitting.
- h. Measure the maximum time duration of one single pulse.
- i. Measure the maximum time duration of one single pulse.
A Period Time = (channel number)*0.4

For Normal Mode (79 Channel):

DH1 Time Solt: Reading * (1600/2)*31.6/(channel number)

DH3 Time Solt: Reading * (1600/2)*31.6/(channel number)

DH5 Time Solt: Reading * (1600/2)*31.6/(channel number)

For AFH Mode (20 Channel):

DH1 Time Solt: Reading * (1600/2)*8/(channel number)

DH3 Time Solt: Reading * (1600/4)*8/(channel number)

DH5 Time Solt: Reading * (1600/6)*8/(channel number)

6.3 DEVIATION FROM STANDARD

No deviation.

6.4 TEST SETUP



6.5 EUT OPERATION CONDITIONS

The EUT tested system was configured as the statements of 3.5 unless otherwise a special operating condition is specified in the follows during the testing.

6.6 TEST RESULTS

Please refer to the APPENDIX E.

7 Hopping Channel Separation Measurement

7.1 APPLIED PROCEDURES / LIMIT

Frequency hopping systems operating in the 2400-2483.5 MHz band may have hopping channel carrier frequencies that are separated by 25 KHz or two-thirds of the 20 dB bandwidth of the hopping channel, whichever is greater.

Spectrum Parameter	Setting
Attenuation	Auto
Span Frequency	> Measurement Bandwidth or Channel Separation
RBW	30 KHz
VBW	100 KHz
Detector	Peak
Trace	Max Hold
Sweep Time	Auto

7.2 TEST PROCEDURE

- a. The EUT must have its hopping function enabled
- b. Span = wide enough to capture the peaks of two adjacent channels
 Resolution (or IF) Bandwidth (RBW) \geq 1% of the span
 Video (or Average) Bandwidth (VBW) \geq RBW
 Sweep = Auto
 Detector function = Peak
 Trace = Max Hold

7.3 DEVIATION FROM STANDARD

No deviation.

7.4 TEST SETUP

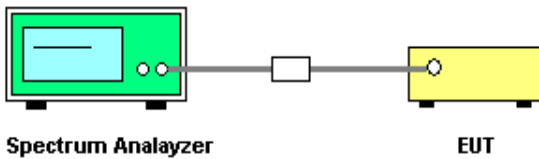

7.5 TEST RESULTS

Please refer to the APPENDIX F.

8 BANDWIDTH TEST

8.1 APPLIED PROCEDURES

Section	Test Item	Frequency Range (MHz)
15.247(a)(2)	Bandwidth	2400-2483.5

Spectrum Parameter	Setting
Attenuation	Auto
Span Frequency	> Measurement Bandwidth or Channel Separation
RBW	30 KHz (20dB Bandwidth) / 30 KHz (Channel Separation)
VBW	100 KHz (20dB Bandwidth) / 100 KHz (Channel Separation)
Detector	Peak
Trace	Max Hold
Sweep Time	Auto

8.2 TEST PROCEDURE

- a. The EUT was directly connected to the spectrum analyzer and antenna output port as show in the block diagram below,
- b. Spectrum Setting: RBW= 30KHz, VBW=100KHz, Sweep Time = Auto.

8.3 DEVIATION FROM STANDARD

No deviation.

8.4 TEST SETUP



8.5 EUT OPERATION CONDITIONS

The EUT tested system was configured as the statements of 3.5 unless otherwise a special operating condition is specified in the follows during the testing.

8.6 TEST RESULTS

Please refer to the APPENDIX G.

9 OUTPUT POWER TEST

9.1 APPLIED PROCEDURES / LIMIT

Section	Test Item	Limit	Frequency Range (MHz)	Result
15.247(b)(1)	Peak Output Power	0.125Watt or 21dBm	2400-2483.5	PASS

9.2 TEST PROCEDURE

- a. The EUT was directly connected to the spectrum analyzer and antenna output port as show in the block diagram below,
- b. Spectrum Setting: RBW= 3MHz, VBW= 3MHz, Sweep time = Auto.

9.3 DEVIATION FROM STANDARD

No deviation.

9.4 TEST SETUP

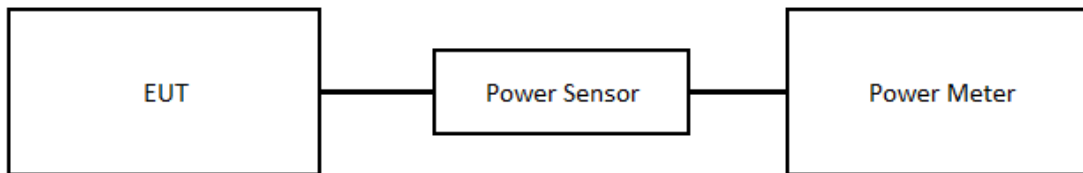

9.5 EUT OPERATION CONDITIONS

The EUT tested system was configured as the statements of 3.5 unless otherwise a special operating condition is specified in the follows during the testing.

9.6 TEST RESULTS

Please refer to the APPENDIX H.

10 ANTENNA CONDUCTED SPURIOUS EMISSION

10.1 APPLIED PROCEDURES / LIMIT

In any 100 kHz bandwidth outside the frequency band in which the spread spectrum or digitally modulated device is operating, the RF power that is produced shall be at least 20 dB below that in the 100 kHz bandwidth within the band that contains the highest level of the desired power, based on either an RF conducted or a radiated measurement, provided that the transmitter demonstrates compliance with the peak conducted power limits.

10.2 TEST PROCEDURE

- a. The EUT was directly connected to the spectrum analyzer and antenna output port as show in the block diagram below,
- b. Spectrum Setting: RBW= 100KHz, VBW=100KHz, Sweep time = Auto.
- c. Offset=antenna gain+cable loss

10.3 DEVIATION FROM STANDARD

No deviation.

10.4 TEST SETUP

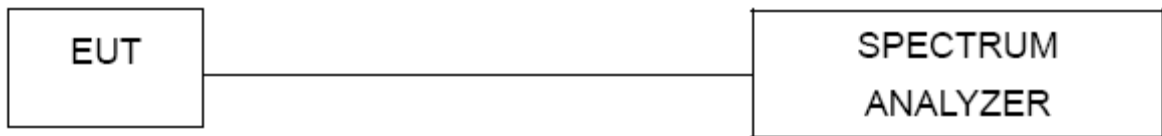

10.5 EUT OPERATION CONDITIONS

The EUT tested system was configured as the statements of 3.5 unless otherwise a special operating condition is specified in the follows during the testing.

10.6 TEST RESULTS

Please refer to the APPENDIX I.

11 LIST OF MEASURING EQUIPMENTS

AC Power Line Conducted Emissions						
Item	Kind of Equipment	Manufacturer	Type No.	Serial No.	Calibrated Date	Calibrated Until
1	TWO-LINE V-NETWORK	R&S	ENV216	101521	2022/9/28	2023/9/27
2	Test Cable	EMCI	EMCCFD300-BM-BMR-5000	220331	2023/3/30	2024/3/29
3	EMI Test Receiver	R&S	ESR 7	101433	2022/11/16	2023/11/15
4	Measurement Software	EZ	EZ EMC (Version NB-03A1-01)	N/A	N/A	N/A

Radiated Emissions						
Item	Kind of Equipment	Manufacturer	Type No.	Serial No.	Calibrated Date	Calibrated Until
1	Preamplifier	EMCI	EMC330N	980850	2022/9/19	2023/9/18
2	Preamplifier	EMCI	EMC118A45SE	980819	2023/3/7	2024/3/6
3	Pre-Amplifier	EMCI	EMC184045SE	980907	2022/9/28	2023/9/27
4	Preamplifier	EMCI	EMC001340	980579	2022/9/30	2023/9/29
5	Test Cable	EMCI	EMC104-SM-1000	180809	2023/7/10	2024/7/9
6	Test Cable	EMCI	EMC104-SM-SM-3000	220322	2023/3/14	2024/3/13
7	Test Cable	EMCI	EMC104-SM-SM-7000	220324	2023/3/14	2024/3/13
8	EXA Signal Analyzer	keysight	N9020B	MY57120120	2023/2/24	2024/2/23
9	Loop Ant	Electro-Metrics	EMCI-LPA600	291	2022/9/19	2023/9/18
10	Horn Antenna	RFSPIN	DRH18-E	211202A18EN	2023/5/12	2024/5/11
11	Horn Ant	Schwarzbeck	BBHA 9170D	1136	2023/5/12	2024/5/11
12	Log-bicon Antenna	Schwarzbeck	VULB9168	1369	2023/5/9	2024/5/8
13	6dB Attenuator	EMCI	EMCI-N-6-06	AT-06001	2023/5/9	2024/5/8
14	Test Cable	EMCI	EMC101G-KM-KM-3000	220329	2023/3/14	2024/3/13
15	Test Cable	EMCI	EMC102-KM-KM-1000	220327	2023/3/14	2024/3/13
16	Measurement Software	EZ	EZ EMC (Version NB-03A1-01)	N/A	N/A	N/A

Number of Hopping Frequency						
Item	Kind of Equipment	Manufacturer	Type No.	Serial No.	Calibrated Date	Calibrated Until
1	Spectrum Analyzer	R&S	FSP 40	101139	2023/3/9	2024/3/8

Average Time of Occupancy						
Item	Kind of Equipment	Manufacturer	Type No.	Serial No.	Calibrated Date	Calibrated Until
1	Spectrum Analyzer	R&S	FSP 40	101139	2023/3/9	2024/3/8

Hopping Channel Separation						
Item	Kind of Equipment	Manufacturer	Type No.	Serial No.	Calibrated Date	Calibrated Until
1	Spectrum Analyzer	R&S	FSP 40	101139	2023/3/9	2024/3/8

Bandwidth						
Item	Kind of Equipment	Manufacturer	Type No.	Serial No.	Calibrated Date	Calibrated Until
1	Spectrum Analyzer	R&S	FSP 40	101139	2023/3/9	2024/3/8

Output Power						
Item	Kind of Equipment	Manufacturer	Type No.	Serial No.	Calibrated Date	Calibrated Until
1	Power Meter	Anritsu	ML2495A	1128008	2023/5/12	2024/5/11
2	Power Sensor	Anritsu	MA2411B	1126001	2023/5/12	2024/5/11

Antenna conducted Spurious Emission						
Item	Kind of Equipment	Manufacturer	Type No.	Serial No.	Calibrated Date	Calibrated Until
1	Spectrum Analyzer	R&S	FSP 40	101139	2023/3/9	2024/3/8

Remark: "N/A" denotes no model name, no serial no. or no calibration specified.
All calibration period of equipment list is one year.

12 EUT TEST PHOTO

Please refer to document Appendix No.: TP-2308T045-FCCP-1 (APPENDIX-TEST PHOTOS).

13 EUT PHOTOS

Please refer to document Appendix No.: EP-2308T045-1 (APPENDIX-EUT PHOTOS).

APPENDIX A AC POWER LINE CONDUCTED EMISSIONS

Test Mode	Normal	Tested Date	2023/8/25
Test Frequency	-	Phase	Line

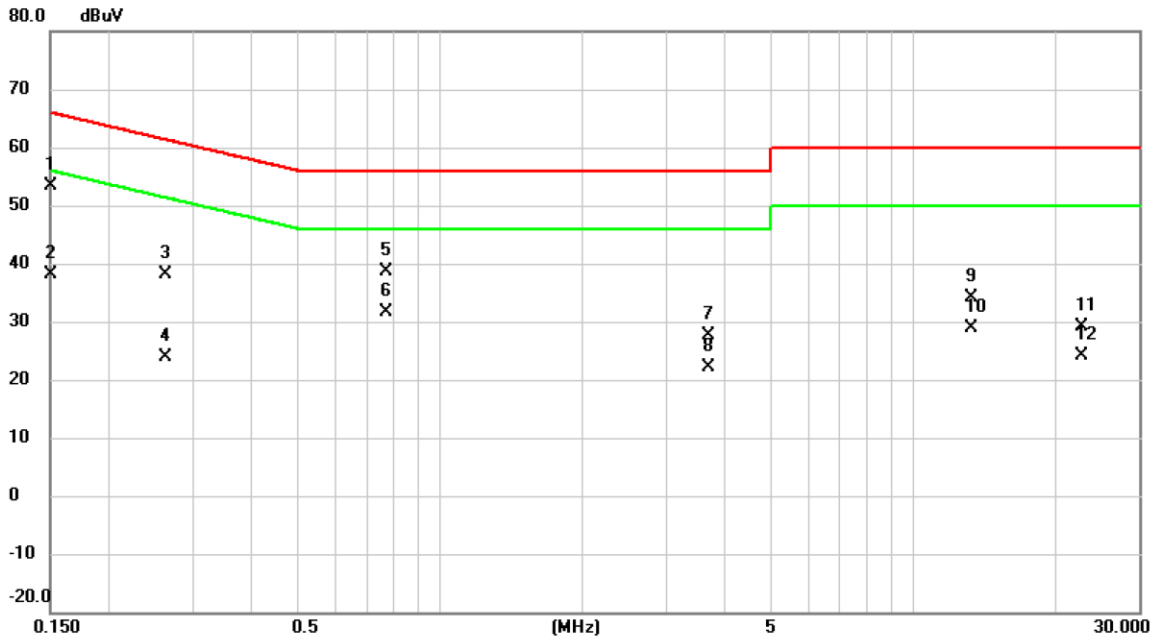

No.	Mk.	Freq.	Reading Level	Correct Factor	Measurement	Limit	Margin	Detector	Comment
		MHz	dBuV	dB	dBuV	dBuV	dB		
1	*	0.1500	43.78	9.67	53.45	66.00	-12.55	QP	
2		0.1500	28.56	9.67	38.23	56.00	-17.77	AVG	
3		0.2625	28.58	9.65	38.23	61.35	-23.12	QP	
4		0.2625	14.13	9.65	23.78	51.35	-27.57	AVG	
5		0.7687	28.95	9.64	38.59	56.00	-17.41	QP	
6		0.7687	22.05	9.64	31.69	46.00	-14.31	AVG	
7		3.6938	17.88	9.70	27.58	56.00	-28.42	QP	
8		3.6938	12.51	9.70	22.21	46.00	-23.79	AVG	
9		13.2968	24.13	9.89	34.02	60.00	-25.98	QP	
10		13.2968	18.92	9.89	28.81	50.00	-21.19	AVG	
11		22.6793	19.04	10.05	29.09	60.00	-30.91	QP	
12		22.6793	14.00	10.05	24.05	50.00	-25.95	AVG	

REMARKS:
 (1) Measurement Value = Reading Level + Correct Factor.
 (2) Margin Level = Measurement Value - Limit Value.

Test Mode	Normal	Tested Date	2023/8/25
Test Frequency	-	Phase	Neutral

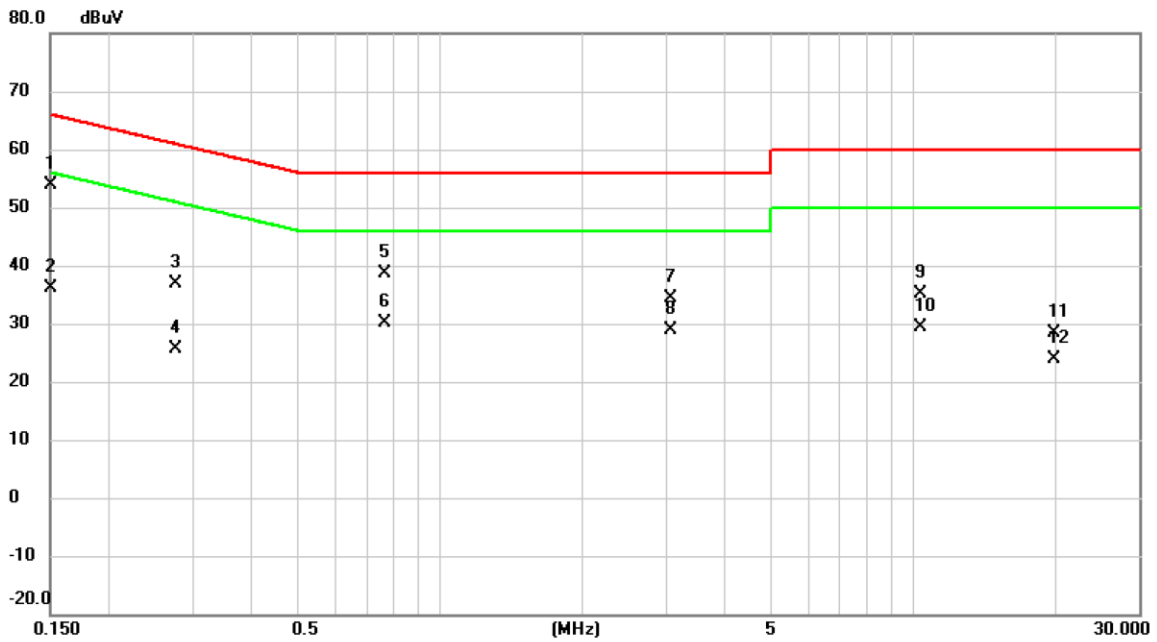

No.	Mk.	Freq.	Reading Level	Correct Factor	Measurement	Limit	Margin	Detector	Comment
		MHz	dBuV	dB	dBuV	dBuV	dB		
1	*	0.1500	44.14	9.66	53.80	66.00	-12.20	QP	
2		0.1500	26.51	9.66	36.17	56.00	-19.83	AVG	
3		0.2760	27.30	9.63	36.93	60.94	-24.01	QP	
4		0.2760	16.00	9.63	25.63	50.94	-25.31	AVG	
5		0.7664	29.08	9.63	38.71	56.00	-17.29	QP	
6		0.7664	20.41	9.63	30.04	46.00	-15.96	AVG	
7		3.0750	24.74	9.69	34.43	56.00	-21.57	QP	
8		3.0750	19.08	9.69	28.77	46.00	-17.23	AVG	
9		10.3447	25.30	9.81	35.11	60.00	-24.89	QP	
10		10.3447	19.63	9.81	29.44	50.00	-20.56	AVG	
11		19.9050	18.56	9.87	28.43	60.00	-31.57	QP	
12		19.9050	13.94	9.87	23.81	50.00	-26.19	AVG	

REMARKS:
 (1) Measurement Value = Reading Level + Correct Factor.
 (2) Margin Level = Measurement Value - Limit Value.

Test Mode	Idle	Tested Date	2023/8/25
Test Frequency	-	Phase	Line

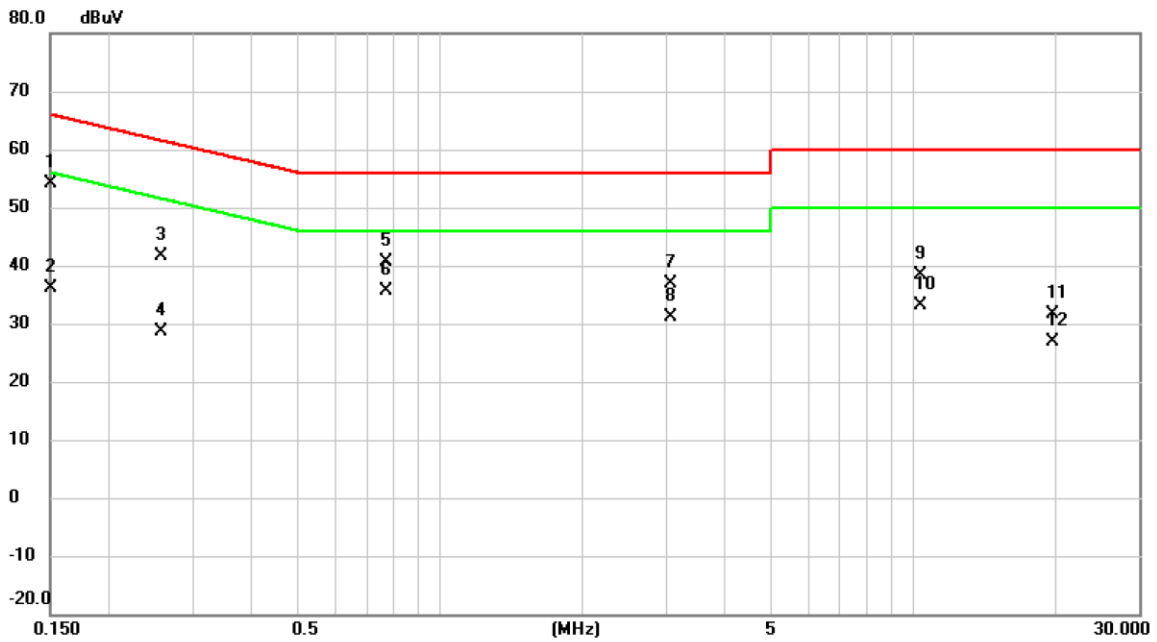

No.	Mk.	Freq. MHz	Reading Level dBuV	Correct Factor dB	Measurement dBuV	Limit dBuV	Margin dB	Detector	Comment
1		0.1500	44.58	9.66	54.24	66.00	-11.76	QP	
2		0.1500	26.47	9.66	36.13	56.00	-19.87	AVG	
3		0.2580	31.90	9.64	41.54	61.50	-19.96	QP	
4		0.2580	19.06	9.64	28.70	51.50	-22.80	AVG	
5		0.7710	31.12	9.63	40.75	56.00	-15.25	QP	
6	*	0.7710	26.10	9.63	35.73	46.00	-10.27	AVG	
7		3.0683	27.09	9.69	36.78	56.00	-19.22	QP	
8		3.0683	21.33	9.69	31.02	46.00	-14.98	AVG	
9		10.3334	28.46	9.81	38.27	60.00	-21.73	QP	
10		10.3334	23.30	9.81	33.11	50.00	-16.89	AVG	
11		19.7182	21.64	9.87	31.51	60.00	-28.49	QP	
12		19.7182	16.91	9.87	26.78	50.00	-23.22	AVG	

REMARKS:

- (1) Measurement Value = Reading Level + Correct Factor.
- (2) Margin Level = Measurement Value - Limit Value.

Test Mode	Idle	Tested Date	2023/8/25
Test Frequency	-	Phase	Neutral

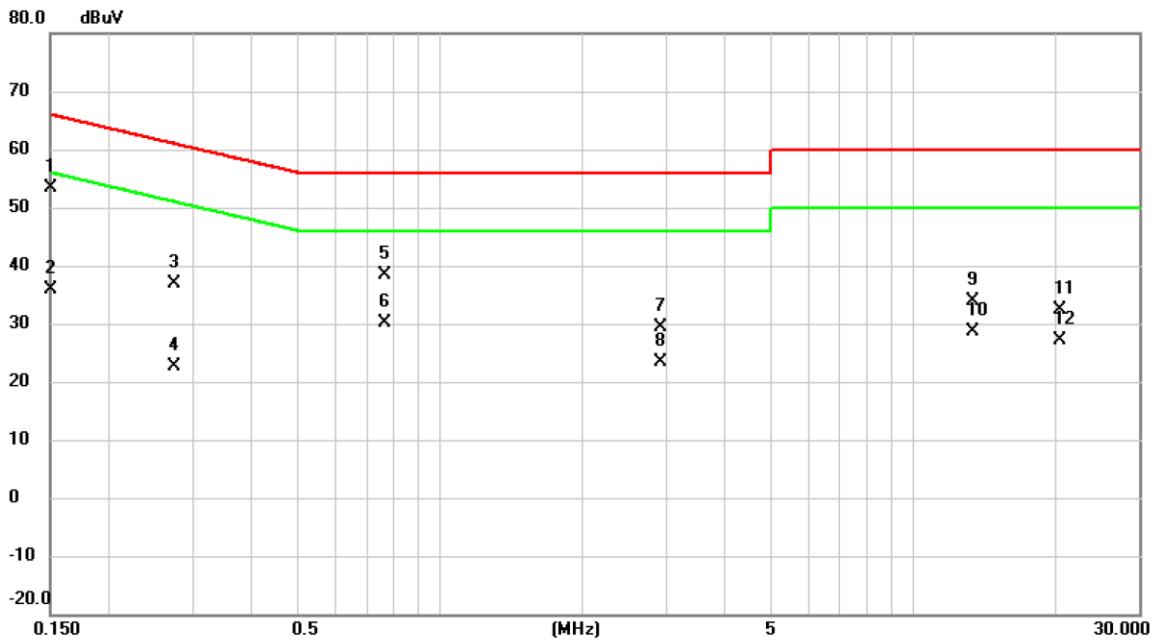

No.	Mk.	Freq.	Reading Level	Correct Factor	Measurement	Limit	Margin	Detector	Comment
		MHz	dBuV	dB	dBuV	dBuV	dB		
1	*	0.1500	43.71	9.67	53.38	66.00	-12.62	QP	
2		0.1500	26.14	9.67	35.81	56.00	-20.19	AVG	
3		0.2737	27.23	9.65	36.88	61.00	-24.12	QP	
4		0.2737	13.03	9.65	22.68	51.00	-28.32	AVG	
5		0.7664	28.69	9.64	38.33	56.00	-17.67	QP	
6		0.7664	20.40	9.64	30.04	46.00	-15.96	AVG	
7		2.9220	19.79	9.69	29.48	56.00	-26.52	QP	
8		2.9220	13.58	9.69	23.27	46.00	-22.73	AVG	
9		13.3980	24.07	9.89	33.96	60.00	-26.04	QP	
10		13.3980	18.80	9.89	28.69	50.00	-21.31	AVG	
11		20.3482	22.36	10.00	32.36	60.00	-27.64	QP	
12		20.3482	17.03	10.00	27.03	50.00	-22.97	AVG	

REMARKS:
 (1) Measurement Value = Reading Level + Correct Factor.
 (2) Margin Level = Measurement Value - Limit Value.

APPENDIX B RADIATED EMISSIONS - 30 MHZ TO 1 GHZ

Test Mode	BT(1Mbps)	Test Date	2023/9/6
Test Frequency	2441MHz	Polarization	Vertical
Temp	23°C	Hum.	55%

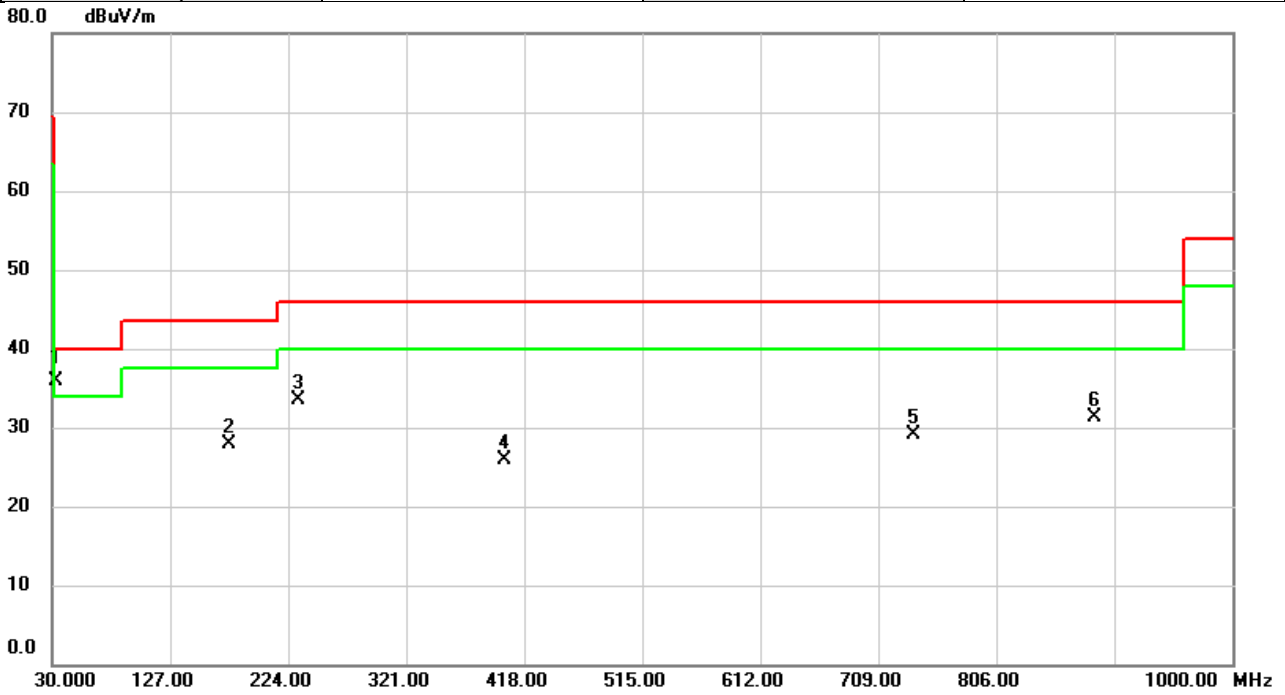

No.	Mk.	Freq. MHz	Reading Level dBuV	Correct Factor dB	Measure- ment dBuV/m	Limit dBuV/m	Over dB	Detector	Comment
1	*	33.0717	48.60	-12.77	35.83	40.00	-4.17	QP	
2		175.0473	40.58	-12.70	27.88	43.50	-15.62	peak	
3		232.5037	47.82	-14.22	33.60	46.00	-12.40	peak	
4		402.2213	34.39	-8.49	25.90	46.00	-20.10	peak	
5		738.1970	30.75	-1.64	29.11	46.00	-16.89	peak	
6		886.9627	30.97	0.42	31.39	46.00	-14.61	peak	

REMARKS:

- (1) Measurement Value = Reading Level + Correct Factor.
- (2) Margin Level = Measurement Value - Limit Value.

Test Mode	BT(1Mbps)	Test Date	2023/9/6
Test Frequency	2441MHz	Polarization	Horizontal
Temp	23°C	Hum.	55%

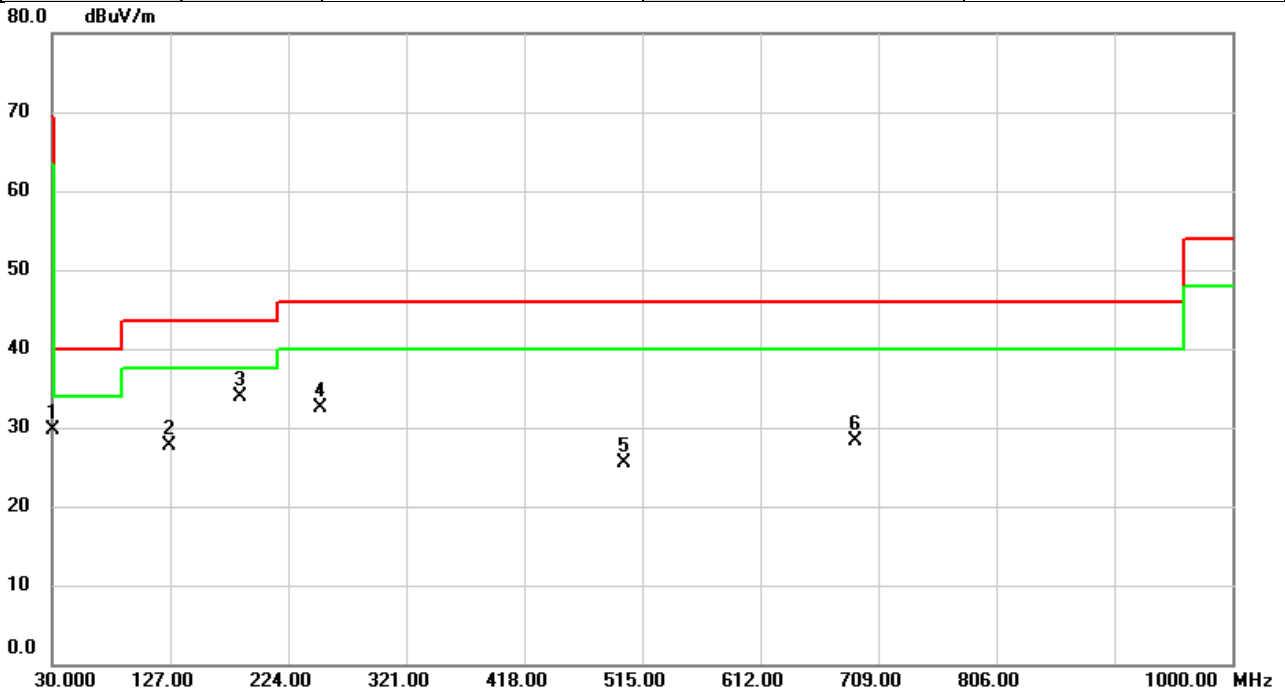

No.	Mk.	Freq.	Reading Level	Correct Factor	Measurement	Limit	Over	Detector	Comment
		MHz	dBuV	dB	dBuV/m	dBuV/m	dB		
1		30.0000	42.98	-13.32	29.66	40.00	-10.34	peak	
2		125.9977	41.42	-13.76	27.66	43.50	-15.84	peak	
3	*	184.9413	47.69	-13.78	33.91	43.50	-9.59	peak	
4		250.3840	45.56	-12.99	32.57	46.00	-13.43	peak	
5		500.7410	31.81	-6.22	25.59	46.00	-20.41	peak	
6		690.0850	30.88	-2.63	28.25	46.00	-17.75	peak	

REMARKS:

- (1) Measurement Value = Reading Level + Correct Factor.
- (2) Margin Level = Measurement Value - Limit Value.

APPENDIX C RADIATED EMISSIONS - ABOVE 1 GHZ

Test Mode	BT(1Mbps)	Test Date	2023/8/30
Test Frequency	2402MHz	Polarization	Horizontal
Temp	24°C	Hum.	55%

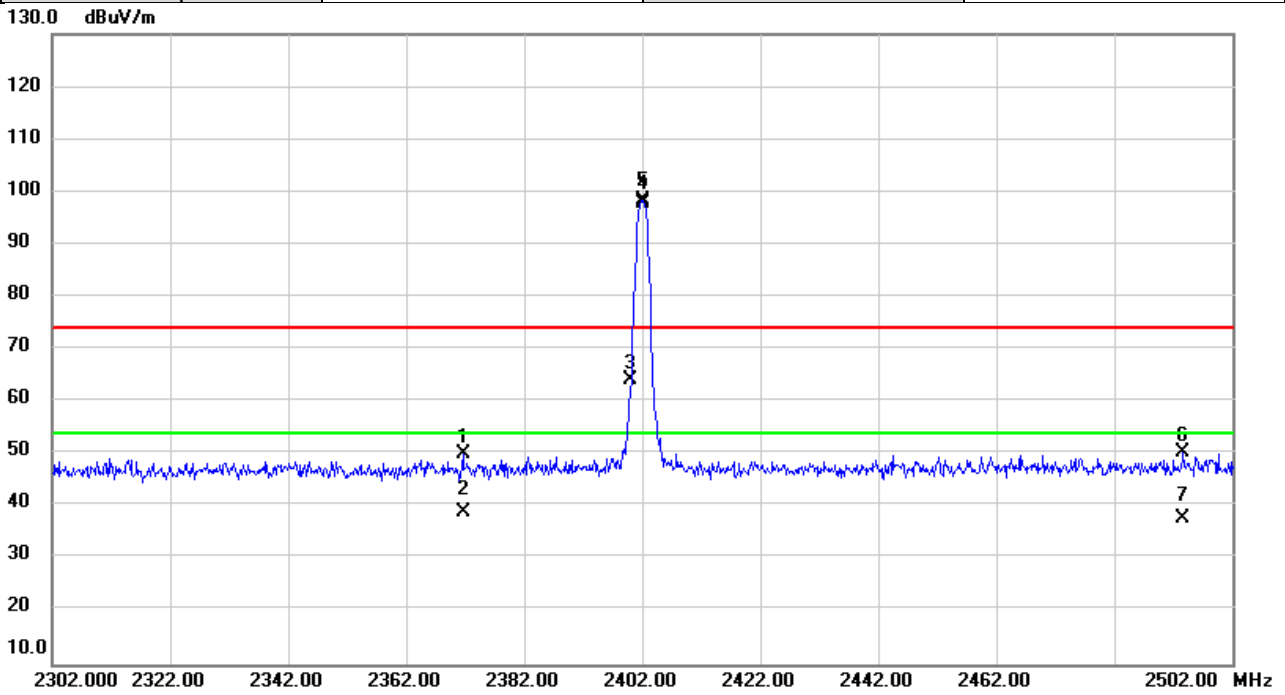

No.	Mk.	Freq.	Reading Level	Correct Factor	Measurement	Limit	Over	Detector	Comment
		MHz	dBuV	dB	dBuV/m	dBuV/m	dB		
1		2371.773	55.56	-5.60	49.96	74.00	-24.04	peak	
2		2371.773	44.63	-5.60	39.03	54.00	-14.97	AVG	
3		2400.000	69.59	-5.56	64.03	74.00	-9.97	peak	No Limit
4	X	2402.000	103.80	-5.55	98.25	74.00	24.25	peak	No Limit
5	*	2402.000	103.39	-5.55	97.84	54.00	43.84	AVG	No Limit
6		2493.620	55.84	-5.39	50.45	74.00	-23.55	peak	
7		2493.620	43.16	-5.39	37.77	54.00	-16.23	AVG	

REMARKS:

- (1) Measurement Value = Reading Level + Correct Factor.
- (2) Margin Level = Measurement Value - Limit Value.

Test Mode	BT(1Mbps)	Test Date	2023/8/30
Test Frequency	2480MHz	Polarization	Horizontal
Temp	24°C	Hum.	55%

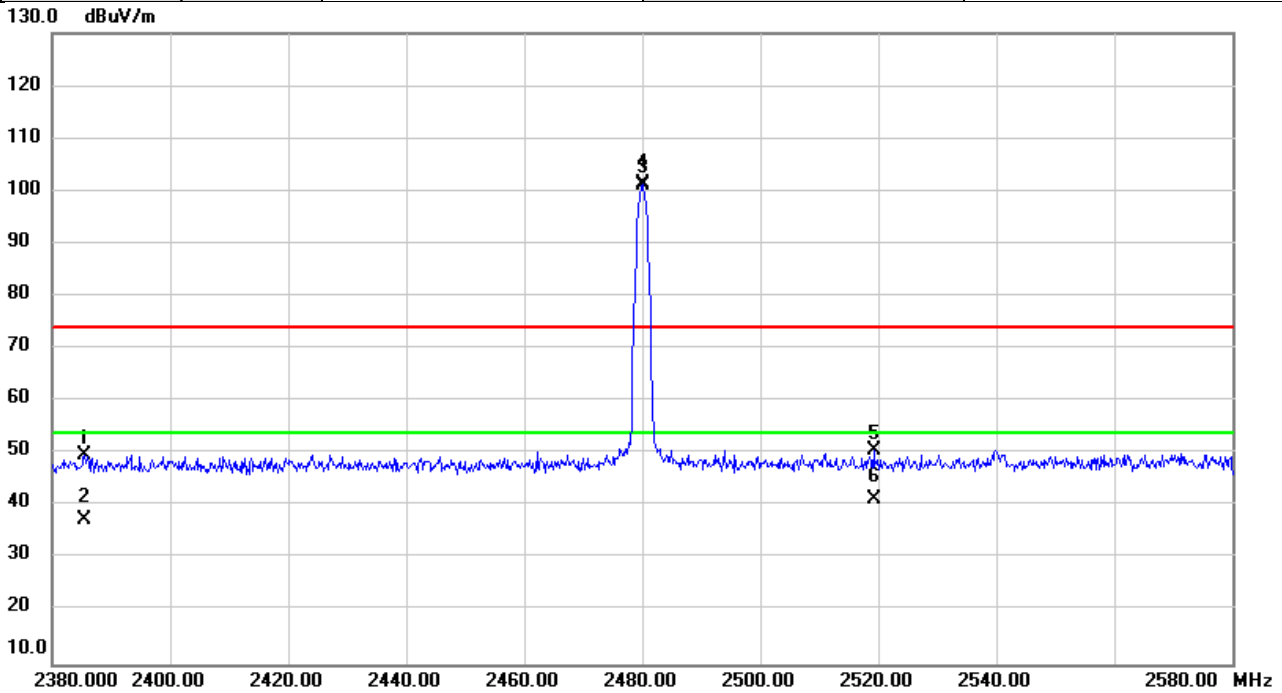

No.	Mk.	Freq.	Reading Level	Correct Factor	Measurement	Limit	Over	Detector	Comment
		MHz	dBuV	dB	dBuV/m	dBuV/m	dB		
1		2385.533	55.35	-5.58	49.77	74.00	-24.23	peak	
2		2385.533	42.97	-5.58	37.39	54.00	-16.61	AVG	
3	X	2480.000	106.62	-5.41	101.21	74.00	27.21	peak	No Limit
4	*	2480.000	106.49	-5.41	101.08	54.00	47.08	AVG	No Limit
5		2519.360	56.11	-5.31	50.80	74.00	-23.20	peak	
6		2519.360	46.69	-5.31	41.38	54.00	-12.62	AVG	

REMARKS:

- (1) Measurement Value = Reading Level + Correct Factor.
- (2) Margin Level = Measurement Value - Limit Value.

Test Mode	BT(3Mbps)	Test Date	2023/8/30
Test Frequency	2402MHz	Polarization	Horizontal
Temp	24°C	Hum.	55%

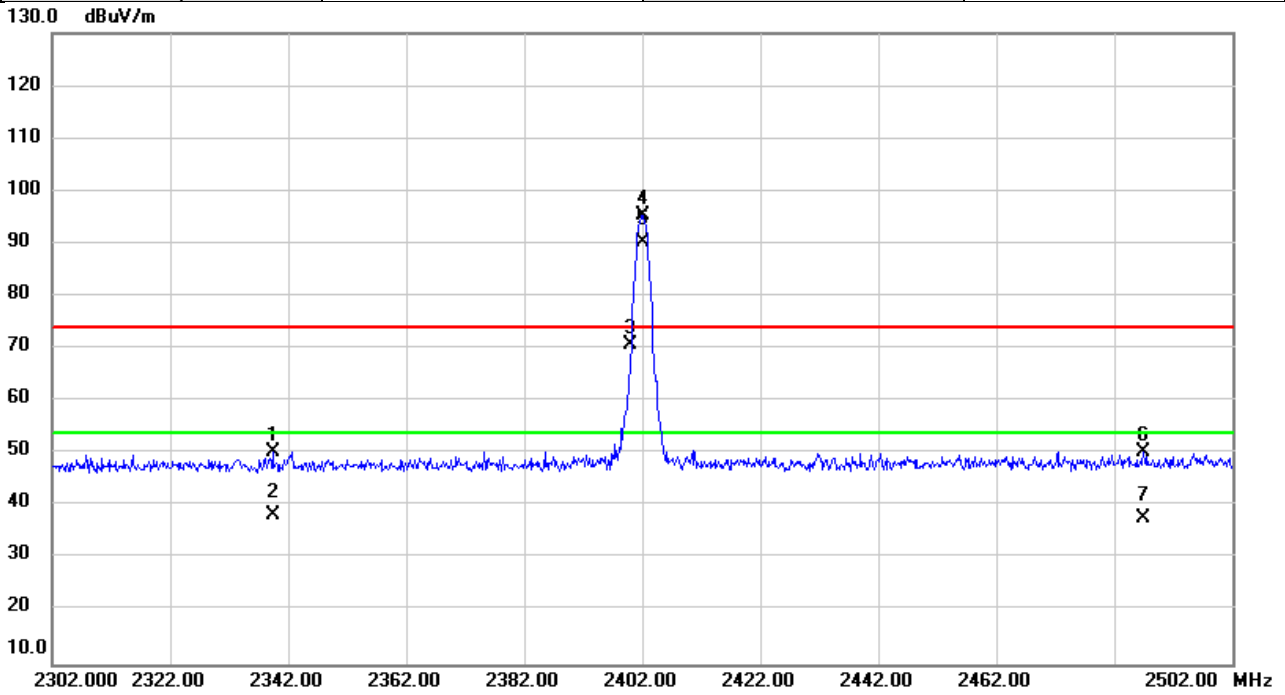

No.	Mk.	Freq.	Reading Level	Correct Factor	Measurement	Limit	Over	Detector	Comment
		MHz	dBuV	dB	dBuV/m	dBuV/m	dB		
1		2339.547	56.03	-5.66	50.37	74.00	-23.63	peak	
2		2339.547	44.05	-5.66	38.39	54.00	-15.61	AVG	
3		2400.000	76.37	-5.56	70.81	74.00	-3.19	peak	No Limit
4	X	2402.000	100.95	-5.55	95.40	74.00	21.40	peak	No Limit
5	*	2402.000	95.87	-5.55	90.32	54.00	36.32	AVG	No Limit
6		2486.833	55.67	-5.40	50.27	74.00	-23.73	peak	
7		2486.833	43.26	-5.40	37.86	54.00	-16.14	AVG	

REMARKS:

- (1) Measurement Value = Reading Level + Correct Factor.
- (2) Margin Level = Measurement Value - Limit Value.

Test Mode	BT(3Mbps)	Test Date	2023/8/30
Test Frequency	2480MHz	Polarization	Horizontal
Temp	24°C	Hum.	55%

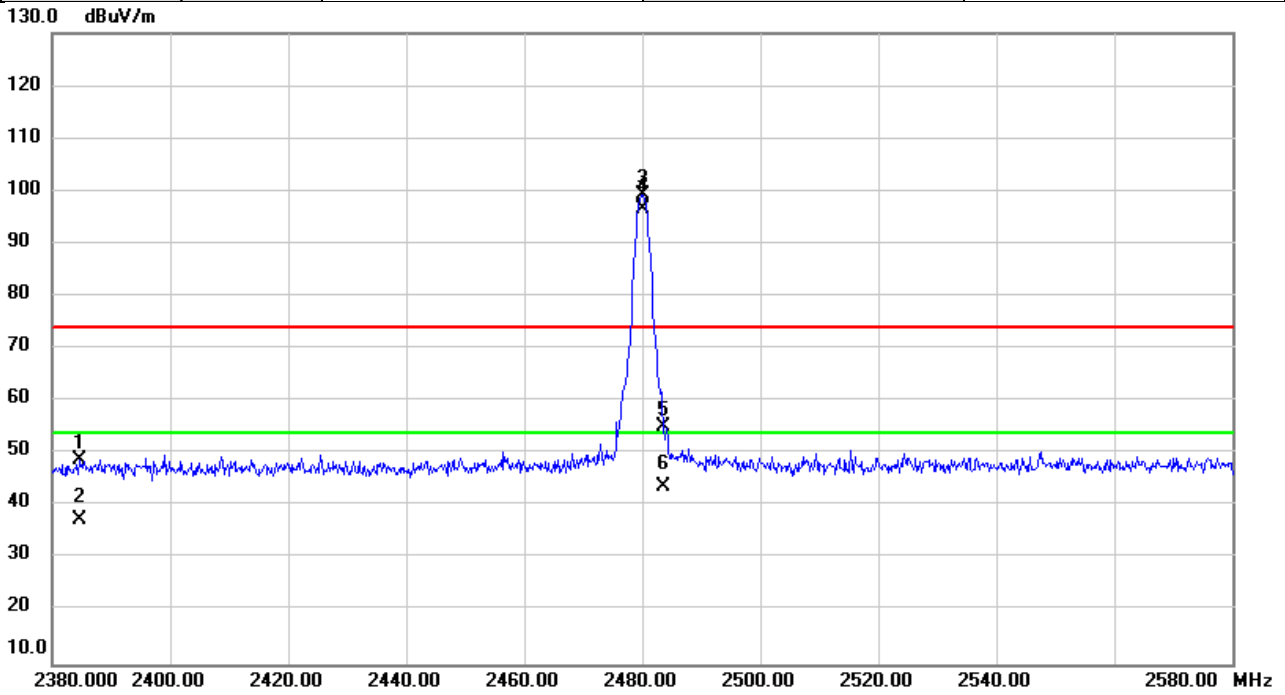

No.	Mk.	Freq.	Reading Level	Correct Factor	Measurement	Limit	Over	Detector	Comment
		MHz	dBuV	dB	dBuV/m	dBuV/m	dB		
1		2384.767	54.55	-5.58	48.97	74.00	-25.03	peak	
2		2384.767	43.13	-5.58	37.55	54.00	-16.45	AVG	
3	X	2480.000	104.69	-5.41	99.28	74.00	25.28	peak	No Limit
4	*	2480.000	102.07	-5.41	96.66	54.00	42.66	AVG	No Limit
5		2483.600	60.43	-5.42	55.01	74.00	-18.99	peak	
6		2483.600	49.28	-5.42	43.86	54.00	-10.14	AVG	

REMARKS:

- (1) Measurement Value = Reading Level + Correct Factor.
- (2) Margin Level = Measurement Value - Limit Value.

Test Mode	BT(1Mbps)	Test Date	2023/8/31
Test Frequency	2402MHz	Polarization	Vertical
Temp	22°C	Hum.	51%

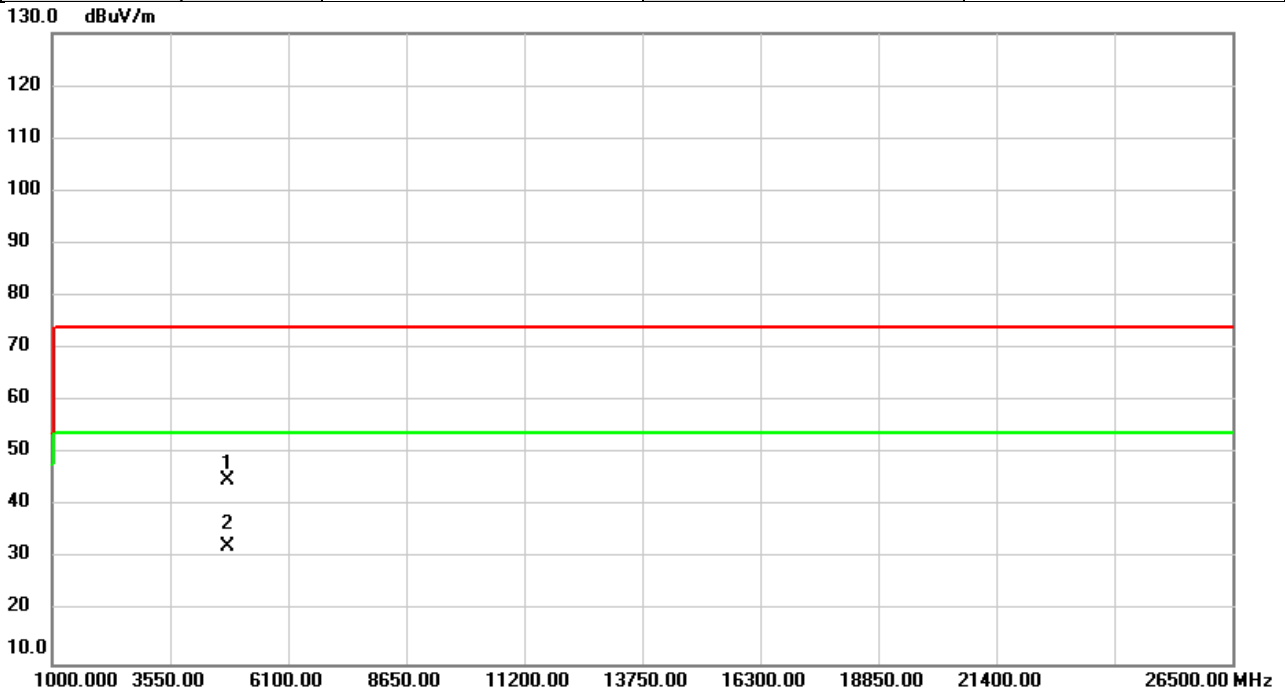

No.	Mk.	Freq. MHz	Reading Level dBuV	Correct Factor dB	Measure- ment dBuV/m	Limit dBuV/m	Over dB	Detector	Comment
1		4804.000	44.35	0.50	44.85	74.00	-29.15	peak	
2	*	4804.000	31.79	0.50	32.29	54.00	-21.71	AVG	

REMARKS:

- (1) Measurement Value = Reading Level + Correct Factor.
- (2) Margin Level = Measurement Value - Limit Value.

Test Mode	BT(1Mbps)	Test Date	2023/8/31
Test Frequency	2402MHz	Polarization	Horizontal
Temp	22°C	Hum.	51%

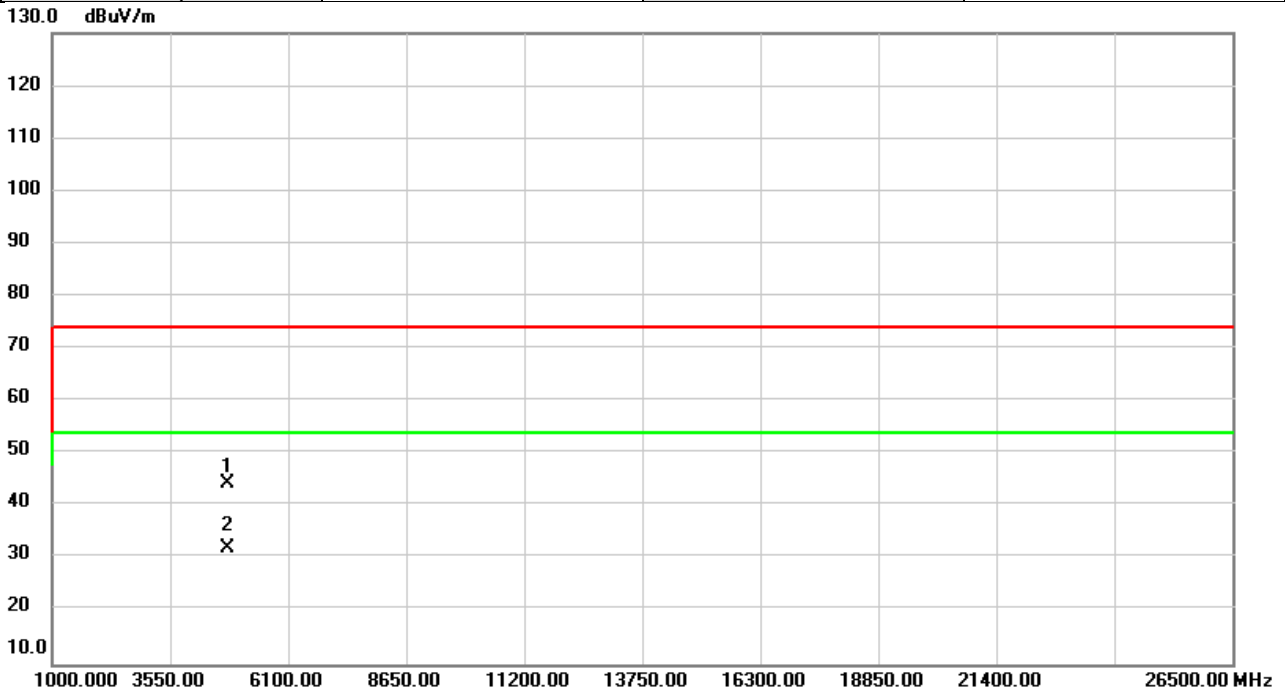

No.	Mk.	Freq. MHz	Reading Level dBuV	Correct Factor dB	Measure- ment dBuV/m	Limit dBuV/m	Over dB	Detector	Comment
1		4804.000	43.97	0.50	44.47	74.00	-29.53	peak	
2	*	4804.000	31.63	0.50	32.13	54.00	-21.87	AVG	

REMARKS:

- (1) Measurement Value = Reading Level + Correct Factor.
- (2) Margin Level = Measurement Value - Limit Value.

Test Mode	BT(1Mbps)	Test Date	2023/8/31
Test Frequency	2441MHz	Polarization	Vertical
Temp	22°C	Hum.	51%

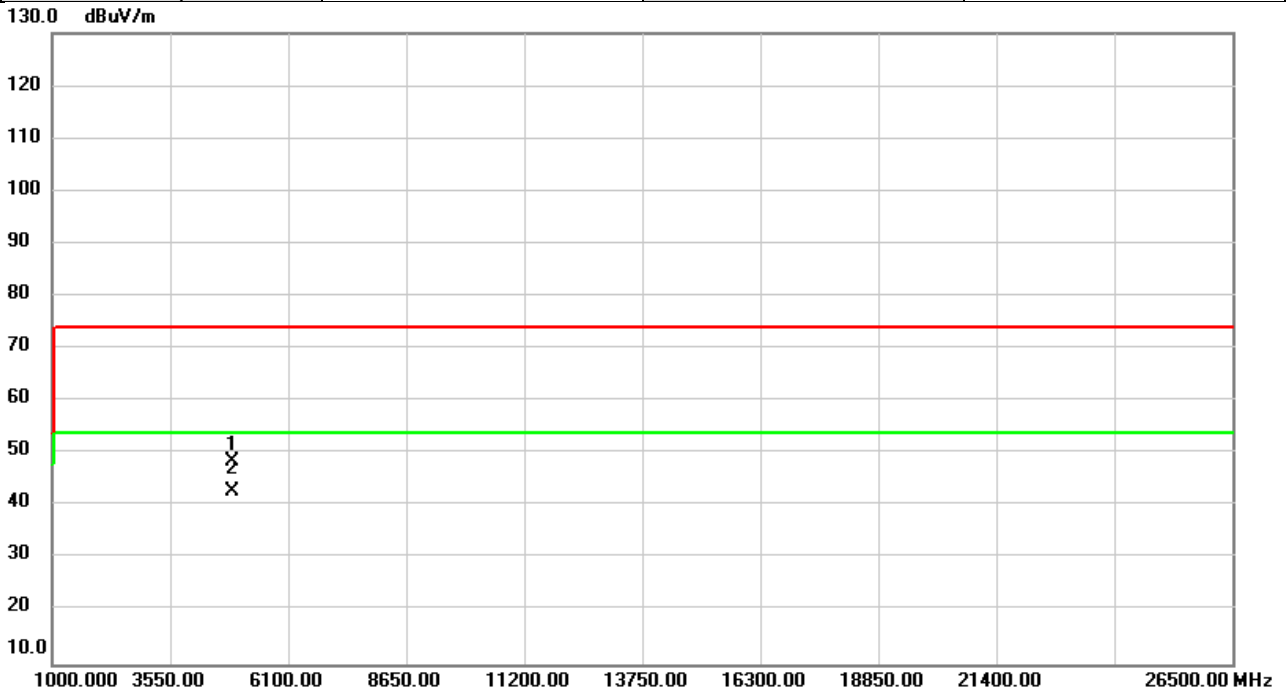

No.	Mk.	Freq. MHz	Reading Level dBuV	Correct Factor dB	Measure- ment dBuV/m	Limit dBuV/m	Over dB	Detector	Comment
1		4882.000	47.80	0.74	48.54	74.00	-25.46	peak	
2	*	4882.000	42.24	0.74	42.98	54.00	-11.02	AVG	

REMARKS:

- (1) Measurement Value = Reading Level + Correct Factor.
- (2) Margin Level = Measurement Value - Limit Value.

Test Mode	BT(1Mbps)	Test Date	2023/8/31
Test Frequency	2441MHz	Polarization	Horizontal
Temp	22°C	Hum.	51%

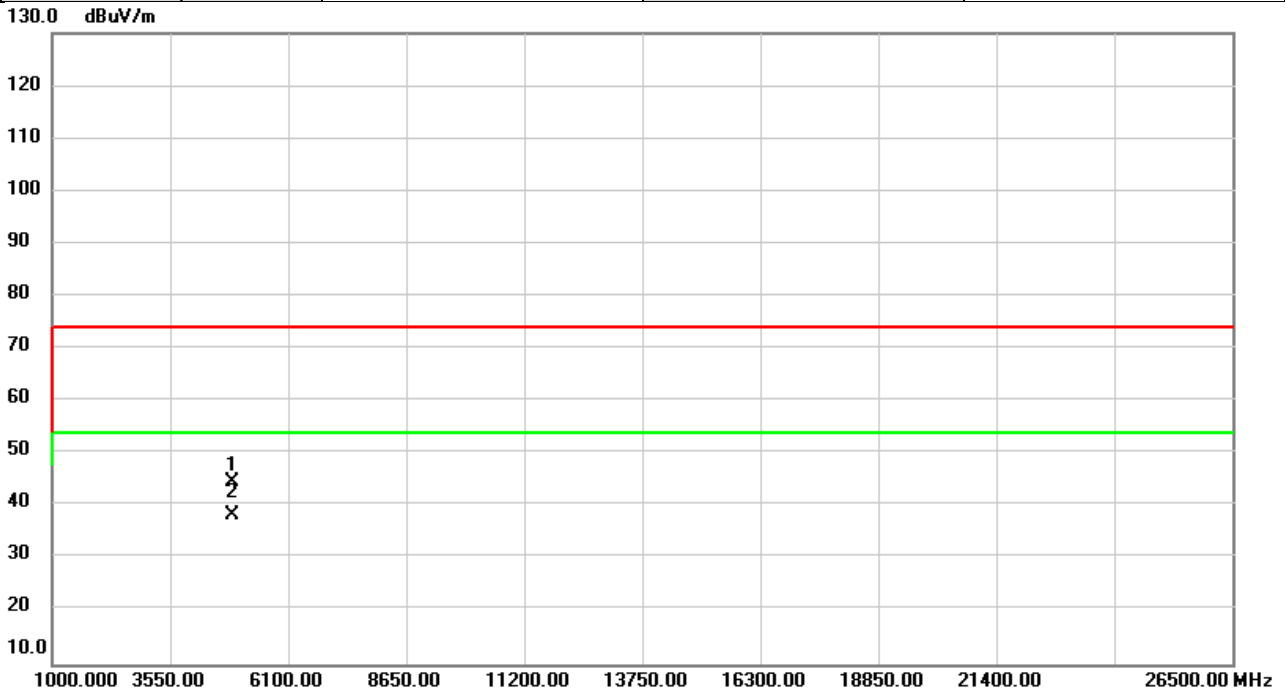

No.	Mk.	Freq. MHz	Reading Level dBuV	Correct Factor dB	Measure- ment dBuV/m	Limit dBuV/m	Over dB	Detector	Comment
1		4882.000	44.06	0.74	44.80	74.00	-29.20	peak	
2	*	4882.000	37.65	0.74	38.39	54.00	-15.61	AVG	

REMARKS:

- (1) Measurement Value = Reading Level + Correct Factor.
- (2) Margin Level = Measurement Value - Limit Value.

Test Mode	BT(1Mbps)	Test Date	2023/8/31
Test Frequency	2480MHz	Polarization	Vertical
Temp	22°C	Hum.	51%

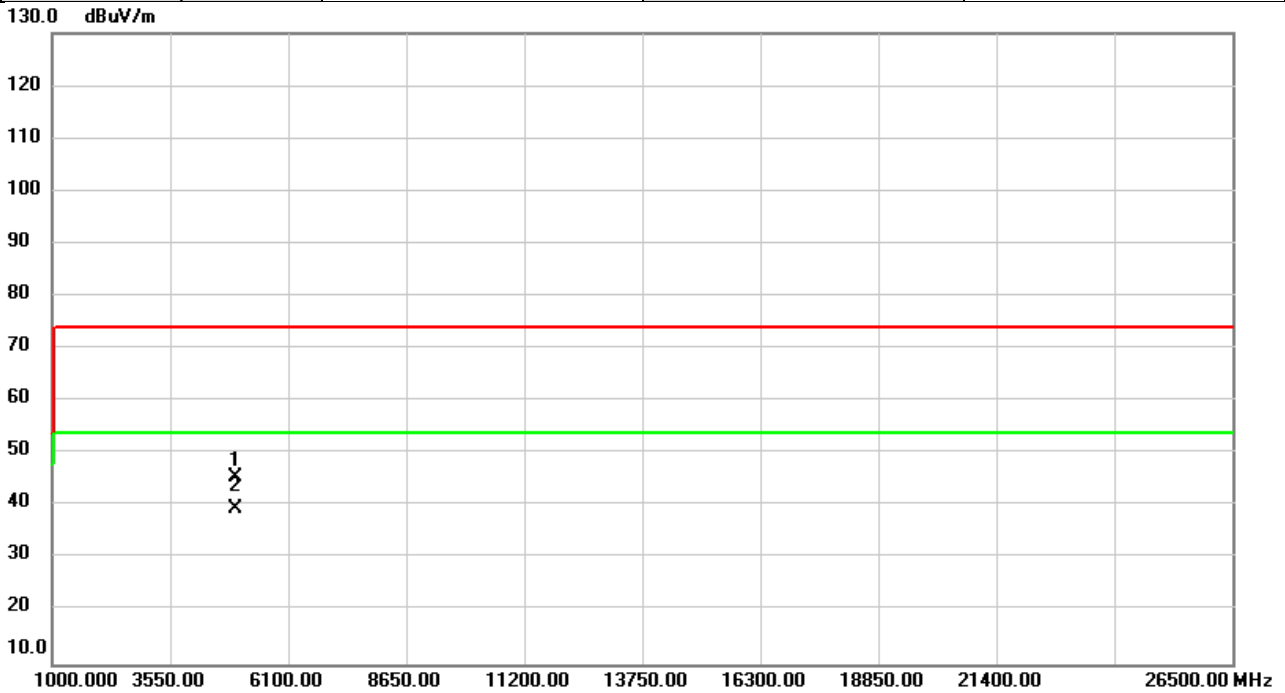

No.	Mk.	Freq. MHz	Reading Level dBuV	Correct Factor dB	Measure- ment dBuV/m	Limit dBuV/m	Over dB	Detector	Comment
1		4960.000	44.53	0.99	45.52	74.00	-28.48	peak	
2	*	4960.000	38.52	0.99	39.51	54.00	-14.49	AVG	

REMARKS:

- (1) Measurement Value = Reading Level + Correct Factor.
- (2) Margin Level = Measurement Value - Limit Value.

Test Mode	BT(1Mbps)	Test Date	2023/8/31
Test Frequency	2480MHz	Polarization	Horizontal
Temp	22°C	Hum.	51%

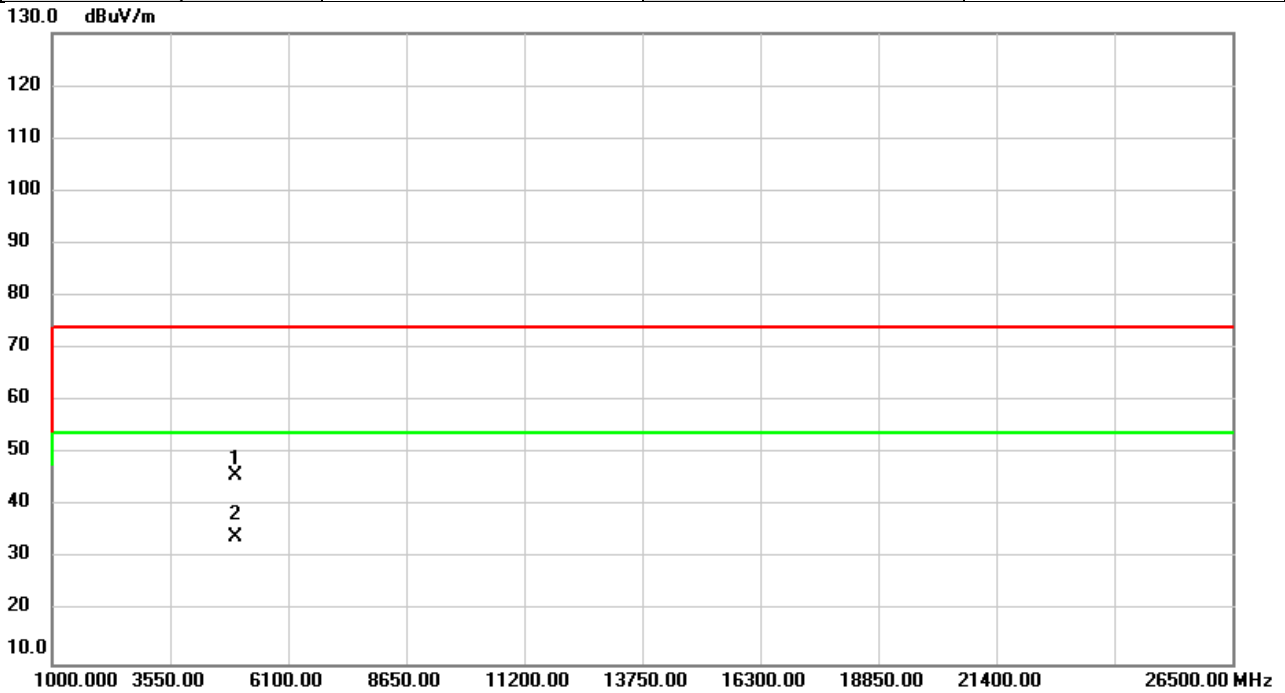

No.	Mk.	Freq. MHz	Reading Level dBuV	Correct Factor dB	Measure- ment dBuV/m	Limit dBuV/m	Over dB	Detector	Comment
1		4960.000	44.99	0.99	45.98	74.00	-28.02	peak	
2	*	4960.000	33.15	0.99	34.14	54.00	-19.86	AVG	

REMARKS:

- (1) Measurement Value = Reading Level + Correct Factor.
- (2) Margin Level = Measurement Value - Limit Value.

Test Mode	BT(3Mbps)	Test Date	2023/8/31
Test Frequency	2402 MHz	Polarization	Vertical
Temp	22°C	Hum.	51%

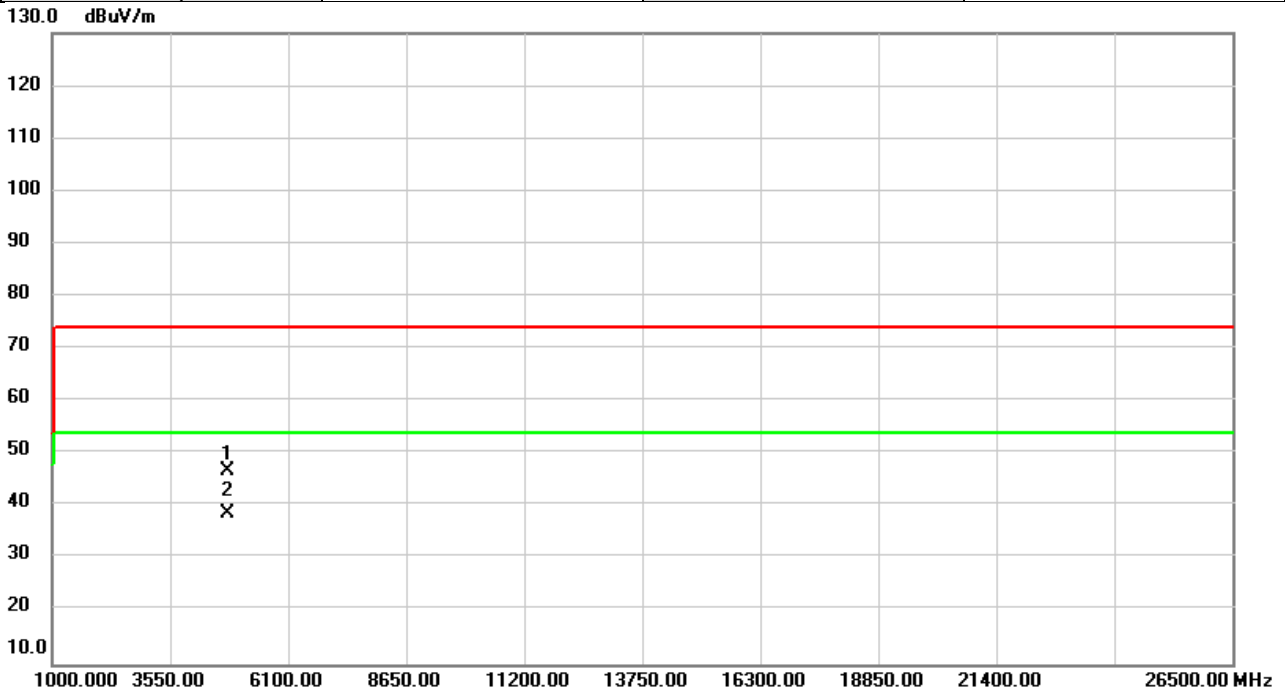

No.	Mk.	Freq. MHz	Reading Level dBuV	Correct Factor dB	Measure- ment dBuV/m	Limit dBuV/m	Over dB	Detector	Comment
1		4802.000	46.38	0.50	46.88	74.00	-27.12	peak	
2	*	4802.000	38.26	0.50	38.76	54.00	-15.24	AVG	

REMARKS:

- (1) Measurement Value = Reading Level + Correct Factor.
- (2) Margin Level = Measurement Value - Limit Value.

Test Mode	BT(3Mbps)	Test Date	2023/8/31
Test Frequency	2402 MHz	Polarization	Horizontal
Temp	22°C	Hum.	51%

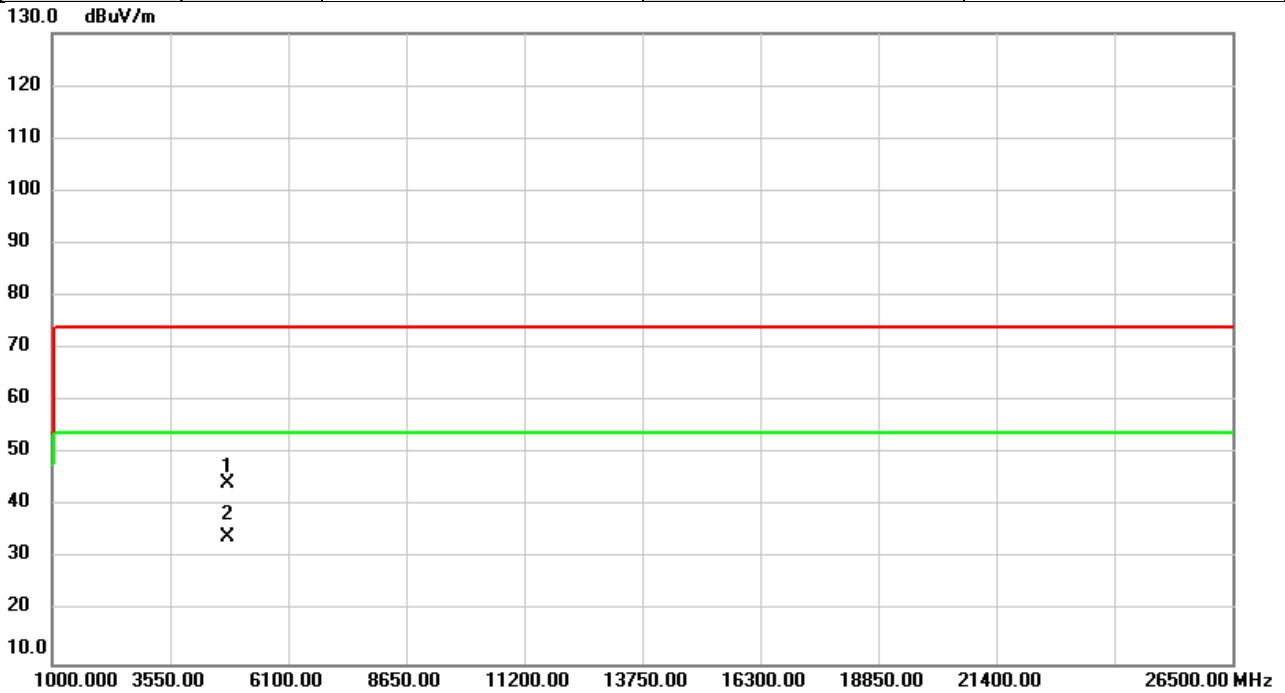

No.	Mk.	Freq. MHz	Reading Level dBuV	Correct Factor dB	Measure- ment dBuV/m	Limit dBuV/m	Over dB	Detector	Comment
1		4804.000	43.93	0.50	44.43	74.00	-29.57	peak	
2	*	4804.000	33.53	0.50	34.03	54.00	-19.97	AVG	

REMARKS:

- (1) Measurement Value = Reading Level + Correct Factor.
- (2) Margin Level = Measurement Value - Limit Value.

Test Mode	BT(3Mbps)	Test Date	2023/8/31
Test Frequency	2441 MHz	Polarization	Vertical
Temp	22°C	Hum.	51%

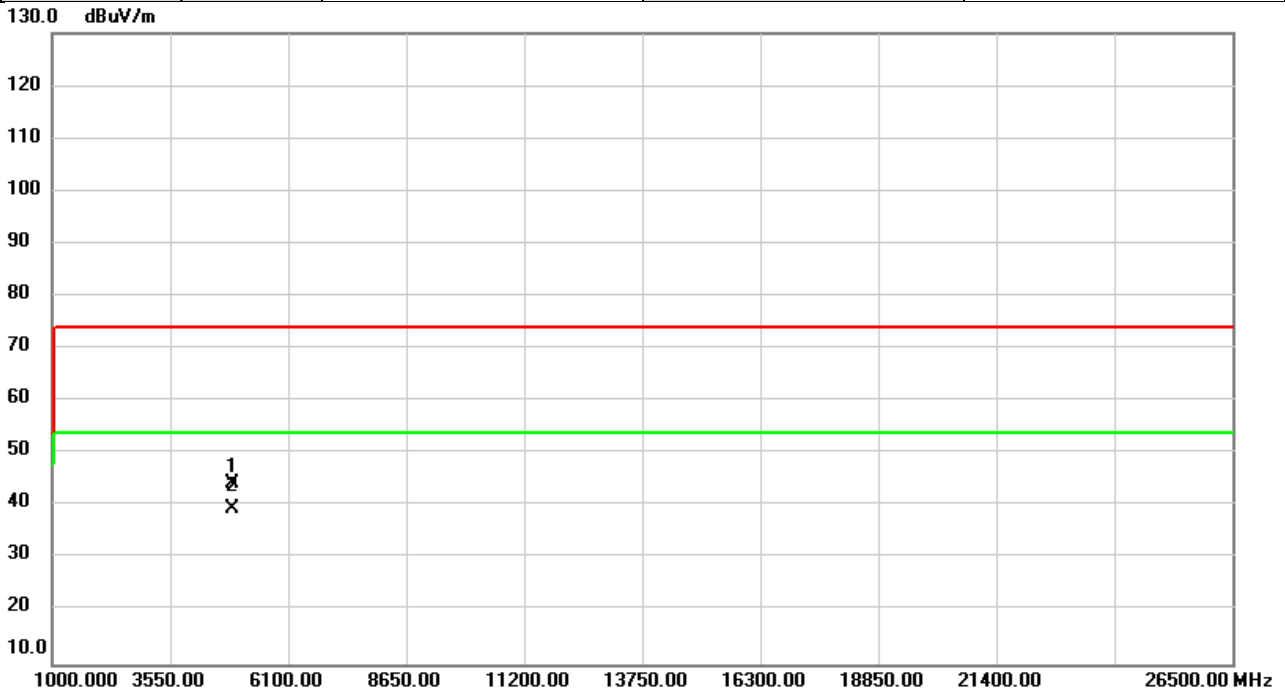

No.	Mk.	Freq. MHz	Reading Level dBuV	Correct Factor dB	Measure- ment dBuV/m	Limit dBuV/m	Over dB	Detector	Comment
1		4882.000	43.52	0.74	44.26	74.00	-29.74	peak	
2	*	4882.000	38.92	0.74	39.66	54.00	-14.34	AVG	

REMARKS:

- (1) Measurement Value = Reading Level + Correct Factor.
- (2) Margin Level = Measurement Value - Limit Value.

Test Mode	BT(3Mbps)	Test Date	2023/8/31
Test Frequency	2441 MHz	Polarization	Horizontal
Temp	22°C	Hum.	51%

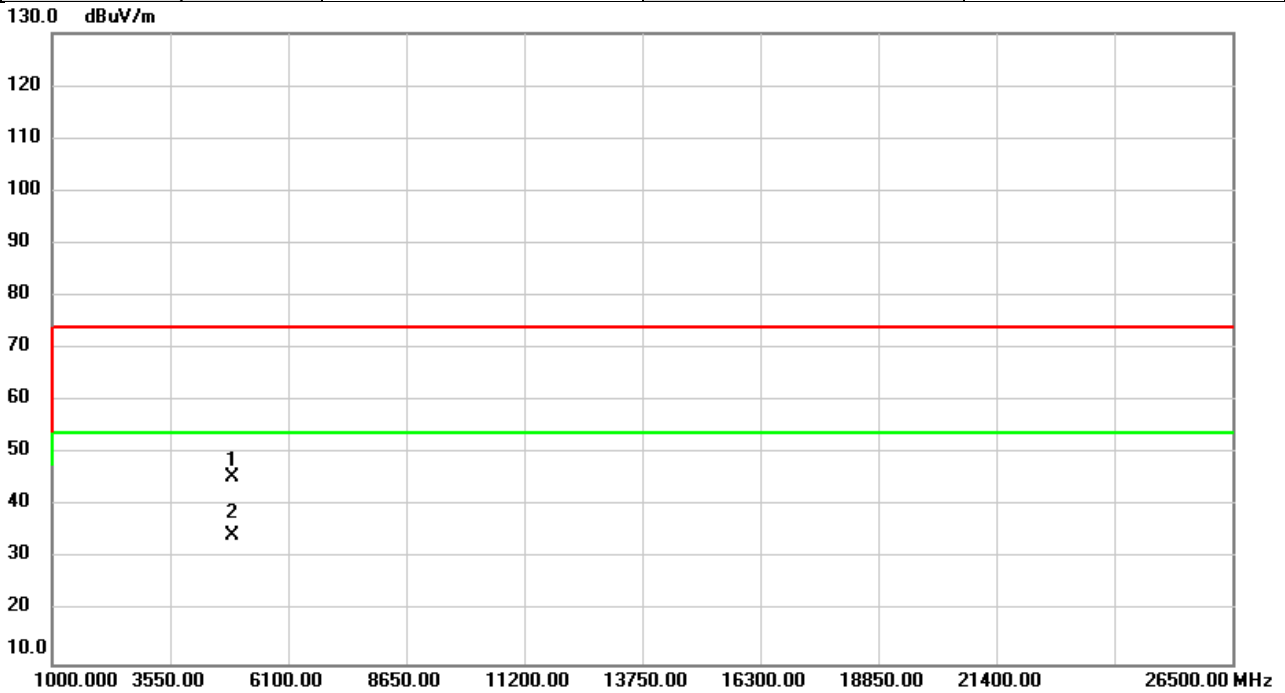

No.	Mk.	Freq. MHz	Reading Level dBuV	Correct Factor dB	Measure- ment dBuV/m	Limit dBuV/m	Over dB	Detector	Comment
1		4882.000	44.74	0.74	45.48	74.00	-28.52	peak	
2	*	4882.000	33.76	0.74	34.50	54.00	-19.50	AVG	

REMARKS:

- (1) Measurement Value = Reading Level + Correct Factor.
- (2) Margin Level = Measurement Value - Limit Value.

Test Mode	BT(3Mbps)	Test Date	2023/8/31
Test Frequency	2480 MHz	Polarization	Vertical
Temp	22°C	Hum.	51%

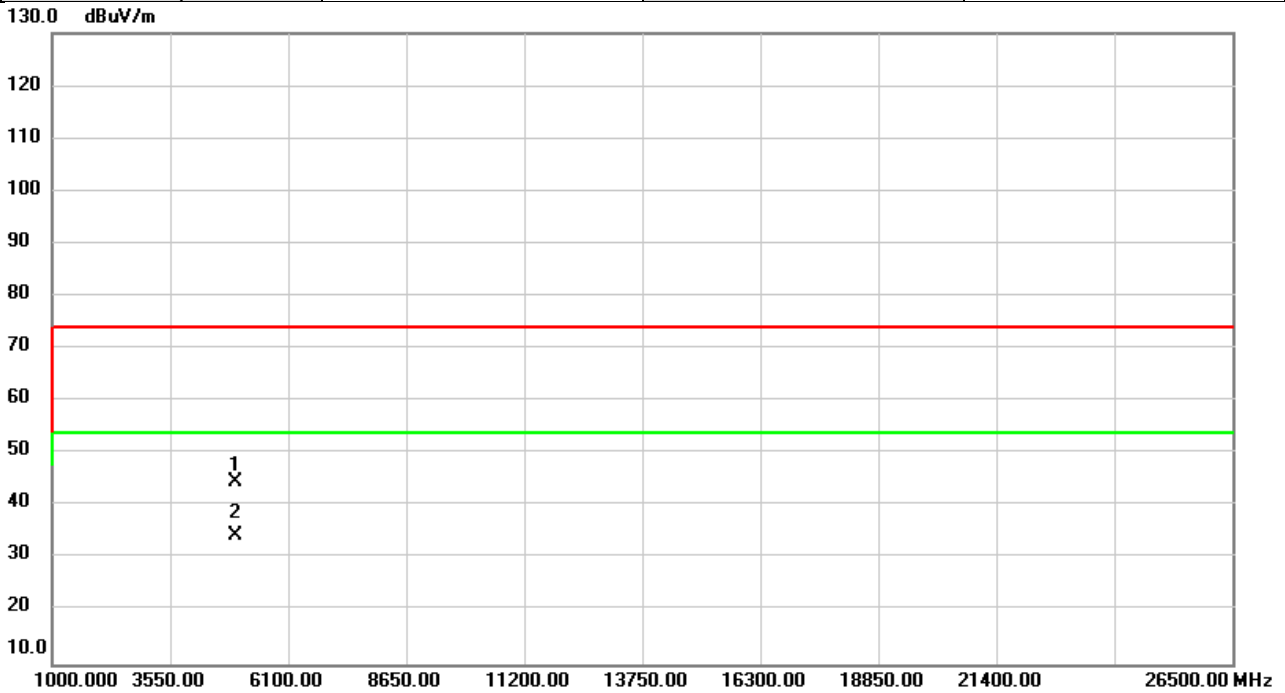

No.	Mk.	Freq. MHz	Reading Level dBuV	Correct Factor dB	Measure- ment dBuV/m	Limit dBuV/m	Over dB	Detector	Comment
1		4960.000	43.66	0.99	44.65	74.00	-29.35	peak	
2	*	4960.000	33.53	0.99	34.52	54.00	-19.48	AVG	

REMARKS:

- (1) Measurement Value = Reading Level + Correct Factor.
- (2) Margin Level = Measurement Value - Limit Value.

Test Mode	BT(3Mbps)	Test Date	2023/8/31
Test Frequency	2480 MHz	Polarization	Horizontal
Temp	22°C	Hum.	51%

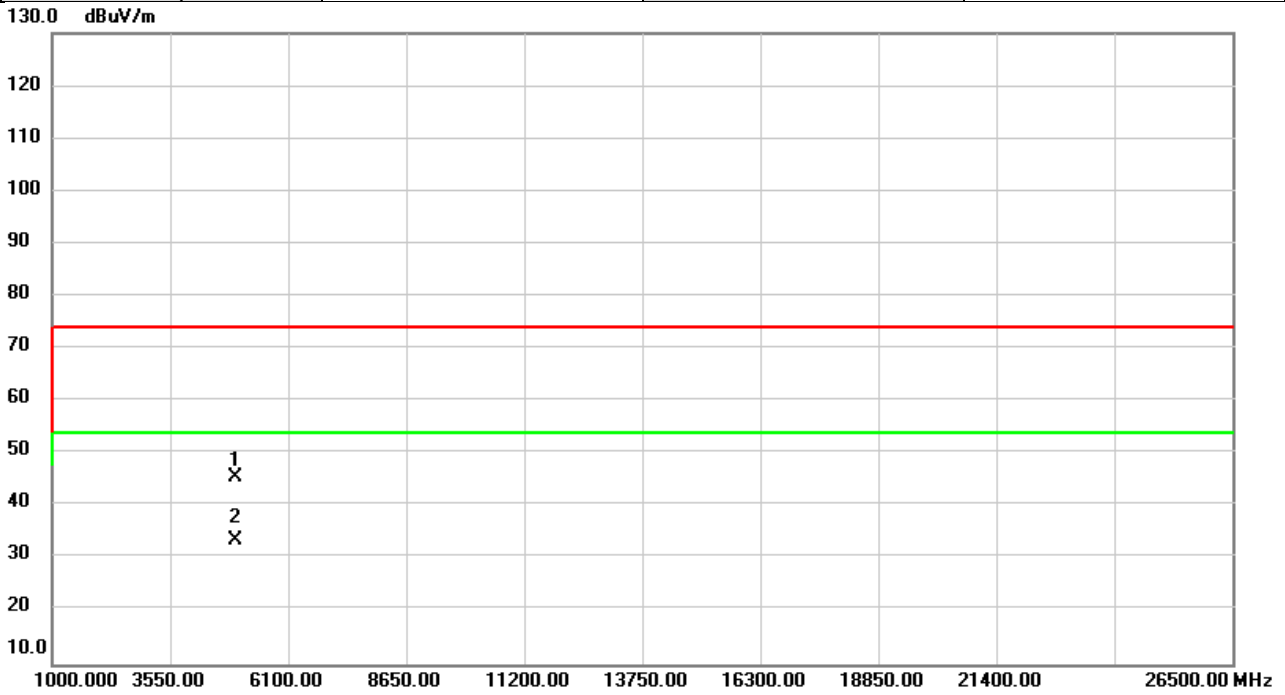

No.	Mk.	Freq. MHz	Reading Level dBuV	Correct Factor dB	Measure- ment dBuV/m	Limit dBuV/m	Over dB	Detector	Comment
1		4960.000	44.46	0.99	45.45	74.00	-28.55	peak	
2	*	4960.000	32.48	0.99	33.47	54.00	-20.53	AVG	

REMARKS:

- (1) Measurement Value = Reading Level + Correct Factor.
- (2) Margin Level = Measurement Value - Limit Value.

APPENDIX D NUMBER OF HOPPING CHANNEL

Test Mode	1/3Mbps
-----------	---------

Test Mode	Number of Hopping Channel	≥ Limit	Test Result
1 Mbps	79	15	Pass
3 Mbps	79	15	Pass

1 Mbps

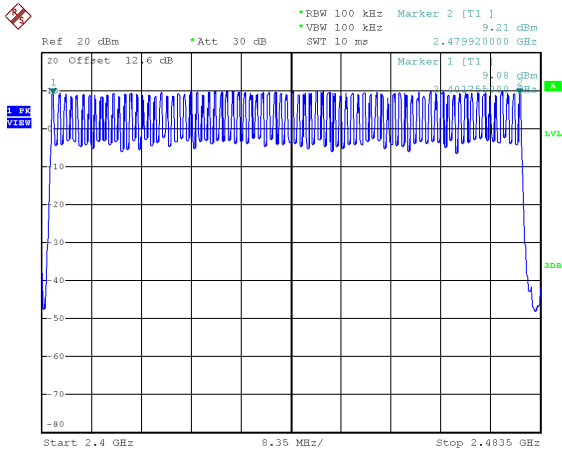

Date: 24.AUG.2023 20:14:38

3 Mbps

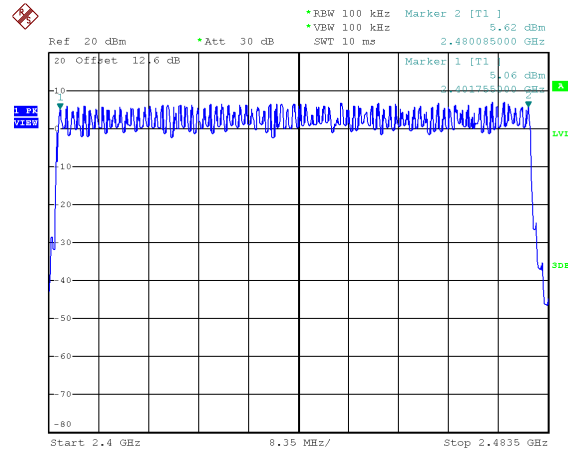

Date: 25.AUG.2023 10:21:02

APPENDIX E AVERAGE TIME OF OCCUPANCY

Test Mode : 1Mbps

Data Packet	Frequency (MHz)	Pulse Duration (ms)	Dwell Time (s)	Limits (s)	Test Result
DH5	2402	2.9200	0.3115	0.4000	Pass
DH3	2402	1.6600	0.2656	0.4000	Pass
DH1	2402	0.3850	0.1232	0.4000	Pass
DH5	2441	2.8800	0.3072	0.4000	Pass
DH3	2441	1.6400	0.2624	0.4000	Pass
DH1	2441	0.3850	0.1232	0.4000	Pass
DH5	2480	2.9200	0.3115	0.4000	Pass
DH3	2480	1.6600	0.2656	0.4000	Pass
DH1	2480	0.3850	0.1232	0.4000	Pass

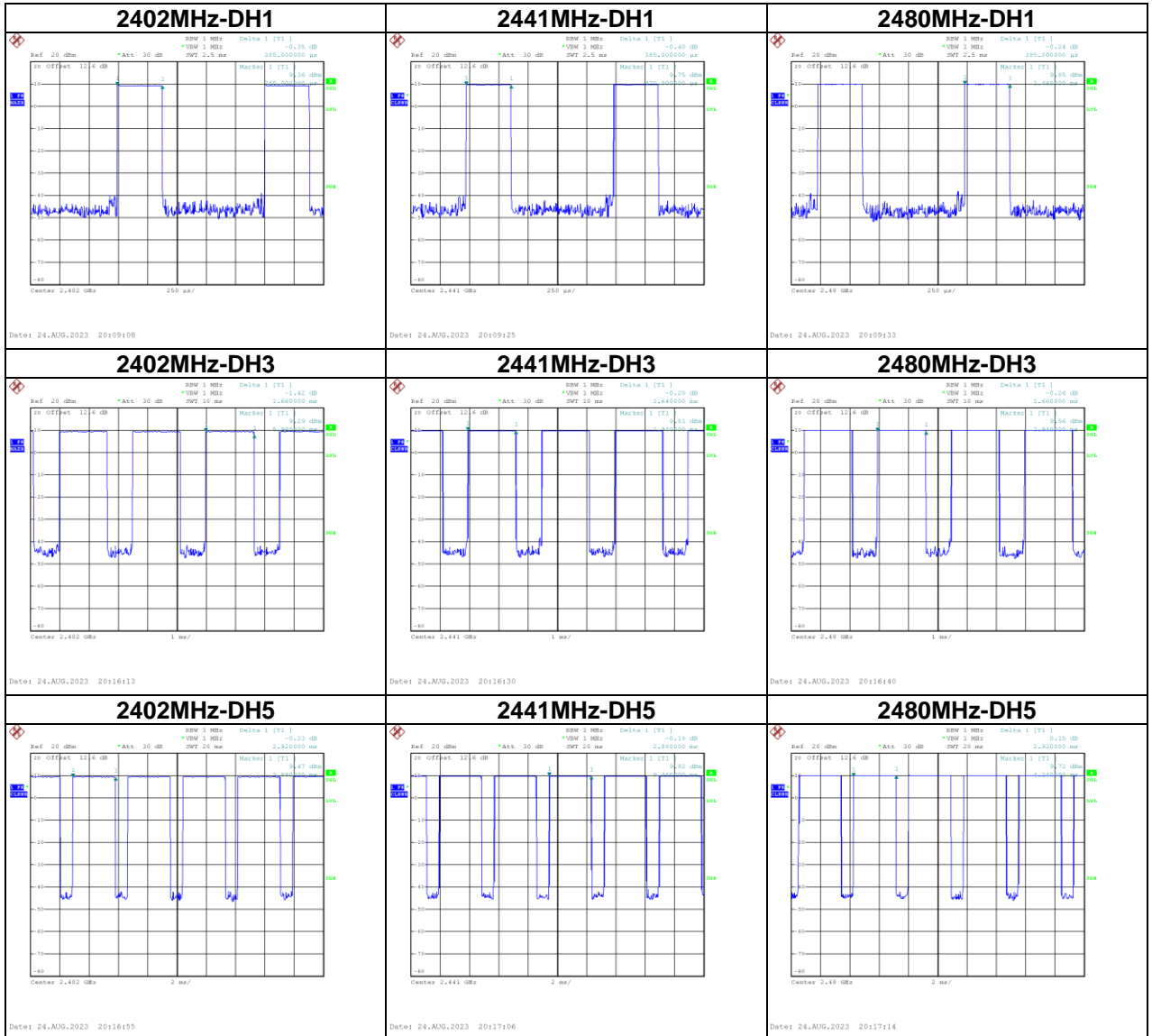

Test Mode : 3Mbps

Data Packet	Frequency	Pulse Duration(ms)	Dwell Time(s)	Limits(s)	Test Result
3DH5	2402	2.8800	0.3072	0.4000	Pass
3DH3	2402	1.6400	0.2624	0.4000	Pass
3DH1	2402	0.3900	0.1248	0.4000	Pass
3DH5	2441	2.9200	0.3115	0.4000	Pass
3DH3	2441	1.6400	0.2624	0.4000	Pass
3DH1	2441	0.3900	0.1248	0.4000	Pass
3DH5	2480	2.9200	0.3115	0.4000	Pass
3DH3	2480	1.6400	0.2624	0.4000	Pass
3DH1	2480	0.3900	0.1248	0.4000	Pass

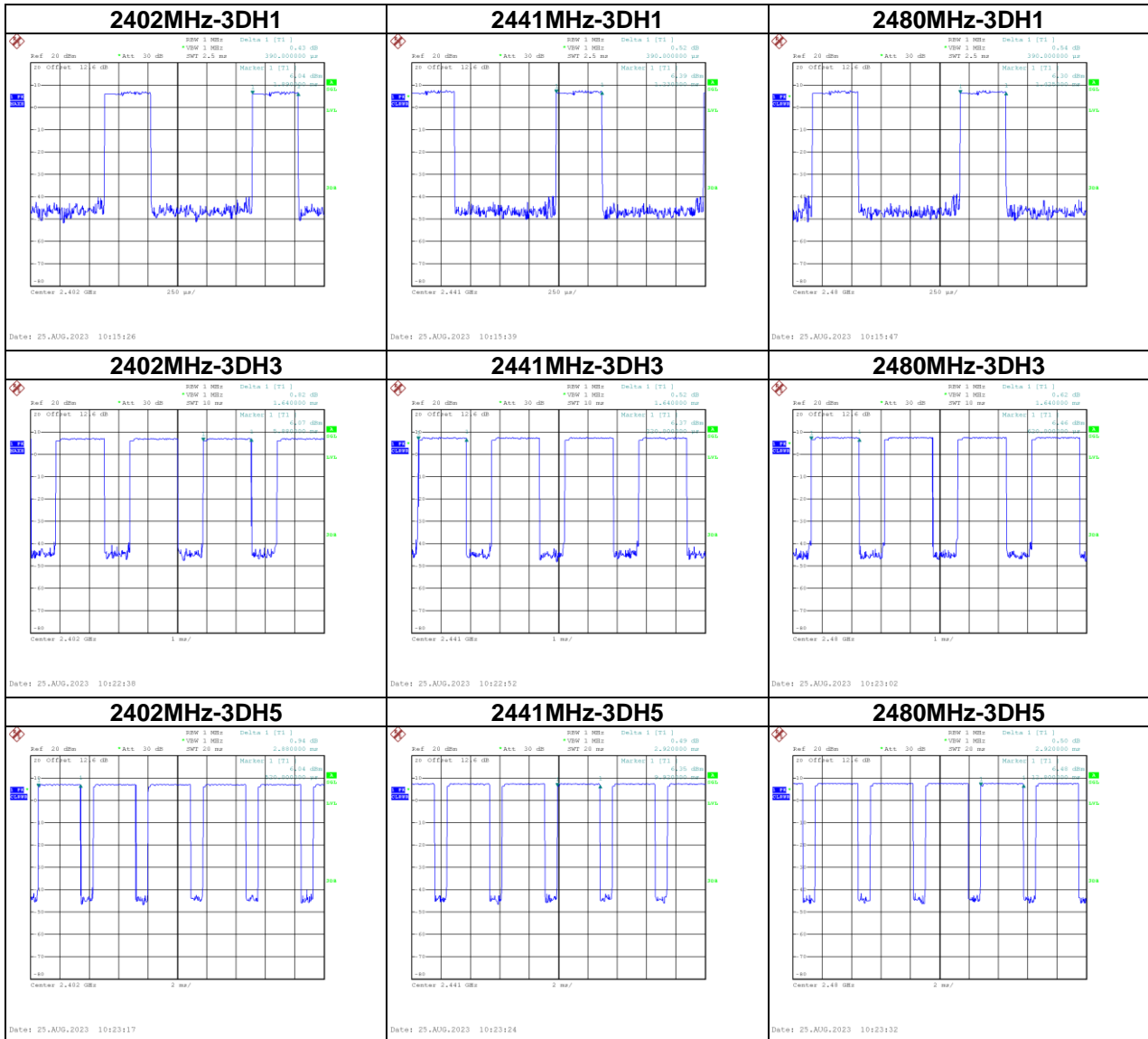

APPENDIX F HOPPING CHANNEL SEPARATION MEASUREMENT

Test Mode : Hopping on _1Mbps

Frequency (MHz)	Channel Separation (MHz)	2/3 of 20dB Bandwidth (MHz)	Test Result
2402	0.984	0.627	Pass
2441	1.016	0.627	Pass
2480	0.990	0.631	Pass

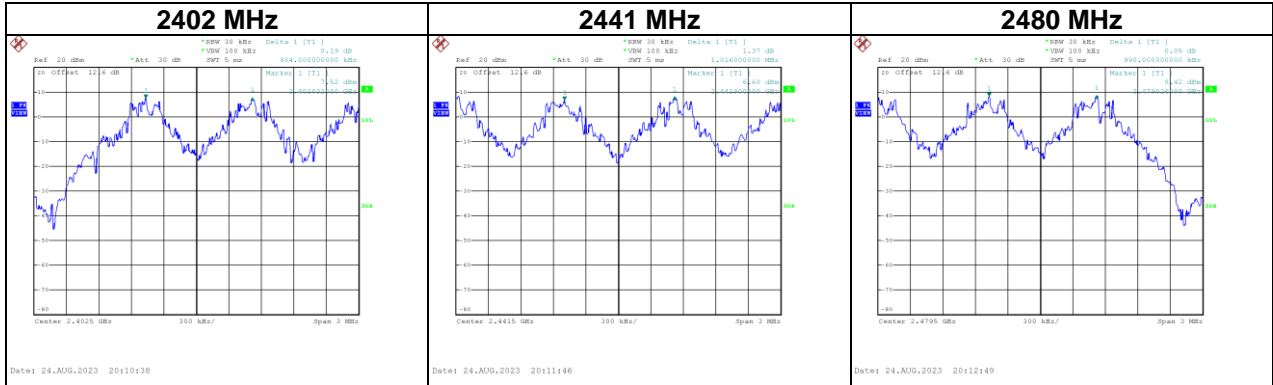

Test Mode : Hopping on _3Mbps

Frequency (MHz)	Channel Separation (MHz)	2/3 of 20dB Bandwidth (MHz)	Test Result
2402	1.197	0.947	Pass
2441	0.997	0.987	Pass
2480	1.185	1.005	Pass

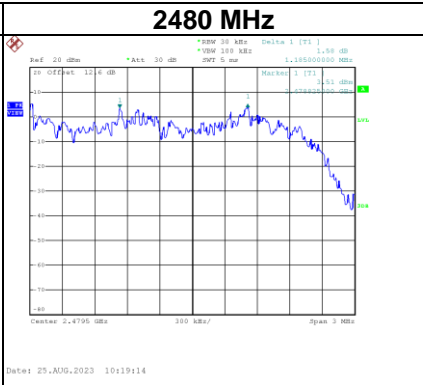
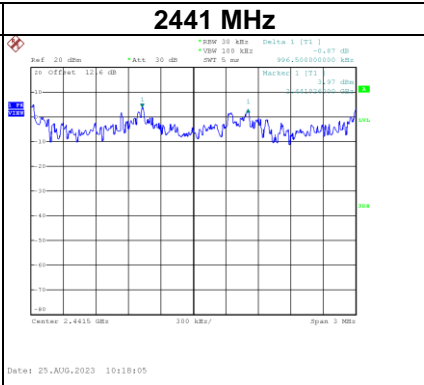
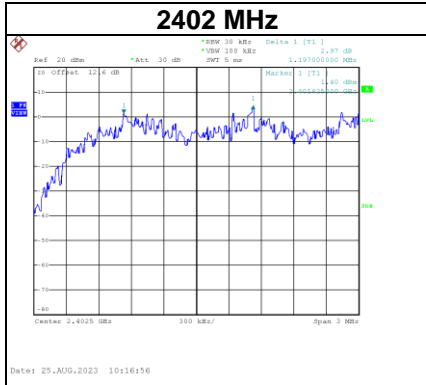

APPENDIX G BANDWIDTH

Test Mode : 1Mbps

Frequency (MHz)	20dB Bandwidth (MHz)	99% Occupied BW (MHz)	Test Result
2402	0.940	0.888	Pass
2441	0.940	0.880	Pass
2480	0.946	0.876	Pass

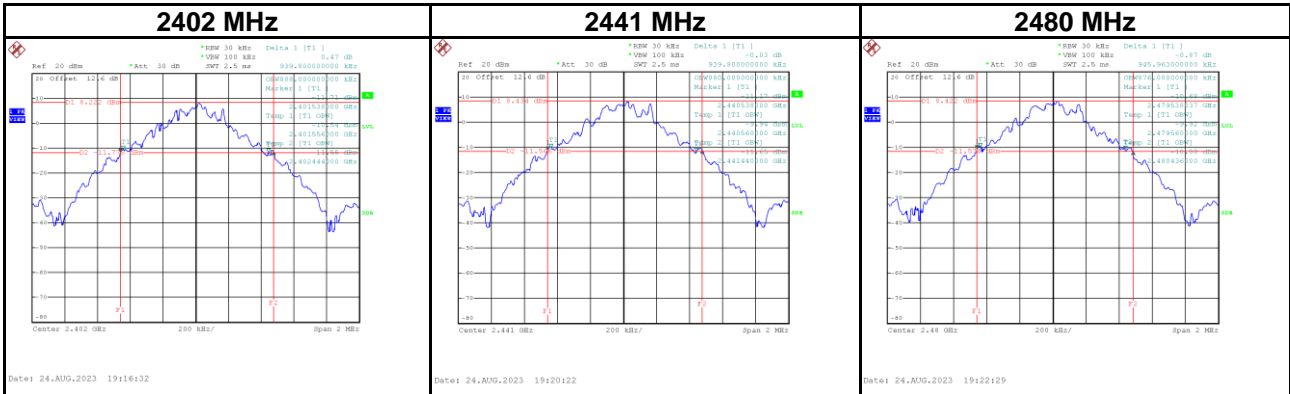

Test Mode : 3Mbps

Frequency (MHz)	20dB Bandwidth (MHz)	99% Occupied BW (MHz)	Test Result
2402	1.420	1.356	Pass
2441	1.481	1.356	Pass
2480	1.508	1.360	Pass

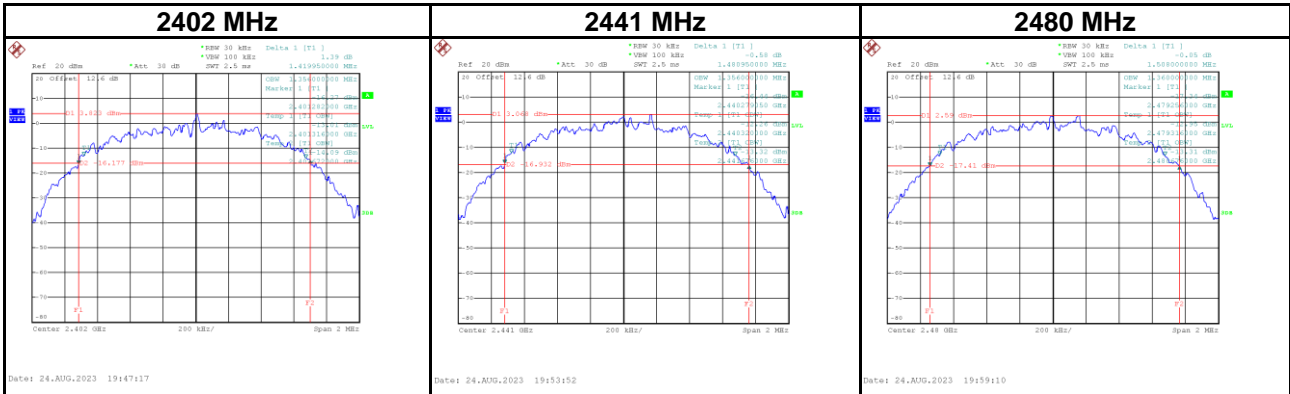

APPENDIX H OUTPUT POWER

Test Mode :	1Mbps	Tested Date	2023/9/13
-------------	-------	-------------	-----------

Frequency (MHz)	Conducted Power (dBm)	Conducted Power (W)	Max. Limit (dBm)	Max. Limit (W)	Test Result
2402	9.63	0.0092	21.00	0.1259	Pass
2441	9.61	0.0091	21.00	0.1259	Pass
2480	9.61	0.0091	21.00	0.1259	Pass

Test Mode :	2Mbps	Tested Date	2023/9/13
-------------	-------	-------------	-----------

Frequency (MHz)	Conducted Power (dBm)	Conducted Power (W)	Max. Limit (dBm)	Max. Limit (W)	Test Result
2402	7.57	0.0057	21.00	0.1259	Pass
2441	7.53	0.0057	21.00	0.1259	Pass
2480	7.64	0.0058	21.00	0.1259	Pass

Test Mode :	3Mbps	Tested Date	2023/9/13
-------------	-------	-------------	-----------

Frequency (MHz)	Conducted Power (dBm)	Conducted Power (W)	Max. Limit (dBm)	Max. Limit (W)	Test Result
2402	7.67	0.0058	21.00	0.1259	Pass
2441	7.65	0.0058	21.00	0.1259	Pass
2480	7.76	0.0060	21.00	0.1259	Pass

APPENDIX I ANTENNA CONDUCTED SPURIOUS EMISSION

Test Mode | 1Mbps

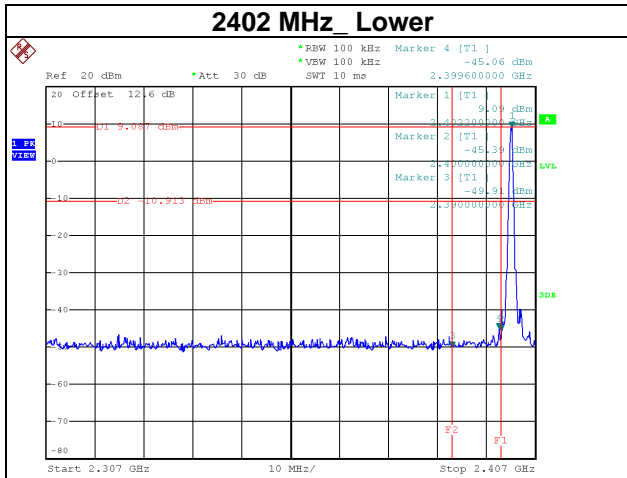

Date: 24.AUG.2023 19:15:48

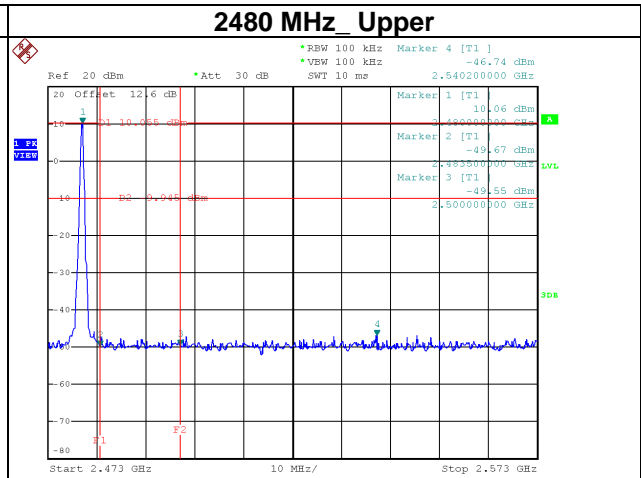

Date: 24.AUG.2023 19:21:43

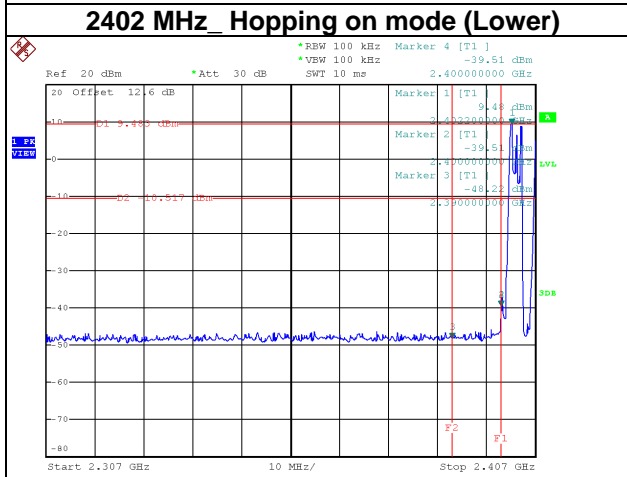

Date: 24.AUG.2023 20:15:12

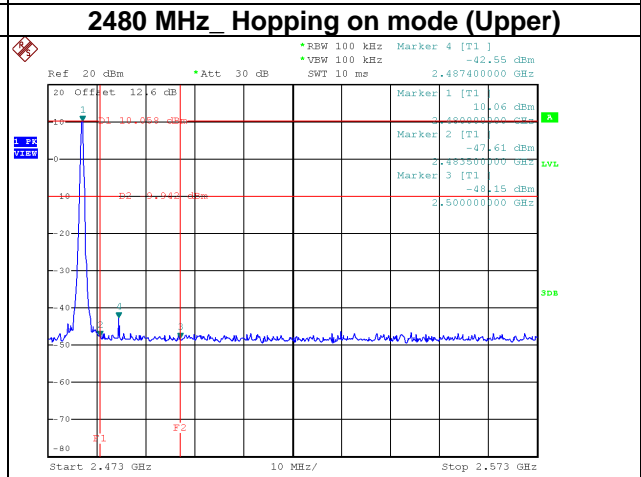

Date: 24.AUG.2023 20:15:46

2402 MHz – 10th Harmonics

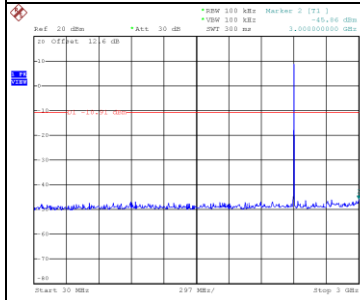

Date: 24.AUG.2023 19:16:45

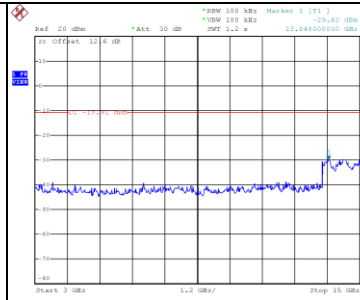

Date: 24.AUG.2023 19:16:52

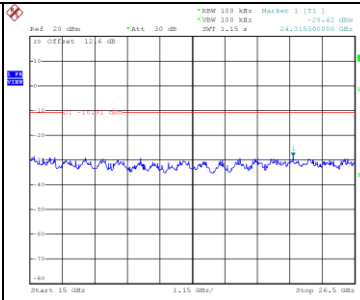

Date: 24.AUG.2023 19:16:59

2441 MHz – 10th Harmonics

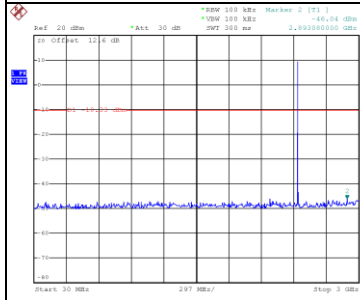

Date: 24.AUG.2023 19:19:30

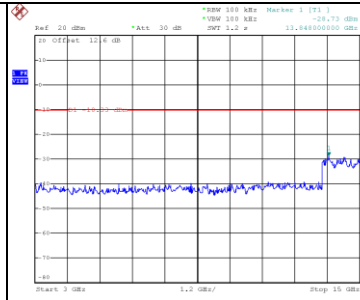

Date: 24.AUG.2023 19:19:37

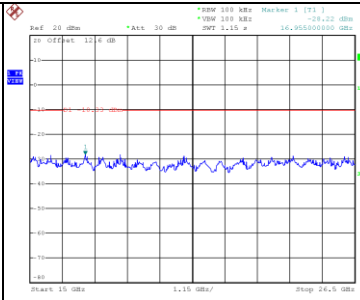

Date: 24.AUG.2023 19:19:44

2480 MHz – 10th Harmonics

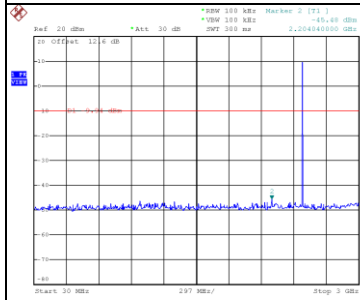

Date: 24.AUG.2023 19:22:42

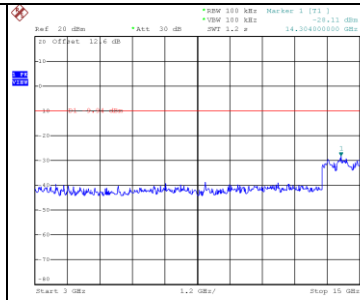

Date: 24.AUG.2023 19:22:49

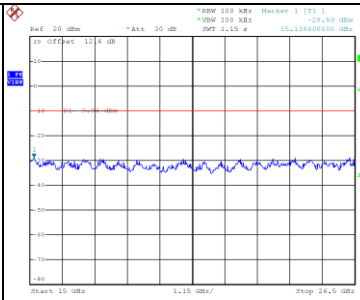

Date: 24.AUG.2023 19:22:56

Test Mode 3Mbps

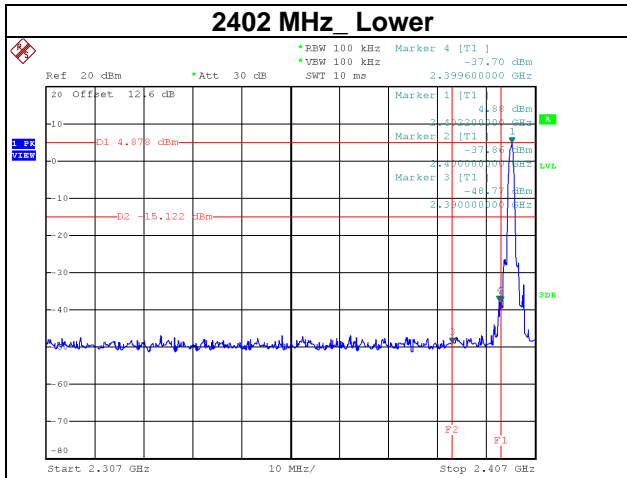

Date: 24.AUG.2023 19:46:52

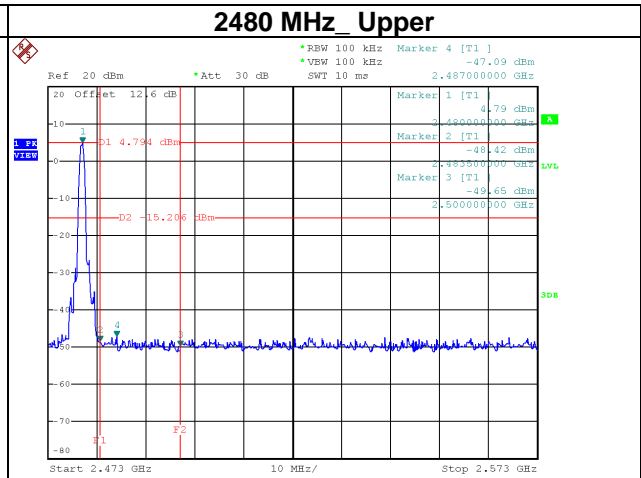

Date: 24.AUG.2023 19:58:50

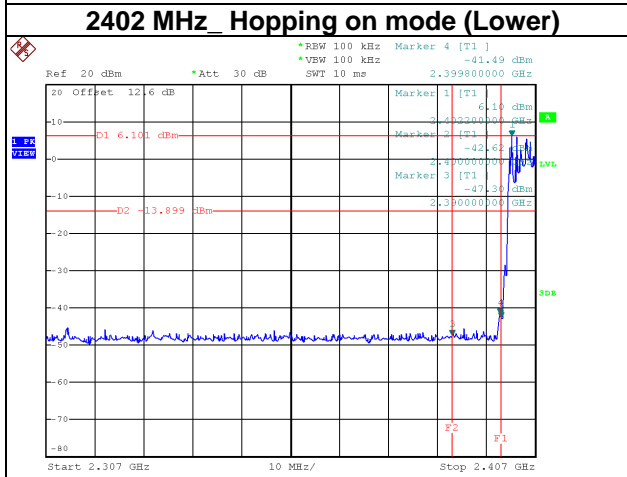

Date: 25.AUG.2023 10:21:37

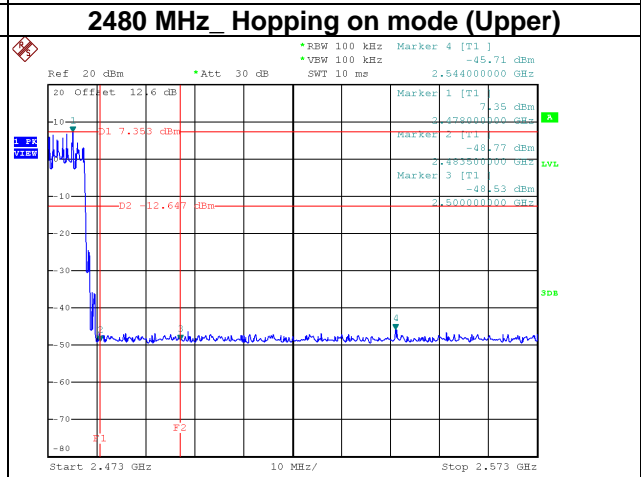

Date: 25.AUG.2023 10:22:11

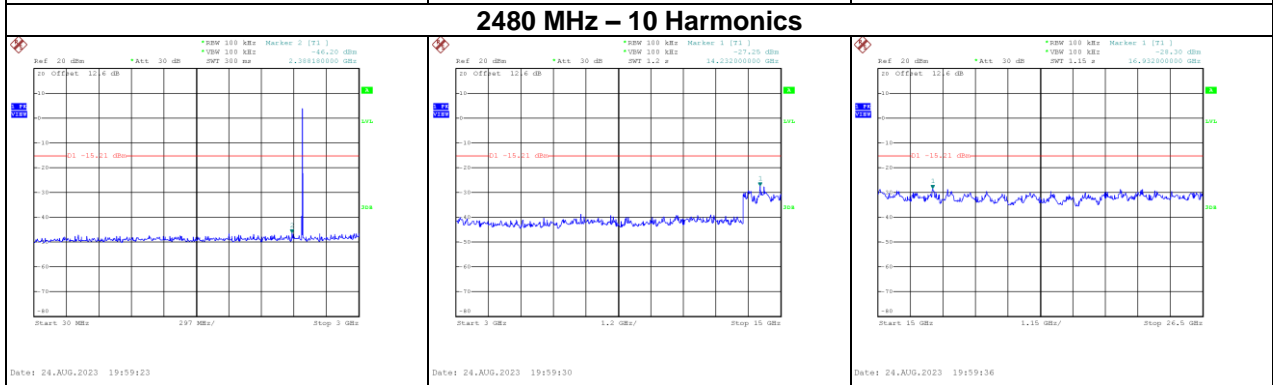
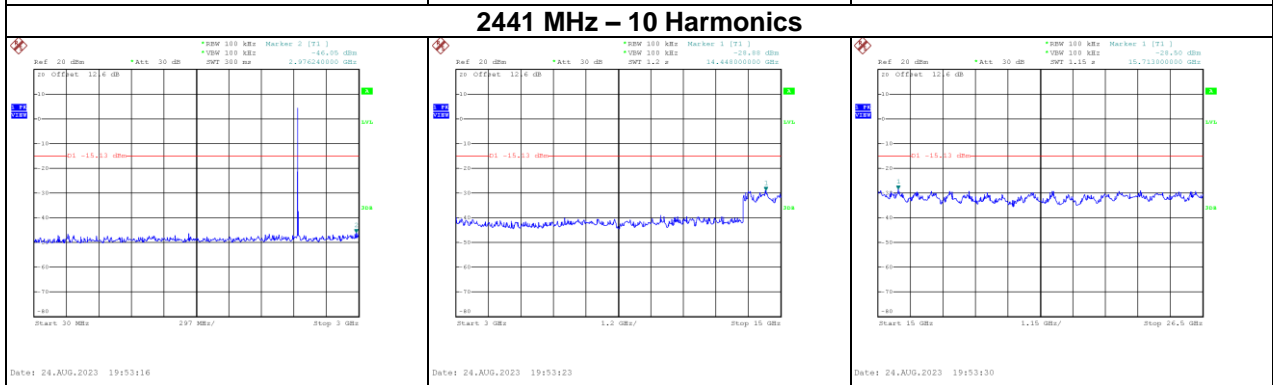
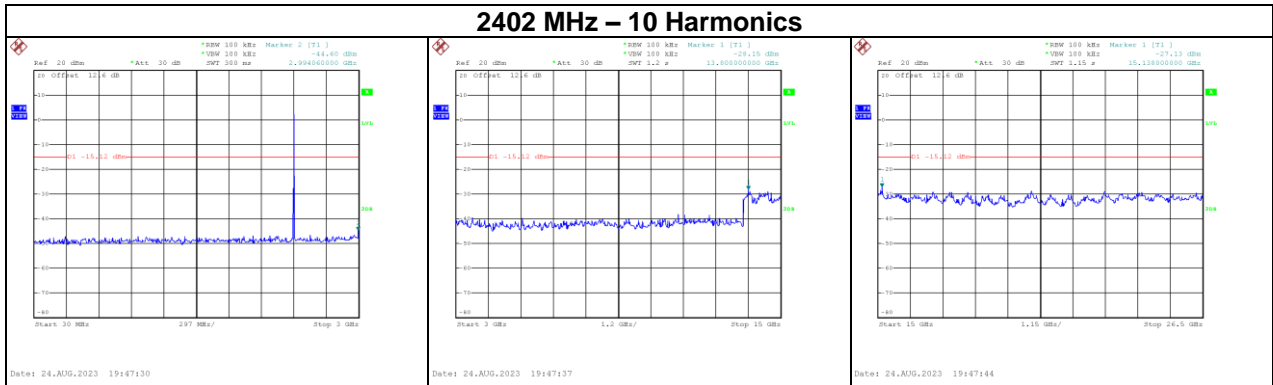

End of Test Report