



# PCTEST ENGINEERING LABORATORY, INC.

6660-B Dobbin Road, Columbia, MD 21045 USA  
Tel. 410.290.6652 / Fax 410.290.6554  
<http://www.pctestlab.com>



## SAR COMPLIANCE EVALUATION REPORT

**Applicant Name:**  
LG Electronics USA  
1000 Sylvan Avenue  
Englewood Cliffs, NJ 07632  
United States

**Date of Testing:**  
12/17/09 - 12/22/09  
**Test Site/Location:**  
PCTEST Lab, Columbia, MD, USA  
**Test Report Serial No.:**  
0912182291.BEJ

**FCC ID:** BEJMN240

**APPLICANT:** LG ELECTRONICS USA

**EUT Type:** Cellular/AWS/PCS CDMA Phone w/ BT  
**Application Type:** Certification  
**FCC Rule Part(s):** CFR §2.1093; FCC/OET Bulletin 65 Supplement C [July 2001]  
**FCC Classification:** Licensed Transmitter Held to Ear (PCE)  
**Model(s):** MN240, LW240  
**Tx Frequency:** 824.70 - 848.31 MHz (Cellular CDMA)  
1711.25 - 1753.75 MHz (AWS CDMA)  
1851.25 - 1908.75 MHz (PCS CDMA)  
**Conducted Power:** 25.2 dBm Cell. CDMA  
25.34 dBm AWS CDMA  
25.22 dBm PCS CDMA  
**Max. SAR Measurement:** 1.22 W/kg Cell. CDMA Head SAR  
0.66 W/kg Cell. CDMA Body SAR  
0.7 W/kg AWS CDMA Head SAR  
0.71 W/kg AWS CDMA Body SAR  
0.55 W/kg PCS CDMA Head SAR  
0.47 W/kg PCS CDMA Body SAR  
**Test Device Serial No.:** Pre-Production [S/N: SAR #1, RF]



This wireless portable device has been shown to be capable of compliance for localized specific absorption rate (SAR) for uncontrolled environment/general population exposure limits specified in ANSI/IEEE C95.1-1992 and has been tested in accordance with the measurement procedures specified in FCC/OET Bulletin 65 Supplement C (2001), IEEE 1528-2003 and in applicable Industry Canada Radio Standards Specifications (RSS); for North American frequency bands only.

I attest to the accuracy of data. All measurements reported herein were performed by me or were made under my supervision and are correct to the best of my knowledge and belief. I assume full responsibility for the completeness of these measurements and vouch for the qualifications of all persons taking them. Test results reported herein relate only to the item(s) tested.

*PCTEST certifies that no party to this application has been denied the FCC benefits pursuant to Section 5301 of the Anti-Drug Abuse Act of 1988, 21 U.S.C. 862.*

  
Randy Ortanez  
President





FCC ID: BEJMN240		SAR COMPLIANCE REPORT		Reviewed by: Quality Manager
Filename: 0912182291.BEJ	Test Dates: 12/17/09 - 12/22/09	EUT Type: Cellular/AWS/PCS CDMA Phone w/ BT		Page 1 of 34

# T A B L E O F C O N T E N T S

---

1	INTRODUCTION .....	3
2	TEST SITE LOCATION .....	4
3	SAR MEASUREMENT SETUP .....	5
4	DASY E-FIELD PROBE SYSTEM .....	7
5	PROBE CALIBRATION PROCESS .....	8
6	PHANTOM AND EQUIVALENT TISSUES.....	9
7	DOSIMETRIC ASSESSMENT & PHANTOM SPECS.....	10
8	DEFINITION OF REFERENCE POINTS .....	11
9	TEST CONFIGURATION POSITIONS .....	12
10	RF EXPOSURE LIMITS .....	15
11	MEASUREMENT UNCERTAINTIES .....	16
12	SYSTEM VERIFICATION.....	17
13	FCC MULTI-TX AND ANTENNA SAR CONSIDERATIONS.....	19
14	FCC 3G MEASUREMENT PROCEDURES.....	20
15	SAR DATA SUMMARY .....	22
16	EQUIPMENT LIST.....	26
17	CONCLUSION.....	27
18	REFERENCES .....	28
19	SAR TEST SETUP PHOTOGRAPHS.....	30

<b>FCC ID:</b> BEJMN240	 <b>PCTEST</b> <small>ENGINEERING LABORATORY, INC.</small>	<b>SAR COMPLIANCE REPORT</b>	 <b>LG</b>	<b>Reviewed by:</b> Quality Manager
<b>Filename:</b> 0912182291.BEJ	<b>Test Dates:</b> 12/17/09 - 12/22/09	<b>EUT Type:</b> Cellular/AWS/PCS CDMA Phone w/ BT		Page 2 of 34

# 1 INTRODUCTION

The FCC has adopted the guidelines for evaluating the environmental effects of radio frequency (RF) radiation in ET Docket 93-62 on Aug. 6, 1996 to protect the public and workers from the potential hazards of RF emissions due to FCC-regulated portable devices.[1]

The safety limits used for the environmental evaluation measurements are based on the criteria published by the American National Standards Institute (ANSI) for localized specific absorption rate (SAR) in IEEE/ANSI C95.1-1992 Standard for Safety Levels with Respect to Human Exposure to Radio Frequency Electromagnetic Fields, 3 kHz to 300 GHz[2] and Health Canada RF Exposure Guidelines Safety Code 6 [26]. The measurement procedure described in IEEE/ANSI C95.3-2002 Recommended Practice for the Measurement of Potentially Hazardous Electromagnetic Fields - RF and Microwave [3] is used for guidance in measuring the Specific Absorption Rate (SAR) due to the RF radiation exposure from the Equipment Under Test (EUT). These criteria for SAR evaluation are similar to those recommended by the International Committee for Non-Ionizing Radiation Protection (ICNIRP) in "Biological Effects and Exposure Criteria for Radiofrequency Electromagnetic Fields," Report No. Vol 74. SAR is a measure of the rate of energy absorption due to exposure to an RF transmitting source. SAR values have been related to threshold levels for potential biological hazards.

## 1.1 SAR Definition

Specific Absorption Rate is defined as the time derivative (rate) of the incremental energy (dU) absorbed by (dissipated in) an incremental mass (dm) contained in a volume element (dV) of a given density (ρ). It is also defined as the rate of RF energy absorption per unit mass at a point in an absorbing body (see Fig. 1-1).

$$SAR = \frac{d}{dt} \left( \frac{dU}{dm} \right) = \frac{d}{dt} \left( \frac{dU}{\rho dv} \right)$$

Figure 1-1  
SAR Mathematical Equation



SAR is expressed in units of Watts per Kilogram (W/kg).

$$SAR = \frac{\sigma \cdot E^2}{\rho}$$

where:

- σ = conductivity of the tissue-simulating material (S/m)
- ρ = mass density of the tissue-simulating material (kg/m<sup>3</sup>)
- E = Total RMS electric field strength (V/m)

NOTE: The primary factors that control rate of energy absorption were found to be the wavelength of the incident field in relation to the dimensions and geometry of the irradiated organism, the orientation of the organism in relation to the polarity of field vectors, the presence of reflecting surfaces, and whether conductive contact is made by the organism with a ground plane.[6]

FCC ID: BEJMN240	 PCTEST ENGINEERING LABORATORY, INC.	SAR COMPLIANCE REPORT	 LG	Reviewed by: Quality Manager
Filename: 0912182291.BEJ	Test Dates: 12/17/09 - 12/22/09	EUT Type: Cellular/AWS/PCS CDMA Phone w/ BT		Page 3 of 34

## 2 TEST SITE LOCATION

### 2.1 INTRODUCTION

The map at the right shows the location of the PCTEST LABORATORY in Columbia, Maryland. It is in proximity to the FCC Laboratory, the Baltimore-Washington International (BWI) airport, the city of Baltimore and Washington, DC (See Figure 2).

These measurement tests were conducted at the PCTEST Engineering Laboratory, Inc. facility in New Concept Business Park, Guilford Industrial Park, Columbia, Maryland. The site address is 6660-B Dobbin Road, Columbia, MD 21045. The test site is one of the highest points in the Columbia area with an elevation of 390 feet above mean sea level. The site coordinates are 39° 11'15" N latitude and 76° 49' 38" W longitude. The facility is 1.5 miles north of the FCC laboratory, and the ambient signal and ambient signal strength are approximately equal to those of the FCC laboratory. There are no FM or TV transmitters within 15 miles of the site. The detailed description of the measurement facility was found to be in compliance with the requirements of § 2.948 according to ANSI C63.4 on January 27, 2006 and Industry Canada.

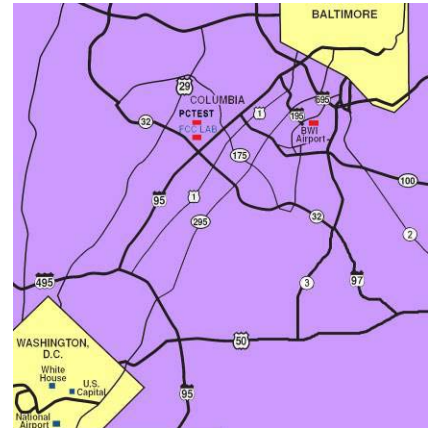



**Figure 2-1**  
Map of the Greater Baltimore and Metropolitan Washington, D.C. area

### 2.2 Test Facility / Accreditations:

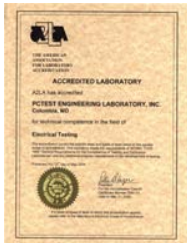
Measurements were performed at an independent accredited PCTEST Engineering Lab located in Columbia, MD 21045, U.S.A.



- PCTEST Lab is accredited to ISO 17025-2005 by the American Association for Laboratory Accreditation (A2LA) in Specific Absorption Rate (SAR) testing, Hearing-Aid Compatibility (HAC), CTIA Test Plans, and wireless testing for FCC and Industry Canada Rules.
- PCTEST Lab is accredited to ISO 17025 by U.S. National Institute of Standards and Technology (NIST) under the National Voluntary Laboratory Accreditation Program (NVLAP Lab code: 100431-0) in EMC, FCC and Telecommunications.
- PCTEST facility is an FCC registered (PCTEST Reg. No. 90864) test facility with the site description report on file and has met all the requirements specified in Section 2.948 of the FCC Rules and Industry Canada (IC-2451).
- PCTEST Lab is a recognized U.S. Conformity Assessment Body (CAB) in EMC and R&TTE (n.b. 0982) under the U.S.-EU Mutual Recognition Agreement (MRA).
- PCTEST TCB is a Telecommunication Certification Body (TCB) accredited to ISO/IEC Guide 65 by the American National Standards Institute (ANSI) in all scopes of FCC Rules and all Industry Canada Standards (RSS).
- PCTEST facility is an IC registered (IC-2451) test laboratory with the site description on file at Industry Canada.
- PCTEST is a CTIA Authorized Test Laboratory (CATL) for AMPS and CDMA, and EvDO mobile phones.
- PCTEST is a CTIA Authorized Test Laboratory (CATL) for Over-the-Air (OTA) Antenna Performance testing for AMPS, CDMA, GSM, GPRS, EGPRS, UMTS (W-CDMA), CDMA 1xEVDO Data, CDMA 1xRTT Data

FCC ID: BEJMN240	 PCTEST ENGINEERING LABORATORY, INC.	SAR COMPLIANCE REPORT	 LG	Reviewed by: Quality Manager
Filename: 0912182291.BEJ	Test Dates: 12/17/09 - 12/22/09	EUT Type: Cellular/AWS/PCS CDMA Phone w/ BT	Page 4 of 34	

## 3 SAR MEASUREMENT SETUP

### 3.1 Robotic System

Measurements are performed using the DASY4 automated dosimetric assessment system. The DASY4 is made by Schmid & Partner Engineering AG (SPEAG) in Zurich, Switzerland and consists of high precision robotics system (Staubli), robot controller, Pentium 4 computer, near-field probe, probe alignment sensor, and the generic twin phantom containing the brain equivalent material. The robot is a six-axis industrial robot performing precise movements to position the probe to the location (points) of maximum electromagnetic field (EMF) (see Figure 3-1).

### 3.2 System Hardware

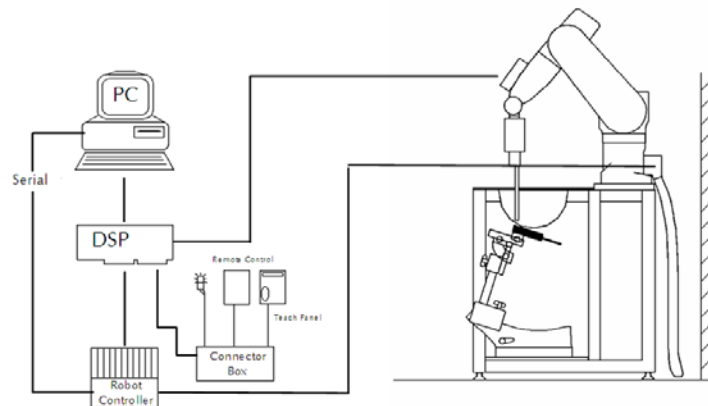

A cell controller system contains the power supply, robot controller, teach pendant (Joystick), and a remote control used to drive the robot motors. The PC consists of the Gateway Pentium 4 2.53 GHz computer with Windows XP system and SAR Measurement Software DASY4, A/D interface card, monitor, mouse, and keyboard. The Staubli Robot is connected to the cell controller to allow software manipulation of the robot. A data acquisition electronic (DAE) circuit that performs the signal amplification, signal multiplexing, AD-conversion, offset measurements, mechanical surface detection, collision detection, etc. is connected to the Electro-optical coupler (EOC). The EOC performs the conversion from the optical into digital electric signal of the DAE and transfers data to the PC plug-in card.

### 3.3 System Electronics



**Figure 3-1**  
**SAR Measurement System Setup**

The DAE4 consists of a highly sensitive electrometer-grade preamplifier with auto-zeroing, a channel and gain-switching multiplexer, a fast 16 bit AD-converter and a command decoder and control logic unit. Transmission to the PC-card is accomplished through an optical downlink for data and status information and an optical uplink for commands and clock lines. The mechanical probe mounting device includes two different sensor systems for frontal and sidewise probe contacts. They are also used for mechanical surface detection and probe collision detection. The robot uses its own controller with a built in VME-bus computer. The system is described in detail in [7].

FCC ID: BEJMN240	 PCTEST ENGINEERING LABORATORY, INC.	SAR COMPLIANCE REPORT		Reviewed by: Quality Manager
Filename: 0912182291.BEJ	Test Dates: 12/17/09 - 12/22/09	EUT Type: Cellular/AWS/PCS CDMA Phone w/ BT		Page 5 of 34

### 3.4 Automated Test System Specifications

Positioner

Robot: Stäubli Unimation Corp. Robot RX60L  
 Repeatability: 0.02 mm  
 No. of Axes: 6

Data Acquisition Electronic System (DAE)

Cell Controller

Processor: Pentium 4  
 Clock Speed: 2.53 GHz  
 Operating System: Windows XP Professional

Data Converter

Features: Signal Amplifier, multiplexer, A/D converter & control logic  
 Software: DASY4, SEMCAD software  
 Connecting Lines: Optical Downlink for data and status info  
 Optical upload for commands and clock

PC Interface Card



Function: 166MHz low power Pentium MMX 32MB chipdisk  
 Link to DAE  
 16-bit A/D converter for surface detection system  
 Two Serial & Ethernet link to robotics  
 Direct emergency stop output for robot

Phantom

Type: SAM Twin Phantom (V4.0)  
 Shell Material: Composite  
 Thickness: 2.0 ± 0.2 mm



**Figure 3-2**  
**DASY4 SAR Measurement System**

FCC ID: BEJMN240	 PCTEST ENGINEERING LABORATORY, INC.	SAR COMPLIANCE REPORT		Reviewed by: Quality Manager
Filename: 0912182291.BEJ	Test Dates: 12/17/09 - 12/22/09	EUT Type: Cellular/AWS/PCS CDMA Phone w/ BT		Page 6 of 34

### 4.1 Probe Measurement System



Figure 4-1  
SAR System

The SAR measurements were conducted with the dosimetric probe EX3DV4, designed in the classical triangular configuration [7] (see Figure 4-3) and optimized for dosimetric evaluation. The probe is constructed using the thick film technique; with printed resistive lines on ceramic substrates. The probe is equipped with an optical multi-fiber line ending at the front of the probe tip. It is connected to the EOC box on the robot arm and provides an automatic detection of the phantom surface. Half of the fibers are connected to a pulsed infrared transmitter, the other half to a synchronized receiver. As the probe approaches the surface, the reflection from the surface produces a coupling from the transmitting to the receiving fibers. This reflection increases first during the approach, reaches maximum and then decreases. If the probe is flatly touching the surface, the coupling is zero. The distance of the coupling maximum to the surface is independent of the surface reflectivity and largely independent of the surface to probe angle. The DASY4 software reads the reflection during a software approach

and looks for the maximum using a 2nd order fitting (see Figure 5-1). The approach is stopped at reaching the maximum.

### 4.2 Probe Specifications



<b>Model:</b>	ES3DV3, EX3DV4
<b>Frequency Range:</b>	10 MHz – 6.0 GHz (EX3DV4) 10 MHz – 4 GHz (ES3DV3)
<b>Calibration:</b>	In brain and muscle simulating tissue at Frequencies from 835 up to 5800MHz
<b>Linearity:</b>	± 0.2 dB (30 MHz to 6 GHz) for EX3DV4 ± 0.2 dB (30 MHz to 4 GHz) for ES3DV3
<b>Dynamic Range:</b>	10 mW/kg – 100 W/kg
<b>Probe Length:</b>	330 mm
<b>Probe Tip Length:</b>	20 mm
<b>Body Diameter:</b>	12 mm
<b>Tip Diameter:</b>	2.5 mm (3.9mm for ES3DV3)
<b>Tip-Center:</b>	1 mm (2.0 mm for ES3DV3)
<b>Application:</b>	SAR Dosimetry Testing Compliance tests of mobile phones Dosimetry in strong gradient fields



Figure 4-2  
Near-Field Probe



Figure 4-3  
Triangular Probe  
Configuration

FCC ID: BEJMN240	 PCTEST ENGINEERING LABORATORY, INC.	SAR COMPLIANCE REPORT	 LG	Reviewed by: Quality Manager
Filename: 0912182291.BEJ	Test Dates: 12/17/09 - 12/22/09	EUT Type: Cellular/AWS/PCS CDMA Phone w/ BT		Page 7 of 34

# 5 PROBE CALIBRATION PROCESS

## 5.1 Dosimetric Assessment Procedure

Each E-Probe/Probe amplifier combination has unique calibration parameters. A TEM cell calibration procedure is conducted to determine the proper amplifier settings to enter in the probe parameters. The amplifier settings are determined for a given frequency by subjecting the probe to a known E-field density (1 mW/cm<sup>2</sup>) using an RF Signal generator, TEM cell, and RF Power Meter.

## 5.2 Free Space Assessment

The free space E-field from amplified probe outputs is determined in a test chamber. This calibration can be performed in a TEM cell if the frequency is below 1 GHz and in a waveguide or other methodologies above 1 GHz for free space. For the free space calibration, the probe is placed in the volumetric center of the cavity and at the proper orientation with the field. The probe is rotated 360 degrees until the three channels show the maximum reading. The power density readings equates to 1 mW/cm<sup>2</sup>.

## 5.3 Temperature Assessment

E-field temperature correlation calibration is performed in a flat phantom filled with the appropriate simulated brain tissue. The E-field in the medium correlates with the temperature rise in the dielectric medium. For temperature correlation calibration a RF transparent thermistor-based temperature probe is used in conjunction with the E-field probe.

$$SAR = C \frac{\Delta T}{\Delta t}$$

where:

- $\Delta t$  = exposure time (30 seconds),
- C = heat capacity of tissue (brain or muscle),
- $\Delta T$  = temperature increase due to RF exposure.

$$SAR = \frac{|E|^2 \cdot \sigma}{\rho}$$

where:

- $\sigma$  = simulated tissue conductivity,
- $\rho$  = Tissue density (1.25 g/cm<sup>3</sup> for brain tissue)

SAR is proportional to  $\Delta T/\Delta t$ , the initial rate of tissue heating, before thermal diffusion takes place. Now it's possible to quantify the electric field in the simulated tissue by equating the thermally derived SAR to the E-field;



Figure 5-1 E-Field and Temperature measurements at 900MHz [7]

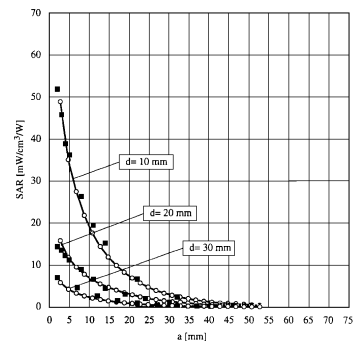



Figure 5-2 E-Field and temperature measurements at 1.9GHz [7]

FCC ID: BEJMN240	 PCTEST ENGINEERING LABORATORY, INC.	SAR COMPLIANCE REPORT		Reviewed by: Quality Manager
Filename: 0912182291.BEJ	Test Dates: 12/17/09 - 12/22/09	EUT Type: Cellular/AWS/PCS CDMA Phone w/ BT		Page 8 of 34

# 6

# PHANTOM AND EQUIVALENT TISSUES

## 6.1 SAM Phantoms



**Figure 6-1**  
**SAM Phantoms**

The SAM Twin Phantom V4.0 is constructed of a fiberglass shell integrated in a wooden table. The shape of the shell is based on data from an anatomical study designed to determine the maximum exposure in at least 90% of all users [11][12]. It enables the dosimetric evaluation of left and right hand phone usage as well as body mounted usage at the flat phantom region. A cover prevents the evaporation of the liquid. Reference markings on the Phantom allow the complete setup of all predefined phantom positions and measurement grids by manually teaching three points in the robot. (see Fig. 5.1)

## 6.2 Brain & Muscle Simulating Mixture Characterization

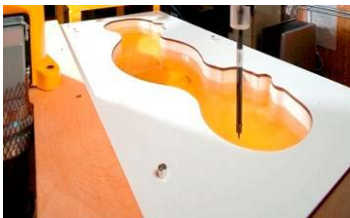

**Figure 6-2**  
**Head Simulated**



The brain and muscle mixtures consist of a viscous gel using hydroxethylcellulose (HEC) gelling agent and saline solution (see Table 6-1). Preservation with a bactericide is added and visual inspection is made to make sure air bubbles are not trapped during the mixing process. The mixture is calibrated to obtain proper dielectric constant (permittivity) and conductivity of the desired tissue. The head tissue dielectric parameters recommended by the IEEE SCC-34/SC-2 have been incorporated in the following table. Other head and body tissue parameters that have not been specified in IEEE-1528 are derived from the tissue dielectric parameters computed from the 4-Cole-Cole equations. The mixture characterizations used for the brain and muscle tissue simulating liquids are according to the data by C. Gabriel and G. Hartsgrove [13]. (See Table 6-1)

**Table 6-1**  
**Composition of the Brain & Muscle Tissue Equivalent Matter**

Frequency (MHz)	300			450		835		900			1450		1800				1900		1950	2000	2100		2450		3000		
Recipe #	1	1	3	1	1	2	3	1	1	2	2	3	1	2	4	1	1	2	2	3	2	3	2	2	2		
Ingredients: (% by weight)																											
1,2-Propanediol								64.81																			
Bactericide	0.19	0.19	0.50	0.10	0.10			0.50							0.50												0.50
Diacerin			48.90					49.20							49.43												49.75
DGBE									45.41	47.00	13.84	44.92			44.64	13.84	45.00	50.00	50.00	7.99	7.99					7.99	
HEC	0.98	0.98		1.00	1.00																						
NaCl	5.95	3.95	1.70	1.45	1.48	0.79	1.10	0.67	0.36	0.35	0.18	0.64	0.18	0.35										0.16	0.16	0.16	
Sucrose	55.32	56.32		57.00	56.50																						
Triton X-100												30.45						30.45							19.97	19.97	19.97
Water	37.56	38.56	48.90	40.45	40.92	34.40	49.20	53.80	52.64	55.36	54.90	49.43	54.90	55.36	55.00	50.00	50.00	50.00	71.88	71.88	49.75	49.75	71.88	71.88	71.88	71.88	
Measured dielectric parameters																											
$\epsilon'_p$	46.00	43.4	44.3	41.6	41.2	41.8	42.7	40.9	39.3	41	40.4	39.2	39.9	41	40.1	37	36.8	41.1	40.3	39.2	37.9						
$\sigma$ (S/m)	0.86	0.85	0.9	0.9	0.98	0.97	0.99	1.21	1.39	1.38	1.4	1.4	1.42	1.38	1.41	1.4	1.51	1.55	1.88	1.82	2.46						
Temp. (°C)	22	22	20	22	22	22	20	22	22	21	22	20	21	21	20	22	22	20	20	20	20						
Target dielectric parameters (Table 2)																											
$\epsilon'_p$	45.30	43.50	41.5		41.50			40.5							40.0				39.80		39.2					38.5	
$\sigma$ (S/m)	0.87	0.87	0.9		0.97			1.2						1.4				1.49		1.8						2.4	

NOTE—Multiple columns for any single frequency are optional recipes. Recipe #, reference: 1 (Kanda et al. [B85]), 2 (Vignone [B143]), 3 (Oguzman and Chabrol [B159]), 4 (Palmucci et al. [B50]).

\*The formulas containing Triton X-100 and corresponding measured parameters are under review and verification.

FCC ID: BEJMN240		SAR COMPLIANCE REPORT		Reviewed by: Quality Manager
Filename: 0912182291.BEJ	Test Dates: 12/17/09 - 12/22/09	EUT Type: Cellular/AWS/PCS CDMA Phone w/ BT		Page 9 of 34

### 7.1 Measurement Procedure

The evaluation was performed using the following procedure:

1. The SAR measurement was taken at a selected spatial reference point to monitor power variations during testing. This fixed point was measured and used as a reference value.
2. The SAR distribution at the exposed side of the head was measured at a distance of 3.0mm from the inner surface of the shell. The area covered the entire dimension of the head and the horizontal grid spacing was 15mm x 15mm.
3. Based on the area scan data, the area of the maximum absorption was determined by spline interpolation. Around this point, a volume of 32mm x 32mm x 30mm (fine resolution volume scan, zoom scan) was assessed by measuring 5 x 5 x 7 points. On this basis of this data set, the spatial peak SAR value was evaluated with the following procedure (see Figure 7-1):
  - a. The data at the surface was extrapolated, since the center of the dipoles is 2.7mm away from the tip of the probe and the distance between the surface and the lowest measuring point is 1.2mm. The extrapolation was based on a least square algorithm [15]. A polynomial of the fourth order was calculated through the points in z-axes. This polynomial was then used to evaluate the points between the surface and the probe tip.
  - b. The maximum interpolated value was searched with a straight-forward algorithm. Around this maximum the SAR values averaged over the spatial volumes (1g or 10g) were computed using the 3D-Spline interpolation algorithm. The 3D-spline is composed of three one-dimensional splines with the "Not a knot" condition (in x, y, and z directions) [15][16]. The volume was integrated with the trapezoidal algorithm. One thousand points (10 x 10 x 10) were interpolated to calculate the average.
  - c. All neighboring volumes were evaluated until no neighboring volume with a higher average value was found.
4. The SAR reference value, at the same location as step 1, was re-measured. If the value changed by more than 5%, the evaluation is repeated.

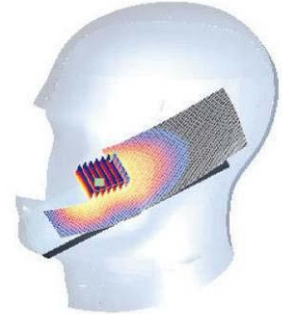



**Figure 7-1**  
Sample SAR Area Scan

### 7.2 Specific Anthropomorphic Mannequin (SAM) Specifications

The phantom for handset SAR assessment testing is a low-loss dielectric shell, with shape and dimensions derived from the anthropometric data of the 90th percentile adult male head dimensions as tabulated by the US Army. The SAM Twin Phantom shell is bisected along the mid-sagittal plane into right and left halves (see Figure 7-2). The perimeter sidewalls of each phantom halves are extended to allow filling with liquid to a depth that is sufficient to minimized reflections from the upper surface. The liquid depth is maintained at a minimum depth of 15cm to minimize reflections from the upper surface.

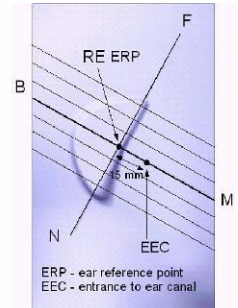

**Figure 7-2**  
SAM Twin Phantom Shell

FCC ID: BEJMN240	 PCTEST ENGINEERING LABORATORY, INC.	SAR COMPLIANCE REPORT	 LG	Reviewed by: Quality Manager
Filename: 0912182291.BEJ	Test Dates: 12/17/09 - 12/22/09	EUT Type: Cellular/AWS/PCS CDMA Phone w/ BT		Page 10 of 34

### 8.1 EAR REFERENCE POINT

Figure 8-1 shows the front, back and side views of the SAM Twin Phantom. The point "M" is the reference point for the center of the mouth, "LE" is the left ear reference point (ERP), and "RE" is the right ERP. The ERP is 15mm posterior to the entrance to the ear canal (EEC) along the B-M line (Back-Mouth), as shown in Figure 8-1. The plane passing through the two ear canals and M is defined as the Reference Plane. The line N-F (Neck-Front) is perpendicular to the reference plane and passing through the RE (or LE) is called the Reference Pivoting Line (see Figure 8-2). Line B-M is perpendicular to the N-F line. Both N-F and B-M lines are marked on the external phantom shell to facilitate handset positioning [5].



**Figure 8-1**  
Close-Up Side view  
of ERP

### 8.2 HANDSET REFERENCE POINTS



Two imaginary lines on the handset were established: the vertical centerline and the horizontal line. The test device was placed in a normal operating position with the "test device reference point" located along the "vertical centerline" on the front of the device aligned to the "ear reference point" (See Figure 8-3). The "test device reference point" was then located at the same level as the center of the ear reference point. The test device was positioned so that the "vertical centerline" was bisecting the front surface of the handset at its top and bottom edges, positioning the "ear reference point" on the outer surface of the both the left and right head phantoms on the ear reference point.

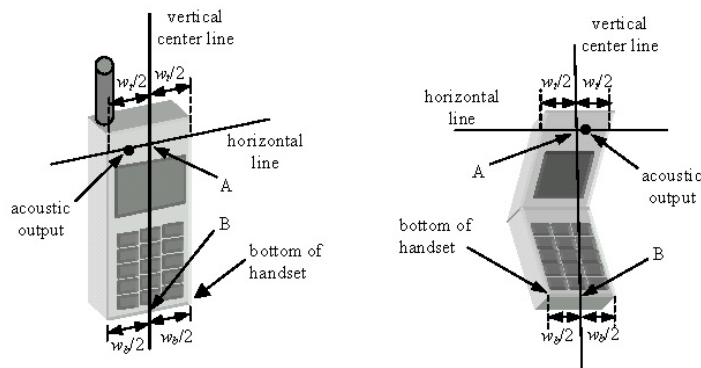

**Figure 8-2**  
Front, back and side view of SAM Twin Phantom



**Figure 8-3**  
Handset Vertical Center & Horizontal Line Reference Points

FCC ID: BEJMN240	 PCTEST ENGINEERING LABORATORY, INC.	SAR COMPLIANCE REPORT	 LG	Reviewed by: Quality Manager
Filename: 0912182291.BEJ	Test Dates: 12/17/09 - 12/22/09	EUT Type: Cellular/AWS/PCS CDMA Phone w/ BT		Page 11 of 34

### 9.1 Positioning for Cheek/Touch

1. The test device was positioned with the handset close to the surface of the phantom such that point A is on the (virtual) extension of the line passing through points RE and LE on the phantom (see Figure 9-1), such that the plane defined by the vertical center line and the horizontal line of the phone is approximately parallel to the sagittal plane of the phantom.

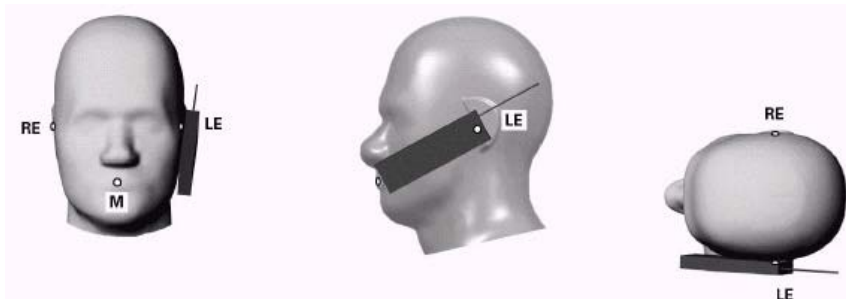



Figure 9-1 Front, Side and Top View of Cheek/Touch Position

2. The handset was translated towards the phantom along the line passing through RE & LE until the handset touches the ear.
3. While maintaining the handset in this plane, the handset was rotated around the LE-RE line until the vertical centerline was in the plane normal to MB-NF including the line MB (reference plane).
4. The phone was then rotated around the vertical centerline until the phone (horizontal line) was symmetrical with respect to the line NF.
5. While maintaining the vertical centerline in the reference plane, keeping point A on the line passing through RE and LE, and maintaining the phone contact with the ear, the handset was rotated about the line NF until any point on the handset made contact with a phantom point below the ear (cheek). See Figure 9-2)

### 9.2 Positioning for Ear / 15° Tilt

With the test device aligned in the “Cheek/Touch Position”:

1. While maintaining the orientation of the phone, the phone was retracted parallel to the reference plane far enough to enable a rotation of the phone by 15 degree.
2. The phone was then rotated around the horizontal line by 15 degree.
3. While maintaining the orientation of the phone, the phone was moved parallel to the reference plane until any part of the phone touches the head. (In this position, point A was located on the line RE-LE). The tilted position is obtained when the contact is on the pinna. If the contact was at any location other than the pinna, the angle of the phone would then be reduced. The tilted position was obtained when any part of the phone was in contact of the ear as well as a second part of the phone was in contact with the head (see Figure 9-3).

FCC ID: BEJMN240	 PCTEST ENGINEERING LABORATORY, INC.	SAR COMPLIANCE REPORT	 LG	Reviewed by: Quality Manager
Filename: 0912182291.BEJ	Test Dates: 12/17/09 - 12/22/09	EUT Type: Cellular/AWS/PCS CDMA Phone w/ BT		Page 12 of 34

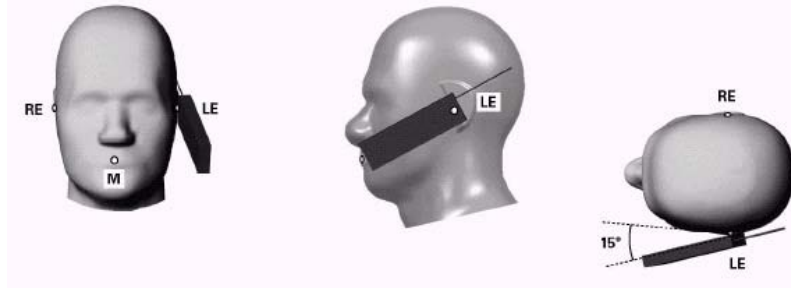

**Figure 9-2 Front, Side and Top View of Ear/15° Tilt Position**

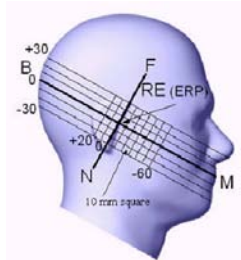

**Figure 9-3 Side view w/ relevant markings**



**Figure 9-4 Body SAR Sample Photo (Not Actual EUT)**

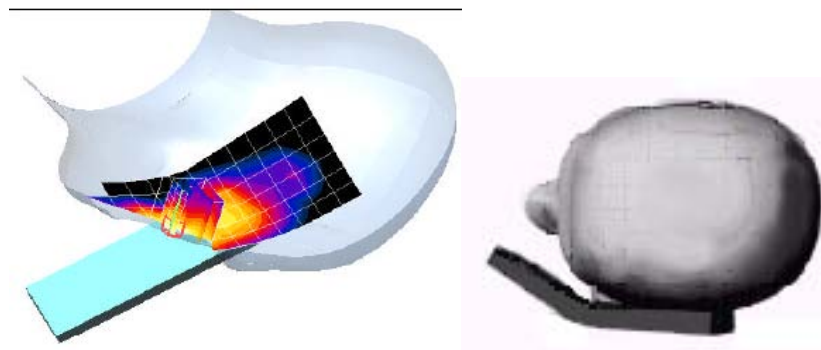

### 9.3 SAR Evaluations near the Mouth/Jaw Regions of the SAM Phantom

Antennas located near the bottom of a phone may require SAR measurements around the mouth and jaw regions of the SAM head phantom. This typically applies to clam-shell style phones that are generally longer in the unfolded normal use positions or to certain older style long rectangular phones. It has been known for some time that there are SAR measurement difficulties in these regions of the SAM phantom. SAR probes are calibrated in tissue equivalent liquids with sufficient separation between the probe sensors and nearby physical boundaries to ensure scattering does not affect probe calibration. When the probe tip is moved into tight regions with multiple boundaries surrounding its sensors, probe calibration and measurement accuracy can become questionable. In addition, these measurement locations often require a probe to be tilted at steep angles, where it may no longer comply with calibration requirements and measurement protocols, or satisfy the required measurement uncertainty. In some situations it is not feasible to tilt the probe or rotate the phantom, as suggested by measurement standards, to conduct these measurements.



**Figure 9-5 SAR Scans near the Jaw/Mouth**

In order to ensure there is sufficient conservativeness for ensuring compliance until practical solutions are available, additional measurement considerations are necessary to address these technical difficulties. When measurements are required near the mouth, nose, jaw or similar tight regions of the SAM phantom,

FCC ID: BEJMN240	 PCTEST ENGINEERING LABORATORY, INC.	SAR COMPLIANCE REPORT	 LG	Reviewed by: Quality Manager
Filename: 0912182291.BEJ	Test Dates: 12/17/09 - 12/22/09	EUT Type: Cellular/AWS/PCS CDMA Phone w/ BT		Page 13 of 34

area or zoom scans are often unable to fully enclose the peak SAR location as required by IEEE 1528 and Supplement C, due to probe orientation and positioning difficulties. Even when limited measurements are possible, the test results could be questionable due to probe calibration and measurement uncertainty issues. Under these circumstances, the following procedures apply, adopted from the FCC guidance on SAR handsets document publication 648474. The SAR required in these regions of SAM should be measured using a flat phantom. **Rectangular shaped phones** should be positioned with its bottom edge positioned from the flat phantom with the same distance provided by the cheek touching position using SAM. The ear reference point (ERP, as defined for SAM) of the phone should be positioned ½ cm from the flat phantom shell. **Clam-shell phones** should be positioned with the hinge against a smooth edge of the flat phantom where the upper half of the phone is unfolded and extended beyond the phantom side wall. The lower half of the phone is secured in the test device holder at a fixed distance below the flat phantom determined by the minimum separation along the lower edge of the phone in the cheek touching position using SAM. Any case with substantial variation in separation distance along the lower edge of a clam shell is discussed with the FCC for best-to-use methodology.



The flat phantom data should allow test results to be compared uniformly across measurement systems, until suitable solutions are available in measurement standards to address certain probe calibration and positioning issues, due to implementation differences between horizontal and upright SAM configurations. These flat phantom procedures are only applicable for stand-alone SAR evaluation in tight regions of the SAM phantom, where measurement is not feasible or test results can be questionable due to probe calibration and accessibility issues. Details on device positioning and photos showing how separation distances are determined are included in the SAR report Photographs. SAR for other regions of the head must be evaluated using SAM; therefore, a phone with antennas at different locations may require flat and SAM phantom evaluation for the different antennas.

#### 9.4 Body Holster /Belt Clip Configurations

Body-worn operating configurations are tested with the belt-clips and holsters attached to the device and positioned against a flat phantom in a normal use configuration (see Figure 9-5). A device with a headset output is tested with a headset connected to the device.

Accessories for Body-worn operation configurations are divided into two categories: those that do not contain metallic components and those that do contain metallic components. When multiple accessories that do not contain metallic components are supplied with the device, the device is tested with only the accessory that dictates the closest spacing to the body. Then multiple accessories that contain metallic components are tested with the device with each accessory. If multiple accessories share an identical metallic component (i.e. the same metallic belt-clip used with different holsters with no other metallic components) only the accessory that dictates the closest spacing to the body is tested.

Body-worn accessories may not always be supplied or available as options for some devices intended to be authorized for body-worn use. In this case, a test configuration with a separation distance between the back of the device and the flat phantom is used. Test position spacing was documented. Transmitters that are designed to operate in front of a person’s face, as in push-to-talk configurations, are tested for SAR compliance with the front of the device positioned to face the flat phantom in brain fluid. For devices that are carried next to the body such as a shoulder, waist or chest-worn transmitters, SAR compliance is tested with the accessories, including headsets and microphones, attached to the device and positioned against a flat phantom in a normal use configuration.

FCC ID: BEJMN240	 PCTEST ENGINEERING LABORATORY, INC.	SAR COMPLIANCE REPORT		Reviewed by: Quality Manager
Filename: 0912182291.BEJ	Test Dates: 12/17/09 - 12/22/09	EUT Type: Cellular/AWS/PCS CDMA Phone w/ BT		Page 14 of 34

# 10 RF EXPOSURE LIMITS

## 10.1 Uncontrolled Environment

UNCONTROLLED ENVIRONMENTS are defined as locations where there is the exposure of individuals who have no knowledge or control of their exposure. The general population/uncontrolled exposure limits are applicable to situations in which the general public may be exposed or in which persons who are exposed as a consequence of their employment may not be made fully aware of the potential for exposure or cannot exercise control over their exposure. Members of the general public would come under this category when exposure is not employment-related; for example, in the case of a wireless transmitter that exposes persons in its vicinity.



## 10.2 Controlled Environment

CONTROLLED ENVIRONMENTS are defined as locations where there is exposure that may be incurred by persons who are aware of the potential for exposure, (i.e. as a result of employment or occupation). In general, occupational/controlled exposure limits are applicable to situations in which persons are exposed as a consequence of their employment, who have been made fully aware of the potential for exposure and can exercise control over their exposure. This exposure category is also applicable when the exposure is of a transient nature due to incidental passage through a location where the exposure levels may be higher than the general population/uncontrolled limits, but the exposed person is fully aware of the potential for exposure and can exercise control over his or her exposure by leaving the area or by some other appropriate means.

**Table 11-1**  
**SAR Human Exposure Specified in ANSI/IEEE C95.1-1992 and Health Canada Safety Code 6**

HUMAN EXPOSURE LIMITS		
	UNCONTROLLED ENVIRONMENT <i>General Population</i> (W/kg) or (mW/g)	CONTROLLED ENVIRONMENT <i>Occupational</i> (W/kg) or (mW/g)
SPATIAL PEAK SAR Brain	1.6	8.0
SPATIAL AVERAGE SAR Whole Body	0.08	0.4
SPATIAL PEAK SAR Hands, Feet, Ankles, Wrists	4.0	20



- 1 The Spatial Peak value of the SAR averaged over any 1 gram of tissue (defined as a tissue volume in the shape of a cube) and over the appropriate averaging time.
- 2 The Spatial Average value of the SAR averaged over the whole body.
- 3 The Spatial Peak value of the SAR averaged over any 10 grams of tissue (defined as a tissue volume in the shape of a cube) and over the appropriate averaging time.

FCC ID: BEJMN240	 PCTEST ENGINEERING LABORATORY, INC.	SAR COMPLIANCE REPORT	 LG	Reviewed by: Quality Manager
Filename: 0912182291.BEJ	Test Dates: 12/17/09 - 12/22/09	EUT Type: Cellular/AWS/PCS CDMA Phone w/ BT		Page 15 of 34

# 11 MEASUREMENT UNCERTAINTIES

a	b	c	d	e= f(d,k)	f	g	h = c x f/e	i = c x g/e	k
Uncertainty Component	IEEE 1528 Sec.	Tol. (± %)	Prob. Dist.	Div.	c <sub>f</sub> 1gm	c <sub>g</sub> 10 gms	1gm u <sub>f</sub> (± %)	10gms u <sub>g</sub> (± %)	v <sub>i</sub>
<b>Measurement System</b>									
Probe Calibration	E2.1	6.6	N	1	1.0	1.0	6.6	6.6	∞
Axial Isotropy	E2.2	0.25	N	1	0.7	0.7	0.2	0.2	∞
Hemishperical Isotropy	E2.2	1.3	N	1	1.0	1.0	1.3	1.3	∞
Boundary Effect	E2.3	0.4	N	1	1.0	1.0	0.4	0.4	∞
Linearity	E2.4	0.3	N	1	1.0	1.0	0.3	0.3	∞
System Detection Limits	E2.5	5.1	N	1	1.0	1.0	5.1	5.1	∞
Readout Electronics	E2.6	1.0	N	1	1.0	1.0	1.0	1.0	∞
Response Time	E2.7	0.8	R	1.73	1.0	1.0	0.5	0.5	∞
Integration Time	E2.8	2.6	R	1.73	1.0	1.0	1.5	1.5	∞
RF Ambient Conditions	E6.1	3.0	R	1.73	1.0	1.0	1.7	1.7	∞
Probe Positioner Mechanical Tolerance	E6.2	0.4	R	1.73	1.0	1.0	0.2	0.2	∞
Probe Positioning w/ respect to Phantom	E6.3	2.9	R	1.73	1.0	1.0	1.7	1.7	∞
Extrapolation, Interpolation & Integration algorithms for Max. SAR Evaluation	E5	1.0	R	1.73	1.0	1.0	0.6	0.6	∞
<b>Test Sample Related</b>									
Test Sample Positioning	E4.2	6.0	N	1	1.0	1.0	6.0	6.0	287
Device Holder Uncertainty	E4.1	3.32	R	1.73	1.0	1.0	1.9	1.9	∞
Output Power Variation - SAR drift measurement	6.6.2	5.0	R	1.73	1.0	1.0	2.9	2.9	∞
<b>Phantom &amp; Tissue Parameters</b>									
Phantom Uncertainty (Shape & Thickness tolerances)	E3.1	4.0	R	1.73	1.0	1.0	2.3	2.3	∞
Liquid Conductivity - deviation from target values	E3.2	5.0	R	1.73	0.64	0.43	1.8	1.2	∞
Liquid Conductivity - measurement uncertainty	E3.3	3.8	N	1	0.64	0.43	2.4	1.6	6
Liquid Permittivity - deviation from target values	E3.2	5.0	R	1.73	0.60	0.49	1.7	1.4	∞
Liquid Permittivity - measurement uncertainty	E3.3	4.5	N	1	0.60	0.49	2.7	2.2	6
<b>Combined Standard Uncertainty (k=1)</b>	RSS						12.4	12.0	299
<b>Expanded Uncertainty</b> (95% CONFIDENCE LEVEL)	k=2						24.7	24.0	

The above measurement uncertainties are according to IEEE Std. 1528-2003

FCC ID: BEJMN240	 PCTEST ENGINEERING LABORATORY, INC.	SAR COMPLIANCE REPORT		Reviewed by: Quality Manager
Filename: 0912182291.BEJ	Test Dates: 12/17/09 - 12/22/09	EUT Type: Cellular/AWS/PCS CDMA Phone w/ BT		Page 16 of 34

# 12 SYSTEM VERIFICATION

## 12.1 Tissue Verification

**Table 13-1  
Measured Tissue Properties**

Calibrated Date:	Tissue Type	Measured Frequency (MHz)	Measured Conductivity, $\sigma$ (S/m)	Measured Dielectric Constant, $\epsilon$	TARGET Conductivity, $\sigma$ (S/m)	TARGET Dielectric Constant, $\epsilon$	% dev $\sigma$	% dev $\epsilon$
12/14/2009	835H	820	0.884	40.58	0.90	41.50	-1.78%	-2.22%
		835	0.898	40.34	0.90	41.50	-0.22%	-2.80%
		850	0.908	40.19	0.90	41.50	0.89%	-3.16%
12/21/2009	835H	820	0.885	40.51	0.90	41.50	-1.67%	-2.39%
		835	0.897	40.31	0.90	41.50	-0.33%	-2.87%
		850	0.909	40.18	0.90	41.50	1.00%	-3.18%
12/21/2009	835M	820	0.962	52.95	0.97	55.20	-0.82%	-4.08%
		835	0.979	52.91	0.97	55.20	0.93%	-4.15%
		850	1.002	52.66	0.97	55.20	3.30%	-4.60%
12/21/2009	1750H	1710	1.304	40.88	1.34	40.43	-2.75%	1.12%
		1750	1.323	40.73	1.37	40.50	-3.43%	0.57%
		1790	1.379	40.45	1.39	40.42	-1.08%	0.07%
12/21/2009	1750M	1710	1.402	54.32	1.46	53.55	-3.79%	1.45%
		1750	1.421	54.16	1.49	53.40	-4.63%	1.42%
		1790	1.485	53.93	1.51	53.32	-1.92%	1.14%
12/14/2009	1900H	1850	1.397	38.75	1.40	40.00	-0.21%	-3.13%
		1880	1.426	38.47	1.40	40.00	1.86%	-3.83%
		1910	1.469	38.31	1.40	40.00	4.93%	-4.22%
12/14/2009	1900M	1850	1.510	52.88	1.52	53.30	-0.67%	-0.79%
		1880	1.546	52.60	1.52	53.30	1.71%	-1.31%
		1910	1.593	52.49	1.52	53.30	4.80%	-1.52%

Note: KDB 450824 was ensured to be applied for probe calibration frequencies greater than or equal to 50 MHz of the DUT frequencies.



The above measured tissue parameters were used in the DASY software to perform interpolation via the DASY software to determine actual dielectric parameters at the test frequencies (per IEEE 1528 6.6.1.2).

## 12.2 Measurement Procedure for Tissue verification

- 1) The network analyzer and probe system was configured and calibrated.
- 2) The probe was immersed in the sample which was placed in a nonmetallic container. Trapped air bubbles beneath the flange were minimized by placing the probe at a slight angle.
- 3) The complex admittance with respect to the probe aperture was measured
- 4) The complex relative permittivity, for example from the below equation (Pournaropoulos and Misra):

$$Y = \frac{j2\omega\epsilon_r\epsilon_0}{[\ln(b/a)]^2} \int_a^b \int_a^b \int_0^\pi \cos\phi' \frac{\exp[-j\omega r(\mu_0\epsilon_r\epsilon_0)^{1/2}]}{r} d\phi'd\rho'd\rho$$

where Y is the admittance of the probe in contact with the sample, the primed and unprimed coordinates refer to source and observation points, respectively,  $r^2 = \rho^2 + \rho'^2 - 2\rho\rho'\cos\phi'$ ,  $\omega$  is the angular frequency, and  $j = \sqrt{-1}$ .

FCC ID: BEJMN240	 PCTEST ENGINEERING LABORATORY, INC.	SAR COMPLIANCE REPORT	 LG	Reviewed by: Quality Manager
Filename: 0912182291.BEJ	Test Dates: 12/17/09 - 12/22/09	EUT Type: Cellular/AWS/PCS CDMA Phone w/ BT		Page 17 of 34

### 12.3 Test System Verification

Prior to assessment, the system is verified to  $\pm 10\%$  of the manufacturer SAR result on the reference dipole at the time of calibration, by using the below system validation kit(s).

**Table 13-2  
System Verification Results**

System Verification TARGET & MEASURED									
Date:	Amb. Temp (°C)	Liquid Temp (°C)	Input Power (W)	Tissue Frequency (MHz)	Dipole SN	Tissue Type	Targeted SAR <sub>1g</sub> (mW)	Measured SAR <sub>1g</sub> (mW)	Deviation (%)
12/17/2009	23.5	21.9	0.100	1900	502	Brain	3.99	4.16	4.26%
12/18/2009	23.9	22.5	0.100	835	4d047	Brain	0.97	1.06	9.28%
12/21/2009	24.1	23.3	0.254	835	4d047	Brain	2.46	2.55	3.70%
12/22/2009	23.9	22	0.100	1765	1008	Brain	3.84	3.82	-0.46%

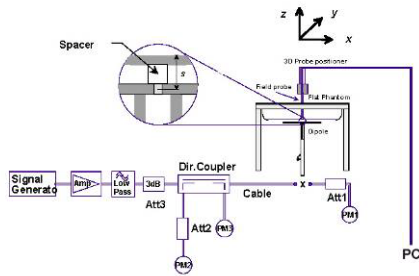

**Figure 13-1  
System Verification Setup Diagram**



**Figure 13-2  
System Verification Setup Photo**

FCC ID: BEJMN240	PCTEST ENGINEERING LABORATORY, INC.	SAR COMPLIANCE REPORT	LG	Reviewed by: Quality Manager
Filename: 0912182291.BEJ	Test Dates: 12/17/09 - 12/22/09	EUT Type: Cellular/AWS/PCS CDMA Phone w/ BT		Page 18 of 34

# 13 FCC MULTI-TX AND ANTENNA SAR CONSIDERATIONS

## 13.1 Introduction

The following procedures adopted from “FCC SAR Considerations for Cell Phones with Multiple Transmitters” v01r03 from May 2008 are applicable to handsets with built-in unlicensed transmitters such as 802.11a/b/g and Bluetooth devices which may simultaneously transmit with the licensed transmitter.

## 13.2 FCC Power Tables & Conditions

	2.45	5.15 - 5.35	5.47 - 5.85	GHz
$P_{Ref}$	12	6	5	mW

Device output power should be rounded to the nearest mW to compare with values specified in this table.

**Figure 14-1**  
Output Power Thresholds for Unlicensed Transmitters

	Individual Transmitter	Simultaneous Transmission
<b>Licensed Transmitters</b>	<u>Routine evaluation required</u>	<b>SAR not required:</b> <u>Unlicensed only</u>
<b>Unlicensed Transmitters</b>	<p><u>When there is no simultaneous transmission –</u></p> <ul style="list-style-type: none"> <li>output <math>\leq 60</math>/f: SAR not required</li> <li>output <math>&gt; 60</math>/f: stand-alone SAR required</li> </ul> <p><u>When there is simultaneous transmission –</u></p> <p><u>Stand-alone SAR not required when</u></p> <ul style="list-style-type: none"> <li>output <math>\leq 2 \cdot P_{Ref}</math> and antenna is <math>\geq 5.0</math> cm from other antennas</li> <li>output <math>\leq P_{Ref}</math> and antenna is <math>\geq 2.5</math> cm from other antennas</li> </ul> <p>o output <math>\leq P_{Ref}</math> and antenna is <math>&lt; 2.5</math> cm from other antennas, each with either output power <math>\leq P_{Ref}</math> or 1-g SAR <math>&lt; 1.2</math> W/kg</p> <p><u>Otherwise stand-alone SAR is required</u></p> <p><u>When stand-alone SAR is required</u></p> <ul style="list-style-type: none"> <li>test SAR on highest output channel for each wireless mode and exposure condition</li> <li>if SAR for highest output channel is <math>&gt; 50\%</math> of SAR limit, evaluate all channels according to normal procedures</li> </ul>	<ul style="list-style-type: none"> <li>when stand-alone 1-g SAR is not required and antenna is <math>\geq 5</math> cm from other antennas</li> </ul> <p><u>Licensed &amp; Unlicensed</u></p> <ul style="list-style-type: none"> <li>when the sum of the 1-g SAR is <math>&lt; 1.6</math> W/kg for all simultaneous transmitting antennas</li> <li>when SAR to peak location separation ratio of simultaneous transmitting antenna pair is <math>&lt; 0.3</math></li> </ul> <p><b>SAR required:</b></p> <p><u>Licensed &amp; Unlicensed</u></p> <p>antenna pairs with SAR to peak location separation ratio <math>\geq 0.3</math>; test is only required for the configuration that results in the highest SAR in stand-alone configuration for each wireless mode and exposure condition</p> <p><b>Note: simultaneous transmission exposure conditions for head and body can be different for different style phones; therefore, different test requirements may apply</b></p>

**Figure 14-2**  
SAR Evaluation Requirements for Multiple Transmitter Handsets



## 13.3 Multiple Antenna/Transmission Information for MN240, LW240

Separation Distance of Antennas: 0.70 cm for Bluetooth.  
RF Conducted Power of Bluetooth Tx is 6.067 mW.

## 13.4 Conclusion

Based on the output power, antenna separation distance and the Body SAR of the dominant transmitter, a stand-alone Bluetooth SAR test is not required.

The summation of BT SAR and Licensed Transmitter SAR is  $0.71$  W/kg +  $0$  W/kg =  $0.71$  W/kg, which is less than  $1.6$  W/kg, therefore, a simultaneous SAR evaluation is not required.

FCC ID: BEJMN240	 PCTEST ENGINEERING LABORATORY, INC.	SAR COMPLIANCE REPORT		Reviewed by: Quality Manager
Filename: 0912182291.BEJ	Test Dates: 12/17/09 - 12/22/09	EUT Type: Cellular/AWS/PCS CDMA Phone w/ BT		Page 19 of 34

## 14 FCC 3G MEASUREMENT PROCEDURES

Power measurements were performed using a base station simulator under digital average power.

### 14.1 Procedures Used to Establish RF Signal for SAR

The device was placed into a simulated call using a base station simulator in a shielded chamber. Such test signals offer a consistent means for testing SAR and are recommended for evaluating SAR [4]. SAR measurements were taken with a fully charged battery. In order to verify that the device was tested and maintained at full power, it was configured with the base station simulator. The SAR measurement software calculates a reference point at the start and end of the test to check for power drifts. If conducted power deviations of more than 5% occurred, the tests were repeated.

### 14.2 SAR Measurement Conditions for CDMA2000

The following procedures were followed according to FCC "SAR Measurement Procedures for 3G Devices" v02, October 2007.

#### 14.2.1 Output Power Verification

See 3GPP2 C.S0011/TIA-98-E as recommended by "SAR Measurement Procedures for 3G Devices" v02, October 2007. Maximum output power is verified on the High, Middle and Low channels according to procedures in section 4.4.5.2 of 3GPP2 C.S0011/TIA-98-E. SO55 tests were measured with power control bits in "All Up" condition. .

1. If the mobile station (MS) supports Reverse TCH RC 1 and Forward TCH RC 1, set up a call using Fundamental Channel Test Mode 1 (RC=1/1) with 9600 bps data rate only.
2. Under RC1, C.S0011 Table 4.4.5.2-1, Table 13-1 parameters were applied.
3. If the MS supports the RC 3 Reverse FCH, RC3 Reverse SCH0 and demodulation of RC 3,4, or 5, set up a call using Supplemental Channel Test Mode 3 (RC 3/3) with 9600 bps Fundamental Channel and 9600 bps SCH0 data rate.
4. Under RC3, C.S0011 Table 4.4.5.2-2, Table 13-2 was applied.
5. FCHs were configured at full rate for maximum SAR with "All Up" power control bits.

**Table 15-1  
Parameters for Max. Power for RC1**



Parameter	Units	Value
$I_{or}$	dBm/1.23 MHz	-104
$\frac{Pilot E_c}{I_{or}}$	dB	-7
$\frac{Traffic E_c}{I_{or}}$	dB	-7.4

**Table 15-2  
Parameters for Max. Power for RC3**

Parameter	Units	Value
$I_{or}$	dBm/1.23 MHz	-86
$\frac{Pilot E_c}{I_{or}}$	dB	-7
$\frac{Traffic E_c}{I_{or}}$	dB	-7.4

#### 14.2.2 Head SAR Measurements

SAR for head exposure configurations is measured in RC3 with the DUT configured to transmit at full rate using Loopback Service Option SO55. SAR for RC1 is not required when the maximum average output of each channel is less than ¼ dB higher than that measured in RC3. Otherwise, SAR is measured on the maximum output channel in RC1 using the exposure configuration that results in the highest SAR for that channel in RC3.

FCC ID: BEJMN240	 PCTEST ENGINEERING LABORATORY, INC.	SAR COMPLIANCE REPORT	 LG	Reviewed by: Quality Manager
Filename: 0912182291.BEJ	Test Dates: 12/17/09 - 12/22/09	EUT Type: Cellular/AWS/PCS CDMA Phone w/ BT		Page 20 of 34

### 14.2.3 Body SAR Measurements

SAR for body exposure configurations is measured in RC3 with the DUT configured to transmit at full rate on FCH with all other code channels disabled using TDSO / SO32. SAR for multiple code channels (FCH + SCH<sub>n</sub>) is not required when the maximum average output of each RF channel is less than ¼ dB higher than that measured with FCH only. Otherwise, SAR is measured on the maximum output channel (FCH + SCH<sub>n</sub>) with FCH at full rate and SCH<sub>0</sub> enabled at 9600 bps using the exposure configuration that results in the highest SAR for that channel with FCH only. When multiple code channels are enabled, the DUT output may shift by more than 0.5 dB and lead to higher SAR drifts and SCH dropouts. Body SAR was measured using TDSO / SO32 with power control bits in the “All Up”

Body SAR in RC1 is not required when the maximum average output of each channel is less than ¼ dB higher than that measured in RC3. Otherwise, SAR is measured on the maximum output channel in RC1; with Loopback Service Option SO55, at full rate, using the body exposure configuration that results in the highest SAR for that channel in RC3.

## 14.3 RF Conducted Powers

### 14.3.1 CDMA Conducted Powers

Band	Channel	SO55 [dBm]		TDSO SO32 [dBm]
		RC1	RC3	RC3
	F-RC			
	Vocoder Rate	Full	Full	N/A
Cellular	1013	25.23	<b>25.20</b>	25.07
	384	25.22	<b>25.18</b>	25.08
	777	25.13	<b>25.06</b>	25.06
AWS	25	25.33	<b>25.22</b>	25.11
	450	25.31	<b>25.23</b>	25.17
	875	25.35	<b>25.32</b>	25.34
PCS	25	25.15	<b>25.12</b>	25.11
	600	25.16	<b>25.11</b>	25.22
	1175	25.08	<b>25.08</b>	25.02



**Figure 15-1**  
**Power Measurement Setup**

FCC ID: BEJMN240	PCTEST ENGINEERING LABORATORY, INC.	SAR COMPLIANCE REPORT	LG	Reviewed by: Quality Manager
Filename: 0912182291.BEJ	Test Dates: 12/17/09 - 12/22/09	EUT Type: Cellular/AWS/PCS CDMA Phone w/ BT		Page 21 of 34



# 15 SAR DATA SUMMARY

## 15.1 Cell. CDMA Head SAR Results

MEASUREMENT RESULTS										
FREQUENCY		Mode/Band	C_Power[dBm]		Side	Test Position	Slider Config.	Battery Type	SAR (1g)	
MHz	Ch.		Start	End					(W/kg)	
836.52	384	Cell. CDMA	25.18	25.28	Right	Touch	In	Standard	0.720	
836.52	384	Cell. CDMA	25.18	25.31	Right	Tilt	In	Standard	0.351	
836.52	384	Cell. CDMA	25.18	25.26	Left	Touch	In	Standard	0.660	
836.52	384	Cell. CDMA	25.18	25.07	Left	Tilt	In	Standard	0.352	
824.70	1013	Cell. CDMA	25.20	25.22	Right	Touch	Out	Standard	1.220	
836.52	384	Cell. CDMA	25.18	25.05	Right	Touch	Out	Standard	1.140	
848.31	777	Cell. CDMA	25.06	25.08	Right	Touch	Out	Standard	1.200	
836.52	384	Cell. CDMA	25.18	25.12	Right	Tilt	Out	Standard	0.602	
824.70	1013	Cell. CDMA	25.20	25.24	Left	Touch	Out	Standard	1.030	
836.52	384	Cell. CDMA	25.18	25.32	Left	Touch	Out	Standard	1.000	
848.31	777	Cell. CDMA	25.06	25.00	Left	Touch	Out	Standard	1.090	
836.52	384	Cell. CDMA	25.18	25.24	Left	Tilt	Out	Standard	0.565	
ANSI / IEEE C95.1 1992 - SAFETY LIMIT						Brain				
Spatial Peak						1.6 W/kg (mW/g)				
Uncontrolled Exposure/General Population						averaged over 1 gram				

Notes:

1. The test data reported are the worst-case SAR value with the position set in a typical configuration. Test procedures used are according to FCC/OET Bulletin 65, Supplement C [July 2001].
2. All modes of operation were investigated, and worst-case results are reported.
3. Batteries are fully charged for all readings.
4. Tissue parameters and temperatures are listed on the SAR plots.
5. Liquid tissue depth is 15.1 cm. ± 0.1.
6. Justification for reduced test configurations: Per FCC/OET Bulletin 65 Supplement C (July, 2001) and Public Notice DA-02-1438, if the SAR measured at the middle channel for each test configuration (left, right, cheek/touch, tilt/ear, extended and retracted) is at least 3.0 dB lower than the SAR limit, testing at the high and low channels is optional for such test configuration(s).
7. CDMA2000 mode was tested under RC3/SO55



FCC ID: BEJMN240	 PCTEST ENGINEERING LABORATORY, INC.	SAR COMPLIANCE REPORT		Reviewed by: Quality Manager
Filename: 0912182291.BEJ	Test Dates: 12/17/09 - 12/22/09	EUT Type: Cellular/AWS/PCS CDMA Phone w/ BT		Page 22 of 34

## 15.2 AWS CDMA Head SAR Results

MEASUREMENT RESULTS									
FREQUENCY		Mode/Band	C_Power[dBm]		Side	Test Position	Slider Config.	Battery Type	SAR (1g)
MHz	Ch.		Start	End					(W/kg)
1732.50	450	AWS CDMA	25.23	25.25	Right	Touch	In	Standard	0.570
1732.50	450	AWS CDMA	25.23	25.24	Right	Tilt	In	Standard	0.414
1732.50	450	AWS CDMA	25.23	25.23	Left	Touch	In	Standard	0.698
1732.50	450	AWS CDMA	25.23	25.23	Left	Tilt	In	Standard	0.456
1732.50	450	AWS CDMA	25.23	25.11	Right	Touch	Out	Standard	0.363
1732.50	450	AWS CDMA	25.23	25.18	Right	Tilt	Out	Standard	0.263
1732.50	450	AWS CDMA	25.23	25.32	Left	Touch	Out	Standard	0.630
1732.50	450	AWS CDMA	25.23	25.36	Left	Tilt	Out	Standard	0.290
ANSI / IEEE C95.1 1992 - SAFETY LIMIT						Brain			
Spatial Peak						1.6 W/kg (mW/g)			
Uncontrolled Exposure/General Population						averaged over 1 gram			

### Notes:

1. The test data reported are the worst-case SAR value with the position set in a typical configuration. Test procedures used are according to FCC/OET Bulletin 65, Supplement C [July 2001].
2. All modes of operation were investigated, and worst-case results are reported.
3. Batteries are fully charged for all readings.
4. Tissue parameters and temperatures are listed on the SAR plots.
5. Liquid tissue depth is 15.1 cm.  $\pm$  0.1.
6. Justification for reduced test configurations: Per FCC/OET Bulletin 65 Supplement C (July, 2001) and Public Notice DA-02-1438, if the SAR measured at the middle channel for each test configuration (left, right, cheek/touch, tilt/ear, extended and retracted) is at least 3.0 dB lower than the SAR limit, testing at the high and low channels is optional for such test configuration(s).
7. CDMA2000 mode was tested under RC3/SO55



FCC ID: BEJMN240	 PCTEST ENGINEERING LABORATORY, INC.	SAR COMPLIANCE REPORT		Reviewed by: Quality Manager
Filename: 0912182291.BEJ	Test Dates: 12/17/09 - 12/22/09	EUT Type: Cellular/AWS/PCS CDMA Phone w/ BT		Page 23 of 34

### 15.3 PCS CDMA Head SAR Results

MEASUREMENT RESULTS									
FREQUENCY		Mode/Band	C_Power[dBm]		Side	Test Position	Slider Config.	Battery Type	SAR (1g)
MHz	Ch.		Start	End					(W/kg)
1880.00	600	PCS CDMA	25.11	24.92	Right	Touch	In	Standard	0.374
1880.00	600	PCS CDMA	25.11	25.30	Right	Tilt	In	Standard	0.261
1880.00	600	PCS CDMA	25.11	25.09	Left	Touch	In	Standard	0.550
1880.00	600	PCS CDMA	25.11	25.15	Left	Tilt	In	Standard	0.268
1880.00	600	PCS CDMA	25.11	25.00	Right	Touch	Out	Standard	0.286
1880.00	600	PCS CDMA	25.11	25.24	Right	Tilt	Out	Standard	0.329
1880.00	600	PCS CDMA	25.11	25.14	Left	Touch	Out	Standard	0.513
1880.00	600	PCS CDMA	25.11	24.97	Left	Tilt	Out	Standard	0.319
ANSI / IEEE C95.1 1992 - SAFETY LIMIT Spatial Peak Uncontrolled Exposure/General Population						Brain 1.6 W/kg (mW/g) averaged over 1 gram			

Notes:

1. The test data reported are the worst-case SAR value with the position set in a typical configuration. Test procedures used are according to FCC/OET Bulletin 65, Supplement C [July 2001].
2. All modes of operation were investigated, and worst-case results are reported.
3. Batteries are fully charged for all readings.
4. Tissue parameters and temperatures are listed on the SAR plots.
5. Liquid tissue depth is 15.1 cm. ± 0.1.
6. Justification for reduced test configurations: Per FCC/OET Bulletin 65 Supplement C (July, 2001) and Public Notice DA-02-1438, if the SAR measured at the middle channel for each test configuration (left, right, cheek/touch, tilt/ear, extended and retracted) is at least 3.0 dB lower than the SAR limit, testing at the high and low channels is optional for such test configuration(s).
7. CDMA2000 mode was tested under RC3/SO55



FCC ID: BEJMN240	 PCTEST ENGINEERING LABORATORY, INC.	SAR COMPLIANCE REPORT		Reviewed by: Quality Manager
Filename: 0912182291.BEJ	Test Dates: 12/17/09 - 12/22/09	EUT Type: Cellular/AWS/PCS CDMA Phone w/ BT		Page 24 of 34

## 15.4 Body SAR Results

MEASUREMENT RESULTS											
FREQUENCY		Mode	Service	C_Power[dBm]		Position	Spacing	Slider Config.	Battery	Side	SAR (1g)
MHz	Ch.			Start	End						(W/kg)
836.52	384	Cell. CDMA	TDSO32	25.08	25.04	Body	2.0 cm	In	Standard	back	0.661
836.52	384	Cell. CDMA	TDSO32	25.08	25.04	Body	2.0 cm	In	Standard	front	0.228
1732.50	450	AWS CDMA	TDSO32	25.17	25.21	Body	2.0 cm	In	Standard	back	0.714
1732.50	450	AWS CDMA	TDSO32	25.17	25.24	Body	2.0 cm	In	Standard	front	0.106
1880.00	600	PCS CDMA	TDSO32	25.22	25.29	Body	2.0 cm	In	Standard	back	0.470
1880.00	600	PCS CDMA	TDSO32	25.22	25.08	Body	2.0 cm	In	Standard	front	0.085
ANSI / IEEE C95.1 1992 - SAFETY LIMIT Spatial Peak Uncontrolled Exposure/General Population							Body 1.6 W/kg (mW/g) averaged over 1 gram				

Notes:

1. The test data reported are the worst-case SAR value with the position set in a typical configuration. Test procedures used are according to FCC/OET Bulletin 65, Supplement C [July 2001].
2. All modes of operation were investigated, and worst-case results are reported.
3. Tissue parameters and temperatures are listed on the SAR plots.
4. Batteries are fully charged for all readings.
5. Liquid tissue depth is 15.1 cm. ± 0.1.
6. Device was tested using 2.0 cm.
7. Body SAR was tested under RC3/SO32



FCC ID: BEJMN240	 PCTEST ENGINEERING LABORATORY, INC.	SAR COMPLIANCE REPORT		Reviewed by: Quality Manager
Filename: 0912182291.BEJ	Test Dates: 12/17/09 - 12/22/09	EUT Type: Cellular/AWS/PCS CDMA Phone w/ BT		Page 25 of 34

# 16 EQUIPMENT LIST

Manufacturer	Model	Description	Cal Date	Cal Interval	Cal Due	Serial Number
Agilent	8648D	(9kHz-4GHz) Signal Generator	9/19/2009	Biennial	9/19/2011	3613A00315
Agilent	8753E	(30kHz-6GHz) Network Analyzer	3/25/2009	Annual	3/25/2010	JP38020182
Agilent	E5515C	Wireless Communications Test Set	9/10/2009	Annual	9/10/2010	GB46110872
Agilent	E5515C	Wireless Communications Test Set	9/11/2009	Annual	9/11/2010	GB46310798
Agilent	E5515C	Wireless Communications Test Set	8/25/2009	Annual	8/25/2010	GB41450275
Agilent	E8257D	(250kHz-20GHz) Signal Generator	3/25/2009	Biennial	3/25/2011	MY45470194
Gigatronics	80701A	(0.05-18GHz) Power Sensor	9/9/2009	Annual	9/9/2010	1833460
Gigatronics	8651A	Universal Power Meter	9/9/2009	Annual	9/9/2010	8650319
Index SAR	IXTL-010	Dielectric Measurement Kit	N/A		N/A	N/A
Index SAR	IXTL-030	30MM TEM line for 6 GHz	N/A		N/A	N/A
Rohde & Schwarz	CMU200	Base Station Simulator	9/11/2009	Annual	9/11/2010	836371/0079
Rohde & Schwarz	CMU200	Base Station Simulator	4/6/2009	Annual	4/6/2010	833855/0010
Rohde & Schwarz	CMU200	Base Station Simulator	9/4/2009	Annual	9/4/2010	109892
Rohde & Schwarz	NRVD	Dual Channel Power Meter	8/20/2008	Biennial	8/20/2010	101695
Rohde & Schwarz	NRV-Z32	Peak Power Sensor (100uW-2W)	12/5/2008	Biennial	12/5/2010	100155
Rohde & Schwarz	NRV-Z33	Peak Power Sensor (1mW-20W)	12/5/2008	Biennial	12/5/2010	100004
SPEAG	D1450V2	1450 MHz SAR Dipole	5/20/2009	Biennial	5/20/2011	1025
SPEAG	D1765V2	1765 MHz SAR Dipole	5/19/2009	Biennial	5/19/2011	1008
SPEAG	D1900V2	1900 MHz SAR Dipole	1/20/2009	Biennial	1/20/2011	502
SPEAG	D1900V2	1900 MHz SAR Dipole	8/18/2009	Biennial	8/18/2011	5d080
SPEAG	D2300V2	2300 MHz SAR Dipole	3/6/2008	Biennial	3/6/2010	1008
SPEAG	D2450V2	2450 MHz SAR Dipole	8/27/2009	Biennial	8/27/2011	719
SPEAG	D2450V2	2450 MHz SAR Dipole	1/8/2009	Biennial	1/8/2011	797
SPEAG	D2600V2	2600 MHz SAR Dipole	8/12/2009	Biennial	8/12/2011	1004
SPEAG	D5GHzV2	5 GHz SAR Dipole	8/19/2009	Biennial	8/19/2011	1007
SPEAG	D5GHzV2	5 GHz SAR Dipole	1/15/2009	Biennial	1/15/2011	1057
SPEAG	D835V2	835 MHz SAR Dipole	1/19/2009	Biennial	1/19/2011	4d047
SPEAG	D835V2	835 MHz SAR Dipole	8/24/2009	Biennial	8/24/2011	4d026
SPEAG	DAE4	Dasy Data Acquisition Electronics	5/14/2009	Annual	5/14/2010	704
SPEAG	DAE4	Dasy Data Acquisition Electronics	5/25/2009	Annual	5/25/2010	665
SPEAG	DAE4	Dasy Data Acquisition Electronics	1/21/2009	Annual	1/21/2010	649
SPEAG	ES3DV2	SAR Probe	9/18/2009	Annual	9/18/2010	3022
SPEAG	EX3DV4	SAR Probe	1/21/2009	Annual	1/21/2010	3550
SPEAG	DAE4	Dasy Data Acquisition Electronics	7/21/2009	Annual	7/21/2010	859
SPEAG	D750V3	750 MHz Dipole	2/19/2009	Biennial	2/19/2011	1003
Rohde & Schwarz	CMU200	Base Station Simulator	6/12/2009	Annual	6/12/2010	836536/0005
Speag	ES3DV3	SAR Probe	4/15/2009	Annual	4/15/2010	3213
Speag	ES3DV3	SAR Probe	4/15/2009	Annual	4/15/2010	3209
Rohde & Schwarz	SMIQ03B	Signal Generator	5/21/2009	Annual	5/21/2010	832810/021
Speag	D1640V2	1640 MHz Dipole	8/21/2008	Biennial	8/21/2010	321
Rohde & Schwarz	CMW500	LTE Base Station Simulator	8/25/2009	Annual	8/25/2010	100976
Anritsu	MA2481A	Power Sensor	12/2/2009	Annual	12/2/2010	5318
Anritsu	MA2481A	Power Sensor	12/3/2009	Annual	12/3/2010	5442
Anritsu	ML2438A	Power Meter	12/3/2009	Annual	12/3/2010	1190013
Anritsu	ML2438A	Power Meter	12/3/2009	Annual	12/3/2010	98150041
Anritsu	ML2438A	Power Meter	12/3/2009	Annual	12/3/2010	1070030
Anritsu	MA2481A	Power Sensor	12/2/2009	Annual	12/2/2010	5821
Anritsu	MA2481A	Power Sensor	12/3/2009	Annual	12/3/2010	8013
Anritsu	MA2481A	Power Sensor	12/3/2009	Annual	12/3/2010	2400

### Notes:

The E-field probe was calibrated by SPEAG, by the waveguide technique procedure. Dipole Validation measurement is performed by PCTEST prior to SAR evaluation. The brain simulating material is calibrated by PCTEST using the dielectric probe system and network analyzer to determine the conductivity and permittivity (dielectric constant) of the brain-equivalent material.



FCC ID: BEJMN240	 PCTEST ENGINEERING LABORATORY, INC.	SAR COMPLIANCE REPORT	 LG	Reviewed by: Quality Manager
Filename: 0912182291.BEJ	Test Dates: 11/17/09 - 12/22/09	EUT Type: Cellular/AWS/PCS CDMA Phone w/ BT	Page 26 of 34	

# 17 CONCLUSION

## 17.1 Measurement Conclusion



The SAR evaluation indicates that the EUT complies with the RF radiation exposure limits of the FCC and Industry Canada, with respect to all parameters subject to this test. These measurements were taken to simulate the RF effects of RF exposure under worst-case conditions. Precise laboratory measures were taken to assure repeatability of the tests. The results and statements relate only to the item(s) tested.

Please note that the absorption and distribution of electromagnetic energy in the body are very complex phenomena that depend on the mass, shape, and size of the body, the orientation of the body with respect to the field vectors, and the electrical properties of both the body and the environment. Other variables that may play a substantial role in possible biological effects are those that characterize the environment (e.g. ambient temperature, air velocity, relative humidity, and body insulation) and those that characterize the individual (e.g. age, gender, activity level, debilitation, or disease). Because various factors may interact with one another to vary the specific biological outcome of an exposure to electromagnetic fields, any protection guide should consider maximal amplification of biological effects as a result of field-body interactions, environmental conditions, and physiological variables. [3]



FCC ID: BEJMN240	 PCTEST ENGINEERING LABORATORY, INC.	SAR COMPLIANCE REPORT	 LG	Reviewed by: Quality Manager
Filename: 0912182291.BEJ	Test Dates: 12/17/09 - 12/22/09	EUT Type: Cellular/AWS/PCS CDMA Phone w/ BT		Page 27 of 34

## 18 REFERENCES

- [1] Federal Communications Commission, ET Docket 93-62, Guidelines for Evaluating the Environmental Effects of Radiofrequency Radiation, Aug. 1996.
- [2] ANSI/IEEE C95.1-2005, American National Standard safety levels with respect to human exposure to radio frequency electromagnetic fields, 300kHz to 100GHz, New York: IEEE, 2006.
- [3] ANSI/IEEE C95.1-1992, American National Standard safety levels with respect to human exposure to radio frequency electromagnetic fields, 300kHz to 100GHz, New York: IEEE, Sept. 1992.
- [4] ANSI/IEEE C95.3-2002, IEEE Recommended Practice for the Measurement of Potentially Hazardous Electromagnetic Fields - RF and Microwave, New York: IEEE, December 2002.
- [5] Federal Communications Commission, OET Bulletin 65 (Edition 97-01), Supplement C (Edition 01-01), Evaluating Compliance with FCC Guidelines for Human Exposure to Radiofrequency Electromagnetic Fields, July 2001.
- [6] IEEE Standards Coordinating Committee 34 – IEEE Std. 1528-2003, Recommended Practice for Determining the Peak Spatial-Average Specific Absorption Rate (SAR) in the Human Body Due to Wireless Communications Devices.
- [7] NCRP, National Council on Radiation Protection and Measurements, Biological Effects and Exposure Criteria for RadioFrequency Electromagnetic Fields, NCRP Report No. 86, 1986. Reprinted Feb. 1995.
- [8] T. Schmid, O. Egger, N. Kuster, Automated E-field scanning system for dosimetric assessments, IEEE Transaction on Microwave Theory and Techniques, vol. 44, Jan. 1996, pp. 105-113.
- [9] K. Pokovic, T. Schmid, N. Kuster, Robust setup for precise calibration of E-field probes in tissue simulating liquids at mobile communications frequencies, ICECOM97, Oct. 1997, pp. 120-124.
- [10] K. Pokovic, T. Schmid, and N. Kuster, E-field Probe with improved isotropy in brain simulating liquids, Proceedings of the ELMAR, Zadar, Croatia, June 23-25, 1996, pp. 172-175.
- [11] Schmid & Partner Engineering AG, Application Note: Data Storage and Evaluation, June 1998, p2.
- [12] V. Hombach, K. Meier, M. Burkhardt, E. Kuhn, N. Kuster, The Dependence of EM Energy Absorption upon Human Head Modeling at 900 MHz, IEEE Transaction on Microwave Theory and Techniques, vol. 44 no. 10, Oct. 1996, pp. 1865-1873.
- [13] N. Kuster and Q. Balzano, Energy absorption mechanism by biological bodies in the near field of dipole antennas above 300MHz, IEEE Transaction on Vehicular Technology, vol. 41, no. 1, Feb. 1992, pp. 17-23.
- [14] G. Hartsgrrove, A. Kraszewski, A. Surowiec, Simulated Biological Materials for Electromagnetic Radiation Absorption Studies, University of Ottawa, Bioelectromagnetics, Canada: 1987, pp. 29-36.
- [15] Q. Balzano, O. Garay, T. Manning Jr., Electromagnetic Energy Exposure of Simulated Users of Portable Cellular Telephones, IEEE Transactions on Vehicular Technology, vol. 44, no.3, Aug. 1995.

FCC ID: BEJMN240	 PCTEST ENGINEERING LABORATORY, INC.	SAR COMPLIANCE REPORT	 LG	Reviewed by: Quality Manager
Filename: 0912182291.BEJ	Test Dates: 12/17/09 - 12/22/09	EUT Type: Cellular/AWS/PCS CDMA Phone w/ BT		Page 28 of 34

- [16] W. Gander, Computermathematick, Birkhaeuser, Basel, 1992.
- [17] W.H. Press, S.A. Teukolsky, W.T. Vetterling, and B.P. Flannery, Numerical Receptions in C, The Art of Scientific Computing, Second edition, Cambridge University Press, 1992.
- [18] Federal Communications Commission, OET Bulletin 65, Evaluating Compliance with FCC Guidelines for Human Exposure to Radiofrequency Electromagnetic Fields. Supplement C, Dec. 1997.
- [19] N. Kuster, R. Kastle, T. Schmid, Dosimetric evaluation of mobile communications equipment with known precision, IEEE Transaction on Communications, vol. E80-B, no. 5, May 1997, pp. 645-652.
- [20] CENELEC CLC/SC111B, European Prestandard (prENV 50166-2), Human Exposure to Electromagnetic Fields High-frequency: 10kHz-300GHz, Jan. 1995.
- [21] Prof. Dr. Niels Kuster, ETH, Eidgenössische Technische Hochschule Zürich, Dosimetric Evaluation of the Cellular Phone.
- [22] IEC 62209-1, Human exposure to radio frequency fields from hand-held and body-mounted wireless communication devices - Human models, instrumentation, and procedures - Part 1: Procedure to determine the specific absorption rate (SAR) for hand-held devices used in close proximity to the ear (frequency range of 300 MHz to 3 GHz), Feb. 2005.
- [23] Industry Canada RSS-102 Radio Frequency Exposure Compliance of Radiocommunication Apparatus (All Frequency Bands) Issue 3, June 2009
- [24] Health Canada Safety Code 6 Limits of Human Exposure to Radio Frequency Electromagnetic Fields in the Frequency Range from 3 kHz – 300 GHz, 2009
- [25] FCC Public Notice DA-02-1438. Office of Engineering and Technology Announces a Transition Period for the Phantom Requirements of Supplement C to OET Bulletin 65, June 19, 2002
- [26] FCC SAR Measurement Procedures for 3G Devices KDB 941225
- [27] SAR Measurement procedures for IEEE 802.11a/b/g KDB 248227
- [28] FCC SAR Considerations for Handsets with Multiple Transmitters and Antennas, KDB 648474
- [29] FCC Application Note for SAR Probe Calibration and System Verification Consideration for Measurements at 150 MHz – 3 GHz, KDB 450824
- [30] FCC SAR Evaluation Considerations for Laptop Computers with Antennas Built-in on Display Screens, KDB 616217
- [31] FCC SAR Measurement Requirements for 3 – 6 GHz, KDB 865664
- [32] FCC Mobile Portable RF Exposure Procedure, KDB 447498
- [33] FCC SAR Procedures for Dongle Transmitters, KDB 447498

FCC ID: BEJMN240	 <b>PCTEST</b> ENGINEERING LABORATORY, INC.	<b>SAR COMPLIANCE REPORT</b>		<b>Reviewed by:</b> Quality Manager
<b>Filename:</b> 0912182291.BEJ	<b>Test Dates:</b> 12/17/09 - 12/22/09	<b>EUT Type:</b> Cellular/AWS/PCS CDMA Phone w/ BT		Page 29 of 34

## **APPENDIX A: SAR TEST DATA**

# PCTEST ENGINEERING LABORATORY, INC.

**DUT: MN240, LW240; Type: Cellular/AWS/PCS CDMA Phone w/ BT; Serial: RF**

Communication System: Cellular CDMA; Frequency: 836.52 MHz; Duty Cycle: 1:1

Medium: 835 Brain Medium parameters used (interpolated):  
 $f = 836.52 \text{ MHz}$ ;  $\sigma = 0.898 \text{ mho/m}$ ;  $\epsilon_r = 40.3$ ;  $\rho = 1000 \text{ kg/m}^3$

Phantom section: Right Section

Test Date: 12-21-2009; Ambient Temp: 24.1 °C; Tissue Temp: 23.3 °C

Probe: ES3DV3 - SN3209; ConvF(6.1, 6.1, 6.1); Calibrated: 4/15/2009

Sensor-Surface: 3mm (Mechanical Surface Detection)

Electronics: DAE4 Sn665; Calibrated: 5/25/2009

Phantom: SAM with CRP; Type: SAM; Serial: TP1375

Measurement SW: DASY4, V4.7 Build 71; Postprocessing SW: SEMCAD, V1.8 Build 184

**Mode: Cellular CDMA, Right Head, Slide In, Touch, Mid.ch**

**Area Scan (7x10x1):** Measurement grid:  $dx=15\text{mm}$ ,  $dy=15\text{mm}$

**Zoom Scan (5x5x7)/Cube 0:** Measurement grid:  $dx=8\text{mm}$ ,  $dy=8\text{mm}$ ,  $dz=5\text{mm}$

Reference Value = 28.5 V/m

Peak SAR (extrapolated) = 0.875 W/kg

**SAR(1 g) = 0.720 mW/g; SAR(10 g) = 0.540 mW/g**

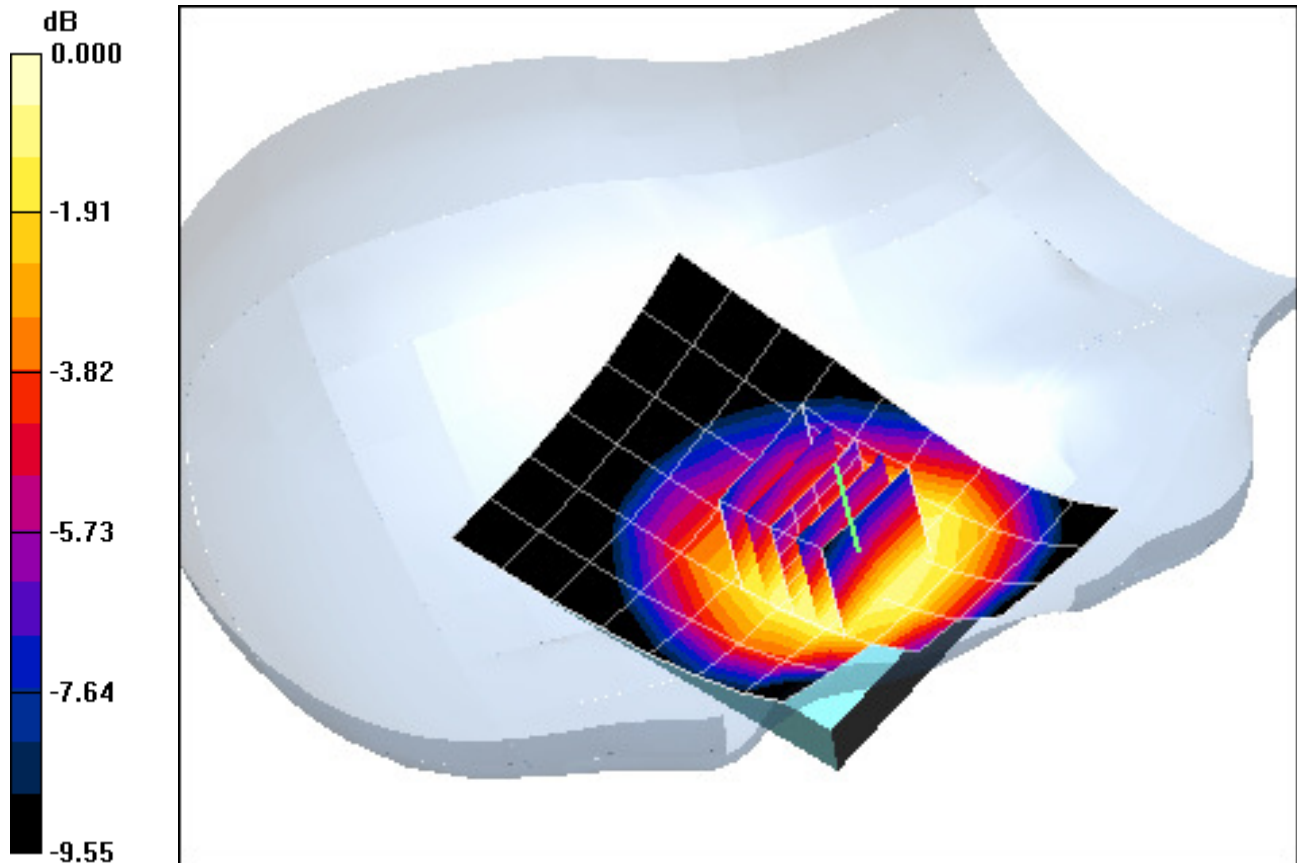

0 dB = 0.773mW/g

# PCTEST ENGINEERING LABORATORY, INC.

**DUT: MN240, LW240; Type: Cellular/AWS/PCS CDMA Phone w/ BT; Serial: RF**

Communication System: Cellular CDMA; Frequency: 836.52 MHz; Duty Cycle: 1:1

Medium: 835 Brain Medium parameters used (interpolated):  
 $f = 836.52 \text{ MHz}$ ;  $\sigma = 0.898 \text{ mho/m}$ ;  $\epsilon_r = 40.3$ ;  $\rho = 1000 \text{ kg/m}^3$

Phantom section: Right Section

Test Date: 12-21-2009; Ambient Temp: 24.1 °C; Tissue Temp: 23.3 °C

Probe: ES3DV3 - SN3209; ConvF(6.1, 6.1, 6.1); Calibrated: 4/15/2009

Sensor-Surface: 3mm (Mechanical Surface Detection)

Electronics: DAE4 Sn665; Calibrated: 5/25/2009

Phantom: SAM with CRP; Type: SAM; Serial: TP1375

Measurement SW: DASY4, V4.7 Build 71; Postprocessing SW: SEMCAD, V1.8 Build 184

**Mode: Cellular CDMA, Right Head, Slide In, Tilt, Mid.ch**

**Area Scan (7x10x1):** Measurement grid:  $dx=15\text{mm}$ ,  $dy=15\text{mm}$

**Zoom Scan (5x5x7)/Cube 0:** Measurement grid:  $dx=8\text{mm}$ ,  $dy=8\text{mm}$ ,  $dz=5\text{mm}$

Reference Value = 20.4 V/m

Peak SAR (extrapolated) = 0.436 W/kg

**SAR(1 g) = 0.351 mW/g; SAR(10 g) = 0.265 mW/g**

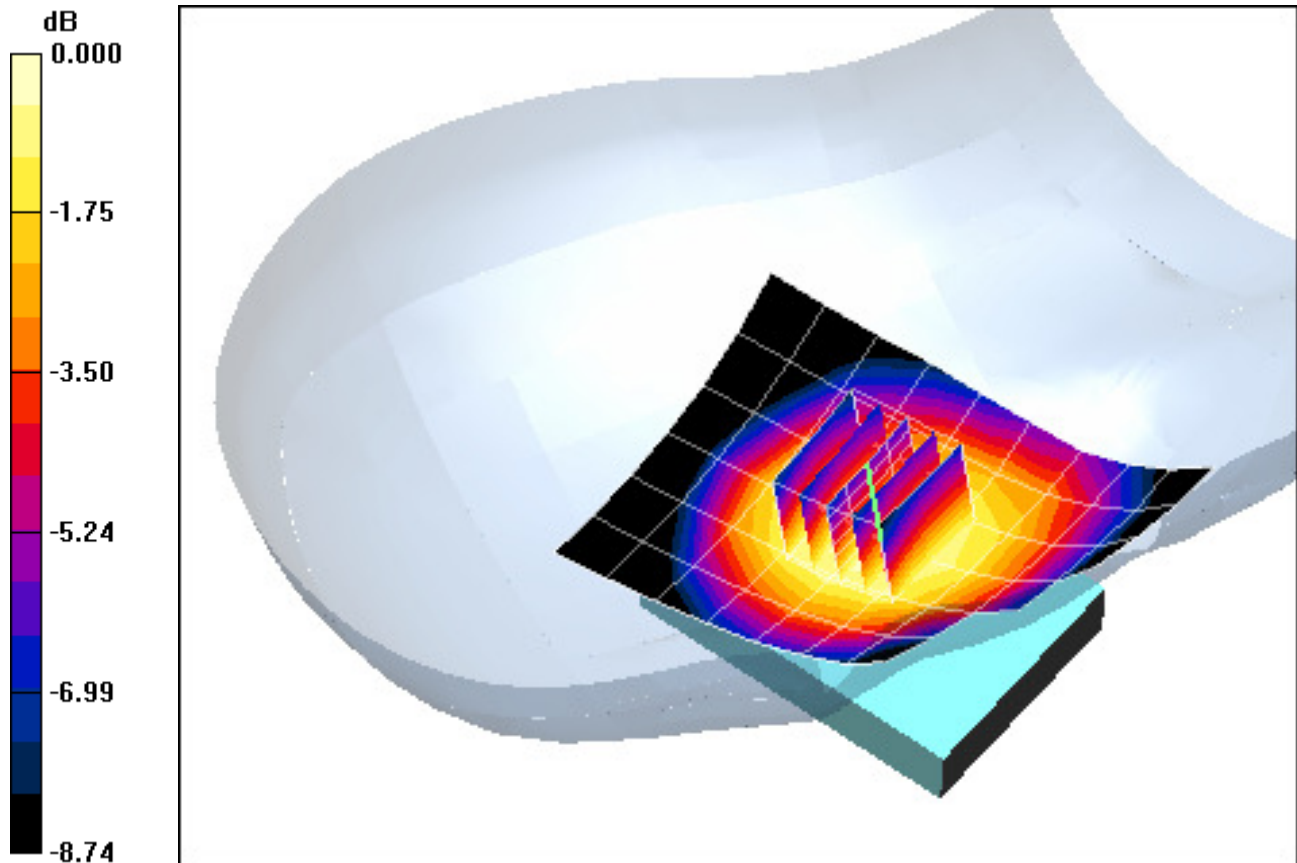

0 dB = 0.382mW/g

# PCTEST ENGINEERING LABORATORY, INC.

**DUT: MN240, LW240; Type: Cellular/AWS/PCS CDMA Phone w/ BT; Serial: RF**

Communication System: Cellular CDMA; Frequency: 836.52 MHz; Duty Cycle: 1:1

Medium: 835 Brain Medium parameters used (interpolated):  
 $f = 836.52 \text{ MHz}$ ;  $\sigma = 0.898 \text{ mho/m}$ ;  $\epsilon_r = 40.3$ ;  $\rho = 1000 \text{ kg/m}^3$

Phantom section: Left Section

Test Date: 12-21-2009; Ambient Temp: 24.1 °C; Tissue Temp: 23.3 °C

Probe: ES3DV3 - SN3209; ConvF(6.1, 6.1, 6.1); Calibrated: 4/15/2009

Sensor-Surface: 3mm (Mechanical Surface Detection)

Electronics: DAE4 Sn665; Calibrated: 5/25/2009

Phantom: SAM with CRP; Type: SAM; Serial: TP1375

Measurement SW: DASY4, V4.7 Build 71; Postprocessing SW: SEMCAD, V1.8 Build 184

**Mode: Cellular CDMA, Left Head, Slide In, Touch, Mid.ch**

**Area Scan (7x10x1):** Measurement grid:  $dx=15\text{mm}$ ,  $dy=15\text{mm}$

**Zoom Scan (5x5x7)/Cube 0:** Measurement grid:  $dx=8\text{mm}$ ,  $dy=8\text{mm}$ ,  $dz=5\text{mm}$

Reference Value = 27.7 V/m

Peak SAR (extrapolated) = 0.862 W/kg

**SAR(1 g) = 0.660 mW/g; SAR(10 g) = 0.482 mW/g**

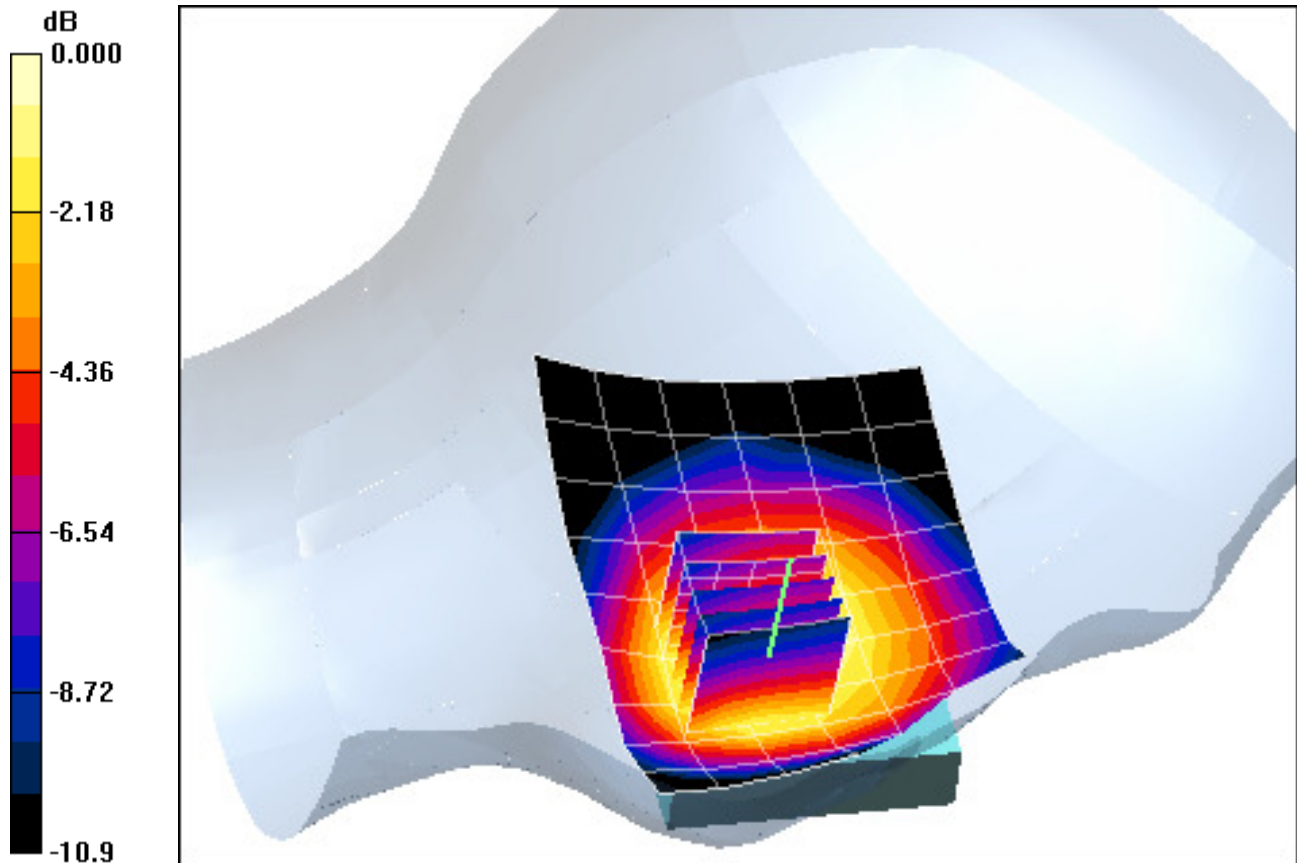

0 dB = 0.723mW/g

# PCTEST ENGINEERING LABORATORY, INC.

**DUT: MN240, LW240; Type: Cellular/AWS/PCS CDMA Phone w/ BT; Serial: RF**

Communication System: Cellular CDMA; Frequency: 836.52 MHz; Duty Cycle: 1:1

Medium: 835 Brain Medium parameters used (interpolated):  
 $f = 836.52 \text{ MHz}$ ;  $\sigma = 0.898 \text{ mho/m}$ ;  $\epsilon_r = 40.3$ ;  $\rho = 1000 \text{ kg/m}^3$

Phantom section: Left Section

Test Date: 12-21-2009; Ambient Temp: 24.1 °C; Tissue Temp: 23.3 °C

Probe: ES3DV3 - SN3209; ConvF(6.1, 6.1, 6.1); Calibrated: 4/15/2009

Sensor-Surface: 3mm (Mechanical Surface Detection)

Electronics: DAE4 Sn665; Calibrated: 5/25/2009

Phantom: SAM with CRP; Type: SAM; Serial: TP1375

Measurement SW: DASY4, V4.7 Build 71; Postprocessing SW: SEMCAD, V1.8 Build 184

**Mode: Cellular CDMA, Left Head, Slide In, Tilt, Mid.ch**

**Area Scan (7x10x1):** Measurement grid:  $dx=15\text{mm}$ ,  $dy=15\text{mm}$

**Zoom Scan (5x5x7)/Cube 0:** Measurement grid:  $dx=8\text{mm}$ ,  $dy=8\text{mm}$ ,  $dz=5\text{mm}$

Reference Value = 20.7 V/m

Peak SAR (extrapolated) = 0.442 W/kg

**SAR(1 g) = 0.352 mW/g; SAR(10 g) = 0.264 mW/g**

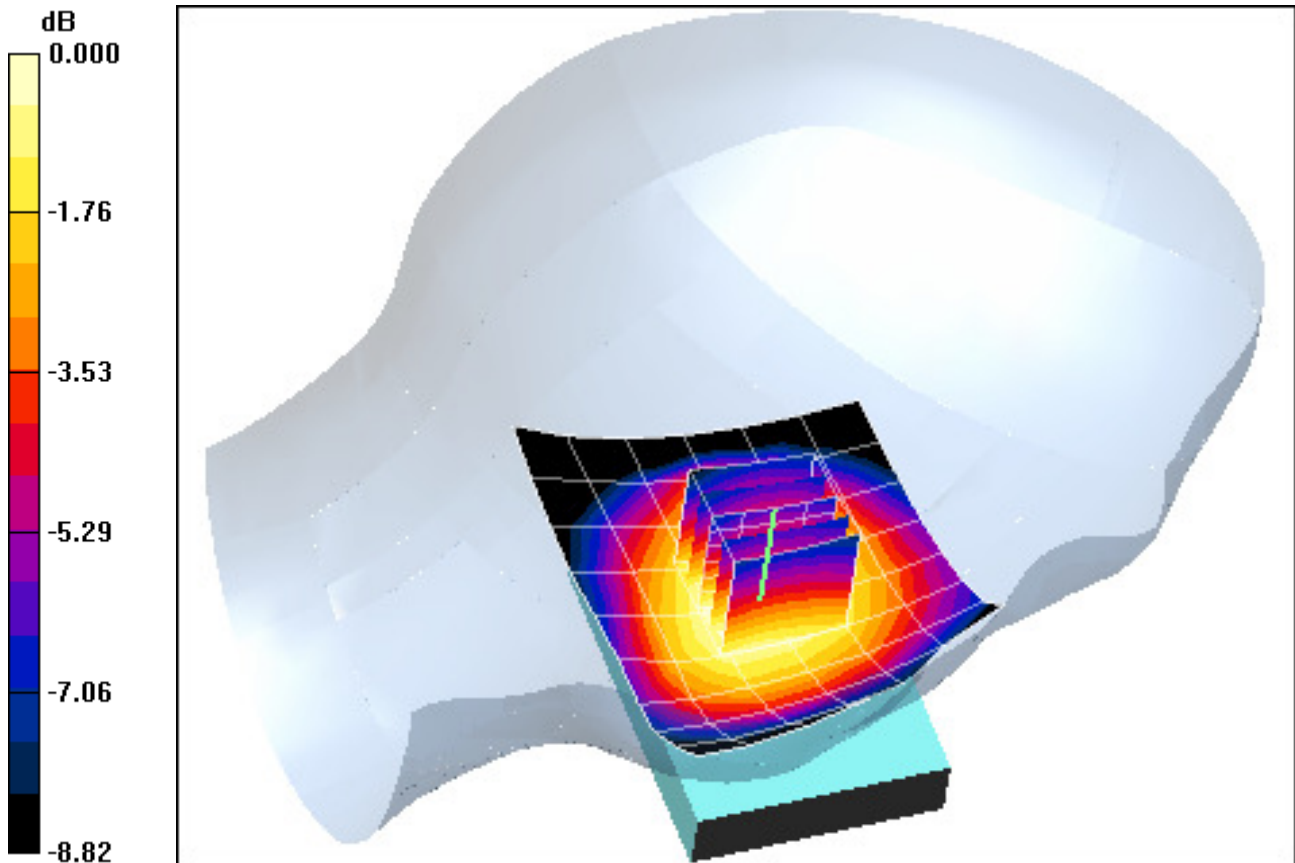

0 dB = 0.387mW/g

# PCTEST ENGINEERING LABORATORY, INC.

**DUT: MN240, LW240; Type: Cellular/AWS/PCS CDMA Phone w/ BT; Serial: RF**

Communication System: Cellular CDMA; Frequency: 824.7 MHz; Duty Cycle: 1:1

Medium: 835 Brain Medium parameters used (interpolated):

$f = 824.7 \text{ MHz}$ ;  $\sigma = 0.888 \text{ mho/m}$ ;  $\epsilon_r = 40.5$ ;  $\rho = 1000 \text{ kg/m}^3$

Phantom section: Right Section

Test Date: 12-18-2009; Ambient Temp: 23.9 °C; Tissue Temp: 22.5 °C

Probe: ES3DV3 - SN3209; ConvF(6.1, 6.1, 6.1); Calibrated: 4/15/2009

Sensor-Surface: 3mm (Mechanical Surface Detection)

Electronics: DAE4 Sn665; Calibrated: 5/25/2009

Phantom: SAM with CRP; Type: SAM; Serial: TP1375

Measurement SW: DASY4, V4.7 Build 71; Postprocessing SW: SEMCAD, V1.8 Build 184

**Mode: Cellular CDMA, Right Head, Slide Out, Touch, Low.ch**

**Area Scan (7x10x1):** Measurement grid: dx=15mm, dy=15mm

**Zoom Scan (5x5x7)/Cube 0:** Measurement grid: dx=8mm, dy=8mm, dz=5mm

Reference Value = 37.5 V/m

Peak SAR (extrapolated) = 1.53 W/kg

**SAR(1 g) = 1.22 mW/g; SAR(10 g) = 0.912 mW/g**

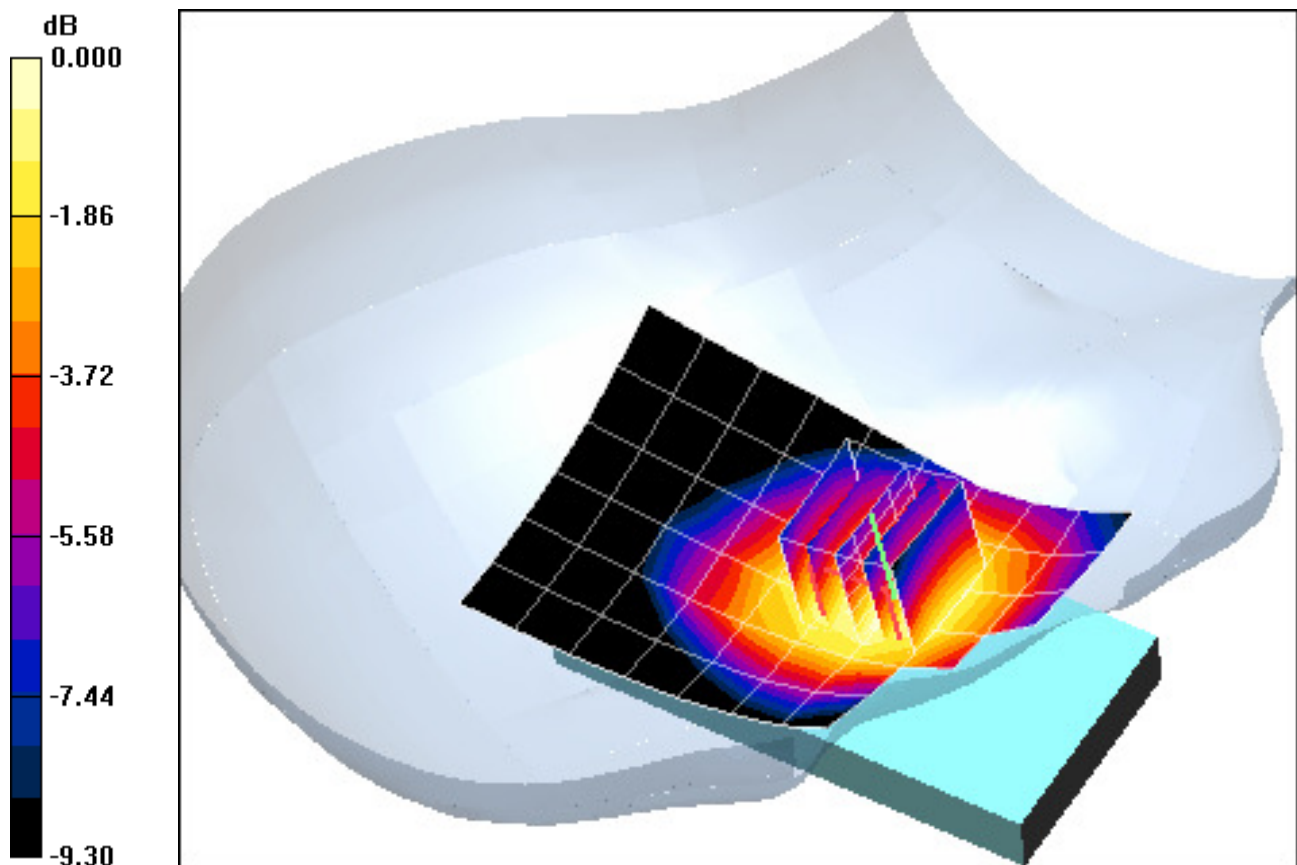

0 dB = 1.35mW/g

# PCTEST ENGINEERING LABORATORY, INC.

**DUT: MN240, LW240; Type: Cellular/AWS/PCS CDMA Phone w/ BT; Serial: RF**

Communication System: Cellular CDMA; Frequency: 824.7 MHz; Duty Cycle: 1:1

Medium: 835 Brain Medium parameters used (interpolated):

$f = 824.7 \text{ MHz}$ ;  $\sigma = 0.888 \text{ mho/m}$ ;  $\epsilon_r = 40.5$ ;  $\rho = 1000 \text{ kg/m}^3$

Phantom section: Right Section

Test Date: 12-18-2009; Ambient Temp: 23.9 °C; Tissue Temp: 22.5 °C

Probe: ES3DV3 - SN3209; ConvF(6.1, 6.1, 6.1); Calibrated: 4/15/2009

Sensor-Surface: 3mm (Mechanical Surface Detection)

Electronics: DAE4 Sn665; Calibrated: 5/25/2009

Phantom: SAM with CRP; Type: SAM; Serial: TP1375

Measurement SW: DASY4, V4.7 Build 71; Postprocessing SW: SEMCAD, V1.8 Build 184

**Mode: Cellular CDMA, Right Head, Slide Out, Touch, Low.ch**

**Area Scan (7x10x1):** Measurement grid: dx=15mm, dy=15mm

**Zoom Scan (5x5x7)/Cube 0:** Measurement grid: dx=8mm, dy=8mm, dz=5mm

Reference Value = 37.5 V/m

Peak SAR (extrapolated) = 1.53 W/kg

**SAR(1 g) = 1.22 mW/g; SAR(10 g) = 0.912 mW/g**

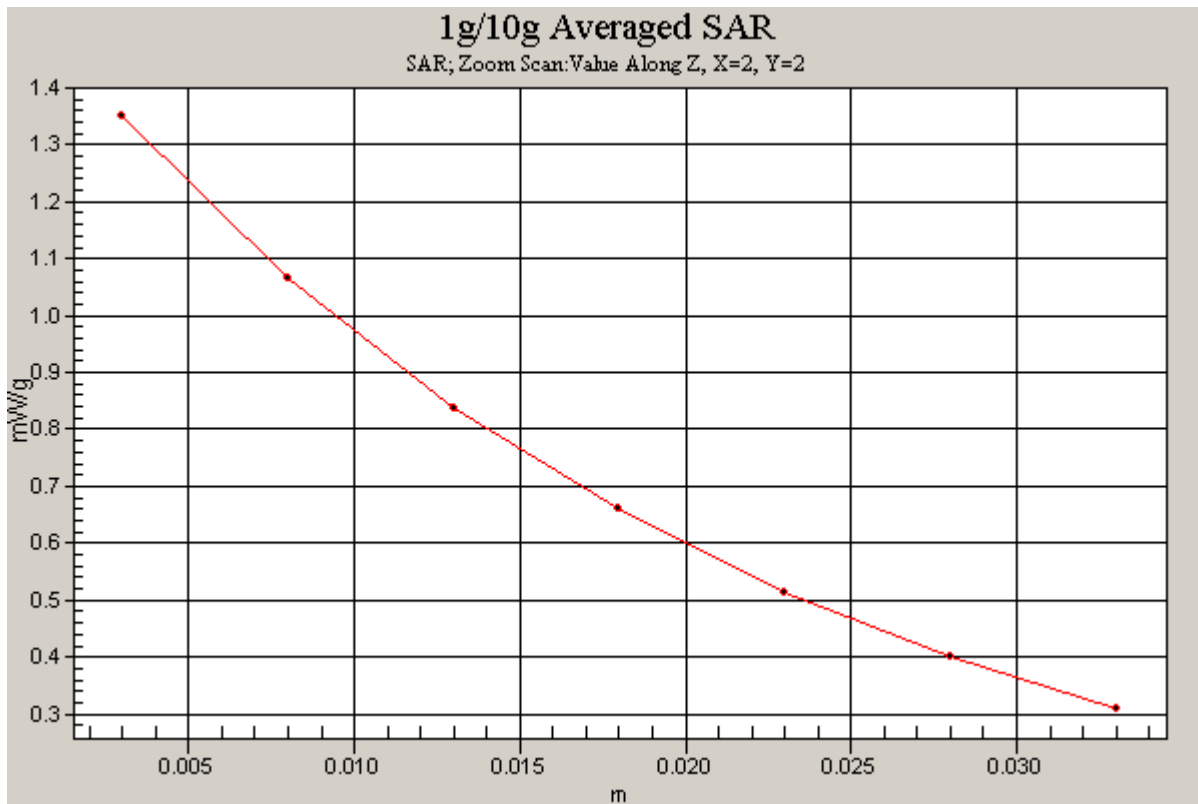

# PCTEST ENGINEERING LABORATORY, INC.

**DUT: MN240, LW240; Type: Cellular/AWS/PCS CDMA Phone w/ BT; Serial: RF**

Communication System: Cellular CDMA; Frequency: 836.52 MHz; Duty Cycle: 1:1

Medium: 835 Brain Medium parameters used (interpolated):  
 $f = 836.52 \text{ MHz}$ ;  $\sigma = 0.898 \text{ mho/m}$ ;  $\epsilon_r = 40.3$ ;  $\rho = 1000 \text{ kg/m}^3$

Phantom section: Right Section

Test Date: 12-21-2009; Ambient Temp: 24.1 °C; Tissue Temp: 23.3 °C

Probe: ES3DV3 - SN3209; ConvF(6.1, 6.1, 6.1); Calibrated: 4/15/2009

Sensor-Surface: 3mm (Mechanical Surface Detection)

Electronics: DAE4 Sn665; Calibrated: 5/25/2009

Phantom: SAM with CRP; Type: SAM; Serial: TP1375

Measurement SW: DASY4, V4.7 Build 71; Postprocessing SW: SEMCAD, V1.8 Build 184

**Mode: Cellular CDMA, Right Head, Slide Out, Tilt, Mid.ch**

**Area Scan (7x10x1):** Measurement grid: dx=15mm, dy=15mm

**Zoom Scan (5x5x7)/Cube 0:** Measurement grid: dx=8mm, dy=8mm, dz=5mm

Reference Value = 26.6 V/m

Peak SAR (extrapolated) = 0.763 W/kg

**SAR(1 g) = 0.602 mW/g; SAR(10 g) = 0.451 mW/g**

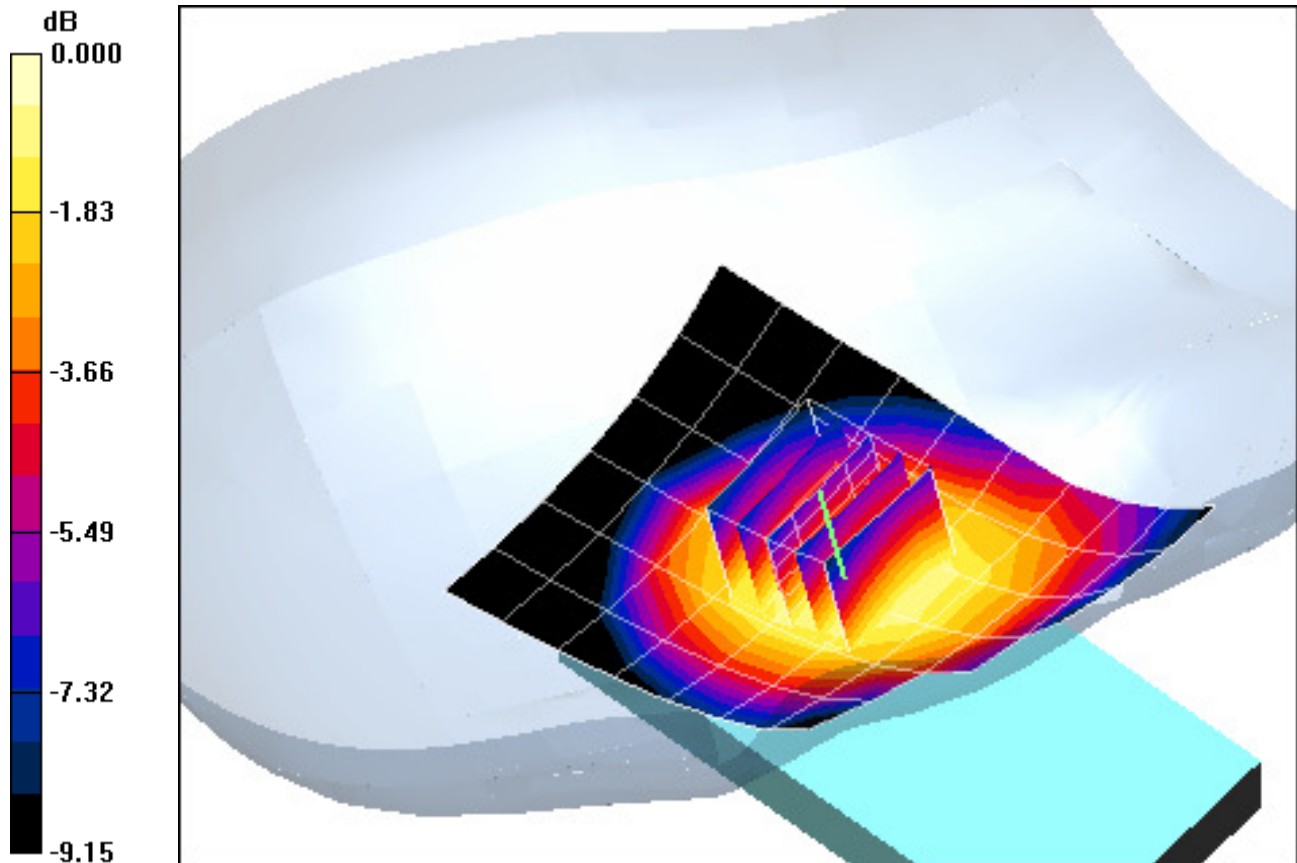

0 dB = 0.666mW/g

# PCTEST ENGINEERING LABORATORY, INC.

**DUT: MN240, LW240; Type: Cellular/AWS/PCS CDMA Phone w/ BT; Serial: RF**

Communication System: Cellular CDMA; Frequency: 848.31 MHz; Duty Cycle: 1:1

Medium: 835 Brain Medium parameters used (interpolated):

$f = 848.31 \text{ MHz}$ ;  $\sigma = 0.908 \text{ mho/m}$ ;  $\epsilon_r = 40.2$ ;  $\rho = 1000 \text{ kg/m}^3$

Phantom section: Left Section

Test Date: 12-21-2009; Ambient Temp: 24.1 °C; Tissue Temp: 23.3 °C

Probe: ES3DV3 - SN3209; ConvF(6.1, 6.1, 6.1); Calibrated: 4/15/2009

Sensor-Surface: 3mm (Mechanical Surface Detection)

Electronics: DAE4 Sn665; Calibrated: 5/25/2009

Phantom: SAM with CRP; Type: SAM; Serial: TP1375

Measurement SW: DASY4, V4.7 Build 71; Postprocessing SW: SEMCAD, V1.8 Build 184

**Mode: Cellular CDMA, Left Head, Slide Out, Touch, High.ch**

**Area Scan (7x10x1):** Measurement grid:  $dx=15\text{mm}$ ,  $dy=15\text{mm}$

**Zoom Scan (5x5x7)/Cube 0:** Measurement grid:  $dx=8\text{mm}$ ,  $dy=8\text{mm}$ ,  $dz=5\text{mm}$

Reference Value = 35.1 V/m

Peak SAR (extrapolated) = 1.45 W/kg

**SAR(1 g) = 1.09 mW/g; SAR(10 g) = 0.783 mW/g**

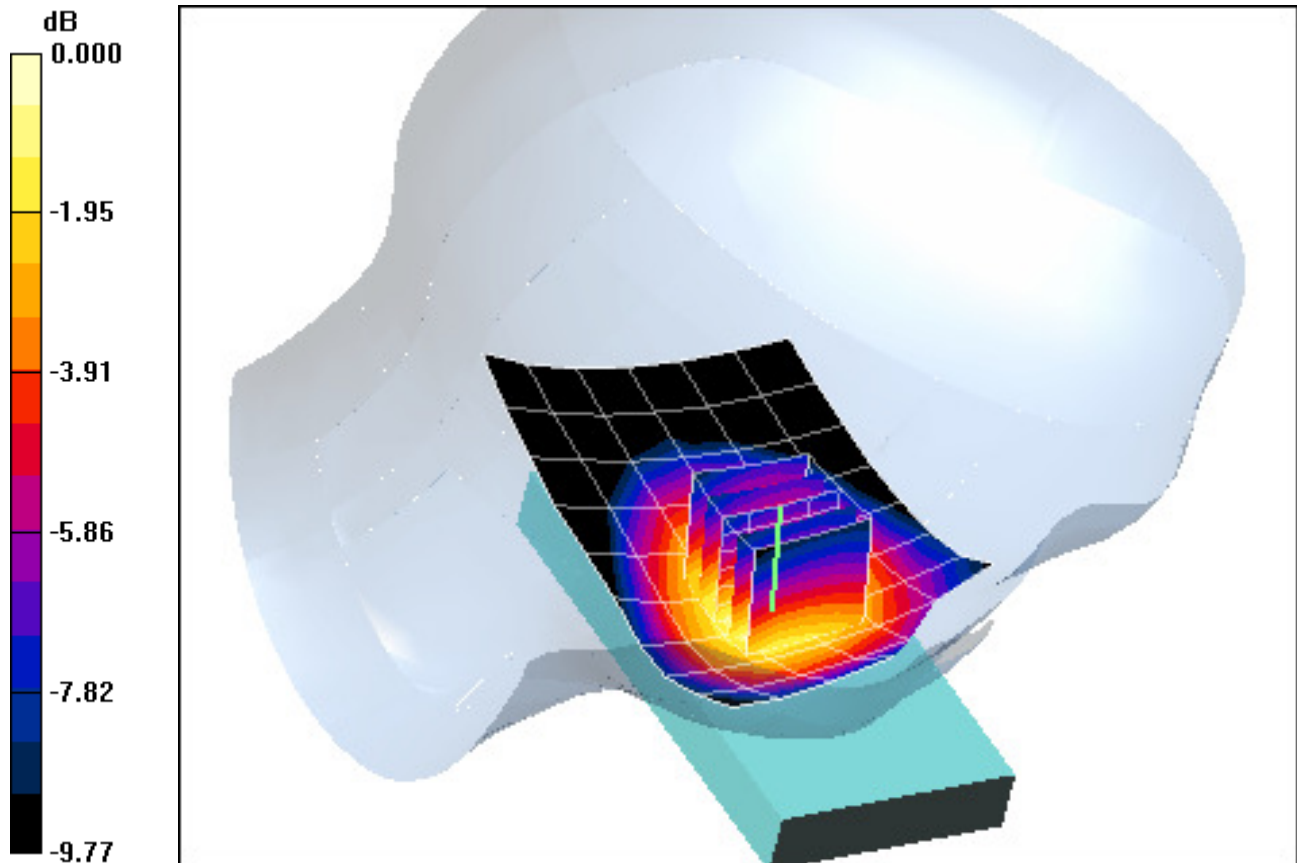

0 dB = 1.25mW/g

# PCTEST ENGINEERING LABORATORY, INC.

**DUT: MN240, LW240; Type: Cellular/AWS/PCS CDMA Phone w/ BT; Serial: RF**

Communication System: Cellular CDMA; Frequency: 835 MHz; Duty Cycle: 1:1

Medium: 835 Brain Medium parameters used:

$f = 835 \text{ MHz}$ ;  $\sigma = 0.897 \text{ mho/m}$ ;  $\epsilon_r = 40.3$ ;  $\rho = 1000 \text{ kg/m}^3$

Phantom section: Left Section

Test Date: 12-21-2009; Ambient Temp: 24.1 °C; Tissue Temp: 23.3 °C

Probe: ES3DV3 - SN3209; ConvF(6.1, 6.1, 6.1); Calibrated: 4/15/2009

Sensor-Surface: 3mm (Mechanical Surface Detection)

Electronics: DAE4 Sn665; Calibrated: 5/25/2009

Phantom: SAM with CRP; Type: SAM; Serial: TP1375

Measurement SW: DASY4, V4.7 Build 71; Postprocessing SW: SEMCAD, V1.8 Build 184

**Mode: Cellular CDMA, Left Head, Slide Out, Tilt, Mid.ch**

**Area Scan (7x10x1):** Measurement grid: dx=15mm, dy=15mm

**Zoom Scan (5x5x7)/Cube 0:** Measurement grid: dx=8mm, dy=8mm, dz=5mm

Reference Value = 26.2 V/m

Peak SAR (extrapolated) = 0.709 W/kg

**SAR(1 g) = 0.565 mW/g; SAR(10 g) = 0.424 mW/g**

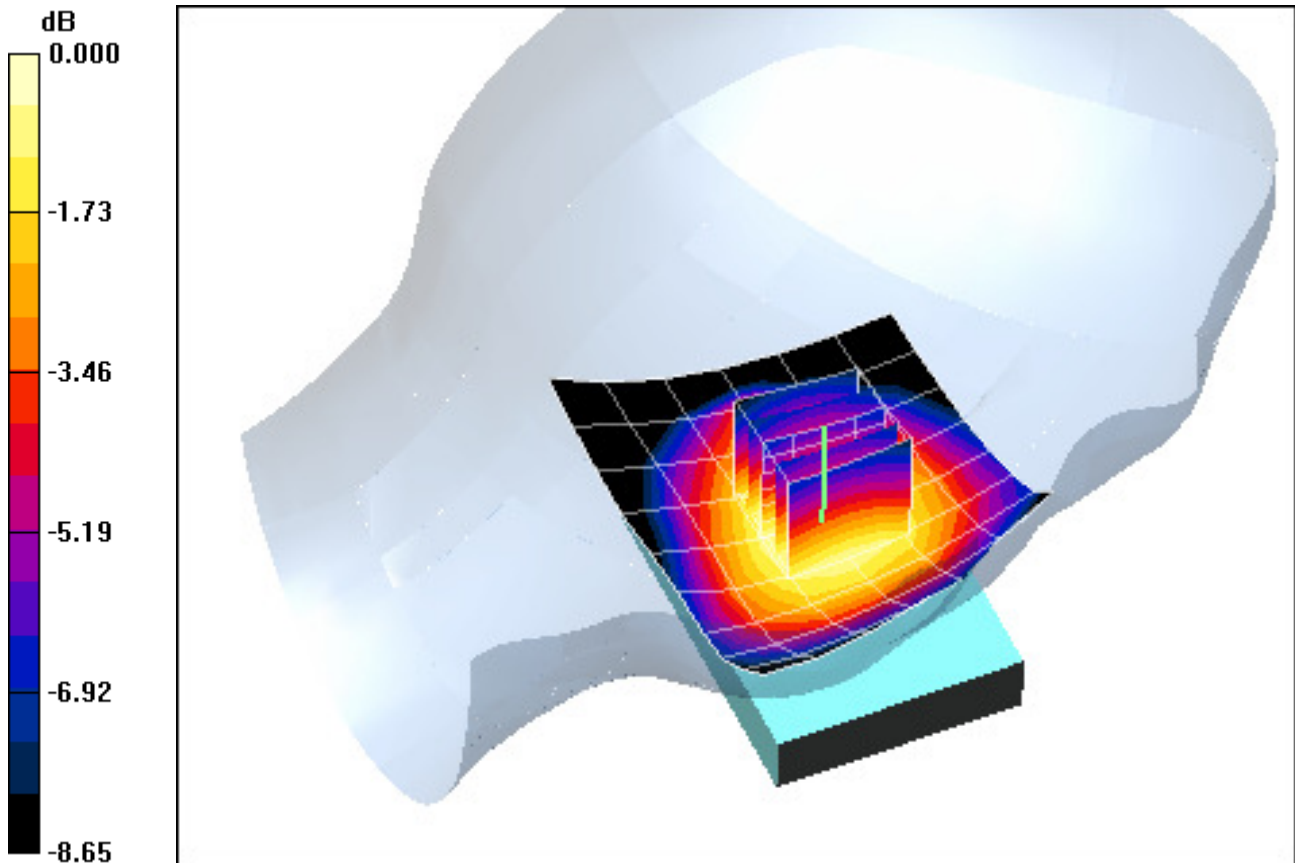

0 dB = 0.621mW/g

# PCTEST ENGINEERING LABORATORY, INC.

**DUT: MN240, LW240; Type: Cellular/AWS/PCS CDMA Phone w/ BT; Serial: SAR #1**

Communication System: AWS CDMA; Frequency: 1732.5 MHz; Duty Cycle: 1:1

Medium: 1750 Brain Medium parameters used (interpolated):

$f = 1732.5 \text{ MHz}$ ;  $\sigma = 1.31 \text{ mho/m}$ ;  $\epsilon_r = 40.8$ ;  $\rho = 1000 \text{ kg/m}^3$

Phantom section: Right Section

Test Date: 12-22-2009; Ambient Temp: 23.9 °C; Tissue Temp: 22.0 °C

Probe: ES3DV3 - SN3209; ConvF(5.29, 5.29, 5.29); Calibrated: 4/15/2009

Sensor-Surface: 3mm (Mechanical Surface Detection)

Electronics: DAE4 Sn665; Calibrated: 5/25/2009

Phantom: SAM with CRP; Type: SAM; Serial: TP1375

Measurement SW: DASY4, V4.7 Build 71; Postprocessing SW: SEMCAD, V1.8 Build 184

**Mode: AWS CDMA, Right Head, Slide In, Touch, Mid.ch**

**Area Scan (7x10x1):** Measurement grid: dx=15mm, dy=15mm

**Zoom Scan (5x5x7)/Cube 0:** Measurement grid: dx=8mm, dy=8mm, dz=5mm

Reference Value = 21.6 V/m

Peak SAR (extrapolated) = 0.849 W/kg

**SAR(1 g) = 0.570 mW/g; SAR(10 g) = 0.370 mW/g**

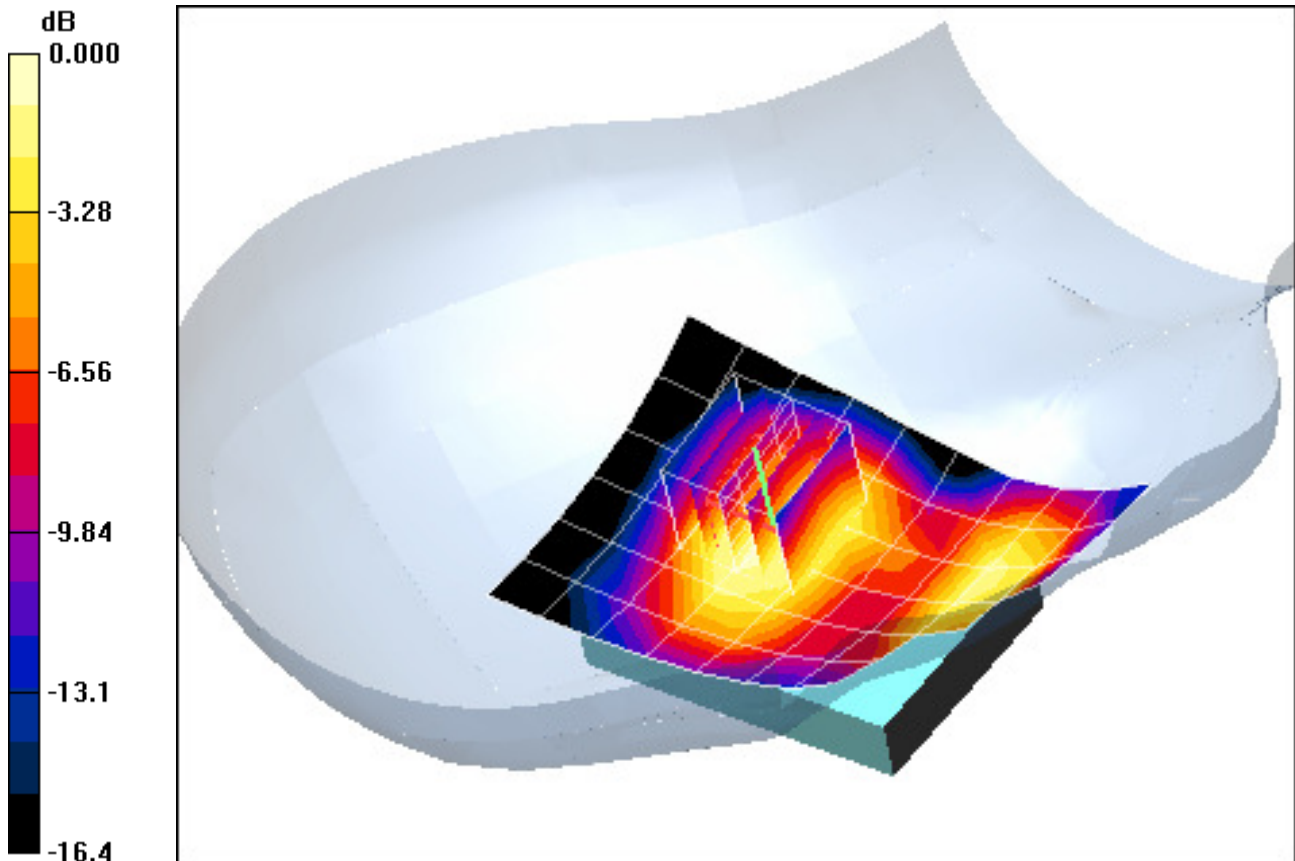

0 dB = 0.655mW/g

# PCTEST ENGINEERING LABORATORY, INC.

**DUT: MN240, LW240; Type: Cellular/AWS/PCS CDMA Phone w/ BT; Serial: SAR #1**

Communication System: AWS CDMA; Frequency: 1732.5 MHz; Duty Cycle: 1:1

Medium: 1750 Brain Medium parameters used (interpolated):

$f = 1732.5 \text{ MHz}$ ;  $\sigma = 1.31 \text{ mho/m}$ ;  $\epsilon_r = 40.8$ ;  $\rho = 1000 \text{ kg/m}^3$

Phantom section: Right Section

Test Date: 12-22-2009; Ambient Temp: 23.9 °C; Tissue Temp: 22.0 °C

Probe: ES3DV3 - SN3209; ConvF(5.29, 5.29, 5.29); Calibrated: 4/15/2009

Sensor-Surface: 3mm (Mechanical Surface Detection)

Electronics: DAE4 Sn665; Calibrated: 5/25/2009

Phantom: SAM with CRP; Type: SAM; Serial: TP1375

Measurement SW: DASY4, V4.7 Build 71; Postprocessing SW: SEMCAD, V1.8 Build 184

**Mode: AWS CDMA, Right Head, Slide In, Tilt, Mid.ch**

**Area Scan (7x10x1):** Measurement grid: dx=15mm, dy=15mm

**Zoom Scan (5x5x7)/Cube 0:** Measurement grid: dx=8mm, dy=8mm, dz=5mm

Reference Value = 18.5 V/m

Peak SAR (extrapolated) = 0.656 W/kg

**SAR(1 g) = 0.414 mW/g; SAR(10 g) = 0.255 mW/g**

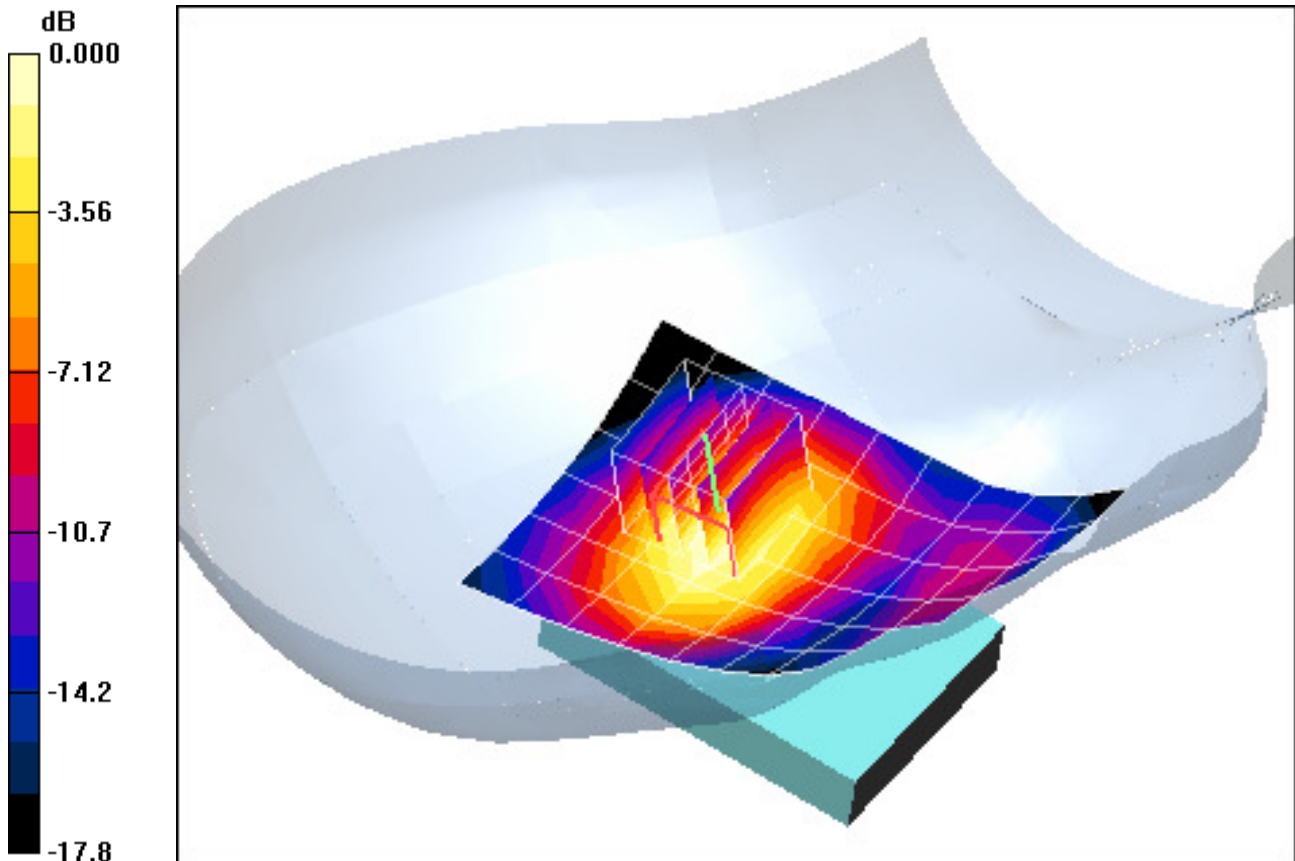

0 dB = 0.492mW/g

# PCTEST ENGINEERING LABORATORY, INC.

**DUT: MN240, LW240; Type: Cellular/AWS/PCS CDMA Phone w/ BT; Serial: SAR #1**

Communication System: AWS CDMA; Frequency: 1732.5 MHz; Duty Cycle: 1:1

Medium: 1750 Brain Medium parameters used (interpolated):

$f = 1732.5 \text{ MHz}$ ;  $\sigma = 1.31 \text{ mho/m}$ ;  $\epsilon_r = 40.8$ ;  $\rho = 1000 \text{ kg/m}^3$

Phantom section: Left Section

Test Date: 12-22-2009; Ambient Temp: 23.9 °C; Tissue Temp: 22.0 °C

Probe: ES3DV3 - SN3209; ConvF(5.29, 5.29, 5.29); Calibrated: 4/15/2009

Sensor-Surface: 3mm (Mechanical Surface Detection)

Electronics: DAE4 Sn665; Calibrated: 5/25/2009

Phantom: SAM with CRP; Type: SAM; Serial: TP1375

Measurement SW: DASY4, V4.7 Build 71; Postprocessing SW: SEMCAD, V1.8 Build 184

**Mode: AWS CDMA, Left Head, Slide In, Touch, Mid.ch**

**Area Scan (7x10x1):** Measurement grid: dx=15mm, dy=15mm

**Zoom Scan (5x5x7)/Cube 0:** Measurement grid: dx=8mm, dy=8mm, dz=5mm

Reference Value = 23.8 V/m

Peak SAR (extrapolated) = 0.977 W/kg

**SAR(1 g) = 0.698 mW/g; SAR(10 g) = 0.429 mW/g**

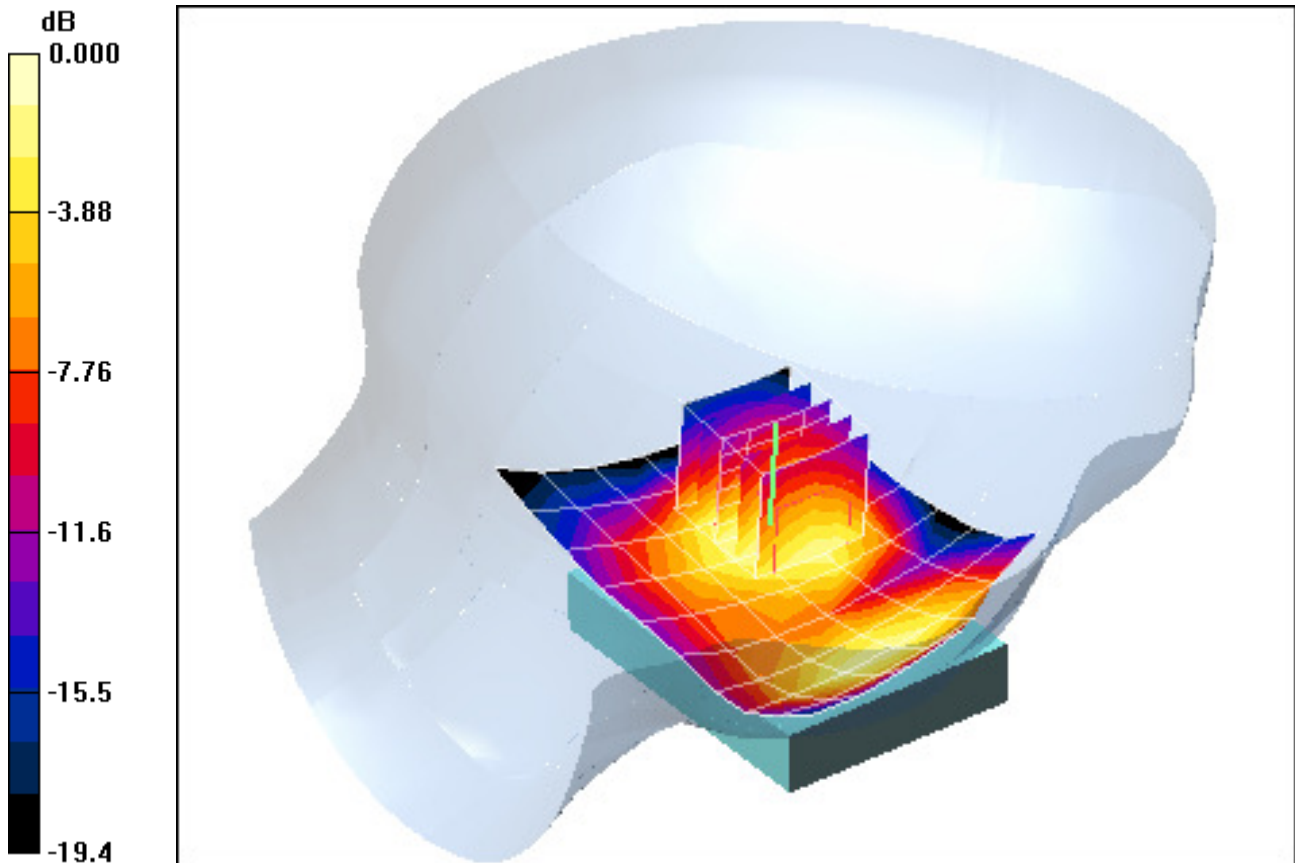

0 dB = 0.788mW/g

# PCTEST ENGINEERING LABORATORY, INC.

**DUT: MN240, LW240; Type: Cellular/AWS/PCS CDMA Phone w/ BT; Serial: SAR #1**

Communication System: AWS CDMA; Frequency: 1732.5 MHz; Duty Cycle: 1:1

Medium: 1750 Brain Medium parameters used (interpolated):

$$f = 1732.5 \text{ MHz}; \sigma = 1.31 \text{ mho/m}; \epsilon_r = 40.8; \rho = 1000 \text{ kg/m}^3$$

Phantom section: Left Section

Test Date: 12-22-2009; Ambient Temp: 23.9 °C; Tissue Temp: 22.0 °C

Probe: ES3DV3 - SN3209; ConvF(5.29, 5.29, 5.29); Calibrated: 4/15/2009

Sensor-Surface: 3mm (Mechanical Surface Detection)

Electronics: DAE4 Sn665; Calibrated: 5/25/2009

Phantom: SAM with CRP; Type: SAM; Serial: TP1375

Measurement SW: DASY4, V4.7 Build 71; Postprocessing SW: SEMCAD, V1.8 Build 184

**Mode: AWS CDMA, Left Head, Slide In, Touch, Mid.ch**

**Area Scan (7x10x1):** Measurement grid: dx=15mm, dy=15mm

**Zoom Scan (5x5x7)/Cube 0:** Measurement grid: dx=8mm, dy=8mm, dz=5mm

Reference Value = 23.8 V/m

Peak SAR (extrapolated) = 0.977 W/kg

**SAR(1 g) = 0.698 mW/g; SAR(10 g) = 0.429 mW/g**

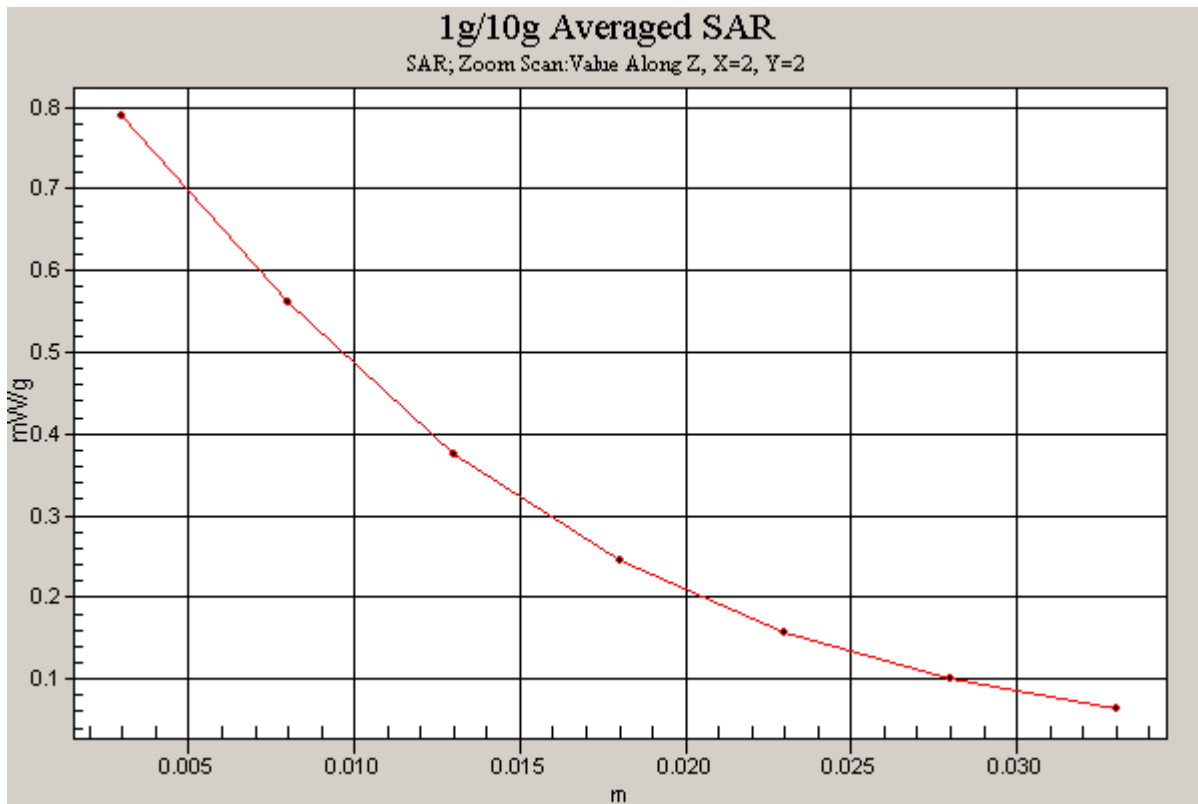

# PCTEST ENGINEERING LABORATORY, INC.

**DUT: MN240, LW240; Type: Cellular/AWS/PCS CDMA Phone w/ BT; Serial: SAR #1**

Communication System: AWS CDMA; Frequency: 1732.5 MHz; Duty Cycle: 1:1

Medium: 1750 Brain Medium parameters used (interpolated):

$f = 1732.5 \text{ MHz}$ ;  $\sigma = 1.31 \text{ mho/m}$ ;  $\epsilon_r = 40.8$ ;  $\rho = 1000 \text{ kg/m}^3$

Phantom section: Left Section

Test Date: 12-22-2009; Ambient Temp: 23.9 °C; Tissue Temp: 22.0 °C

Probe: ES3DV3 - SN3209; ConvF(5.29, 5.29, 5.29); Calibrated: 4/15/2009

Sensor-Surface: 3mm (Mechanical Surface Detection)

Electronics: DAE4 Sn665; Calibrated: 5/25/2009

Phantom: SAM with CRP; Type: SAM; Serial: TP1375

Measurement SW: DASY4, V4.7 Build 71; Postprocessing SW: SEMCAD, V1.8 Build 184

**Mode: AWS CDMA, Left Head, Slide In, Tilt, Mid.ch**

**Area Scan (7x10x1):** Measurement grid: dx=15mm, dy=15mm

**Zoom Scan (5x5x7)/Cube 0:** Measurement grid: dx=8mm, dy=8mm, dz=5mm

Reference Value = 18.3 V/m

Peak SAR (extrapolated) = 0.684 W/kg

**SAR(1 g) = 0.456 mW/g; SAR(10 g) = 0.280 mW/g**

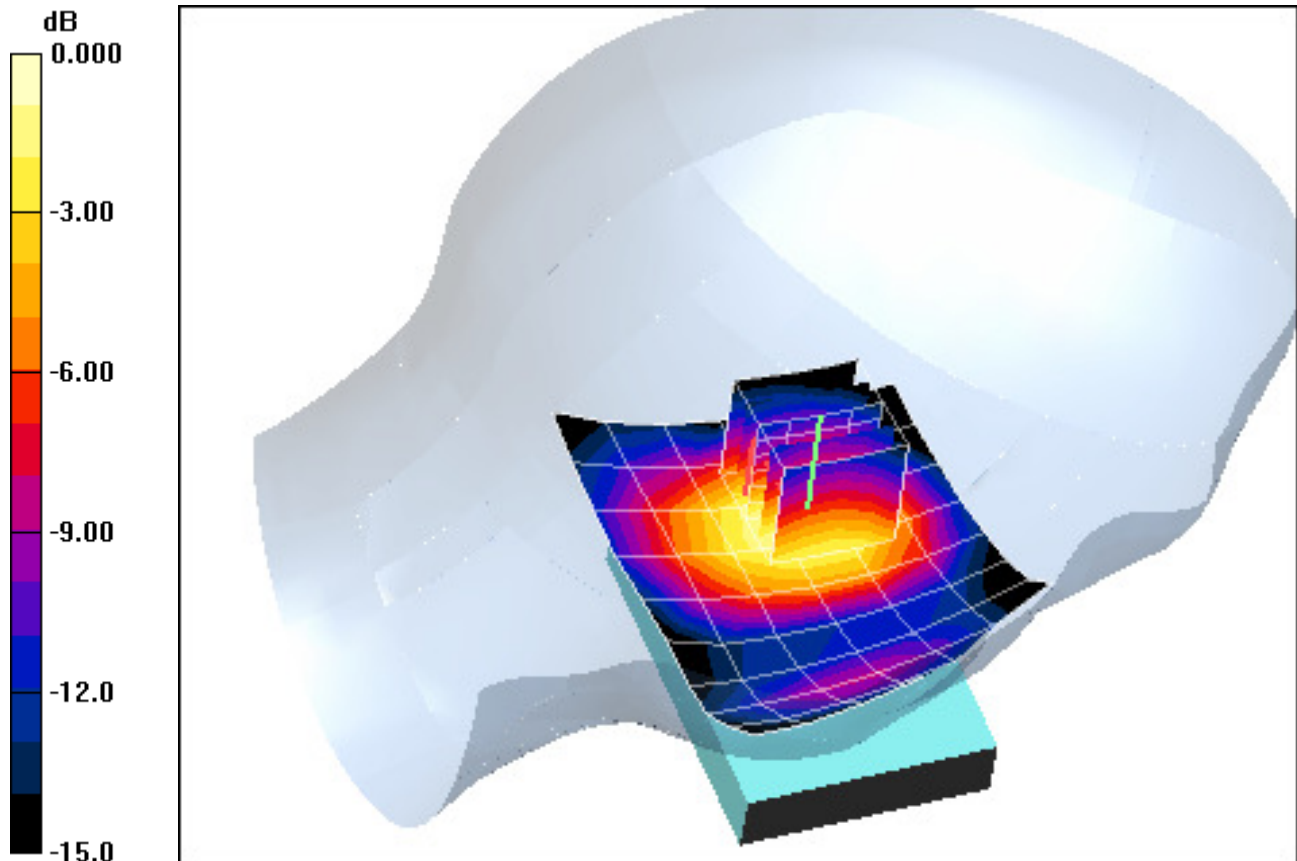

0 dB = 0.537mW/g

# PCTEST ENGINEERING LABORATORY, INC.

**DUT: MN240, LW240; Type: Cellular/AWS/PCS CDMA Phone w/ BT; Serial: SAR #1**

Communication System: AWS CDMA; Frequency: 1732.5 MHz; Duty Cycle: 1:1

Medium: 1750 Brain Medium parameters used (interpolated):

$f = 1732.5 \text{ MHz}$ ;  $\sigma = 1.31 \text{ mho/m}$ ;  $\epsilon_r = 40.8$ ;  $\rho = 1000 \text{ kg/m}^3$

Phantom section: Right Section

Test Date: 12-22-2009; Ambient Temp: 23.9 °C; Tissue Temp: 22.0 °C

Probe: ES3DV3 - SN3209; ConvF(5.29, 5.29, 5.29); Calibrated: 4/15/2009

Sensor-Surface: 3mm (Mechanical Surface Detection)

Electronics: DAE4 Sn665; Calibrated: 5/25/2009

Phantom: SAM with CRP; Type: SAM; Serial: TP1375

Measurement SW: DASY4, V4.7 Build 71; Postprocessing SW: SEMCAD, V1.8 Build 184

**Mode: AWS CDMA, Right Head, Slide Out, Touch, Mid.ch**

**Area Scan (7x12x1):** Measurement grid:  $dx=15\text{mm}$ ,  $dy=15\text{mm}$

**Zoom Scan (5x5x7)/Cube 0:** Measurement grid:  $dx=8\text{mm}$ ,  $dy=8\text{mm}$ ,  $dz=5\text{mm}$

Reference Value = 17.3 V/m

Peak SAR (extrapolated) = 0.533 W/kg

**SAR(1 g) = 0.363 mW/g; SAR(10 g) = 0.241 mW/g**

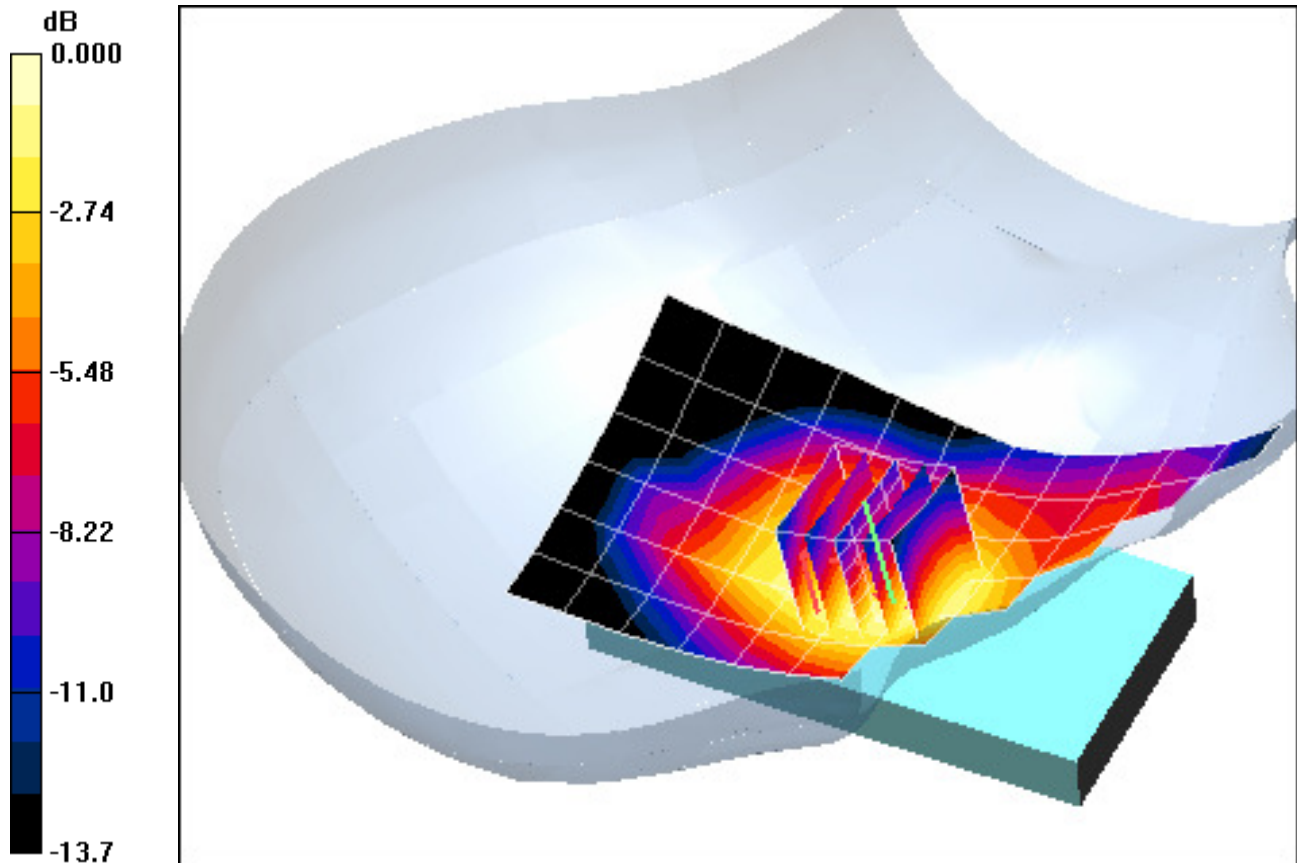

0 dB = 0.420mW/g

# PCTEST ENGINEERING LABORATORY, INC.

**DUT: MN240, LW240; Type: Cellular/AWS/PCS CDMA Phone w/ BT; Serial: SAR #1**

Communication System: AWS CDMA; Frequency: 1732.5 MHz; Duty Cycle: 1:1

Medium: 1750 Brain Medium parameters used (interpolated)

:  $f = 1732.5$  MHz;  $\sigma = 1.31$  mho/m;  $\epsilon_r = 40.8$ ;  $\rho = 1000$  kg/m<sup>3</sup>

Phantom section: Right Section

Test Date: 12-22-2009; Ambient Temp: 23.9 °C; Tissue Temp: 22.0 °C

Probe: ES3DV3 - SN3209; ConvF(5.29, 5.29, 5.29); Calibrated: 4/15/2009

Sensor-Surface: 3mm (Mechanical Surface Detection)

Electronics: DAE4 Sn665; Calibrated: 5/25/2009

Phantom: SAM with CRP; Type: SAM; Serial: TP1375

Measurement SW: DASY4, V4.7 Build 71; Postprocessing SW: SEMCAD, V1.8 Build 184

**Mode: AWS CDMA, Right Head, Slide Out, Tilt, Mid.ch**

**Area Scan (7x12x1):** Measurement grid: dx=15mm, dy=15mm

**Zoom Scan (5x5x7)/Cube 0:** Measurement grid: dx=8mm, dy=8mm, dz=5mm

Reference Value = 14.8 V/m

Peak SAR (extrapolated) = 0.379 W/kg

**SAR(1 g) = 0.263 mW/g; SAR(10 g) = 0.170 mW/g**

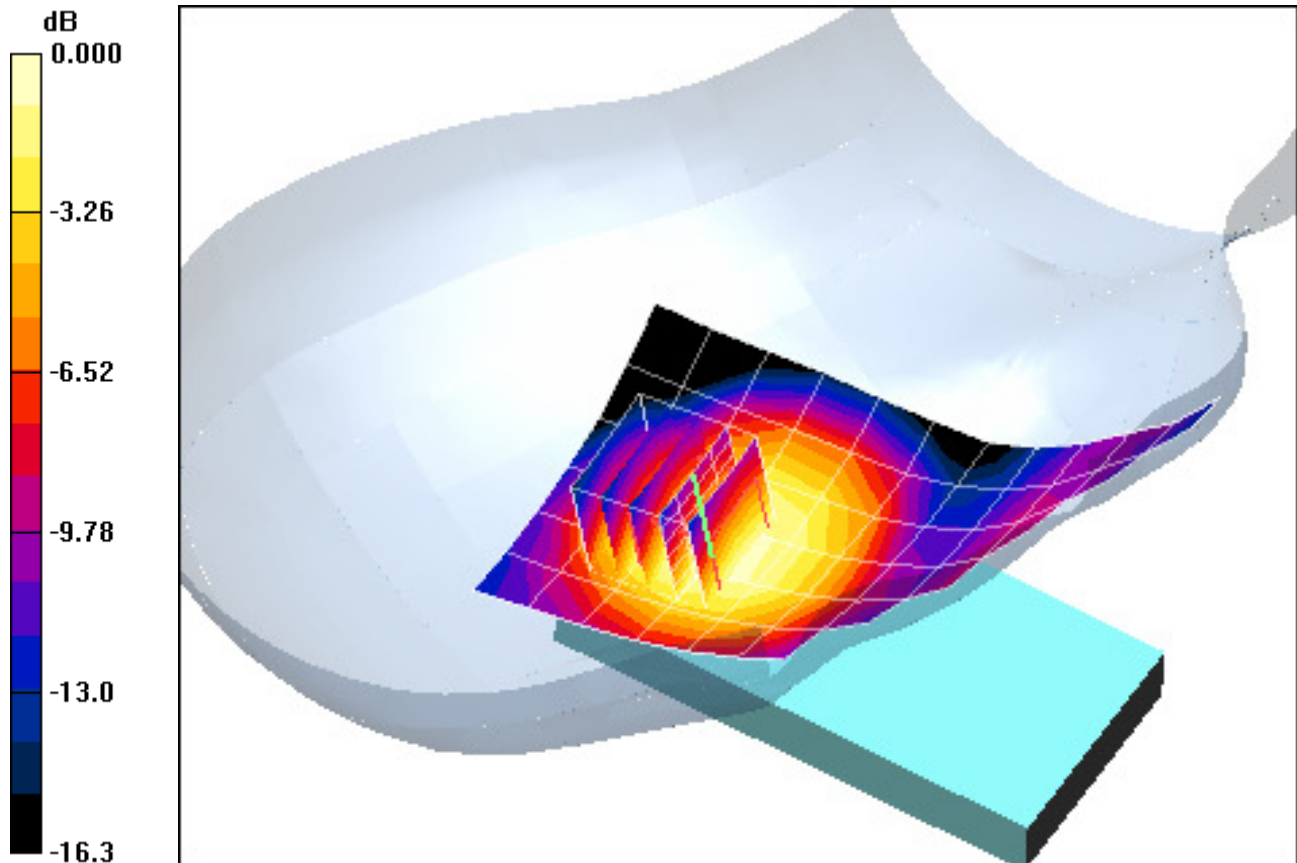

0 dB = 0.305mW/g

# PCTEST ENGINEERING LABORATORY, INC.

**DUT: MN240, LW240; Type: Cellular/AWS/PCS CDMA Phone w/ BT; Serial: SAR #1**

Communication System: AWS CDMA; Frequency: 1732.5 MHz; Duty Cycle: 1:1

Medium: 1750 Brain Medium parameters used (interpolated):

$f = 1732.5 \text{ MHz}$ ;  $\sigma = 1.31 \text{ mho/m}$ ;  $\epsilon_r = 40.8$ ;  $\rho = 1000 \text{ kg/m}^3$

Phantom section: Left Section

Test Date: 12-22-2009; Ambient Temp: 23.9 °C; Tissue Temp: 22.0 °C

Probe: ES3DV3 - SN3209; ConvF(5.29, 5.29, 5.29); Calibrated: 4/15/2009

Sensor-Surface: 3mm (Mechanical Surface Detection)

Electronics: DAE4 Sn665; Calibrated: 5/25/2009

Phantom: SAM with CRP; Type: SAM; Serial: TP1375

Measurement SW: DASY4, V4.7 Build 71; Postprocessing SW: SEMCAD, V1.8 Build 184

**Mode: AWS CDMA, Left Head, Slide Out, Touch, Mid.ch**

**Area Scan (7x12x1):** Measurement grid: dx=15mm, dy=15mm

**Zoom Scan (5x5x7)/Cube 0:** Measurement grid: dx=8mm, dy=8mm, dz=5mm

Reference Value = 23.0 V/m

Peak SAR (extrapolated) = 0.946 W/kg

**SAR(1 g) = 0.630 mW/g; SAR(10 g) = 0.388 mW/g**

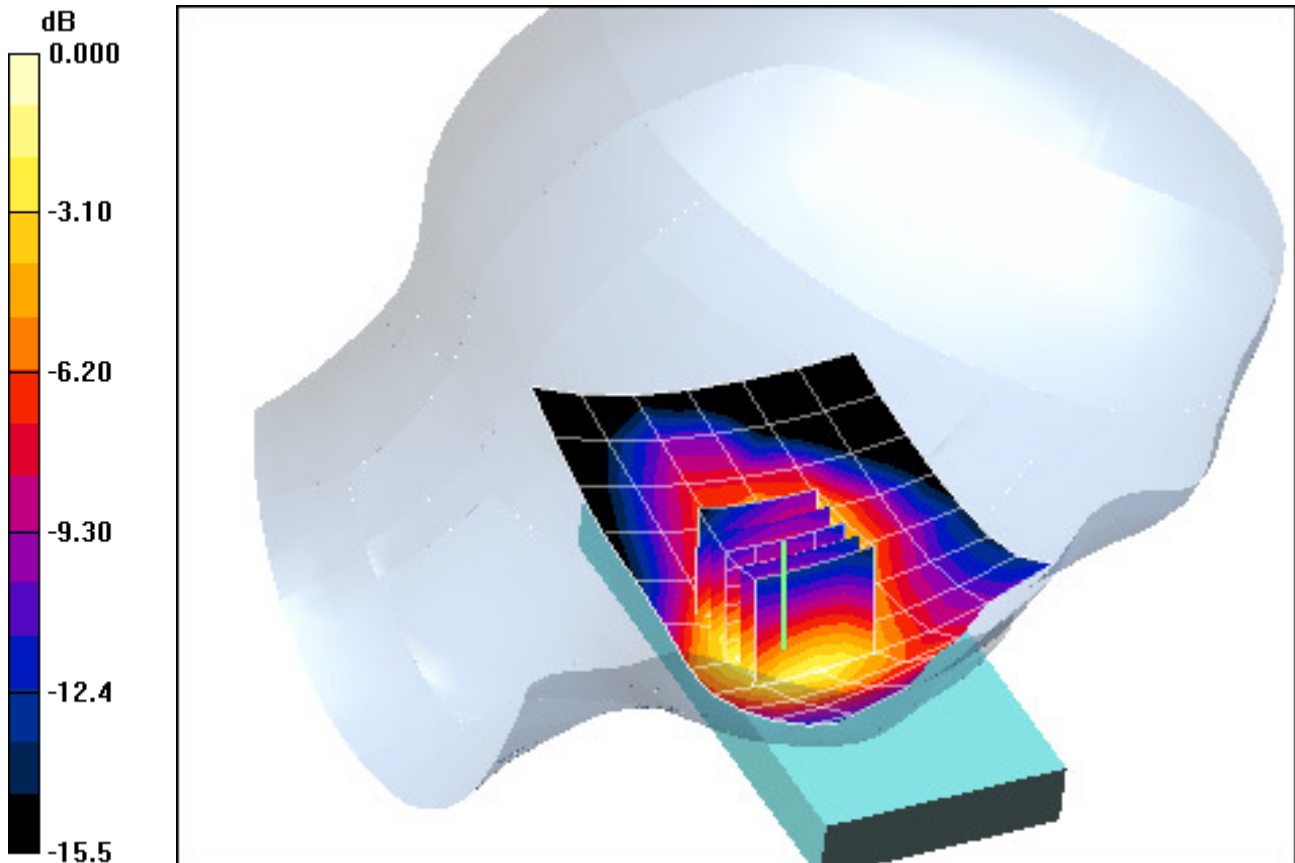

0 dB = 0.746mW/g

# PCTEST ENGINEERING LABORATORY, INC.

**DUT: MN240, LW240; Type: Cellular/AWS/PCS CDMA Phone w/ BT; Serial: SAR #1**

Communication System: AWS CDMA; Frequency: 1880 MHz; Duty Cycle: 1:1

Medium: 1750 Brain Medium parameters used:

$f = 1790 \text{ MHz}$ ;  $\sigma = 1.379 \text{ mho/m}$ ;  $\epsilon_r = 40.5$ ;  $\rho = 1000 \text{ kg/m}^3$

Phantom section: Left Section

Test Date: 12-22-2009; Ambient Temp: 23.9 °C; Tissue Temp: 22.0 °C

Probe: ES3DV3 - SN3209; ConvF(5.1, 5.1, 5.1); Calibrated: 4/15/2009

Sensor-Surface: 3mm (Mechanical Surface Detection)

Electronics: DAE4 Sn665; Calibrated: 5/25/2009

Phantom: SAM with CRP; Type: SAM; Serial: TP1375

Measurement SW: DASY4, V4.7 Build 71; Postprocessing SW: SEMCAD, V1.8 Build 184

**Mode: AWS CDMA, Left Head, Slide Out, Tilt, Mid.ch**

**Area Scan (7x12x1):** Measurement grid: dx=15mm, dy=15mm

**Zoom Scan (5x5x7)/Cube 0:** Measurement grid: dx=8mm, dy=8mm, dz=5mm

Reference Value = 15.1 V/m; Power Drift = 0.128 dB

Peak SAR (extrapolated) = 0.417 W/kg

**SAR(1 g) = 0.290 mW/g; SAR(10 g) = 0.193 mW/g**

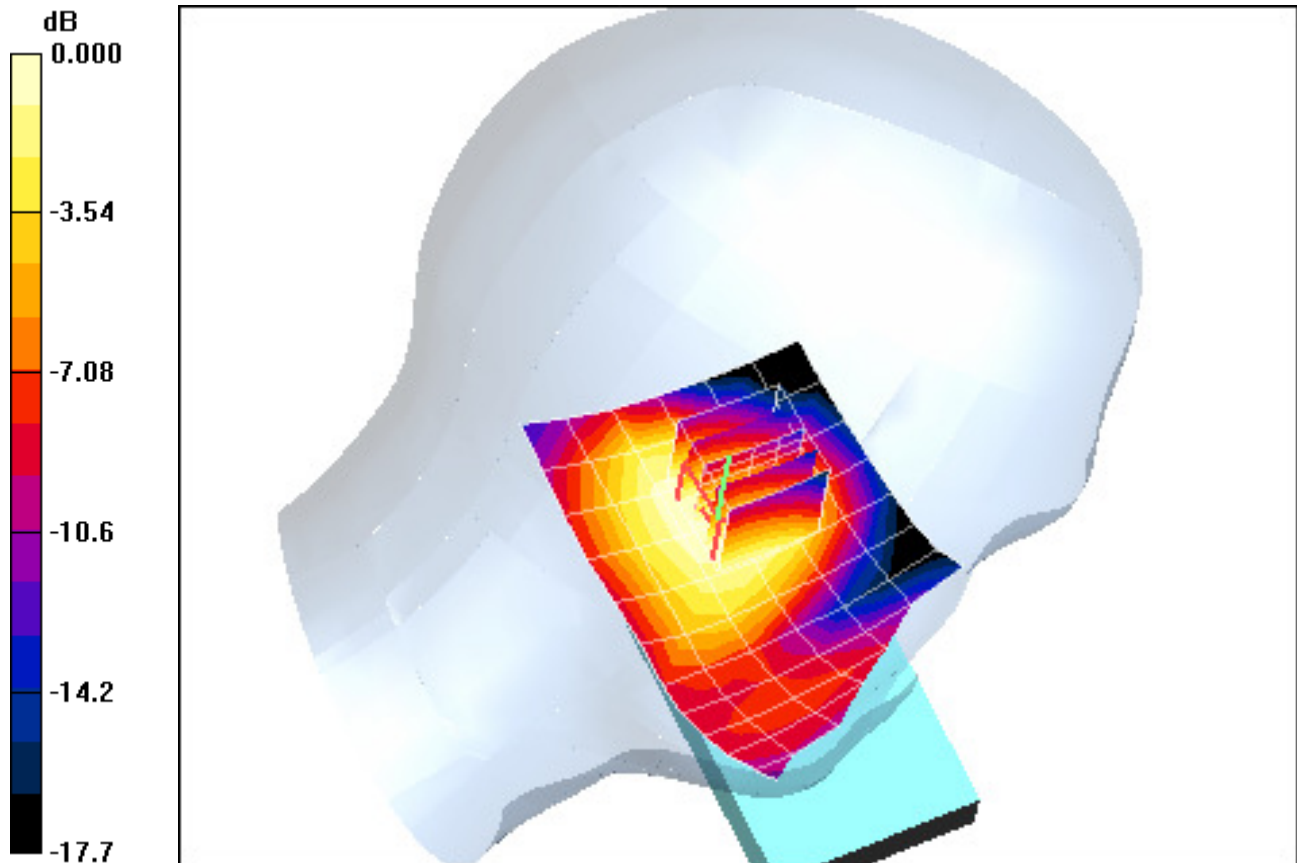

0 dB = 0.336mW/g

# PCTEST ENGINEERING LABORATORY, INC.

**DUT: MN240, LW240; Type: Cellular/AWS/PCS CDMA Phone w/ BT; Serial: SAR #1**

Communication System: PCS CDMA; Frequency: 1880 MHz; Duty Cycle: 1:1

Medium: 1900 Brain Medium parameters used:

$f = 1880 \text{ MHz}$ ;  $\sigma = 1.43 \text{ mho/m}$ ;  $\epsilon_r = 38.5$ ;  $\rho = 1000 \text{ kg/m}^3$

Phantom section: Right Section

Test Date: 12-17-2009; Ambient Temp: 23.5 °C; Tissue Temp: 21.9 °C

Probe: ES3DV3 - SN3209; ConvF(5.1, 5.1, 5.1); Calibrated: 4/15/2009

Sensor-Surface: 3mm (Mechanical Surface Detection)

Electronics: DAE4 Sn665; Calibrated: 5/25/2009

Phantom: SAM with CRP; Type: SAM; Serial: TP1375

Measurement SW: DASY4, V4.7 Build 71; Postprocessing SW: SEMCAD, V1.8 Build 184

**Mode: PCS CDMA, Right Head, Slide In, Touch, Mid.ch**

**Area Scan (7x10x1):** Measurement grid: dx=15mm, dy=15mm

**Zoom Scan (5x5x7)/Cube 0:** Measurement grid: dx=8mm, dy=8mm, dz=5mm

Reference Value = 17.3 V/m

Peak SAR (extrapolated) = 0.543 W/kg

**SAR(1 g) = 0.374 mW/g; SAR(10 g) = 0.229 mW/g**

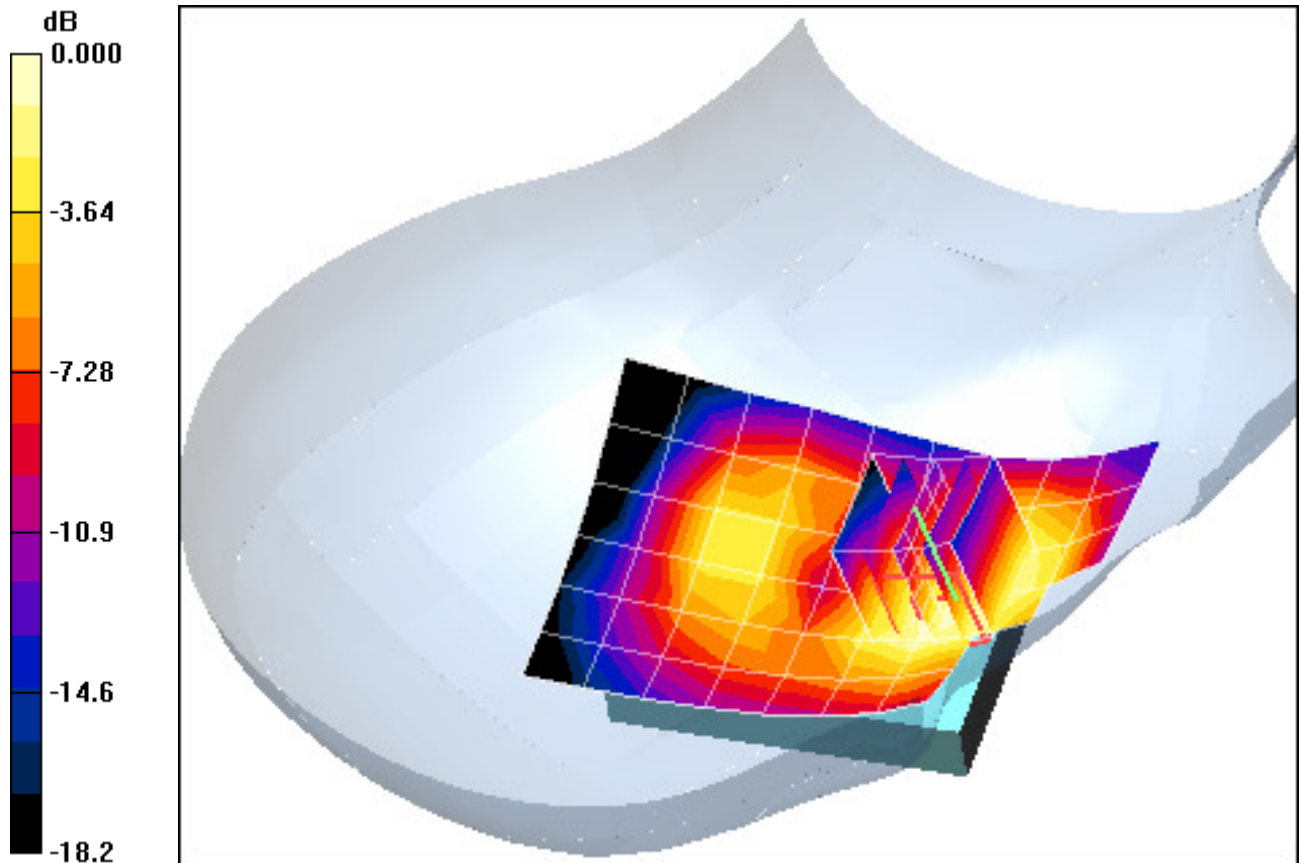

0 dB = 0.435mW/g

# PCTEST ENGINEERING LABORATORY, INC.

**DUT: MN240, LW240; Type: Cellular/AWS/PCS CDMA Phone w/ BT; Serial: SAR #1**

Communication System: PCS CDMA; Frequency: 1880 MHz; Duty Cycle: 1:1

Medium: 1900 Brain Medium parameters used:

$f = 1880 \text{ MHz}$ ;  $\sigma = 1.43 \text{ mho/m}$ ;  $\epsilon_r = 38.5$ ;  $\rho = 1000 \text{ kg/m}^3$

Phantom section: Right Section

Test Date: 12-17-2009; Ambient Temp: 23.5 °C; Tissue Temp: 21.9 °C

Probe: ES3DV3 - SN3209; ConvF(5.1, 5.1, 5.1); Calibrated: 4/15/2009

Sensor-Surface: 3mm (Mechanical Surface Detection)

Electronics: DAE4 Sn665; Calibrated: 5/25/2009

Phantom: SAM with CRP; Type: SAM; Serial: TP1375

Measurement SW: DASY4, V4.7 Build 71; Postprocessing SW: SEMCAD, V1.8 Build 184

**Mode: PCS CDMA, Right Head, Slide In, Tilt, Mid.ch**

**Area Scan (7x10x1):** Measurement grid: dx=15mm, dy=15mm

**Zoom Scan (5x5x7)/Cube 0:** Measurement grid: dx=8mm, dy=8mm, dz=5mm

Reference Value = 13.2 V/m

Peak SAR (extrapolated) = 0.438 W/kg

**SAR(1 g) = 0.261 mW/g; SAR(10 g) = 0.149 mW/g**

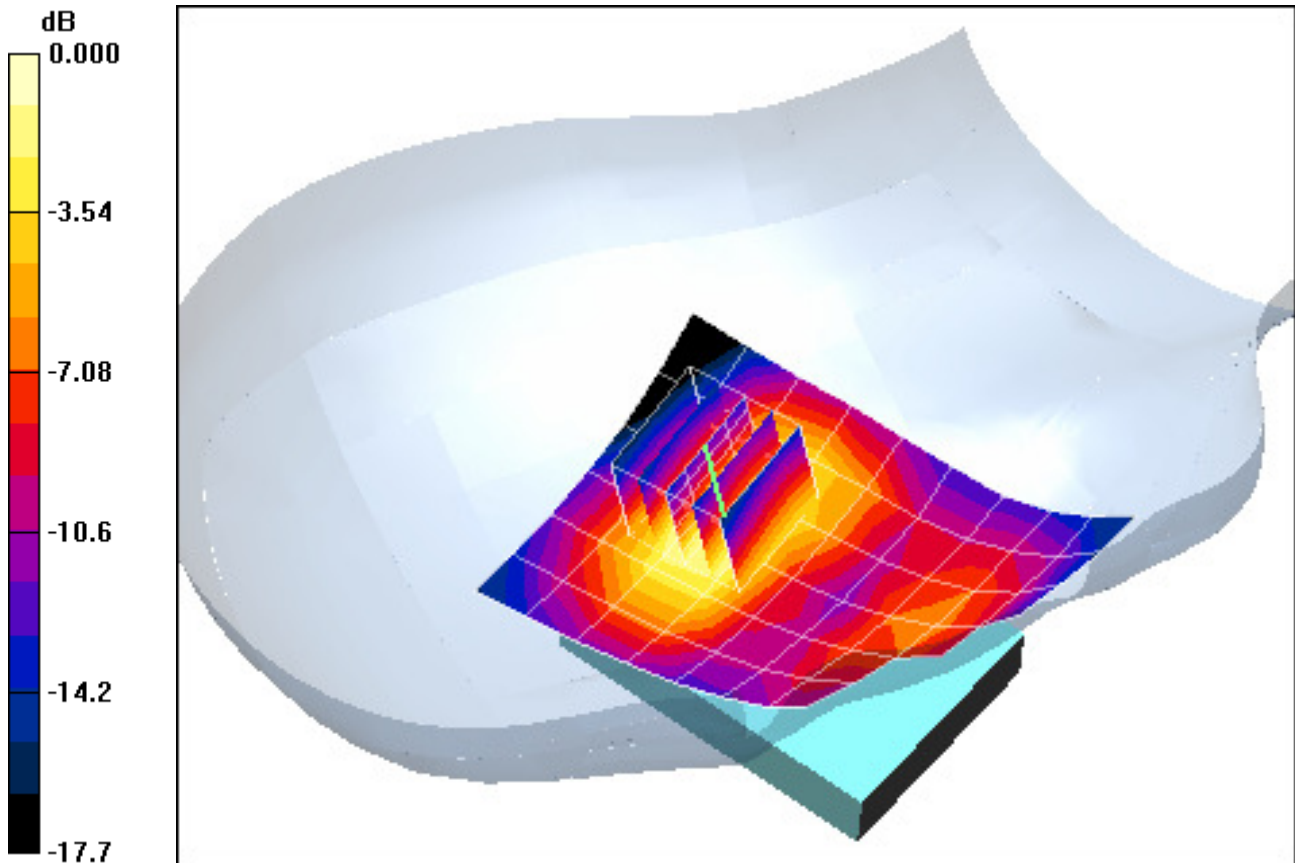

0 dB = 0.315mW/g

# PCTEST ENGINEERING LABORATORY, INC.

**DUT: MN240, LW240; Type: Cellular/AWS/PCS CDMA Phone w/ BT; Serial: SAR #1**

Communication System: PCS CDMA; Frequency: 1880 MHz; Duty Cycle: 1:1

Medium: 1900 Brain Medium parameters used:

$f = 1880 \text{ MHz}$ ;  $\sigma = 1.43 \text{ mho/m}$ ;  $\epsilon_r = 38.5$ ;  $\rho = 1000 \text{ kg/m}^3$

Phantom section: Left Section

Test Date: 12-17-2009; Ambient Temp: 23.5 °C; Tissue Temp: 21.9 °C

Probe: ES3DV3 - SN3209; ConvF(5.1, 5.1, 5.1); Calibrated: 4/15/2009

Sensor-Surface: 3mm (Mechanical Surface Detection)

Electronics: DAE4 Sn665; Calibrated: 5/25/2009

Phantom: SAM with CRP; Type: SAM; Serial: TP1375

Measurement SW: DASY4, V4.7 Build 71; Postprocessing SW: SEMCAD, V1.8 Build 184

**Mode: PCS CDMA, Left Head, Slide In, Touch, Mid.ch**

**Area Scan (7x10x1):** Measurement grid: dx=15mm, dy=15mm

**Zoom Scan (5x5x7)/Cube 0:** Measurement grid: dx=8mm, dy=8mm, dz=5mm

Reference Value = 20.5 V/m

Peak SAR (extrapolated) = 0.847 W/kg

**SAR(1 g) = 0.550 mW/g; SAR(10 g) = 0.314 mW/g**

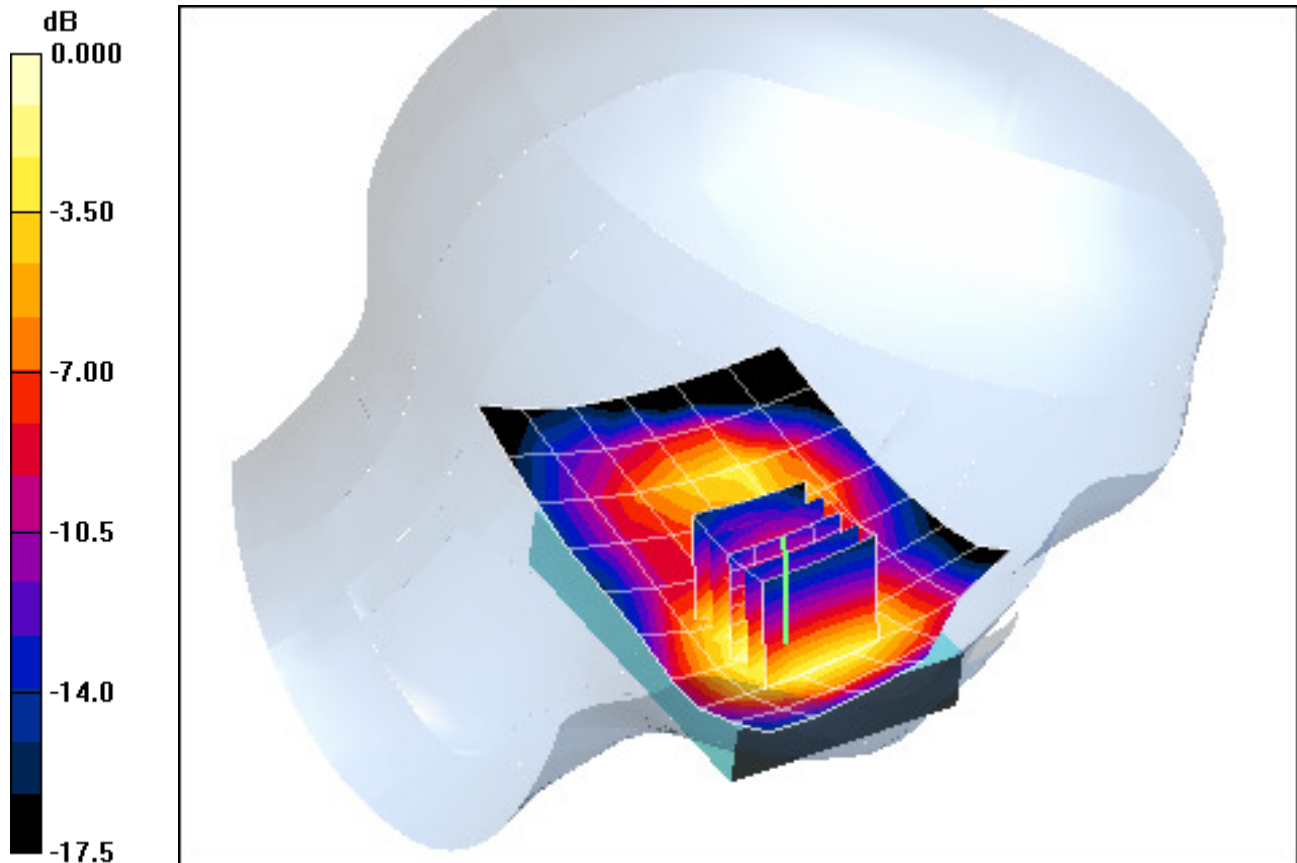

0 dB = 0.652mW/g

# PCTEST ENGINEERING LABORATORY, INC.

**DUT: MN240, LW240; Type: Cellular/AWS/PCS CDMA Phone w/ BT; Serial: SAR #1**

Communication System: PCS CDMA; Frequency: 1880 MHz; Duty Cycle: 1:1

Medium: 1900 Brain Medium parameters used:

$f = 1880 \text{ MHz}$ ;  $\sigma = 1.43 \text{ mho/m}$ ;  $\epsilon_r = 38.5$ ;  $\rho = 1000 \text{ kg/m}^3$

Phantom section: Left Section

Test Date: 12-17-2009; Ambient Temp: 23.5 °C; Tissue Temp: 21.9 °C

Probe: ES3DV3 - SN3209; ConvF(5.1, 5.1, 5.1); Calibrated: 4/15/2009

Sensor-Surface: 3mm (Mechanical Surface Detection)

Electronics: DAE4 Sn665; Calibrated: 5/25/2009

Phantom: SAM with CRP; Type: SAM; Serial: TP1375

Measurement SW: DASY4, V4.7 Build 71; Postprocessing SW: SEMCAD, V1.8 Build 184

**Mode: PCS CDMA, Left Head, Slide In, Touch, Mid.ch**

**Area Scan (7x10x1):** Measurement grid: dx=15mm, dy=15mm

**Zoom Scan (5x5x7)/Cube 0:** Measurement grid: dx=8mm, dy=8mm, dz=5mm

Reference Value = 20.5 V/m

Peak SAR (extrapolated) = 0.847 W/kg

**SAR(1 g) = 0.550 mW/g; SAR(10 g) = 0.314 mW/g**

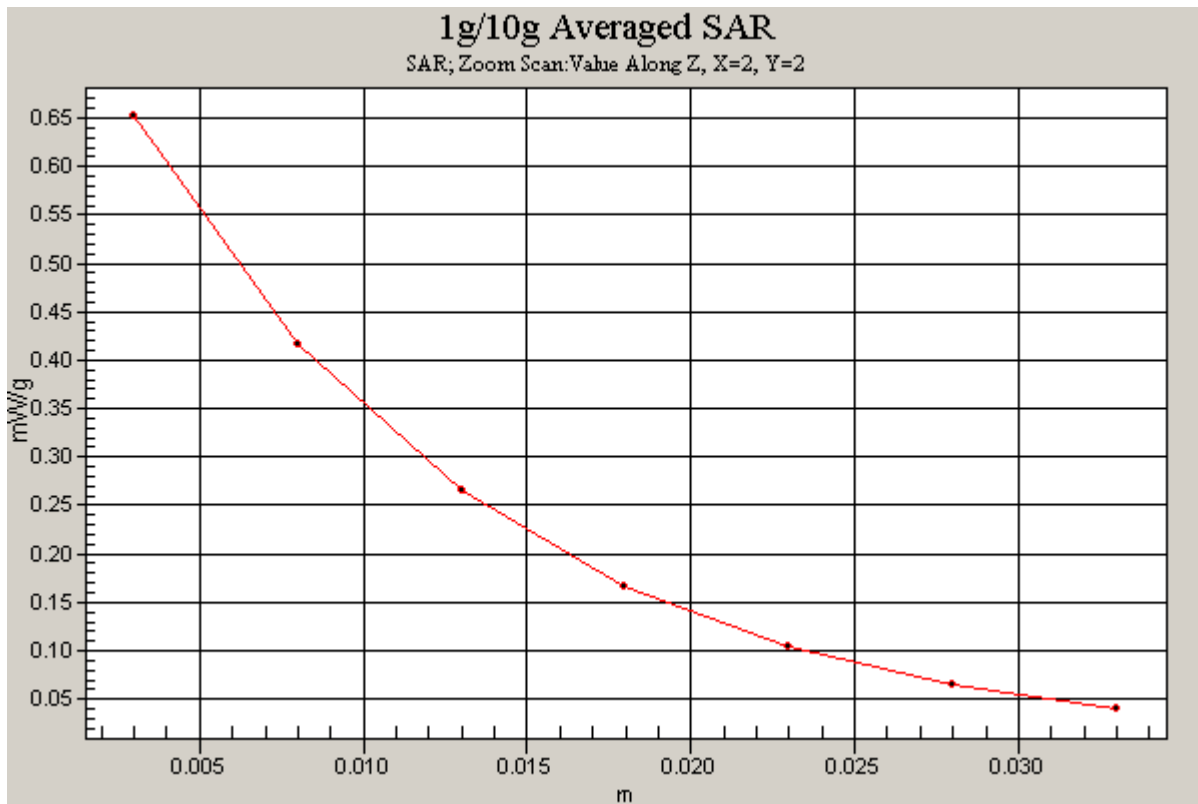

# PCTEST ENGINEERING LABORATORY, INC.

**DUT: MN240, LW240; Type: Cellular/AWS/PCS CDMA Phone w/ BT; Serial: SAR #1**

Communication System: PCS CDMA; Frequency: 1880 MHz; Duty Cycle: 1:1

Medium: 1900 Brain Medium parameters used:

$f = 1880 \text{ MHz}$ ;  $\sigma = 1.43 \text{ mho/m}$ ;  $\epsilon_r = 38.5$ ;  $\rho = 1000 \text{ kg/m}^3$

Phantom section: Left Section

Test Date: 12-17-2009; Ambient Temp: 23.5 °C; Tissue Temp: 21.9 °C

Probe: ES3DV3 - SN3209; ConvF(5.1, 5.1, 5.1); Calibrated: 4/15/2009

Sensor-Surface: 3mm (Mechanical Surface Detection)

Electronics: DAE4 Sn665; Calibrated: 5/25/2009

Phantom: SAM with CRP; Type: SAM; Serial: TP1375

Measurement SW: DASY4, V4.7 Build 71; Postprocessing SW: SEMCAD, V1.8 Build 184

**Mode: PCS CDMA, Left Head, Slide In, Tilt, Mid.ch**

**Area Scan (7x10x1):** Measurement grid: dx=15mm, dy=15mm

**Zoom Scan (5x5x7)/Cube 0:** Measurement grid: dx=8mm, dy=8mm, dz=5mm

Reference Value = 14.3 V/m

Peak SAR (extrapolated) = 0.412 W/kg

**SAR(1 g) = 0.268 mW/g; SAR(10 g) = 0.161 mW/g**

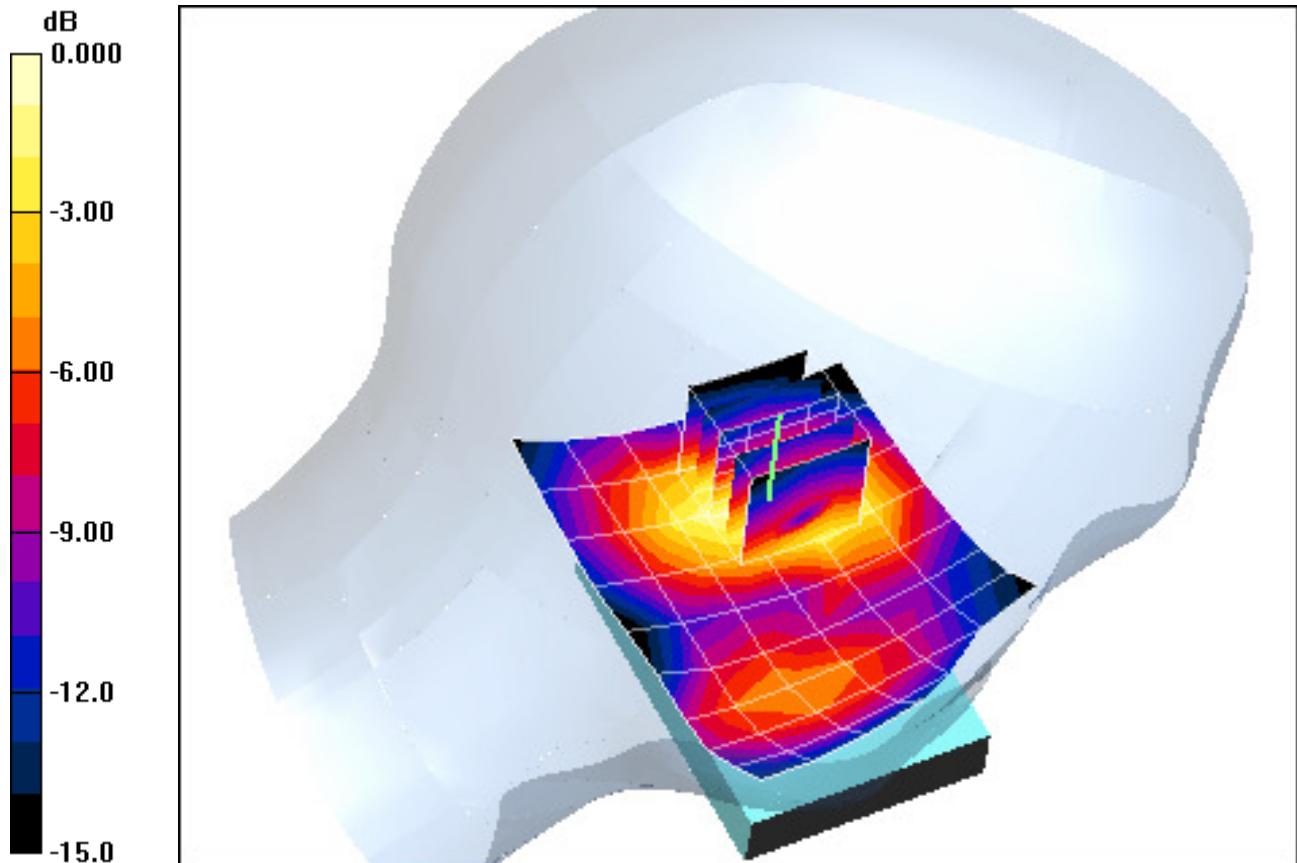

0 dB = 0.310mW/g

# PCTEST ENGINEERING LABORATORY, INC.

**DUT: MN240, LW240; Type: Cellular/AWS/PCS CDMA Phone w/ BT; Serial: SAR #1**

Communication System: PCS CDMA; Frequency: 1880 MHz; Duty Cycle: 1:1

Medium: 1900 Brain Medium parameters used:

$f = 1880 \text{ MHz}$ ;  $\sigma = 1.43 \text{ mho/m}$ ;  $\epsilon_r = 38.5$ ;  $\rho = 1000 \text{ kg/m}^3$

Phantom section: Right Section

Test Date: 12-17-2009; Ambient Temp: 23.5 °C; Tissue Temp: 21.9 °C

Probe: ES3DV3 - SN3209; ConvF(5.1, 5.1, 5.1); Calibrated: 4/15/2009

Sensor-Surface: 3mm (Mechanical Surface Detection)

Electronics: DAE4 Sn665; Calibrated: 5/25/2009

Phantom: SAM with CRP; Type: SAM; Serial: TP1375

Measurement SW: DASY4, V4.7 Build 71; Postprocessing SW: SEMCAD, V1.8 Build 184

**Mode: PCS CDMA, Right Head, Slide Out, Touch, Mid.ch**

**Area Scan (7x12x1):** Measurement grid: dx=15mm, dy=15mm

**Zoom Scan (5x5x7)/Cube 0:** Measurement grid: dx=8mm, dy=8mm, dz=5mm

Reference Value = 14.7 V/m

Peak SAR (extrapolated) = 0.444 W/kg

**SAR(1 g) = 0.286 mW/g; SAR(10 g) = 0.176 mW/g**

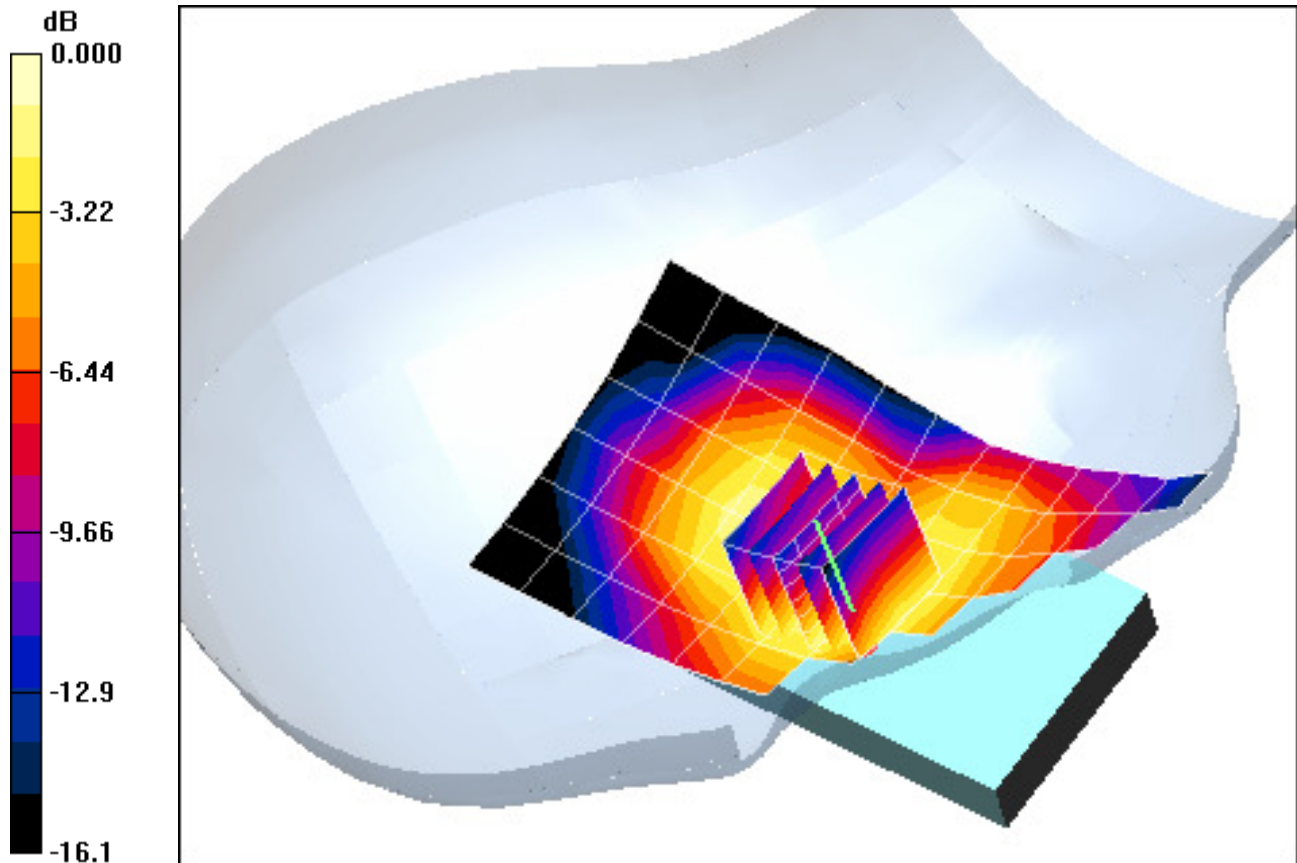

0 dB = 0.343mW/g

# PCTEST ENGINEERING LABORATORY, INC.

**DUT: MN240, LW240; Type: Cellular/AWS/PCS CDMA Phone w/ BT; Serial: SAR #1**

Communication System: PCS CDMA; Frequency: 1880 MHz; Duty Cycle: 1:1

Medium: 1900 Brain Medium parameters used:

$f = 1880 \text{ MHz}$ ;  $\sigma = 1.43 \text{ mho/m}$ ;  $\epsilon_r = 38.5$ ;  $\rho = 1000 \text{ kg/m}^3$

Phantom section: Right Section

Test Date: 12-17-2009; Ambient Temp: 23.5 °C; Tissue Temp: 21.9 °C

Probe: ES3DV3 - SN3209; ConvF(5.1, 5.1, 5.1); Calibrated: 4/15/2009

Sensor-Surface: 3mm (Mechanical Surface Detection)

Electronics: DAE4 Sn665; Calibrated: 5/25/2009

Phantom: SAM with CRP; Type: SAM; Serial: TP1375

Measurement SW: DASY4, V4.7 Build 71; Postprocessing SW: SEMCAD, V1.8 Build 184

**Mode: PCS CDMA, Right Head, Slide Out, Tilt, Mid.ch**

**Area Scan (7x12x1):** Measurement grid: dx=15mm, dy=15mm

**Zoom Scan (5x5x7)/Cube 0:** Measurement grid: dx=8mm, dy=8mm, dz=5mm

Reference Value = 15.6 V/m

Peak SAR (extrapolated) = 0.473 W/kg

**SAR(1 g) = 0.329 mW/g; SAR(10 g) = 0.210 mW/g**

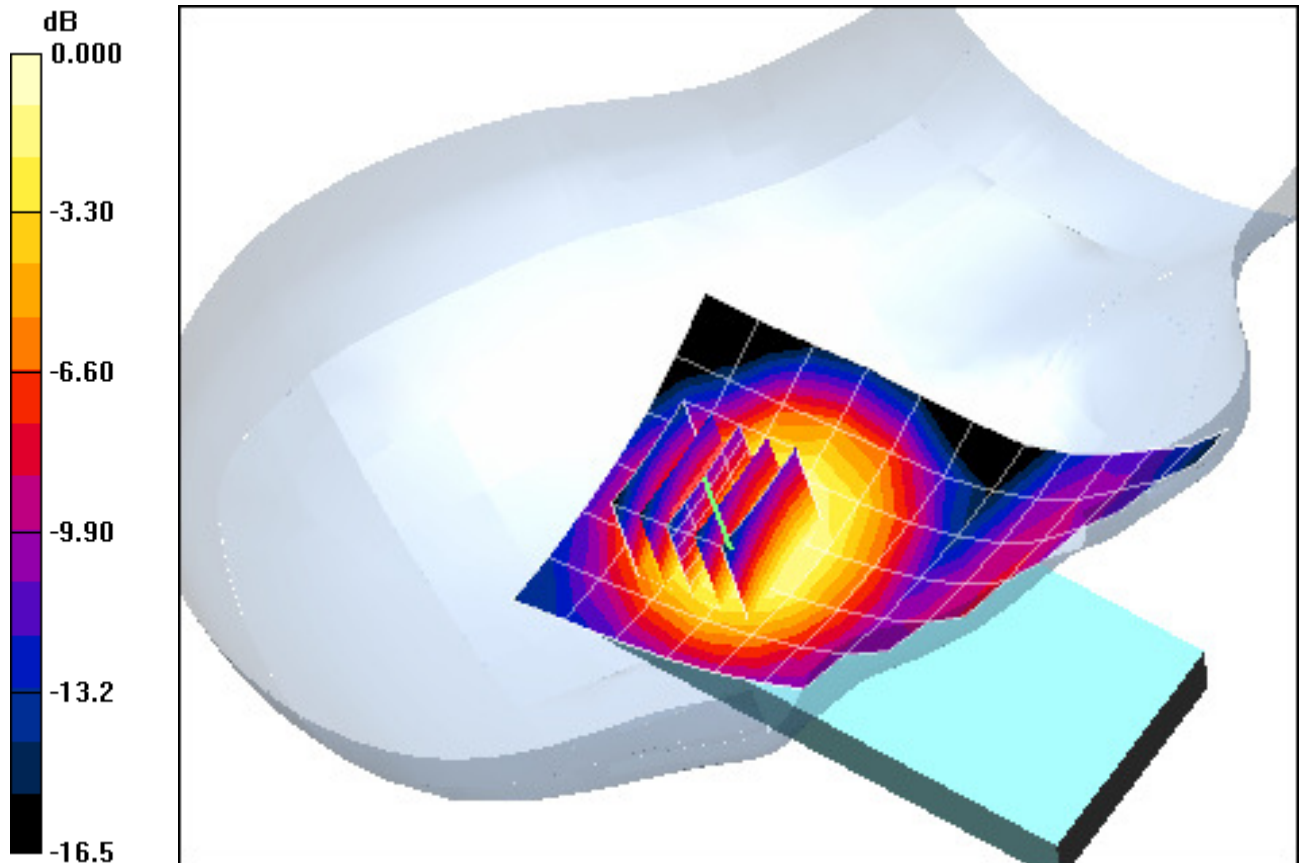

0 dB = 0.379mW/g

# PCTEST ENGINEERING LABORATORY, INC.

**DUT: MN240, LW240; Type: Cellular/AWS/PCS CDMA Phone w/ BT; Serial: SAR #1**

Communication System: PCS CDMA; Frequency: 1880 MHz; Duty Cycle: 1:1

Medium: 1900 Brain Medium parameters used:

$f = 1880 \text{ MHz}$ ;  $\sigma = 1.43 \text{ mho/m}$ ;  $\epsilon_r = 38.5$ ;  $\rho = 1000 \text{ kg/m}^3$

Phantom section: Left Section

Test Date: 12-17-2009; Ambient Temp: 23.5 °C; Tissue Temp: 21.9 °C

Probe: ES3DV3 - SN3209; ConvF(5.1, 5.1, 5.1); Calibrated: 4/15/2009

Sensor-Surface: 3mm (Mechanical Surface Detection)

Electronics: DAE4 Sn665; Calibrated: 5/25/2009

Phantom: SAM with CRP; Type: SAM; Serial: TP1375

Measurement SW: DASY4, V4.7 Build 71; Postprocessing SW: SEMCAD, V1.8 Build 184

**Mode: PCS CDMA, Left Head, Slide Out, Touch, Mid.ch**

**Area Scan (7x12x1):** Measurement grid: dx=15mm, dy=15mm

**Zoom Scan (5x5x7)/Cube 0:** Measurement grid: dx=8mm, dy=8mm, dz=5mm

Reference Value = 19.7 V/m

Peak SAR (extrapolated) = 0.805 W/kg

**SAR(1 g) = 0.513 mW/g; SAR(10 g) = 0.305 mW/g**

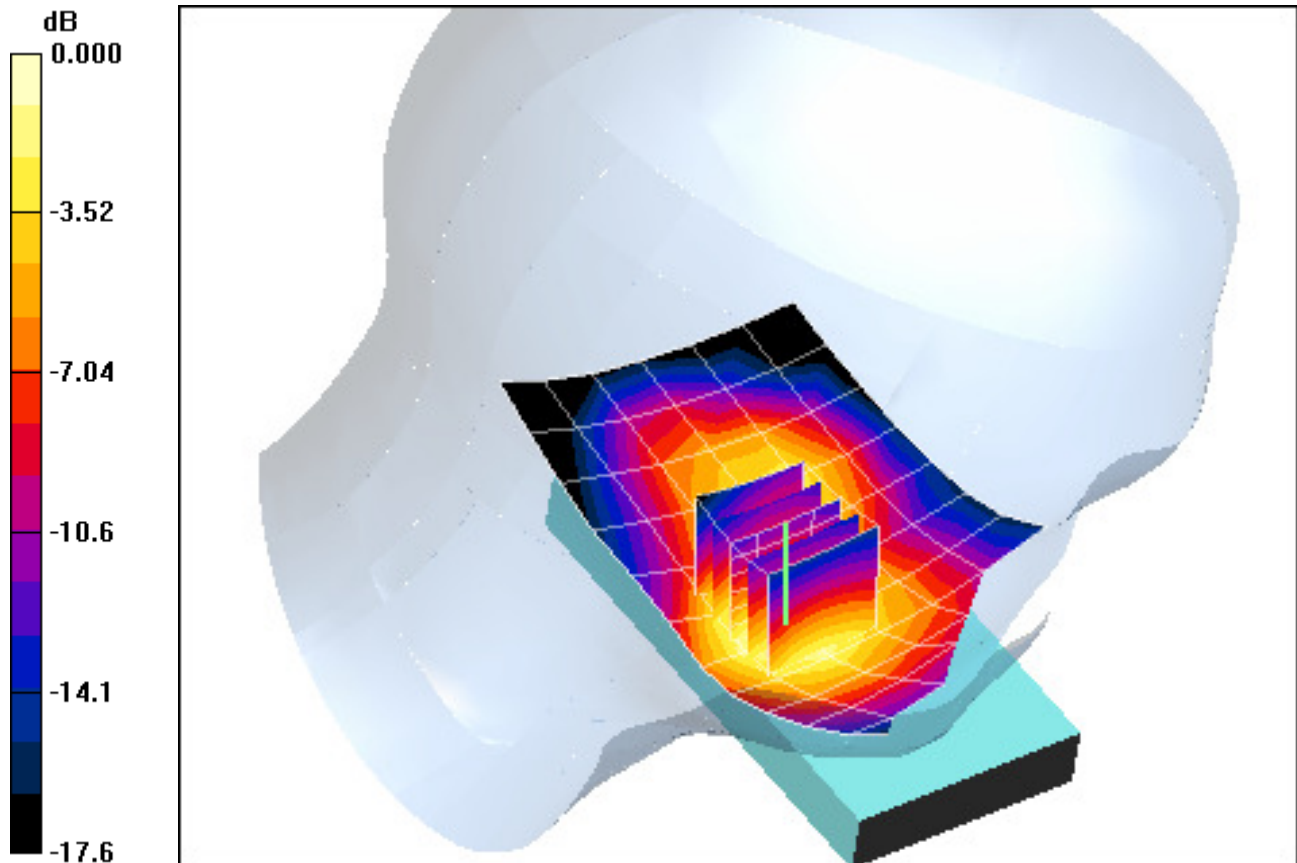

0 dB = 0.617mW/g

# PCTEST ENGINEERING LABORATORY, INC.

**DUT: MN240, LW240; Type: Cellular/AWS/PCS CDMA Phone w/ BT; Serial: SAR #1**

Communication System: PCS CDMA; Frequency: 1880 MHz; Duty Cycle: 1:1

Medium: 1900 Brain Medium parameters used:

$f = 1880 \text{ MHz}$ ;  $\sigma = 1.43 \text{ mho/m}$ ;  $\epsilon_r = 38.5$ ;  $\rho = 1000 \text{ kg/m}^3$

Phantom section: Left Section

Test Date: 12-17-2009; Ambient Temp: 23.5 °C; Tissue Temp: 21.9 °C

Probe: ES3DV3 - SN3209; ConvF(5.1, 5.1, 5.1); Calibrated: 4/15/2009

Sensor-Surface: 3mm (Mechanical Surface Detection)

Electronics: DAE4 Sn665; Calibrated: 5/25/2009

Phantom: SAM with CRP; Type: SAM; Serial: TP1375

Measurement SW: DASY4, V4.7 Build 71; Postprocessing SW: SEMCAD, V1.8 Build 184

**Mode: PCS CDMA, Left Head, Slide Out, Tilt, Mid.ch**

**Area Scan (7x12x1):** Measurement grid: dx=15mm, dy=15mm

**Zoom Scan (5x5x7)/Cube 0:** Measurement grid: dx=8mm, dy=8mm, dz=5mm

Reference Value = 15.3 V/m

Peak SAR (extrapolated) = 0.475 W/kg

**SAR(1 g) = 0.319 mW/g; SAR(10 g) = 0.203 mW/g**

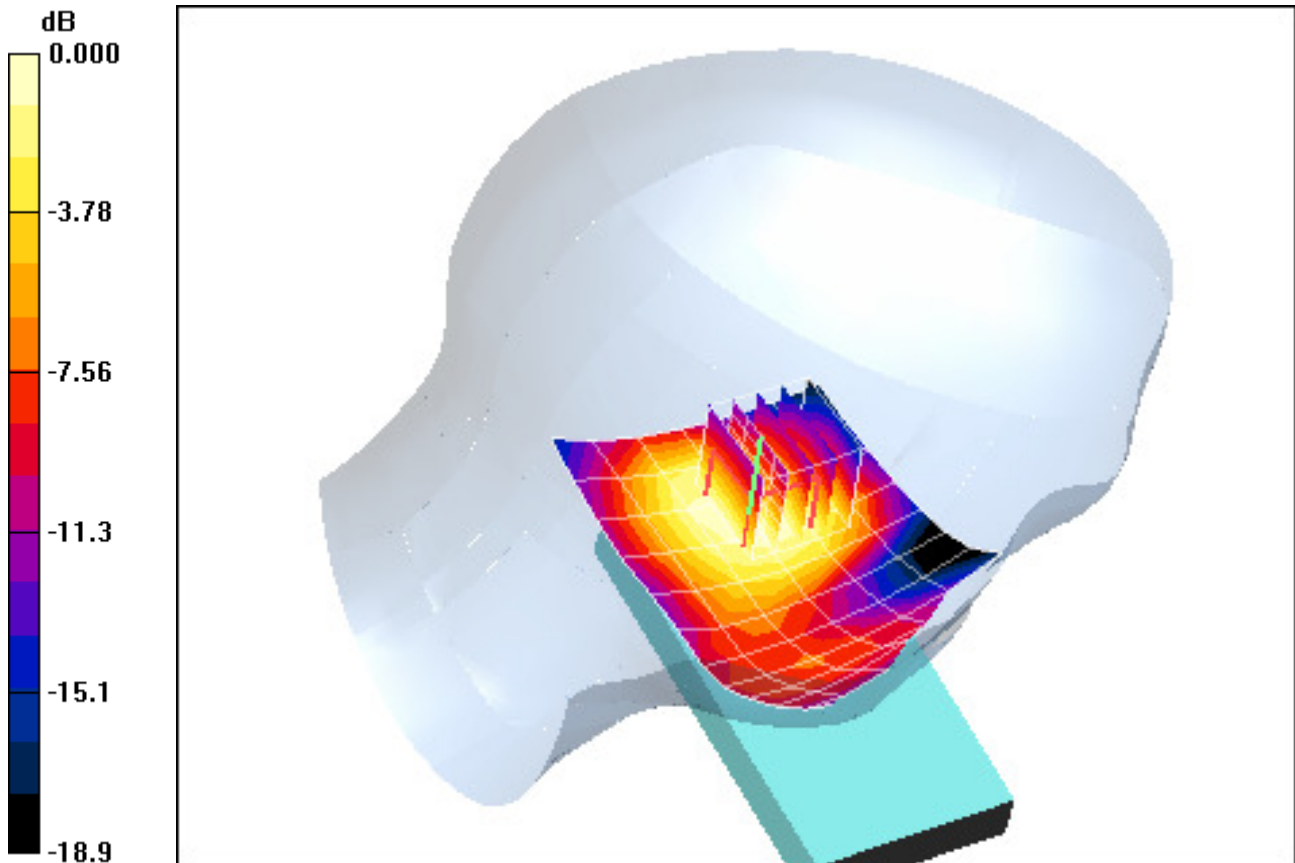

0 dB = 0.376mW/g

# PCTEST ENGINEERING LABORATORY, INC.

**DUT: MN240, LW240; Type: Cellular/AWS/PCS CDMA Phone w/ BT; Serial: RF**

Communication System: Cellular CDMA; Frequency: 836.52 MHz; Duty Cycle: 1:1

Medium: 835 Muscle Medium parameters used (interpolated):

$f = 836.52 \text{ MHz}$ ;  $\sigma = 0.981 \text{ mho/m}$ ;  $\epsilon_r = 52.9$ ;  $\rho = 1000 \text{ kg/m}^3$

Phantom section: Flat Section; Space: 2.0 cm

Test Date: 12-21-2009; Ambient Temp: 23.8 °C; Tissue Temp: 22.4 °C

Probe: ES3DV3 - SN3209; ConvF(6.07, 6.07, 6.07); Calibrated: 4/15/2009

Sensor-Surface: 3mm (Mechanical Surface Detection)

Electronics: DAE4 Sn665; Calibrated: 5/25/2009

Phantom: SAM with CRP; Type: SAM; Serial: TP1375

Measurement SW: DASY4, V4.7 Build 71; Postprocessing SW: SEMCAD, V1.8 Build 184

**Mode: Cellular CDMA, Body SAR, Back side, Slide In, Mid.ch**

**Area Scan (7x10x1):** Measurement grid: dx=15mm, dy=15mm

**Zoom Scan (5x5x7)/Cube 0:** Measurement grid: dx=8mm, dy=8mm, dz=5mm

Reference Value = 26.6 V/m

Peak SAR (extrapolated) = 0.917 W/kg

**SAR(1 g) = 0.661 mW/g; SAR(10 g) = 0.460 mW/g**

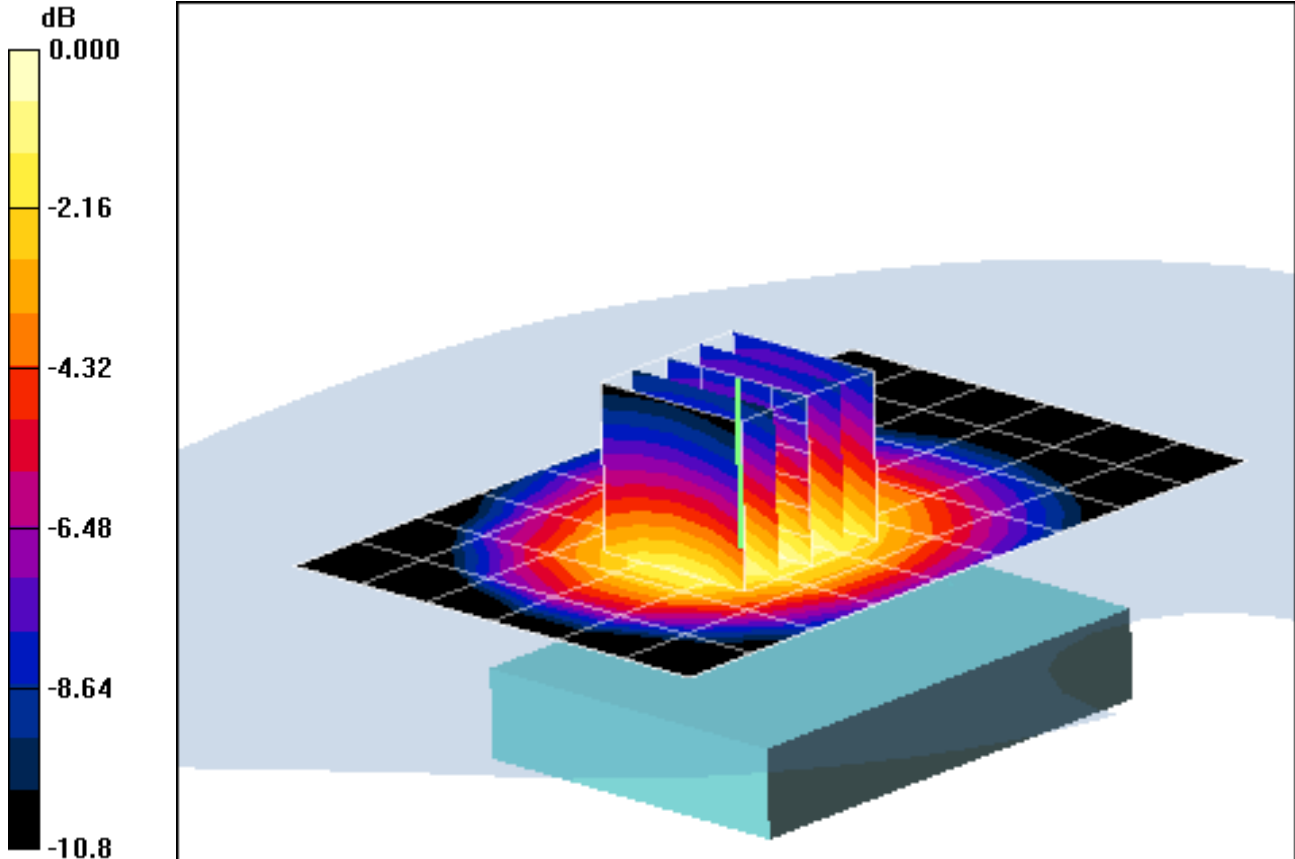

0 dB = 0.747mW/g

# PCTEST ENGINEERING LABORATORY, INC.

**DUT: MN240, LW240; Type: Cellular/AWS/PCS CDMA Phone w/ BT; Serial: RF**

Communication System: Cellular CDMA; Frequency: 836.52 MHz; Duty Cycle: 1:1

Medium: 835 Muscle Medium parameters used (interpolated):

$f = 836.52 \text{ MHz}$ ;  $\sigma = 0.981 \text{ mho/m}$ ;  $\epsilon_r = 52.9$ ;  $\rho = 1000 \text{ kg/m}^3$

Phantom section: Flat Section; Space: 2.0 cm

Test Date: 12-21-2009; Ambient Temp: 23.8 °C; Tissue Temp: 22.4 °C

Probe: ES3DV3 - SN3209; ConvF(6.07, 6.07, 6.07); Calibrated: 4/15/2009

Sensor-Surface: 3mm (Mechanical Surface Detection)

Electronics: DAE4 Sn665; Calibrated: 5/25/2009

Phantom: SAM with CRP; Type: SAM; Serial: TP1375

Measurement SW: DASY4, V4.7 Build 71; Postprocessing SW: SEMCAD, V1.8 Build 184

**Mode: Cellular CDMA, Body SAR, Back side, Slide In, Mid.ch**

**Area Scan (7x10x1):** Measurement grid: dx=15mm, dy=15mm

**Zoom Scan (5x5x7)/Cube 0:** Measurement grid: dx=8mm, dy=8mm, dz=5mm

Reference Value = 26.6 V/m

Peak SAR (extrapolated) = 0.917 W/kg

**SAR(1 g) = 0.661 mW/g; SAR(10 g) = 0.460 mW/g**

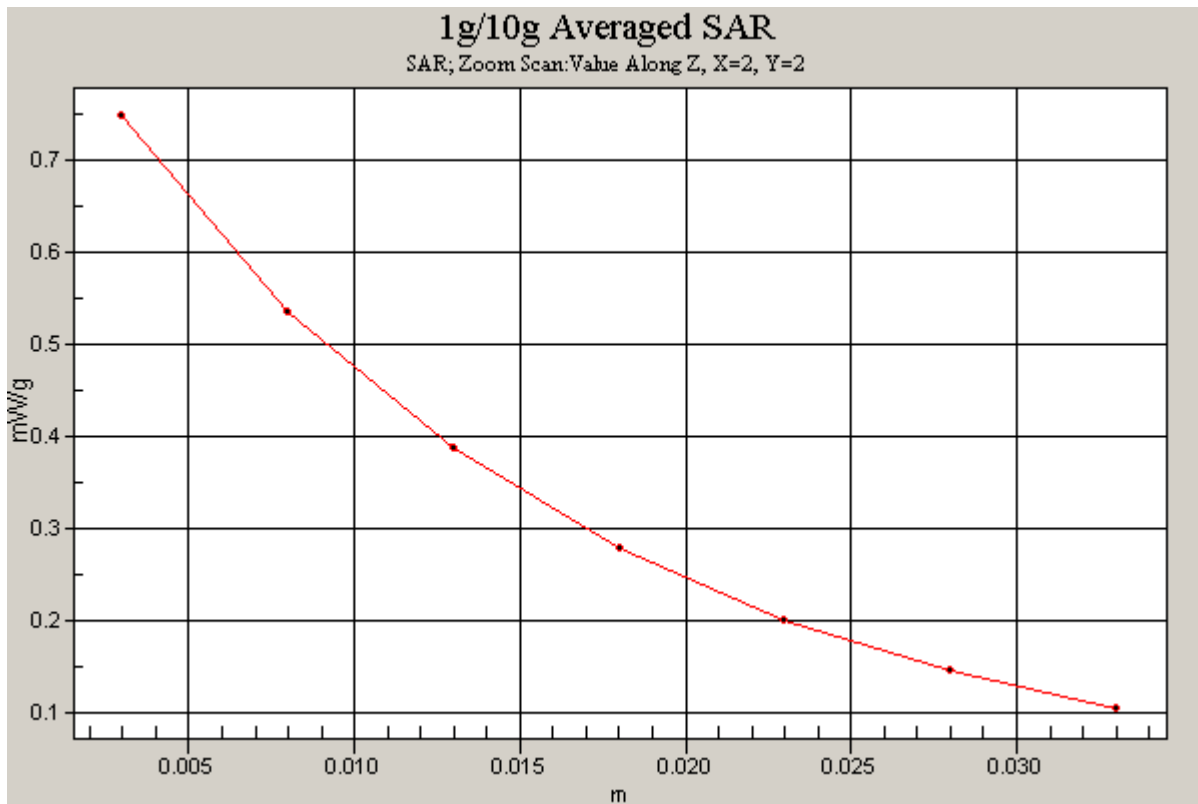

# PCTEST ENGINEERING LABORATORY, INC.

**DUT: MN240, LW240; Type: Cellular/AWS/PCS CDMA Phone w/ BT; Serial: SAR #1**

Communication System: AWS CDMA; Frequency: 1732.5 MHz; Duty Cycle: 1:1

Medium: 1750 Muscle Medium parameters used (interpolated):

$f = 1732.5 \text{ MHz}$ ;  $\sigma = 1.41 \text{ mho/m}$ ;  $\epsilon_r = 54.2$ ;  $\rho = 1000 \text{ kg/m}^3$

Phantom section: Flat Section; Space: 2.0 cm

Test Date: 12-22-2009; Ambient Temp: 22.8 °C; Tissue Temp: 21.4 °C

Probe: ES3DV3 - SN3209; ConvF(4.83, 4.83, 4.83); Calibrated: 4/15/2009

Sensor-Surface: 3mm (Mechanical Surface Detection)

Electronics: DAE4 Sn665; Calibrated: 5/25/2009

Phantom: SAM with CRP; Type: SAM; Serial: TP1375

Measurement SW: DASY4, V4.7 Build 71; Postprocessing SW: SEMCAD, V1.8 Build 184

**Mode: AWS CDMA, Body SAR, Back side, Slide In, Mid.ch**

**Area Scan (7x10x1):** Measurement grid: dx=15mm, dy=15mm

**Zoom Scan (5x5x7)/Cube 0:** Measurement grid: dx=8mm, dy=8mm, dz=5mm

Reference Value = 22.3 V/m

Peak SAR (extrapolated) = 1.13 W/kg

**SAR(1 g) = 0.714 mW/g; SAR(10 g) = 0.406 mW/g**

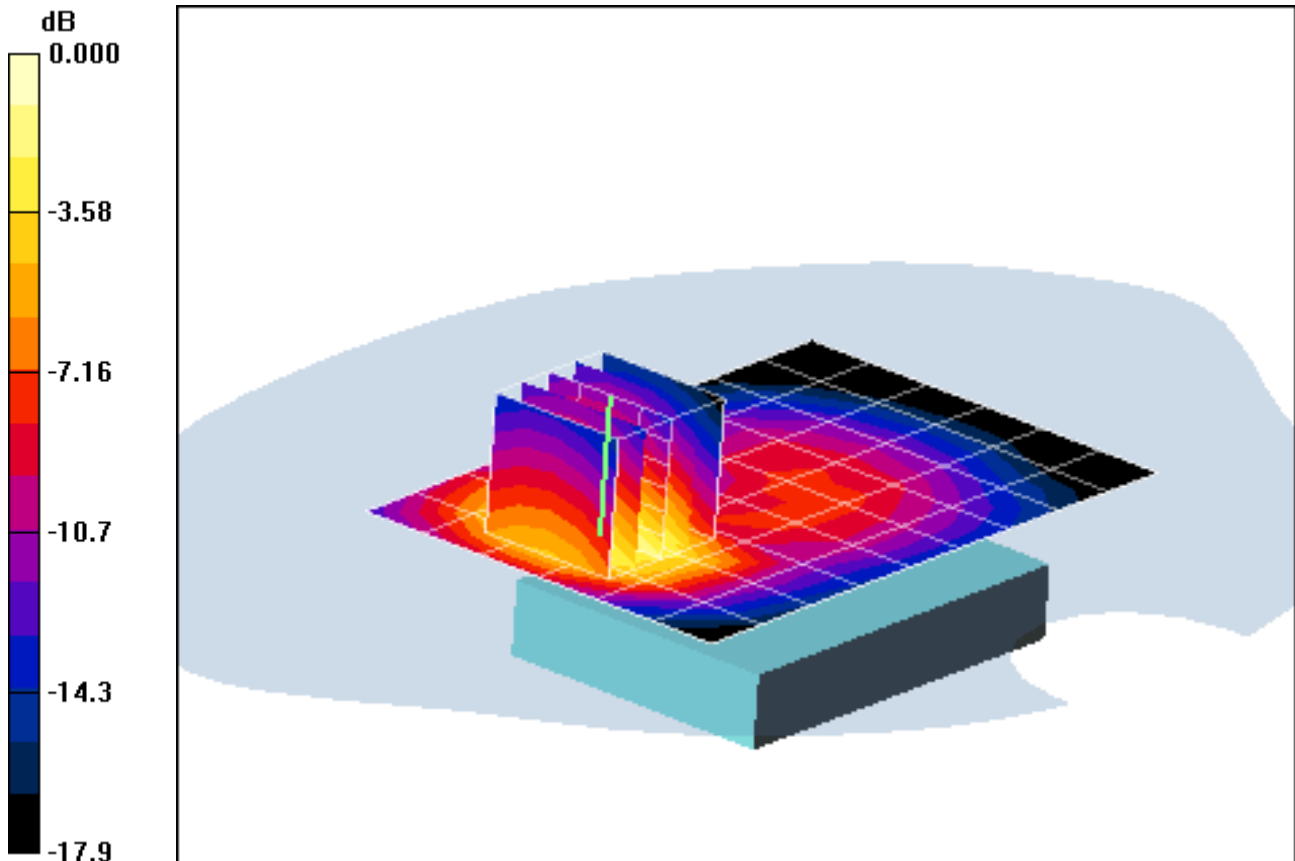

0 dB = 0.865mW/g

# PCTEST ENGINEERING LABORATORY, INC.

**DUT: MN240, LW240; Type: Cellular/AWS/PCS CDMA Phone w/ BT; Serial: SAR #1**

Communication System: AWS CDMA; Frequency: 1732.5 MHz; Duty Cycle: 1:1

Medium: 1750 Muscle Medium parameters used (interpolated):

$$f = 1732.5 \text{ MHz}; \sigma = 1.41 \text{ mho/m}; \epsilon_r = 54.2; \rho = 1000 \text{ kg/m}^3$$

Phantom section: Flat Section; Space: 2.0 cm

Test Date: 12-22-2009; Ambient Temp: 22.8 °C; Tissue Temp: 21.4 °C

Probe: ES3DV3 - SN3209; ConvF(4.83, 4.83, 4.83); Calibrated: 4/15/2009

Sensor-Surface: 3mm (Mechanical Surface Detection)

Electronics: DAE4 Sn665; Calibrated: 5/25/2009

Phantom: SAM with CRP; Type: SAM; Serial: TP1375

Measurement SW: DASY4, V4.7 Build 71; Postprocessing SW: SEMCAD, V1.8 Build 184

**Mode: AWS CDMA, Body SAR, Back side, Slide In, Mid.ch**

**Area Scan (7x10x1):** Measurement grid: dx=15mm, dy=15mm

**Zoom Scan (5x5x7)/Cube 0:** Measurement grid: dx=8mm, dy=8mm, dz=5mm

Reference Value = 22.3 V/m

Peak SAR (extrapolated) = 1.13 W/kg

**SAR(1 g) = 0.714 mW/g; SAR(10 g) = 0.406 mW/g**

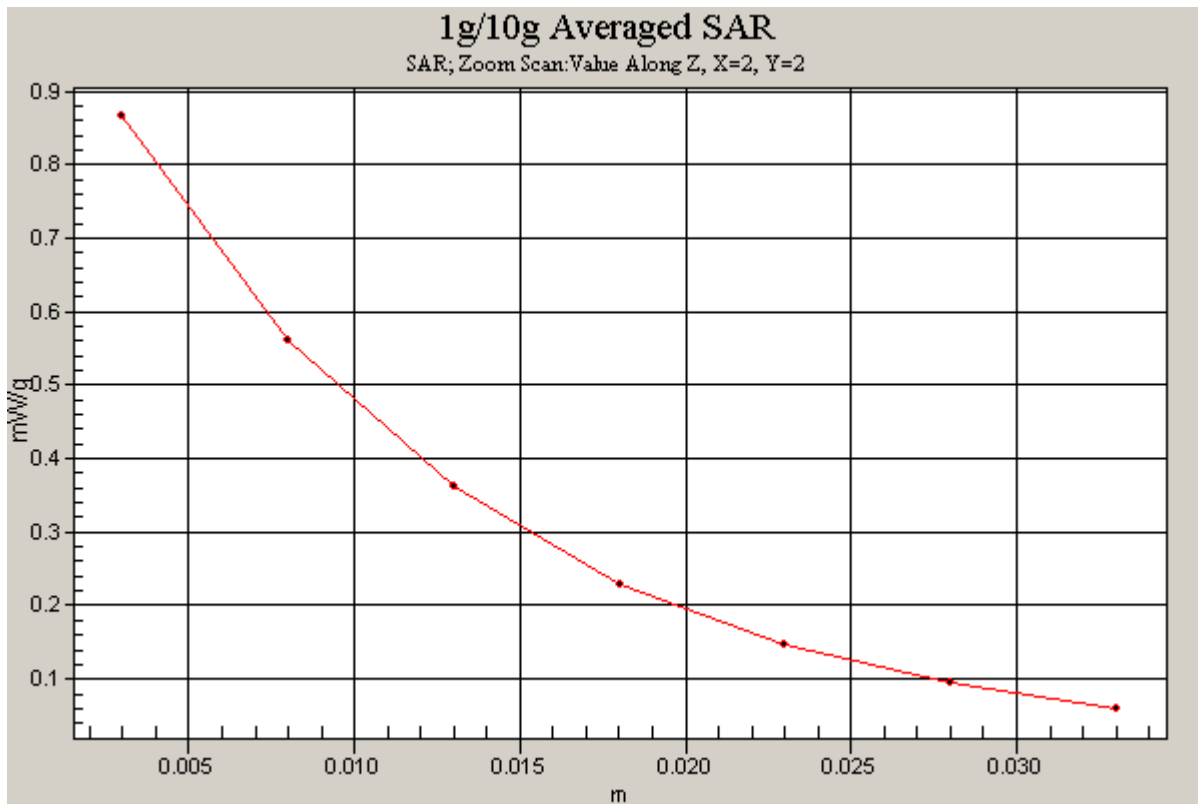

# PCTEST ENGINEERING LABORATORY, INC.

**DUT: MN240, LW240; Type: Cellular/AWS/PCS CDMA Phone w/ BT; Serial: SAR #1**

Communication System: PCS CDMA; Frequency: 1880 MHz; Duty Cycle: 1:1

Medium: 1900 Muscle Medium parameters used:

$f = 1880 \text{ MHz}$ ;  $\sigma = 1.55 \text{ mho/m}$ ;  $\epsilon_r = 52.6$ ;  $\rho = 1000 \text{ kg/m}^3$

Phantom section: Flat Section; Space: 2.0 cm

Test Date: 12-17-2009; Ambient Temp: 22.8 °C; Tissue Temp: 21.3 °C

Probe: ES3DV3 - SN3209; ConvF(4.55, 4.55, 4.55); Calibrated: 4/15/2009

Sensor-Surface: 3mm (Mechanical Surface Detection)

Electronics: DAE4 Sn665; Calibrated: 5/25/2009

Phantom: SAM with CRP; Type: SAM; Serial: TP1375

Measurement SW: DASY4, V4.7 Build 71; Postprocessing SW: SEMCAD, V1.8 Build 184

**Mode: PCS CDMA, Body SAR, Back side, Slide In, Mid.ch**

**Area Scan (7x10x1):** Measurement grid:  $dx=15\text{mm}$ ,  $dy=15\text{mm}$

**Zoom Scan (5x5x7)/Cube 0:** Measurement grid:  $dx=8\text{mm}$ ,  $dy=8\text{mm}$ ,  $dz=5\text{mm}$

Reference Value = 18.5 V/m

Peak SAR (extrapolated) = 0.759 W/kg

**SAR(1 g) = 0.470 mW/g; SAR(10 g) = 0.264 mW/g**

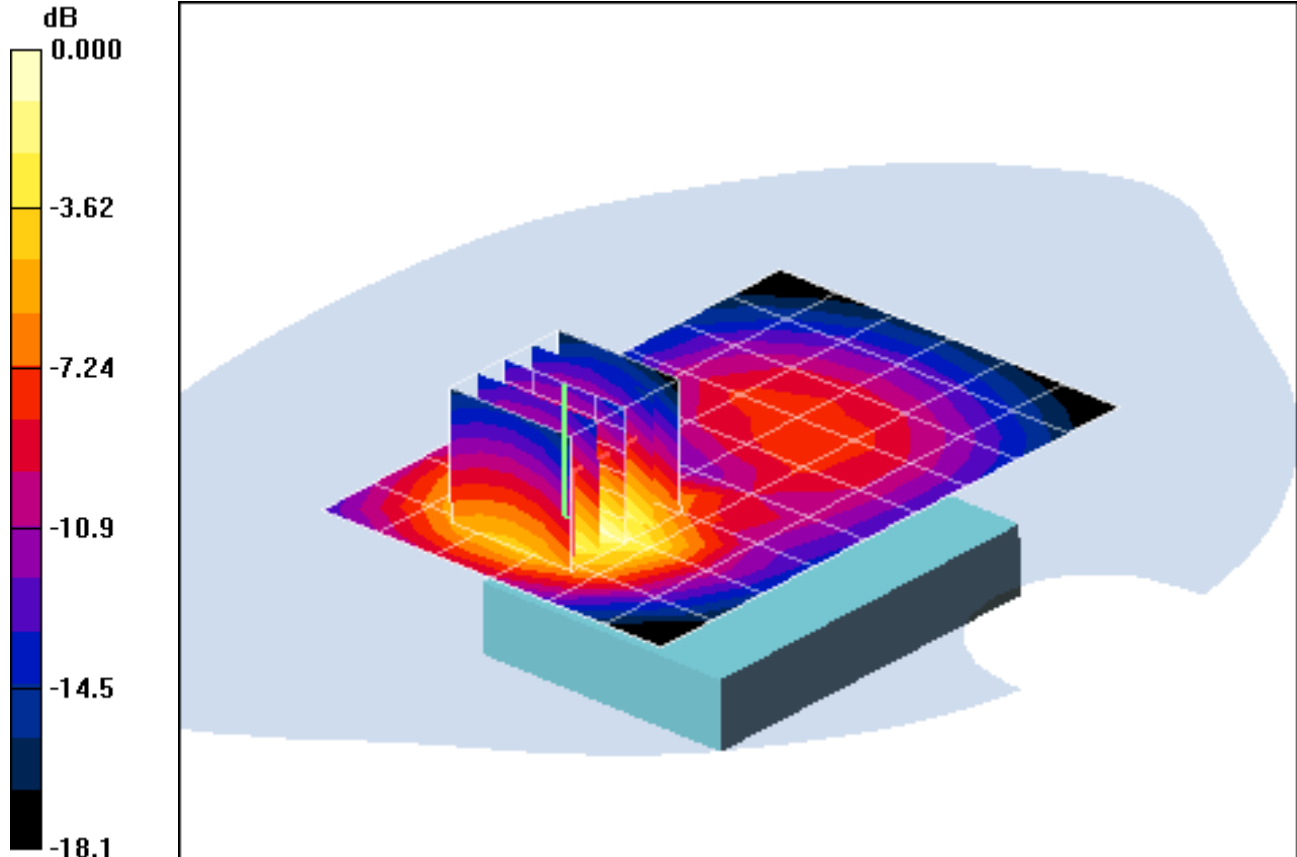

0 dB = 0.567mW/g

# PCTEST ENGINEERING LABORATORY, INC.

**DUT: MN240, LW240; Type: Cellular/AWS/PCS CDMA Phone w/ BT; Serial: SAR #1**

Communication System: PCS CDMA; Frequency: 1880 MHz; Duty Cycle: 1:1

Medium: 1900 Muscle Medium parameters used:

$f = 1880 \text{ MHz}$ ;  $\sigma = 1.55 \text{ mho/m}$ ;  $\epsilon_r = 52.6$ ;  $\rho = 1000 \text{ kg/m}^3$

Phantom section: Flat Section; Space: 2.0 cm

Test Date: 12-17-2009; Ambient Temp: 22.8 °C; Tissue Temp: 21.3 °C

Probe: ES3DV3 - SN3209; ConvF(4.55, 4.55, 4.55); Calibrated: 4/15/2009

Sensor-Surface: 3mm (Mechanical Surface Detection)

Electronics: DAE4 Sn665; Calibrated: 5/25/2009

Phantom: SAM with CRP; Type: SAM; Serial: TP1375

Measurement SW: DASY4, V4.7 Build 71; Postprocessing SW: SEMCAD, V1.8 Build 184

**Mode: PCS CDMA, Body SAR, Back side, Slide In, Mid.ch**

**Area Scan (7x10x1):** Measurement grid: dx=15mm, dy=15mm

**Zoom Scan (5x5x7)/Cube 0:** Measurement grid: dx=8mm, dy=8mm, dz=5mm

Reference Value = 18.5 V/m

Peak SAR (extrapolated) = 0.759 W/kg

**SAR(1 g) = 0.470 mW/g; SAR(10 g) = 0.264 mW/g**

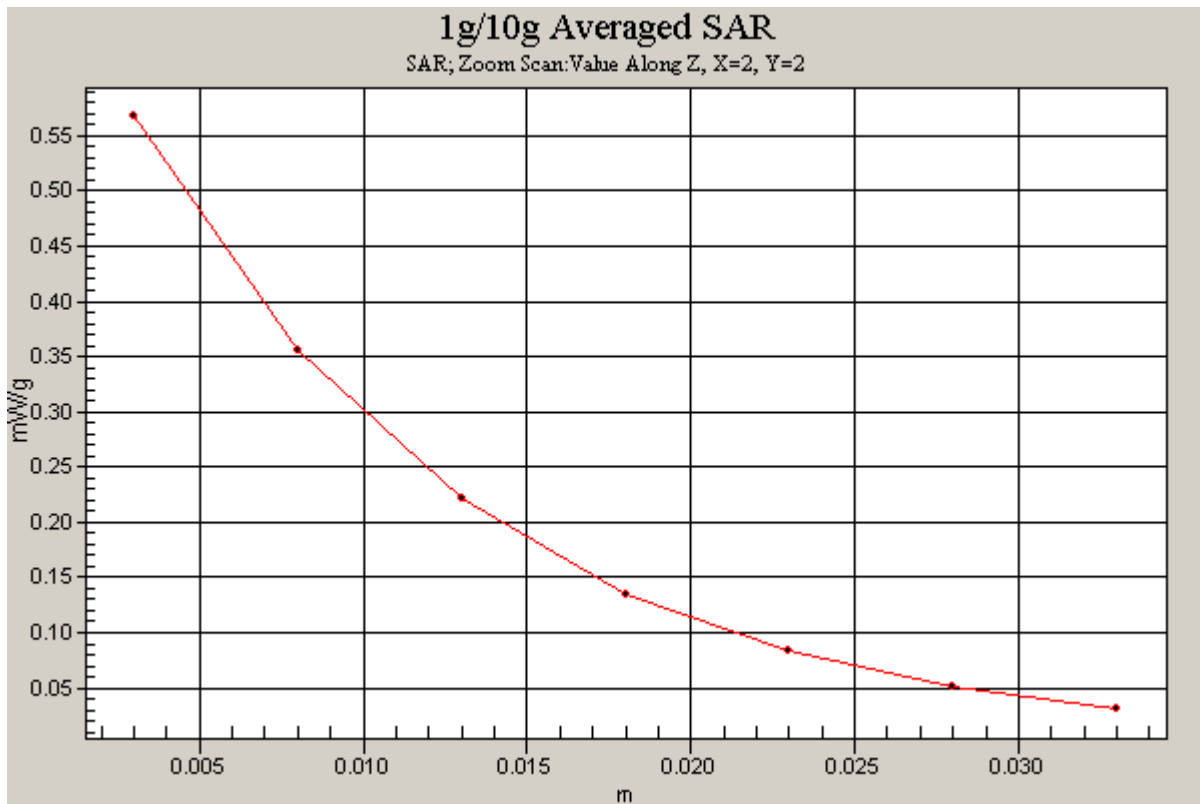

## **APPENDIX B: DIPOLE VALIDATION**

# PCTEST ENGINEERING LABORATORY, INC.

**DUT: Dipole 835 MHz; Type: D835V2; Serial: 4d047**

Communication System: CW; Frequency: 835 MHz; Duty Cycle: 1:1

Medium: 835 Brain Medium parameters used:

$f = 835 \text{ MHz}$ ;  $\sigma = 0.898 \text{ mho/m}$ ;  $\epsilon_r = 40.3$ ;  $\rho = 1000 \text{ kg/m}^3$

Phantom section: Flat Section; Space: 1.5 cm

Test Date: 12-18-2009; Ambient Temp: 23.9 °C; Tissue Temp: 22.5 °C

Probe: ES3DV3 - SN3209; ConvF(6.1, 6.1, 6.1); Calibrated: 4/15/2009

Sensor-Surface: 3mm (Mechanical Surface Detection)

Electronics: DAE4 Sn665; Calibrated: 5/25/2009

Phantom: SAM with CRP; Type: SAM; Serial: TP1375

Measurement SW: DASY4, V4.7 Build 71; Postprocessing SW: SEMCAD, V1.8 Build 184

## 835MHz Dipole Validation

**Area Scan (7x13x1):** Measurement grid: dx=15mm, dy=15mm

**Zoom Scan (5x5x7)/Cube 0:** Measurement grid: dx=8mm, dy=8mm, dz=5mm

Input Power = 20.0 dBm (100 mW)

**SAR(1 g) = 1.06 mW/g; SAR(10 g) = 0.692 mW/g**

Deviation = 9.28 %

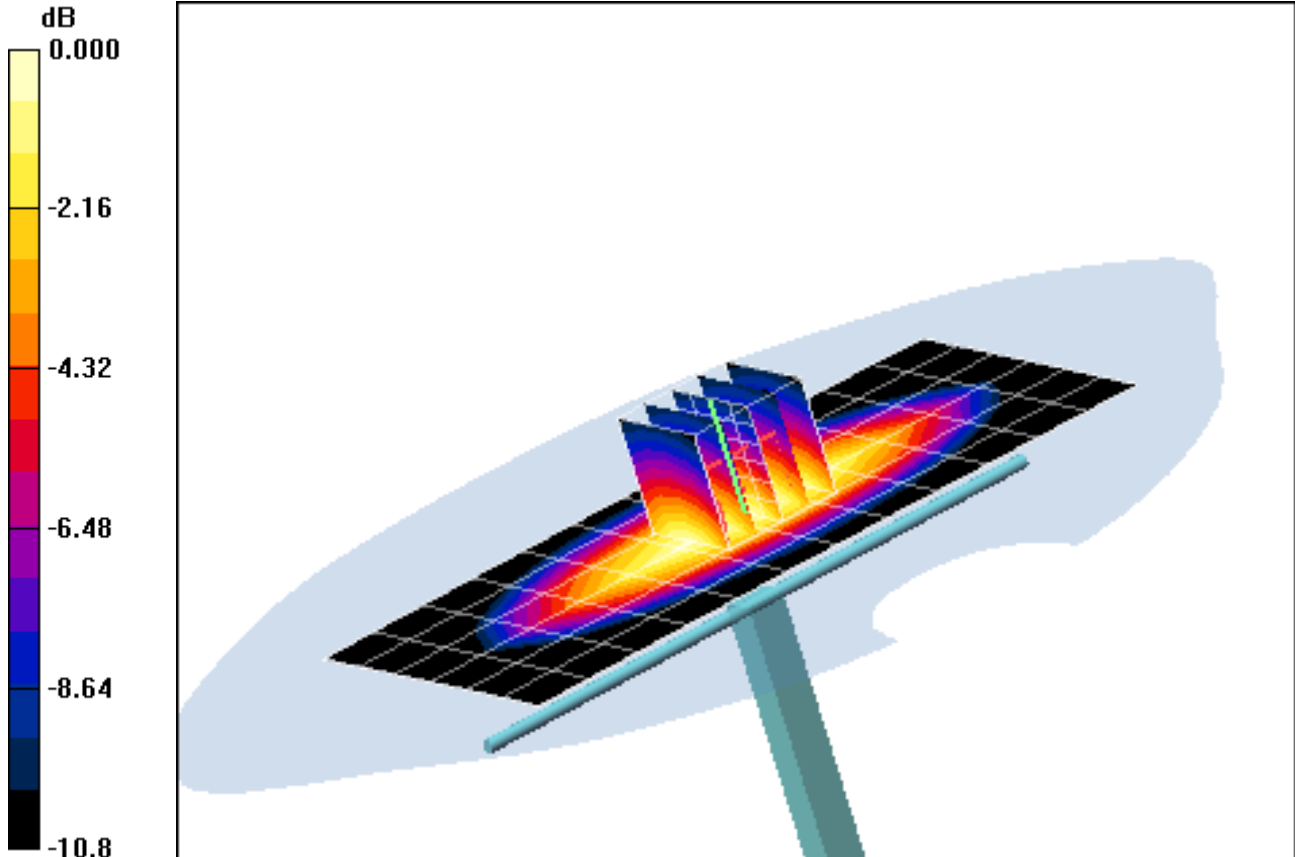

0 dB = 1.24mW/g

# PCTEST ENGINEERING LABORATORY, INC.

**DUT: Dipole 835 MHz; Type: D835V2; Serial: 4d047**

Communication System: CW; Frequency: 835 MHz; Duty Cycle: 1:1

Medium: 835 Brain Medium parameters used:

$f = 835 \text{ MHz}$ ;  $\sigma = 0.897 \text{ mho/m}$ ;  $\epsilon_r = 40.3$ ;  $\rho = 1000 \text{ kg/m}^3$

Phantom section: Flat Section; Space: 1.5 cm

Test Date: 12-21-2009; Ambient Temp: 24.1 °C; Tissue Temp: 23.3 °C

Probe: ES3DV3 - SN3209; ConvF(6.1, 6.1, 6.1); Calibrated: 4/15/2009

Sensor-Surface: 3mm (Mechanical Surface Detection)

Electronics: DAE4 Sn665; Calibrated: 5/25/2009

Phantom: SAM with CRP; Type: SAM; Serial: TP1375

Measurement SW: DASY4, V4.7 Build 71; Postprocessing SW: SEMCAD, V1.8 Build 184

## 835MHz Dipole Validation

**Area Scan (7x13x1):** Measurement grid: dx=15mm, dy=15mm

**Zoom Scan (5x5x7)/Cube 0:** Measurement grid: dx=8mm, dy=8mm, dz=5mm

Input Power = 24.0 dBm (254 mW)

**SAR(1 g) = 2.55 mW/g; SAR(10 g) = 1.66 mW/g**

Deviation = 3.70 %

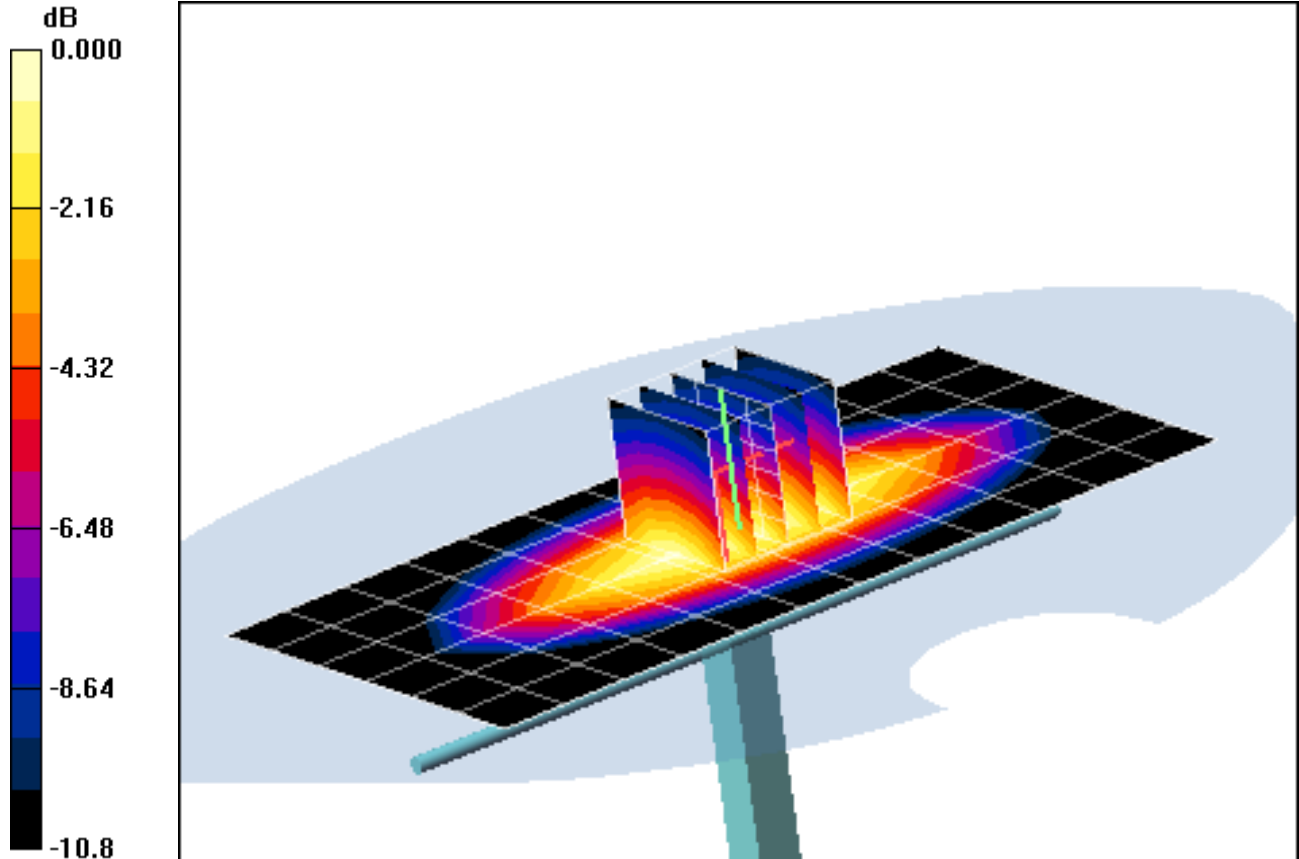

0 dB = 2.99mW/g

# PCTEST ENGINEERING LABORATORY, INC.

**DUT: Dipole 1760 MHz; Type: D1760V2; Serial: 1008**

Communication System: CW; Frequency: 1765 MHz; Duty Cycle: 1:1

Medium: 1750 Brain Medium parameters used (interpolated):

$f = 1765 \text{ MHz}$ ;  $\sigma = 1.34 \text{ mho/m}$ ;  $\epsilon_r = 40.6$ ;  $\rho = 1000 \text{ kg/m}^3$

Phantom section: Flat Section; Space: 1.0 cm

Test Date: 12-22-2009; Ambient Temp: 23.9 °C; Tissue Temp: 22.0 °C

Probe: ES3DV3 - SN3209; ConvF(5.29, 5.29, 5.29); Calibrated: 4/15/2009

Sensor-Surface: 3mm (Mechanical Surface Detection)

Electronics: DAE4 Sn665; Calibrated: 5/25/2009

Phantom: SAM with CRP; Type: SAM; Serial: TP1375

Measurement SW: DASY4, V4.7 Build 71; Postprocessing SW: SEMCAD, V1.8 Build 184

## 1750 MHz SAR Validation

**Area Scan (6x6x1):** Measurement grid: dx=15mm, dy=15mm

**Zoom Scan (5x5x7)/Cube 0:** Measurement grid: dx=8mm, dy=8mm, dz=5mm

Input Power = 20.0 dBm (100 mW)

**SAR(1 g) = 3.82 mW/g; SAR(10 g) = 1.98 mW/g**

Deviation = -0.46 %

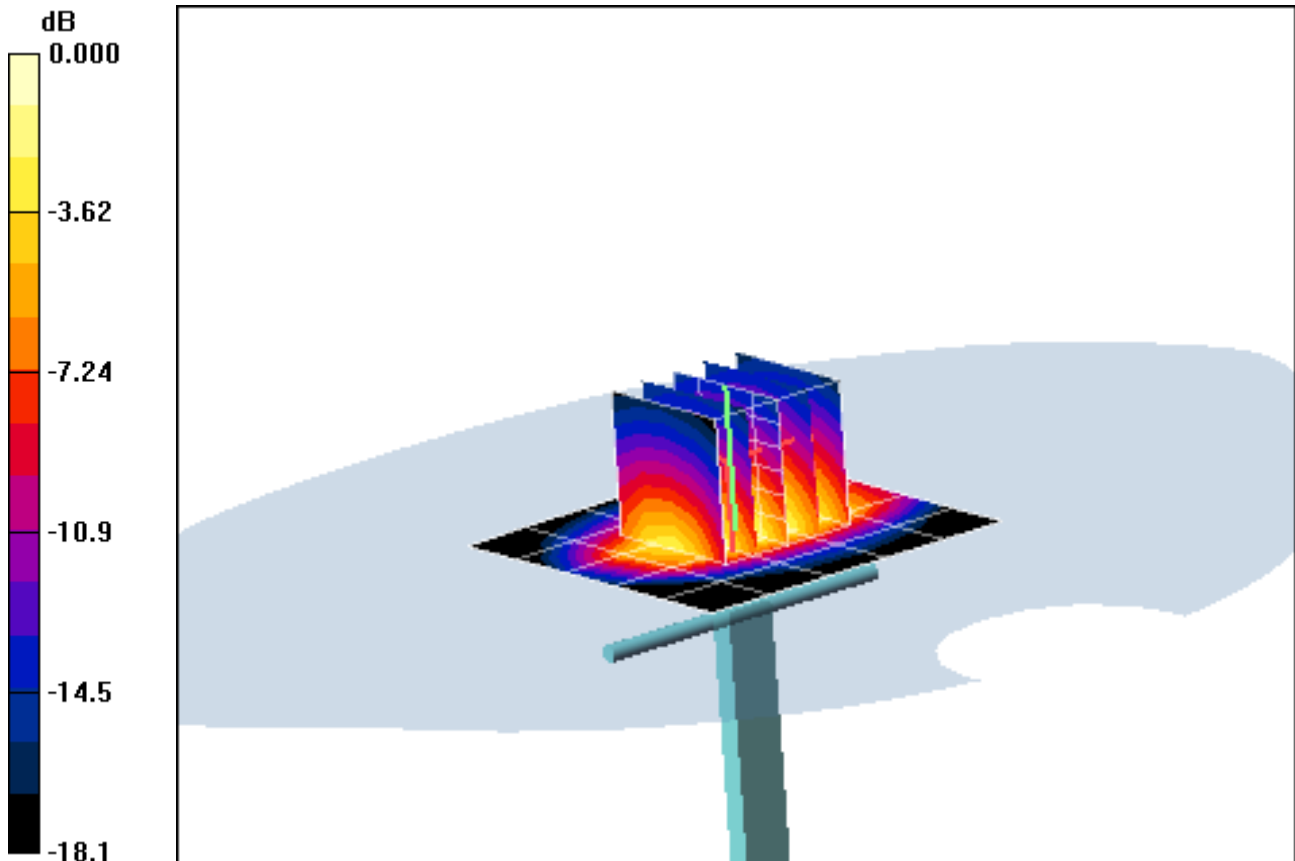

0 dB = 4.79mW/g

# PCTEST ENGINEERING LABORATORY, INC.

**DUT: SAR Dipole 1900 MHz; Type: D1900V2; Serial: 502**

Communication System: CW; Frequency: 1900 MHz; Duty Cycle: 1:1

Medium: 1900 Brain Medium parameters used (interpolated):

$f = 1900 \text{ MHz}$ ;  $\sigma = 1.45 \text{ mho/m}$ ;  $\epsilon_r = 38.4$ ;  $\rho = 1000 \text{ kg/m}^3$

Phantom section: Flat Section; Space: 1.0 cm

Test Date: 12-17-2009; Ambient Temp: 23.5 °C; Tissue Temp: 21.9 °C

Probe: ES3DV3 - SN3209; ConvF(5.1, 5.1, 5.1); Calibrated: 4/15/2009

Sensor-Surface: 3mm (Mechanical Surface Detection)

Electronics: DAE4 Sn665; Calibrated: 5/25/2009

Phantom: SAM with CRP; Type: SAM; Serial: TP1375

Measurement SW: DASY4, V4.7 Build 71; Postprocessing SW: SEMCAD, V1.8 Build 184

## 1900MHz Dipole Validation

**Area Scan (5x7x1):** Measurement grid: dx=15mm, dy=15mm

**Zoom Scan (5x5x7)/Cube 0:** Measurement grid: dx=8mm, dy=8mm, dz=5mm

Input Power = 20.0 dBm (100 mW)

**SAR(1 g) = 4.16 mW/g; SAR(10 g) = 2.14 mW/g**

Deviation = 4.26 %

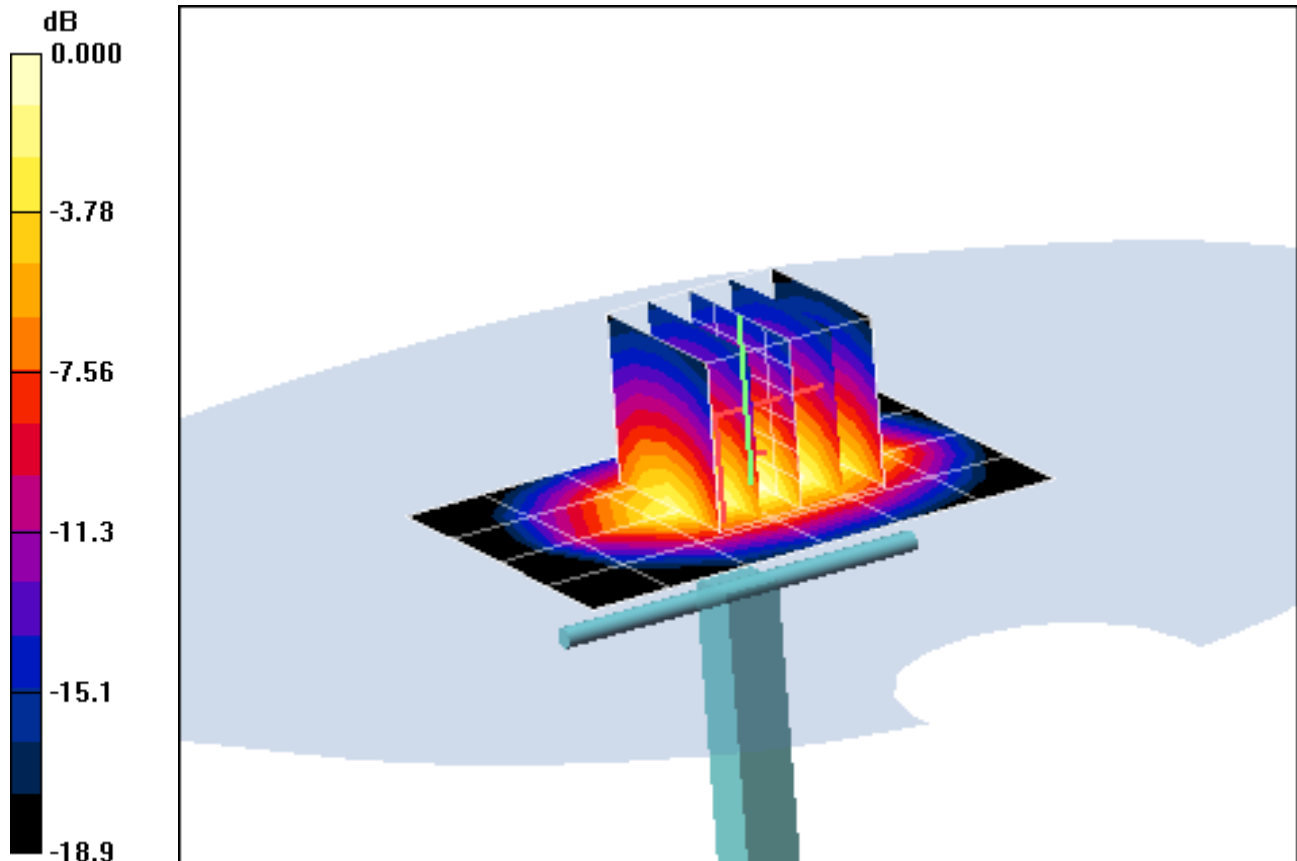

0 dB = 5.31mW/g

## **APPENDIX C: PROBE CALIBRATION**



Accredited by the Swiss Accreditation Service (SAS)  
The Swiss Accreditation Service is one of the signatories to the EA  
Multilateral Agreement for the recognition of calibration certificates

Accreditation No.: SCS 108

Client **PC Test**

Certificate No: **ES3-3209\_Apr09**

## CALIBRATION CERTIFICATE

Object **ES3DV3 - SN:3209**

Calibration procedure(s) **QA CAL-01.v6 and QA CAL-23.v3  
Calibration procedure for dosimetric E-field probes**

Calibration date: **April 15, 2009**

Condition of the calibrated item **In Tolerance**

*OK  
4/23/09  
[Signature]*

This calibration certificate documents the traceability to national standards, which realize the physical units of measurements (SI).  
The measurements and the uncertainties with confidence probability are given on the following pages and are part of the certificate.

All calibrations have been conducted in the closed laboratory facility: environment temperature (22 ± 3)°C and humidity < 70%.

Calibration Equipment used (M&TE critical for calibration)

Primary Standards	ID #	Cal Date (Certificate No.)	Scheduled Calibration
Power meter E4419B	GB41293874	1-Apr-09 (No. 217-01030)	Apr-10
Power sensor E4412A	MY41495277	1-Apr-09 (No. 217-01030)	Apr-10
Power sensor E4412A	MY41498087	1-Apr-09 (No. 217-01030)	Apr-10
Reference 3 dB Attenuator	SN: S5054 (3c)	31-Mar-09 (No. 217-01026)	Mar-10
Reference 20 dB Attenuator	SN: S5086 (20b)	31-Mar-09 (No. 217-01028)	Mar-10
Reference 30 dB Attenuator	SN: S5129 (30b)	31-Mar-09 (No. 217-01027)	Mar-10
Reference Probe ES3DV2	SN: 3013	2-Jan-09 (No. ES3-3013_Jan09)	Jan-10
DAE4	SN: 660	9-Sep-08 (No. DAE4-660_Sep08)	Sep-09

Secondary Standards	ID #	Check Date (in house)	Scheduled Check
RF generator HP 8648C	US3642U01700	4-Aug-99 (in house check Oct-07)	In house check: Oct-09
Network Analyzer HP 8753E	US37390585	18-Oct-01 (in house check Oct-08)	In house check: Oct-09

Calibrated by:	Name <b>Katja Pokovic</b>	Function <b>Technical Manager</b>	Signature 
Approved by:	Name <b>Fin Bomholt</b>	R&D Director <b>R&amp;D Director</b>	Signature 

Issued: April 15, 2009

This calibration certificate shall not be reproduced except in full without written approval of the laboratory.



Accredited by the Swiss Accreditation Service (SAS)  
The Swiss Accreditation Service is one of the signatories to the EA  
Multilateral Agreement for the recognition of calibration certificates

Accreditation No.: **SCS 108**

### Glossary:

TSL	tissue simulating liquid
NORM <sub>x,y,z</sub>	sensitivity in free space
ConvF	sensitivity in TSL / NORM <sub>x,y,z</sub>
DCP	diode compression point
Polarization $\varphi$	$\varphi$ rotation around probe axis
Polarization $\vartheta$	$\vartheta$ rotation around an axis that is in the plane normal to probe axis (at measurement center), i.e., $\vartheta = 0$ is normal to probe axis

### Calibration is Performed According to the Following Standards:

- IEEE Std 1528-2003, "IEEE Recommended Practice for Determining the Peak Spatial-Averaged Specific Absorption Rate (SAR) in the Human Head from Wireless Communications Devices: Measurement Techniques", December 2003
- IEC 62209-1, "Procedure to measure the Specific Absorption Rate (SAR) for hand-held devices used in close proximity to the ear (frequency range of 300 MHz to 3 GHz)", February 2005

### Methods Applied and Interpretation of Parameters:

- NORM<sub>x,y,z</sub>**: Assessed for E-field polarization  $\vartheta = 0$  ( $f \leq 900$  MHz in TEM-cell;  $f > 1800$  MHz: R22 waveguide). NORM<sub>x,y,z</sub> are only intermediate values, i.e., the uncertainties of NORM<sub>x,y,z</sub> does not effect the E<sup>2</sup>-field uncertainty inside TSL (see below *ConvF*).
- NORM(f)<sub>x,y,z</sub>** = NORM<sub>x,y,z</sub> \* *frequency\_response* (see Frequency Response Chart). This linearization is implemented in DASY4 software versions later than 4.2. The uncertainty of the frequency response is included in the stated uncertainty of *ConvF*.
- DCP<sub>x,y,z</sub>**: DCP are numerical linearization parameters assessed based on the data of power sweep (no uncertainty required). DCP does not depend on frequency nor media.
- ConvF and Boundary Effect Parameters**: Assessed in flat phantom using E-field (or Temperature Transfer Standard for  $f \leq 800$  MHz) and inside waveguide using analytical field distributions based on power measurements for  $f > 800$  MHz. The same setups are used for assessment of the parameters applied for boundary compensation (alpha, depth) of which typical uncertainty values are given. These parameters are used in DASY4 software to improve probe accuracy close to the boundary. The sensitivity in TSL corresponds to NORM<sub>x,y,z</sub> \* *ConvF* whereby the uncertainty corresponds to that given for *ConvF*. A frequency dependent *ConvF* is used in DASY version 4.4 and higher which allows extending the validity from  $\pm 50$  MHz to  $\pm 100$  MHz.
- Spherical isotropy (3D deviation from isotropy)**: in a field of low gradients realized using a flat phantom exposed by a patch antenna.
- Sensor Offset**: The sensor offset corresponds to the offset of virtual measurement center from the probe tip (on probe axis). No tolerance required.

# Probe ES3DV3

## SN:3209

Manufactured: October 14, 2008  
Calibrated: April 15, 2009

Calibrated for DASY Systems

(Note: non-compatible with DASY2 system!)

## DASY - Parameters of Probe: ES3DV3 SN:3209

Sensitivity in Free Space <sup>A</sup>			Diode Compression <sup>B</sup>	
NormX	1.33 ± 10.1%	$\mu V/(V/m)^2$	DCP X	91 mV
NormY	1.34 ± 10.1%	$\mu V/(V/m)^2$	DCP Y	93 mV
NormZ	1.14 ± 10.1%	$\mu V/(V/m)^2$	DCP Z	92 mV

### Sensitivity in Tissue Simulating Liquid (Conversion Factors)

Please see Page 8.

### Boundary Effect

**TSL**                      **835 MHz**      Typical SAR gradient: 5 % per mm

Sensor Center to Phantom Surface Distance		<b>3.0 mm</b>	<b>4.0 mm</b>
SAR <sub>be</sub> [%]	Without Correction Algorithm	9.5	5.5
SAR <sub>be</sub> [%]	With Correction Algorithm	0.8	0.5

**TSL**                      **1750 MHz**      Typical SAR gradient: 10 % per mm

Sensor Center to Phantom Surface Distance		<b>3.0 mm</b>	<b>4.0 mm</b>
SAR <sub>be</sub> [%]	Without Correction Algorithm	8.6	5.1
SAR <sub>be</sub> [%]	With Correction Algorithm	0.8	0.3

### Sensor Offset

Probe Tip to Sensor Center                      **2.0 mm**

The reported uncertainty of measurement is stated as the standard uncertainty of measurement multiplied by the coverage factor k=2, which for a normal distribution corresponds to a coverage probability of approximately 95%.

<sup>A</sup> The uncertainties of NormX,Y,Z do not affect the E<sup>2</sup>-field uncertainty inside TSL (see Page 8).

<sup>B</sup> Numerical linearization parameter: uncertainty not required.

# Frequency Response of E-Field

(TEM-Cell:ifi110 EXX, Waveguide: R22)

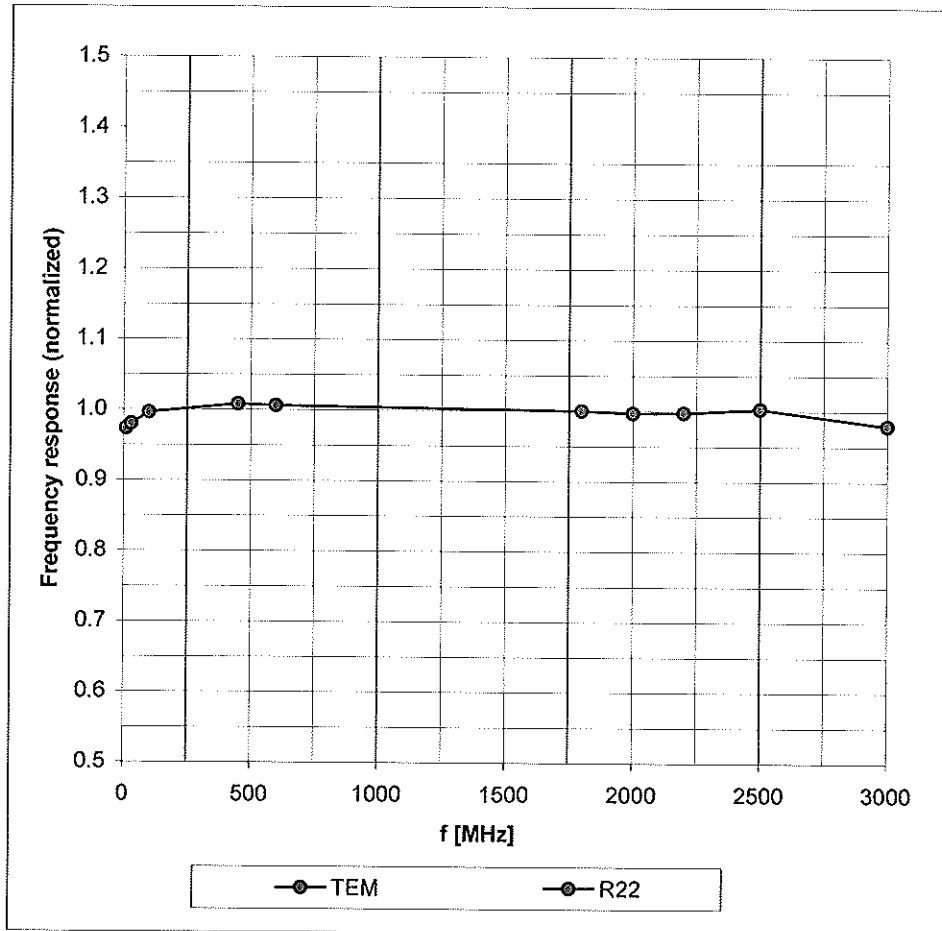

Uncertainty of Frequency Response of E-field:  $\pm 6.3\%$  ( $k=2$ )

### Receiving Pattern ( $\phi$ ), $\vartheta = 0^\circ$

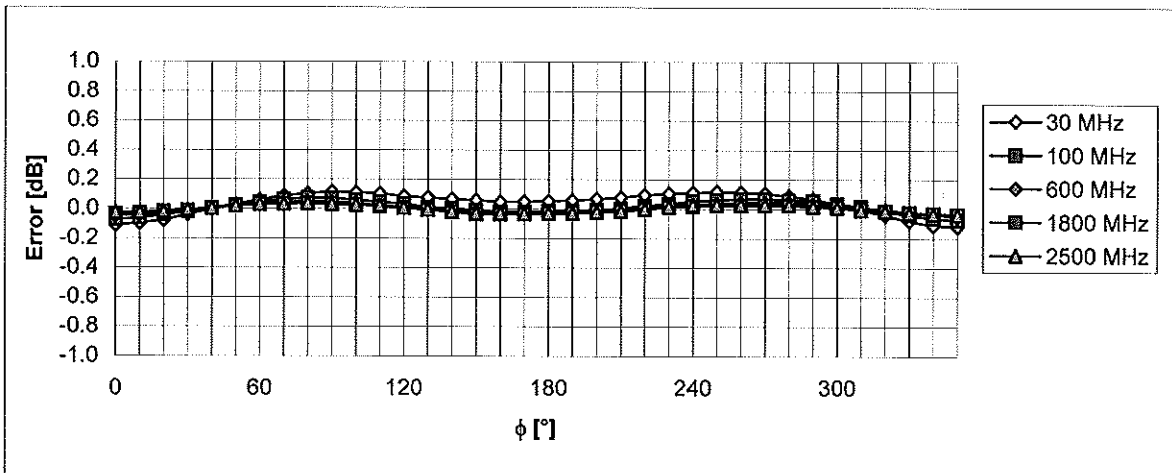
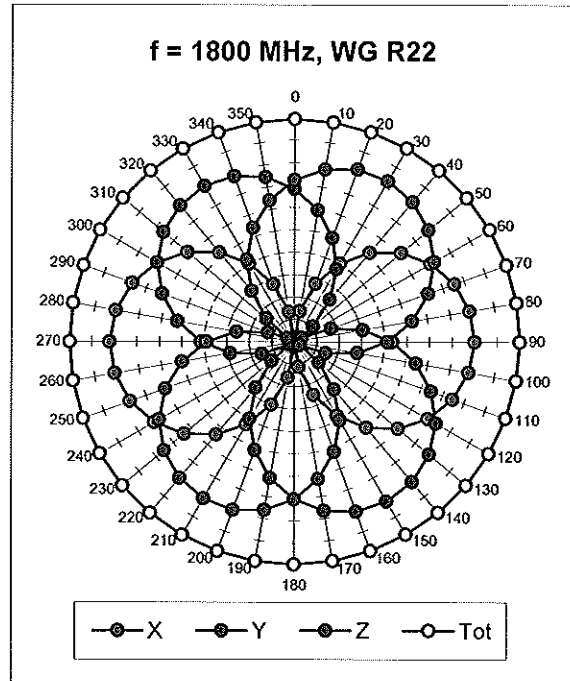
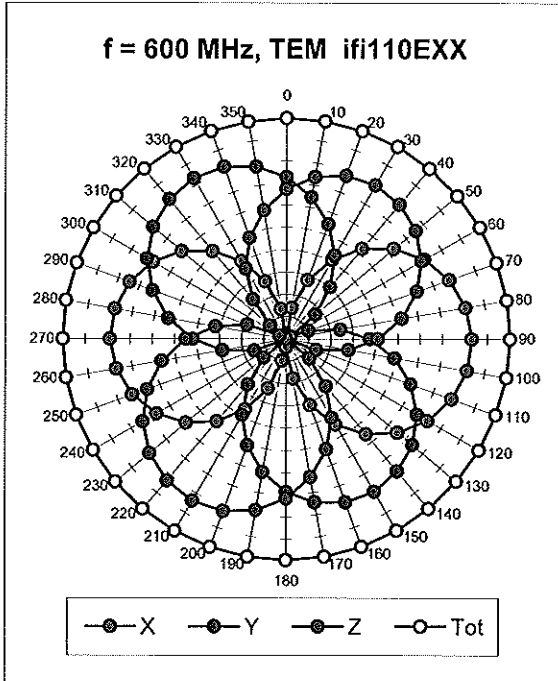

Uncertainty of Axial Isotropy Assessment:  $\pm 0.5\%$  (k=2)

### Dynamic Range f(SAR<sub>head</sub>) (Waveguide R22, f = 1800 MHz)

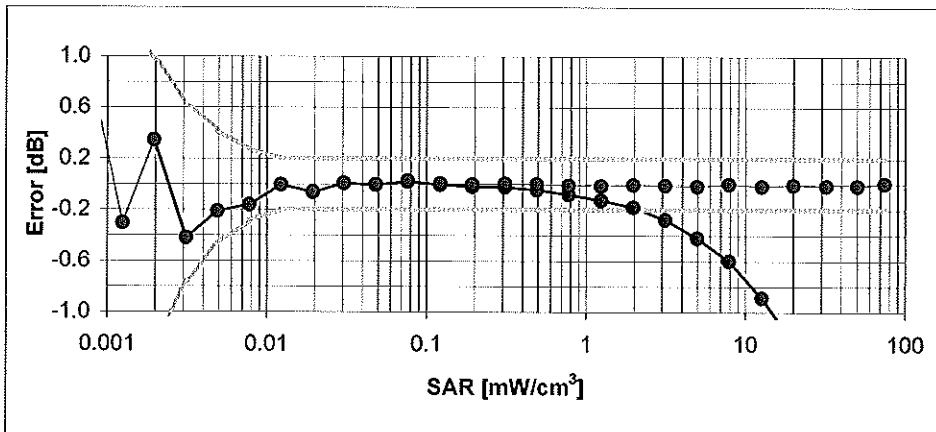
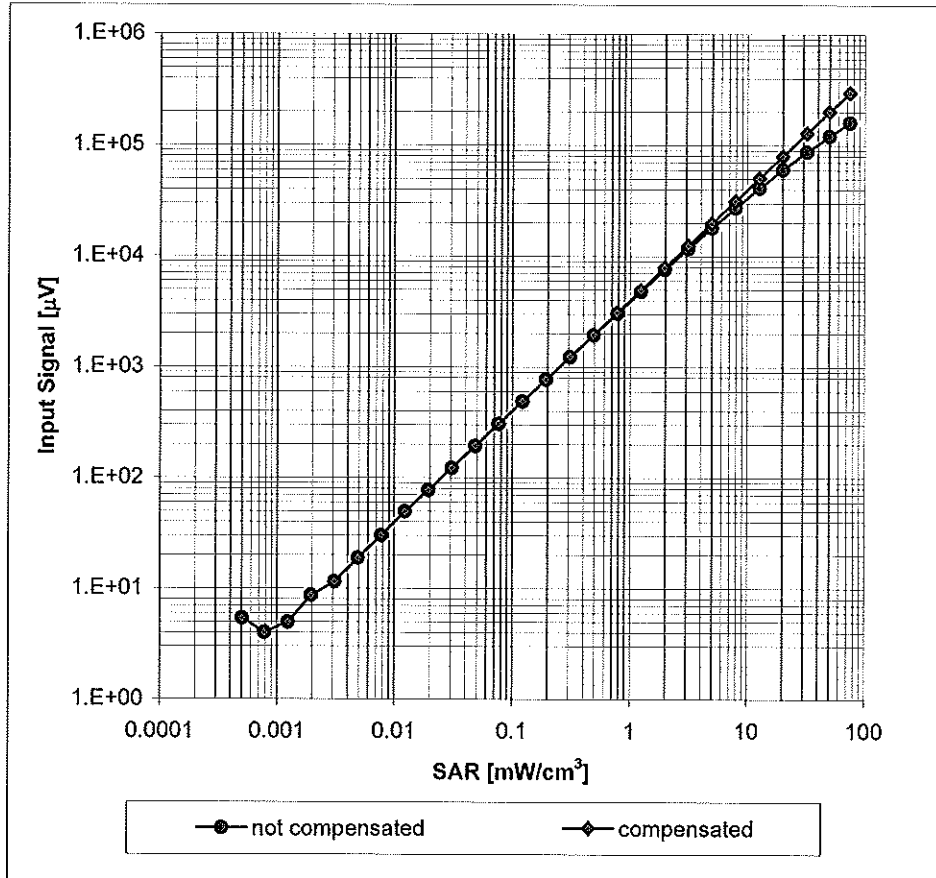

Uncertainty of Linearity Assessment: ± 0.6% (k=2)

## Conversion Factor Assessment

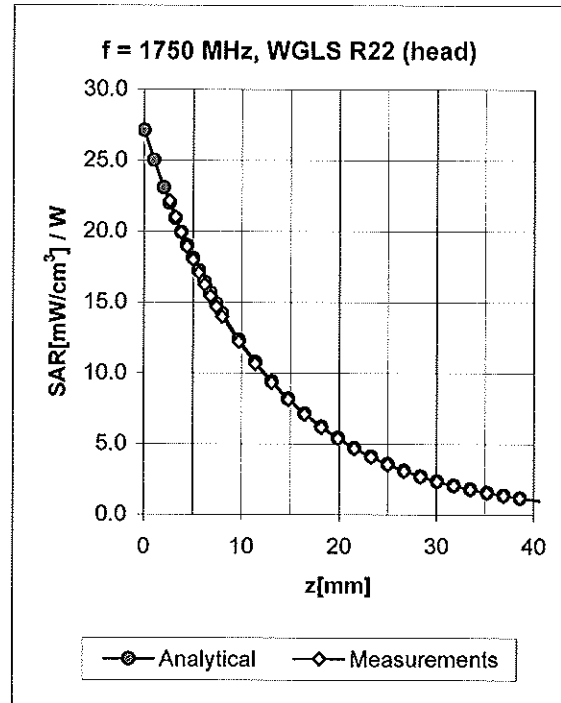
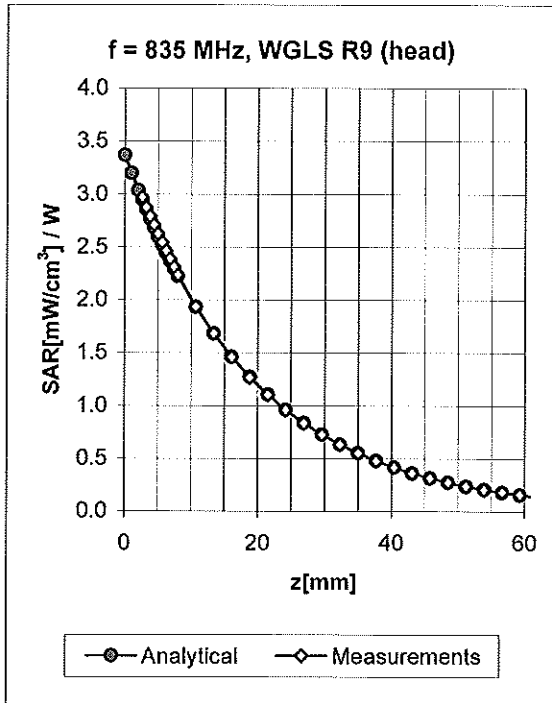

f [MHz]	Validity [MHz] <sup>c</sup>	TSL	Permittivity	Conductivity	Alpha	Depth	ConvF Uncertainty
835	± 50 / ± 100	Head	41.5 ± 5%	0.90 ± 5%	0.84	1.10	6.10 ± 11.0% (k=2)
1750	± 50 / ± 100	Head	40.1 ± 5%	1.37 ± 5%	0.40	1.74	5.29 ± 11.0% (k=2)
1900	± 50 / ± 100	Head	40.0 ± 5%	1.40 ± 5%	0.36	1.83	5.10 ± 11.0% (k=2)
835	± 50 / ± 100	Body	55.2 ± 5%	0.97 ± 5%	0.78	1.17	6.07 ± 11.0% (k=2)
1750	± 50 / ± 100	Body	53.4 ± 5%	1.49 ± 5%	0.33	2.21	4.83 ± 11.0% (k=2)
1900	± 50 / ± 100	Body	53.3 ± 5%	1.52 ± 5%	0.31	2.41	4.55 ± 11.0% (k=2)

<sup>c</sup> The validity of ± 100 MHz only applies for DASY v4.4 and higher (see Page 2). The uncertainty is the RSS of the ConvF uncertainty at calibration frequency and the uncertainty for the indicated frequency band.

# Deviation from Isotropy in HSL

Error ( $\phi$ ,  $\theta$ ),  $f = 900$  MHz

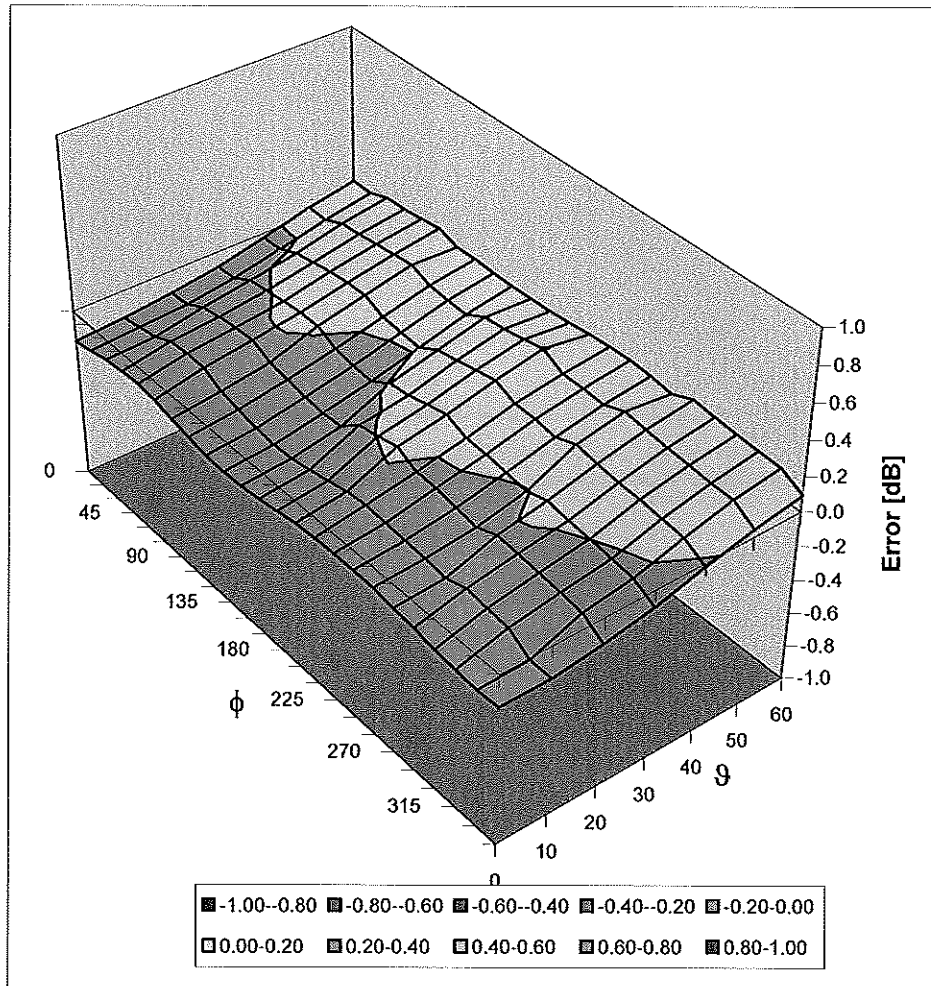

Uncertainty of Spherical Isotropy Assessment:  $\pm 2.6\%$  ( $k=2$ )

## **Additional Conversion Factors**

**for Dosimetric E-Field Probe**

Type:

**ES3DV3**

Serial Number:

**3209**

Place of Assessment:

**Zurich**

Date of Assessment:

**September 17, 2009**

Probe Calibration Date:

**April 15, 2009**

Schmid & Partner Engineering AG hereby certifies that conversion factor(s) of this probe have been evaluated on the date indicated above. The assessment was performed using the FDTD numerical code SEMCAD of Schmid & Partner Engineering AG. The evaluation is coupled with measured conversion factors (probe calibration date indicated above). The uncertainty of the numerical assessment is based on the extrapolation from measured value at 835 MHz or at 1750 MHz.

Assessed by:

## Dosimetric E-Field Probe ES3DV3 SN:3209

Conversion factor ( $\pm$  standard deviation)

**750  $\pm$  50 MHz**

*ConvF*

**6.17  $\pm$  7%**

$\epsilon_r = 55.5 \pm 5\%$ $\sigma = 0.96 \pm 5\%$ mho/m (body tissue)
---

### Important Note:

**For numerically assessed probe conversion factors, parameters Alpha and Delta in the DASY software must have the following entries: Alpha = 0 and Delta = 1.**

**Please see also Section 4.7 of the DASY4 Manual.**



Accredited by the Swiss Accreditation Service (SAS)  
The Swiss Accreditation Service is one of the signatories to the EA  
Multilateral Agreement for the recognition of calibration certificates

Accreditation No.: **SCS 108**

Client **PC Test**

Certificate No: **D835V2-4d047\_Jan09**

## CALIBRATION CERTIFICATE

Object **D835V2 - SN: 4d047**

Calibration procedure(s) **QA CAL-05.v7  
Calibration procedure for dipole validation kits**

Calibration date: **January 19, 2009**

Condition of the calibrated item **In Tolerance**

This calibration certificate documents the traceability to national standards, which realize the physical units of measurements (SI).  
The measurements and the uncertainties with confidence probability are given on the following pages and are part of the certificate.

All calibrations have been conducted in the closed laboratory facility: environment temperature (22 ± 3)°C and humidity < 70%.

Calibration Equipment used (M&TE critical for calibration)

Primary Standards	ID #	Cal Date (Certificate No.)	Scheduled Calibration
Power meter EPM-442A	GB37480704	08-Oct-08 (No. 217-00898)	Oct-09
Power sensor HP 8481A	US37292783	08-Oct-08 (No. 217-00898)	Oct-09
Reference 20 dB Attenuator	SN: 5086 (20g)	01-Jul-08 (No. 217-00864)	Jul-09
Type-N mismatch combination	SN: 5047.2 / 06327	01-Jul-08 (No. 217-00867)	Jul-09
Reference Probe ES3DV2	SN: 3025	28-Apr-08 (No. ES3-3025_Apr08)	Apr-09
DAE4	SN: 601	14-Mar-08 (No. DAE4-601_Mar08)	Mar-09

Secondary Standards	ID #	Check Date (in house)	Scheduled Check
Power sensor HP 8481A	MY41092317	18-Oct-02 (in house check Oct-07)	In house check: Oct-09
RF generator R&S SMT-06	100005	4-Aug-99 (in house check Oct-07)	In house check: Oct-09
Network Analyzer HP 8753E	US37390585 S4206	18-Oct-01 (in house check Oct-08)	In house check: Oct-09

	Name	Function	Signature
Calibrated by:	Jeton Kastrati	Laboratory Technician	
Approved by:	Katja Pokovic	Technical Manager	

Issued: January 20, 2009

This calibration certificate shall not be reproduced except in full without written approval of the laboratory.



Accredited by the Swiss Accreditation Service (SAS)  
The Swiss Accreditation Service is one of the signatories to the EA  
Multilateral Agreement for the recognition of calibration certificates

### Glossary:

TSL	tissue simulating liquid
ConvF	sensitivity in TSL / NORM x,y,z
N/A	not applicable or not measured

### Calibration is Performed According to the Following Standards:

- IEEE Std 1528-2003, "IEEE Recommended Practice for Determining the Peak Spatial-Averaged Specific Absorption Rate (SAR) in the Human Head from Wireless Communications Devices: Measurement Techniques", December 2003
- IEC 62209-1, "Procedure to measure the Specific Absorption Rate (SAR) for hand-held devices used in close proximity to the ear (frequency range of 300 MHz to 3 GHz)", February 2005
- Federal Communications Commission Office of Engineering & Technology (FCC OET), "Evaluating Compliance with FCC Guidelines for Human Exposure to Radiofrequency Electromagnetic Fields; Additional Information for Evaluating Compliance of Mobile and Portable Devices with FCC Limits for Human Exposure to Radiofrequency Emissions", Supplement C (Edition 01-01) to Bulletin 65

### Additional Documentation:

- DASY4/5 System Handbook

### Methods Applied and Interpretation of Parameters:

- Measurement Conditions:* Further details are available from the Validation Report at the end of the certificate. All figures stated in the certificate are valid at the frequency indicated.
- Antenna Parameters with TSL:* The dipole is mounted with the spacer to position its feed point exactly below the center marking of the flat phantom section, with the arms oriented parallel to the body axis.
- Feed Point Impedance and Return Loss:* These parameters are measured with the dipole positioned under the liquid filled phantom. The impedance stated is transformed from the measurement at the SMA connector to the feed point. The Return Loss ensures low reflected power. No uncertainty required.
- Electrical Delay:* One-way delay between the SMA connector and the antenna feed point. No uncertainty required.
- SAR measured:* SAR measured at the stated antenna input power.
- SAR normalized:* SAR as measured, normalized to an input power of 1 W at the antenna connector.
- SAR for nominal TSL parameters:* The measured TSL parameters are used to calculate the nominal SAR result.

## Measurement Conditions

DASY system configuration, as far as not given on page 1.

<b>DASY Version</b>	DASY5	V5.0
<b>Extrapolation</b>	Advanced Extrapolation	
<b>Phantom</b>	Modular Flat Phantom V4.9	
<b>Distance Dipole Center - TSL</b>	15 mm	with Spacer
<b>Zoom Scan Resolution</b>	dx, dy, dz = 5 mm	
<b>Frequency</b>	835 MHz ± 1 MHz	

## Head TSL parameters

The following parameters and calculations were applied.

	Temperature	Permittivity	Conductivity
<b>Nominal Head TSL parameters</b>	22.0 °C	41.5	0.90 mho/m
<b>Measured Head TSL parameters</b>	(22.0 ± 0.2) °C	41.3 ± 6 %	0.91 mho/m ± 6 %
<b>Head TSL temperature during test</b>	(21.5 ± 0.2) °C	---	---

## SAR result with Head TSL

<b>SAR averaged over 1 cm<sup>3</sup> (1 g) of Head TSL</b>	Condition	
SAR measured	250 mW input power	2.45 mW / g
SAR normalized	normalized to 1W	9.80 mW / g
<b>SAR for nominal Head TSL parameters <sup>1</sup></b>	normalized to 1W	<b>9.70 mW / g ± 17.0 % (k=2)</b>

<b>SAR averaged over 10 cm<sup>3</sup> (10 g) of Head TSL</b>	condition	
SAR measured	250 mW input power	1.61 mW / g
SAR normalized	normalized to 1W	6.44 mW / g
<b>SAR for nominal Head TSL parameters <sup>1</sup></b>	normalized to 1W	<b>6.39 mW / g ± 16.5 % (k=2)</b>

<sup>1</sup> Correction to nominal TSL parameters according to d), chapter "SAR Sensitivities"

## Appendix

### Antenna Parameters with Head TSL

Impedance, transformed to feed point	50.9 $\Omega$ -3.7 j $\Omega$
Return Loss	- 28.4 dB

### Antenna Parameters with Body TSL

Impedance, transformed to feed point	46.8 $\Omega$ -5.5 j $\Omega$
Return Loss	- 23.7 dB

### General Antenna Parameters and Design

Electrical Delay (one direction)	1.386 ns
----------------------------------	----------

After long term use with 100W radiated power, only a slight warming of the dipole near the feedpoint can be measured.

The dipole is made of standard semirigid coaxial cable. The center conductor of the feeding line is directly connected to the second arm of the dipole. The antenna is therefore short-circuited for DC-signals.

No excessive force must be applied to the dipole arms, because they might bend or the soldered connections near the feedpoint may be damaged.

### Additional EUT Data

Manufactured by	SPEAG
Manufactured on	August 16, 2006

## Body TSL parameters

The following parameters and calculations were applied.

	Temperature	Permittivity	Conductivity
Nominal Body TSL parameters	22.0 °C	55.2	0.97 mho/m
Measured Body TSL parameters	(22.0 ± 0.2) °C	53.5 ± 6 %	1.00 mho/m ± 6 %
Body TSL temperature during test	(21.5 ± 0.2) °C	----	----

## SAR result with Body TSL

SAR averaged over 1 cm <sup>3</sup> (1 g) of Body TSL	Condition	
SAR measured	250 mW input power	2.53 mW / g
SAR normalized	normalized to 1W	10.1 mW / g
SAR for nominal Body TSL parameters <sup>2</sup>	normalized to 1W	<b>9.82 mW / g ± 17.0 % (k=2)</b>

SAR averaged over 10 cm <sup>3</sup> (10 g) of Body TSL	condition	
SAR measured	250 mW input power	1.67 mW / g
SAR normalized	normalized to 1W	6.68 mW / g
SAR for nominal Body TSL parameters <sup>2</sup>	normalized to 1W	<b>6.54 mW / g ± 16.5 % (k=2)</b>

<sup>2</sup> Correction to nominal TSL parameters according to d), chapter "SAR Sensitivities"

## DASY5 Validation Report for Head TSL

Date/Time: 19.01.2009 11:45:19

Test Laboratory: SPEAG, Zurich, Switzerland

**DUT: Dipole 835 MHz; Type: D835V2; Serial: D835V2 - SN:4d047**

Communication System: CW-835; Frequency: 835 MHz; Duty Cycle: 1:1

Medium: HSL 900 MHz

Medium parameters used:  $f = 835$  MHz;  $\sigma = 0.91$  mho/m;  $\epsilon_r = 41.1$ ;  $\rho = 1000$  kg/m<sup>3</sup>

Phantom section: Flat Section

Measurement Standard: DASY5 (IEEE/IEC)

DASY5 Configuration:

- Probe: ES3DV2 - SN3025; ConvF(5.97, 5.97, 5.97); Calibrated: 28.04.2008
- Sensor-Surface: 3.4mm (Mechanical Surface Detection)
- Electronics: DAE4 Sn601; Calibrated: 14.03.2008
- Phantom: Flat Phantom 4.9L; Type: QD000P49AA; Serial: 1001
- Measurement SW: DASY5, V5.0 Build 120; SEMCAD X Version 13.4 Build 45

**Pin=250mW; dip=15mm; dist=3.4mm/Zoom Scan (7x7x7)/Cube 0: Measurement grid: dx=5mm, dy=5mm, dz=5mm**

Reference Value = 56.4 V/m; Power Drift = -0.00691 dB

Peak SAR (extrapolated) = 3.61 W/kg

**SAR(1 g) = 2.45 mW/g; SAR(10 g) = 1.61 mW/g**

Maximum value of SAR (measured) = 2.77 mW/g

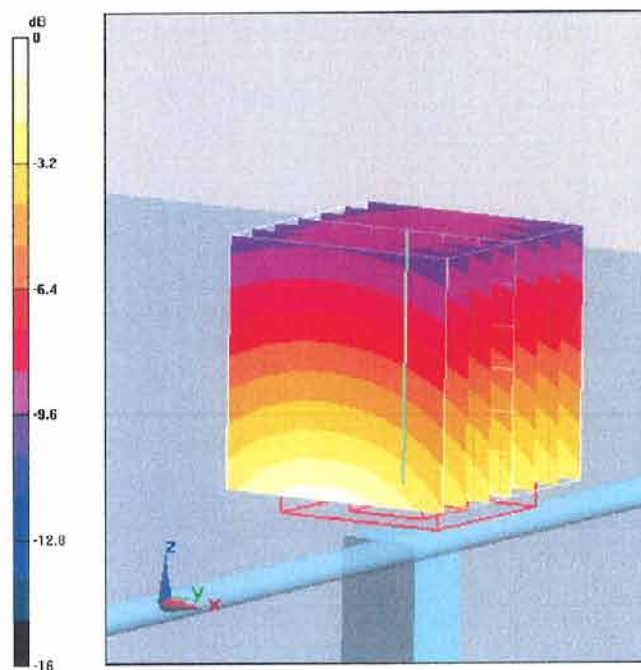

0 dB = 2.77mW/g

# Impedance Measurement Plot for Head TSL

19 Jan 2009 10:48:17

CH1 S11 1 U FS 1: 50.052  $\Omega$  -3.7266  $\Omega$  51.148 pF 835.000 000 MHz

\*  
De1  
Cor  
Avg  
15  
↑

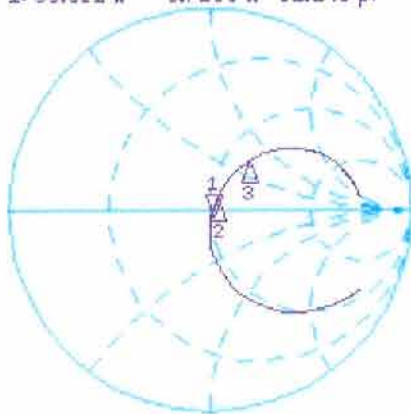

CH1 Markers  
2: 53.711  $\Omega$   
4.9805  $\Omega$   
850.000 MHz  
3: 63.910  $\Omega$   
32.480  $\Omega$   
900.000 MHz

CH2 S11 LOG 5 dB/REF -20 dB 1: -28.447 dB 835.000 000 MHz

Cor  
Avg  
15  
↑

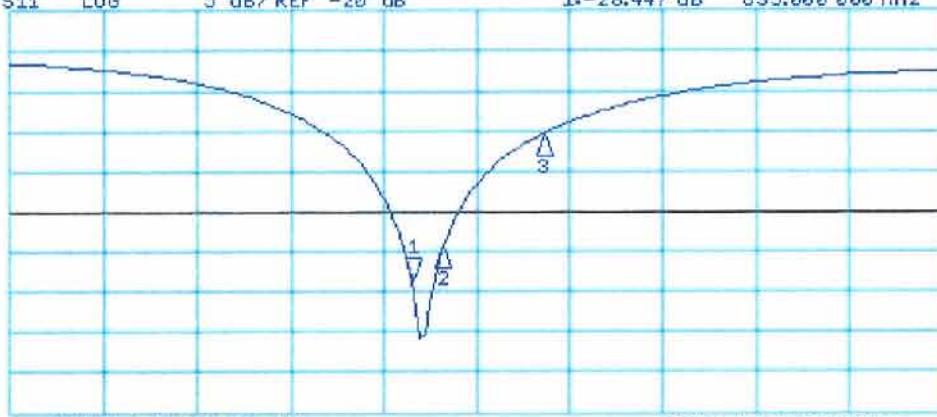

CH2 Markers  
2: -24.508 dB  
850.000 MHz  
3: -10.504 dB  
900.000 MHz

START 635.000 000 MHz STOP 1 100.000 000 MHz

## DASY5 Validation Report for Body TSL

Date/Time: 12.01.2009 12:18:12

Test Laboratory: SPEAG, Zurich, Switzerland

**DUT: Dipole 835 MHz; Type: D835V2; Serial: D835V2 - SN:4d047**

Communication System: CW; Frequency: 835 MHz; Duty Cycle: 1:1

Medium: MSL900

Medium parameters used:  $f = 835$  MHz;  $\sigma = 1$  mho/m;  $\epsilon_r = 53.5$ ;  $\rho = 1000$  kg/m<sup>3</sup>

Phantom section: Flat Section

Measurement Standard: DASY5 (IEEE/IEC)

DASY5 Configuration:

- Probe: ES3DV2 - SN3025; ConvF(5.9, 5.9, 5.9); Calibrated: 28.04.2008
- Sensor-Surface: 3.4mm (Mechanical Surface Detection)
- Electronics: DAE4 Sn601; Calibrated: 14.03.2008
- Phantom: Flat Phantom 4.9L; Type: QD000P49AA; Serial: 1001
- Measurement SW: DASY5, V5.0 Build 120; SEMCAD X Version 13.4 Build 45

**Pin = 250mW, d = 15mm/Zoom Scan (7x7x7)/Cube 0: Measurement grid: dx=5mm, dy=5mm, dz=5mm**

Reference Value = 54.5 V/m; Power Drift = 0.010 dB

Peak SAR (extrapolated) = 3.65 W/kg

**SAR(1 g) = 2.53 mW/g; SAR(10 g) = 1.67 mW/g**

Maximum value of SAR (measured) = 2.82 mW/g

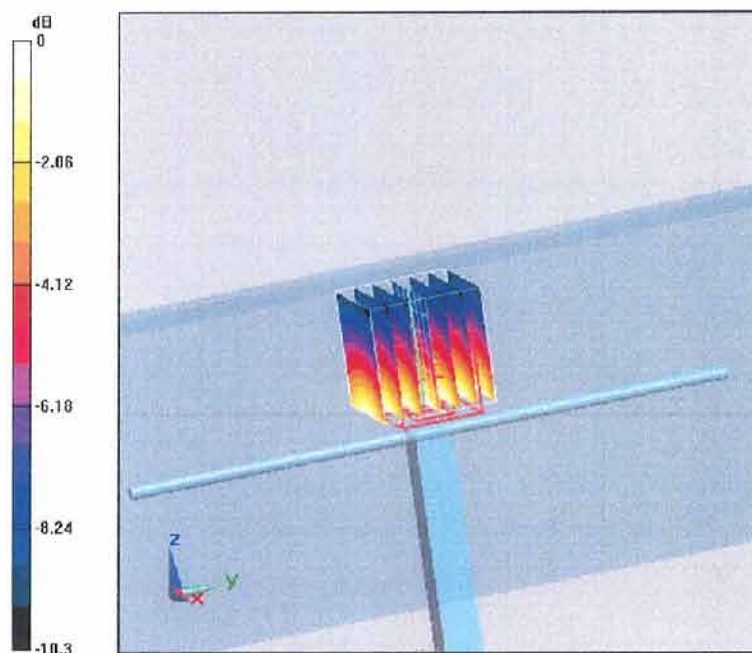

0 dB = 2.82mW/g

# Impedance Measurement Plot for Body TSL

12 Jan 2009 11:52:45

CH1 S11 1 U FS

1: 46.760  $\Omega$  -5.4531  $\Omega$  34.953 pF

835.000 000 MHz

\*  
Del  
Cor  
Avg  
16  
↑

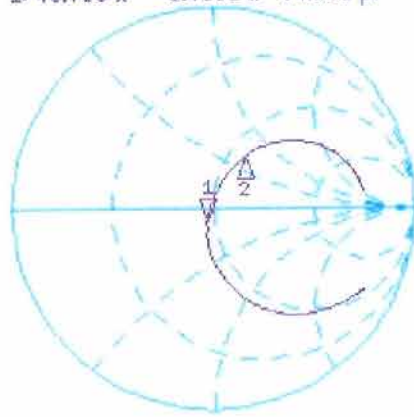

CH1 Markers  
2: 58.283  $\Omega$   
31.037  $\Omega$   
900.000 MHz

CH2

S11 LOG

5 dB/REF -20 dB

1: -23.684 dB

835.000 000 MHz

Cor  
Avg  
16  
↑

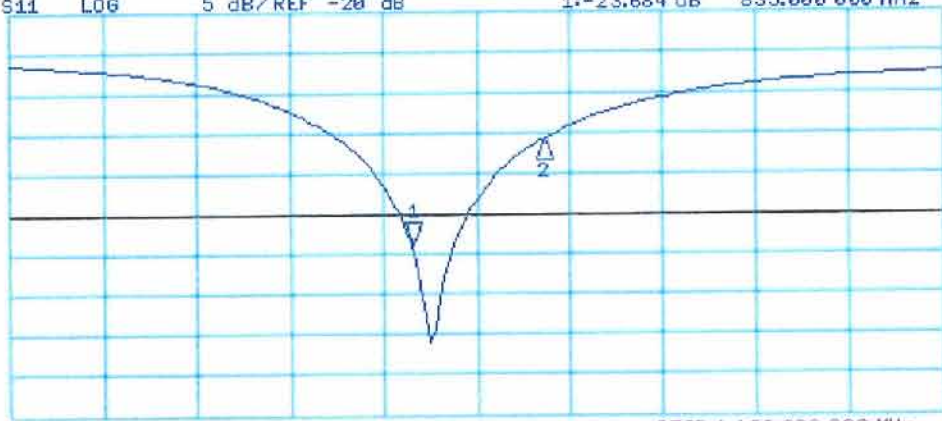

CH2 Markers  
2: -10.898 dB  
900.000 MHz

START 635.000 000 MHz

STOP 1 100.000 000 MHz



Accredited by the Swiss Accreditation Service (SAS)  
The Swiss Accreditation Service is one of the signatories to the EA  
Multilateral Agreement for the recognition of calibration certificates

Accreditation No.: **SCS 108**

Client **PC Test**

Certificate No: **D1765V2-1008\_May09**

**CALIBRATION CERTIFICATE**

Object **D1765V2 - SN: 1008**

Calibration procedure(s) **QA CAL-05.v7  
Calibration procedure for dipole validation kits**

*OK  
82  
5/26/09*

Calibration date: **May 19, 2009**

Condition of the calibrated item **In Tolerance**

This calibration certificate documents the traceability to national standards, which realize the physical units of measurements (SI).  
The measurements and the uncertainties with confidence probability are given on the following pages and are part of the certificate.

All calibrations have been conducted in the closed laboratory facility: environment temperature (22 ± 3)°C and humidity < 70%.

Calibration Equipment used (M&TE critical for calibration)

Primary Standards	ID #	Cal Date (Calibrated by, Certificate No.)	Scheduled Calibration
Power meter EPM-442A	GB37480704	08-Oct-08 (No. 217-00898)	Oct-09
Power sensor HP 8481A	US37292783	08-Oct-08 (No. 217-00898)	Oct-09
Reference 20 dB Attenuator	SN: 5086 (20g)	31-Mar-09 (No. 217-01025)	Mar-10
Type-N mismatch combination	SN: 5047.2 / 06327	31-Mar-09 (No. 217-01029)	Mar-10
Reference Probe ES3DV2	SN: 3025	30-Apr-09 (No. ES3-3025_Apr09)	Apr-10
DAE4	SN: 601	07-Mar-09 (No. DAE4-601_Mar09)	Mar-10
Secondary Standards	ID #	Check Date (in house)	Scheduled Check
Power sensor HP 8481A	MY41092317	18-Oct-02 (in house check Oct-07)	In house check: Oct-09
RF generator R&S SMT-06	100005	4-Aug-99 (in house check Oct-07)	In house check: Oct-09
Network Analyzer HP 8753E	US37390585 S4206	18-Oct-01 (in house check Oct-08)	In house check: Oct-09

Calibrated by: **Name: Mike Meili, Function: Laboratory Technician, Signature: [Signature]**

Approved by: **Name: Kalja Pokovic, Function: Technical Manager, Signature: [Signature]**

Issued: May 20, 2009

This calibration certificate shall not be reproduced except in full without written approval of the laboratory.



Accredited by the Swiss Accreditation Service (SAS)  
The Swiss Accreditation Service is one of the signatories to the EA  
Multilateral Agreement for the recognition of calibration certificates

Accreditation No.: **SCS 108**

**Glossary:**

TSL	tissue simulating liquid
ConvF	sensitivity in TSL / NORM x,y,z
N/A	not applicable or not measured

**Calibration is Performed According to the Following Standards:**

- a) IEEE Std 1528-2003, "IEEE Recommended Practice for Determining the Peak Spatial-Averaged Specific Absorption Rate (SAR) in the Human Head from Wireless Communications Devices: Measurement Techniques", December 2003
- b) IEC 62209-1, "Procedure to measure the Specific Absorption Rate (SAR) for hand-held devices used in close proximity to the ear (frequency range of 300 MHz to 3 GHz)", February 2005
- c) Federal Communications Commission Office of Engineering & Technology (FCC OET), "Evaluating Compliance with FCC Guidelines for Human Exposure to Radiofrequency Electromagnetic Fields; Additional Information for Evaluating Compliance of Mobile and Portable Devices with FCC Limits for Human Exposure to Radiofrequency Emissions", Supplement C (Edition 01-01) to Bulletin 65

**Additional Documentation:**

- d) DASY4/5 System Handbook

**Methods Applied and Interpretation of Parameters:**

- *Measurement Conditions:* Further details are available from the Validation Report at the end of the certificate. All figures stated in the certificate are valid at the frequency indicated.
- *Antenna Parameters with TSL:* The dipole is mounted with the spacer to position its feed point exactly below the center marking of the flat phantom section, with the arms oriented parallel to the body axis.
- *Feed Point Impedance and Return Loss:* These parameters are measured with the dipole positioned under the liquid filled phantom. The impedance stated is transformed from the measurement at the SMA connector to the feed point. The Return Loss ensures low reflected power. No uncertainty required.
- *Electrical Delay:* One-way delay between the SMA connector and the antenna feed point. No uncertainty required.
- *SAR measured:* SAR measured at the stated antenna input power.
- *SAR normalized:* SAR as measured, normalized to an input power of 1 W at the antenna connector.
- *SAR for nominal TSL parameters:* The measured TSL parameters are used to calculate the nominal SAR result.

## Measurement Conditions

DASY system configuration, as far as not given on page 1.

DASY Version	DASY5	V5.0
Extrapolation	Advanced Extrapolation	
Phantom	Modular Flat Phantom V5.0	
Distance Dipole Center - TSL	10 mm	with Spacer
Zoom Scan Resolution	dx, dy, dz = 5 mm	
Frequency	1765 MHz $\pm$ 1 MHz	

## Head TSL parameters

The following parameters and calculations were applied.

	Temperature	Permittivity	Conductivity
Nominal Head TSL parameters	22.0 °C	40.1	1.38 mho/m
Measured Head TSL parameters	(22.0 $\pm$ 0.2) °C	41.4 $\pm$ 6 %	1.36 mho/m $\pm$ 6 %
Head TSL temperature during test	(21.4 $\pm$ 0.2) °C	----	----

## SAR result with Head TSL

SAR averaged over 1 cm <sup>3</sup> (1 g) of Head TSL	condition	
SAR measured	250 mW input power	9.38 mW /g
SAR normalized	normalized to 1W	37.5 mW /g
SAR for nominal Head TSL parameters <sup>1</sup>	normalized to 1W	<b>38.2 mW/g <math>\pm</math> 17.0 % (k=2)</b>

SAR averaged over 10 cm <sup>3</sup> (10 g) of Head TSL	condition	
SAR measured	250 mW input power	5.02 mW /g
SAR normalized	normalized to 1W	20.1 mW /g
SAR for nominal Head TSL parameters <sup>1</sup>	normalized to 1W	<b>20.3 W/g <math>\pm</math> 16.5 % (k=2)</b>

<sup>1</sup> Correction to nominal TSL parameters according to d), chapter "SAR Sensitivities"

## Body TSL parameters

The following parameters and calculations were applied.

	Temperature	Permittivity	Conductivity
Nominal Body TSL parameters	22.0 °C	53.4	1.50 mho/m
Measured Body TSL parameters	(22.0 ± 0.2) °C	53.8 ± 6 %	1.47 mho/m ± 6 %
Body TSL temperature during test	(21.0 ± 0.2) °C	----	----

## SAR result with Body TSL

SAR averaged over 1 cm <sup>3</sup> (1 g) of Body TSL	condition	
SAR measured	250 mW input power	9.19 mW /g
SAR normalized	normalized to 1W	36.6 mW /g
SAR for nominal Body TSL parameters <sup>2</sup>	normalized to 1W	<b>37.3 mW / g ± 17.0 % (k=2)</b>

SAR averaged over 10 cm <sup>3</sup> (10 g) of Body TSL	condition	
SAR measured	250 mW input power	4.97 mW /g
SAR normalized	normalized to 1W	19.9 mW /g
SAR for nominal Body TSL parameters <sup>2</sup>	normalized to 1W	<b>20.0 mW / g ± 16.5 % (k=2)</b>

<sup>2</sup> Correction to nominal TSL parameters according to d), chapter "SAR Sensitivities"

## Appendix

### Antenna Parameters with Head TSL

Impedance, transformed to feed point	48.4 $\Omega$ - 2.7 j $\Omega$
Return Loss	- 29.9 dB

### Antenna Parameters with Body TSL

Impedance, transformed to feed point	44.8 $\Omega$ - 2.6 j $\Omega$
Return Loss	- 24.2 dB

### General Antenna Parameters and Design

Electrical Delay (one direction)	1.210 ns
----------------------------------	----------

After long term use with 100W radiated power, only a slight warming of the dipole near the feedpoint can be measured.

The dipole is made of standard semirigid coaxial cable. The center conductor of the feeding line is directly connected to the second arm of the dipole. The antenna is therefore short-circuited for DC-signals.

No excessive force must be applied to the dipole arms, because they might bend or the soldered connections near the feedpoint may be damaged.

### Additional EUT Data

Manufactured by	SPEAG
Manufactured on	October 6, 2005

## DASY5 Validation Report for Head TSL

Date/Time: 19.05.2009 13:14:46

Test Laboratory: SPEAG, Zurich, Switzerland

**DUT: Dipole 1765 MHz; Type: D1765V2; Serial: D1765V2 - SN1008**

Communication System: CW-1750; Frequency: 1765 MHz; Duty Cycle: 1:1

Medium: HSL U11 BB

Medium parameters used:  $f = 1765$  MHz;  $\sigma = 1.36$  mho/m;  $\epsilon_r = 41.5$ ;  $\rho = 1000$  kg/m<sup>3</sup>

Phantom section: Flat Section

Measurement Standard: DASY5 (IEEE/IEC)

DASY5 Configuration:

- Probe: ES3DV2 - SN3025; ConvF(5.04, 5.04, 5.04); Calibrated: 30.04.2009
- Sensor-Surface: 3mm (Mechanical Surface Detection)
- Electronics: DAE4 Sn601; Calibrated: 07.03.2009
- Phantom: Flat Phantom 5.0 (front); Type: QD000P50AA; Serial: 1001
- Measurement SW: DASY5, V5.0 Build 120; SEMCAD X Version 13.4 Build 45

**Pin = 250 mW; d = 10 mm, f = 1765 MHz/Zoom Scan (7x7x7)/Cube 0:**

Measurement grid: dx=5mm, dy=5mm, dz=5mm

Reference Value = 95.1 V/m; Power Drift = 0.048 dB

Peak SAR (extrapolated) = 16.7 W/kg

**SAR(1 g) = 9.38 mW/g; SAR(10 g) = 5.02 mW/g**

Maximum value of SAR (measured) = 11.5 mW/g

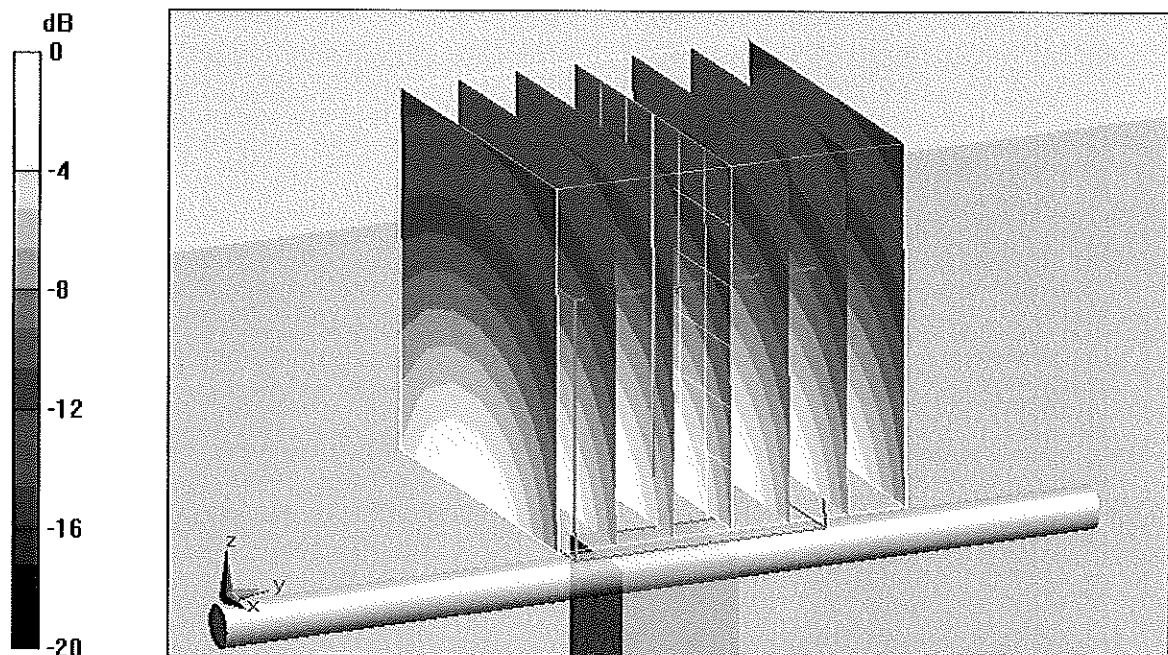

0 dB = 11.5mW/g

# Impedance Measurement Plot for Head TSL

19 May 2009 10:36:08

[CH1] S11 1 U FS 1: 48.412  $\Omega$  -2.7422  $\Omega$  32.884  $\mu$ F 1 765.000 000 MHz

\*  
Del  
CA

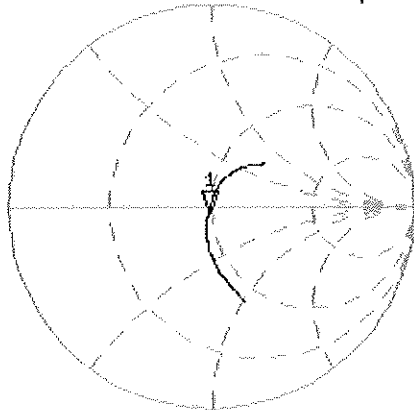

Avg  
16

↑

CH2 S11 L06 5 dB/REF -20 dB 1:-29.856 dB 1 765.000 000 MHz

CA

Avg  
16

↑

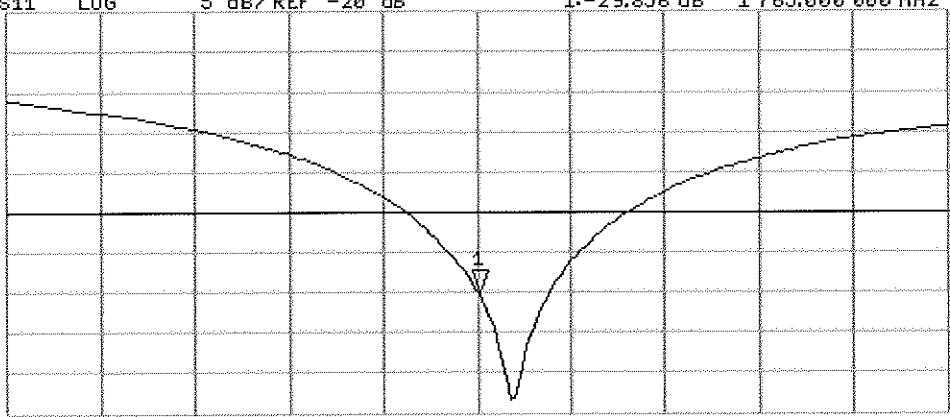

CENTER 1 765.000 000 MHz

SPAN 400.000 000 MHz

## DASY5 Validation Report for Body TSL

Date/Time: 19.05.2009 15:46:05

Test Laboratory: SPEAG, Zurich, Switzerland

**DUT: Dipole 1765 MHz; Type: D1765V2; Serial: D1765V2 - SN1008**

Communication System: CW-1750; Frequency: 1765 MHz; Duty Cycle: 1:1

Medium: MSL U10 BB

Medium parameters used:  $f = 1765$  MHz;  $\sigma = 1.47$  mho/m;  $\epsilon_r = 54$ ;  $\rho = 1000$  kg/m<sup>3</sup>

Phantom section: Flat Section

Measurement Standard: DASY5 (IEEE/IEC)

### DASY5 Configuration:

- Probe: ES3DV2 - SN3025; ConvF(4.71, 4.71, 4.71); Calibrated: 30.04.2009
- Sensor-Surface: 3mm (Mechanical Surface Detection)
- Electronics: DAE4 Sn601; Calibrated: 07.03.2009
- Phantom: Flat Phantom 5.0 (back); Type: QD000P50AA; Serial: 1002
- Measurement SW: DASY5, V5.0 Build 120; SEMCAD X Version I3.4 Build 45

**Pin = 250 mW; d = 10 mm, f = 1765 MHz/Zoom Scan (7x7x7)/Cube 0:**

Measurement grid: dx=5mm, dy=5mm, dz=5mm

Reference Value = 92.4 V/m; Power Drift = 0.00676 dB

Peak SAR (extrapolated) = 15.7 W/kg

**SAR(1 g) = 9.19 mW/g; SAR(10 g) = 4.97 mW/g**

Maximum value of SAR (measured) = 11.5 mW/g

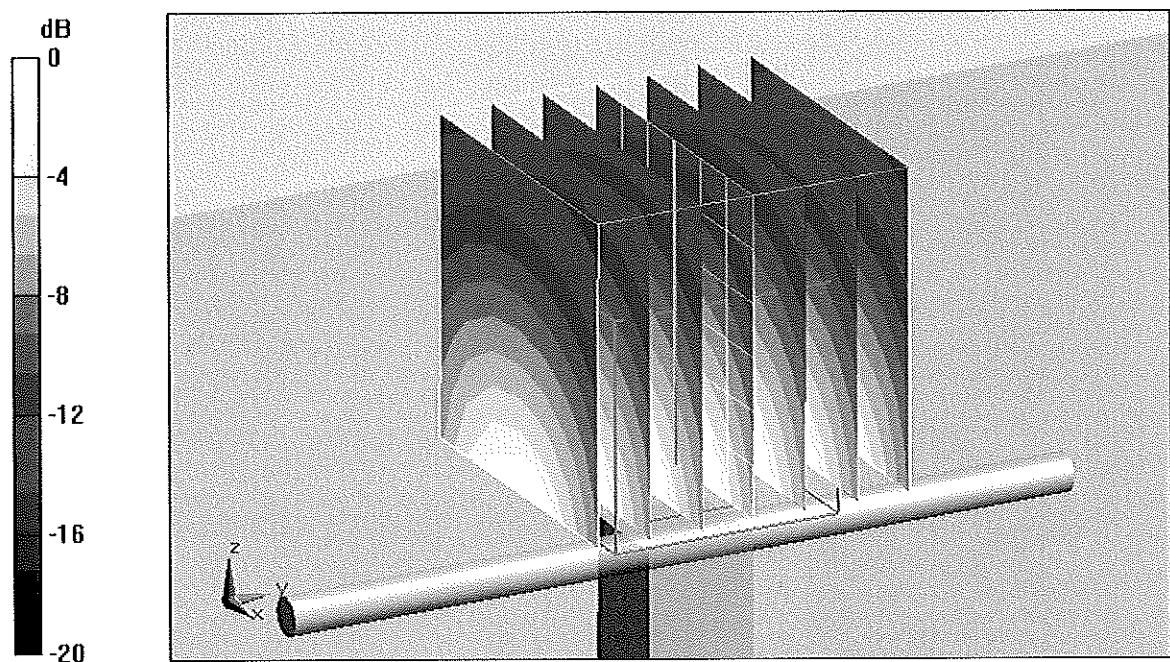

0 dB = 11.5mW/g

# Impedance Measurement Plot for Body TSL

19 May 2009 10:36:41

CH1 S11 1 U FS 1: 44.799  $\Omega$  -2.6426  $\Omega$  34.123 pF 1 765.000 000 MHz

\*  
De1  
CΔ  
Avg  
16  
↑

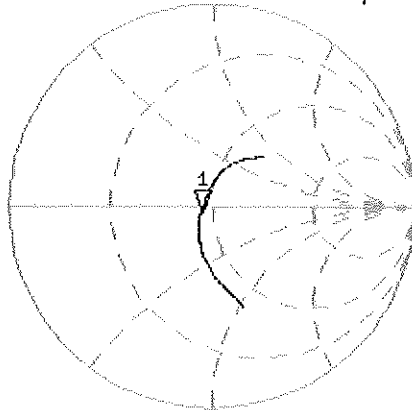

CH2 S11 LOG 5 dB/REF -20 dB 1:-24.219 dB 1 765.000 000 MHz

CΔ  
Avg  
16  
↑

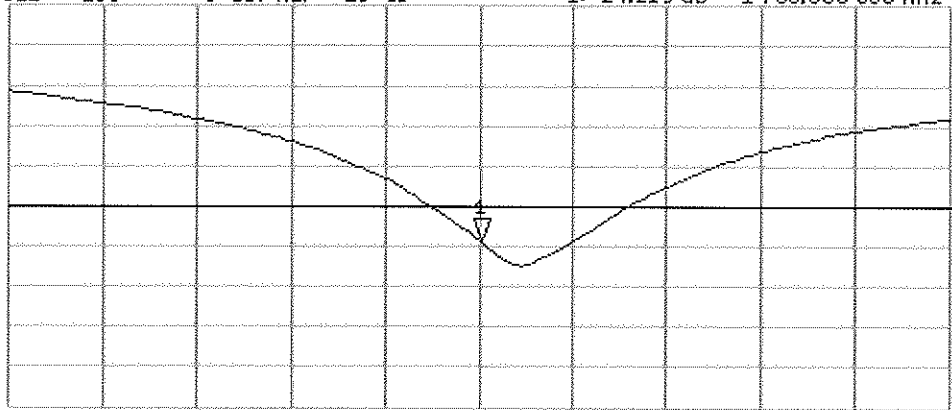

CENTER 1 765.000 000 MHz

SPAN 400.000 000 MHz



Accredited by the Swiss Accreditation Service (SAS)  
The Swiss Accreditation Service is one of the signatories to the EA  
Multilateral Agreement for the recognition of calibration certificates

Accreditation No.: **SCS 108**

Client **PC Test**

Certificate No: **D1900V2-502-Jan09**

## CALIBRATION CERTIFICATE

Object **D1900V2 - SN: 502**

Calibration procedure(s) **QA CAL-05.v7  
Calibration procedure for dipole validation kits**

Calibration date: **January 20, 2009**

Condition of the calibrated item **In Tolerance**

This calibration certificate documents the traceability to national standards, which realize the physical units of measurements (SI).  
The measurements and the uncertainties with confidence probability are given on the following pages and are part of the certificate.

All calibrations have been conducted in the closed laboratory facility: environment temperature (22 ± 3)°C and humidity < 70%.

Calibration Equipment used (M&TE critical for calibration)

Primary Standards	ID #	Cal Date (Calibrated by, Certificate No.)	Scheduled Calibration
Power meter EPM-442A	GB37480704	08-Oct-08 (No. 217-00898)	Oct-09
Power sensor HP 8481A	US37292783	08-Oct-08 (No. 217-00898)	Oct-09
Reference 20 dB Attenuator	SN: 5086 (20g)	01-Jul-08 (No. 217-00864)	Jul-09
Type-N mismatch combination	SN: 5047.2 / 06327	01-Jul-08 (No. 217-00867)	Jul-09
Reference Probe ES3DV2	SN: 3025	28-Apr-08 (No. ES3-3025_Apr08)	Apr-09
DAE4	SN: 601	14-Mar-08 (No. DAE4-601_Mar08)	Mar-09

Secondary Standards	ID #	Check Date (in house)	Scheduled Check
Power sensor HP 8481A	MY41092317	18-Oct-02 (in house check Oct-07)	In house check: Oct-09
RF generator R&S SMT-06	100005	4-Aug-99 (in house check Oct-07)	In house check: Oct-09
Network Analyzer HP 8753E	US37390585 S4206	18-Oct-01 (in house check Oct-08)	In house check: Oct-09

Calibrated by: **Claudio Leubler**      **Laboratory Technician**

Approved by: **Katja Pokovic**      **Technical Manager**

Issued: January 21, 2009

This calibration certificate shall not be reproduced except in full without written approval of the laboratory.



Accredited by the Swiss Accreditation Service (SAS)  
The Swiss Accreditation Service is one of the signatories to the EA  
Multilateral Agreement for the recognition of calibration certificates

Accreditation No.: **SCS 108**

**Glossary:**

TSL	tissue simulating liquid
ConvF	sensitivity in TSL / NORM x,y,z
N/A	not applicable or not measured

**Calibration is Performed According to the Following Standards:**

- a) IEEE Std 1528-2003, "IEEE Recommended Practice for Determining the Peak Spatial-Averaged Specific Absorption Rate (SAR) in the Human Head from Wireless Communications Devices: Measurement Techniques", December 2003
- b) CENELEC EN 50361, "Basic standard for the measurement of Specific Absorption Rate related to human exposure to electromagnetic fields from mobile phones (300 MHz - 3 GHz), July 2001
- c) Federal Communications Commission Office of Engineering & Technology (FCC OET), "Evaluating Compliance with FCC Guidelines for Human Exposure to Radiofrequency Electromagnetic Fields; Additional Information for Evaluating Compliance of Mobile and Portable Devices with FCC Limits for Human Exposure to Radiofrequency Emissions", Supplement C (Edition 01-01) to Bulletin 65

**Additional Documentation:**

- d) DASY4/5 System Handbook

**Methods Applied and Interpretation of Parameters:**

- *Measurement Conditions:* Further details are available from the Validation Report at the end of the certificate. All figures stated in the certificate are valid at the frequency indicated.
- *Antenna Parameters with TSL:* The dipole is mounted with the spacer to position its feed point exactly below the center marking of the flat phantom section, with the arms oriented parallel to the body axis.
- *Feed Point Impedance and Return Loss:* These parameters are measured with the dipole positioned under the liquid filled phantom. The impedance stated is transformed from the measurement at the SMA connector to the feed point. The Return Loss ensures low reflected power. No uncertainty required.
- *Electrical Delay:* One-way delay between the SMA connector and the antenna feed point. No uncertainty required.
- *SAR measured:* SAR measured at the stated antenna input power.
- *SAR normalized:* SAR as measured, normalized to an input power of 1 W at the antenna connector.
- *SAR for nominal TSL parameters:* The measured TSL parameters are used to calculate the nominal SAR result.

## Measurement Conditions

DASY system configuration, as far as not given on page 1.

<b>DASY Version</b>	DASY5	V5.0
<b>Extrapolation</b>	Advanced Extrapolation	
<b>Phantom</b>	Modular Flat Phantom V5.0	
<b>Distance Dipole Center - TSL</b>	10 mm	with Spacer
<b>Zoom Scan Resolution</b>	dx, dy, dz = 5 mm	
<b>Frequency</b>	1900 MHz $\pm$ 1 MHz	

## Head TSL parameters

The following parameters and calculations were applied.

	Temperature	Permittivity	Conductivity
<b>Nominal Head TSL parameters</b>	22.0 °C	40.0	1.40 mho/m
<b>Measured Head TSL parameters</b>	(22.0 $\pm$ 0.2) °C	39.2 $\pm$ 6 %	1.47 mho/m $\pm$ 6 %
<b>Head TSL temperature during test</b>	(21.0 $\pm$ 0.2) °C	---	----

## SAR result with Head TSL

<b>SAR averaged over 1 cm<sup>3</sup> (1 g) of Head TSL</b>	condition	
SAR measured	250 mW input power	10.3 mW / g
SAR normalized	normalized to 1W	41.2 mW / g
SAR for nominal Head TSL parameters <sup>1</sup>	normalized to 1W	<b>39.9 mW / g <math>\pm</math> 17.0 % (k=2)</b>

<b>SAR averaged over 10 cm<sup>3</sup> (10 g) of Head TSL</b>	Condition	
SAR measured	250 mW input power	5.32 mW / g
SAR normalized	normalized to 1W	21.3 mW / g
SAR for nominal Head TSL parameters <sup>1</sup>	normalized to 1W	<b>20.9 mW / g <math>\pm</math> 16.5 % (k=2)</b>

<sup>1</sup> Correction to nominal TSL parameters according to d), chapter "SAR Sensitivities"

## Body TSL parameters

The following parameters and calculations were applied.

	Temperature	Permittivity	Conductivity
Nominal Body TSL parameters	22.0 °C	53.3	1.52 mho/m
Measured Body TSL parameters	(22.0 ± 0.2) °C	54.7 ± 6 %	1.57 mho/m ± 6 %
Body TSL temperature during test	(21.0 ± 0.2) °C	---	---

## SAR result with Body TSL

SAR averaged over 1 cm <sup>3</sup> (1 g) of Body TSL	Condition	
SAR measured	250 mW input power	10.5 mW / g
SAR normalized	normalized to 1W	42.0 mW / g
SAR for nominal Body TSL parameters <sup>2</sup>	normalized to 1W	41.5 mW / g ± 17.0 % (k=2)

SAR averaged over 10 cm <sup>3</sup> (10 g) of Body TSL	condition	
SAR measured	250 mW input power	5.55 mW / g
SAR normalized	normalized to 1W	22.2 mW / g
SAR for nominal Body TSL parameters <sup>2</sup>	normalized to 1W	22.1 mW / g ± 16.5 % (k=2)

<sup>2</sup> Correction to nominal TSL parameters according to d), chapter "SAR Sensitivities"

## Appendix

### Antenna Parameters with Head TSL

Impedance, transformed to feed point	47.1 $\Omega$ - 3.3 $j\Omega$
Return Loss	- 26.8 dB

### Antenna Parameters with Body TSL

Impedance, transformed to feed point	43.3 $\Omega$ - 3.4 $j\Omega$
Return Loss	- 21.9 dB

### General Antenna Parameters and Design

Electrical Delay (one direction)	1.183 ns
----------------------------------	----------

After long term use with 100W radiated power, only a slight warming of the dipole near the feedpoint can be measured.

The dipole is made of standard semirigid coaxial cable. The center conductor of the feeding line is directly connected to the second arm of the dipole. The antenna is therefore short-circuited for DC-signals.

No excessive force must be applied to the dipole arms, because they might bend or the soldered connections near the feedpoint may be damaged.

### Additional EUT Data

Manufactured by	SPEAG
Manufactured on	November 14, 1998

## DASY5 Validation Report for Head TSL

Date/Time: 20.01.2009 12:10:12

Test Laboratory: SPEAG, Zurich, Switzerland

**DUT: Dipole 1900 MHz; Type: D1900V2; Serial: D1900V2 - SN:502**

Communication System: CW; Frequency: 1900 MHz; Duty Cycle: 1:1

Medium: HSL U10 BB

Medium parameters used:  $f = 1900$  MHz;  $\sigma = 1.47$  mho/m;  $\epsilon_r = 39.3$ ;  $\rho = 1000$  kg/m<sup>3</sup>

Phantom section: Flat Section

Measurement Standard: DASY5 (IEEE/IEC)

### DASY5 Configuration:

- Probe: ES3DV2 - SN3025; ConvF(4.9, 4.9, 4.9); Calibrated: 28.04.2008
- Sensor-Surface: 3.4mm (Mechanical Surface Detection)
- Electronics: DAE4 Sn601; Calibrated: 14.03.2008
- Phantom: Flat Phantom 5.0 (front); Type: QD000P50AA; Serial: 1001
- Measurement SW: DASY5, V5.0 Build 120; SEMCAD X Version 13.4 Build 45

**Pin = 250 mW; dip = 10 mm, scan at 3.4mm/Zoom Scan (dist=3.4mm, probe 0deg)**

**(7x7x7)/Cube 0:** Measurement grid: dx=5mm, dy=5mm, dz=5mm

Reference Value = 93.1 V/m; Power Drift = 0.042 dB

Peak SAR (extrapolated) = 19.3 W/kg

**SAR(1 g) = 10.3 mW/g; SAR(10 g) = 5.32 mW/g**

Maximum value of SAR (measured) = 12.2 mW/g

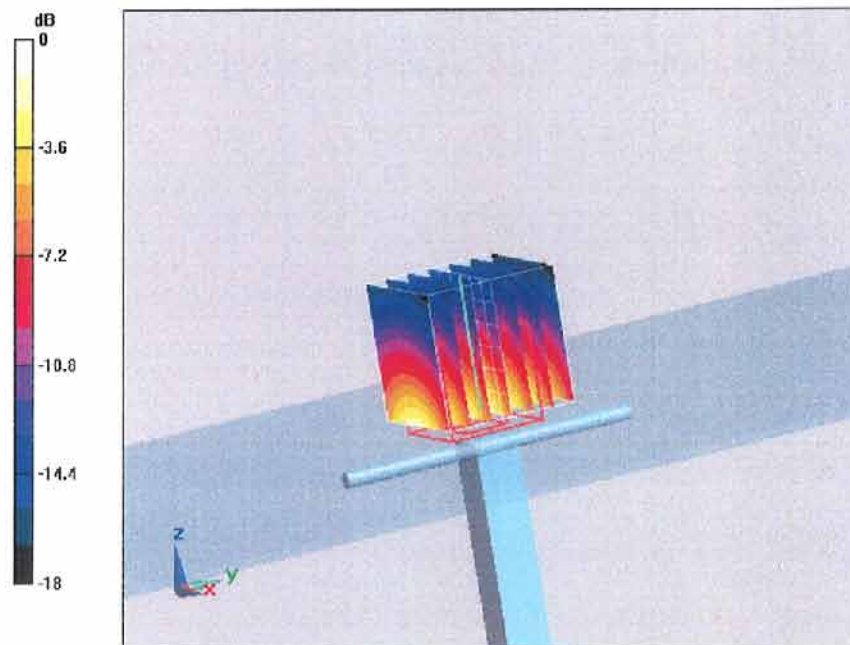

0 dB = 12.2mW/g

# Impedance Measurement Plot for Head TSL

20 Jan 2009 10:59:51

CH1 S11 1 U FS 2: 47.075  $\Omega$  -3.3418  $\Omega$  25.066 pF 1 900.000 000 MHz

\*  
De1  
Cor  
Avg  
16  
↑

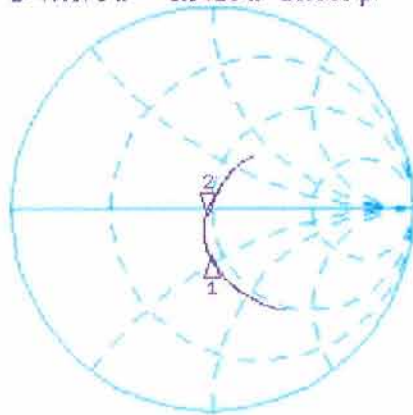

CH1 Markers  
1: 44.506  $\Omega$   
-22.549  $\Omega$   
1.80000 GHz

CH2 S11 LOG 5 dB/REF -20 dB 2: -26.796 dB 1 900.000 000 MHz

Cor  
Avg  
16  
↑



CH2 Markers  
1: -12.437 dB  
1.80000 GHz

START 1 500.000 000 MHz

STOP 2 1000.000 000 MHz

Test Laboratory: SPEAG, Zurich, Switzerland

**DUT: Dipole 1900 MHz; Type: D1900V2; Serial: D1900V2 - SN:502**

Communication System: CW; Frequency: 1900 MHz; Duty Cycle: 1:1

Medium: MSL U10 BB

Medium parameters used:  $f = 1900$  MHz;  $\sigma = 1.57$  mho/m;  $\epsilon_r = 54.9$ ;  $\rho = 1000$  kg/m<sup>3</sup>

Phantom section: Flat Section

Measurement Standard: DASY5 (IEEE/IEC)

**DASY5 Configuration:**

- Probe: ES3DV2 - SN3025; ConvF(4.5, 4.5, 4.5); Calibrated: 28.04.2008
- Sensor-Surface: 3.4mm (Mechanical Surface Detection)
- Electronics: DAE4 Sn601; Calibrated: 14.03.2008
- Phantom: Flat Phantom 5.0 (back); Type: QD000P50AA; Serial: 1002
- Measurement SW: DASY5, V5.0 Build 120; SEMCAD X Version 13.4 Build 45

**Pin = 250 mW; dip = 10 mm, scan at 3.4mm 2 2/Zoom Scan (dist=3.4mm, probe 0deg)  
(7x7x7)/Cube 0:**

Measurement grid: dx=5mm, dy=5mm, dz=5mm

Reference Value = 93 V/m; Power Drift = 0.00443 dB

Peak SAR (extrapolated) = 18.5 W/kg

**SAR(1 g) = 10.5 mW/g; SAR(10 g) = 5.55 mW/g**

Maximum value of SAR (measured) = 12.7 mW/g

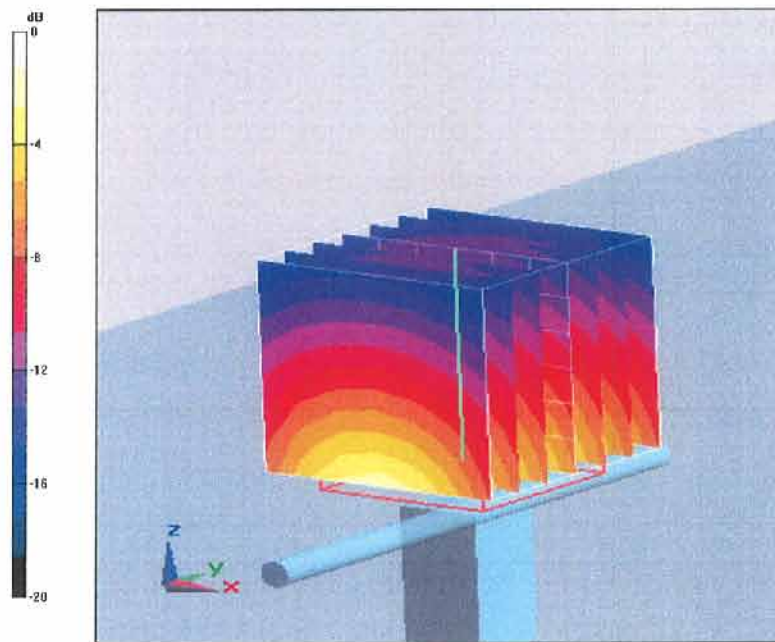

0 dB = 12.7mW/g

# Impedance Measurement Plot for Body TSL

13 Jan 2009 10:01:40

CH1 S11 1 U FS 2: 43.262  $\Omega$  -3.3789  $\Omega$  24.791 pF 1 900.000 000 MHz

\*  
Del  
Cor

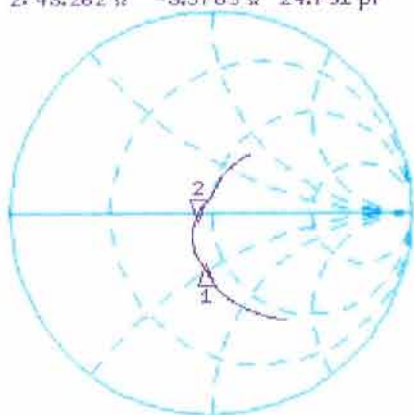

CH1 Markers  
1: 43.135  $\Omega$   
-22.896  $\Omega$   
1.80000 GHz

Avg  
16

↑

CH2 S11 LOG 5 dB/REF -20 dB 2: -21.858 dB 1 900.000 000 MHz

Cor



CH2 Markers  
1: -11.657 dB  
1.80000 GHz

Avg  
16

↑

START 1 600.000 000 MHz

STOP 2 100.000 000 MHz