



ENGLISH

www.lg.com

Copyright © 2023 LG Electronics Inc.
All Rights Reserved.

Display

OWNER'S MANUAL

Safety and Reference

Please read this manual carefully before operating your set and retain it for future reference.

The model and serial number of the product are located on the back and on one side of the product. Record them below in case you ever need service.

Model _____

Serial No. _____



* M F L 7 1 9 4 6 0 5 8 2 3 0 4 R E V 0 0 *

Supplier's Declaration of Conformity

Trade Name	LG
Responsible Party	LG Electronics USA, Inc.
Address	111 Sylvan Avenue, North Building, Englewood Cliffs, NJ 07632
E-mail	lg.environmental@lge.com

LG Customer Information Center

For inquires or comments, visit www.lg.com or call;

1-800-243-0000	USA, Consumer User
1-888-865-3026	USA, Commercial User
1-888-542-2623	CANADA

Register your product Online!

www.lg.com

Important Safety Instruction

- Read these instructions.
- Keep these instructions.
- Heed all warnings.
- Follow all instructions.
- Do not use this apparatus near water.
- Clean only with dry cloth.
- Do not block any ventilation openings. Install in accordance with the manufacturer's instructions.
- Do not install near any heat sources such as radiators, heat registers, stoves, or other apparatus (including amplifiers) that produce heat.
- Do not defeat the safety purpose of the polarized or grounding-type plug. A polarized plug has two blades with one wider than the other. A grounding type plug has two blades and a third grounding prong. The wide blade or the third prong are provided for your safety. If the provided plug does not fit into your outlet, consult an electrician for replacement of the obsolete outlet.
- Protect the power cord from being walked on or pinched particularly at plugs, convenience receptacles, and the point where they exit from the apparatus.
- Only use attachments/accessories specified by the manufacturer.
- Use only with the cart, stand, tripod, bracket, or table specified by the manufacturer, or sold with the apparatus. When a cart is used, use caution when moving the cart/apparatus combination to avoid injury from tip-over.



- Unplug this apparatus during lightning storms or when unused for long periods of time.
- Refer all servicing to qualified service personnel. Servicing is required when the apparatus has been damaged in any way, such as power-supply cord or plug is damaged, liquid has been spilled or objects have fallen into the apparatus, the apparatus has been exposed to rain or moisture, does not operate normally, or has been dropped.

By using this product, you agree that all disputes between you and LG arising out of or relating in any way to this product (including but not limited to warranty disputes) shall be resolved exclusively through binding arbitration on an individual basis. The terms of the arbitration agreement (including details on the procedure for resolving disputes) is available at www.lg.com/us/arbitration (USA) or www.lg.com/ca_en/arbitration (Canada).

Checking before use

- 1 Place the product on a flat surface with the logo facing upwards.

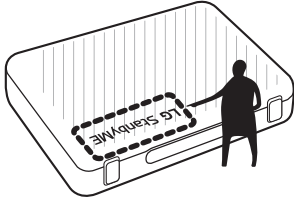

- 2 Connect the power cable for the first use. The AC power terminal is inside the cover on the right side at the back of the product.

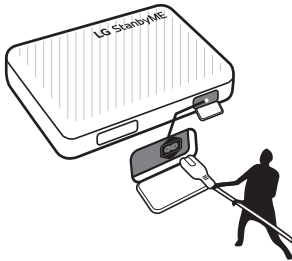

- 3 Pull the upper part of the locking mechanism at the front of the product to unlock it. Lift the top cover of the product upwards to open it.

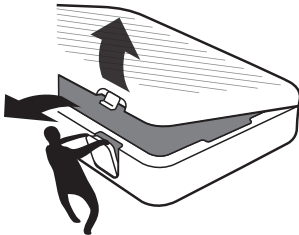

- 4 Raise the display upwards while facing it forward.

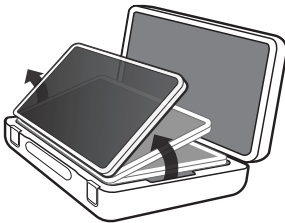

- 5 Lift the display up as far as it will go and rotate it clockwise. (Do not rotate counter-clockwise.)



- 6 Using the upper groove, lift the accessory cover located at the bottom of the display. It may be tightly secured for safety. Exert some force to release it. Store the power cord in the space inside the cover. (Depending upon country)



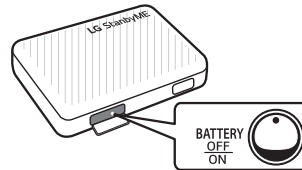

- 7 Open the terminal cover located on the back of the product and check the battery switch. Discharge can be prevented when the battery switch is off (O direction).

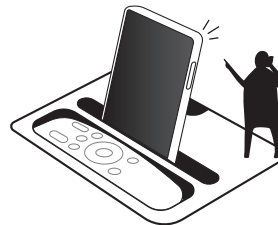

- 8 Use the accessory tray to store the remote control and mount your phone for use.



Before reading this manual

- The user manual for this product consists of two parts: the Owner's Manual and the User Guide. The Owner's Manual explains the steps to install the product purchased, and the electronic User Guide shows how to use the various features of the product.
- **Owner's Manual:** The Owner's Manual contains safety instructions that must be followed when using the product. It also explains how to connect an external device to the product as well as how to use the remote control. For more information about the components and installation instructions, see the separate guide provided with the product.
- **User Guide:** The electronic User Guide stored in the product provides more information about how to use various features. On the remote control, select the menu as shown below.
 - To open the USER GUIDE  →  → [Support] → [User Guide]

✓ Note

- LG Electronics is not responsible for product failure or injury caused by the use of non-genuine imitation products.
- Product components and accessories are subject to change without prior notice through performance upgrades. The model name or design may be changed depending upon the manufacturer's circumstances or policies.
- Images shown in this manual may differ from the actual product.

Checking accessories



Owner's Manual



Power Cord



Remote Control



Cable Management

Optional Extras

- A cable to connect external devices must be purchased separately.

Warning! Safety instructions



CAUTION: TO REDUCE THE RISK OF ELECTRIC SHOCK, DO NOT REMOVE COVER (OR BACK). NO USER-SERVICEABLE PARTS INSIDE. REFER TO QUALIFIED SERVICE PERSONNEL.

 This symbol is intended to alert the user to the presence of uninsulated "dangerous voltage" within the product's enclosure that may be of sufficient magnitude to constitute a risk of electric shock to persons.

 This symbol is intended to alert the user to the presence of important operating and maintenance (servicing) instructions in the literature accompanying this apparatus.

WARNING: TO REDUCE THE RISK OF FIRE AND ELECTRIC SHOCK, DO NOT EXPOSE THIS PRODUCT TO RAIN OR MOISTURE.

- TO PREVENT THE SPREAD OF FIRE, KEEP CANDLES OR OTHER ITEMS WITH OPEN FLAMES AWAY FROM THIS PRODUCT AT ALL TIMES.
- **Do not place the product and/or remote control in the following environments:**
 - Keep the product away from direct sunlight.
 - An area with high humidity such as a bathroom.
 - Near any heat source such as stoves and other devices that produce heat.
 - Near kitchen counters or humidifiers where they can easily be exposed to steam or oil.
 - An area exposed to rain or wind.
 - Do not expose to dripping or splashing and do not place objects filled with liquids, such as vases, cups, etc. on or over the apparatus (e.g., on shelves above the unit).
 - Near flammable objects such as gasoline or candles, or expose the product to direct air conditioning.
 - Do not install in excessively dusty places.
 - On unsecured or high furniture, such as shelves or bookshelves.

Otherwise, this may result in fire, electric shock, combustion/explosion, malfunction or product deformation.
- **Ventilation**
 - Install your product where there is proper ventilation. Do not install in a confined space such as a bookcase.
 - Do not install the product on a carpet or cushion.
 - Do not block or cover the product with cloth or other materials while unit is plugged in.
- Take care not to touch the ventilation openings. When watching the product for a long period, the ventilation openings may become hot.
- Protect the power cord from physical or mechanical abuse, such as being twisted, kinked, pinched, closed in a door, or walked upon. Pay particular attention to plugs, wall outlets, and the point where the cord exits the device.
- Do not move the product whilst the Power cord is plugged in.
- Do not use a damaged or loosely fitting power cord.
- Be sure to grasp the plug when unplugging the power cord. Do not pull on the power cord to unplug the product.
- Do not connect too many devices to the same AC power outlet as this could result in fire or electric shock.
- When connecting the power plug to a socket, connect the power cord to the product first, then connect the power plug of the power cord to the socket.

- **Disconnecting the Device from the Main Power**
 - The power plug is the disconnecting device. In case of an emergency, the power plug must remain readily accessible.
- Do not let your children climb or cling onto the product. Otherwise, the product may fall over, which may cause serious injury.
- **Grounding** (Except for devices which are not grounded.)
 - The product with a three-prong grounded AC plug must be connected to a three-prong grounded AC outlet. Ensure that you connect the earth ground wire to prevent possible electric shock.
- Never touch this apparatus or antenna during a lightning storm. You may be electrocuted.
- Make sure the power cord is connected securely to the product and wall socket if not secured damage to the Plug and socket may occur and in extreme cases a fire may break out.
- Do not insert metallic or inflammable objects into the product. If a foreign object is dropped into the product, unplug the power cord and contact the customer service.
- Do not touch the end of the power cord while it is plugged in. You may be electrocuted.
- **If any of the following occur, unplug the product immediately and contact your local customer service.**
 - The product has been damaged.
 - If water or another substance enters the product (like an AC adapter, power cord, or product).
 - If you smell smoke or other odors coming from the product.
 - When lightning storms or when unused for long periods of time.

Even the product is turned off by remote control or button, AC power source is connected to the unit if not unplugged in.
- Do not use high voltage electrical equipment near the product (e.g., a bug zapper). This may result in product malfunction.
- Turning on the power while the product and power cord are wet may cause the product to malfunction or result in an electric shock.
- When rotating the screen from landscape to portrait, do so in a clockwise direction.
- Do not attempt to modify this product in any way without written authorization from LG Electronics. Accidental fire or electric shock can occur. Contact your local customer service for service or repair. Unauthorized modification could void the user's authority to operate this product.

- Use only an authorized attachments / accessories approved by LG Electronics. Otherwise, this may result in fire, electric shock, malfunction, or product damage.
- Never disassemble the AC adapter or power cord. This may result in fire or electric shock.
- Handle the adapter carefully to avoid dropping or striking it. Do not subject the adaptor to external shock. An impact could damage the adapter.
- To reduce the risk of fire or electrical shock, do not touch the product with wet hands. If the power cord prongs are wet or covered with dust, dry the power plug completely or wipe dust off.
- Please make sure the device is installed near the wall outlet to which it is connected and that the outlet is easily accessible.
- **Batteries**
 - Store the accessories (battery, etc.) in a safe location out of the reach of children.
 - Do not short circuit, disassemble, or allow the batteries to overheat. Do not dispose of batteries in a fire. Batteries should not be exposed to excessive heat.
 - Caution: Use the correct batteries for the product. Risk of fire or explosion if the battery is replaced by an incorrect type.
 - Do not store or transport the product at pressures of less than 11.6 kPa (1.68 psi) and altitudes above 15,000 m (49212.5 feet).
- **Moving**
 - When moving, make sure the product is turned off, unplugged, and all cables have been removed. It may take 2 or more people to carry larger products. Do not press or put stress on the front panel of the product. Otherwise, this may result in product damage, fire hazard or injury.
 - Secure the product safely when moving it after loading. Impact may result in product damage.
 - Carrying the product with the case open may cause damage to the product or injury.
 - When closing the product, be sure to check that the lock is properly closed before moving.
- Keep the packing anti-moisture material or vinyl packing out of the reach of children.
- Do not allow an impact shock, any objects to fall into the product, and do not drop anything onto the screen.
- Do not press strongly upon the panel with a hand or a sharp object such as a nail, pencil, or pen, or make a scratch on it. It may cause damage to screen.
- Do not hold the product screen, scratch the surface with a metal object, or apply impact to it.
 - The screen may break, resulting in personal injury or malfunction of the product.
- Do not subject the touch screen to severe impact. Doing so may damage the touch sensors (touch screen).
- As the switch on the back of the product is for internal battery power, it remains connected to the main power even when turned off.
- Please use and charge the product by connecting it to a socket in its correct position.
- Do not place the product on an inclined surface when standing.
- Pulling the handle forcefully may result in damage.
- The product may be discharged if the case is not closed properly.
- Discolouration or damage may occur if cosmetics or oils come into contact with the product.
- While the case is open, placing objects inside and closing may damage the product.
- Applying excessive force when adjusting the height/rotating the screen/opening and closing the case may damage the product.
- Long-term exposure to direct sunlight with the case open may cause discolouration of the jersey part.
- If your hand gets caught when closing the case, you may be injured.
- Do not push or kick the product.
- Do not place heavy objects on top of the product.
- Do not ride the product like a kickboard.
- Do not force the product to rotate at an angle that exceeds its limit.
- Be careful if you have pets
- **Cleaning**

The product is not waterproof.

 - When cleaning, unplug the power cord and wipe gently with a soft/dry cloth. Do not spray water or other liquids directly on the product. Do not clean your product with chemicals including glass cleaner, any type of air freshener, insecticide, lubricants, wax (car, industrial), abrasive, thinner, benzene, alcohol etc., which can damage the product and/or its panel. Otherwise, this may result in electric shock or product damage.

If the fabric on the back of the product comes into contact with a foreign substance, wipe it off immediately using a clean wet tissue or cloth.

 - If not cleaned immediately, it may leave a stain.

• **Precautions when using the built-in battery**

- If liquid leaks from the battery, stop using it immediately and avoid contact with your skin and eyes. It may cause blindness or burns. If any abnormality is found in the body part that came into contact with liquid, wash the area with sufficient water and seek advice from a doctor.
- Do not dispose of batteries in an incorrect manner. Doing so creates a risk of explosion or fire. Battery disposal guidelines vary by country and region. Please dispose of batteries in the proper manner.
- Do not subject the product to shock (particularly the lithium battery). Do not expose it to fire, electric heaters, or direct sunlight. Doing so may result in electric shock, injury, or fire.
- When charging the battery, ensure it is correctly inserted, and do not use any other power supply or circuit. There is a risk of battery damage or fire.
- Be careful when using the battery as it contains lithium. There is a risk of fire or explosion.
- Make sure to use a genuine adaptor/battery approved by LG Electronics. Failure to do so may result in shorter product life or malfunction and may also cause overheating, fire, explosion, or injury.
- Clean the charging terminal using a soft cloth. If the charging terminal is dirty or has foreign substances on it, the battery will not charge normally.
- If the battery is completely discharged and not used for a long period of time, it may not charge at all or the battery life may be reduced.
- Do not disconnect, disassemble, or short circuit the battery. Doing so may result in electric shock, injury, or fire. If you or a third party have disassembled/assembled any part of the product or battery without contacting the LG Electronics Service Centre, you will not be able to receive any repair services or compensation in the event of product failure, safety accidents or injury.
- Do not remove the battery from the product. Doing so may result in electric shock, injury, or fire. If you or a third party have disassembled/assembled any part of the product without contacting the LG Electronics Service Centre, you will not be able to receive any repair services or compensation in the event of product failure, safety accidents or injury.
- The battery may explode if disposed of in a fire or hot oven, or if mechanically crushed or cut.
- Leaving the battery in an extremely high-temperature environment may cause an explosion or leakage of flammable liquids or gases.
- Extremely low air pressure may cause the battery to explode or leak flammable liquids or gases.

Operating the product

Turning on the product

You can simply operate the product functions, using the button.

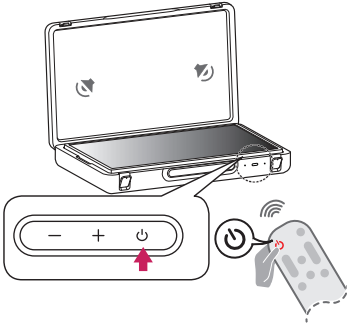

Using the button

	Adjusts the volume level.
	Turn the product on and off. - A short press turns the product on, and a long press shuts down all functions and turns off the screen. You can also turn the power on and off by opening and closing the case.

✔ Note

- The shape and location of the power button may vary depending upon the product model.
- When the screen is powered on for the first time, it may turn on after approximately one minute to complete the initialization of the product.
- Avoid placing magnets near the operation buttons.

Using the touch screen

Tap	Tap the screen lightly.
Tap and hold	Tap the screen for 2 seconds or longer.
Scroll	Scroll the screen up, down, left, and right.
Drag	Tap and hold the item you wish to move, such as an app or widget, and drag it to the desired location.
Pinch-Close / Pinch-Open	You can zoom in or out on the app by placing two fingers on the screen and spreading them apart or bringing them together.

✔ Note

- Touch functions such as zooming in and out on the screen may not be supported, depending upon the app used.
- Avoid pressing too hard on the screen; instead, tap lightly on the desired item with your fingertips. If you touch the screen while wearing gloves or with the tip of your fingernails, it may not work correctly.
- Touch sensors may not work correctly if the screen is moist or wet.

About LED operation

The battery status LED is only displayed when charging in standby mode.

While viewing, you can check the battery status on the upper right corner of the screen.

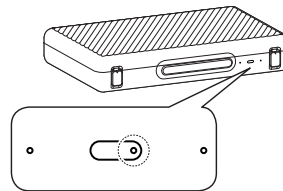

✔ Note

- When the lid is closed, ensure that the red LED blinks.
- The red LED is displayed during charging, and the green LED is displayed when fully charged.

Connections

Other devices, such as HDMI, can be connected to the product.

When connecting with an external device, locate and select the device with which you wish to connect on the Home screen.

HDMI

- When connecting the HDMI cable, the product and external devices should be turned off and unplugged.
- Supported HDMI Audio format (Depending upon model):
True HD (48 kHz),
Dolby Digital / Dolby Digital Plus (32 kHz, 44.1 kHz, 48 kHz),
PCM (32 kHz, 44.1 kHz, 48 kHz, 96 kHz, 192 kHz)

✔ Note

- Use a certified cable with the HDMI logo attached.
- If you do not use a certified HDMI cable, the screen may not display or a connection error may occur.
- Recommended HDMI Cable Types
 - Ultra High Speed HDMI[®]/™ cable (3 m or less)

USB

Some USB Hubs may not work. If a USB device connected using a USB Hub is not detected, connect it to the USB port on the product directly.

✔ Note

- For an optimal connection, HDMI cables and USB devices should have bezels less than 10 mm (0.39 inches) thick and 18 mm (0.7 inches) width.
- Use an extension cable that supports USB 2.0 if the USB cable or USB memory stick does not fit into your product's USB port.

IR Blaster

Control the set-top box (cable/satellite/IP/OTT), Blu-ray/DVD player, soundbar, game consoles, etc., using the IR Blaster, (Depending upon country).

✔ Note

- Connect the IR Blaster cable to the product's IR Blaster port.
- Do not plug headphones (earphones) into the IR blaster terminal.
- Use universal control settings to control the device.
- Secure the IR Blaster with the 3M tape provided.
- In order to control external devices through "Room to Room Share" and "Hands-free Voice Control", an IR blaster connection is required.

External Devices

Supported external devices are: Blu-ray player, HD receivers, DVD players, VCRs, audio systems, USB storage devices, PC, gaming devices, and other external devices.

✔ Note

- The external device connections shown may differ slightly from illustrations in a manual.
- In PC mode, there may be noise associated with the resolution, vertical pattern, contrast or brightness. If noise is present, change the PC output to another resolution, change the refresh rate to another rate or adjust the brightness and contrast on the [Picture] menu until the picture is clear. Depending upon the graphics card, some resolution settings may not allow the image to be positioned on the screen properly.

Using the built-in battery

This product has a built-in battery, allowing convenient use of the product with only the battery for a period of time without an additional power supply.

Battery status display

The remaining battery level is displayed as % on the upper right corner of the screen. In standby mode, it is displayed as a green/red LED when connected to the power cord.

✔ Note

- The battery takes about 3 hours to fully charge in standby mode and about 4 hours while in use.
- The battery life and usage time after charging decrease in proportion to the period and duration of use of the product.
- Battery charging may not be possible at temperatures below 0 °C (32 °F).
- Even when not in use, the remaining charge of the battery will naturally decrease.
- For a longer battery life, charge the battery after using it for a certain period of time instead of keeping the battery fully charged.
- Keeping the battery level at 50 % helps extend battery life.
- The maximum usage time after charging is 3 hours.
- The standard usage time shown in this manual is based on measurements conducted by LG. Thus, the actual time may vary depending upon usage.
- The usage time may vary depending upon factors such as the device connected, operating temperature, period of use, and user settings.

Battery switch

The **O** direction indicates the off state, and the **I** direction indicates the on state.

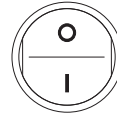

- We recommend turning the product off (**O** direction) when not using it for an extended period or when moving it.
- Leaving the battery operation switch on without charging it for an extended period may result in battery discharge.
- The product can only be used in battery mode when the battery switch is on. When turned off, the external power is used.
- When connected to an external power source, you can charge the battery and use the product.

Specifications

Power requirement	AC 120 V~ 50/60 Hz
Current Value / Power consumption	0.8 A / 85 W

Battery			
Type	Rechargeable Lithium Ion Battery	Rating	DC 14.8 V --- / (5,000 mAh) (74 Wh)

Environment Condition			
Operating Temperature	0 °C to 40 °C (32 °F to 104 °F)	Storage Temperature	-20 °C to 60 °C (-4 °F to 140 °F)
Operating Humidity	Less than 80 %	Storage Humidity	Less than 85 %

- See the label on the back of the display for power source, power consumption and product information.

Product Specifications

(Image shown may differ from your product.)

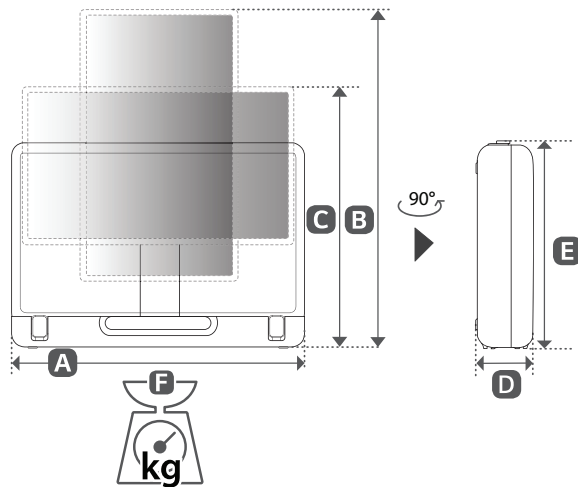

A, B, C, D, E : mm
F : kg

Model	A	B	C	D	E	F
27LX5QKNA	670	729	598	119	433	12.7

Product Information

Wireless module(LGSBWAC95)Specifications

Wireless LAN (IEEE 802.11a/b/g/n/ac)

Frequency range	Output Power (Max.)
2,400 to 2,483.5 MHz	18.5 dBm
5,150 to 5,725 MHz	18 dBm
5,725 to 5,850 MHz	18 dBm

Bluetooth

Frequency range	Output Power (Max.)
2,400 to 2,483.5 MHz	9 dBm

As band channels can vary per country, the user cannot change or adjust the operating frequency. This product is configured for the regional frequency table.

FCC ID: BEJLGSBWAC95 / IC: 2703H-LGSBWAC95

Open Source Software Notice Information

To obtain the source code that is contained in this product, under GPL, LGPL, MPL, and other open source licenses that have the obligation to disclose source code, and to access all referred license terms, copyright notices and other relevant documents please visit <https://opensource.lge.com>.

LG Electronics will also provide open source code to you on CD-ROM for a charge covering the cost of performing such distribution (such as the cost of media, shipping, and handling) upon email request to opensource@lge.com.

This offer is valid to anyone in receipt of this information for a period of three years after our last shipment of this product.

Licenses

HDMI™
HIGH-DEFINITION MULTIMEDIA INTERFACE

HEVC Advance™
Covered by patents at patentlist.accessadvance.com

Troubleshooting

In HDMI input, press the  button on the remote control three times to display the model name and serial number on the screen.

Cannot control the product with the remote control.	<ul style="list-style-type: none"> • Check if anything such as tape has been placed over the receiver. • Check if there is any obstacle between the product and the remote control. • Replace the batteries with new fresh ones.
No image display and no sound is produced.	<ul style="list-style-type: none"> • Check if the product is turned on. • Check if the power cord is connected to a wall outlet. • Check if there is a problem in the wall outlet by connecting other products. • When using in battery mode, turn the battery switch on.
The product turns off suddenly.	<ul style="list-style-type: none"> • Check the power control settings. The power supply may be interrupted. • Check if the auto-off function is activated in the settings menu. • If there is no signal while the product is on, the product will turn off automatically after 15 minutes of inactivity. • If the battery overheats, the product automatically turns off to protect itself.
Abnormal Display	<ul style="list-style-type: none"> • If the product feels cold to the touch, there may be a small "flicker" when it is turned on. This is normal, there is nothing wrong with product. • This panel is an advanced product that contains millions of pixels. You may see tiny black dots and/or brightly colored dots (red, blue or green) at a size of 1 ppm on the panel. This does not indicate a malfunction and does not affect the performance and reliability of the product. This phenomenon also occurs in third-party products and is not subject to exchange or refund. • You may find different brightness and color of the panel depending upon your viewing position(left/right/top/down). This phenomenon occurs due to the characteristic of the panel. It is not related with the product performance, and it is not malfunction. • Avoid touching the screen or holding your finger(s) against it for long periods of time. Doing so may produce some temporary distortion effects on the screen. • Displaying a still image for a prolonged period of time may cause image sticking. Avoid displaying a fixed image on the product screen for a long period of time.
Generated Sound	<ul style="list-style-type: none"> • Cracking noise A cracking noise that occurs when watching or turning off the TV is generated by plastic thermal contraction due to temperature and humidity. This noise is common for products where thermal deformation is required. • Electrical circuit humming/panel buzzing A low level noise is generated from a high-speed switching circuit, which supplies a large amount of current to operate a product. It varies depending upon the product. This generated sound does not affect the performance and reliability of the product.
<ul style="list-style-type: none"> • Using the product in a dusty environment may cause the screen to become dim. • In the case of abnormal operation, turn the battery switch off, unplug the power cord, and then plug it back in. 	



- When cleaning the product, be careful not to allow any liquid or foreign objects to enter the gap between the upper, left or right side of the panel and the guide panel, (Depending upon model).
- Make sure to wring any excess water or cleaner from the cloth.
- Do not spray water or cleaner directly onto the product screen.
- Make sure to spray just enough of water or cleaner onto a dry cloth to wipe the screen.

Regulatory

FCC NOTICE

(For USA)

This equipment has been tested and found to comply with the limits for a Class B digital device, pursuant to Part 15 of the FCC Rules. These limits are designed to provide reasonable protection against harmful interference in a residential installation. This equipment generates, uses, and can radiate radio frequency energy and, if not installed and used in accordance with the instructions, may cause harmful interference to radio communications. However, there is no guarantee that interference will not occur in a particular installation. If this equipment does cause harmful interference to radio or television reception, which can be determined by turning the equipment off and on, the user is encouraged to try to correct the interference by one or more of the following measures:

- Reorient or relocate the receiving antenna.
- Increase the separation between the equipment and the receiver.
- Connect the equipment to an outlet on a circuit different from that to which the receiver is connected.
- Consult the dealer or an experienced radio/TV technician for help.

This device complies with part 15 of the FCC Rules. Operation is subject to the following two conditions: (1) this device may not cause harmful interference and (2) this device must accept any interference received, including interference that may cause undesired operation. Any changes or modifications in construction of this device which are not expressly approved by the party responsible for compliance could void the user's authority to operate the equipment and For indoor use only, use outdoors or in other modes not covered by this manual may violate the FCC regulation and violate the user authority to use the product.

This device complies with RF exposure requirement.

FCC Radio Frequency Interference Requirements (for UNII devices)

(For USA)

High power radars are allocated as primary users of the 5.25 to 5.35 GHz and 5.65 to 5.85 GHz bands. These radar stations can cause interference with and/or damage this device. This device cannot be co-located with any other transmitter.

Industry Canada Statement

(For Canada)

(For having wireless function (WLAN, Bluetooth,...))

This device contains licence-exempt transmitter(s)/receiver(s) that comply with Innovation, Science and Economic Development Canada's licence-exempt RSS(s). Operation is subject to the following two conditions:

- (1) This device may not cause interference.
- (2) This device must accept any interference, including interference that may cause undesired operation of the device.

NOTE: THE MANUFACTURER IS NOT RESPONSIBLE FOR ANY RADIO OR TV INTERFERENCE CAUSED BY UNAUTHORIZED MODIFICATIONS TO THIS EQUIPMENT. SUCH MODIFICATIONS COULD VOID THE USER'S AUTHORITY TO OPERATE THE EQUIPMENT.

RSS-247 Requirement

(For Canada)

(For product having the wireless function using 5 GHz frequency bands)

- (1) The device for operation in the band 5150–5250 MHz is only for indoor use to reduce the potential for harmful interference to co-channel mobile satellite systems;
- (2) For devices with detachable antenna(s), the maximum antenna gain permitted for devices in the bands 5250-5350 MHz and 5470-5725 MHz shall be such that the equipment still complies with the e.i.r.p. limit;
- (3) For devices with detachable antenna(s), the maximum antenna gain permitted for devices in the band 5725-5850 MHz shall be such that the equipment still complies with the e.i.r.p. limits as appropriate; and
- (4) (For devices operating in the band 5250-5350 MHz having an e.i.r.p. greater than 200 mW) Antenna type(s), antenna models(s), and worst-case tilt angle(s) necessary to remain compliant with the e.i.r.p. elevation mask requirement set forth in section 6.2.2.3 of RSS-247 shall be clearly indicated.

Users should also be advised that high-power radars are allocated as primary users (i.e. priority users) of the bands 5250-5350 MHz and 5650-5850 MHz and that these radars could cause interference and/or damage to LE-LAN devices.







WARNING! (STABILITY HAZARD)

A television set may fall, causing serious personal injury or death. Many injuries, particularly to children, can be avoided by taking simple precautions such as:

- ALWAYS use cabinets or stands or mounting methods recommended by the manufacturer of the television set.
- ALWAYS use furniture that can safely support the television set.
- ALWAYS ensure the television set is not overhanging the edge of the supporting furniture.
- ALWAYS educate children about the dangers of climbing on furniture to reach the television set or its controls.
- ALWAYS route cords and cables connected to your television so they cannot be tripped over, pulled or grabbed.
- NEVER place a television set in an unstable location.
- NEVER place the television set on tall furniture (for example, cupboards or bookcases) without anchoring both the furniture and the television set to a suitable support.
- NEVER place the television set on cloth or other materials that may be located between the television set and supporting furniture.
- NEVER place items that might tempt children to climb, such as toys and remote controls, on the top of the television or furniture on which the television is placed.

If the existing television set is going to be retained and relocated, the same considerations as above should be applied.

Symbols

	Refers to alternating current (AC).		Refers to stand-by.
	Refers to direct current (DC).		Refers to "ON" (power).
	Refers to class II equipment.		Refers to dangerous voltage.

Battery take-back information

In case rechargeable battery is included in this product, the entire device should be recycled in compliance with rechargeable battery recycling standards because of the internal battery. To dispose of properly, call (800) 822-8837 or visit www.call2recycle.org.

LG Take-back & Recycling Policy

(For USA)

LG Electronics offers a customized e-waste take-back & recycling service that meets local needs and requirements in the countries where e-waste regulations are in place, and also provides product take-back & recycling service voluntarily in some regions. LG Electronics evaluates products' recyclability at the design step selectively, with the goal of improving recyclability where practicable. Through these activities, LG Electronics seeks to contribute to conserving natural resources and protecting the environment. For more information, please visit our global site at <https://www.lg.com/recycling>

