



# HCT.CO., LTD.

Product Compliance Division

TEL : +82 31 639 8518 FAX : +82 31 639 8535

## FCC Certification

**Applicant Name:**  
LG Electronics, Inc.

**Date of Issue:**  
December 22, 2009

**Address:**  
60-39, Gasan-dong, Gumchon-gu,  
Seoul, 153-023, Korea

**Location:**  
HCT CO., LTD., San 136-1 Ami-ri, Bubal-eup, Icheon-si,  
Kyungki-do, Korea

**Test Report No.:** HCTR0912FR04-1

**HCT FRN:** 0005866421

**IC Recognition No.:** IC 5944A-1

**FCC ID : BEJGX200**

**APPLICANT : LG Electronics, Inc.**

**Model(s):** GX200

**EUT Type:** Cellular/ PCS GSM Phone with Bluetooth

**Tx Frequency:** 824.20 – 848.80 MHz (GSM850)  
1 850.20 – 1 909.80 MHz (GSM1900)

**Rx Frequency:** 869.20 – 893.80 MHz (GSM850)  
1 930.20 – 1 989.80 MHz (GSM1900)

**Max. RF Output Power:** Sim 1: 1.104 W ERP GSM850 ( 30.43 dBm) / 0.497 W EIRP GSM1900 ( 26.96 dBm)  
Sim 2: 1.096 W ERP GSM850 ( 30.40 dBm) / 0.511 W EIRP GSM1900 ( 27.08 dBm)

**Emission Designator(s):** Sim 1: 250KGXW (GSM850), 249KGXW (GSM1900)  
Sim 2: 248KGXW (GSM850), 250KGXW (GSM1900)

**FCC Classification:** Licensed Portable Transmitter Held to Ear (PCE)

**FCC Rule Part(s):** §22, §24, §2

The measurements shown in this report were made in accordance with the procedures specified in §2.947. I assume full responsibility for the accuracy and completeness of these measurements, and for the qualifications of all persons taking them.

HCT CO., LTD. Certifies that no party to this application has been denied FCC benefits pursuant to section 5301 of the Anti-Drug Abuse Act of 1998,21 U.S. C.853(a)

**Report prepared by**

**: Jong Seok Lee**

**Test engineer of RF Team**

**Approved by**

**: Sang Jun Lee**

**Manager of RF Team**

This report only responds to the tested sample and may not be reproduced, except in full, without written approval of the HCT Co., Ltd.

FCC CERTIFICATION REPORT				<a href="http://www.hct.co.kr">www.hct.co.kr</a>
Test Report No. HCTR0912FR04-1	Date of Issue: December 22, 2009	EUT Type: Cellular/ PCS GSM Phone with Bluetooth	FCC ID: BEJGX200	Page 1 of 51



# Table of Contents

1. GENERAL INFORMATION .....	3
2. INTRODUCTION .....	4
2.1. EUT DESCRIPTION.....	4
2.2. MEASURING INSTRUMENT CALIBRATION.....	4
2.3. TEST FACILITY .....	4
3. DESCRIPTION OF TESTS .....	5
3.1 Effective Radiated Power/Equivalent Isotropic Radiated Power.....	5
3.2 Peak- to- Average Ratio .....	6
3.3 Occupied bandwidth. ....	7
3.4 Spurious and Harmonic Emissions at Antenna Terminal.....	8
3.5 Radiated Spurious and Harmonic Emissions .....	9
3.6 Frequency stability / variation of ambient temperature .....	10
4. LIST OF TEST EQUIPMENT .....	11
5. SUMMARY OF TEST RESULTS .....	12
6. SAMPLE CALCULATION .....	13
7. TEST DATA .....	14
7.1 Conducted Output Power .....	14
7.2 Peak-to-Average Ratio .....	15
7.3 Occupied Bandwidth.....	16
7.4 Conducted Spurious Emissions .....	17
7.4.1 Band Edge .....	17
7.5 Effective Radiated Power Output (E.R.P)(GSM850).....	18
7.6 Equivalent Isotropic Radiated Power (E.I.R.P.) (GSM1900 ) .....	19
7.7 Radiated Spurious Emissions.....	20
7.7.1 Radiated Spurious Emissions (GSM850 Mode) .....	20
7.7.2 Radiated Spurious Emissions (GSM1900 Mode) .....	22
7.8 Frequency stability / variation of ambient temperature .....	24
7.8.1 FREQUENCY STABILITY (GSM850) .....	24
7.8.2 FREQUENCY STABILITY (GSM1900) .....	26
8. TEST PLOTS.....	28



# MEASUREMENT REPORT

## 1. GENERAL INFORMATION

**Applicant Name:** LG Electronics, Inc.  
**Address:** 60-39, Gasan-dong, Gumchon-gu, Seoul, 153-023, Korea

**FCC ID:** BEJGX200

**Application Type:** Certification  
**FCC Classification:** Licensed Portable Transmitter Held to Ear (PCE)  
**FCC Rule Part(s):** §22, §24, §2  
**EUT Type:** Cellular/ PCS GSM Phone with Bluetooth  
**Model(s):** GX200

**Battery Model Name:** LGIP-400N(Standard)  
**Power Rating:** 3.7 V, 1500 mAh, 5.6 Wh  
**Type:** Lithium-Ion Polymer Battery

**Tx Frequency:** 824.20 – 848.80 MHz (GSM850)  
1 850.20 – 1 909.80 MHz (GSM1900)

**Rx Frequency:** 869.20 – 893.80 MHz (GSM850)  
1 930.20 – 1 989.80 MHz (GSM1900)

**Max. RF Output Power:** Sim 1: 1.104 W ERP GSM850 ( 30.43 dBm) / 0.497 W EIRP GSM1900 ( 26.96 dBm)  
Sim 2: 1.096 W ERP GSM850 ( 30.40 dBm) / 0.511 W EIRP GSM1900 ( 27.08 dBm)

**Emission Designator(s):** Sim 1: 250KGXW (GSM850), 249KGXW (GSM1900)  
Sim 2: 248KGXW (GSM850), 250KGXW (GSM1900)

**Antenna Specification** Manufacturer: Arima / RTC  
Antenna type: Internal Antenna  
Peak Gain: -2.85 dBi

**Date(s) of Tests:** November 06, 2009 ~ December 07, 2009

FCC CERTIFICATION REPORT				<a href="http://www.hct.co.kr">www.hct.co.kr</a>
Test Report No. HCTR0912FR04-1	Date of Issue: December 22, 2009	EUT Type: Cellular/ PCS GSM Phone with Bluetooth	FCC ID: BEJGX200	Page 3 of 51



## 2. INTRODUCTION

### 2.1. EUT DESCRIPTION

The LG Electronics, Inc. GX200 Cellular/ PCS GSM Phone with Bluetooth consists of GSM850, GSM1900 and GPRS Class10 and GPRS mode Class B(GPRS and GSM, but not simultaneously).

### 2.2. MEASURING INSTRUMENT CALIBRATION

The measuring equipment, which was utilized in performing the tests documented herein, has been calibrated in accordance with the manufacturer's recommendations for utilizing calibration equipment, which is traceable to recognized national standards.

### 2.3. TEST FACILITY

The open area test site and conducted measurement facility used to collect the radiated data are located at the 254-1, Maekok-Ri, Hobup-Myun, Ichon-Si, Kyoungki-Do, 467-701, KOREA. The site is constructed in conformance with the requirements of ANSI C63.4 and CISPR Publication 22. Detailed description of test facility was submitted to the Commission and accepted dated June 10, 2009(Registration Number: 90661)

FCC CERTIFICATION REPORT				<a href="http://www.hct.co.kr">www.hct.co.kr</a>
Test Report No. HCTR0912FR04-1	Date of Issue: December 22, 2009	EUT Type: Cellular/ PCS GSM Phone with Bluetooth	FCC ID: BEJGX200	Page 4 of 51

### 3. DESCRIPTION OF TESTS

#### 3.1 Effective Radiated Power/Equivalent Isotropic Radiated Power

##### Test Set-up

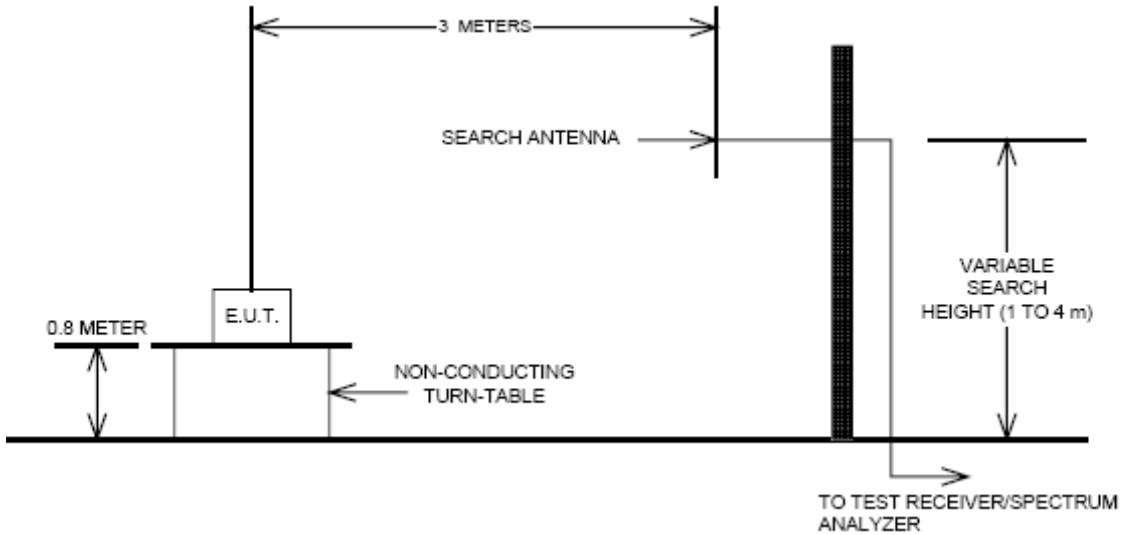

##### Test Procedure

Radiated emission measurements were performed at an open Site.

The equipment under test is placed on a wooden turntable 3-meters from the receive antenna.

A wooden turntable was rotated 360° and the receiving antenna scanned from 1-4m in order to capture the maximum emission. A half wave dipole was substituted in place of the EUT. This dipole antenna was driven by a signal generator and the previously recorded signal was duplicated.

The maximum EIRP was calculated by adding the forward power to the calibrated source plus its appropriate gain value. These steps were carried out with the receiving antenna in both vertical and horizontal polarization. For readings above 1GHz, the above procedure is repeated using horn antennas and the difference between the gain of the horn and an isotropic antenna are taken into consideration.



### 3.2 Peak- to- Average Ratio

A peak to average ratio measurement is performed at the conducted port of the EUT. For CDMA and WCDMA signals, the spectrum analyzers Complementary Cumulative Distribution Function ( CCDF ) measurement profile is used to determine the largest deviation between the average and the peak power of the EUT in a given bandwidth. The CCDF curve shows how much time the peak waveform spends at or above a given average power level. The percent of time the signal spends at or above the level defines the probability for that particular power level. For GSM signals, an average and a peak trace are used on a spectrum analyzer to determine the largest deviation between the average and the peak power of the EUT in a bandwidth greater than the emission bandwidth. Plots of the EUT's Peak- to- Average Ratio are shown herein.

FCC CERTIFICATION REPORT				<a href="http://www.hct.co.kr">www.hct.co.kr</a>
Test Report No. HCTR0912FR04-1	Date of Issue: December 22, 2009	EUT Type: Cellular/ PCS GSM Phone with Bluetooth	FCC ID: BEJGX200	Page 6 of 51

### 3.3 Occupied bandwidth.

#### Test set-up

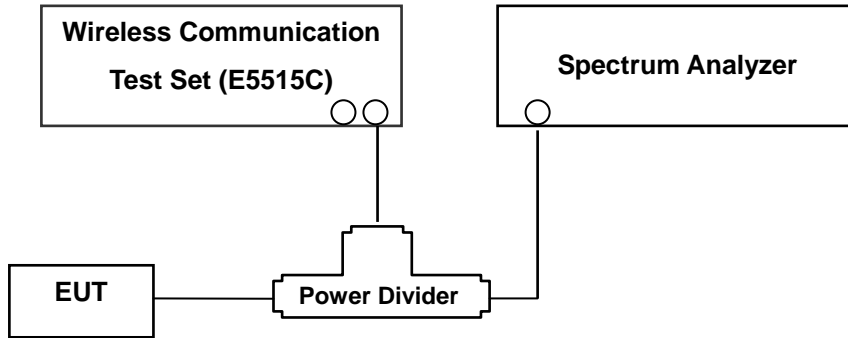

(Configuration of conducted Emission measurement)

#### Test Procedure

The EUT was setup to maximum output power at its lowest channel. The occupied bandwidth was measured using a spectrum analyzer. The measurements are repeated for the highest and a middle channel. The EUT's occupied bandwidth is measured as the width of the signal between two points, one below the carrier center frequency and one above the carrier frequency, outside of which all emissions are attenuated at least 26 dB below the transmitter power. Plots of the EUT's occupied bandwidth are shown herein.



### 3.4 Spurious and Harmonic Emissions at Antenna Terminal.

#### Test Procedure

The level of the carrier and the various conducted spurious and harmonic frequencies is measured by means of a calibrated spectrum analyzer.

The EUT was setup to maximum output power at its lowest channel. The Resolution BW of the analyzer is set to 1 % of the emission bandwidth to show compliance with the – 13 dBm limit, in the 1 MHz bands immediately outside and adjacent to the edge of the frequency block. The 1 MHz RBW was used to scan from 30 MHz to 10 GHz. (GSM1900 Mode: 30 MHz to 20 GHz). A display line was placed at – 13 dBm to show compliance. The high, lowest and a middle channel were tested for out of band measurements.

- Band Edge Requirement : In the 1MHz bands immediately outside and adjacent to the frequency block, a resolution bandwidth of at least 1 percent of the emission bandwidth of the fundamental emission of the transmitter may be employed to measure the out of band Emissions. Limit, -13 dBm.

FCC CERTIFICATION REPORT				<a href="http://www.hct.co.kr">www.hct.co.kr</a>
Test Report No. HCTR0912FR04-1	Date of Issue: December 22, 2009	EUT Type: Cellular/ PCS GSM Phone with Bluetooth	FCC ID: BEJGX200	Page 8 of 51

### 3.5 Radiated Spurious and Harmonic Emissions

#### Test Set-up

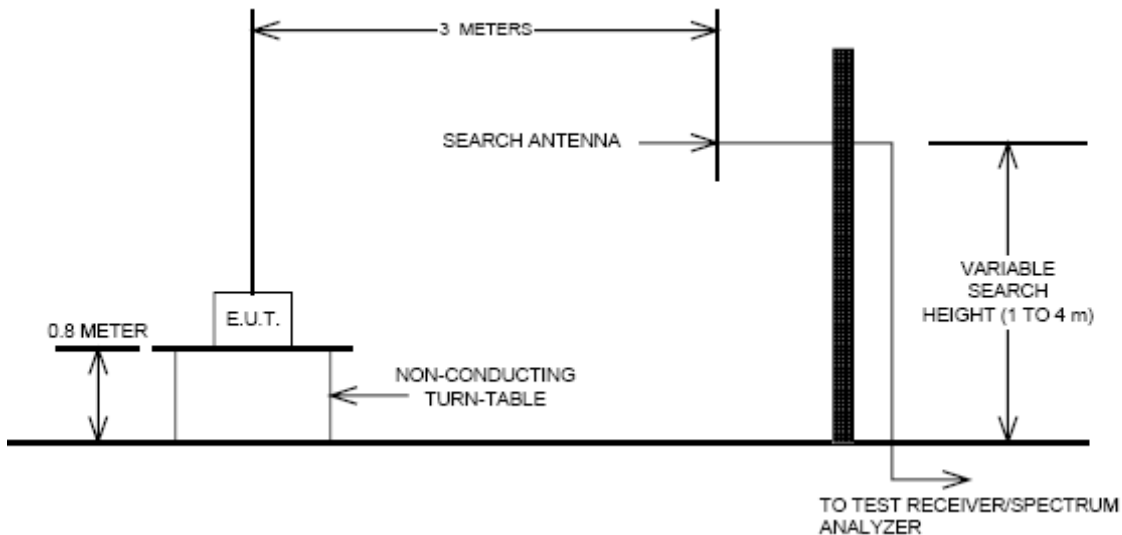

The measurement facilities used for this test have been documented in previous filings with the commission pursuant to section § 2.948. The open field test site is situated in open field with ground screen whose site attenuation characteristics meet ANSI C63.4 –2003. A mast capable of lifting the receiving antenna from a height of one to four meters is used together with a rotatable wooden platform mounted at three from the antenna mast.

- 1) The unit mounted on a wooden table 1.5 m × 1.0 m × 0.80 m is 0.8 meter above test site ground level.
- 2) During the emission test, the turntable is rotated and the EUT is manipulated to find the configuration resulting in maximum emission under normal condition of installation and operation.
- 3) The antenna height and polarization are also varied from 1 to 4 meters until the maximum signal is found.
- 4) The spectrum shall be scanned up to the 10<sup>th</sup> harmonic of the fundamental frequency.

#### Test Procedure

The equipment under test is placed on a wooden turntable 3-meters from the receive antenna. A wooden turntable was rotated 360° and the receiving antenna scanned from 1-4m in order to capture the maximum emission. A half wave dipole was substituted in place of the EUT. This dipole antenna was driven by a signal generator and the previously recorded signal was duplicated.

The maximum EIRP was calculated by adding the forward power to the calibrated source plus its appropriate gain value. These steps were carried out with the receiving antenna in both vertical and horizontal polarization. For readings above 1GHz, the above procedure is repeated using horn antennas and the difference between the gain of the horn and an isotropic antenna are taken into consideration.

### 3.6 Frequency stability / variation of ambient temperature

#### Test Set-up

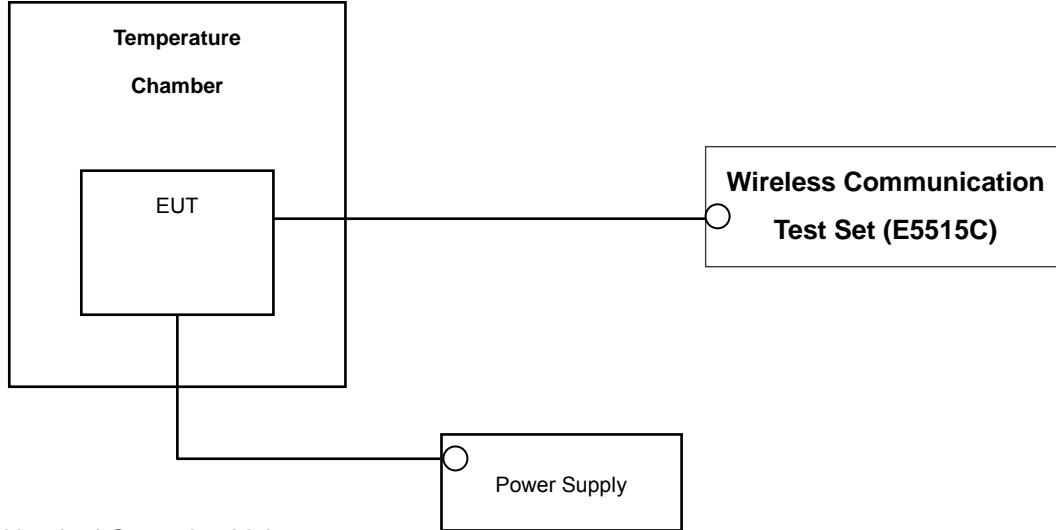

\* Nominal Operating Voltage

#### Test Procedure

The frequency stability of the transmitter is measured by:

- a.) **Temperature:** The temperature is varied from - 30 °C to + 50 °C using an environmental chamber.
- b.) **Primary Supply Voltage:** The primary supply voltage is varied from battery end point to 115 % of the voltage normally at the input to the device or at the power supply terminals if cables are not normally supplied.

Specification — the frequency stability shall be sufficient to ensure that the fundamental emission stays within the authorized frequency block. The frequency stability of the transmitter shall be maintained within  $\pm 0.00025\%$  ( $\pm 2.5$  ppm) of the center frequency.

#### Time Period and Procedure:

The carrier frequency of the transmitter is measured at room temperature (20°C to provide a reference).

1. The equipment is turned on in a “standby” condition for one minute before applying power to the transmitter. Measurement of the carrier frequency of the transmitter is made within one minute after applying power to the transmitter.
2. Frequency measurements are made at 10°C intervals ranging from -30°C to +50°C. A period of at least one half-hour is provided to allow stabilization of the equipment at each temperature level.

**NOTE: The EUT is tested down to the battery endpoint.**



## 4. LIST OF TEST EQUIPMENT

Manufacture	Model/ Equipment	Serial Number	Calibration Interval	Calibration Due
R&S	ESI40/ Spectrum Analyzer	831564/003	Annual	10/30/2010
Agilent	E4416A/ Power Meter	GB41291412	Annual	01/21/2010
Agilent	E9327A/ Power Sensor	MY4442009	Annual	07/28/2010
Agilent	8960 (E5515C)/ Base Station	GB44400269	Annual	02/10/2010
MITEQ	AMF-60-0010 1800-35-20P / AMP	1200937	Annual	05/20/2010
Wainwright	WHK1.2/15G-10EF/H.P.F	2	Annual	06/29/2010
Wainwright	WHK3.3/18G-10EF/H.P.F	1	Annual	06/29/2010
Agilent	775D/ Dual Directional Coupler	12922	Annual	12/24/2009
Agilent	11636B/ Power Divider	11377	Annual	12/24/2009
Digital	EP-3010/ Power Supply	3110117	Annual	01/07/2010
Schwarzbeck	UHAP/ Dipole Antenna	585	Annual	02/13/2011
Schwarzbeck	UHAP/ Dipole Antenna	558	Annual	02/13/2011
Korea Engineering	KR-1005L / Chamber	KRAB07063-2CH	Annual	12/31/2009
Schwarzbeck	BBHA 9120D/ Horn Antenna	147	Biennial	03/26/2010
Agilent	E4440A/Spectrum Analyzer	US45303008	Annual	12/23/2009



## 5. SUMMARY OF TEST RESULTS

FCC Part Section(s)	Test Description	Test Limit	Test Condition	Test Result
2.1049, 22.917(a), 24.238(a)	Occupied Bandwidth	N/A	CONDUCTED	PASS
2.1051, 22.917(a), 24.238(a)	Band Edge / Spurious and Harmonic Emissions at Antenna Terminal.	< 43 +10 log <sub>10</sub> (P[Watts]) at Band Edge and for all out-of-band emissions		PASS
2.1046	Conducted Output Power	N/A		PASS
24.232(d)	Peak- to- Average Ratio	< 13 dB		PASS
2.1055, 22.355, 24.235	Frequency stability / variation of ambient temperature	< 2.5 ppm		PASS
22.913(a)(2) 24.232(c)	Effective Radiated Power	< 7 Watts max. ERP	RADIATED	PASS
	Equivalent Isotropic Radiated Power	< 2 Watts max. EIRP		PASS
2.1053, 22.917(a), 24.238(a)	Radiated Spurious and Harmonic Emissions	< 43 + 10log <sub>10</sub> (P[Watts]) for all out-of band emissions		PASS



## 6. SAMPLE CALCULATION

### A. ERP Sample Calculation

Mode	Ch./ Freq.		Measured Level(dBm)	Substitute LEVEL(dBm)	Ant. Gain	C.L	Pol.	ERP	
	channel	Freq.(MHz)						W	dBm
GSM850	251	848.80	-7.58	28.59	2.83	1.20	H	1.05	30.22

**ERP = SubstituteLEVEL(dBm) + Ant. Gain – CL(Cable Loss)**

- 1) The EUT mounted on a wooden tripod is 0.8 meter above test site ground level.
- 2) During the test , the turn table is rotated and the antenna height is also varied from 1 to 4 meters until the maximum signal is found.
- 3) Record the field strength meter's level.
- 4) Replace the EUT with dipole/Horn antenna that is connected to a calibrated signal generator.
- 5) Increase the signal generator output till the field strength meter's level is equal to the item (3).
- 6) The signal generator output level with Ant. Gain and cable loss are the rating of effective radiated power (ERP).

## B. Emission Designator

### GSM Emission Designator

**Emission Designator = 249KGXW**

GSM BW = 249 kHz

G = Phase Modulation

X = Cases not otherwise covered

W = Combination (Audio/Data)

## 7. TEST DATA

### 7.1 Conducted Output Power

A base station simulator was used to establish communication with the EUT.

The base station simulator parameters were set to produce the maximum power from the EUT. This device was tested under all configurations and the highest power is reported. Conducted Output Powers of EUT are reported below.

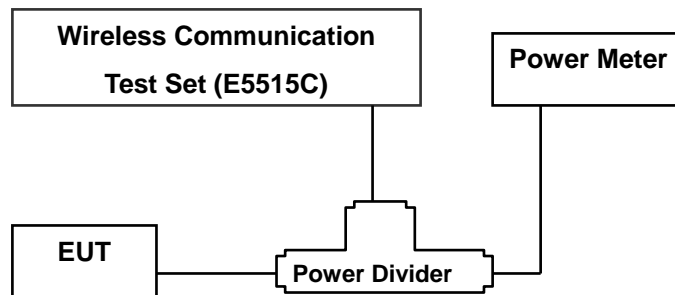

Sim 1

Band	Channel	Voice	GPRS Data	
		GSM (dBm)	GPRS 1 TX Slot (dBm)	GPRS 2 TX Slot (dBm)
GSM 850	128	32.03	32.01	31.99
	190	31.98	31.96	31.95
	251	31.93	31.92	31.90
GSM 1900	512	29.84	29.80	29.74
	661	29.82	29.79	29.73
	810	29.99	29.98	29.92

(GSM Conducted Maximum Output Powers)



### Sim 2

Band	Channel	Voice	GPRS Data	
		GSM (dBm)	GPRS 1 TX Slot (dBm)	GPRS 2 TX Slot (dBm)
GSM 850	128	32.01	32.00	31.98
	190	31.99	31.98	31.94
	251	31.94	31.93	31.92
GSM 1900	512	29.78	29.74	29.71
	661	29.79	29.74	29.72
	810	29.96	29.93	29.91

(GSM Conducted Maximum Output Powers)

Note : Detecting mode is average.

## 7.2 Peak-to-Average Ratio

Sim 1: - Plot of the EUT's Peak- to- Average Ratio is shown Page 35.

Sim 2: - Plot of the EUT's Peak- to- Average Ratio is shown Page 35.



### 7.3 Occupied Bandwidth

Sim 1

Band	Channel	Frequency(MHz)	Data (kHz)
GSM850	128	824.20	246.9208
	190	836.60	249.7246
	251	848.80	247.9869
GSM1900	512	1850.20	245.8126
	661	1880.00	244.7701
	810	1909.80	249.4291

- Plots of the EUT's Occupied Bandwidth are shown Page 29 ~ 31.

Sim 2

Band	Channel	Frequency(MHz)	Data (kHz)
GSM850	128	824.20	248.2462
	190	836.60	247.7299
	251	848.80	245.1087
GSM1900	512	1850.20	250.3417
	661	1880.00	247.0066
	810	1909.80	244.8216

- Plots of the EUT's Occupied Bandwidth are shown Page 32 ~ 34.



## 7.4 Conducted Spurious Emissions

Sim 1

Band	Channel	Frequency of Maximum Harmonic (GHz)	Maximum Data (dBm)
GSM850	128	7.0875	-31.73
	190	7.0500	-30.12
	251	7.3000	-30.12
GSM1900	512	13.2800	-27.94
	661	13.2000	-27.53
	810	14.2930	-27.91

- Plots of the EUT's Conducted Spurious Emissions are shown Page 40 ~ 45.

Sim 2

Band	Channel	Frequency of Maximum Harmonic (GHz)	Maximum Data (dBm)
GSM850	128	9.3000	-30.97
	190	7.1000	-30.47
	251	7.1375	-30.61
GSM1900	512	14.2130	-28.34
	661	13.6270	-28.10
	810	14.2930	-27.87

- Plots of the EUT's Conducted Spurious Emissions are shown Page 46 ~ 51.

### 7.4.1 Band Edge

Sim 1: - Plots of the EUT's Band Edge are shown Page 36 ~ 37.

Sim 2: - Plots of the EUT's Band Edge are shown Page 38 ~ 39.



## 7.5 Effective Radiated Power Output (E.R.P)(GSM850)

(GSM850 Mode)

### Sim 1

Mode	Ch./ Freq.		Measured Level(dBm)	Substitute LEVEL (dBm)	Ant. Gain (dBd)	C.L	Pol.	ERP	
	channel	Freq.(MHz)						W	dBm
GSM850	128	824.20	-6.40	39.44	-8.32	1.17	H	0.99	29.95
	190	836.60	-6.65	39.84	-8.22	1.19	H	1.10	30.43
	251	848.80	-7.46	39.66	-8.12	1.20	H	1.08	30.34

### Sim 2

Mode	Ch./ Freq.		Measured Level(dBm)	Substitute LEVEL (dBm)	Ant. Gain (dBd)	C.L	Pol.	ERP	
	channel	Freq.(MHz)						W	dBm
GSM850	128	824.20	-6.42	39.42	-8.32	1.17	H	0.98	29.93
	190	836.60	-6.68	39.81	-8.22	1.19	H	1.10	30.40
	251	848.80	-7.48	39.64	-8.12	1.20	H	1.08	30.32

Note: Standard batteries are the only options for this phone

#### NOTES:

Effective Radiated Power Output Measurements by Substitution Method

according to ANSI/TIA/EIA-603-C-2004, Aug. 17, 2004:

The EUT was placed on a wooden turn table 3-meters from the receive antenna. The receive antenna height and turntable rotation was adjusted for the highest reading on the receive spectrum analyzer. For CDMA signals, a peak detector is used, with RBW = VBW = 3 MHz. For WCDMA signals, a peak detector is used, with RBW = VBW = 5MHz. For AMPS, GSM, and NADC TDMA signals, a peak detector is used, with RBW = VBW = 1 MHz. A half-wave dipole was substituted in place of the EUT. This dipole antenna was driven by a signal generator and the level of the signal generator was adjusted to obtain the same receive spectrum analyzer reading. The conducted power at the terminals of the dipole is measured. The ERP is recorded.

This device was tested under all configurations and the highest power is reported in GSM mode and using a Power Control Level of "0" in the PCS Band and "5" in the Cellular Band. This unit was tested with its standard battery. **Also, we have done x, y, z planes in EUT and horizontal and vertical polarization in detecting antenna. The worst case of the EUT is in z plane in GSM850 mode. Also worst case of detecting Antenna is in horizontal polarization in GSM850 mode.**

FCC CERTIFICATION REPORT				<a href="http://www.hct.co.kr">www.hct.co.kr</a>
Test Report No. HCTR0912FR04-1	Date of Issue: December 22, 2009	EUT Type: Cellular/ PCS GSM Phone with Bluetooth	FCC ID: BEJGX200	Page 18 of 51



## 7.6 Equivalent Isotropic Radiated Power (E.I.R.P.) (GSM1900 )

(GSM1900 Mode)

Sim 1

Mode	Ch./ Freq.		Measured Level(dBm)	Substitute LEVEL (dBm)	Ant. Gain (dBi)	C.L	Pol.	EIRP	
	channel	Freq.(MHz)						W	dBm
GSM1900	512	1,850.20	-13.66	17.95	10.05	1.91	V	0.41	26.08
	661	1,880.00	-12.96	18.86	10.05	1.95	V	0.50	26.96
	810	1,909.80	-13.42	18.48	10.06	1.97	V	0.45	26.57

Sim 2

Mode	Ch./ Freq.		Measured Level(dBm)	Substitute LEVEL (dBm)	Ant. Gain (dBi)	C.L	Pol.	EIRP	
	channel	Freq.(MHz)						W	dBm
GSM1900	512	1,850.20	-13.48	18.13	10.05	1.91	V	0.42	26.26
	661	1,880.00	-12.84	18.98	10.05	1.95	V	0.51	27.08
	810	1,909.80	-13.79	18.11	10.06	1.97	V	0.42	26.20

Note: Standard batteries are the only options for this phone

### NOTES:

#### Equivalent Isotropic Radiated Power Measurements by Substitution Method

according to ANSI/TIA/EIA-603-C-2004, Aug. 17, 2004:

The EUT was placed on a wooden turn table 3-meters from the receive antenna. The receive antenna height and turntable rotation was adjusted for the highest reading on the receive spectrum analyzer. For CDMA signals, a peak detector is used, with RBW = VBW = 3 MHz. For WCDMA signals, a peak detector is used, with RBW = VBW = 5MHz. For AMPS, GSM, and NADC TDMA signals, a peak detector is used, with RBW = VBW = 1 MHz. A Horn antenna was substituted in place of the EUT. This Horn antenna was driven by a signal generator and the level of the signal generator was adjusted to obtain the same receive spectrum analyzer reading. The conducted power at the terminals of the Horn antenna is measured. The difference between the gain of the horn and an isotropic antenna is taken into consideration and the EIRP is recorded.

This device was tested under all configurations and the highest power is reported in GSM mode and using a Power Control Level of "0" in the PCS Band and "5" in the Cellular Band. This unit was tested with its standard battery. **Also, we have done x, y, z planes in EUT and horizontal and vertical polarization in detecting antenna. The worst case of the EUT is in z plane in GSM1900 mode. Also worst case of detecting Antenna is in vertical polarization in GSM1900 mode.**

FCC CERTIFICATION REPORT				<a href="http://www.hct.co.kr">www.hct.co.kr</a>
Test Report No. HCTR0912FR04-1	Date of Issue: December 22, 2009	EUT Type: Cellular/ PCS GSM Phone with Bluetooth	FCC ID: BEJGX200	Page 19 of 51



## 7.7 Radiated Spurious Emissions

### 7.7.1 Radiated Spurious Emissions (GSM850 Mode)

Sim 1

- MEASURED OUTPUT POWER: 30.43 dBm = 1.104 W
- MODULATION SIGNAL: GSM850
- DISTANCE: 3 meters
- LIMIT:  $-(43 + 10 \log_{10}(W)) =$  - 43.43 dBc

Ch.	Freq.(MHz)	Measured Level [dBm]	Ant. Gain (dBd)	Substitute Level [dBm]	C.L	Pol.	ERP (dBm)	dBc
128	1,648.40	-43.16	7.09	-53.69	1.73	H	-48.33	-78.76
	2,472.60	-49.08	8.12	-56.19	2.28	H	-50.35	-80.78
	3,296.80	-48.73	9.72	-56.31	2.57	H	-49.16	-79.59
190	1,673.20	-44.73	7.23	-55.49	1.79	H	-50.05	-80.48
	2,509.80	-51.47	8.14	-58.60	2.33	H	-52.79	-83.22
	3,346.40	-49.47	9.99	-57.50	2.66	H	-50.17	-80.60
251	1,697.60	-42.54	7.41	-53.15	1.83	H	-47.57	-78.00
	2,549.40	-53.59	8.21	-60.87	2.34	H	-55.00	-85.43
	3,395.20	-47.58	9.91	-55.21	2.85	H	-48.15	-78.58

- NOTES:**
1. Radiated Spurious Emission Measurements at 3 meters by Substitution Method according to ANSI/TIA/EIA-603-C-2004, Aug. 17, 2004:
  2. The magnitude of spurious emissions attenuated more than 20dB below the limit above 5<sup>th</sup> Harmonic for all channel.
  3. we have done x, y, z planes in EUT and horizontal and vertical polarization in detecting antenna.



Sim 2

- MEASURED OUTPUT POWER: 30.40 dBm = 1.096 W
- MODULATION SIGNAL: GSM850
- DISTANCE: 3 meters
- LIMIT: - (43 + 10 log<sub>10</sub> (W)) = - 43.40 dBc

Ch.	Freq.(MHz)	<u>Measured Level</u> [dBm]	Ant. Gain (dBd)	<u>Substitute</u> <u>Level</u> [dBm]	C.L	Pol.	ERP (dBm)	dBc
128	1,648.40	-46.02	7.09	-56.55	1.73	H	-51.19	-81.59
	2,472.60	-51.74	8.12	-58.85	2.28	H	-53.01	-83.41
	3,296.80	-49.05	9.72	-56.63	2.57	H	-49.48	-79.88
190	1,673.20	-45.27	7.23	-56.03	1.79	H	-50.59	-80.99
	2,509.80	-51.69	8.14	-58.82	2.33	H	-53.01	-83.41
	3,346.40	-49.80	9.99	-57.83	2.66	H	-50.50	-80.90
251	1,697.60	-41.70	7.41	-52.31	1.83	H	-46.73	-77.13
	2,549.40	-52.14	8.21	-59.42	2.34	H	-53.55	-83.95
	3,395.20	-48.41	9.91	-56.04	2.85	H	-48.98	-79.38

- NOTES:**
1. Radiated Spurious Emission Measurements at 3 meters by Substitution Method according to ANSI/TIA/EIA-603-C-2004, Aug. 17, 2004:
  2. The magnitude of spurious emissions attenuated more than 20dB below the limit above 5<sup>th</sup> Harmonic for all channel.
  3. we have done x, y, z planes in EUT and horizontal and vertical polarization in detecting antenna.



### 7.7.2 Radiated Spurious Emissions (GSM1900 Mode)

Sim 1

- MEASURED OUTPUT POWER: 26.96 dBm = 0.497 W
- MODULATION SIGNAL: GSM1900
- DISTANCE: 3 meters
- LIMIT: - (43 + 10 log<sub>10</sub> (W)) = -39.96 dBc

Ch.	Freq.(MHz)	Measured Level [dBm]	Ant. Gain (dBi)	Substitute Level [dBm]	C.L	Pol.	EIRP (dBm)	dBc
512	3,700.40	-25.15	12.46	-31.42	2.73	H	-21.69	-48.65
	5,550.60	-44.97	12.70	-46.55	3.60	V	-37.45	-64.41
	7,400.80	-41.89	11.36	-33.01	3.88	V	-25.53	-52.49
661	3,760.00	-22.87	12.47	-28.84	2.73	H	-19.10	-46.06
	5,640.00	-45.77	10.60	-45.27	3.60	V	-38.27	-65.23
	7,520.00	-47.19	11.33	-38.09	3.88	V	-30.64	-57.60
810	3,819.60	-22.00	12.49	-27.88	2.73	H	-18.12	-45.08
	5,729.40	-44.95	12.80	-46.26	3.60	H	-37.06	-64.02
	7,639.20	-44.47	11.30	-35.14	3.88	H	-27.72	-54.68

- NOTES:**
1. Radiated Spurious Emission Measurements at 3 meters by Substitution Method according to ANSI/TIA/EIA-603-C-2004, Aug. 17, 2004:
  2. The magnitude of spurious emissions attenuated more than 20dB below the limit above 5<sup>th</sup> Harmonic for all channel.
  3. we have done x, y, z planes in EUT and horizontal and vertical polarization in detecting antenna.



Sim 2

- MEASURED OUTPUT POWER: 27.08 dBm = 0.511 W
- MODULATION SIGNAL: GSM1900
- DISTANCE: 3 meters
- LIMIT: - (43 + 10 log<sub>10</sub> (W)) = -40.08 dBc

Ch.	Freq.(MHz)	Measured Level [dBm]	Ant. Gain (dBi)	Substitute Level [dBm]	C.L	Pol.	EIRP (dBm)	dBc
512	3,700.40	-25.80	12.46	-32.07	2.73	H	-22.34	-49.42
	5,550.60	-46.79	12.70	-48.37	3.60	V	-39.27	-66.35
	7,400.80	-40.05	11.36	-31.17	3.88	H	-23.69	-50.77
661	3,760.00	-24.11	12.47	-30.08	2.73	H	-20.34	-47.42
	5,640.00	-46.19	10.60	-45.69	3.60	V	-38.69	-65.77
	7,520.00	-45.73	11.33	-36.63	3.88	V	-29.18	-56.26
810	3,819.60	-23.95	12.49	-29.83	2.73	H	-20.07	-47.15
	5,729.40	-45.38	12.80	-46.69	3.60	V	-37.49	-64.57
	7,639.20	-42.20	11.30	-32.87	3.88	H	-25.45	-52.53

- NOTES:**
1. Radiated Spurious Emission Measurements at 3 meters by Substitution Method according to ANSI/TIA/EIA-603-C-2004, Aug. 17, 2004:
  2. The magnitude of spurious emissions attenuated more than 20dB below the limit above 5<sup>th</sup> Harmonic for all channel.
  3. we have done x, y, z planes in EUT and horizontal and vertical polarization in detecting antenna.



## 7.8 Frequency stability / variation of ambient temperature

### 7.8.1 FREQUENCY STABILITY (GSM850)

Sim 1

OPERATING FREQUENCY: 836,600,000 Hz  
 CHANNEL: 190  
 REFERENCE VOLTAGE: 3.7 VDC  
 DEVIATION LIM IT: ± 0.000 25 % or 2.5 ppm

Voltage (%)	Power (VDC)	Temp. (°C)	Frequency (Hz)	Frequency Error (Hz)	Deviation (%)	ppm
100%	3.700	+20(Ref)	836 600 015	14.71	0.000 002	0.018
100%		-30	836 600 011	11.20	0.000 001	0.013
100%		-20	836 600 009	9.06	0.000 001	0.011
100%		-10	836 600 005	4.62	0.000 001	0.006
100%		0	836 600 012	12.42	0.000 001	0.015
100%		+10	836 599 995	-4.69	-0.000 001	-0.006
100%		+20	836 600 015	15.00	0.000 002	0.018
100%		+30	836 599 990	-9.71	-0.000 001	-0.012
100%		+40	836 600 008	7.52	0.000 001	0.009
100%		+50	836 599 992	-8.18	-0.000 001	-0.010
115%	4.255	+20	836 599 988	-12.46	-0.000 001	-0.015
Batt. Endpoint	3.400	+20	836 600 005	5.26	0.000 001	0.006

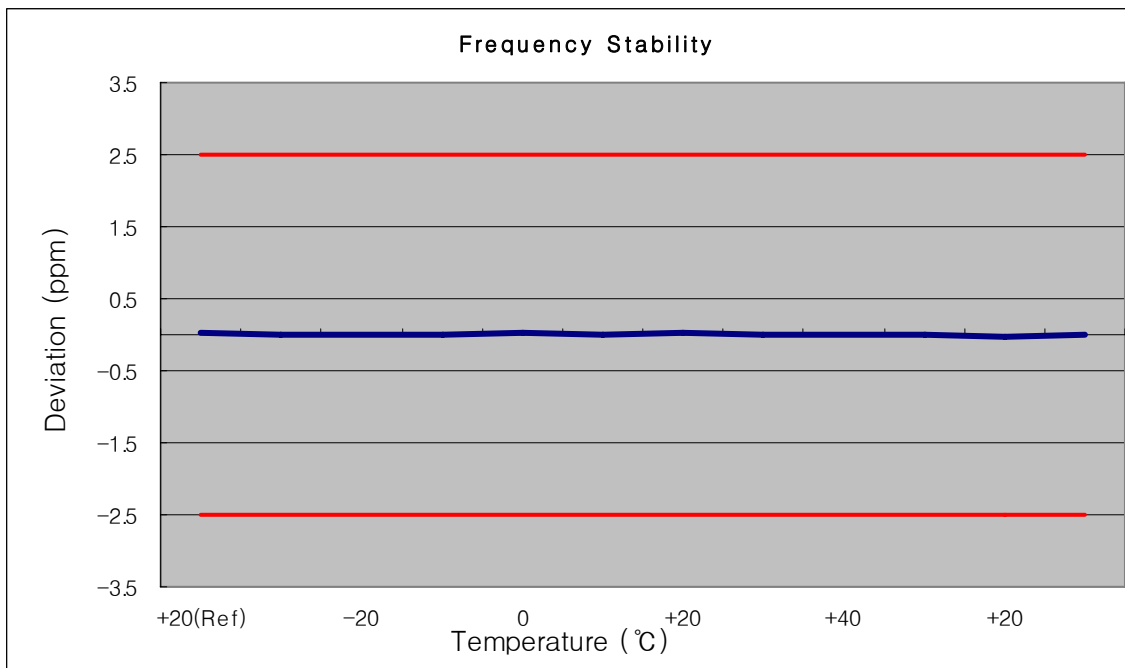



Sim 2

OPERATING FREQUENCY: 836,600,000 Hz  
 CHANNEL: 190  
 REFERENCE VOLTAGE: 3.7 VDC  
 DEVIATION LIM IT: ± 0.000 25 % or 2.5 ppm

Voltage (%)	Power (VDC)	Temp. (°C)	Frequency (Hz)	Frequency Error (Hz)	Deviation (%)	ppm
100%	3.700	+20(Ref)	836 600 011	10.83	0.000 001	0.013
100%		-30	836 600 008	7.68	0.000 001	0.009
100%		-20	836 600 012	11.71	0.000 001	0.014
100%		-10	836 600 007	6.82	0.000 001	0.008
100%		0	836 600 015	14.62	0.000 002	0.017
100%		+10	836 599 995	-5.19	-0.000 001	-0.006
100%		+20	836 600 009	8.91	0.000 001	0.011
100%		+30	836 599 989	-10.68	-0.000 001	-0.013
100%		+40	836 600 012	11.64	0.000 001	0.014
100%		+50	836 599 991	-9.10	-0.000 001	-0.011
115%	4.255	+20	836 599 992	-8.06	-0.000 001	-0.010
Batt. Endpoint	3.400	+20	836 600 005	4.97	0.000 001	0.006

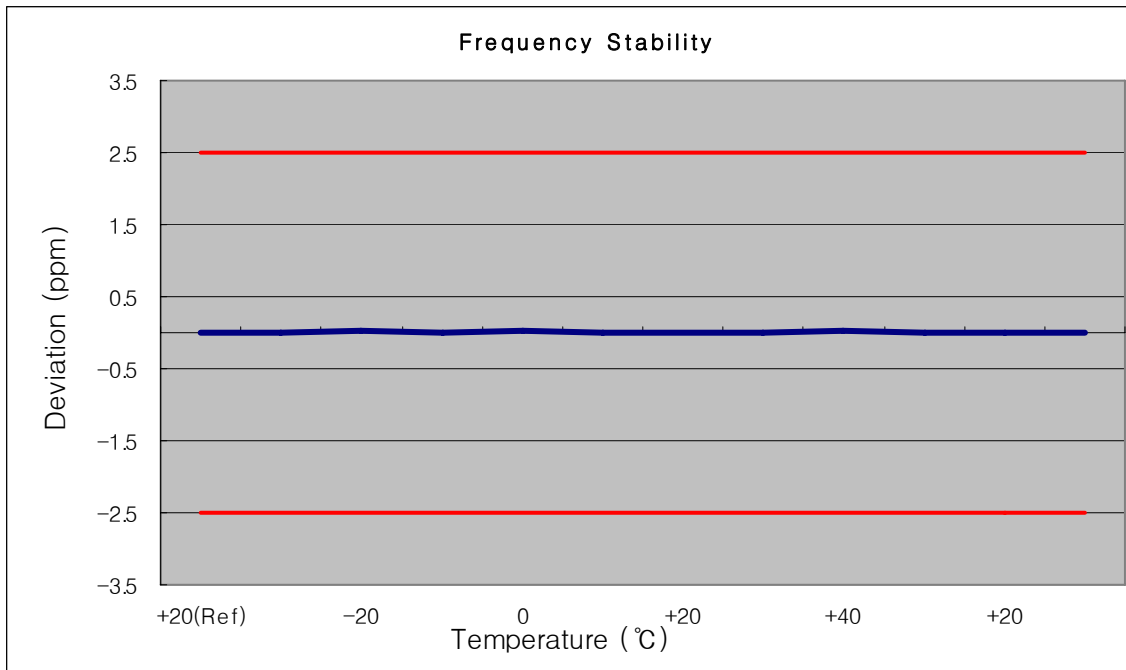



**7.8.2 FREQUENCY STABILITY (GSM1900)**

Sim 1

OPERATING FREQUENCY: 1880,000,000 Hz  
 CHANNEL: 661  
 REFERENCE VOLTAGE: 3.7 VDC  
 DEVIATION LIM IT: ± 0.000 25 % or 2.5 ppm

Voltage (%)	Power (VDC)	Temp. (°C)	Frequency (Hz)	Frequency Error (Hz)	Deviation (%)	ppm
100%	3.700	+20(Ref)	1879 999 976	-23.77	-0.000 001	-0.013
100%		-30	1879 999 986	-13.88	-0.000 001	-0.007
100%		-20	1879 999 994	-6.49	0.000 000	-0.003
100%		-10	1879 999 983	-16.73	-0.000 001	-0.009
100%		0	1880 000 002	1.57	0.000 000	0.001
100%		+10	1880 000 004	4.06	0.000 000	0.002
100%		+20	1879 999 976	-24.28	-0.000 001	-0.013
100%		+30	1879 999 995	-4.83	0.000 000	-0.003
100%		+40	1880 000 009	8.97	0.000 000	0.005
100%		+50	1879 999 981	-18.69	-0.000 001	-0.010
115%	4.255	+20	1879 999 980	-19.61	-0.000 001	-0.010
Batt. Endpoint	3.400	+20	1879 999 999	-1.16	0.000 000	-0.001

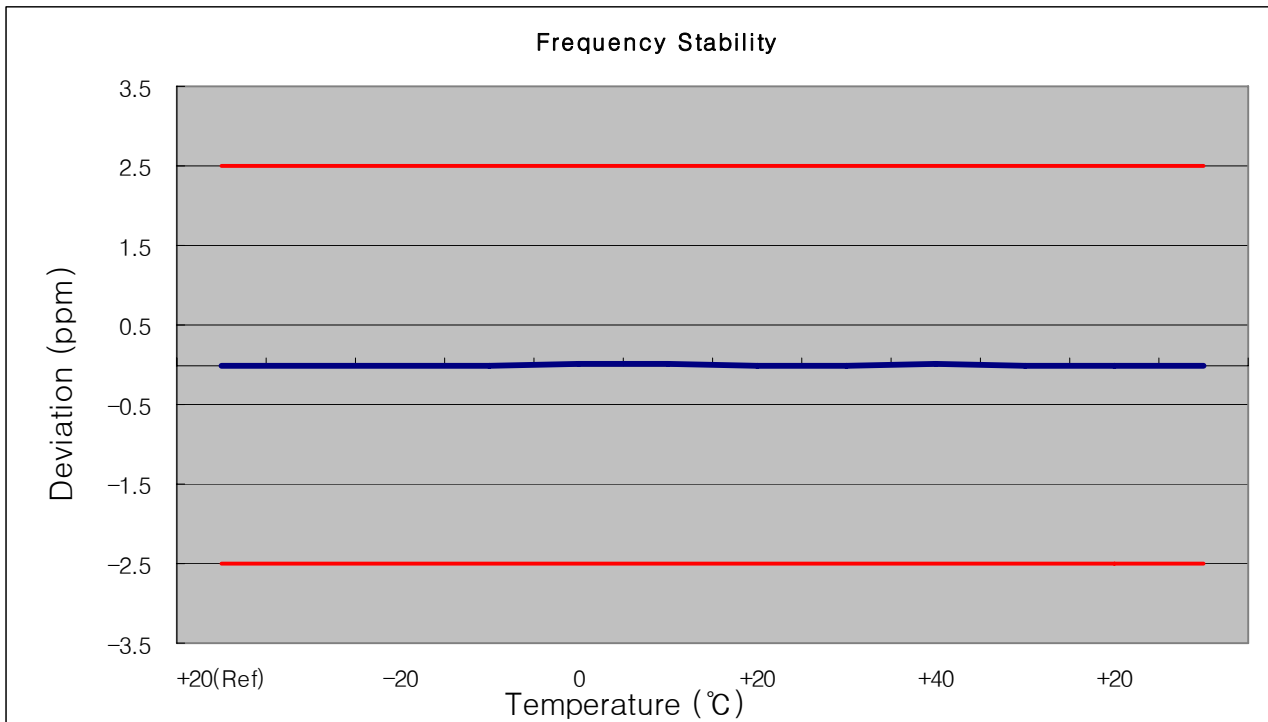



Sim 2

OPERATING FREQUENCY: 1880,000,000 Hz  
 CHANNEL: 661  
 REFERENCE VOLTAGE: 3.7 VDC  
 DEVIATION LIM IT: ± 0.000 25 % or 2.5 ppm

Voltage (%)	Power (VDC)	Temp. (°C)	Frequency (Hz)	Frequency Error (Hz)	Deviation (%)	ppm
100%	3.700	+20(Ref)	1879 999 982	-18.32	-0.000 001	-0.010
100%		-30	1879 999 980	-19.61	-0.000 001	-0.010
100%		-20	1879 999 983	-17.50	-0.000 001	-0.009
100%		-10	1879 999 997	-3.37	0.000 000	-0.002
100%		0	1879 999 982	-17.64	-0.000 001	-0.009
100%		+10	1880 000 005	4.89	0.000 000	0.003
100%		+20	1879 999 980	-20.11	-0.000 001	-0.011
100%		+30	1879 999 987	-13.05	-0.000 001	-0.007
100%		+40	1879 999 983	-17.29	-0.000 001	-0.009
100%		+50	1880 000 007	6.68	0.000 000	0.004
115%	4.255	+20	1879 999 978	-21.73	-0.000 001	-0.012
Batt. Endpoint	3.400	+20	1879 999 999	-1.30	0.000 000	-0.001

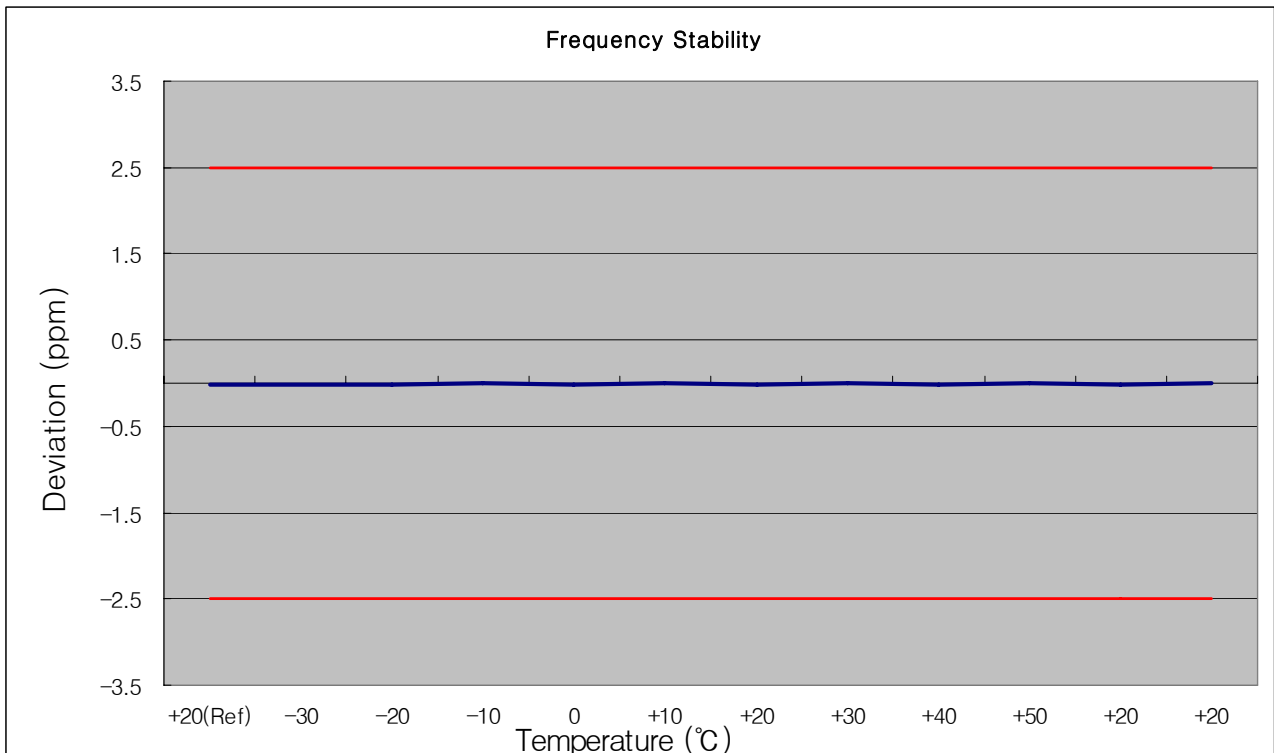



## 8. TEST PLOTS

FCC CERTIFICATION REPORT				<a href="http://www.hct.co.kr">www.hct.co.kr</a>
<b>Test Report No.</b> HCTR0912FR04-1	<b>Date of Issue:</b> December 22, 2009	<b>EUT Type:</b> Cellular/ PCS GSM Phone with Bluetooth	<b>FCC ID:</b> BEJGX200	Page 28 of 51

Sim 1

■ GSM850 MODE (128 CH.) Occupied Bandwidth

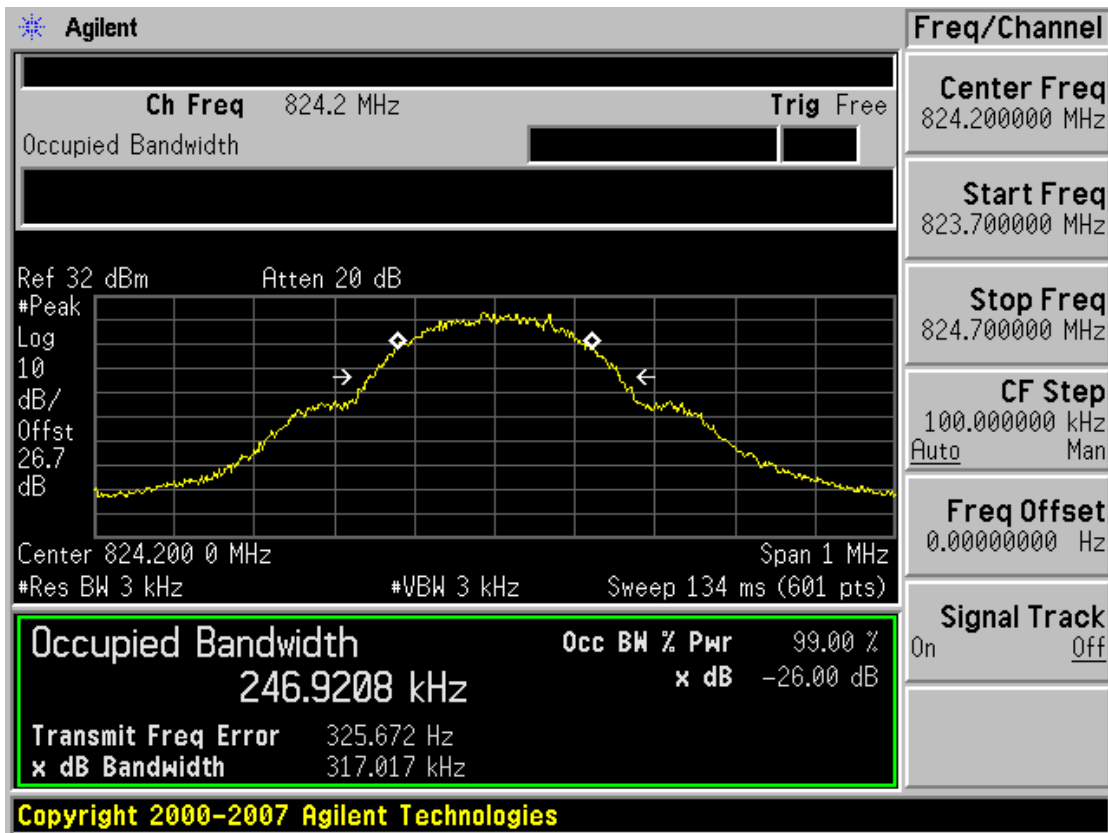

■ GSM850 MODE (190 CH.) Occupied Bandwidth



■ GSM850 MODE (251 CH.) Occupied Bandwidth

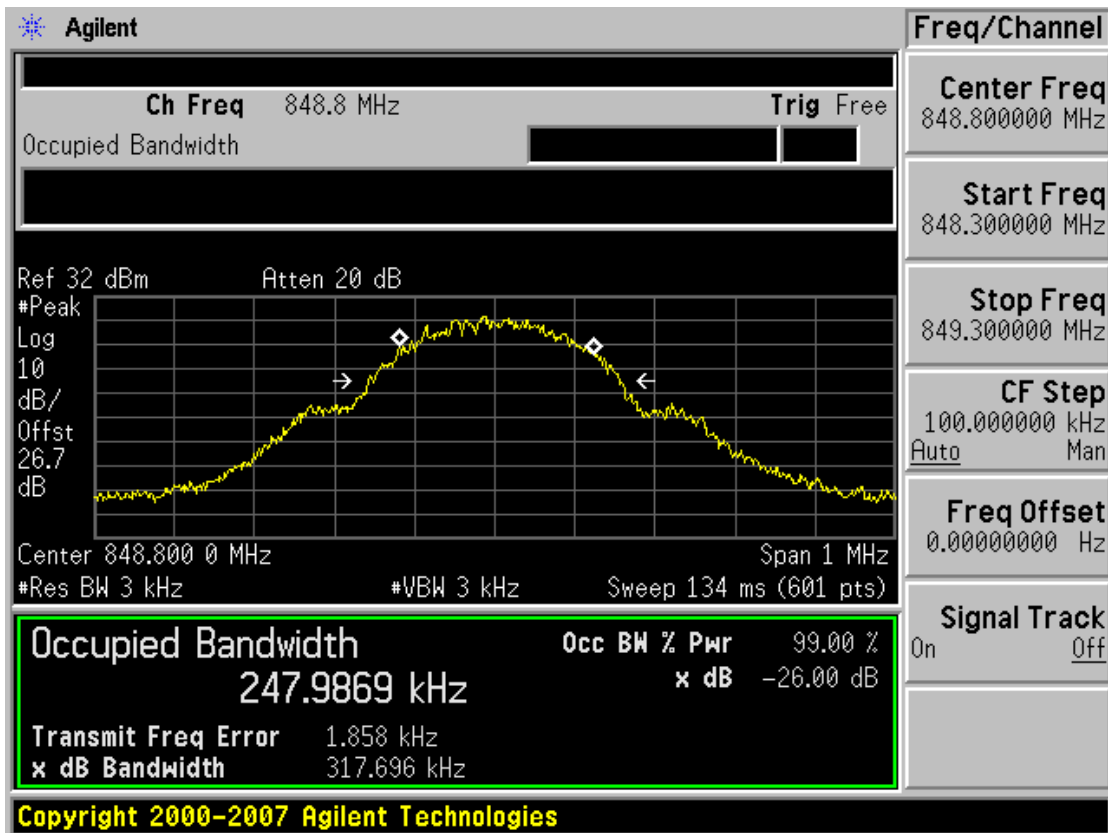

■ GSM1900 MODE (512 CH.) Occupied Bandwidth

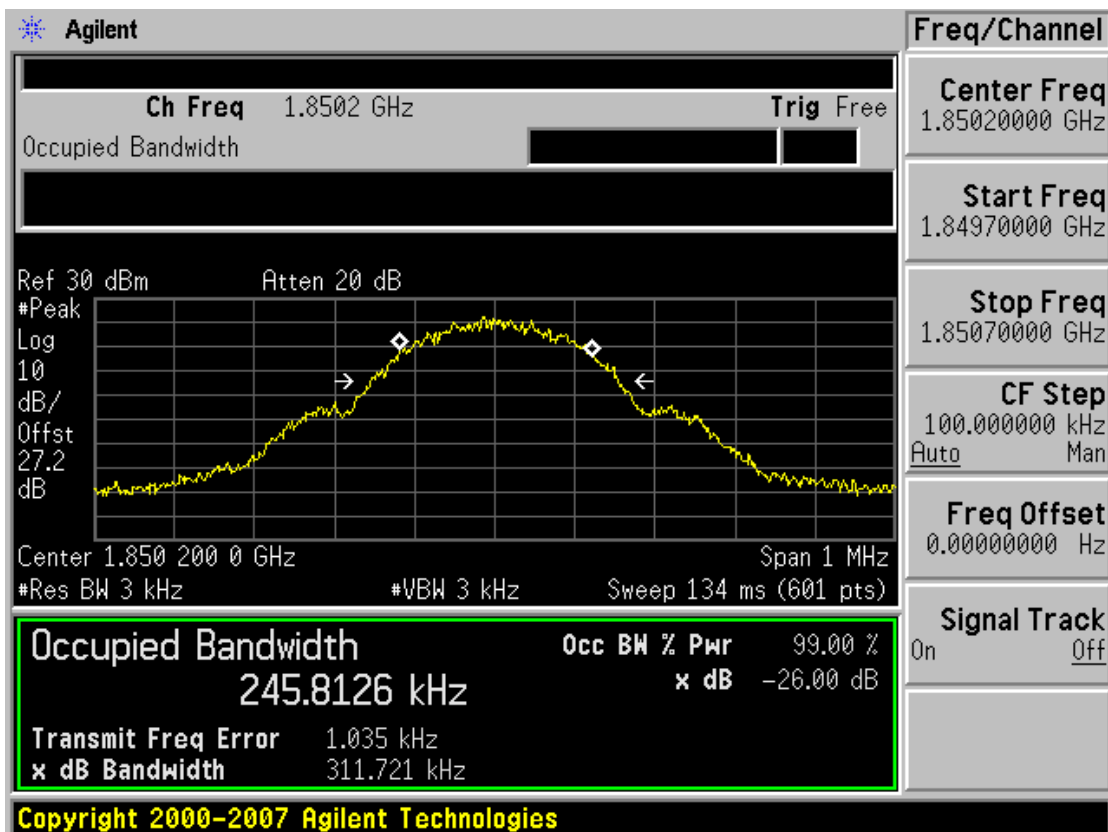

■ GSM1900 MODE (661 CH.) Occupied Bandwidth

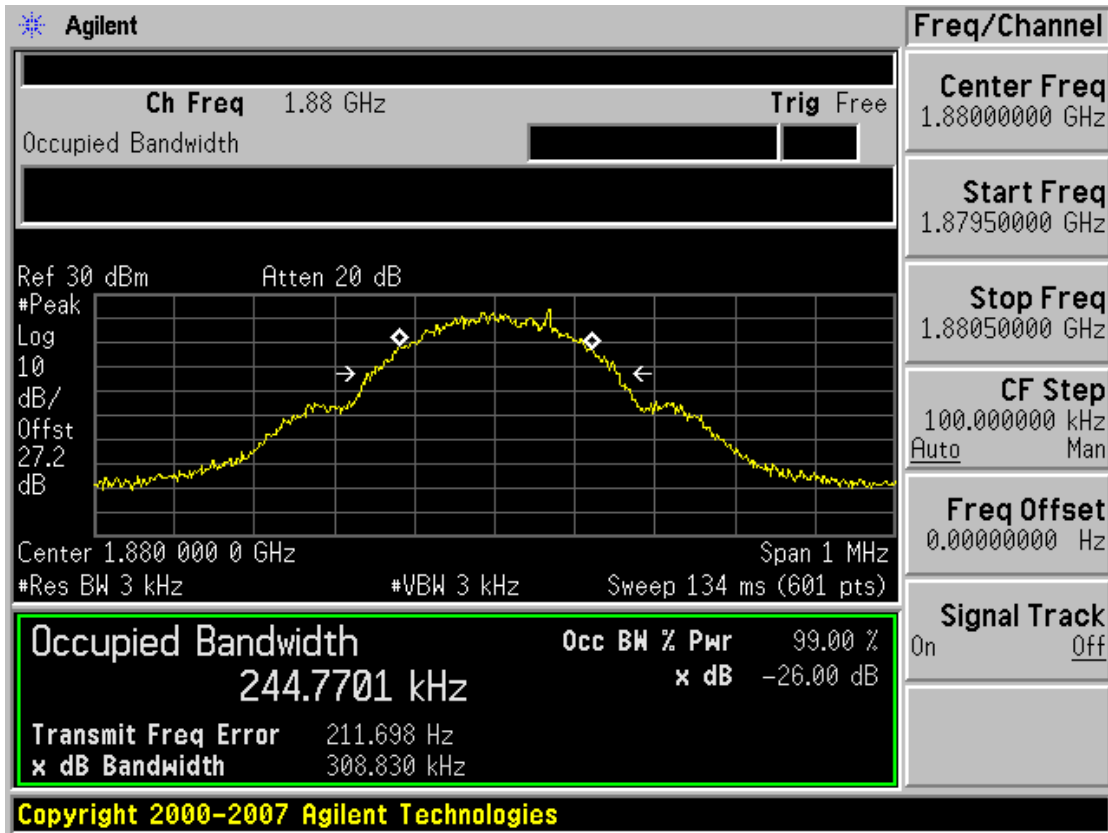

■ GSM1900 MODE (810 CH.) Occupied Bandwidth

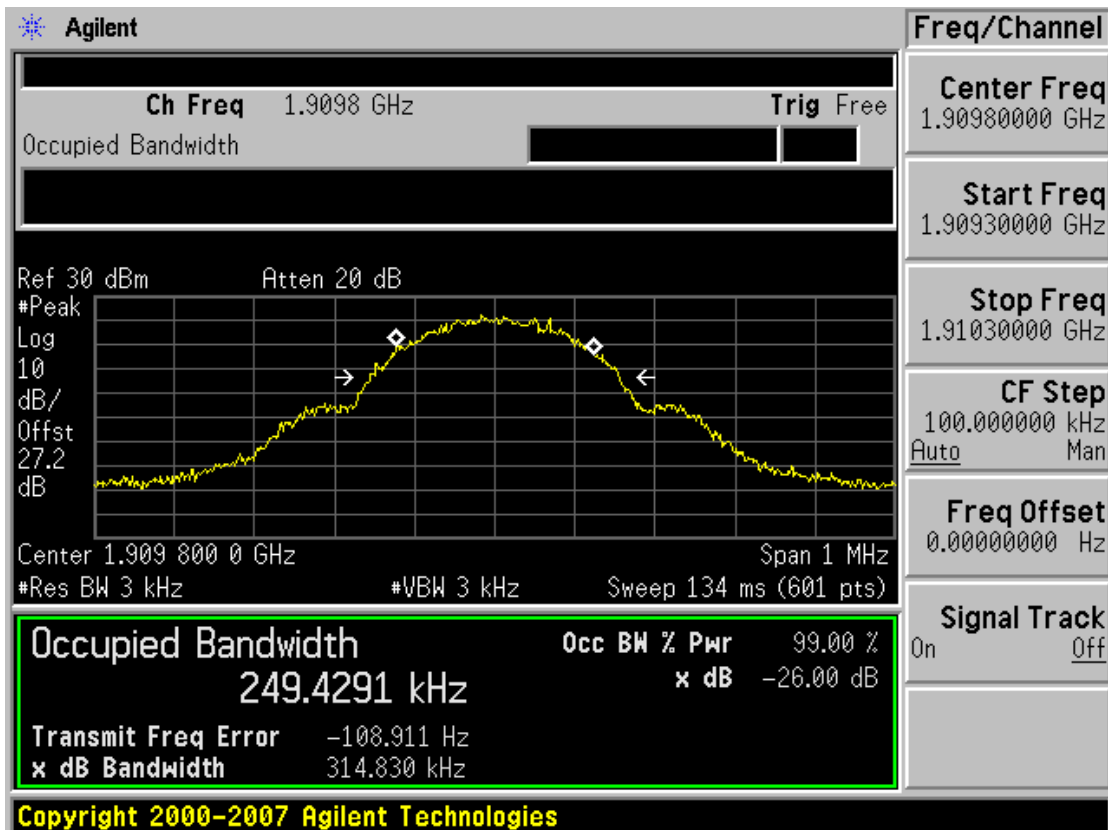

Sim 2

■ GSM850 MODE (128 CH.) Occupied Bandwidth

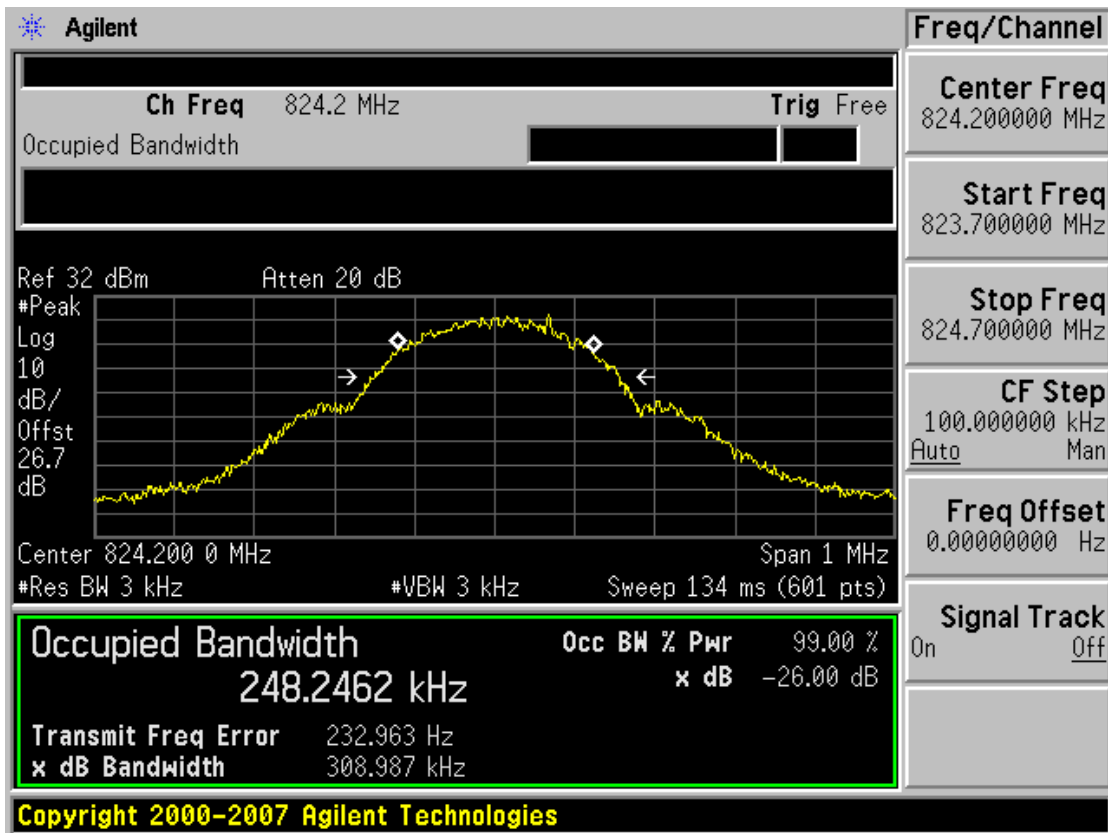

■ GSM850 MODE (190 CH.) Occupied Bandwidth



■ GSM850 MODE (251 CH.) Occupied Bandwidth

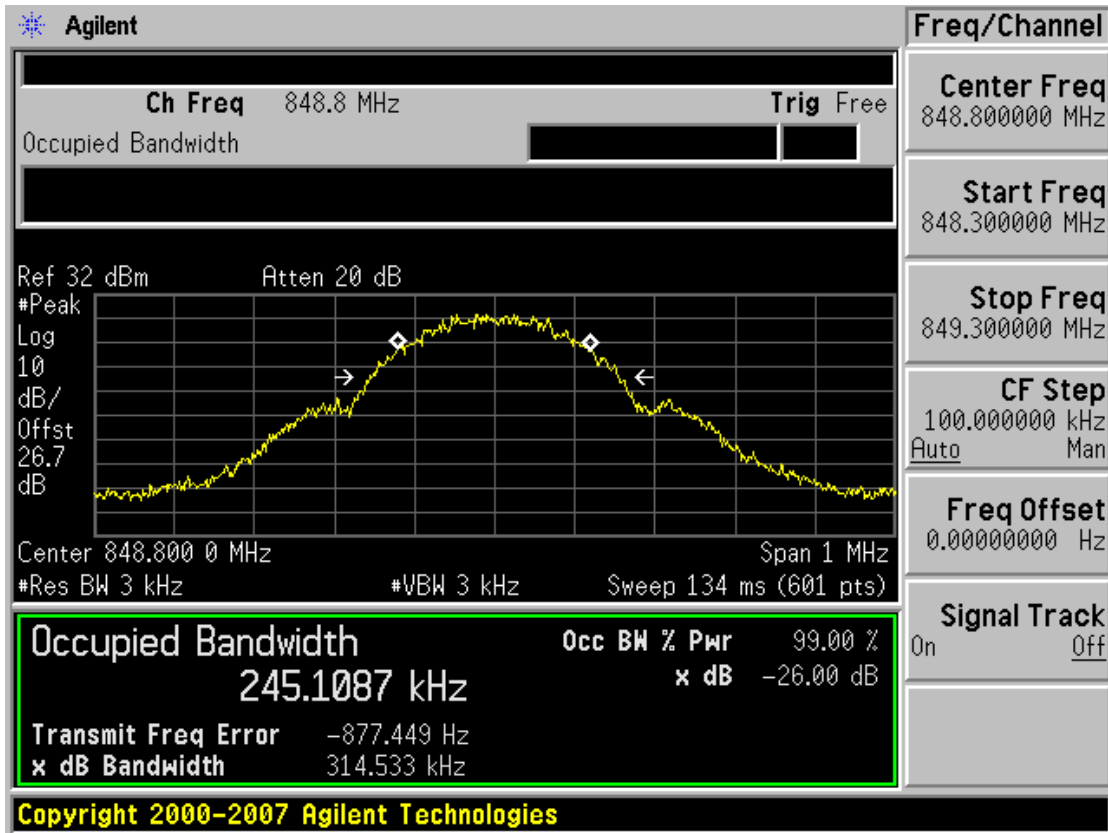

■ GSM1900 MODE (512 CH.) Occupied Bandwidth

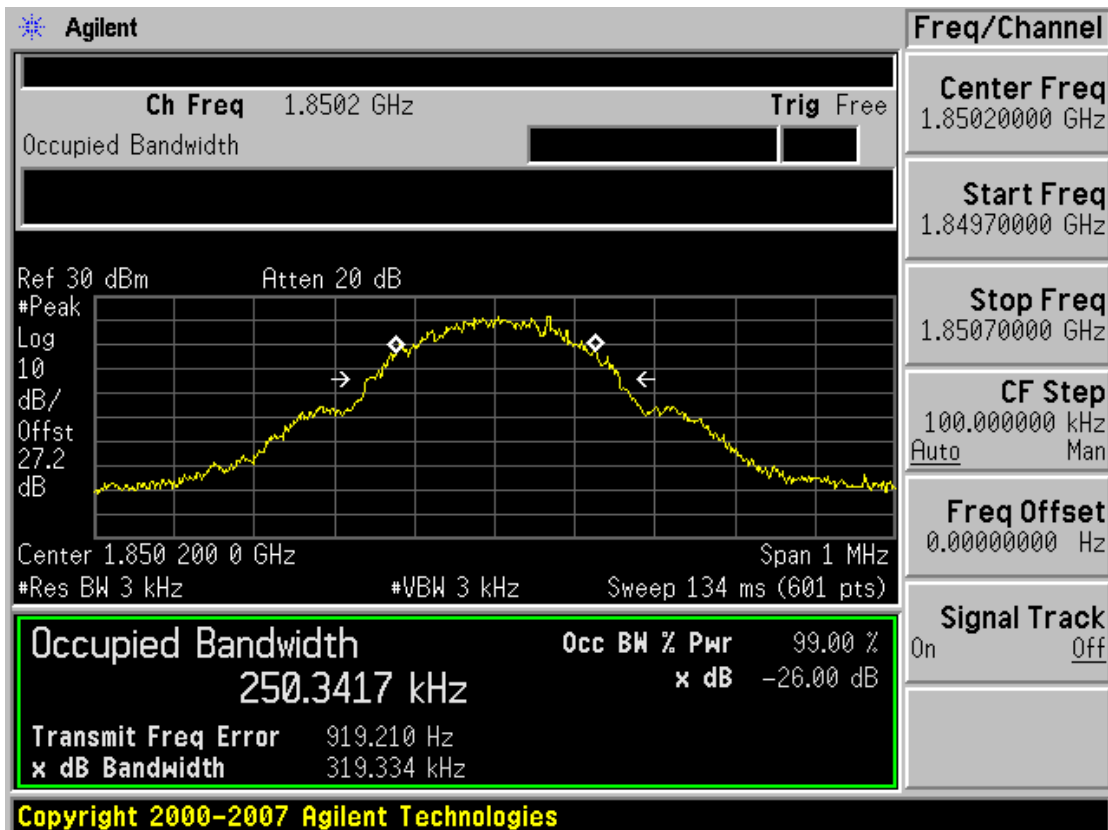

■ GSM1900 MODE (661 CH.) Occupied Bandwidth

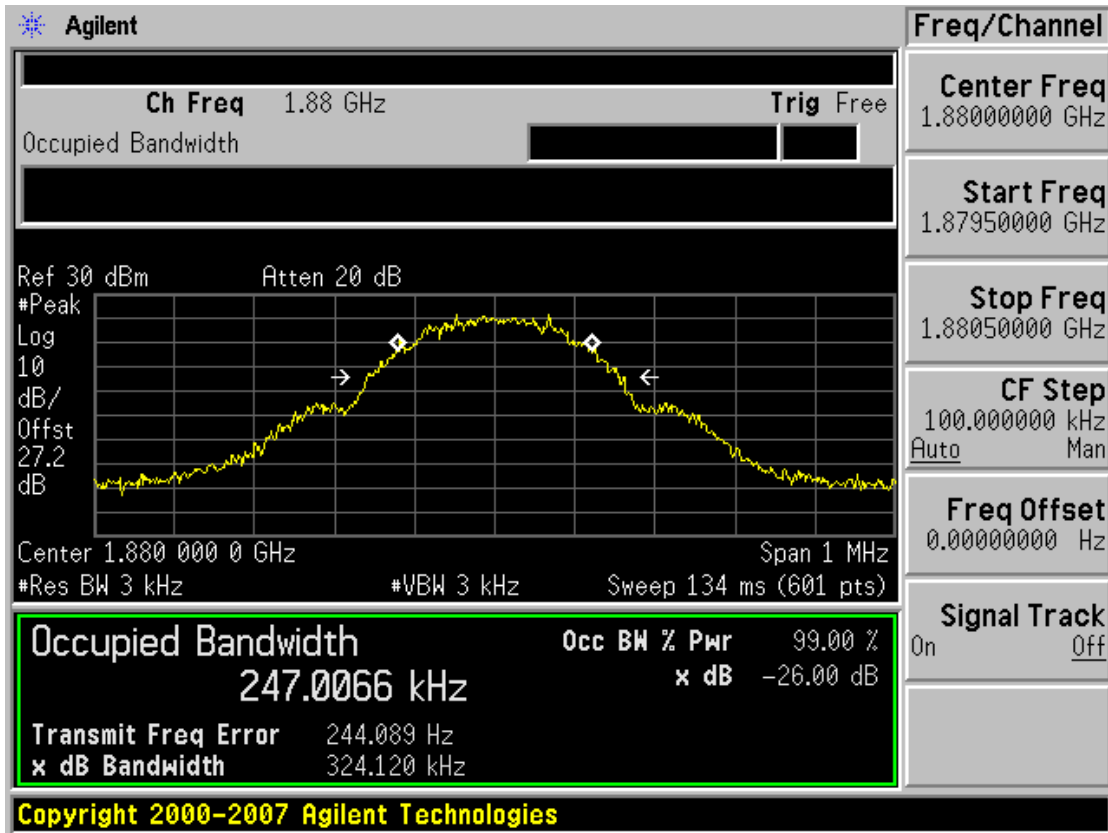

■ GSM1900 MODE (810 CH.) Occupied Bandwidth



Sim 1

■ GSM1900 MODE (661 CH.) Peak-to-Average Ratio

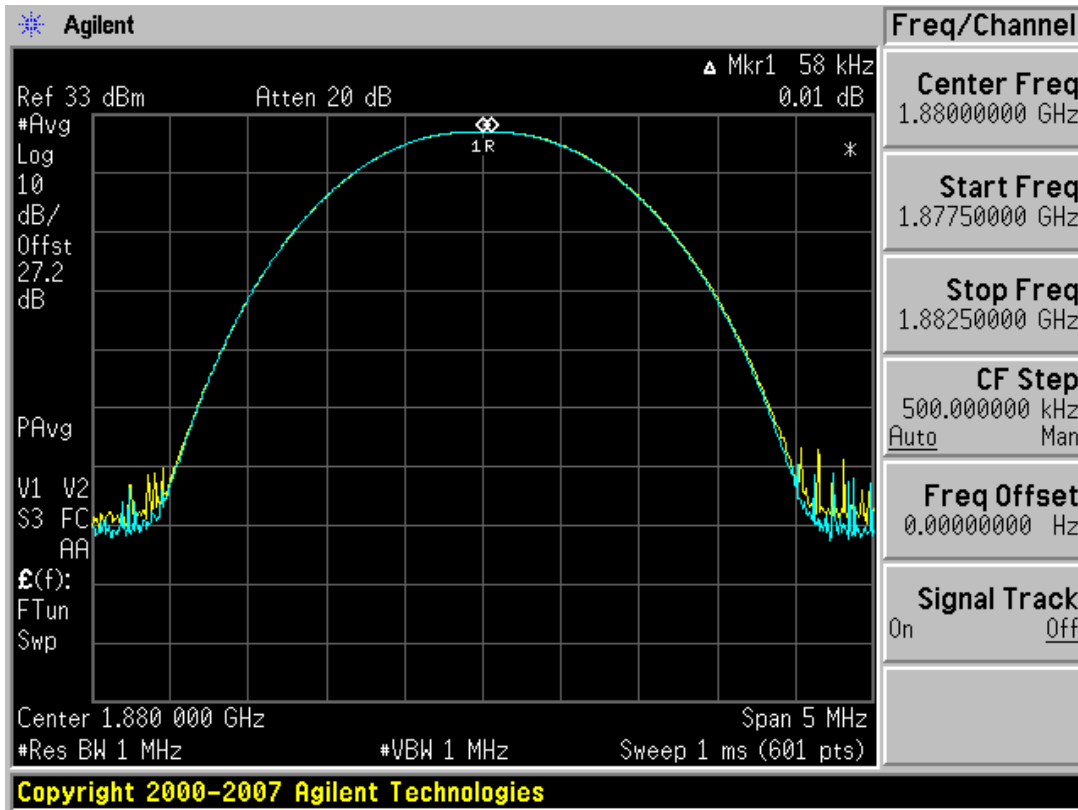

Sim 2

■ GSM1900 MODE (661 CH.) Peak-to-Average Ratio

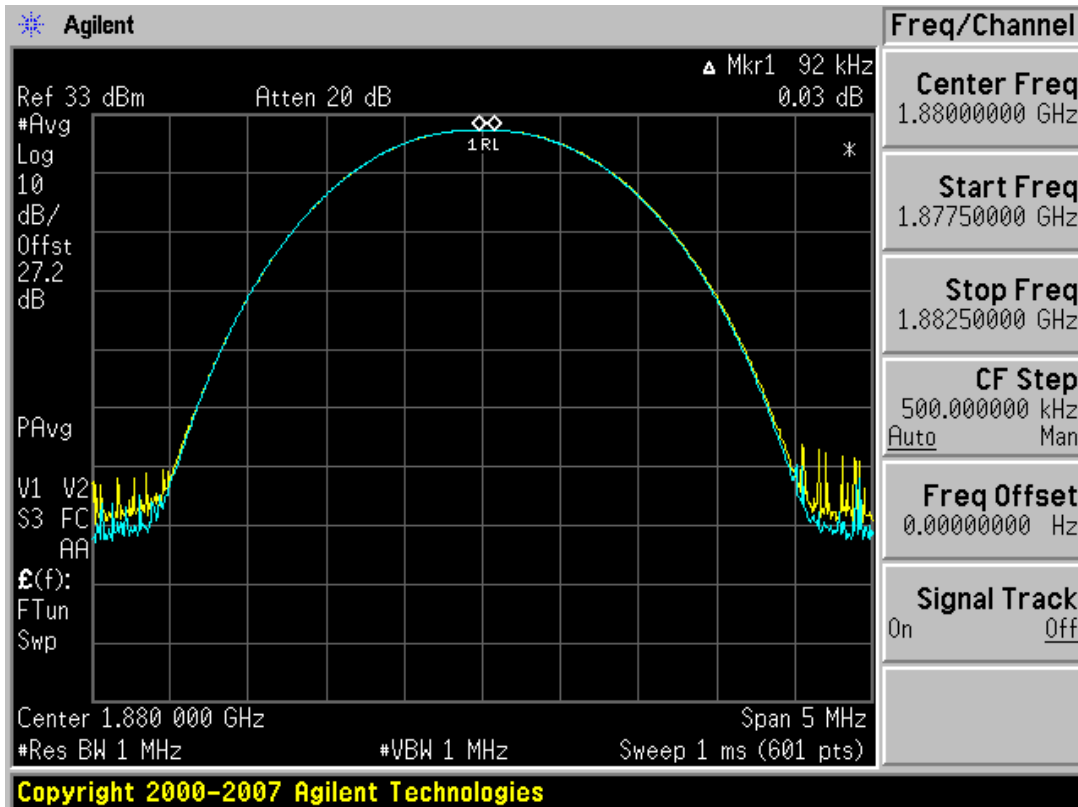

FCC CERTIFICATION REPORT

Sim 1

■ GSM850 MODE (128 CH.) Block Edge

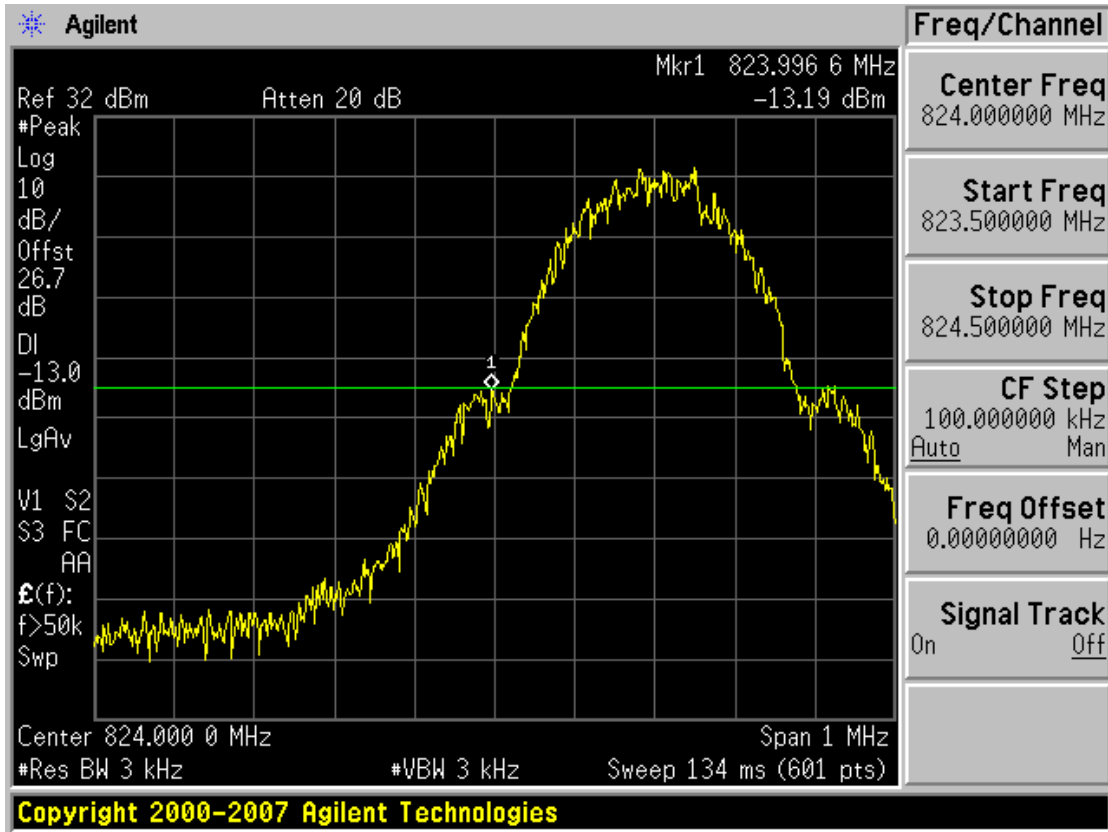

■ GSM850 MODE (251 CH.) Block Edge

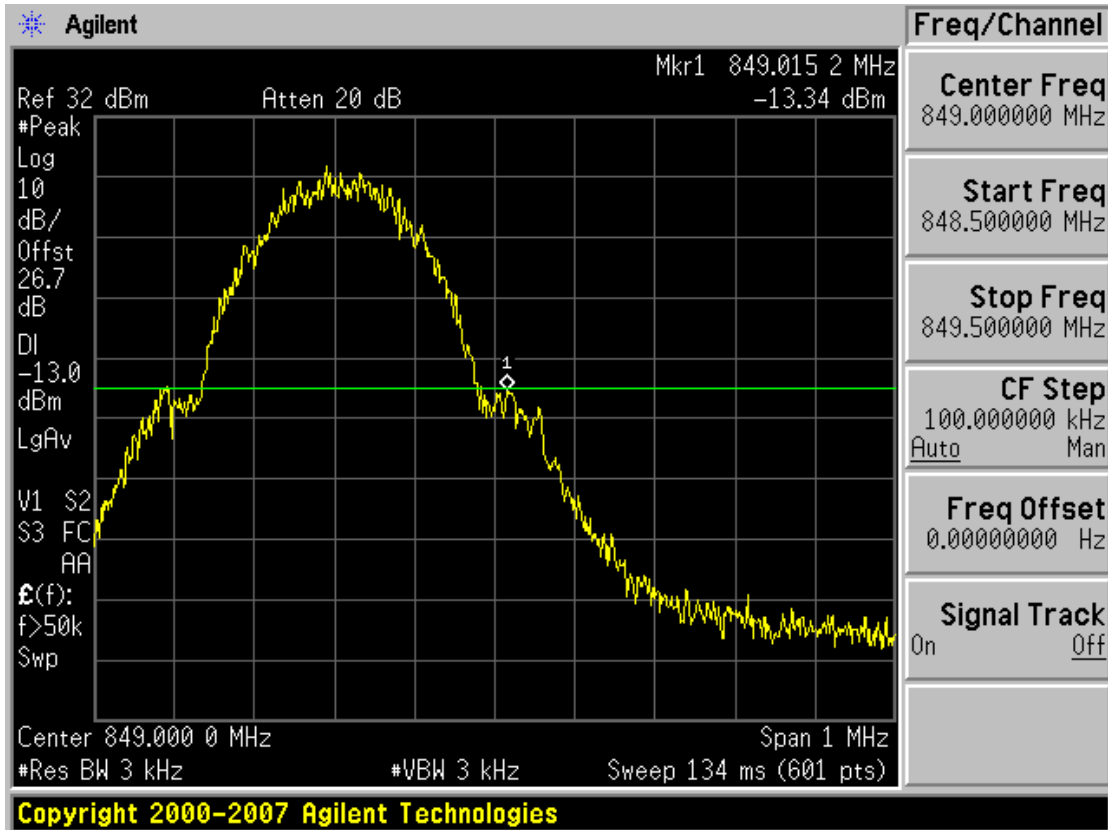

FCC CERTIFICATION REPORT

[www.hct.co.kr](http://www.hct.co.kr)

Test Report No. HCTR0912FR04-1	Date of Issue: December 22, 2009	EUT Type: Cellular/ PCS GSM Phone with Bluetooth	FCC ID: BEJGX200	Page 36 of 51
-----------------------------------	-------------------------------------	---	---------------------	---------------

■ GSM1900 MODE (512 CH.) Block Edge

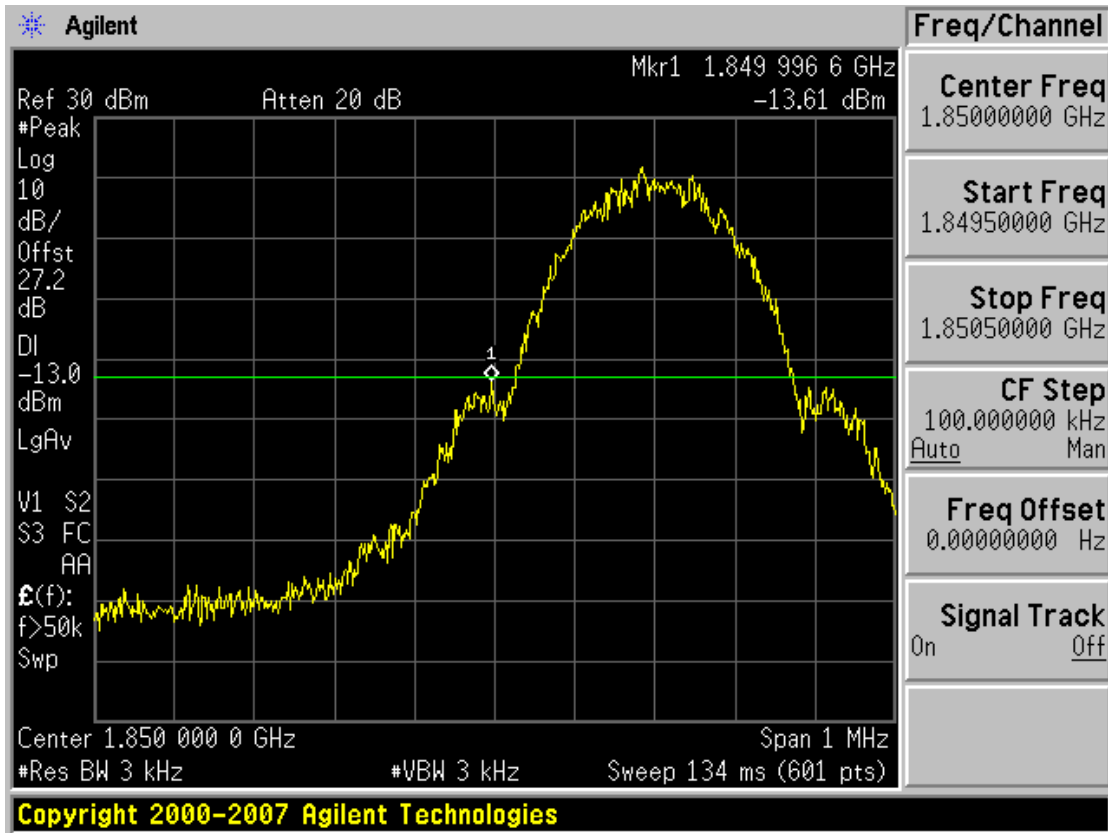

■ GSM1900 MODE (810 CH.) Block Edge

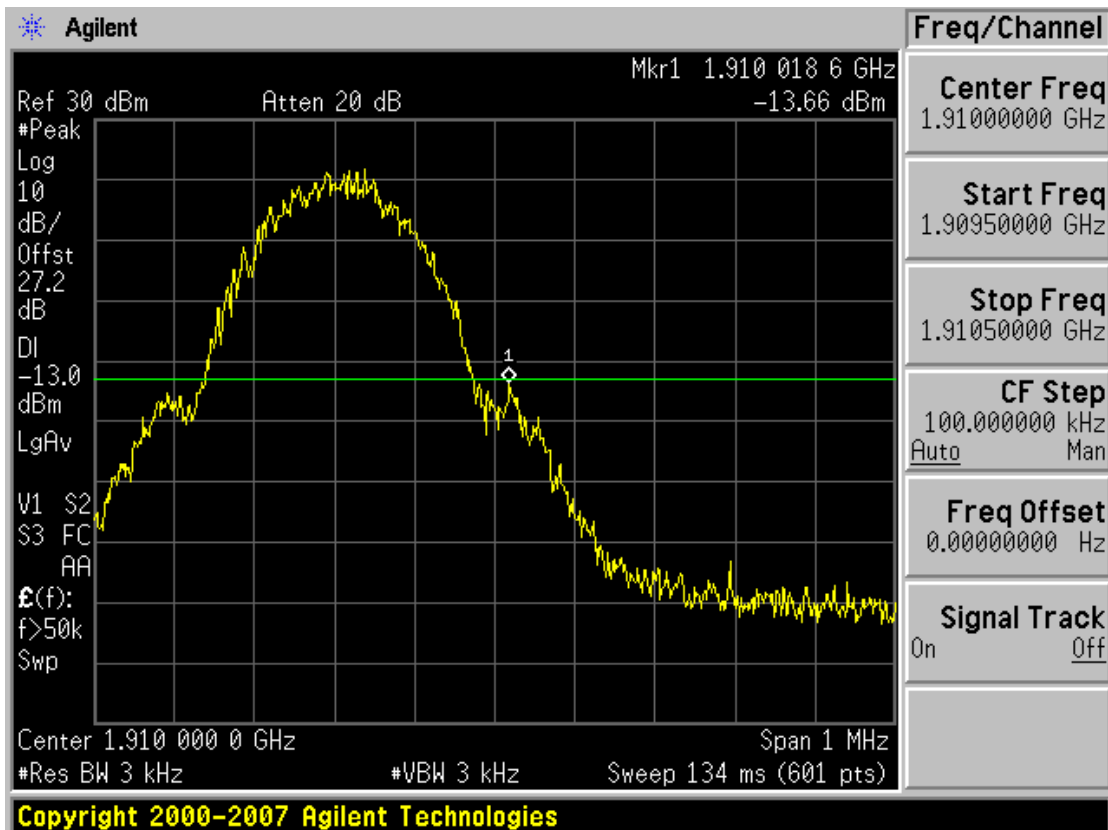

Sim 2

■ GSM850 MODE (128 CH.) Block Edge

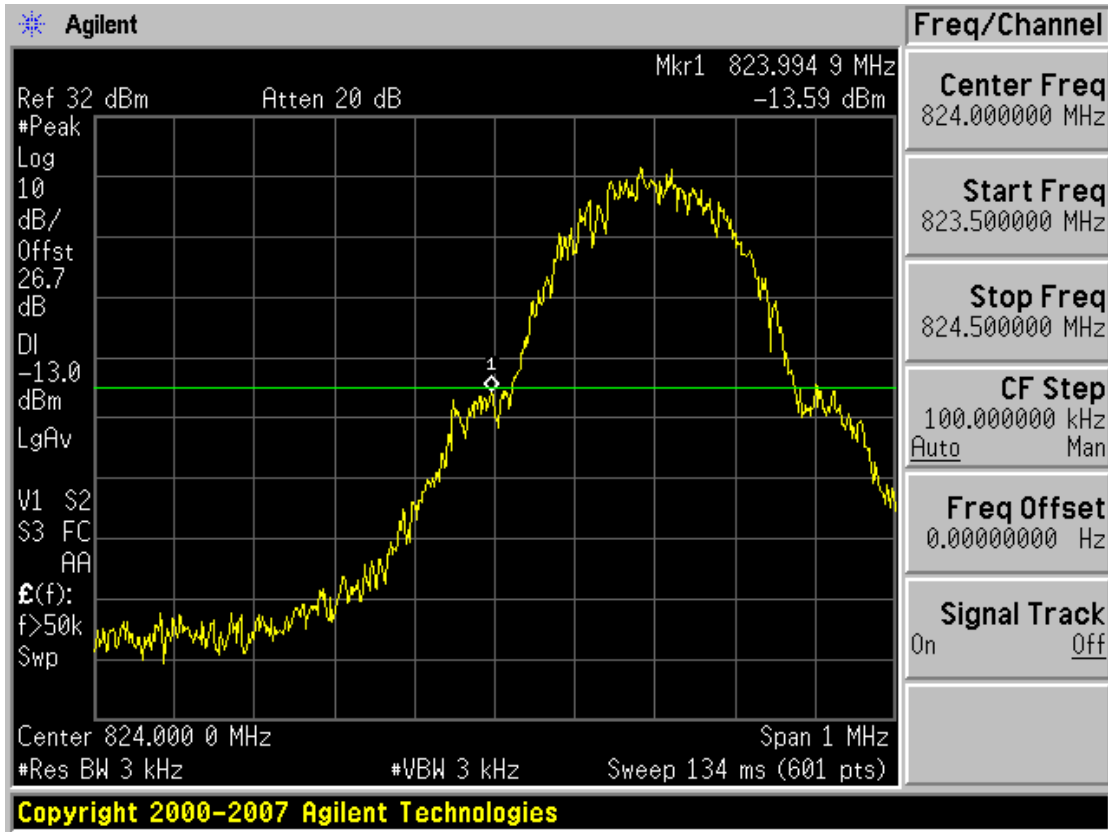

■ GSM850 MODE (251 CH.) Block Edge

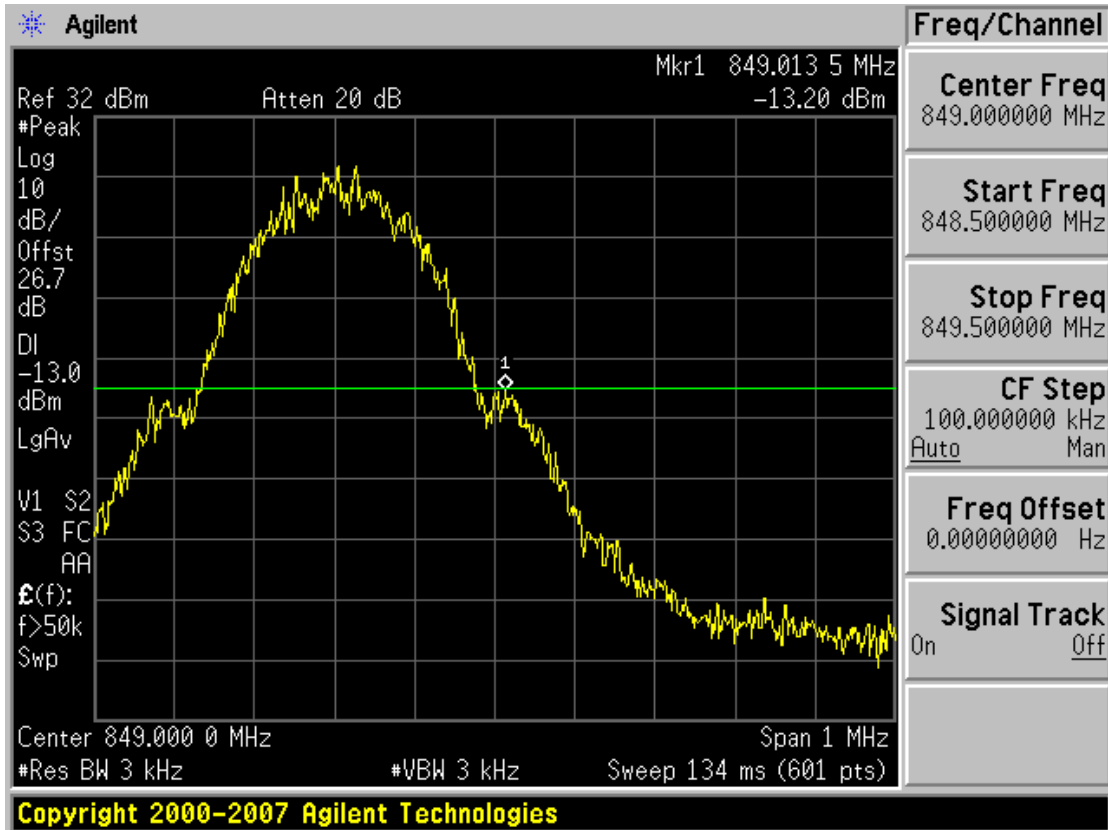

■ GSM1900 MODE (512 CH.) Block Edge

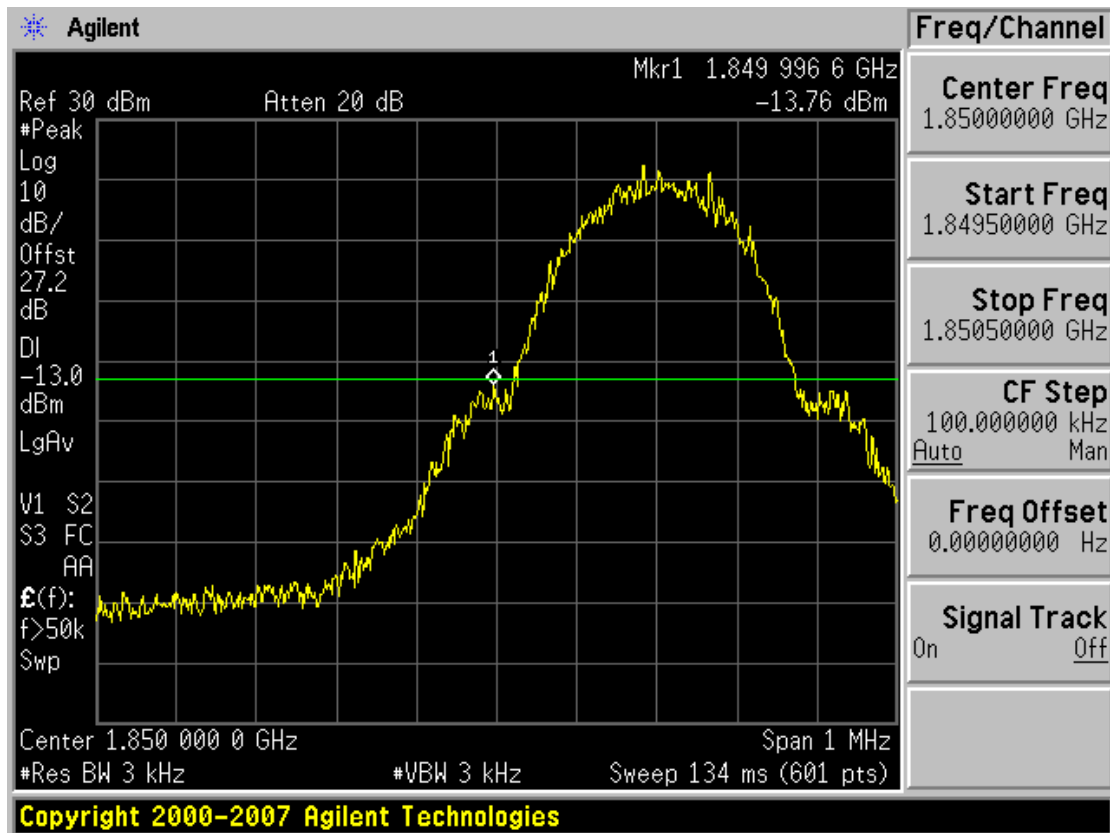

■ GSM1900 MODE (810 CH.) Block Edge

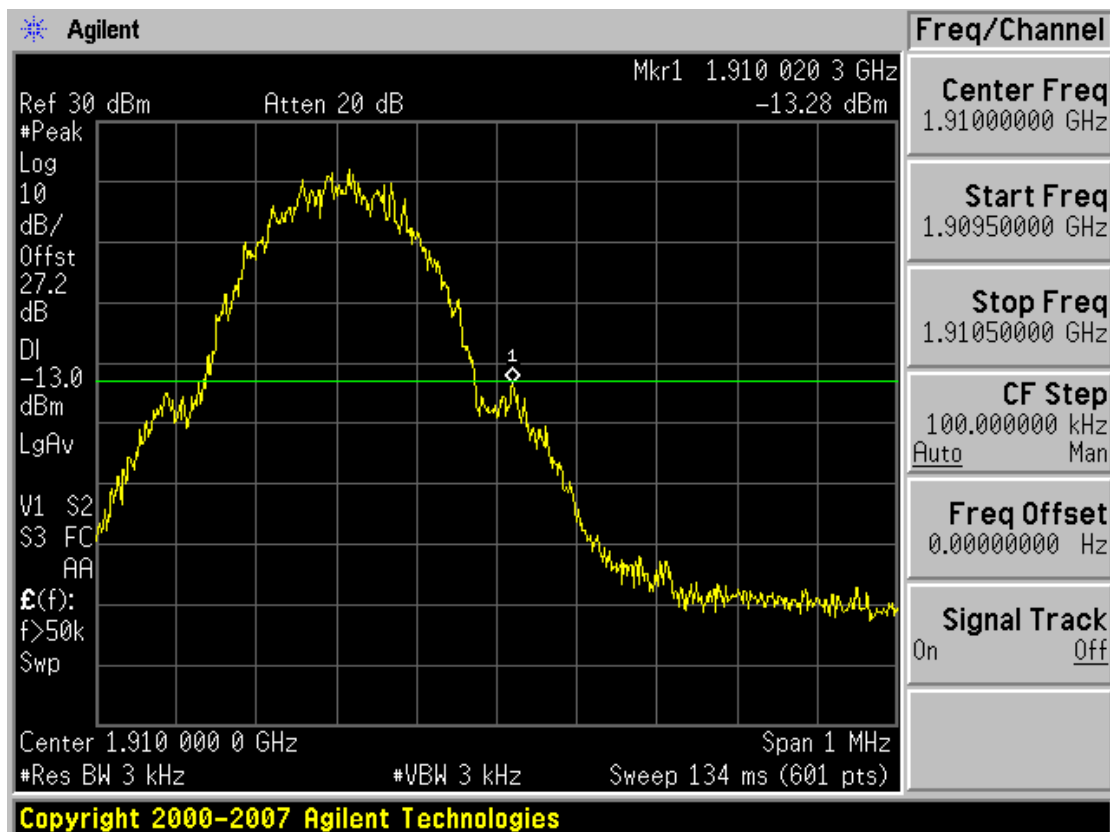

FCC CERTIFICATION REPORT

Test Report No. HCTR0912FR04-1	Date of Issue: December 22, 2009	EUT Type: Cellular/ PCS GSM Phone with Bluetooth	FCC ID: BEJGX200	Page 39 of 51
-----------------------------------	-------------------------------------	---	---------------------	---------------

Sim 1

■ GSM850 MODE (128 CH.) Conducted Spurious Emissions 1

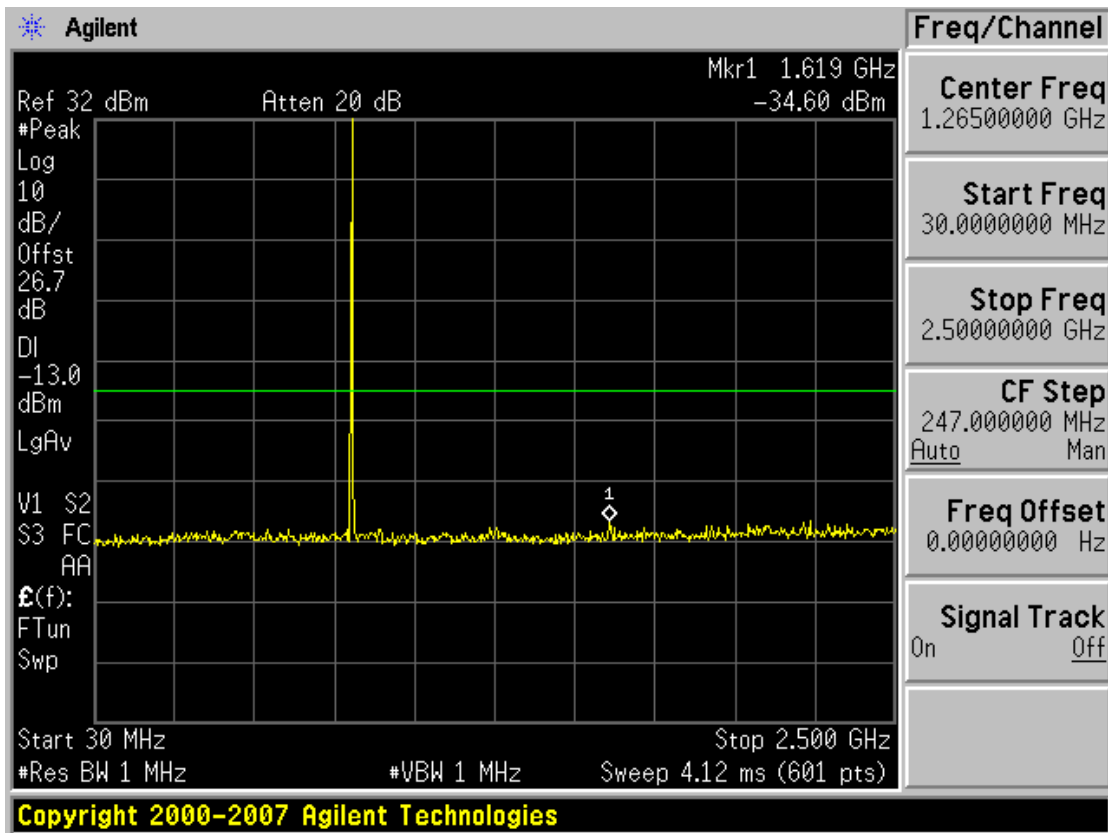

■ GSM850 MODE (128 CH.) Conducted Spurious Emissions 2

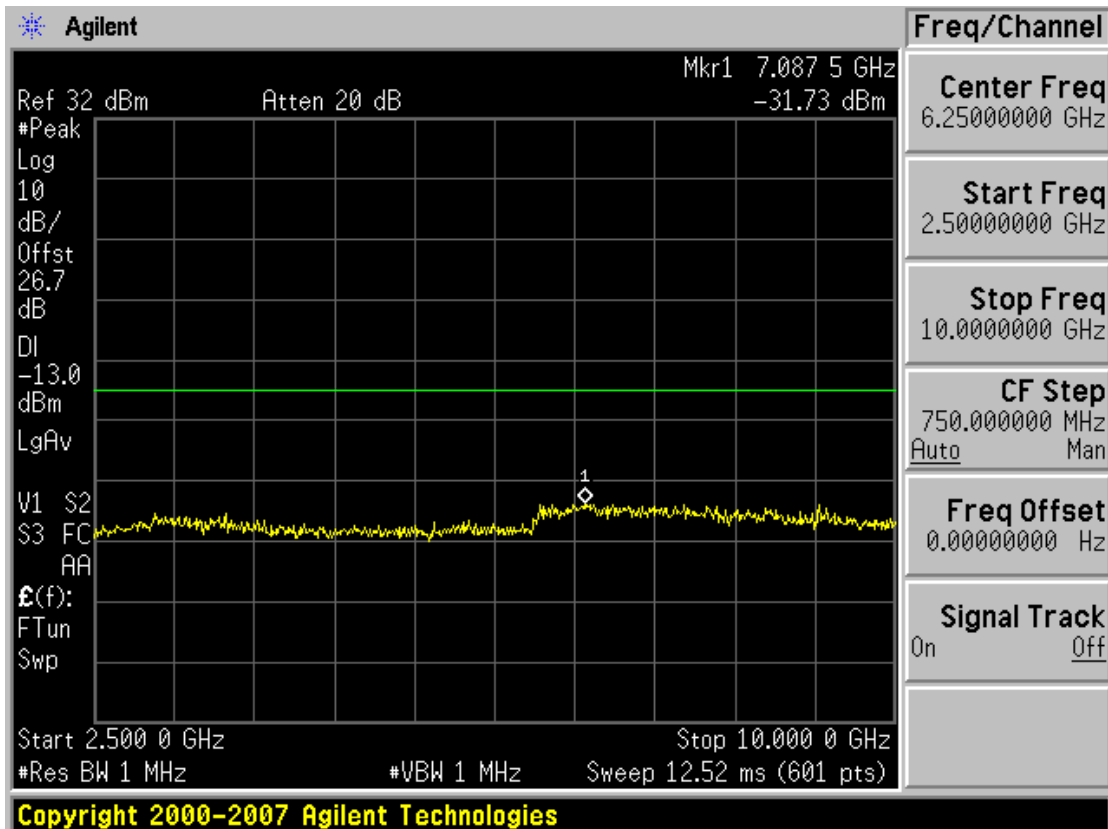

■ GSM850 MODE (190 CH.) Conducted Spurious Emissions 1

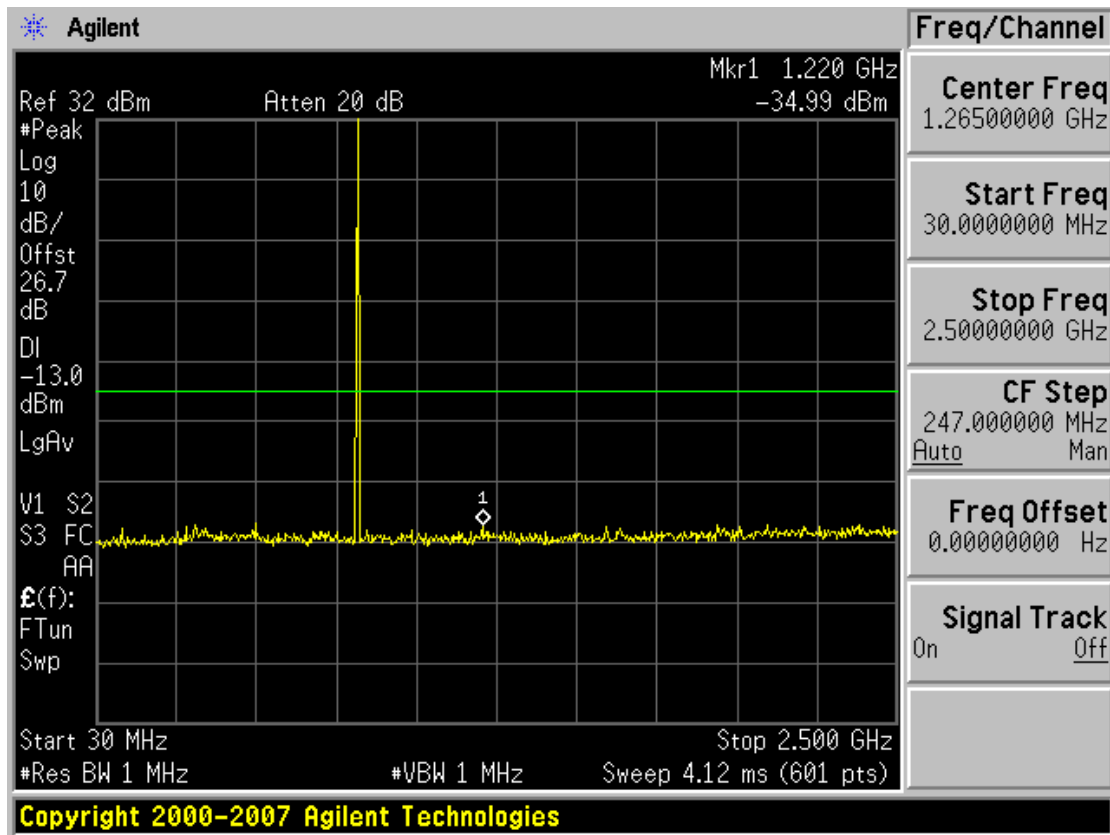

■ GSM850 MODE (190 CH.) Conducted Spurious Emissions 2

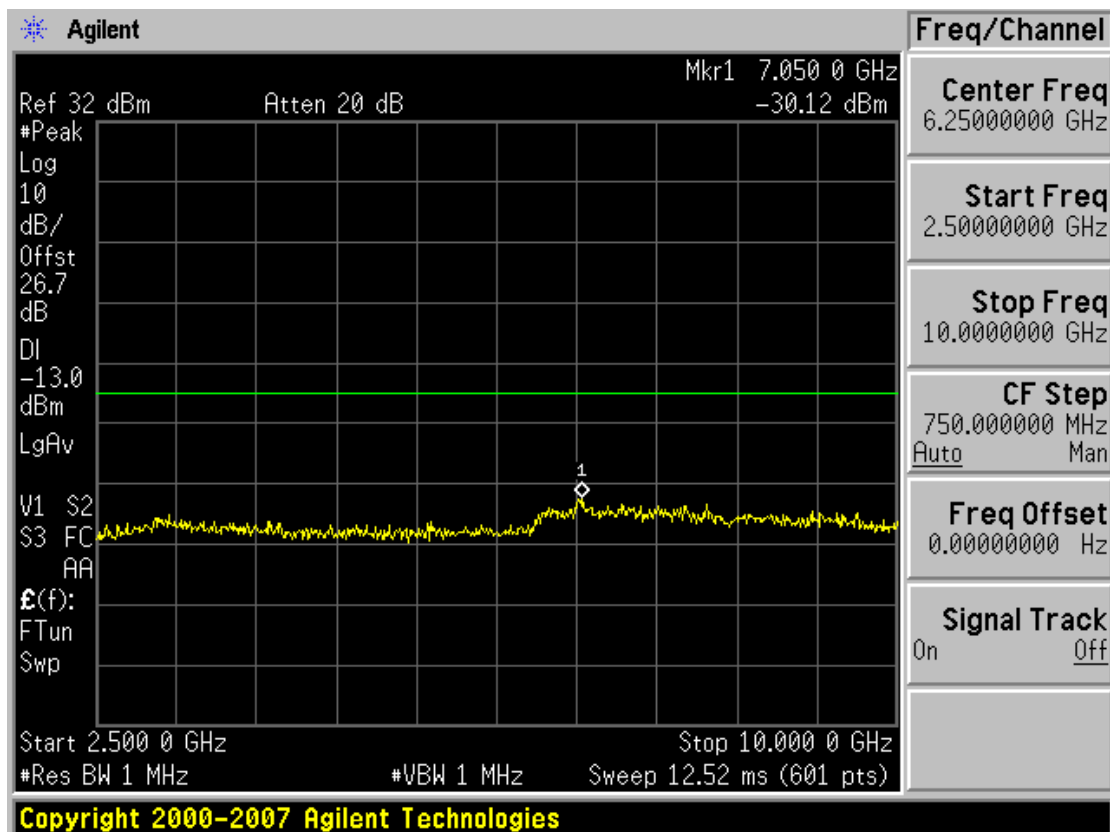

■ GSM850 MODE (251 CH.) Conducted Spurious Emissions 1

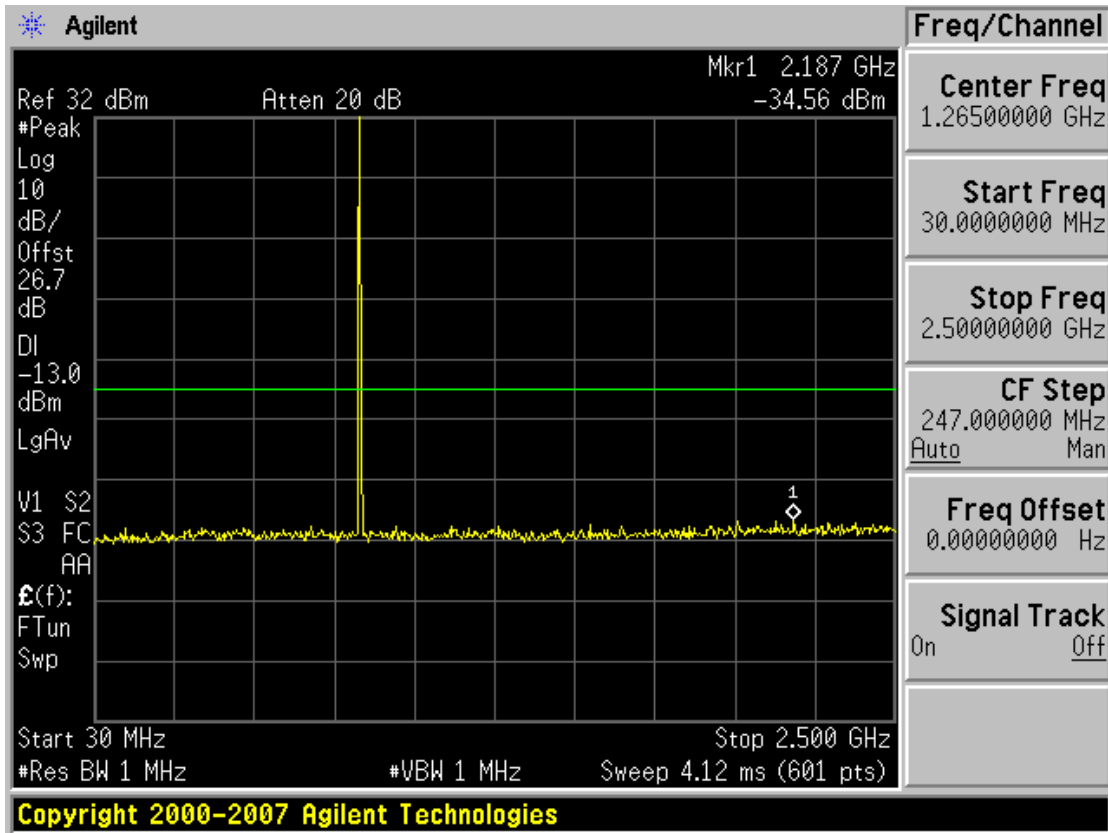

■ GSM850 MODE (251 CH.) Conducted Spurious Emissions 2

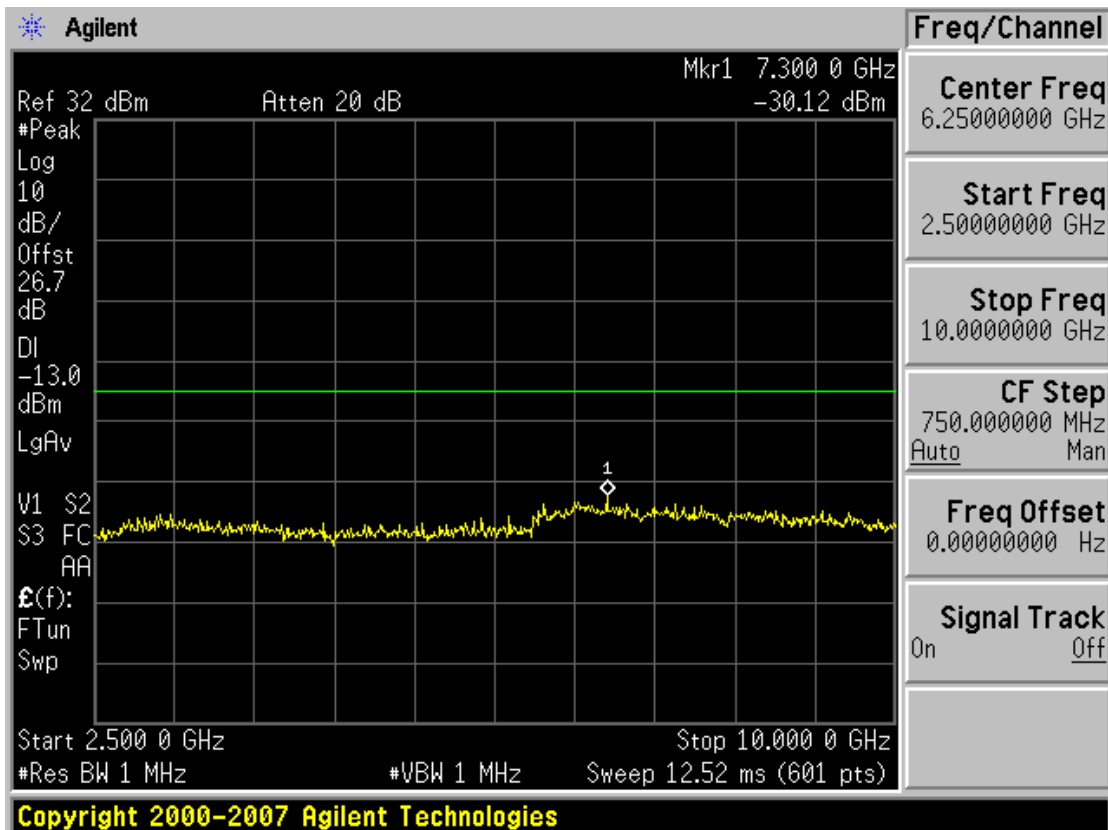

■ GSM1900 MODE (512 CH.) Conducted Spurious Emissions 1

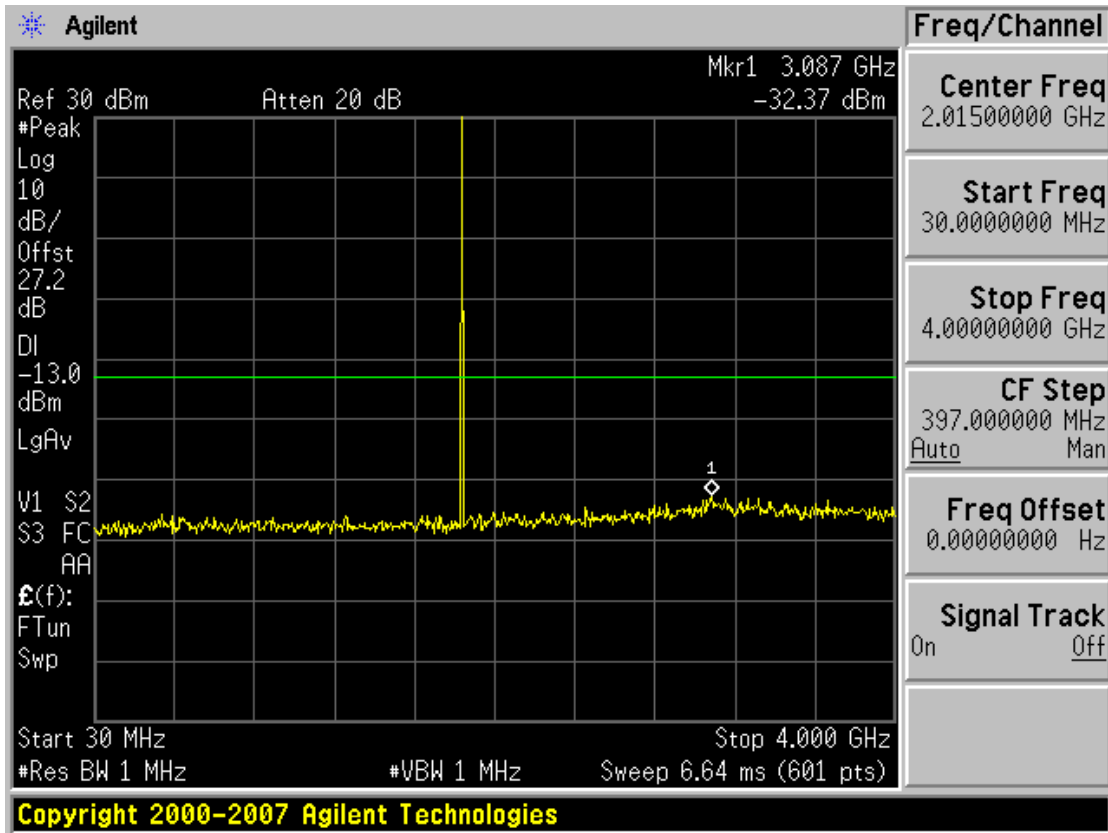

■ GSM1900 MODE (512 CH.) Conducted Spurious Emissions 2

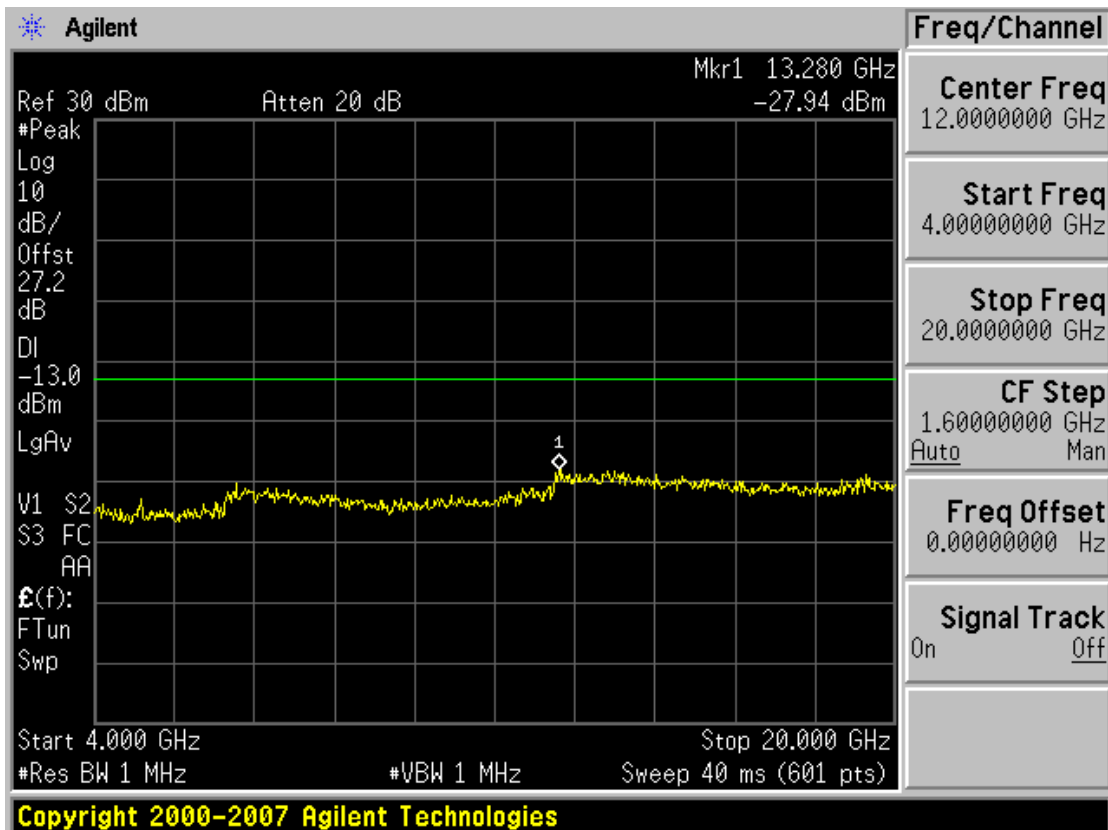

■ GSM1900 MODE (661 CH.) Conducted Spurious Emissions 1

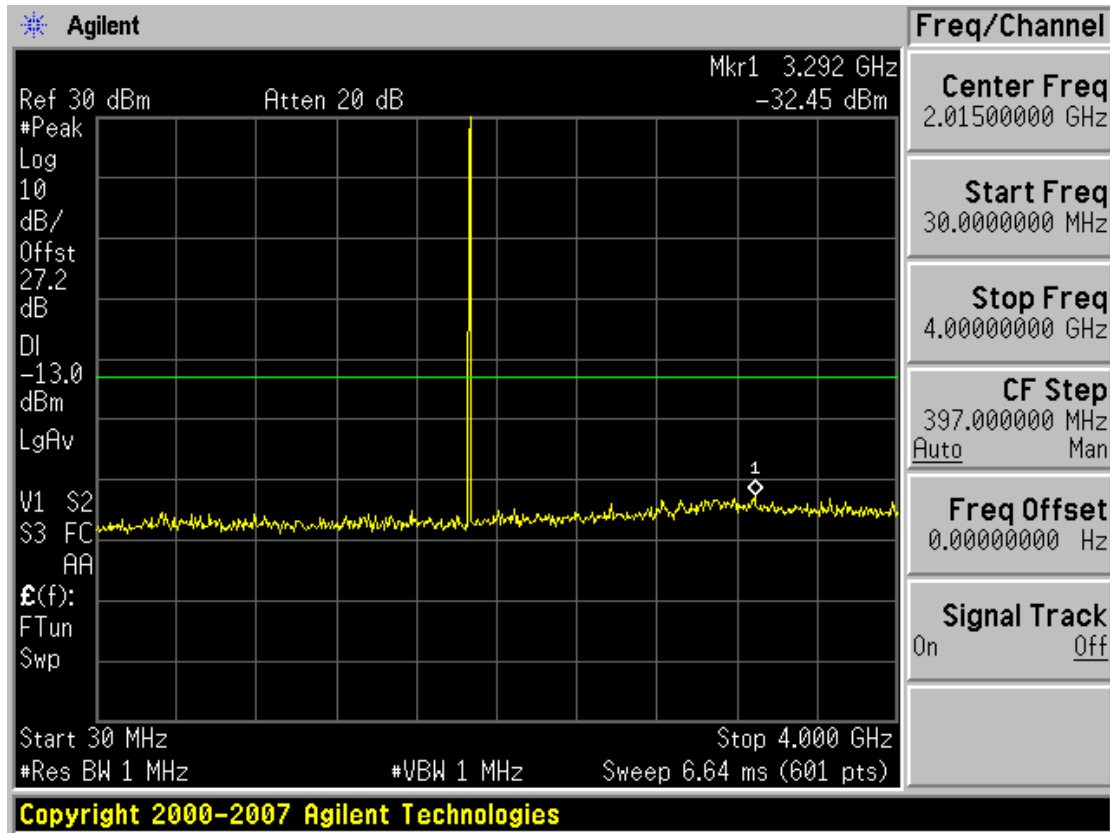

■ GSM1900 MODE (661 CH.) Conducted Spurious Emissions 2

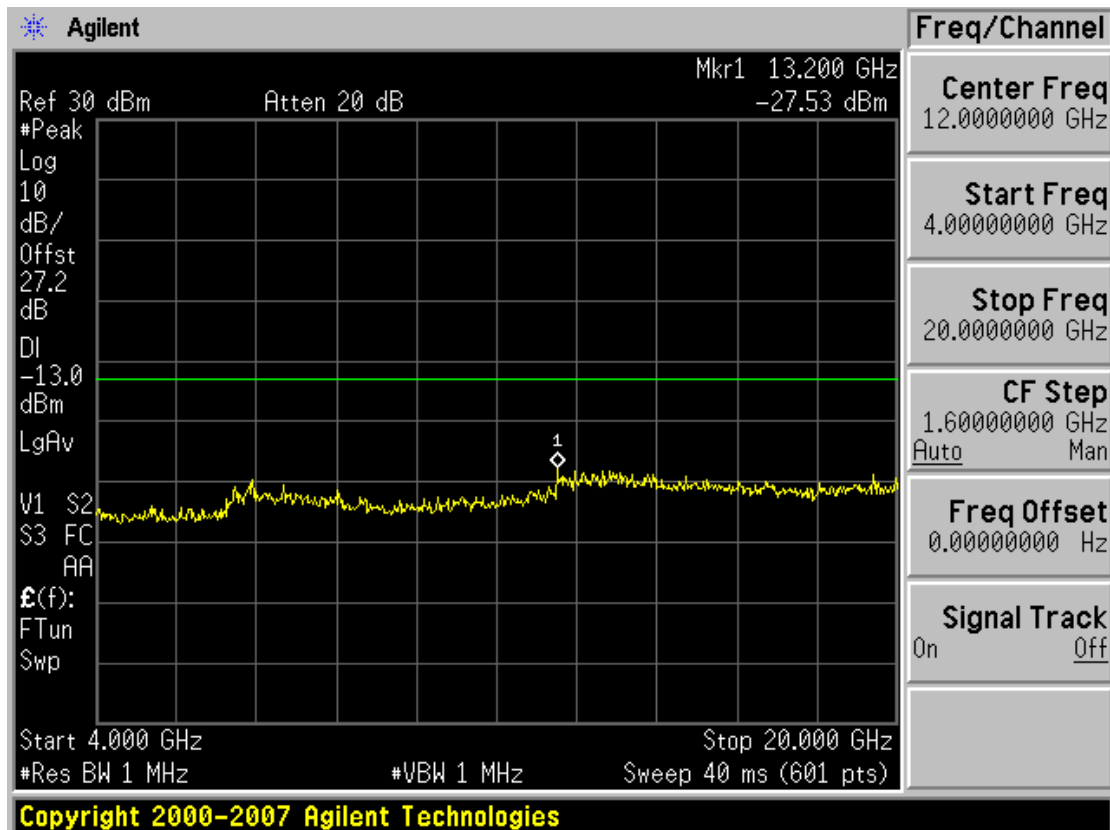

■ GSM1900 MODE (810 CH.) Conducted Spurious Emissions 1

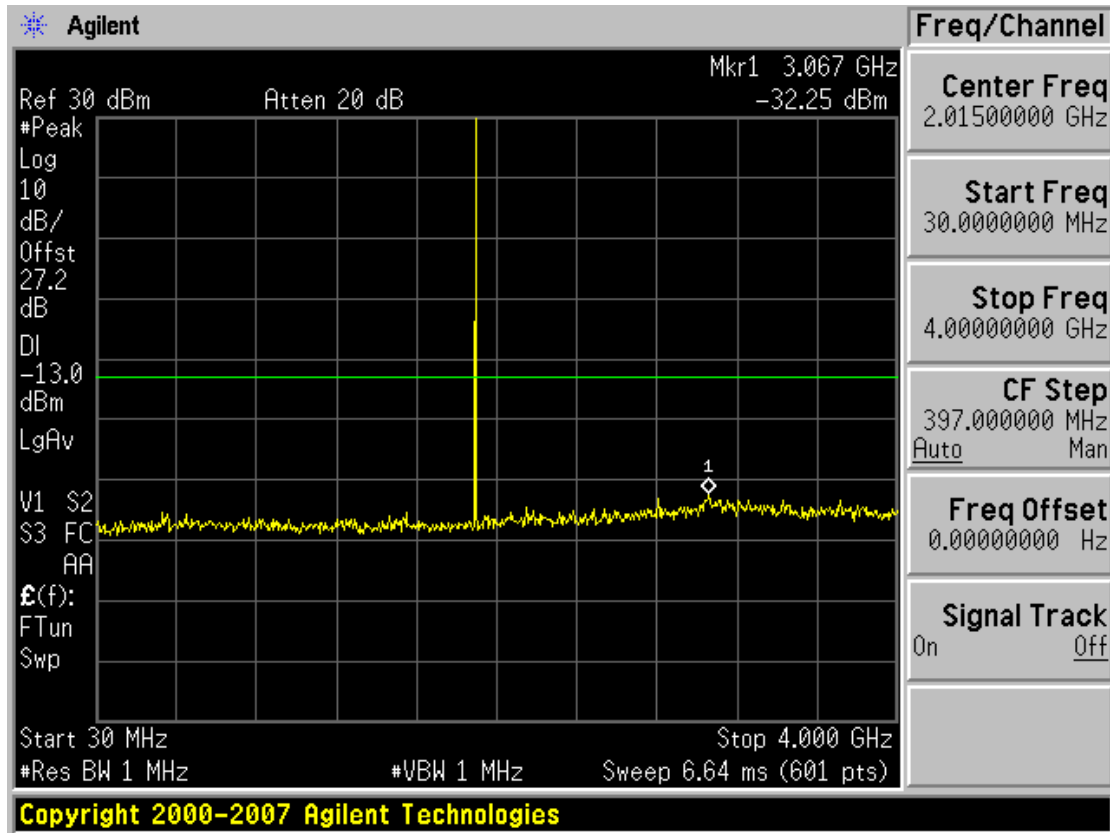

■ GSM1900 MODE (810 CH.) Conducted Spurious Emissions 2

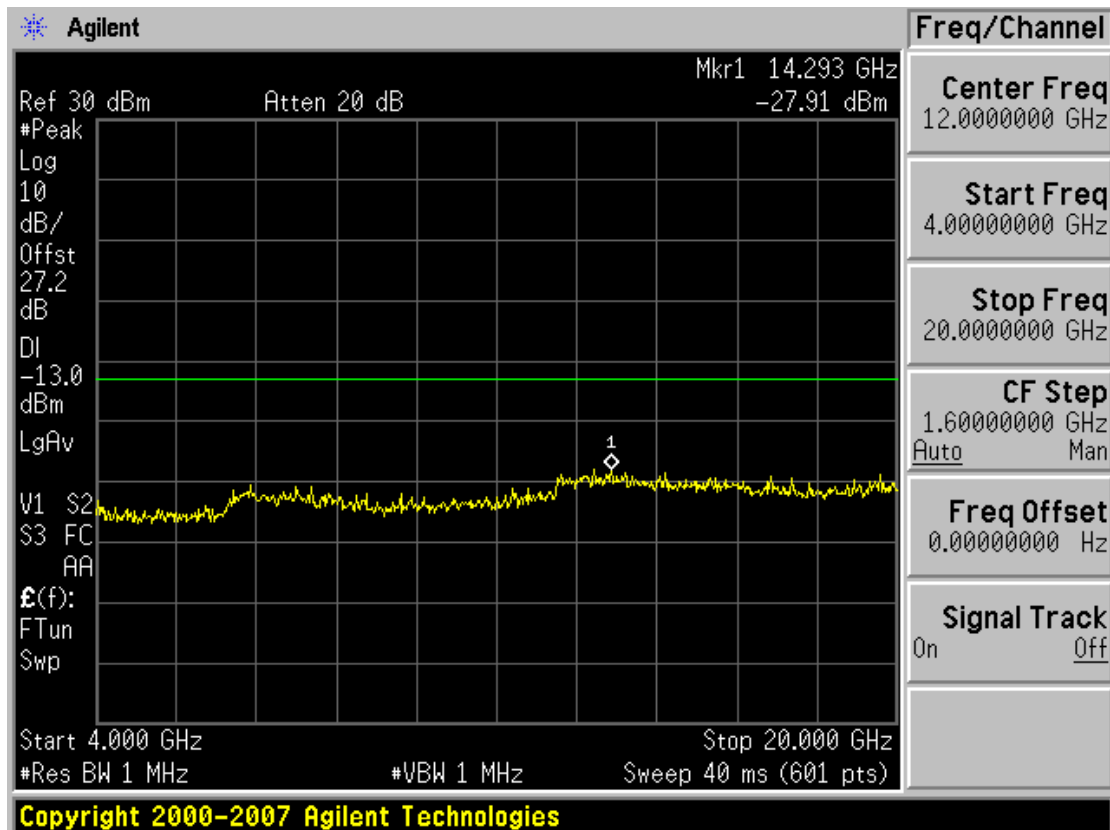

Sim 2

■ GSM850 MODE (128 CH.) Conducted Spurious Emissions 1

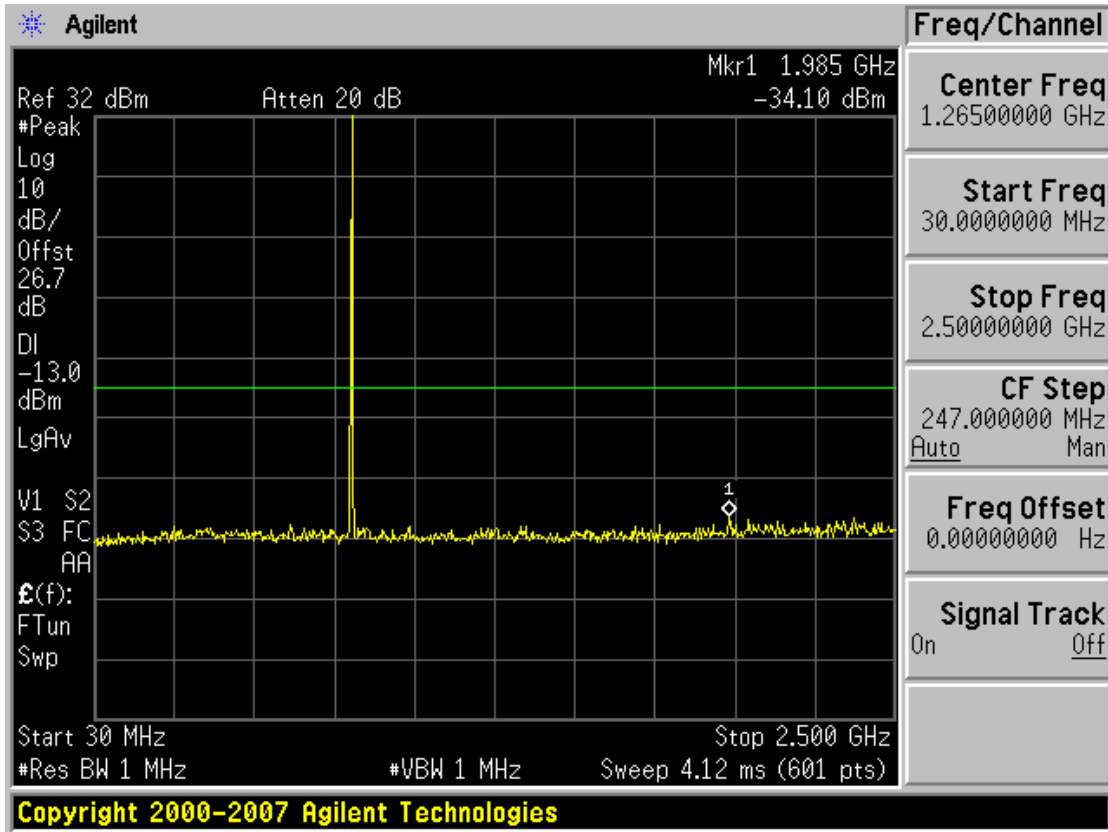

■ GSM850 MODE (128 CH.) Conducted Spurious Emissions 2

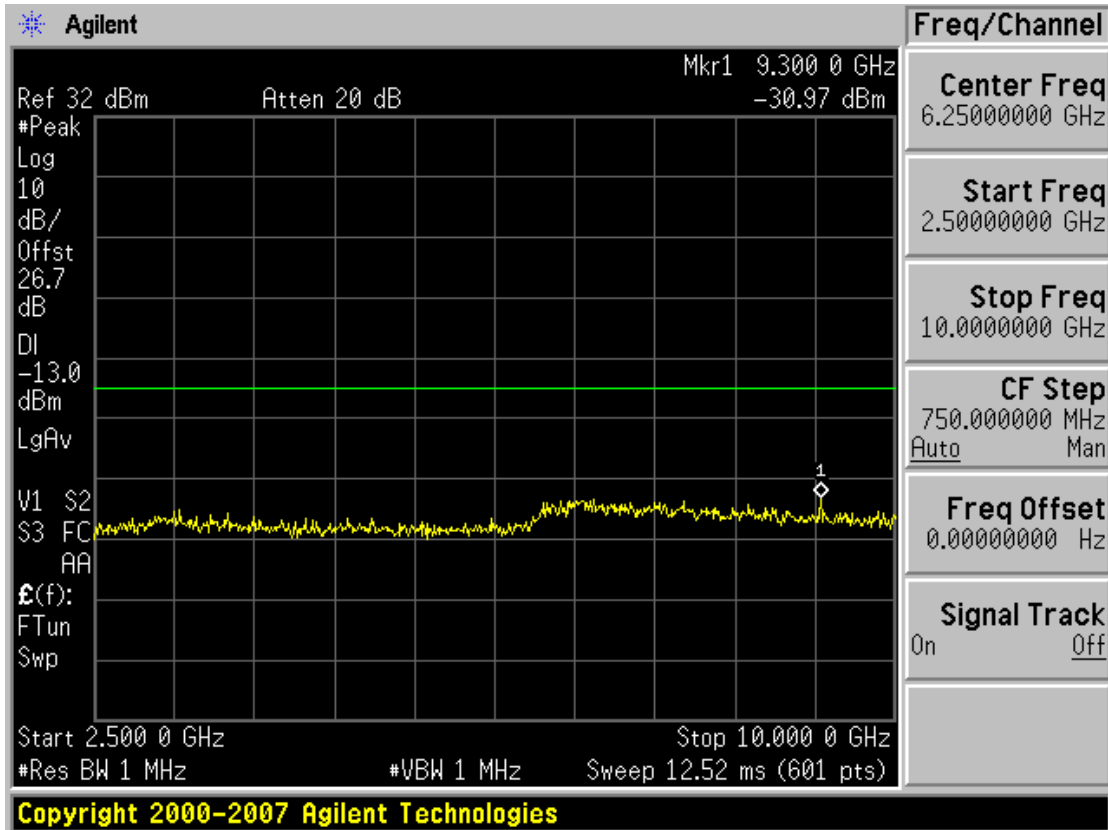

■ GSM850 MODE (190 CH.) Conducted Spurious Emissions 1

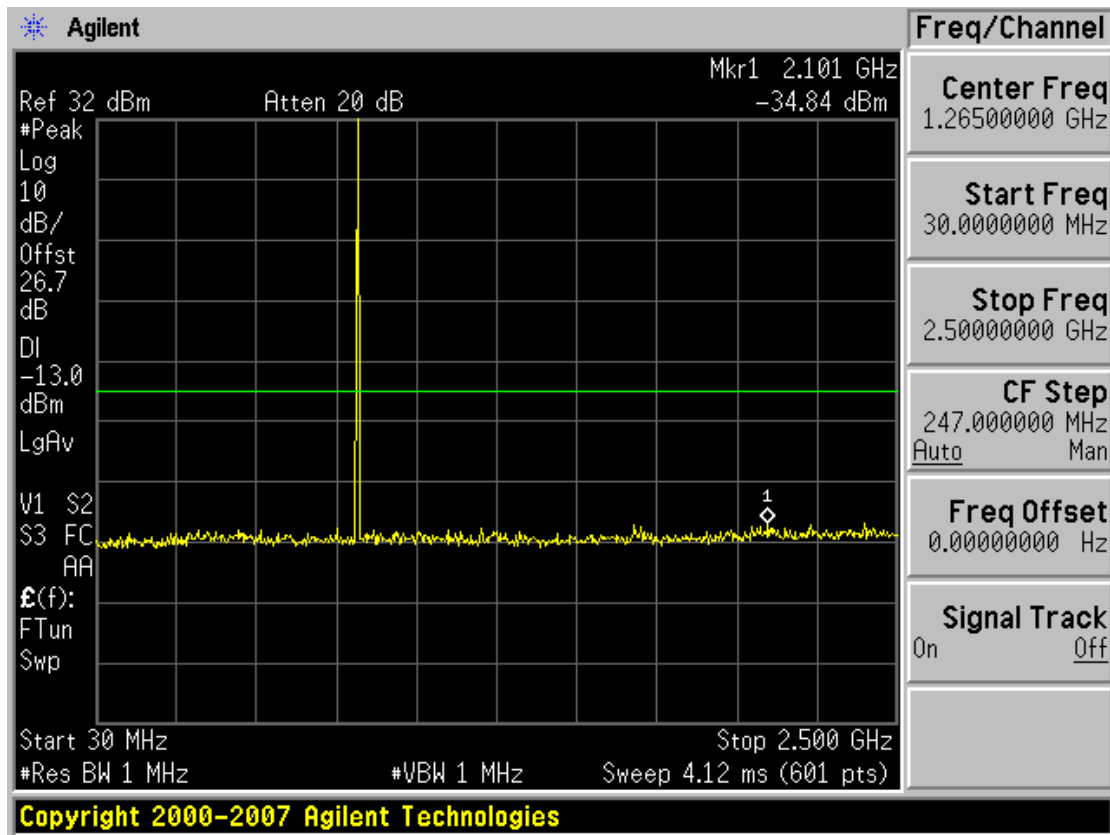

■ GSM850 MODE (190 CH.) Conducted Spurious Emissions 2

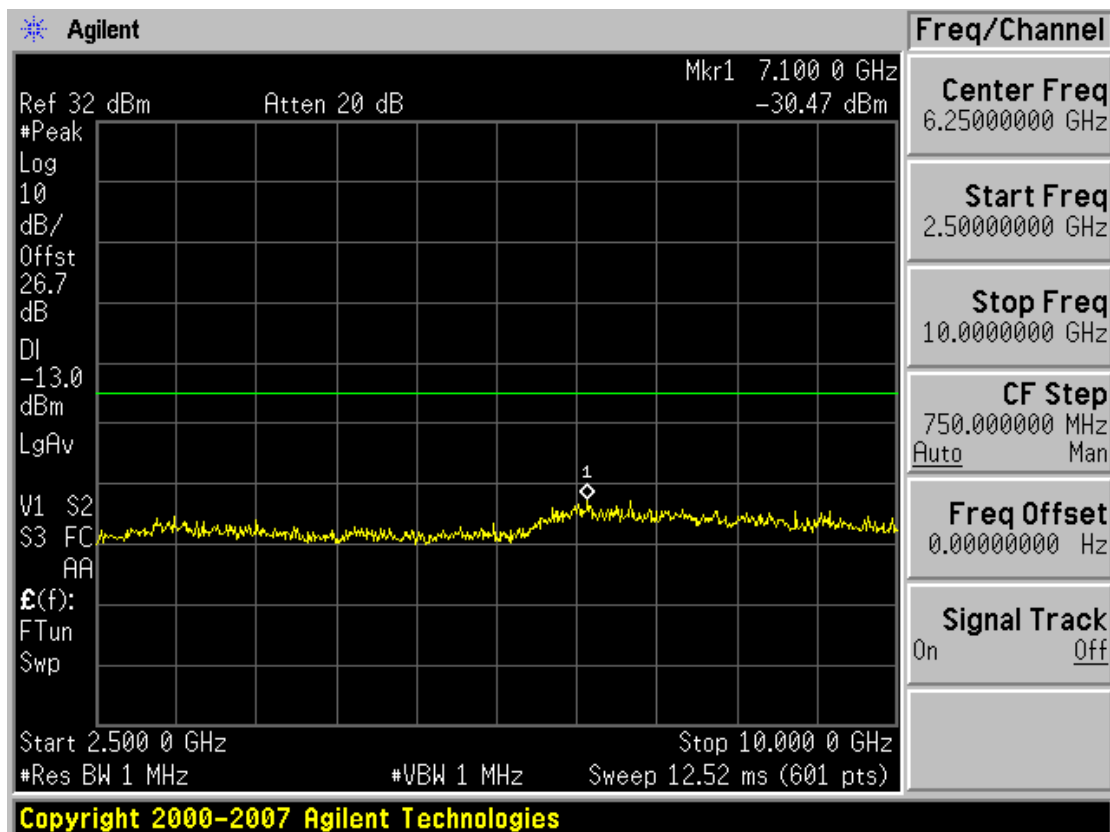

■ GSM850 MODE (251 CH.) Conducted Spurious Emissions 1

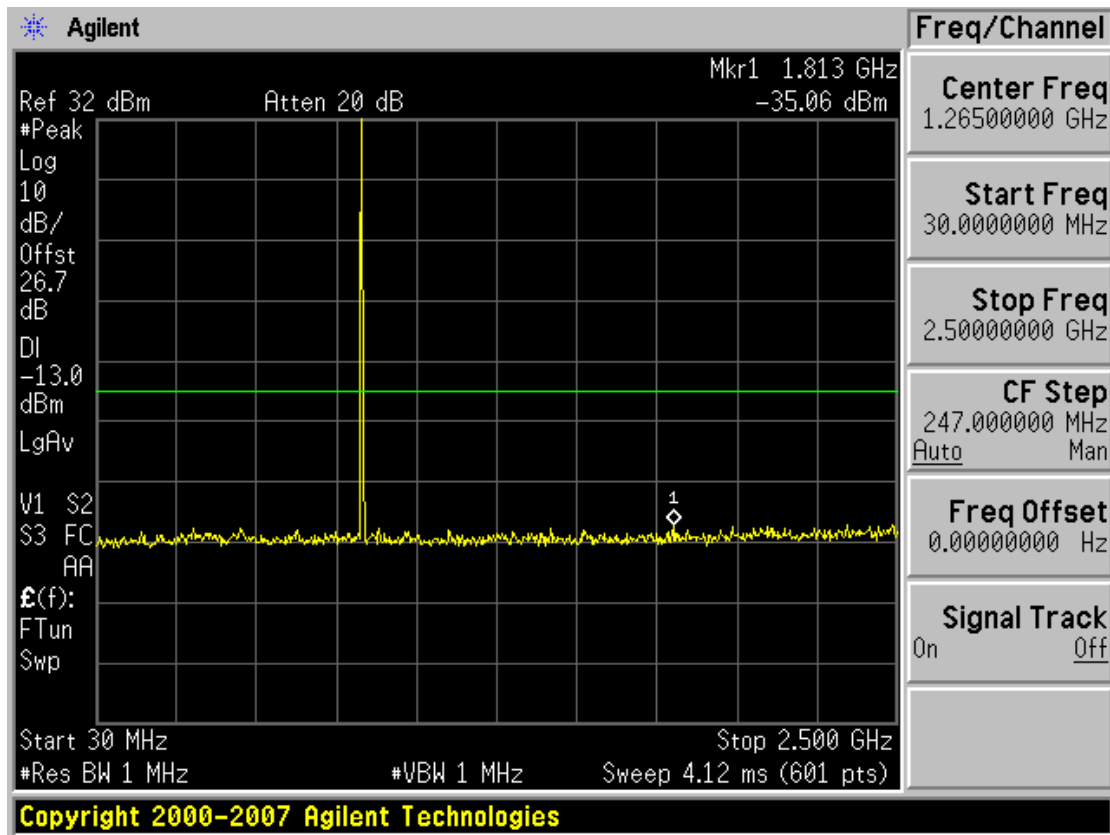

■ GSM850 MODE (251 CH.) Conducted Spurious Emissions 2

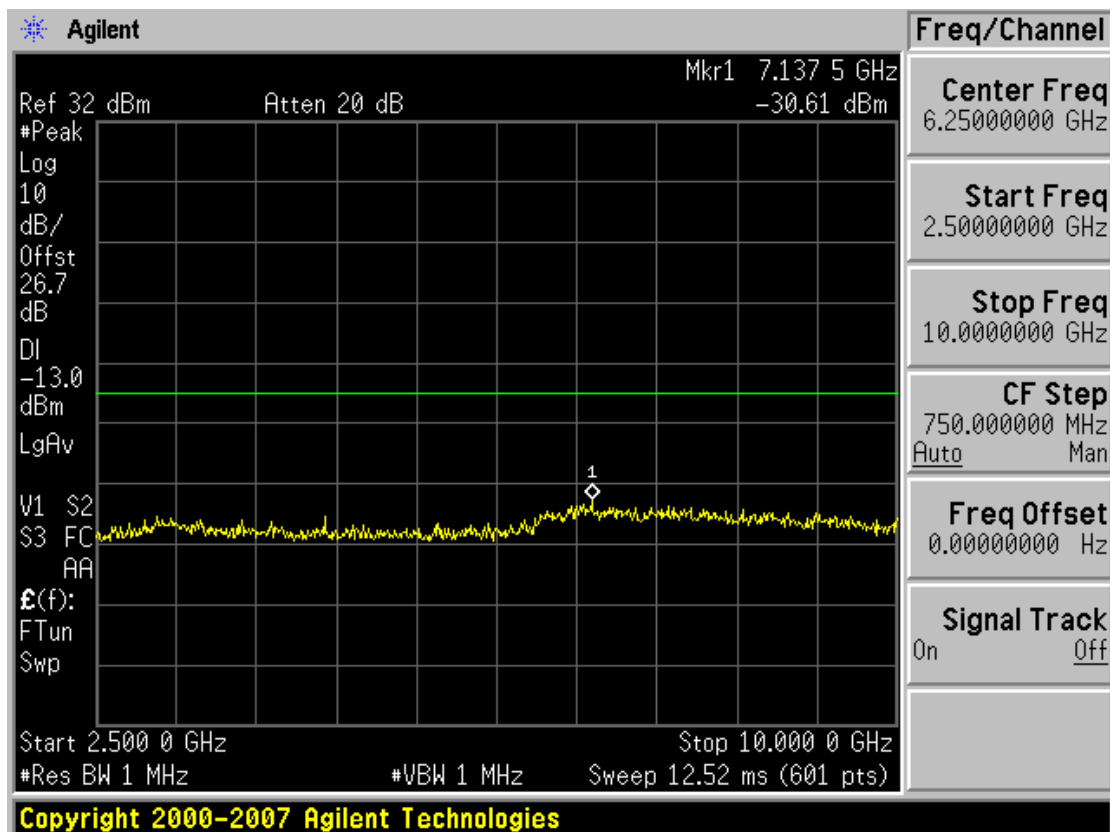

■ GSM1900 MODE (512 CH.) Conducted Spurious Emissions 1

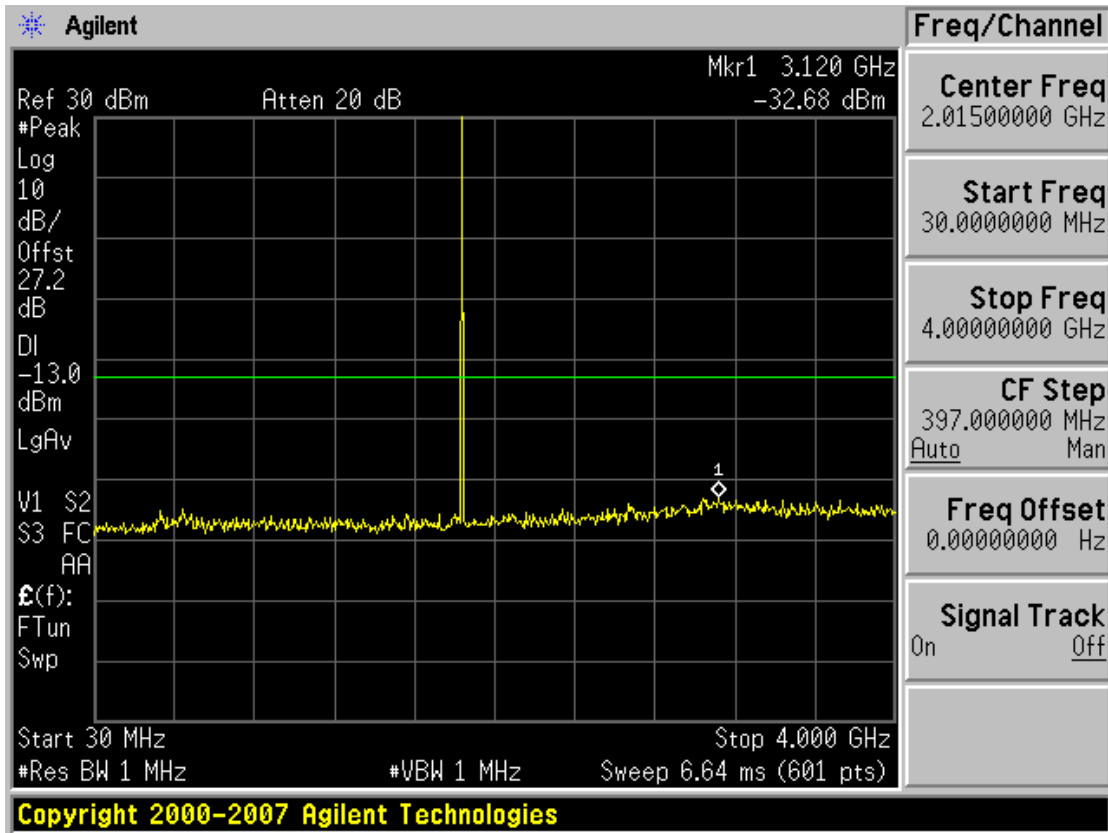

■ GSM1900 MODE (512 CH.) Conducted Spurious Emissions 2

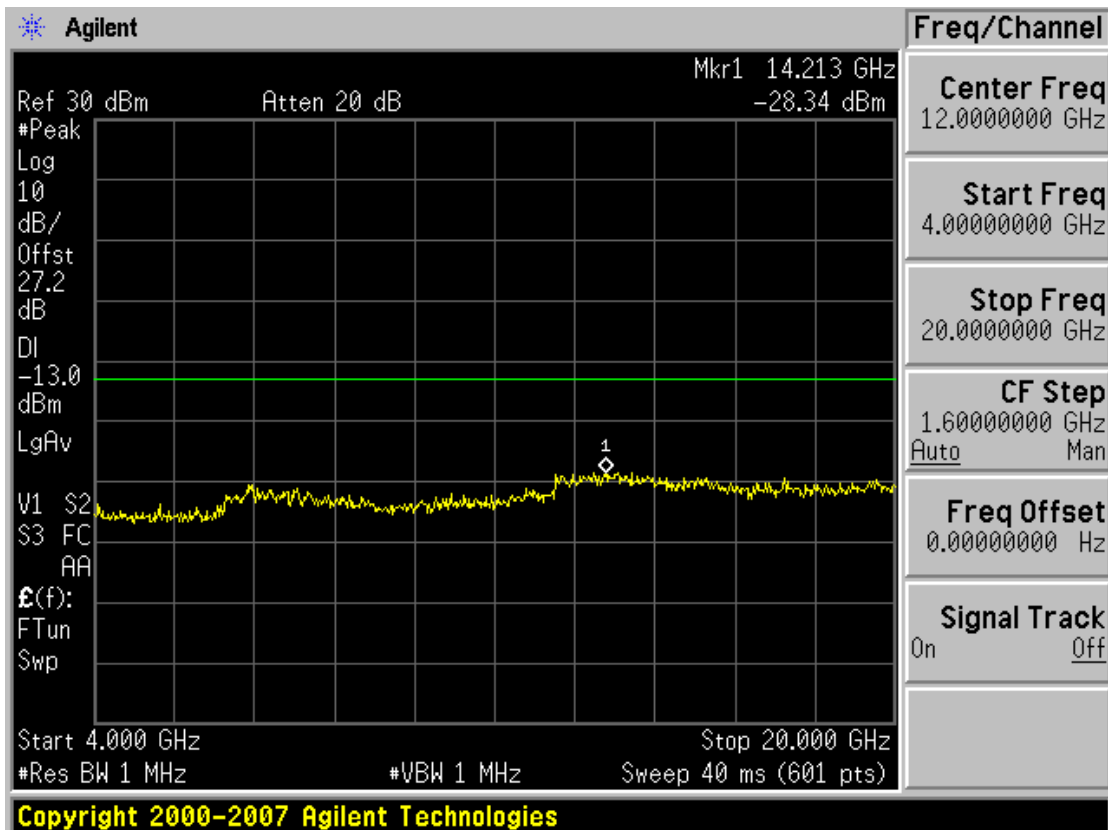

■ GSM1900 MODE (661 CH.) Conducted Spurious Emissions 1

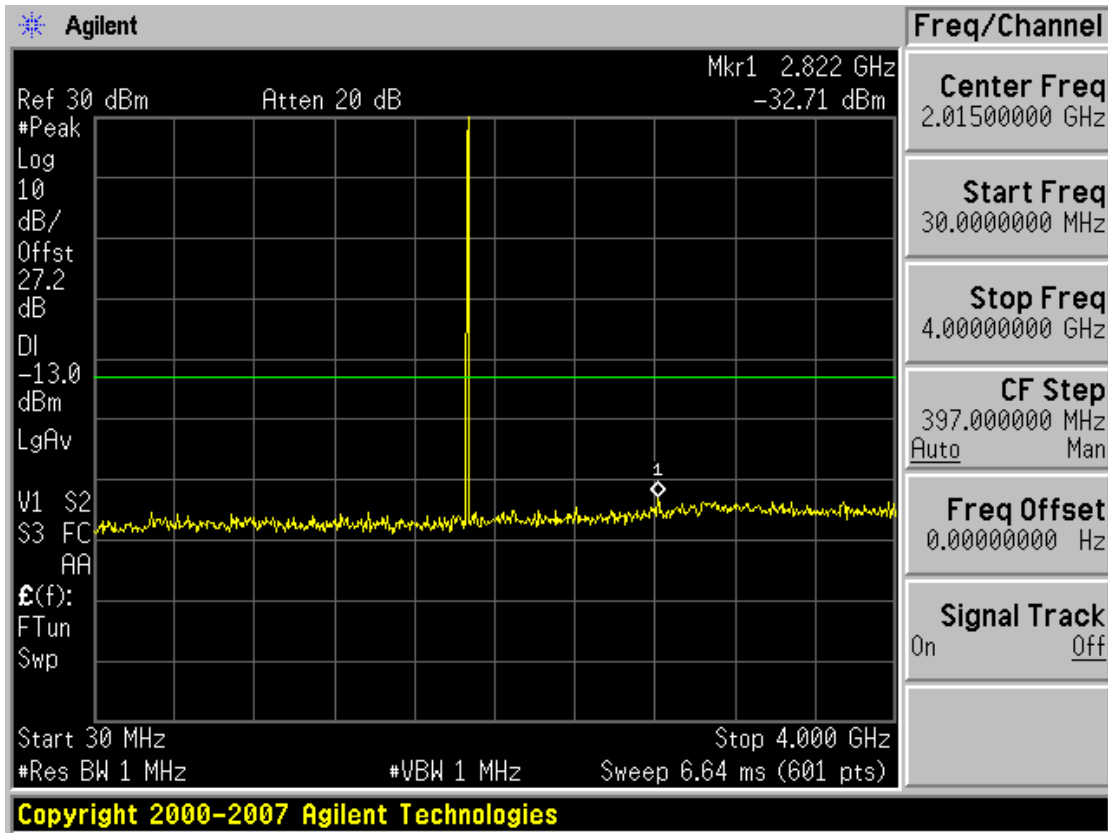

■ GSM1900 MODE (661 CH.) Conducted Spurious Emissions 2

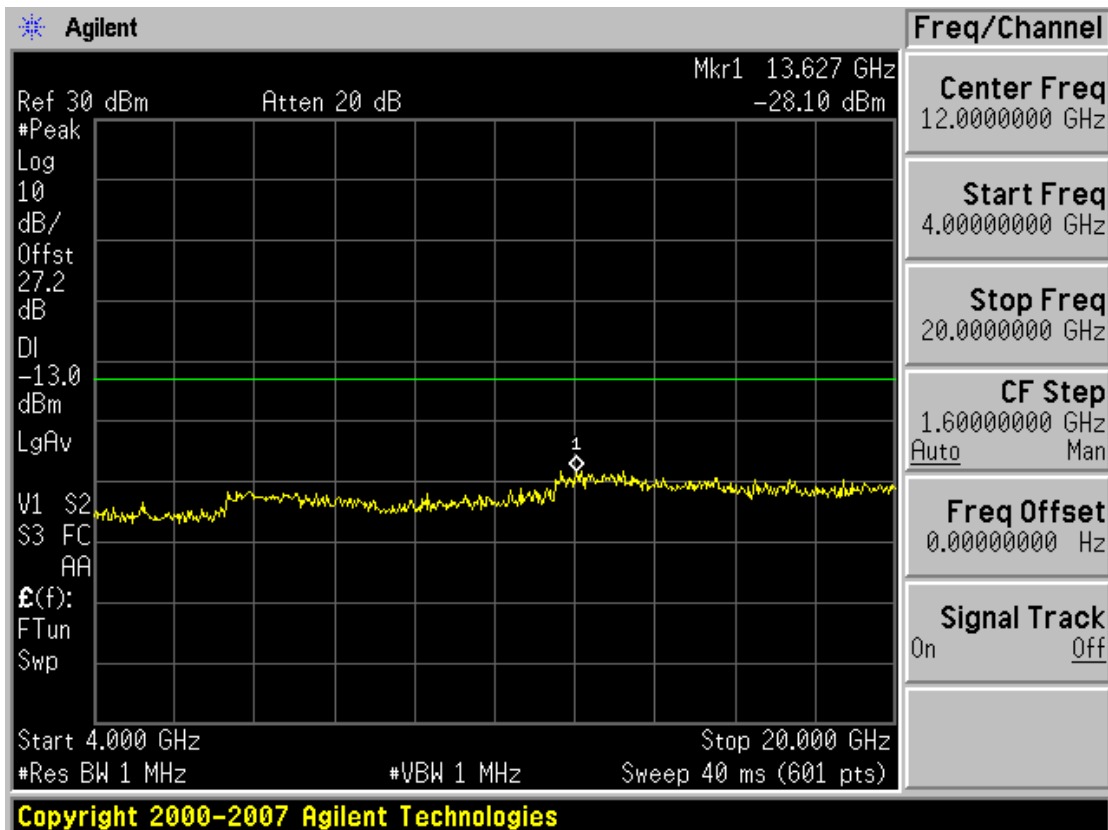

■ GSM1900 MODE (810 CH.) Conducted Spurious Emissions 1

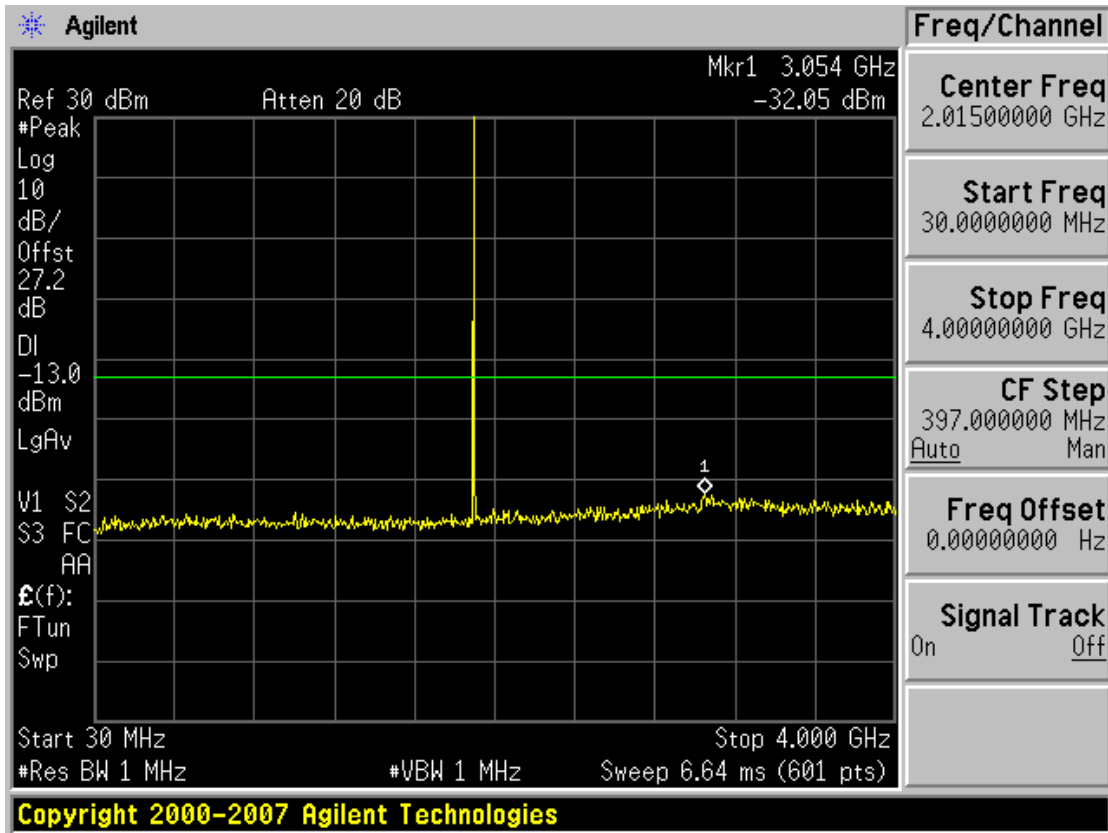

■ GSM1900 MODE (810 CH.) Conducted Spurious Emissions 2

