

SAR TEST REPORT

Specific Absorption Rate
Test Report No : MCCL-3-09-130

Product : Cellular/PCS GSM Phone

Model Name(s) : GS107a

Manufacturer : LG Electronics, Inc.

Applicant : LG Electronics, Inc.

Application Type : Certification

Device Category : Licensed Portable Transmitter Held to Ear (PCE)

Standards : § 2.1093; FCC/OET Bulletin 65 Supplement C [July 2001]

Date of Sample Receipt : October 06, 2009

Date of Issue : October 23, 2009

Test Device Serial No. : Pre-Production Sample [S/N: #1]

Test Result : PASS

SUMMARY

This wireless portable device has been shown to be capable of compliance for localized specific absorption rate (SAR) for uncontrolled environment/general population exposure limits specified in ANSI / IEEE C95.1(2005) and had been tested in accordance with the measurement procedures specified in FCC/OET bulletin 65 Supplement C (2001) , ANSI / IEEE 1528 – Dec. 2003 and in applicable Industry Canada Radio Standards specifications (RSS)

※ The test results in this test report apply only to sample(s) tested.



Issued under the authority of
 E. S. Park / Technical Manager
 MCCL



Reviewed by
 J. S. Jang /Vice Technical Manager
 MCCL



Prepared by
 H. S. Shim / Test Engineer
 MCCL

TABLE OF CONTENTS

1. TEST RESULT SUMMARY 3

2. DESCRIPTION OF THE DEVICE UNDER TEST..... 4

 2.1 Antenna Description..... 4

 2.2 Device Description..... 4

3. INTRODUCTION..... 5

4. SAR MEASUREMENT SYSTEM 6

 4.1 SAR Measurement Setup.....6

 4.2 DASY4 E-Field Probe System..... 7

 4.3 Phantom..... 9

 4.4 Brain & Muscle Simulating Mixture Characterization10

 4.5 Device Holder for Transmitters..... 11

 4.6 Validation Dipole 11

5. SAR MEASUREMENT PROCEDURE..... 12

6. DEFINITION OF REFERENCE POINT..... 13

 6.1 EAR Reference Point..... 13

 6.2 Handset Reference Points..... 14

7. TEST CONFIGURATION POSITIONS..... 15

 7.1 Positioning for Cheek/Touch..... 15

 7.2 Positioning for Ear / 15° Tilt..... 16

 7.3 Body Holster /Belt Clip Configuration..... 17

8. MEASUREMENT UNCERTAINTY..... 18

9. ANSI/IEEE C95.1–2005 RF EXPOSURE LIMITS 19

10. SYSTEM VERIFICATION..... 20

11. RF CONDUCTED POWER 22

 11.1 Procedures Used To Establish Test Signal..... 22

12. MEASUREMENT RESULTS 23

13. TEST EQUIPMENT..... 27

14. REFERENCES..... 28

APPENDIX A: Validation Test Data..... 29

APPENDIX B: SAR Test Data..... 33

APPENDIX C: Calibration Certificates..... 54

1. TEST RESULT SUMMARY

Model Name(s) : GS107a
 Date of Test : October 16 ~ 17, 2009
 Date of Issue : October 23, 2009
 Address of Test Site : 60-39, Kasan-Dong, Kumchon-Gu, Seoul 153-801, Korea.
 Responsible Test Engineer : Eui-Soon Park
 Test Engineer : Hyun-seop Shim
 EUT Type : Cellular / PCS GSM Phone

 Tx Frequency : 824.20 ~ 848.80 MHz (GSM850)
 1850.20 ~ 1909.80 MHz (PCS1900)

 Rx Frequency : 869.20 ~ 893.80 MHz (GSM850)
 1930.20 ~ 1989.80 MHz (PCS1900)

 Transmit Output Power : GSM850: 33.0 dBm
 PCS1900: 29.5 dBm

Maximum Results Found During SAR Evaluation

1. Head Configuration

ANSI / IEEE C95.1(2005) - SAFETY LIMIT Spatial Peak Uncontrolled Exposure/General Population					1.6 W/kg averaged over 1 gram			
Frequency		Mod.	Conducted Power (dBm)		Battery	Device Test Position	Antenna Position	SAR (W/kg)
MHz	Ch.		Start	End				
836.60	190	GSM 850	32.98	32.79	Standard	Left Touch	Fixed	1.17

2. Body Worn Configuration

ANSI / IEEE C95.1(2005) - SAFETY LIMIT Spatial Peak Uncontrolled Exposure/General Population					1.6 W/kg averaged over 1 gram			
Frequency		Mod.	Conducted Power (dBm)		Battery	Device Test Position	Antenna Position	SAR (W/kg)
MHz	Ch.		Start	End				
836.60	190	GSM 850	32.98	32.82	Standard	20mm [Rear]	Fixed	0.377

3. Measurement Uncertainty

Combine Standard Uncertainty	10.4
Extended Standard Uncertainty	20.8 (k=2, 95% CONFIDENCE LEVEL)

2. DESCRIPTION OF THE DEVICE UNDER TEST

The FCC rules for evaluating portable devices for RF exposure compliance are contained in 47 CFR §2.1093. For purposes of RF exposure evaluation, a portable device is defined as a transmitting device designed to be used with any part of its radiating structure in direct contact with the user's body or within 1.5 centimeters of the body of a user or bystanders under normal operating conditions. This category of devices would include hand-held cellular and PCS telephones that incorporate the radiating antenna into the hand-piece and wireless transmitters that are carried next to the body. Portable devices are evaluated with respect to SAR limits for RF exposure. The applicable SAR limit for portable transmitters used by consumers is 1.6 watts/kg, which is averaged over any one gram of tissue defined as a tissue volume in the shape of a cube.

2.1 Antenna Description

Type :	Fixed
Location :	The inside of the device
Configuration :	Intenna Type Antenna

2.2 Device Description

Manufacturer :	LG Electronics, Inc.
FCC ID :	BEJGS107A
Trade Name :	LG
Model Name :	GS107a
Serial No :	Pre-Production Sample [S/N: #1]
EUT Type :	Cellular / PCS GSM Phone
Mode(s) of Operation :	GSM850 / PCS1900
Transmit Output Power :	GSM 850 : Level 5 (33.0 dBm) PCS 1900 : Level 0 (29.5 dBm)
Mode(s) of Operation :	GSM
Modulation Mode(s) :	GSM
Duty Cycle :	8.3 (GSM)
Transmitting Frequency Range :	824.20 ~ 848.80 MHz (GSM850) 1850.20 ~ 1909.80 MHz (PCS1900)
Battery Type :	Standard

3. INTRODUCTION

The FCC has adopted the guidelines for evaluating the environmental effects of radio frequency radiation in ET Docket 93-62 on Aug. 6, 1996 to protect the public and workers from the potential hazards of RF emissions due to FCC-regulated portable device.[1]

The safety limits used for the environmental evaluation measurements are based on the criteria published by the American National Standards Institute (ANSI) For localized specific absorption rate (SAR) in IEEE/ANSI C95.1-2005 Standard for safety Levels with Respect to Human Exposure to Radio Frequency Electronic Fields, 3 kHz to 300 GHz. (c) 1992 by the institute of Electrical and Electronics Engineers, Inc., New York, New York 10017.[2] The measurement procedure described in IEEE/ANSIC95.3-2005 Recommended Practice for the Measurement of Potentially Hazardous Electromagnetic Fields – RF and Microwave[3] is used for guidance in measuring SAR due to the RF radiation exposure from the Equipment Under Test (EUT). These criteria for SAR evaluation are similar to those recommended by the National Council on Radiation Protection and Measurements (ICNIRP) in Biological Effects and Exposure Criteria for Radio Frequency Electromagnetic Fields,” ICNIRP Report No. 86 (c) ICNIRP, 1986, Bethesda, MD20814.[6] SAR is a measure of the rate of energy absorption due to exposure to an RF transmitting source. SAR values have been related to threshold levels for potential biological hazards.

SAR Definition

Specific Absorption Rate (SAR) is defined as the time derivative (rate) of the incremental energy (dU) absorbed by (dissipated in) an incremental mass (dm) contained in a volume element (dV) of a given density (ρ). it is also defined as the rate of rf energy absorption per unit mass at a point in an absorbing body. (see Fig. 2.1.)

$$SAR = \frac{d}{dt} \left(\frac{dU}{dm} \right) = \frac{d}{dt} \left(\frac{dU}{\rho dV} \right)$$

Figure 2.1 SAR Mathematical Equation

SAR is expressed in units of Watts per Kilogram (W/kg).

$$SAR = \sigma E^2 / \rho$$

Where:

- σ = conductivity of the tissue-simulant material (S/m)
- ρ = mass density of the tissue-simulant material (kg/m^3)
- E = Total RMS electric field strength (V/m)

NOTE: The primary factors that control rate of energy absorption were found to be the wavelength of the incident field in relations to the dimensions and geometry of the irradiated organism, the orientation of the organism in relation to the polarity of field vectors, the presence of reflecting surfaces, and whether conductive contact is made by the organism with a ground plane.[6]

4. SAR MEASUREMENT SYSTEM

An SAR measurement system usually consists of a small diameter isotropic electric field probe, a multiple axis probe positioning system, a test device holder, one or more phantom models, the field probe instrumentation, a computer and other electronic equipment for controlling the probe and making the measurements. Other supporting equipment, such as a network analyzer, power meters and RF signal generators, are also required to measure the dielectric parameters of the simulated tissue media and to verify the measurement accuracy of the SAR system.

4.1 SAR Measurement Setup

Robotic System

Measurement are performed using the DASY4 dosimetric assessment system. The DASY4 is made by Schmid & Partner Engineering AG(SPEAG) in Zurich, Switzerland and consists of high precision robotics system (Stäubli), robot controller, Pentium IV computer, near-field probe, probe alignment sensor, and the SAM twin phantom containing the brain equivalent material. The robot is a six-axis industrial robot performing precise movements to position the probe to the location (points) of maximum electromagnetic field (EMF) (see Fig. 4.1)

System Hardware

A cell controller system contains the power supply, robot controller, teach pendant (Joystick), and a remote control used to drive the robot motors. The pc consists of the Intel Pentium IV 2.4 GHz computer with Windows 2000 system and SAR measurement Software DASY4, A/D interface card, monitor, mouse, and keyboard. The Stäubli Robot data acquisition electronic (DAE) circuit that performs the signal amplification, signal multiplexing, AD-conversion, offset measurements, mechanical surface detection, collision detection, etc. is connected to the Electro-optical coupler (EOC). The EOC performs the conversion from the optical into digital electric signal of the DAE and transfers data to the PC plug-in card.

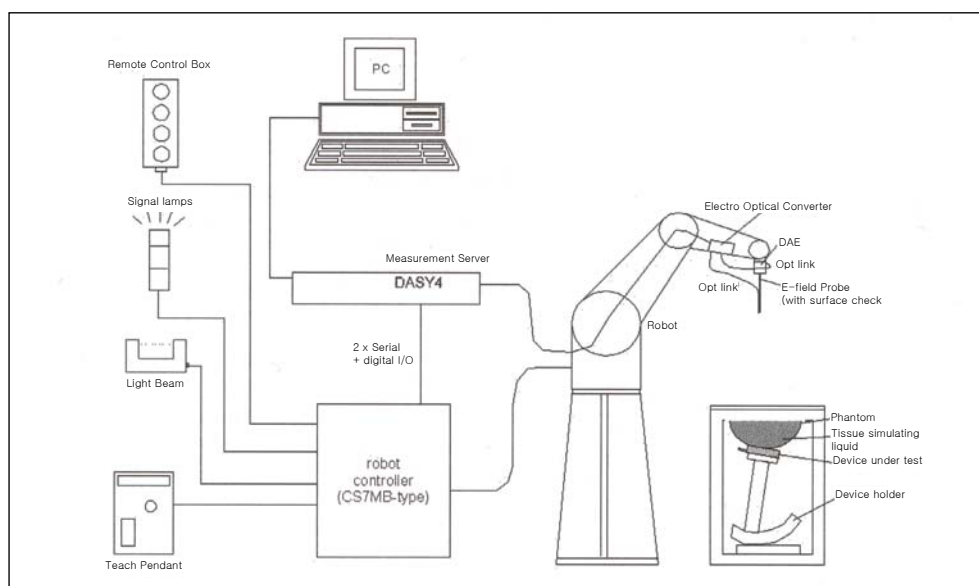

Figure 4.1 SAR Measurement System Setup

System Electronics

The DAE consists of a highly sensitive electrometer-grade preamplifier with auto-zeroing, a channel and gain-switching multiplexer, a fast 16 bit AD-converter and a command decoder and control logic unit. Transmission to the PC-card is accomplished through an optical Down,link for data and status information and an optical uplink for commands and clock lines. The mechanical probe mounting device includes two different sensor systems for frontal and sidewise probe contacts. They are also used for mechanical surface detection and probe collision detection. The robot uses its own controller with a built in VME-bus computer. The system is described in detail in [7].

4.2 DASY4 E-Field Probe System

The SAR measurements were conducted with the dosimetric probe ET3DV6, designed in the classical triangular configuration [7] (see Fig. 4.2) and optimized for dosimetric evaluation. The probe is constructed using the thick film technique; with printed resistive lines on ceramic substrates. The probe is equipped with an optical multifiber line ending at the front of the probe tip. It is connected to the EOC box in the robot arm and provides an automatic detection transmitter, the other half to a synchronized receiver. As the probe approach the surface, the reflection from the surface produces a coupling from the transmitting to the receiving fibers. This reflection increases first during the approach, reaches coupling is zero. The distance of the coupling maximum to the surface is probe angle. The DASY4 software reads the reflection during a software approach and looks for the maximum using a 2nd order fitting. The approach is stopped at reaching the maximum.

Probe Specifications

- Construction:** Symmetrical design with triangular core
 Built-in optical fiber for surface detection system
 Built-in shielding against static charges
 PEEK enclosure material (resistant to organic solvents, e.g., DGBE)
- Calibration:** Basic Broad Band Calibration: in air: 10-3000 MHz
 Conversion Factors (CF) for HSL 900 and HSL 1800
 Additional CF for other liquids and frequencies upon request
- Frequency:** 10 MHz to 3 GHz; Linearity: ± 0.2 dB (30 MHz to 3 GHz)
- Directivity:** ± 0.2 dB in HSL (rotation around probe axis)
 ± 0.4 dB in HSL (rotation normal to probe axis)
- Dynamic Range:** 5 μ W/g to > 100 mW/g; Linearity: ± 0.2 dB
- Optical Surface** ± 0.2 mm repeatability in air and clear liquids over
- Detection:** diffuse reflecting surfaces
- Dimensions:** Overall length: 330 mm (Tip: 16 mm)
 Tip diameter: 6.8 mm (Body: 12 mm)
 Distance from probe tip to dipole centers: 2.7 mm
- Application:** General dosimetric measurements up to 2.5GHz
 Compliance tests of mobile phones
 Fast automatic scanning in arbitrary phantoms

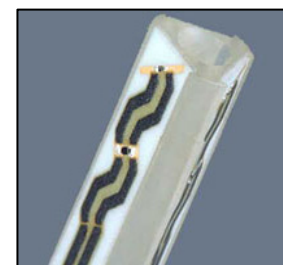

Figure 4.2 Isotropic E-Field Probe

Probe Calibration Process

Dosimetric Assessment Procedure

Each probe is calibrated according to a dosimetric assessment procedure described in [8] with accuracy better than +/- 10%. The spherical isotropy was evaluated with the procedure described in [9] and found to be better than +/-0.25dB. The sensitivity parameters (NormX, NormY, NormZ), the diode compression parameter (DCP) and the conversion factor (ConvF) of the probe is tested.

Free Space Assessment

The free space E-field from amplified probe outputs is determined in a test chamber. This is performed in a TEM cell for frequencies below 1 GHz (see Fig. 4.3), and in a waveguide above 1 GHz for free space. For the free space calibration, the probe is placed in the volumetric center of the cavity at the proper orientation with the field. The probe is then rotated 360 degrees.

Temperature Assessment *

E-field temperature correlation calibration is performed in a flat phantom filled with the appropriate simulated brain tissue. The measured free space E-field in the medium correlates to temperature rise in a dielectric medium. For temperature correlation calibration a RF transparent thermistor-based temperature probe is used in conjunction with the E-field probe. (see Fig. 4.4)

$$SAR = C \frac{\Delta T}{\Delta t}$$

$$SAR = \frac{|E|^2 \sigma}{\rho}$$

Where:

- Δt = exposure time (30 seconds),
 - C = heat capacity of tissue (brain or muscle),
 - ΔT = temperature increase due to RF exposure.
- SAR is proportional to $\Delta T/\Delta t$, the initial rate of tissue heating, before thermal diffusion takes place. Now it's possible to quantify the electric field in the simulated tissue by equating the thermally derived SAR to the E- field;

Where:

- σ = simulated tissue conductivity,
- ρ = Tissue density (1.25 g/cm³ for brain tissue)

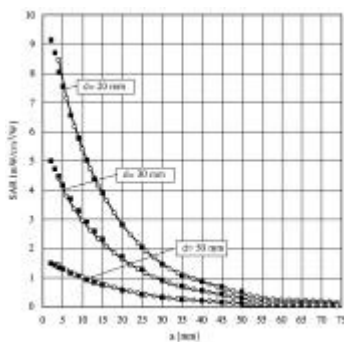

Figure 4.3 E-Field and Temperature measurements at 900MHz [7]

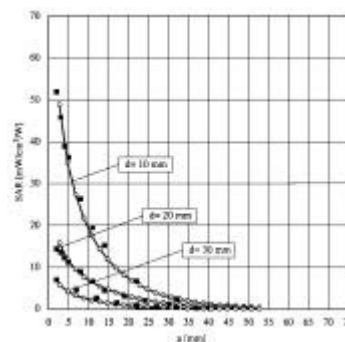

Figure 4.4 E-Field and Temperature measurements at 1.9GHz [7]

4.3 Phantom

The SAM Twin Phantom V4.0 is constructed of the fiberglass shell integrated in a wooden table. The shape of the shell is based on data from an anatomical study designed to determine the maximum exposure in at least 90% of all users [11][12]. It enables the dosimetric evaluation of left and right hand phone usage as well as body mounted usage at the flat phantom region. A cover prevents the evaporation of the liquid. Reference markings on the phantom allow the complete setup of all predefined phantom positions and measurement grids by manually teaching three points in the robot. (see Fig. 4.5)



Figure 4.5 SAM Twin Phantom

Phantom Specification

Construction:	The shell corresponds to the specifications of the Specific Anthropomorphic Mannequin (SAM) phantom defined in IEEE 1528-200X, CENELEC 50361 and IEC 62209. It enables the dosimetric evaluation of left and right hand phone usage as well as body mounted usage at the flat phantom region. A cover prevents evaporation of the liquid. Reference markings on the phantom allow the complete setup of all predefined phantom positions and measurement grids by teaching three points with the robot.
Shell Thickness:	2 ± 0.2 mm; Center ear point: 6 ± 0.2 mm
Filling:	Volume Approx. 25 liters
Dimensions:	Height: adjustable feet; Length: 1000 mm; Width: 500 mm

4.4 Brain & Muscle Simulating Mixture Characterization

The brain and muscle mixtures consist of a viscous gel using hydroxethylcellulose(HEC) gelling agent and saline solution (see Table 4.1). Preservation with a bacteriacide is added and visual inspection is made to make sure air bubbles are not trapped during the mixing process. The mixture is calibrated to obtain proper dielectric constant (permittivity) and conductivity of the desired tissue. The head tissue dielectric parameters recommended by the IEEE SCC-34/SC-2 have been specified in P1528 are derived from the issue dielectric parameters computed from the 4-Cole-Cole equations The mixture characterizations used for the brain and muscle tissue simulation liquids are according to the data by C. Gabriel and G. Hartagrove [13]. (see Table 4.2)

INGREDIENTS (% by weight)	900MHz	1800MHz	1900MHz	2450MHz
De-ionized water	40.92	52.64	54.90	45.00
DGBE	-	47.00	44.94	55.00
SUGAR	56.50	-	-	-
SALT	1.48	0.36	0.18	-
BACTERIACIDE	0.10	-	-	-
HEC	1.00	-	-	-
Dielectric Constant Target	41.50	40.00	40.00	38.20
Conductivity (S/m) Target	0.97	1.40	1.40	1.80

Table. 4.1 Composition of the Tissue Equivalent Matter

4.5 Device Holder for Transmitters

In combination with the SAM Twin Phantom V4.0, the Mounting Device (see Fig. 4.6) enables the rotation of the accurately, and repeatably be positioned according to the IEC, IEEE, CENELEC, FCC specifications. The device holder can be locked at different phantom locations (left head, right head, flat phantom).

*Note : A simulating human hand is not used due to the complex anatomical and geometrical structure of the hand that may produce infinite number of configurations [12]. To produce the worst-case condition (the hand absorbs antenna output power), the hand is omitted during the tests.



Figure. 4.6 Device Holder

4.6 Validation Dipole

The reference dipole should have a return loss better than -20 dB (measured in the setup) at the resonant frequency to reduce the uncertainty in the power measurement.

Validation Dipole Specifications

- Construction:** Symmetrical dipole with 1/4 balun. Enables measurement of feedpoint impedance with NWA. Matched for use near flat phantoms filled with head simulating solutions. Includes distance holder and tripod adaptor.
- Calibration:** Calibrated SAR value for specified position and input power at the flat phantom in simulating solution
- Frequency:** 835 MHz, 1900 MHz
- Return Loss:** > 20 dB at specified validation position
- Power Capability:** > 100 W (f < 1GHz); > 40 W (f > 1GHz)
- Dimensions:**
 - D835V2: dipole length: 161 mm; overall height: 330 mm
 - D1900V2: dipole length: 68 mm; overall height: 300 mm



Figure 4.7 Validation Dipole

5. SAR MEASUREMENT PROCEDURE

The evaluation was performed using the following procedure:

- 1) The SAR measurement was taken at a selected spatial reference point to monitor power variations during testing. This fixed location point was measured and used as a reference value.
- 2) The SAR distribution at the exposed side of the head was measured at a distance of 3.9mm from the inner surface of the shell. The area covered the entire dimension of the head and the horizontal grid spacing was 15mm x 15mm.
- 3) Based on the area scan data, the area of the maximum absorption was determined by spline interpolation. Around this point, a volume of 32mm x 32mm x 34mm (fine resolution volume scan, zoom scan) was assessed by measuring 5 x 5 x 7 points. On this basis of this data set, the spatial peak SAR value was evaluated with the following procedure:
 - a. The data at the surface was extrapolated, since the center of the dipoles is 2.7mm away from the tip of the probe and the distance between the surface and the lowest measuring point is 1.2mm. The extrapolation was based on a least square algorithm [15]. A polynomial of the fourth order was calculated through the points in z-axes. This polynomial was then used to evaluate the points between the surface and the probe tip.
 - b. The maximum interpolated value was searched with a straight-forward algorithm. Around this maximum the SAR values averaged over the spatial volumes (1g or 10g) were computed using the 3D-Spline interpolation algorithm. The 3D-spline is composed of three one-dimensional splines with the "Not a knot" condition (in x, y, and z directions) [15][16]. The volume was integrated with the trapezoidal algorithm. One thousand points (10 x 10 x 10) were interpolated to calculate the average.
 - c. All neighboring volumes were evaluated until no neighboring volume with a higher average value was found.
- 4) The SAR reference value, at the same location as procedure #1, was re-measured. If the value changed by more than 5%, the evaluation is repeated.

6. DEFINITION OF REFERENCE POINT

6.1 EAR Reference Point

Figure 6.1 shows the front, back and side views of the SAM Twin Phantom. The point “M” is the reference point for the center of the mouth, “LE” is the left ear reference point (ERP), and “RE” is the right ERP. The ERPs are 15mm posterior to the entrance to the ear canal (EEC) along the B-M line (Back-Mouth), as shown in Figure 6.2. The plane passing through the two ear canals and M is defined as the Reference Plane. The line N-F (Neck-Front) is perpendicular to the reference plane and passing through the RE (or LE) is called the Reference Pivoting Line (see Fig. 6.3). Line B-M is perpendicular to the N-F line. Both N-F and B-M lines are marked on the external phantom shell to facilitate handset positioning [5].

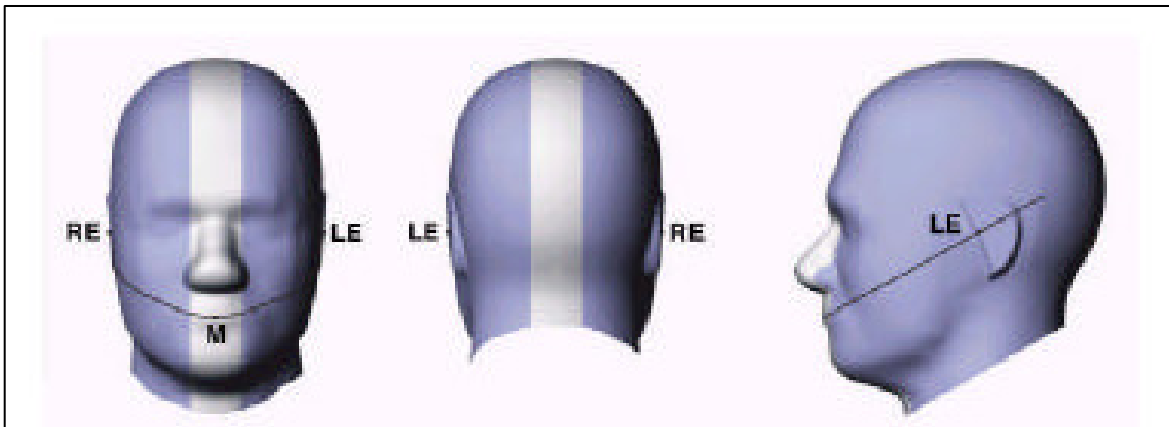

Figure 6.1 Front, back and side view of SAM Twin Phantom

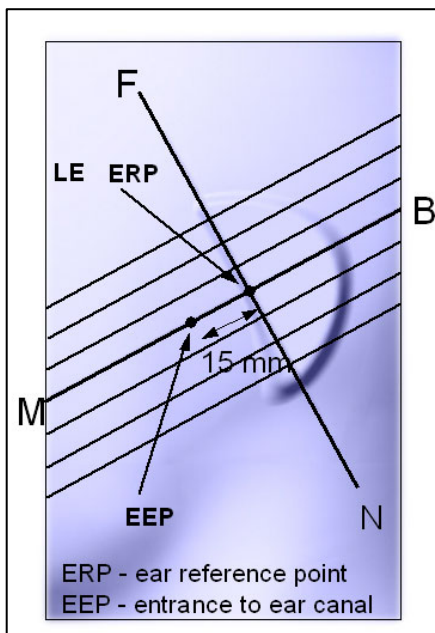

Figure 6.2 Close-Up, side view of ERP

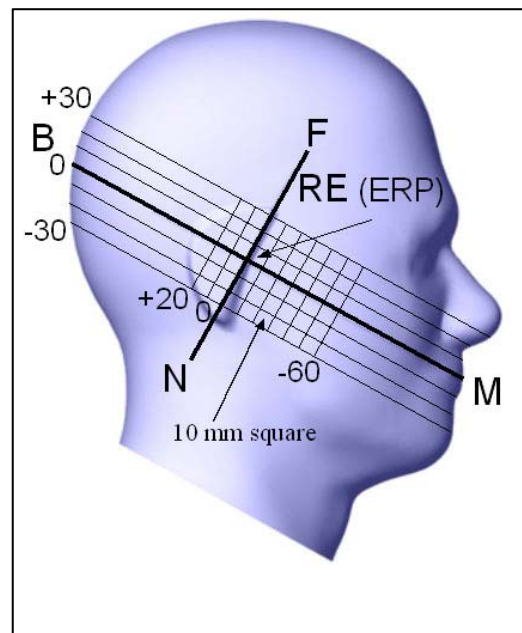

Figure 6.3 Side view of the phantom showing relevant markings

6.2 Handset Reference Points

Two imaginary lines on the handset were established: the vertical centerline and the horizontal line. The test device was placed in a normal operating position with the “test device reference point” located along the “vertical centerline” on the front of the device aligned to the “ear reference point” (see Fig. 6.4). The “test device reference point” was then located at the same level as the center of the ear reference point. The test device was positioned so that the “vertical centerline” was bisecting the front surface of the handset at its top and bottom edges, positioning the “ear reference point” on the outer surface of the both the left and right head phantoms on the ear reference point.

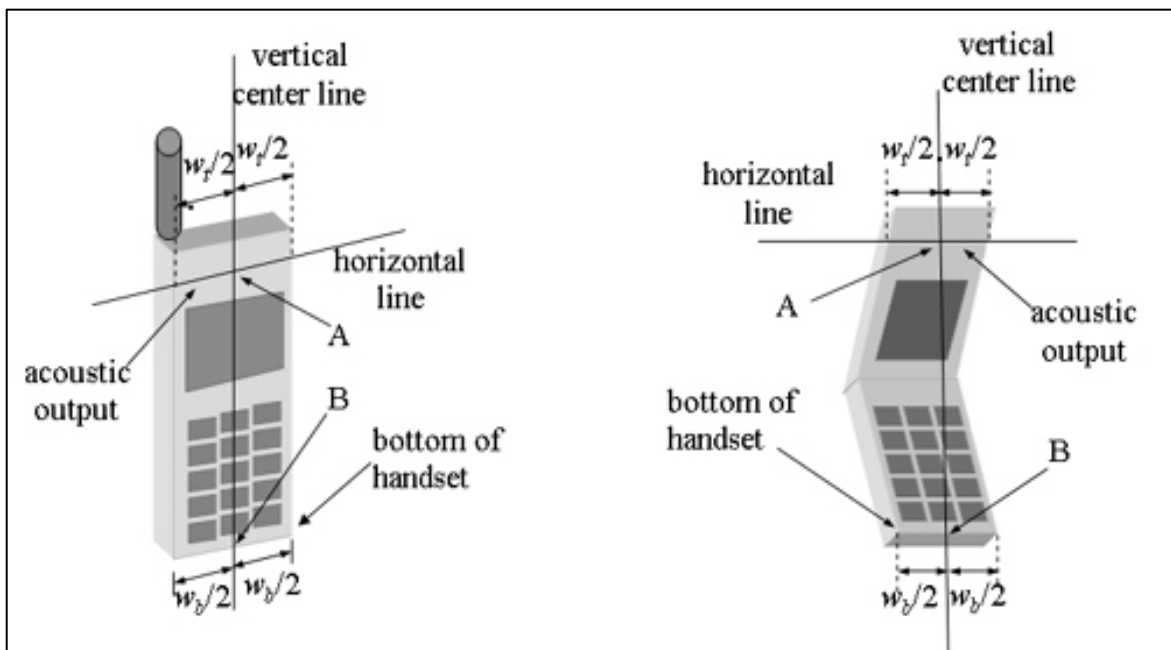

Figure 6.4 Handset Vertical Center & Horizontal Line Reference Points

7. TEST CONFIGURATION POSITIONS

7.1 Positioning for Cheek/Touch

- 1) Ready the handset for talk operation, if necessary. For example, for handsets with a cover piece, open the cover. (If the phone can also be used with the cover closed, both configurations must be tested.)
- 2) Define two imaginary lines on the handset: the vertical centerline and the horizontal line. The vertical centerline passes through two points on the front side of the handset: the midpoint of the width w_t of the handset at the level of the acoustic output (point A on Fig. 6.4), and the midpoint of the width w_b of the bottom of the handset (point B). The horizontal line is perpendicular to the vertical centerline and passes through the center of the acoustic output (see Fig. 6.4). The two lines intersect at point A. Note that for many handsets, point A coincides with the center of the acoustic output. However, the acoustic output may be located elsewhere on the horizontal line. Also note that the vertical centerline is not necessarily parallel to the front face of the handset (see Fig. 6.4), especially for clamshell handsets, handsets with lip pieces, and other irregularly-shaped handsets.
- 3) Position the handset close to the surface of the phantom touch that point A is on the (virtual) extension of the line passing through points RE and LE on the phantom (see Fig. 7.1), such that the plane defined by the vertical center line and the horizontal line of the phone is approximately parallel to the sagittal plane of the phantom.
- 4) Translate the handset towards the phantom along the line passing through RE and LE until the handset touches the ear.
- 5) While maintaining the handset in this plane, rotate it around the LE-RE line until the vertical centerline is in the plane normal to MB-NF including the line MB (called the reference plane).
- 6) Rotate the phone around the vertical centerline until the phone (horizontal line) is symmetrical with respect to the line NF.
- 7) While maintaining the vertical centerline in the reference plane, keeping point A on the line passing through RE and LE, and maintaining the phone contact with the ear, rotate the handset about the line NF until any point on the handset is in contact with a phantom point below the pinna (cheek). (see Fig. 7.1) The physical angles of rotation should be noted.

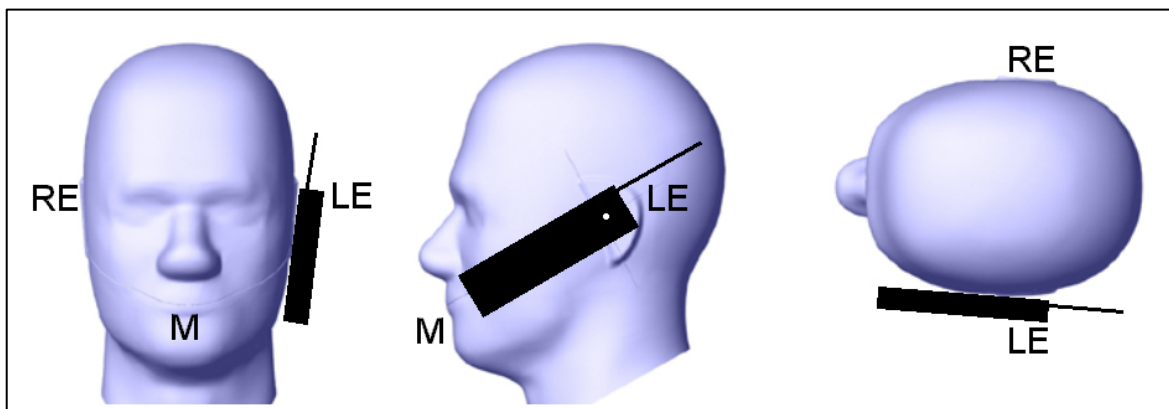

Figure 7.1 Front, Side and Top View of Cheek/Touch Position

7.2 Positioning for Ear / 15° Tilt

With the test device aligned in the “Cheek/Touch Position”:

- 1) While maintaining the orientation of the phone retract the phone parallel to the reference plane far enough to enable a rotation of the phone by 15 degree.
- 2) Rotate the phone around the horizontal line by 15 degree.
- 3) While maintaining the orientation of the phone, move the phone parallel to the reference plane until any part of the phone touches the head. (In this position, point A will be located on the line RE-LE). The tilted position is obtained when the contact is on the pinna. If the contact is at any location other than the pinna, the angle of the phone shall be reduced. The tilted position is obtained if any part of the phone is in contact of the ear as well as a second part of the phone is contact with the head. (see Fig. 7.2)

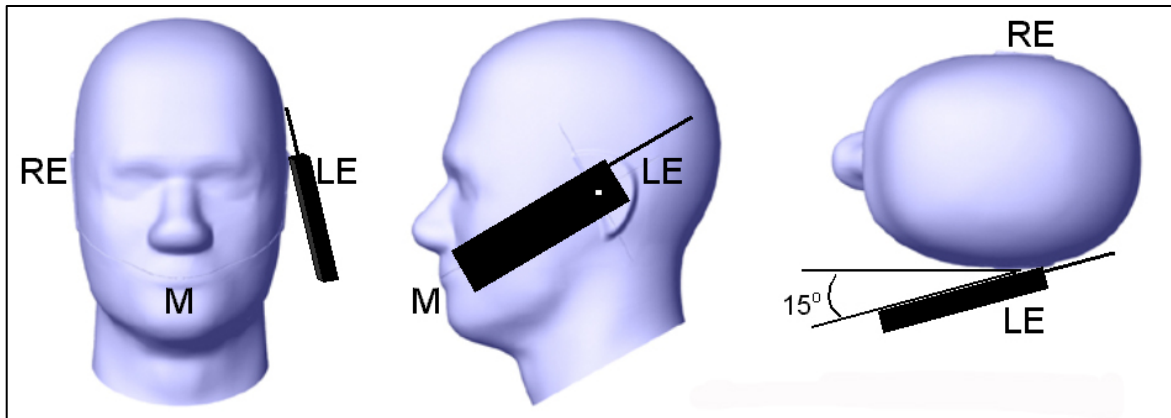

Figure 7.2 Front, Side and Top View of Ear/15 Tilt Position

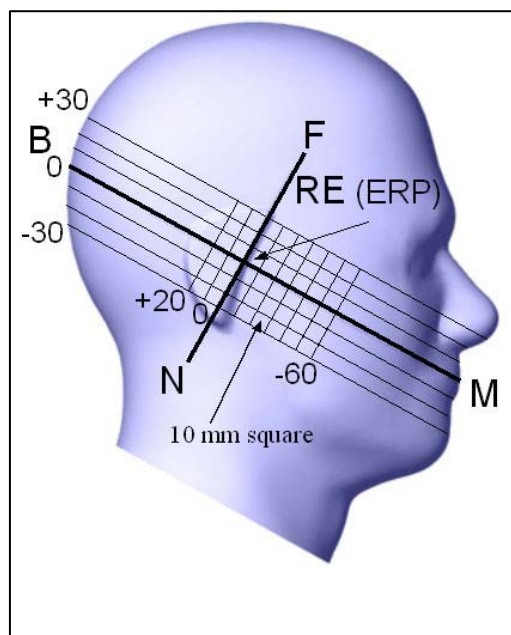

Figure 7.3 Side view of the phantom showing relevant markings

7.3 Body Holster /Belt Clip Configurations

Body-worn operation configurations are tested with the belt-clips and holsters attached to the device and positioned against a flat phantom in a normal use configuration. (see Fig. 7.4) A device with a headset output is tested with a headset connected to the device. Body dielectric parameters are used.

Accessories for Body-worn operation configurations are divided into two categories: those that do not contain metallic components and those that do contain metallic components. When multiple accessories that do not contain metallic components are supplied with the device, the device is tested with only the accessory that dictates the closest spacing to the body. Then multiple accessories that contain metallic components are supplied with the device, the device is tested with each accessory that contains a unique metallic component. If multiple accessories share an identical metallic component (i.e. the same metallic belt-clip used with different holsters with no other metallic components) only the accessory that dictates the closest spacing to the body is tested.

Body-worn accessories may not always be supplied or available as options for some devices intended to be authorized for body-worn use. In this case, a test configuration where a separation distance between the back of the device and the flat phantom is used. All test position spacings are documented.

Transmitters that are designed to operate in front of a person's face, as in push-to-talk configurations, are tested for SAR compliance is tested with the accessory(ies), including headsets and microphones, attached to the device and positioned against a flat phantom in a normal use configuration.

In all case SAR measurements are performed to investigate the worst case positioning. Worst-case positioning is then documented and used to perform Body SAR testing.



Figure 7.4 Body Holster Configuration

8. MEASUREMENT UNCERTAINTY

$$U(y) = \text{root} [(C_1^2 U_{pc}^2 / d_1) + (U_{ai}^2) + (U_{hi}^2) + (C_4^2 U_{be}^2) + (C_5^2 U_{li}^2) + (C_6^2 U_{dl}^2) + (C_7^2 U_{re}^2 / d_7) + (C_8^2 U_{rt}^2) + (C_9^2 U_{it}^2) + (C_{10}^2 U_{an}^2) + (C_{10}^2 U_{ar}^2) + (C_{11}^2 U_{pm}^2) + (C_{12}^2 U_{pp}^2) + (C_{13}^2 U_{ei}^2) + (C_{14}^2 U_{pu}^2) + (C_{15}^2 U_{ct}^2) + (C_{16}^2 U_{lc}^2 / d_{16}) + (C_{17}^2 U_{lp}^2) + (C_{18}^2 U_{lp}^2 / d_{18})]$$

	Description	Type	Prob. Dist.	Divider	Ci	Std. Unc	Veff
Measure. Equipment	U(pc) Probe Calibration	B	Normal	1	1	± 5.9%	∞
	U(al) Axial Isotropy	B	Rectan.	Root 3	0.7	± 1.9%	∞
	U(hi) Hemispherical Isotropy	B	Rectan.	Root 3	0.7	± 3.9%	∞
	U(be) Boundary Effect	B	Rectan.	Root 3	1	± 0.6%	∞
	U(li) Linearity	B	Rectan.	Root 3	1	± 2.7%	∞
	U(dl) Detection Limits	B	Rectan.	Root 3	1	± 0.0%	∞
	U(re) Readout Electronics	B	Normal	1	1	± 1.0%	∞
	U(rt) Response Time	B	Rectan.	Root 3	1	± 0.0%	∞
	U(it) Integration Time	B	Rectan.	Root 3	1	± 1.0%	∞
	U(an) RF Ambient Conditions-Noise	B	Rectan.	Root 3	1	± 1.7%	∞
	U(ar) RF Ambient Conditions-Reflection	B	Rectan.	Root 3	1	± 1.7%	∞
	U(pm) Probe Positioner Mechanical	B	Rectan.	Root 3	1	± 0.9%	∞
	U(pp) Probe Positioning w/ Phantom	B	Rectan.	Root 3	1	± 1.7%	∞
U(ei) Extrapolation and Integration	B	Rectan.	Root 3	1	± 0.6%	∞	
Test Sample	U(dp) Device Positioning	A	Normal	1	1	± 2.8%	36
	U(dh) Device Holder Uncertainty	B	Normal	1	1	± 3.6%	5
	U(op) Drift of Output Power	B	Rectan.	Root 3	1	± 2.9%	∞
Physical Parameter	U(pu) Phantom Uncertainty	B	Rectan.	Root 3	1	± 2.3%	∞
	U(ct) Liquid Conductivity (Target)	B	Rectan.	Root 3	0.64	± 1.8%	∞
	U(lc) Liquid Conductivity (Measurement)	B	Normal	1	0.64	± 1.6%	∞
	U(lp) Liquid Permittivity (Target)	B	Rectan.	Root 3	0.6	± 1.7%	∞
	U(lp) Liquid Permittivity (Measurement)	B	Normal	1	0.6	± 1.5%	∞
Uc(y) Combined	± 10.4 %						
Expanded	± 20.8 % (k =2)						

Table 6.1 Worst-Case uncertainty budget for DASY4 assessed according to IEC 62209-1. The budget is valid for the frequency range 300MHz-3GHz and represents a worst-case analysis.

9. ANSI/IEEE C95.1 –2005 RF EXPOSURE LIMITS

Uncontrolled Environment

UNCONTROLLED ENVIRONMENTS are defined as locations where there is the exposure of individuals who have no knowledge or control of their exposure. The general population/uncontrolled exposure limits are applicable to situations in which the general public may be exposed or in which persons who are exposed as a consequence of their employment may not be made fully aware of the potential for exposure or cannot exercise control over their exposure. Members of the general public would come under this category when exposure is not employment-related; for example, in the case of a wireless transmitter that exposes persons in its vicinity.

Controlled Environment

CONTROLLED ENVIRONMENTS are defined as locations where there is exposure that may be incurred by persons who are aware of the potential for exposure, (i.e. as a result of employment or occupation). In general, occupational/controlled exposure limits are applicable to situations in which persons are exposed as a consequence of their employment, who have been made fully aware of the potential for exposure and can exercise control over their exposure. This exposure category is also applicable when the exposure is of a transient nature due to incidental passage through a location where the exposure levels may be higher than the general population/uncontrolled limits, but the exposed person is fully aware of the potential for exposure and can exercise control over his or her exposure by leaving the area or by some other appropriate means.

	UNCONTROLLED ENVIRONMENT General Population (W/kg) or (mW/g)	CONTROLLED ENVIRONMENT General Population (W/kg) or (mW/g)
SPATIAL PEAK SAR¹ Brain	1.60	8.00
SPATIAL PEAK SAR² Whole Body	0.08	0.40
SPATIAL PEAK SAR³ Hands, Feet, Ankles, Wrists	4.00	20.00

Table 9.1 Safety Limits for Partial Body Exposure [2]

NOTE:

- 1 The Spatial Peak value of the SAR averaged over any 1 gram of tissue (defined as a tissue volume in the shape of a cube) and over the appropriate averaging time.
- 2 The Spatial Average value of the SAR averaged over the whole body.
- 3 The Spatial Peak value of the SAR averaged over any 10 grams of tissue (defined as a tissue volume in the shape of a cube) The Spatial Peak value of the SAR averaged over any 10 grams of tissue (defined as a tissue volume in the shape of a cube)

10. SYSTEM VERIFICATION

Tissue Verification

MEASURED TISSUE PARAMETERS								
Liquid Temp (°C)	21.8							
Liquid Depth (mm)	150 ± 1							
Tissue	835MHz Brain		835MHz Muscle		1900MHz Brain		1900MHz Muscle	
Date	10/16/2009		10/16/2009		10/17/2009		10/17/2009	
Parameters	Target	Measured	Target	Measured	Target	Measured	Target	Measured
Dielectric Constant: ϵ	41.5	40.3	55.2	53.7	40.0	39.9	53.3	54.1
Conductivity: σ	0.90	0.88	0.97	0.94	1.40	1.43	1.52	1.53
Deviation (%)	ϵ :-2.89 σ :-2.22		ϵ :-2.71 σ :-3.09		ϵ :-0.25 σ :+2.14		ϵ :+1.50 σ :+0.65	

Table 10.1 Simulated Tissue Verification

Test System Validation

Prior to assessment, the system is verified to the ±10% of the specifications at 835MHz and 1900MHz by using the system validation kit(s). (Graphic Plots Attached)

SYSTEM DIPOLE VALIDATION TARGET & MEASURED						
Tissue	System Validation Kit	Date	Liquid Temp (°C)	Targeted SAR _{1g} (mW/g)	Measured SAR _{1g} (mW/g)	Deviation (%)
835MHz Brain	D835V2, S/N: 471	10/16/2009	21.8	9.66	9.4	-2.69
1900MHz Brain	D1900V2, S/N: 5d057	10/17/2009	21.8	39.5	40.4	+2.27

Table 10.2 System Validation

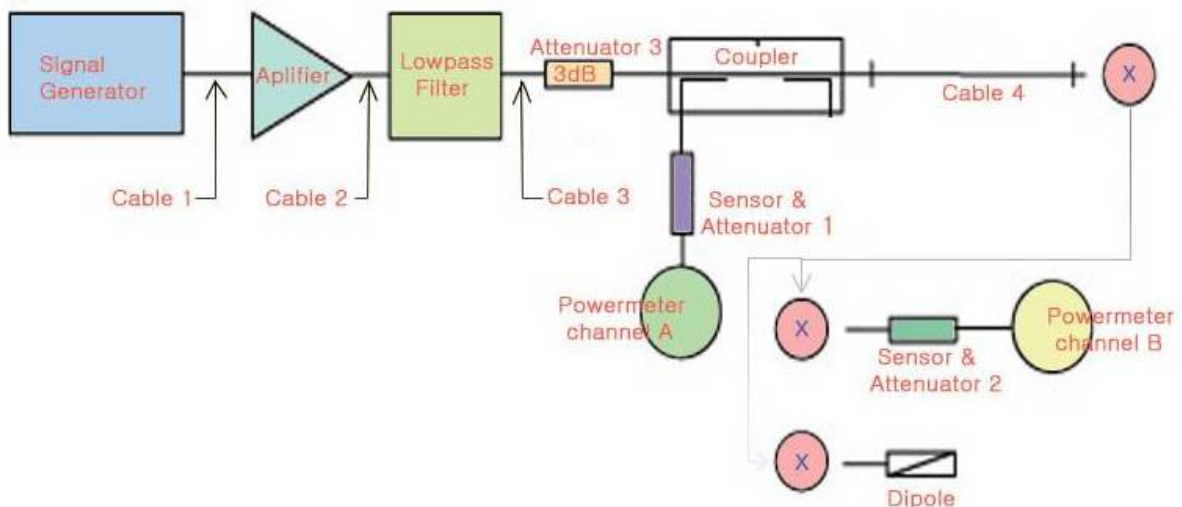
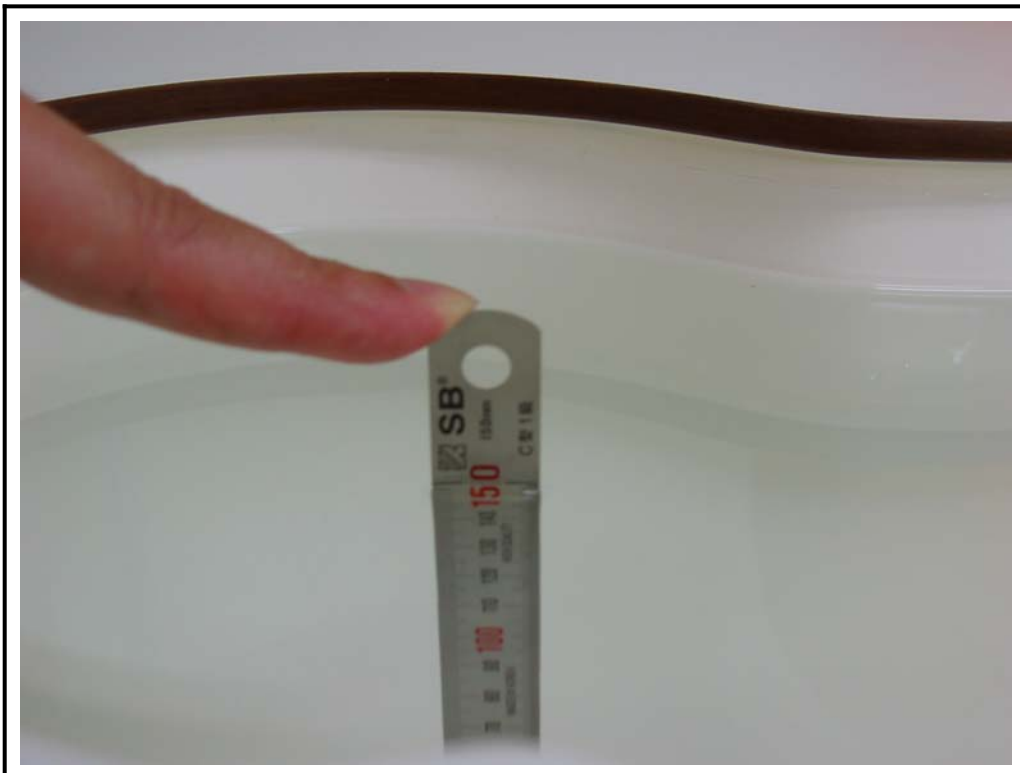

Figure 10.1 Dipole Validation Test Setup

835 MHz Liquid Depth



1900 MHz Liquid Depth



11. RF CONDUCTED POWER

Power measurements were performed using a base station simulator under digital average power

11.1 Procedures Used To Establish Test Signal

The handset was placed into a simulated call using a base station simulator in a shielded chamber. Such test signals offer a consistent means for testing SAR and are recommended for evaluating SAR. SAR measurements were taken with a fully charged battery. In order to verify that the device was tested and maintained at full power, this was configured with the base station simulator. The SAR measurement software calculates a reference point at the start and end of the test to check for power drifts. If conducted power deviations of more than 5% occurred, the tests were repeated.

Average Output Power Measurement for FCC ID: BEJGS107A

Band	Channel	Voice
		GSM (dBm)
GSM 850	128	32.92
	190	32.98
	251	32.96
GSM 1900	512	29.42
	661	29.44
	810	29.3

11.1 GSM Conducted Output Powers

12. MEASUREMENT RESULTS (Continued)

Measurement Results

ANSI / IEEE C95.1- 2005 - SAFETY LIMIT Spatial Peak Uncontrolled Exposure/General Population	Brain 1.6 W/kg averaged over 1 gram
---	--

MEASUREMENT RESULTS (Head SAR)								
Frequency		Mod.	Conducted Power (dBm)		Battery	Device Test Position	Antenna Position	SAR (W/kg)
MHz	Ch.		Start	End				
836.60	190	GSM 850	32.98	32.88	Standard	Right Touch	Fixed	1.12
836.60	190	GSM 850	32.98	32.86	Standard	Right Tilt	Fixed	0.535
836.60	190	GSM 850	32.98	32.79	Standard	Left Touch	Fixed	1.17
836.60	190	GSM 850	32.98	32.81	Standard	Left Tilt	Fixed	0.485
824.20	128	GSM 850	32.92	32.89	Standard	Left Touch	Fixed	1.10
848.80	251	GSM 850	32.96	32.88	Standard	Left Touch	Fixed	0.987
836.60	190	GSM 850	32.98	32.79	Standard	Left Touch (Z-Scan)	Fixed	1.17

1. The test data reported are the worst-case SAR value with the position set in a typical configuration. Test procedures used are according to FCC/OET Bulletin 65, Supplement C [July 2001].
2. All modes of operation were investigated, and worst-case results are reported.
3. Battery is fully charged for all readings. Standard batteries are the only options.
4. Tissue parameters and temperatures are listed on the SAR plots.
5. Justification for reduced test configurations: Per FCC/OET Bulletin 65 Supplement C [July 2001], if the SAR measured at the middle channel for each test configuration (left, right, cheek/touch, tilt/ear, extended and retracted) is at least 3.0dB lower than the SAR limit, testing at the high and low channels is optional for such test configuration(s).



Eui - Soon Park
 E. S. Park / Technical Manager
 MCCL

12. MEASUREMENT RESULTS (Continued)

Measurement Results

ANSI / IEEE C95.1- 2005 - SAFETY LIMIT Spatial Peak Uncontrolled Exposure/General Population	Brain 1.6 W/kg averaged over 1 gram
---	--

MEASUREMENT RESULTS (Head SAR)								
Frequency		Mod.	Conducted Power (dBm)		Battery	Device Test Position	Antenna Position	SAR (W/kg)
MHz	Ch.		Start	End				
1880.00	661	PCS 1900	29.44	29.45	Standard	Right Touch	Fixed	0.985
1880.00	661	PCS 1900	29.44	29.46	Standard	Right Tilt	Fixed	0.378
1880.00	661	PCS 1900	29.44	29.45	Standard	Left Touch	Fixed	0.780
1880.00	661	PCS 1900	29.44	29.47	Standard	Left Tilt	Fixed	0.281
1850.20	512	PCS 1900	29.42	29.44	Standard	Right Touch	Fixed	0.873
1909.80	810	PCS 1900	29.43	29.45	Standard	Right Touch	Fixed	1.14
1909.80	810	PCS 1900	29.43	29.45	Standard	Right Touch (Z-Scan)	Fixed	1.14

1. The test data reported are the worst-case SAR value with the position set in a typical configuration. Test procedures used are according to FCC/OET Bulletin 65, Supplement C [July 2001].
2. All modes of operation were investigated, and worst-case results are reported.
3. Battery is fully charged for all readings. Standard batteries are the only options.
4. Tissue parameters and temperatures are listed on the SAR plots.
5. Justification for reduced test configurations: Per FCC/OET Bulletin 65 Supplement C [July 2001], if the SAR measured at the middle channel for each test configuration (left, right, cheek/touch, tilt/ear, extended and retracted) is at least 3.0dB lower than the SAR limit, testing at the high and low channels is optional for such test configuration(s).



Eui - Soon Park
 E. S. Park / Technical Manager
 MCCL

12. MEASUREMENT RESULTS (Continued)

Measurement Results

ANSI / IEEE C95.1- 2005 - SAFETY LIMIT Spatial Peak Uncontrolled Exposure/General Population	Muscle 1.6 W/kg averaged over 1 gram
---	---

MEASUREMENT RESULTS (Body SAR)								
Frequency		Mod.	Conducted Power (dBm)		Battery	Device Test Position	Antenna Position	SAR (W/kg)
MHz	Ch.		Start	End				
836.60	190	GSM 850	32.98	32.88	Standard	20mm [Front]	Fixed	0.316
836.60	190	GSM 850	32.98	32.82	Standard	20mm [Rear]	Fixed	0.377
836.60	190	GSM 850	32.98	32.82	Standard	20mm [Rear] (Z-Scan)	Fixed	0.377

1. The test data reported are the worst-case SAR value with the position set in a typical configuration. Test procedures used are according to FCC/OET Bulletin 65, Supplement C [July 2001].
2. All modes of operation were investigated, and worst-case results are reported.
3. Battery is fully charged for all readings. Standard batteries are the only options.
4. Tissue parameters and temperatures are listed on the SAR plots.
5. Justification for reduced test configurations: Per FCC/OET Bulletin 65 Supplement C [July 2001], if the SAR measured at the middle channel for each test configuration (left, right, cheek/touch, tilt/ear, extended and retracted) is at least 3.0dB lower than the SAR limit, testing at the high and low channels is optional for such test configuration(s).



Eui - Soon Park
 E. S. Park / Technical Manager
 MCCL

12. MEASUREMENT RESULTS

Measurement Results

ANSI / IEEE C95.1- 2005 - SAFETY LIMIT Spatial Peak Uncontrolled Exposure/General Population	Muscle 1.6 W/kg averaged over 1 gram
---	---

MEASUREMENT RESULTS (Body SAR)								
Frequency		Mod.	Conducted Power (dBm)		Battery	Device Test Position	Antenna Position	SAR (W/kg)
MHz	Ch.		Start	End				
1880.00	661	PCS 1900	29.44	29.45	Standard	20mm [Front]	Fixed	0.271
1880.00	661	PCS 1900	29.44	29.46	Standard	20mm [Rear]	Fixed	0.323
1880.00	661	PCS 1900	29.44	29.46	Standard	20mm [Rear] (Z-Scan)	Fixed	0.323

1. The test data reported are the worst-case SAR value with the position set in a typical configuration. Test procedures used are according to FCC/OET Bulletin 65, Supplement C [July 2001].
2. All modes of operation were investigated, and worst-case results are reported.
3. Battery is fully charged for all readings. Standard batteries are the only options.
4. Tissue parameters and temperatures are listed on the SAR plots.
5. Justification for reduced test configurations: Per FCC/OET Bulletin 65 Supplement C [July 2001], if the SAR measured at the middle channel for each test configuration (left, right, cheek/touch, tilt/ear, extended and retracted) is at least 3.0dB lower than the SAR limit, testing at the high and low channels is optional for such test configuration(s).



Eui - Soon Park
 E. S. Park / Technical Manager
 MCCL

13. TEST EQUIPMENT

Equipment List and Calibration Lab No.1

Name of Equipment	Manufacturer	Model Type	Serial Number	Cal. Due date
Robot	Stäubli	RX90BL	5L74A1	N/A
SAM Twin Phantom	SPEAG	V4.0	TP-1066	N/A
SAM Twin Phantom	SPEAG	V4.0	TP-1244	N/A
DAE	SPEAG	DAE4	646	05/25/10
E-Field Probe	SPEAG	ET3DV6	1729	01/20/10
Validation Dipole 835MHz	SPEAG	D835V2	471	01/19/11
Validation Dipole 1900MHz	SPEAG	D1900V2	5d057	04/22/10
S-Parameter Network Analyzer	Agilent	8753ES	MY4002948	06/22/10
Dielectric Probe Kit	Agilent	85070D	US01440173	N/A
Signal Generator	Agilent	E4421B	MY41000790	03/04/10
High Power RF Amplifier	EM Power	BBS3Q7ECK	1014	03/04/10
Dual Direction Coupler	Agilent	778D-012	50344	06/22/10
EPM-Series Power Meter	Agilent	E4419B	GB39290525	04/15/10
Power Sensor	Agilent	8481A	MY41092723	04/16/10
Power Sensor	Agilent	8481A	MY41092718	04/16/10
Attenuator	Agilent	8491A	59049	03/04/10
Low Pass Filter 1.5 GHz	Dymstec	LA-15N	-	N/A
Low Pass Filter 3.0 GHz	Dymstec	LA-30N	-	N/A
Thermometer/Hygrometer	SATO	SK-L200TH	8440587	06/26/10
Wireless Communication Test	Agilent	E5515C	GB4400522	03/04/10

Table 13.1 Test Equipment List and Calibration

NOTE:

The E-field probe was calibrated by SPEAG, by waveguide technique procedure. Dipole Validation measurement is performed by LG Electronics. before each test. The brain simulating material is calibrated by LG Electronics using the dielectric probe system and network analyzer to determine the conductivity and permittivity (dielectric constant) of the brain-equivalent material.

14. REFERENCES

- [1] Product standard to demonstrate the compliance of mobile phone with the basic restriction related to human exposure electromagnetic(300MHz – 3GHz), CENELEC EN 50360, July 2001.
- [2] Basic standard for the measurement of Specific Absorption Rate related to human exposure to electromagnetic fields from mobile phone(300MHz – 3GHz), CENELEC EN 50361, July 2001.
- [3] Council Recommendations 1999/519/EC on the limitations of exposure of the general public to electromagnetic fields (300MHz – 3GHz) annex II
- [4] International Commission on Non-Ionising Radiation Protection (1998), Guidelines for limiting exposure in time-varying electric, magnetic, and electromagnetic field (up to 300 GHz). Health Physical 74, 494-522.
- [5] IEEE Standards Coordinating Committee 34 – IEEE Std. 1528 - 2003, Draft Recommended Practice for Determining the Peak Spatial-Average Specific Absorption Rate (SAR) in the Human Body Due to Wireless Communications Devices: Experimental Techniques.
- [6] NCRP, National Council on Radiation Protection and Measurements, Biological Effects and Exposure Criteria for Radio Frequency Electromagnetic Fields, NCRP Report No. 86, 1986. Reprinted Feb. 1995.
- [7] T. Schmid, O. Egger, N. Kuster, Automated E-field scanning system for dosimetric assessments, IEEE Transaction on Microwave Theory and Techniques, vol. 44, Jan. 1996, pp. 105-113.
- [8] K. Pokovic, T. Schmid, N. Kuster, Robust setup for precise calibration of E-field probes in tissue simulating liquids at mobile communications frequencies, ICECOM97, Oct. 1997, pp. 120-124.
- [9] K. Pokovic, T. Schmid, and N. Kuster, E-field Probe with improved isotropy in brain simulating liquids, Proceedings of the ELMAR, Zadar, Croatia, June 23-25, 1996, pp. 172-175.
- [10] Schmid & Partner Engineering AG, Application Note: Data Storage and Evaluation, June 1998, p2.
- [11] V. Hombach, K. Meier, M. Burkhardt, E. Kuhn, N. Kuster, The Dependence of EM Energy Absorption upon Human Head Modeling at 900 MHz, IEEE Transaction on Microwave Theory and Techniques, vol. 44 no. 10, Oct. 1996, pp. 1865-1873.
- [12] N. Kuster and Q. Balzano, Energy absorption mechanism by biological bodies in the near field of dipole antennas above 300MHz, IEEE Transaction on Vehicular Technology, vol. 41, no. 1, Feb. 1992, pp. 17-23.
- [13] G. Hartsgrove, A. Kraszewski, A. Surowiec, Simulated Biological Materials for Electromagnetic Radiation Absorption Studies, University of Ottawa, Bioelectromagnetics, Canada: 1987, pp. 29-36.
- [14] Q. Balzano, O. Garay, T. Manning Jr., Electromagnetic Energy Exposure of Simulated Users of Portable Cellular Telephones, IEEE Transactions on Vehicular Technology, vol. 44, no.3, Aug. 1995.
- [15] W. Gander, Computermathematick, Birkhaeuser, Basel, 1992.
- [16] W.H. Press, S.A. Teukolsky, W.T. Vetterling, and B.P. Flannery, Numerical Recipes in C, The Art of Scientific Computing, Second edition, Cambridge University Press, 1992.
- [17] N. Kuster, R. Kastle, T. Schmid, Dosimetric evaluation of mobile communications equipment with known precision, IEEE Transaction on Communications, vol. E80-B, no. 5, May 1997, pp. 645-652.
- [18] CENELEC CLC/SC111B, European Prestandard (prENV 50166-2), Human Exposure to Electromagnetic Fields High-frequency: 10kHz-300GHz, Jan. 1995.
- [19] Prof. Dr. Niels Kuster, ETH, Eidgenössische Technische Hochschule Zürich, Dosimetric Evaluation of the Cellular Phone.

APPENDIX A: Validation Test Data

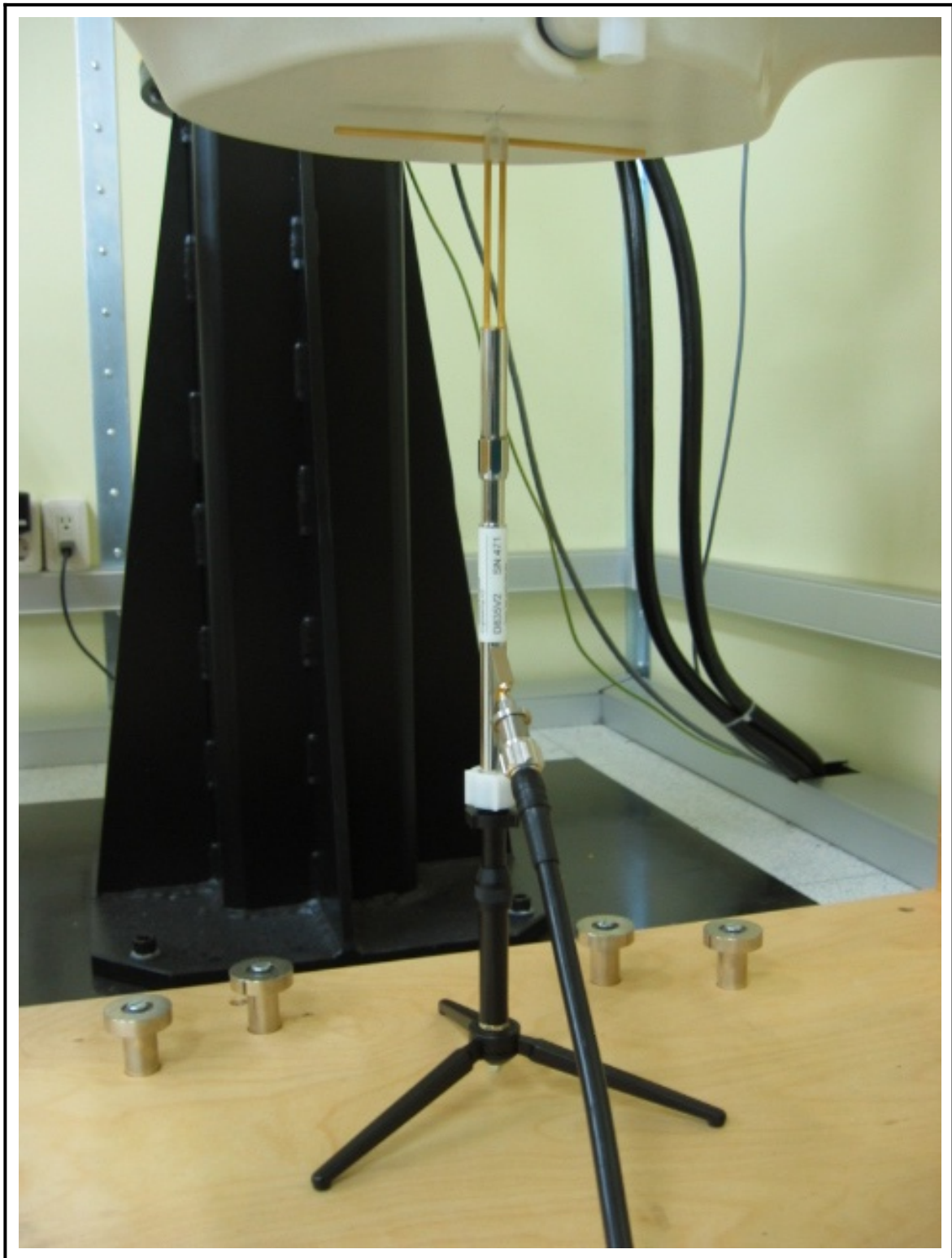

Figure 1 835 MHz Dipole Validation Test Setup



Figure 2 1900 MHz Dipole Validation Test Setup

LG Electronics Inc.

DUT: Dipole 835MHz;Type: D835V2;Serial: 471

Communication System: CW; Frequency: 835 MHz; Duty Cycle: 1:1
Medium: Head 835 MHz;(σ = 0.886 mho/m; ε_r = 40.3; ρ = 1000 kg/m³)
Phantom section: Flat Section

Test Date: 10/16/2009; Ambient Temp: 22.0°C; Tissue Temp: 21.8°C

Probe: ET3DV6 - SN1729; ConvF(6.08, 6.08, 6.08); Calibrated: 2009-01-20
Sensor-Surface: 4mm (Mechanical Surface Detection)
Electronics: DAE4 Sn646; Calibrated: 2009-05-25
Phantom: SAM with CRP 835MHz; Type: SAM; Serial: TP-1066
Measurement SW: DASY4, V4.7 Build 71; Postprocessing SW: SEMCAD, V1.8 Build 184

835 MHz Dipole Validation

Area Scan (71x71x1): Measurement grid: dx=15mm, dy=15mm
Maximum value of SAR (interpolated) = 2.49mW/g

Zoom Scan (5x5x7): Measurement grid: dx=8mm, dy=8mm, dz=5mm
Reference Value = 53.1 V/m; Power Drift = 0.001 dB
Peak SAR (extrapolated) = 4.00 W/kg
SAR(1 g) = 2.35mW/g; SAR(10 g) = 1.49mW/g
Maximum value of SAR (measured) = 2.52mW/g

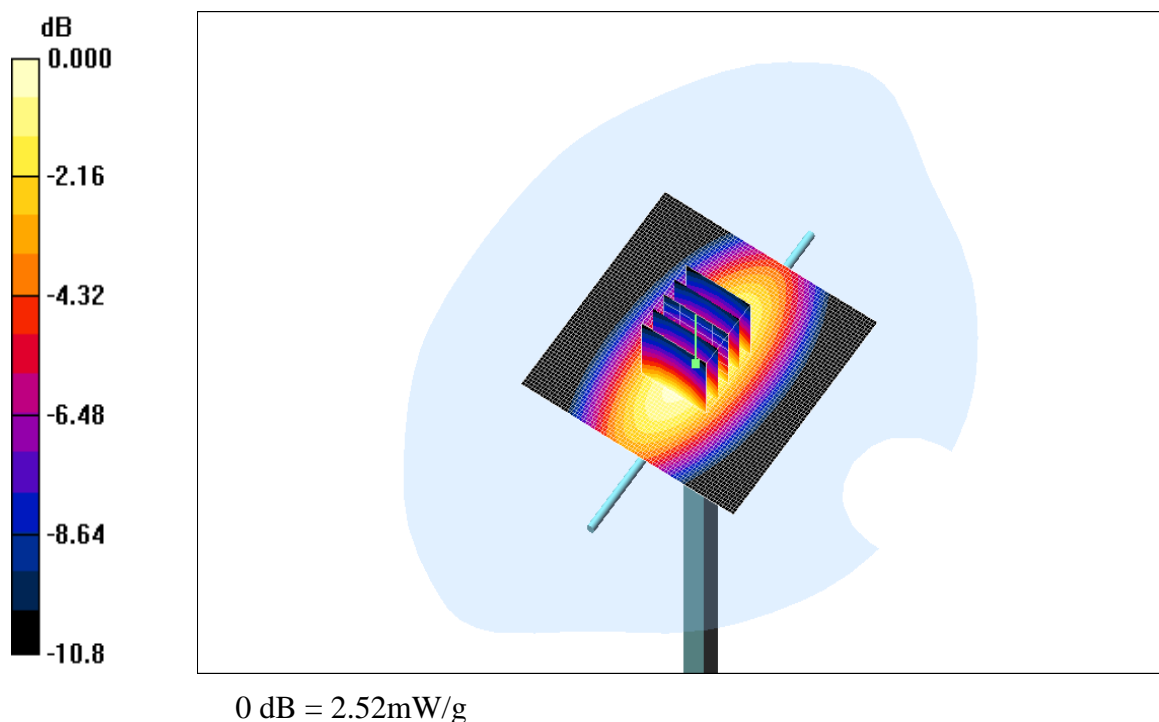

LG Electronics Inc.

DUT: Dipole 1900MHz; Type: D1900V2; Serial: 5d057

Communication System: CW; Frequency: 1900 MHz; Duty Cycle: 1:1
Medium: Head 1900 MHz; ($\sigma = 1.43\text{mho/m}$; $\epsilon_r = 39.9$; $\rho = 1000\text{ kg/m}^3$)
Phantom section: Flat Section

Test Date: 10/17/2009; Ambient Temp: 22.0°C; Tissue Temp: 21.8°C

Probe: ET3DV6 - SN1729; ConvF(4.96, 4.96, 4.96); Calibrated: 2009-01-20
Sensor-Surface: 4mm (Mechanical Surface Detection)
Electronics: DAE4 Sn646; Calibrated: 2009-05-25
Phantom: SAM with CRP 1800MHz; Type: SAM; Serial: TP-1244
Measurement SW: DASY4, V4.7 Build 71; Postprocessing SW: SEMCAD, V1.8 Build 184

1900 MHz Dipole Validation

Area Scan (71x71x1): Measurement grid: dx=15mm, dy=15mm
Maximum value of SAR (interpolated) = 11.7mW/g

Zoom Scan (5x5x7): Measurement grid: dx=8mm, dy=8mm, dz=5mm
Reference Value = 88.4 V/m; Power Drift = -0.084 dB
Peak SAR (extrapolated) = 22.1 W/kg
SAR(1 g) = 10.1mW/g; SAR(10 g) = 5.06mW/g
Maximum value of SAR (measured) = 10.9mW/g

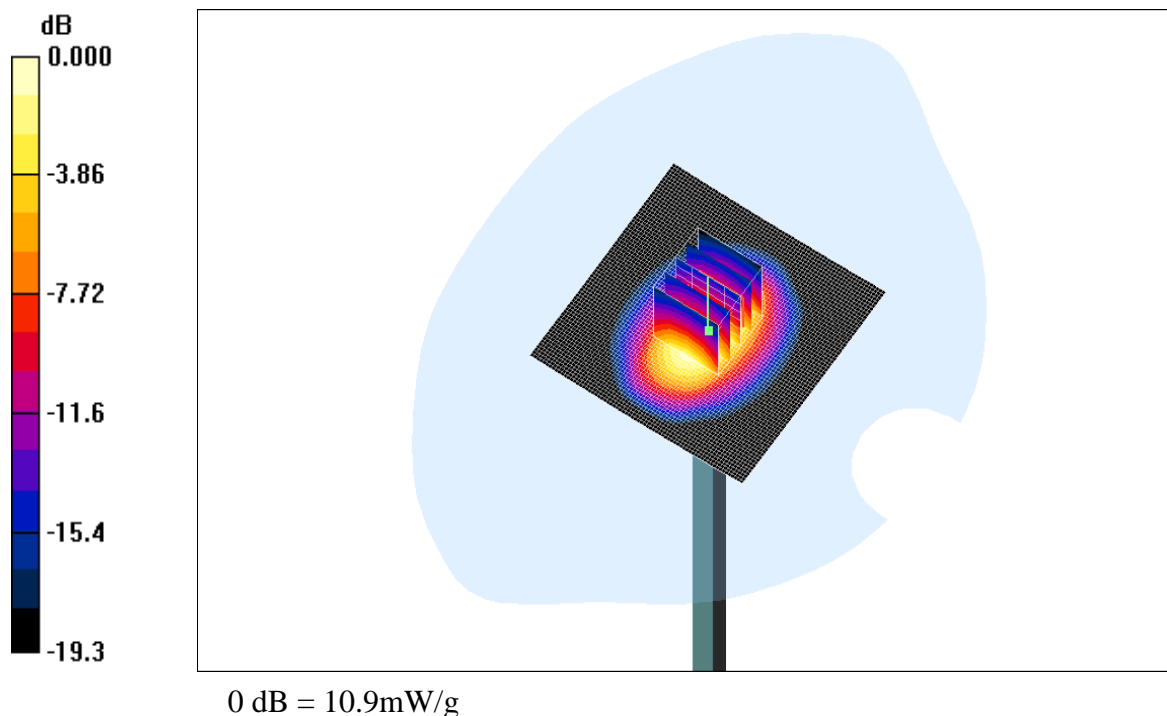

APPENDIX B: SAR Test Data

LG Electronics Inc.

DUT: GS107a; Type: Cellular/PCS GSM Phone; Serial:#1

Communication System: GSM 850; Frequency: 836.6 MHz; Duty Cycle: 1:8.3

Medium: Head 836.6 MHz; ($\sigma = 0.887\text{mho/m}$; $\epsilon_r = 40.3$; $\rho = 1000\text{ kg/m}^3$)

Phantom section: Right Section

Test Date: 10/16/2009; Ambient Temp: 22.0°C; Tissue Temp: 21.8°C

Probe: ET3DV6 - SN1729; ConvF(6.08, 6.08, 6.08); Calibrated: 2009-01-20

Sensor-Surface: 4mm (Mechanical Surface Detection)

Electronics: DAE4 Sn646; Calibrated: 2009-05-25

Phantom: SAM with CRP 835MHz; Type: SAM; Serial: TP-1066

Measurement SW: DASY4, V4.7 Build 71; Postprocessing SW: SEMCAD, V1.8 Build 184

Right Head Touch, Ch.190, Fixed Ant., Standard Battery

Area Scan (61x111x1): Measurement grid: dx=15mm, dy=15mm

Maximum value of SAR (interpolated) = 1.18mW/g

Zoom Scan (5x5x7) : Measurement grid: dx=8mm, dy=8mm, dz=5mm

Reference Value = 13.0 V/m; Power Drift = 0.268 dB

Peak SAR (extrapolated) = 1.68 W/kg

SAR(1 g) = 1.12mW/g; SAR(10 g) = 0.755mW/g

Maximum value of SAR (measured) = 1.18mW/g

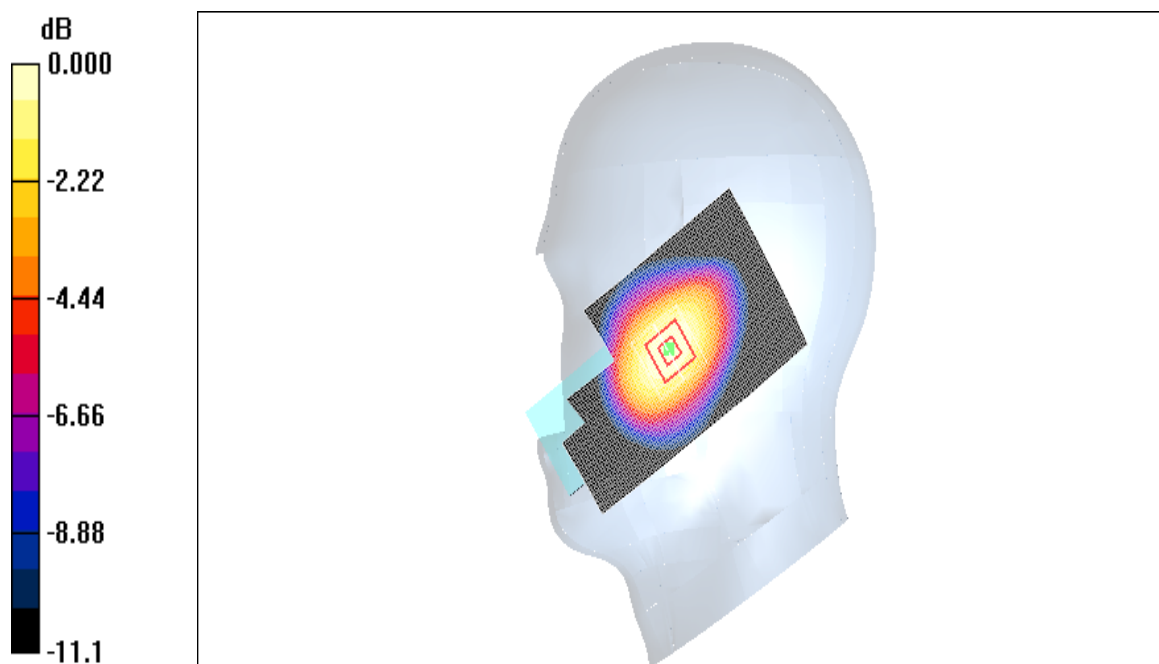

LG Electronics Inc.

DUT: GS107a; Type: Cellular/PCS GSM Phone; Serial:#1

Communication System: GSM 850; Frequency: 836.6 MHz; Duty Cycle: 1:8.3

Medium: Head 836.6 MHz; ($\sigma = 0.887\text{mho/m}$; $\epsilon_r = 40.3$; $\rho = 1000\text{ kg/m}^3$)

Phantom section: Right Section

Test Date: 10/16/2009; Ambient Temp: 22.0°C; Tissue Temp: 21.8°C

Probe: ET3DV6 - SN1729; ConvF(6.08, 6.08, 6.08); Calibrated: 2009-01-20

Sensor-Surface: 4mm (Mechanical Surface Detection)

Electronics: DAE4 Sn646; Calibrated: 2009-05-25

Phantom: SAM with CRP 835MHz; Type: SAM; Serial: TP-1066

Measurement SW: DASY4, V4.7 Build 71; Postprocessing SW: SEMCAD, V1.8 Build 184

Right Head Tilt, Ch.190, Fixed Ant., Standard Battery

Area Scan (61x111x1): Measurement grid: dx=15mm, dy=15mm

Maximum value of SAR (interpolated) = 0.574mW/g

Zoom Scan (5x5x7) : Measurement grid: dx=8mm, dy=8mm, dz=5mm

Reference Value = 16.7 V/m; Power Drift = -0.202 dB

Peak SAR (extrapolated) = 0.801 W/kg

SAR(1 g) = 0.535mW/g; SAR(10 g) = 0.366mW/g

Maximum value of SAR (measured) = 0.569mW/g

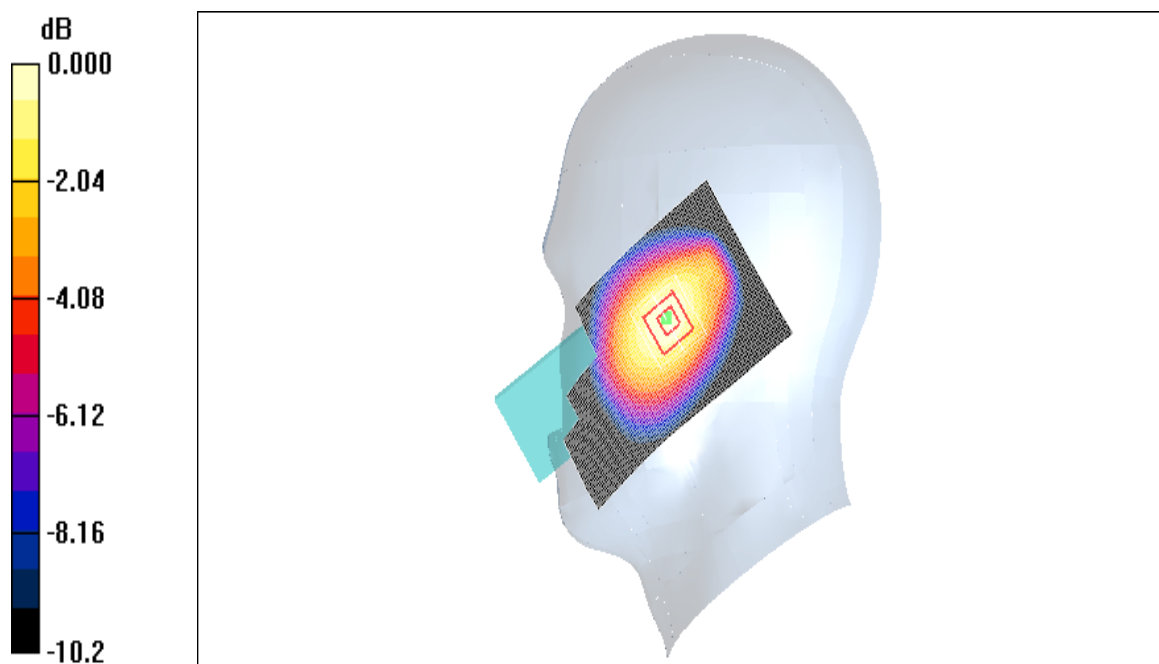

0 dB = 0.569mW/g

LG Electronics Inc.

DUT: GS107a; Type: Cellular/PCS GSM Phone; Serial:#1

Communication System: GSM 850; Frequency: 836.6 MHz; Duty Cycle: 1:8.3

Medium: Head 836.6 MHz; ($\sigma = 0.887\text{mho/m}$; $\epsilon_r = 40.3$; $\rho = 1000\text{ kg/m}^3$)

Phantom section: Left Section

Test Date: 10/16/2009; Ambient Temp: 22.0°C; Tissue Temp: 21.8°C

Probe: ET3DV6 - SN1729; ConvF(6.08, 6.08, 6.08); Calibrated: 2009-01-20

Sensor-Surface: 4mm (Mechanical Surface Detection)

Electronics: DAE4 Sn646; Calibrated: 2009-05-25

Phantom: SAM with CRP 835MHz; Type: SAM; Serial: TP-1066

Measurement SW: DASY4, V4.7 Build 71; Postprocessing SW: SEMCAD, V1.8 Build 184

Left Head Touch, Ch.190, Fixed Ant., Standard Battery

Area Scan (61x111x1): Measurement grid: dx=15mm, dy=15mm

Maximum value of SAR (interpolated) = 1.22mW/g

Zoom Scan (5x5x7) : Measurement grid: dx=8mm, dy=8mm, dz=5mm

Reference Value = 12.8 V/m; Power Drift = -0.383 dB

Peak SAR (extrapolated) = 1.77 W/kg

SAR(1 g) = 1.17mW/g; SAR(10 g) = 0.784mW/g

Maximum value of SAR (measured) = 1.23mW/g

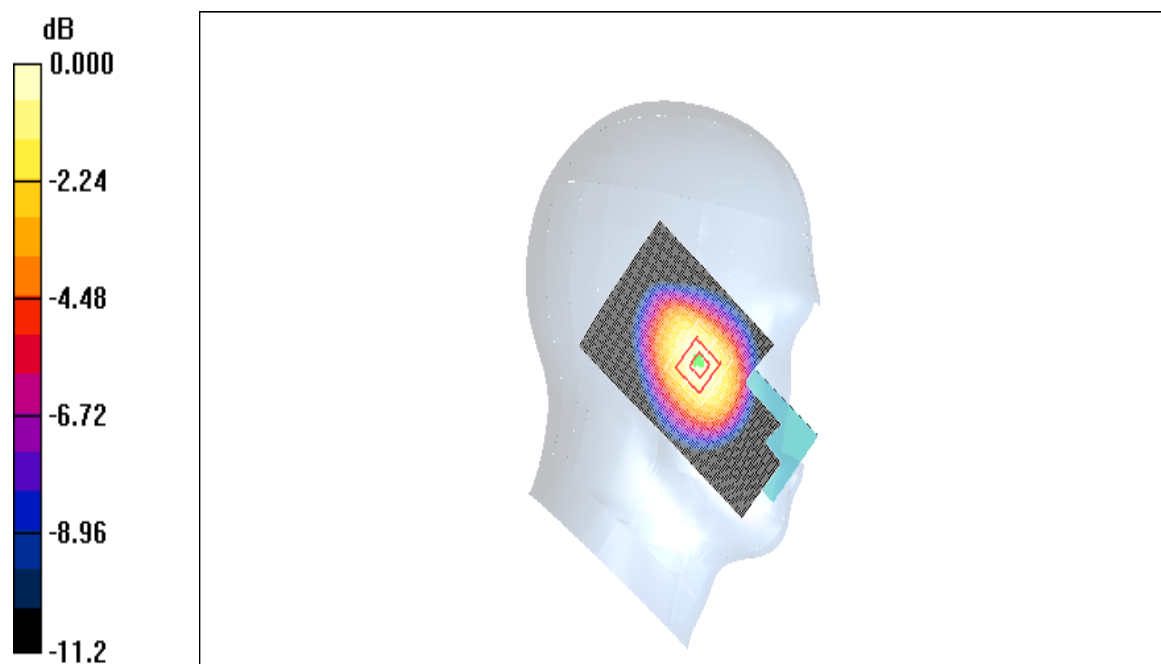

0 dB = 1.23mW/g

LG Electronics Inc.

DUT: GS107a; Type: Cellular/PCS GSM Phone; Serial:#1

Communication System: GSM 850; Frequency: 836.6 MHz; Duty Cycle: 1:8.3

Medium: Head 836.6 MHz; ($\sigma = 0.887\text{mho/m}$; $\epsilon_r = 40.3$; $\rho = 1000\text{ kg/m}^3$)

Phantom section: Left Section

Test Date: 10/16/2009; Ambient Temp: 22.0°C; Tissue Temp: 21.8°C

Probe: ET3DV6 - SN1729; ConvF(6.08, 6.08, 6.08); Calibrated: 2009-01-20

Sensor-Surface: 4mm (Mechanical Surface Detection)

Electronics: DAE4 Sn646; Calibrated: 2009-05-25

Phantom: SAM with CRP 835MHz; Type: SAM; Serial: TP-1066

Measurement SW: DASY4, V4.7 Build 71; Postprocessing SW: SEMCAD, V1.8 Build 184

Left Head Tilt, Ch.190, Fixed Ant., Standard Battery

Area Scan (61x111x1): Measurement grid: dx=15mm, dy=15mm

Maximum value of SAR (interpolated) = 0.507mW/g

Zoom Scan (5x5x7): Measurement grid: dx=8mm, dy=8mm, dz=5mm

Reference Value = 15.6 V/m; Power Drift = -0.067 dB

Peak SAR (extrapolated) = 0.732 W/kg

SAR(1 g) = 0.485mW/g; SAR(10 g) = 0.338mW/g

Maximum value of SAR (measured) = 0.510mW/g

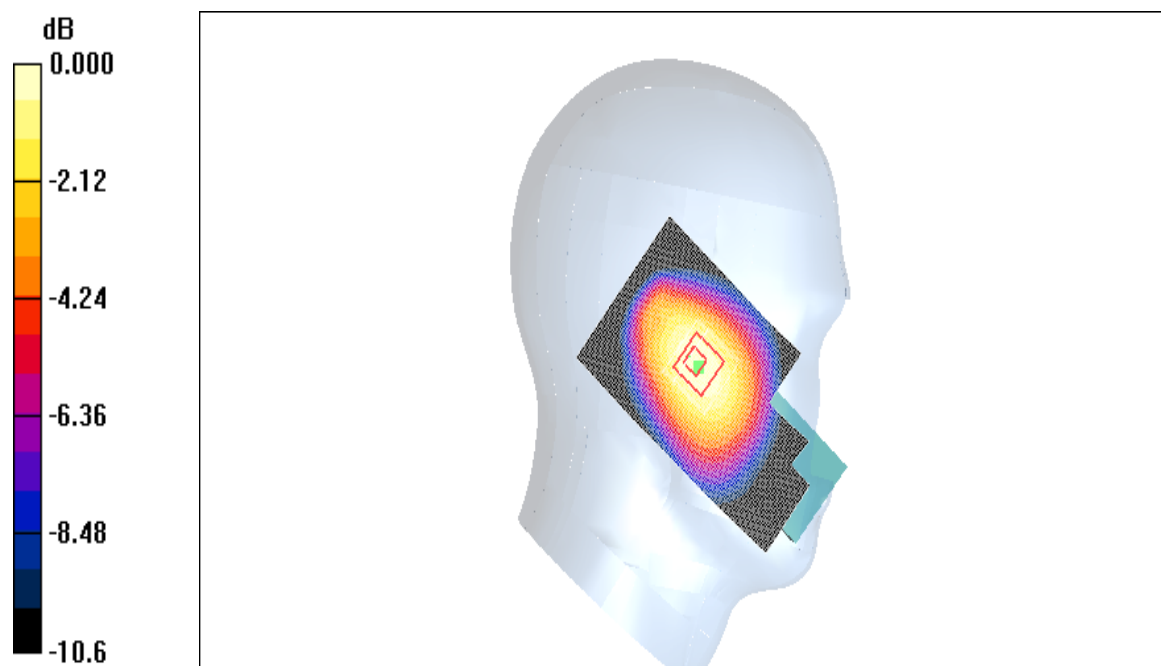

0 dB = 0.510mW/g

LG Electronics Inc.

DUT: GS107a; Type: Cellular/PCS GSM Phone; Serial:#1

Communication System: GSM 850; Frequency: 824.2 MHz; Duty Cycle: 1:8.3
Medium: Head 824.2 MHz; ($\sigma = 0.886$ mho/m; $\epsilon_r = 40.4$; $\rho = 1000$ kg/m³)
Phantom section: Left Section

Test Date: 10/16/2009; Ambient Temp: 22.0°C; Tissue Temp: 21.8°C

Probe: ET3DV6 - SN1729; ConvF(6.08, 6.08, 6.08); Calibrated: 2009-01-20
Sensor-Surface: 4mm (Mechanical Surface Detection)
Electronics: DAE4 Sn646; Calibrated: 2009-05-25
Phantom: SAM with CRP 835MHz; Type: SAM; Serial: TP-1066
Measurement SW: DASY4, V4.7 Build 71; Postprocessing SW: SEMCAD, V1.8 Build 184

Left Head Touch, Ch.128, Fixed Ant., Standard Battery

Area Scan (61x111x1): Measurement grid: dx=15mm, dy=15mm
Maximum value of SAR (interpolated) = 1.15mW/g

Zoom Scan (5x5x7): Measurement grid: dx=8mm, dy=8mm, dz=5mm
Reference Value = 11.6 V/m; Power Drift = 0.383dB
Peak SAR (extrapolated) = 1.66 W/kg
SAR(1 g) = 1.1mW/g; SAR(10 g) = 0.738mW/g
Maximum value of SAR (measured) = 1.15mW/g

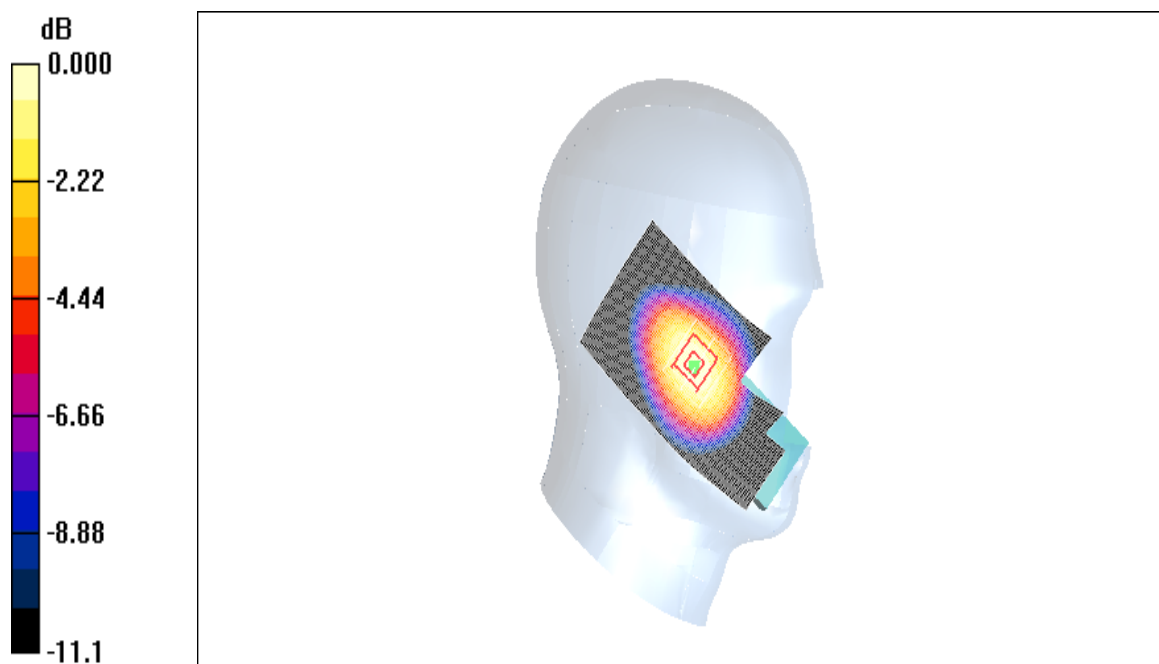

0 dB = 1.15mW/g

LG Electronics Inc.

DUT: GS107a; Type: Cellular/PCS GSM Phone; Serial:#1

Communication System: GSM 850; Frequency: 848.8 MHz; Duty Cycle: 1:8.3
Medium: Head 848.8 MHz; ($\sigma = 0.897$ mho/m; $\epsilon_r = 40.1$; $\rho = 1000$ kg/m³)
Phantom section: Left Section

Test Date: 10/16/2009; Ambient Temp: 22.0°C; Tissue Temp: 21.8°C

Probe: ET3DV6 - SN1729; ConvF(6.08, 6.08, 6.08); Calibrated: 2009-01-20
Sensor-Surface: 4mm (Mechanical Surface Detection)
Electronics: DAE4 Sn646; Calibrated: 2009-05-25
Phantom: SAM with CRP 835MHz; Type: SAM; Serial: TP-1066
Measurement SW: DASY4, V4.7 Build 71; Postprocessing SW: SEMCAD, V1.8 Build 184

Left Head Touch, Ch.251, Fixed Ant., Standard Battery

Area Scan (61x111x1): Measurement grid: dx=15mm, dy=15mm
Maximum value of SAR (interpolated) = 1.05mW/g

Zoom Scan (5x5x7): Measurement grid: dx=8mm, dy=8mm, dz=5mm
Reference Value = 11.3 V/m; Power Drift = -0.086 dB
Peak SAR (extrapolated) = 1.49 W/kg
SAR(1 g) = 0.987mW/g; SAR(10 g) = 0.663mW/g
Maximum value of SAR (measured) = 1.03mW/g

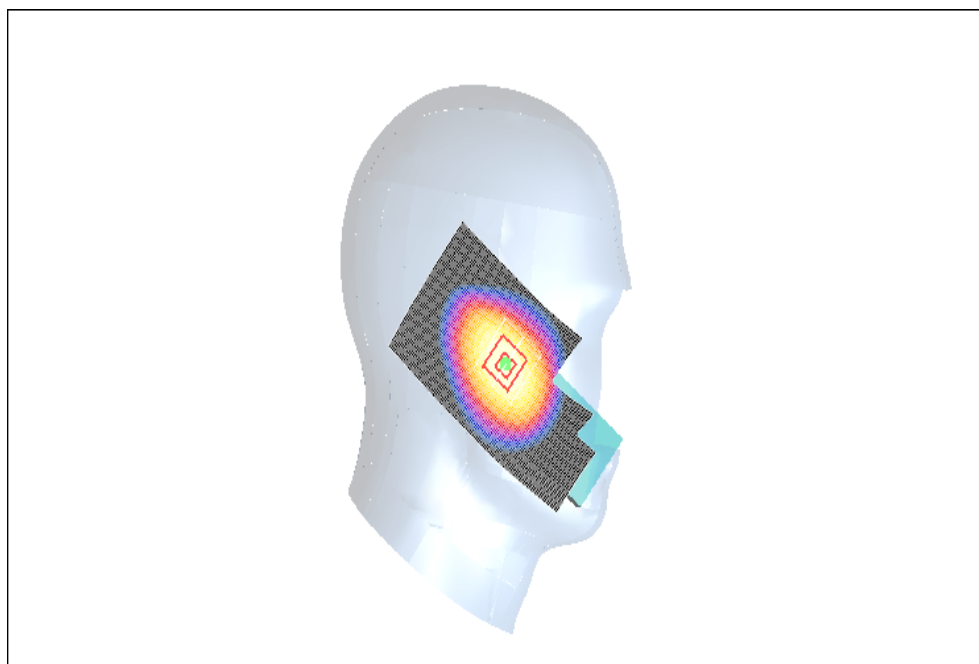
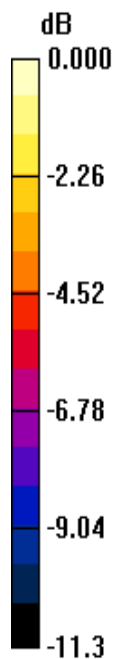

0 dB = 1.03mW/g

LG Electronics Inc.

DUT: GS107a; Type: Cellular/PCS GSM Phone; Serial:#1

Communication System: PCS 1900; Frequency: 1880 MHz; Duty Cycle: 1:8.3

Medium: Head 1880 MHz; ($\sigma = 1.4\text{mho/m}$; $\epsilon_r = 40$; $\rho = 1000\text{ kg/m}^3$)

Phantom section: Right Section

Test Date: 10/17/2009; Ambient Temp: 22.0°C; Tissue Temp: 21.8°C

Probe: ET3DV6 - SN1729; ConvF(4.96, 4.96, 4.96); Calibrated: 2009-01-20

Sensor-Surface: 4mm (Mechanical Surface Detection)

Electronics: DAE4 Sn646; Calibrated: 2009-05-25

Phantom: SAM with CRP 1800MHz; Type: SAM; Serial: TP-1244

Measurement SW: DASY4, V4.7 Build 71; Postprocessing SW: SEMCAD, V1.8 Build 184

Right Head Touch, Ch.661, Fixed Ant., Standard Battery

Area Scan (61x111x1): Measurement grid: dx=15mm, dy=15mm

Maximum value of SAR (interpolated) = 1.17mW/g

Zoom Scan (5x5x7): Measurement grid: dx=8mm, dy=8mm, dz=5mm

Reference Value = 10.1 V/m; Power Drift = -0.005 dB

Peak SAR (extrapolated) = 1.95 W/kg

SAR(1 g) = 0.985mW/g; SAR(10 g) = 0.546mW/g

Maximum value of SAR (measured) = 1.06mW/g

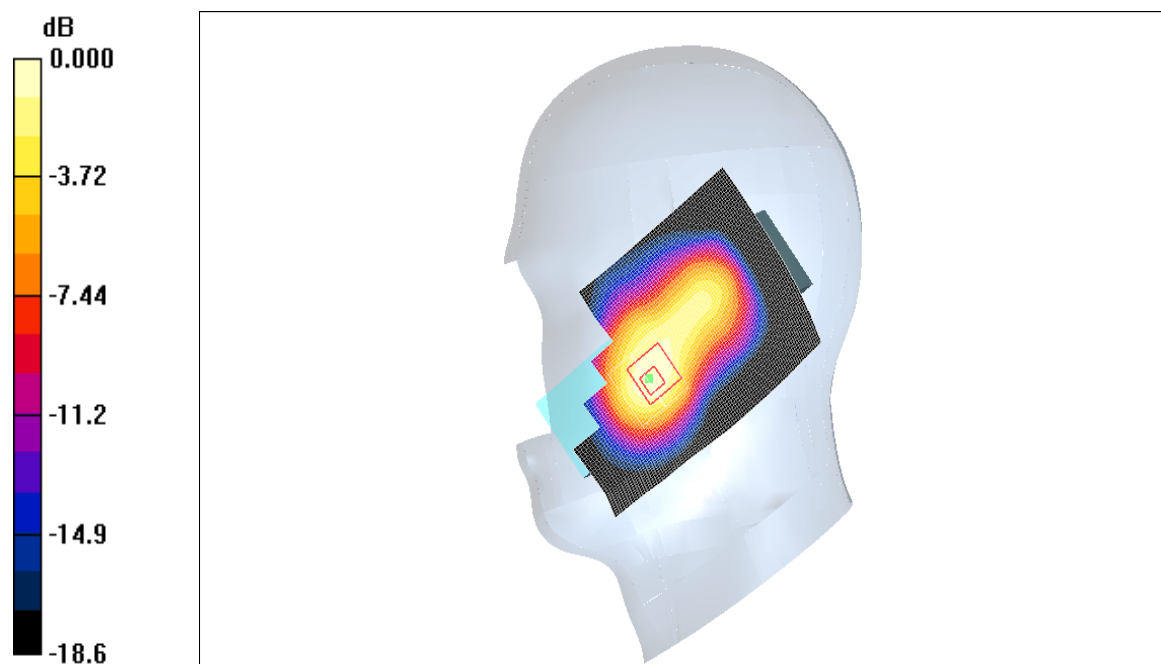

0 dB = 1.06mW/g

LG Electronics Inc.

DUT: GS107a; Type: Cellular/PCS GSM Phone; Serial:#1

Communication System: PCS 1900; Frequency: 1880 MHz; Duty Cycle: 1:8.3

Medium: Head 1880 MHz; ($\sigma = 1.4\text{mho/m}$; $\epsilon_r = 40$; $\rho = 1000\text{ kg/m}^3$)

Phantom section: Right Section

Test Date: 10/17/2009; Ambient Temp: 22.0°C; Tissue Temp: 21.8°C

Probe: ET3DV6 - SN1729; ConvF(4.96, 4.96, 4.96); Calibrated: 2009-01-20

Sensor-Surface: 4mm (Mechanical Surface Detection)

Electronics: DAE4 Sn646; Calibrated: 2009-05-25

Phantom: SAM with CRP 1800MHz; Type: SAM; Serial: TP-1244

Measurement SW: DASY4, V4.7 Build 71; Postprocessing SW: SEMCAD, V1.8 Build 184

Right Head Tilt, Ch.661, Fixed Ant., Standard Battery

Area Scan (61x111x1): Measurement grid: dx=15mm, dy=15mm

Maximum value of SAR (interpolated) = 0.417mW/g

Zoom Scan (5x5x7): Measurement grid: dx=8mm, dy=8mm, dz=5mm

Reference Value = 12.0 V/m; Power Drift = -0.033 dB

Peak SAR (extrapolated) = 0.695 W/kg

SAR(1 g) = 0.378mW/g; SAR(10 g) = 0.217mW/g

Maximum value of SAR (measured) = 0.400mW/g

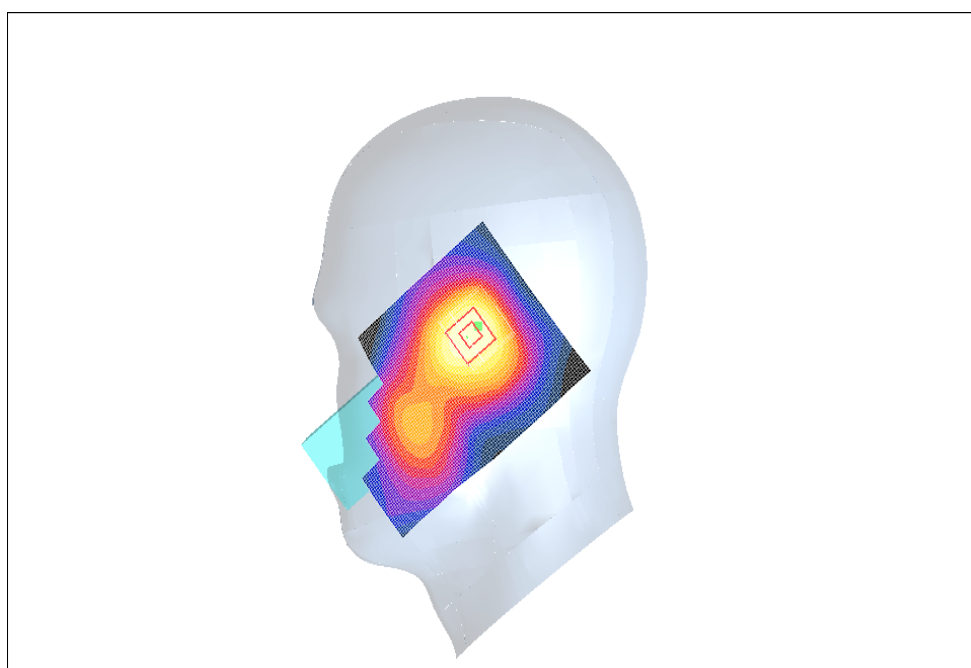
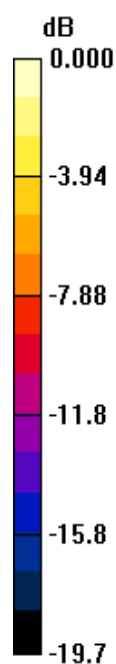

LG Electronics Inc.

DUT: GS107a; Type: Cellular/PCS GSM Phone; Serial:#1

Communication System: PCS 1900; Frequency: 1880 MHz; Duty Cycle: 1:8.3

Medium: Head 1880 MHz; ($\sigma = 1.4\text{mho/m}$; $\epsilon_r = 40$; $\rho = 1000\text{ kg/m}^3$)

Phantom section: Left Section

Test Date: 10/17/2009; Ambient Temp: 22.0°C; Tissue Temp: 21.8°C

Probe: ET3DV6 - SN1729; ConvF(4.96, 4.96, 4.96); Calibrated: 2009-01-20

Sensor-Surface: 4mm (Mechanical Surface Detection)

Electronics: DAE4 Sn646; Calibrated: 2009-05-25

Phantom: SAM with CRP 1800MHz; Type: SAM; Serial: TP-1244

Measurement SW: DASY4, V4.7 Build 71; Postprocessing SW: SEMCAD, V1.8 Build 184

Left Head Touch, Ch.661, Fixed Ant., Standard Battery

Area Scan (61x111x1): Measurement grid: dx=15mm, dy=15mm

Maximum value of SAR (interpolated) = 0.898mW/g

Zoom Scan (5x5x7): Measurement grid: dx=8mm, dy=8mm, dz=5mm

Reference Value = 10.3 V/m; Power Drift = 0.391 dB

Peak SAR (extrapolated) = 1.50 W/kg

SAR(1 g) = 0.780mW/g; SAR(10 g) = 0.463mW/g

Maximum value of SAR (measured) = 0.816mW/g

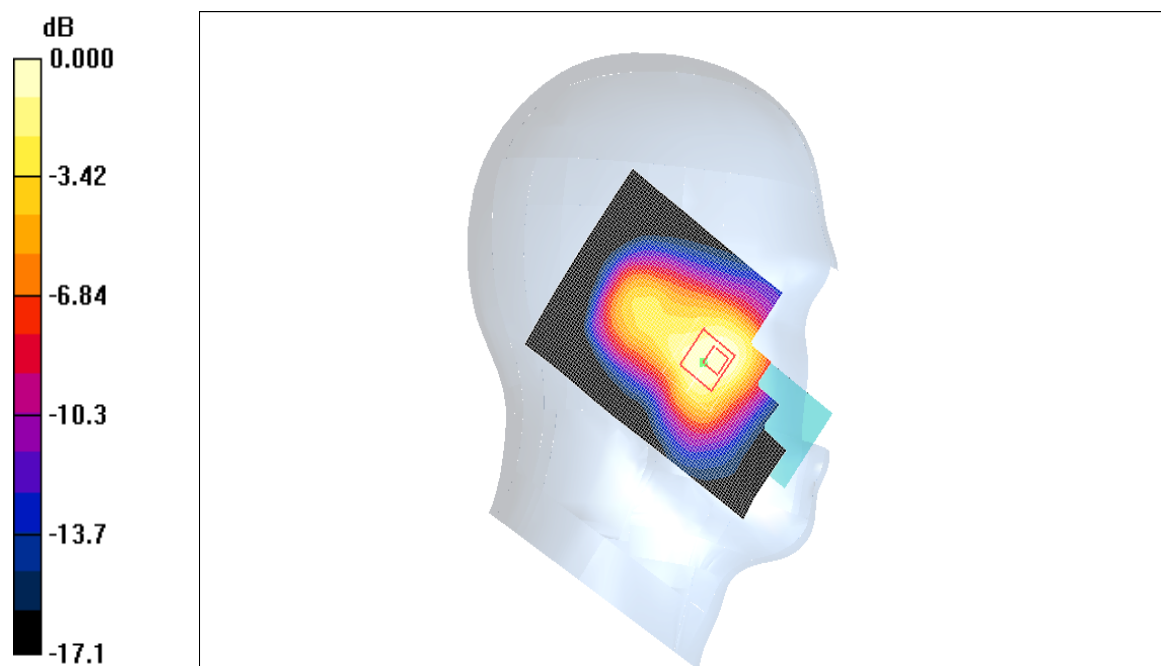

0 dB = 0.816mW/g

LG Electronics Inc.

DUT: GS107a; Type: Cellular/PCS GSM Phone; Serial:#1

Communication System: PCS 1900; Frequency: 1880 MHz; Duty Cycle: 1:8.3

Medium: Head 1880 MHz; ($\sigma = 1.4\text{mho/m}$; $\epsilon_r = 40$; $\rho = 1000\text{ kg/m}^3$)

Phantom section: Left Section

Test Date: 10/17/2009; Ambient Temp: 22.0°C; Tissue Temp: 21.8°C

Probe: ET3DV6 - SN1729; ConvF(4.96, 4.96, 4.96); Calibrated: 2009-01-20

Sensor-Surface: 4mm (Mechanical Surface Detection)

Electronics: DAE4 Sn646; Calibrated: 2009-05-25

Phantom: SAM with CRP 1800MHz; Type: SAM; Serial: TP-1244

Measurement SW: DASY4, V4.7 Build 71; Postprocessing SW: SEMCAD, V1.8 Build 184

Left Head Tilt, Ch.661, Fixed Ant., Standard Battery

Area Scan (61x111x1): Measurement grid: dx=15mm, dy=15mm

Maximum value of SAR (interpolated) = 0.339mW/g

Zoom Scan (5x5x7): Measurement grid: dx=8mm, dy=8mm, dz=5mm

Reference Value = 12.3 V/m; Power Drift = -0.053 dB

Peak SAR (extrapolated) = 0.490 W/kg

SAR(1 g) = 0.281mW/g; SAR(10 g) = 0.170mW/g

Maximum value of SAR (measured) = 0.295mW/g

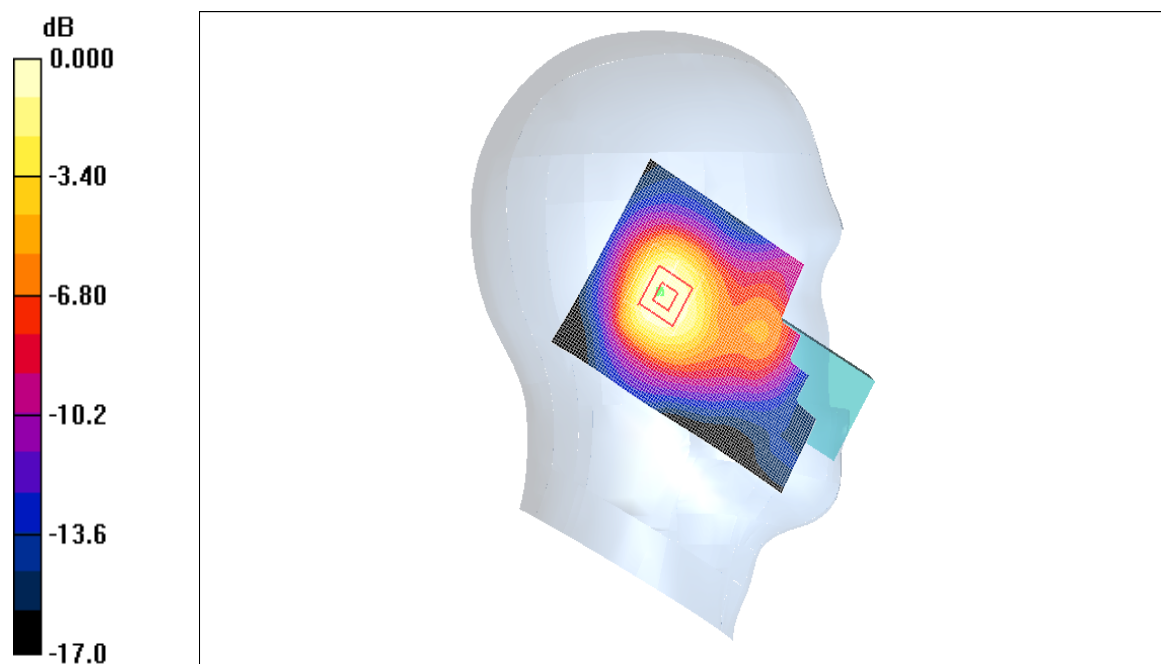

0 dB = 0.295mW/g

LG Electronics Inc.

DUT: GS107a; Type: Cellular/PCS GSM Phone; Serial:#1

Communication System: PCS 1900; Frequency: 1850.2 MHz; Duty Cycle: 1:8.3

Medium: Head 1850.2 MHz; ($\sigma = 1.37\text{mho/m}$; $\epsilon_r = 40.1$; $\rho = 1000\text{ kg/m}^3$)

Phantom section: Right Section

Test Date: 10/17/2009; Ambient Temp: 22.0°C; Tissue Temp: 21.8°C

Probe: ET3DV6 - SN1729; ConvF(4.96, 4.96, 4.96); Calibrated: 2009-01-20

Sensor-Surface: 4mm (Mechanical Surface Detection)

Electronics: DAE4 Sn646; Calibrated: 2009-05-25

Phantom: SAM with CRP 1800MHz; Type: SAM; Serial: TP-1244

Measurement SW: DASY4, V4.7 Build 71; Postprocessing SW: SEMCAD, V1.8 Build 184

Right Head Touch, Ch.512, Fixed Ant., Standard Battery

Area Scan (61x111x1): Measurement grid: dx=15mm, dy=15mm

Maximum value of SAR (interpolated) = 1.04mW/g

Zoom Scan (5x5x7): Measurement grid: dx=8mm, dy=8mm, dz=5mm

Reference Value = 10.2 V/m; Power Drift = -0.186 dB

Peak SAR (extrapolated) = 1.79W/kg

SAR(1 g) = 0.873mW/g; SAR(10 g) = 0.481mW/g

Maximum value of SAR (measured) = 0.942mW/g

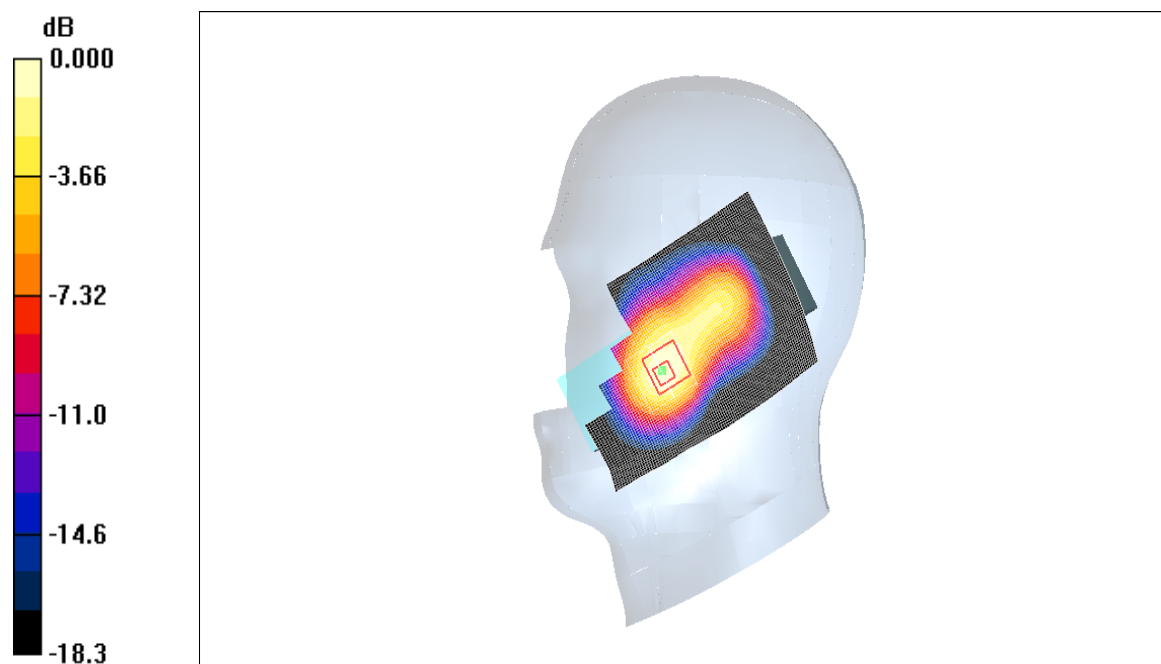

0 dB = 0.942mW/g

LG Electronics Inc.

DUT: GS107a; Type: Cellular/PCS GSM Phone; Serial:#1

Communication System: PCS 1900; Frequency: 1909.8 MHz; Duty Cycle: 1:8.3

Medium: Head 1909.8 MHz; ($\sigma = 1.44\text{mho/m}$; $\epsilon_r = 39.9$; $\rho = 1000\text{ kg/m}^3$)

Phantom section: Right Section

Test Date: 10/17/2009; Ambient Temp: 22.0°C; Tissue Temp: 21.8°C

Probe: ET3DV6 - SN1729; ConvF(4.96, 4.96, 4.96); Calibrated: 2009-01-20

Sensor-Surface: 4mm (Mechanical Surface Detection)

Electronics: DAE4 Sn646; Calibrated: 2009-05-25

Phantom: SAM with CRP 1800MHz; Type: SAM; Serial: TP-1244

Measurement SW: DASY4, V4.7 Build 71; Postprocessing SW: SEMCAD, V1.8 Build 184

Right Head Touch, Ch.810, Fixed Ant., Standard Battery

Area Scan (61x111x1): Measurement grid: dx=15mm, dy=15mm

Maximum value of SAR (interpolated) = 1.35mW/g

Zoom Scan (5x5x7): Measurement grid: dx=8mm, dy=8mm, dz=5mm

Reference Value = 11.6 V/m; Power Drift = -0.020 dB

Peak SAR (extrapolated) = 2.35 W/kg

SAR(1 g) = 1.14mW/g; SAR(10 g) = 0.618mW/g

Maximum value of SAR (measured) = 1.24mW/g

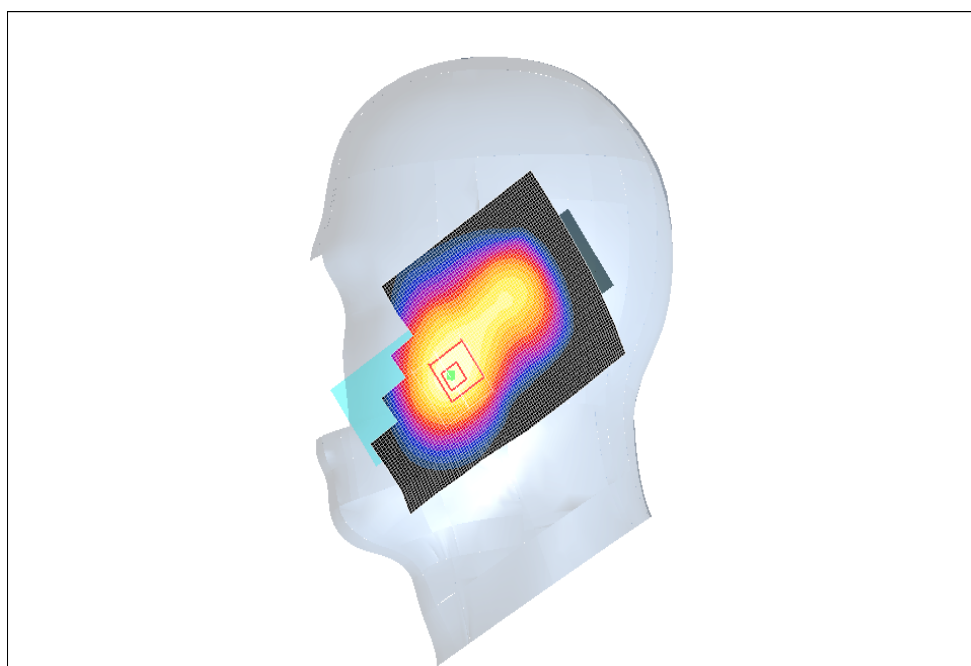
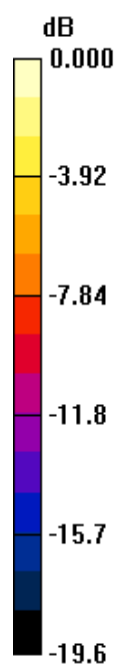

0 dB = 1.24mW/g

LG Electronics Inc.

DUT: GS107a; Type: Cellular/PCS GSM Phone; Serial:#1

Communication System: GSM 850; Frequency: 836.6 MHz; Duty Cycle: 1:8.3

Medium: Body 836.6 MHz; ($\sigma = 0.95$ mho/m; $\epsilon_r = 53.7$; $\rho = 1000$ kg/m³)

Phantom section: Flat Section

Test Date: 10/16/2009; Ambient Temp: 22.0°C; Tissue Temp: 21.8°C

Probe: ET3DV6 - SN1729; ConvF(5.84, 5.84, 5.84); Calibrated: 2009-01-20

Sensor-Surface: 4mm (Mechanical Surface Detection)

Electronics: DAE4 Sn646; Calibrated: 2009-05-25

Phantom: SAM with CRP 835MHz; Type: SAM; Serial: TP-1066

Measurement SW: DASY4, V4.7 Build 71; Postprocessing SW: SEMCAD, V1.8 Build 184

Flat Touch, Ch.190, Front, Fixed Ant., Standard Battery

Area Scan (71x101x1): Measurement grid: dx=15mm, dy=15mm

Maximum value of SAR (interpolated) = 0.336mW/g

Zoom Scan (5x5x7): Measurement grid: dx=8mm, dy=8mm, dz=5mm

Reference Value = 7.22 V/m; Power Drift = -0.133 dB

Peak SAR (extrapolated) = 0.466 W/kg

SAR(1 g) = 0.316mW/g; SAR(10 g) = 0.221mW/g

Maximum value of SAR (measured) = 0.332mW/g

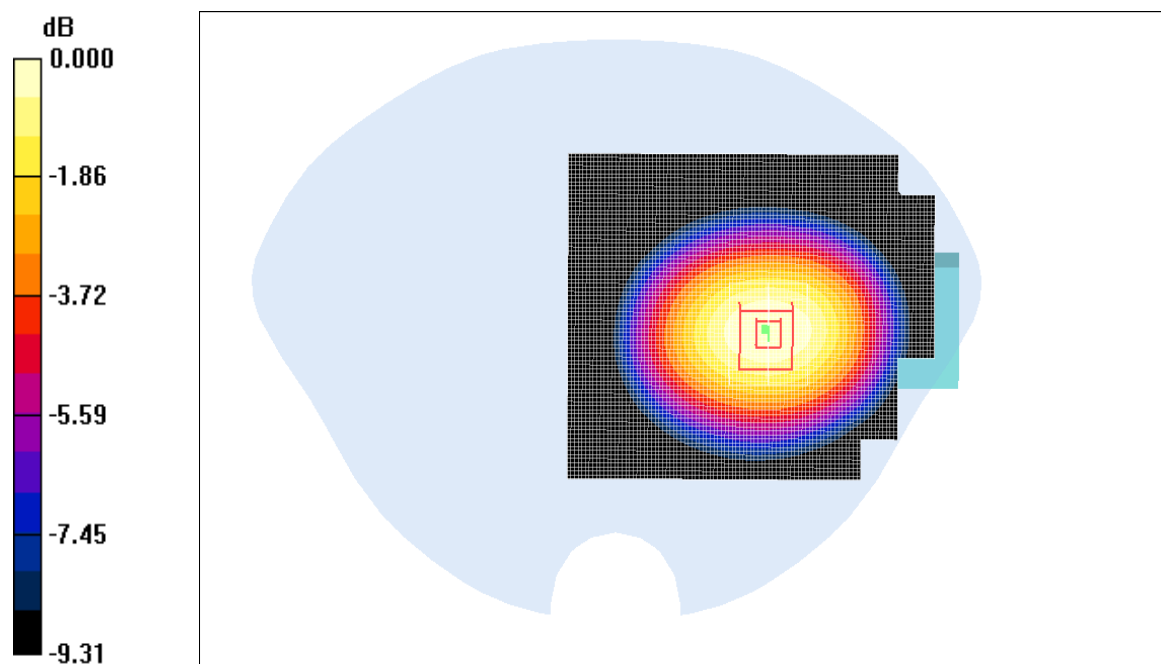

0 dB = 0.332mW/g

LG Electronics Inc.

DUT: GS107a; Type: Cellular/PCS GSM Phone; Serial:#1

Communication System: GSM 850; Frequency: 836.6 MHz; Duty Cycle: 1:8.3

Medium: Body 836.6 MHz; ($\sigma = 0.95$ mho/m; $\epsilon_r = 53.7$; $\rho = 1000$ kg/m³)

Phantom section: Flat Section

Test Date: 10/16/2009; Ambient Temp: 22.0°C; Tissue Temp: 21.8°C

Probe: ET3DV6 - SN1729; ConvF(5.84, 5.84, 5.84); Calibrated: 2009-01-20

Sensor-Surface: 4mm (Mechanical Surface Detection)

Electronics: DAE4 Sn646; Calibrated: 2009-05-25

Phantom: SAM with CRP 835MHz; Type: SAM; Serial: TP-1066

Measurement SW: DASY4, V4.7 Build 71; Postprocessing SW: SEMCAD, V1.8 Build 184

Flat Touch, Ch.190, Rear, Fixed Ant., Standard Battery

Area Scan (71x101x1): Measurement grid: dx=15mm, dy=15mm

Maximum value of SAR (interpolated) = 0.399mW/g

Zoom Scan (5x5x7): Measurement grid: dx=8mm, dy=8mm, dz=5mm

Reference Value = 7.53 V/m; Power Drift = -0.064 dB

Peak SAR (extrapolated) = 0.565 W/kg

SAR(1 g) = 0.377mW/g; SAR(10 g) = 0.264mW/g

Maximum value of SAR (measured) = 0.397mW/g

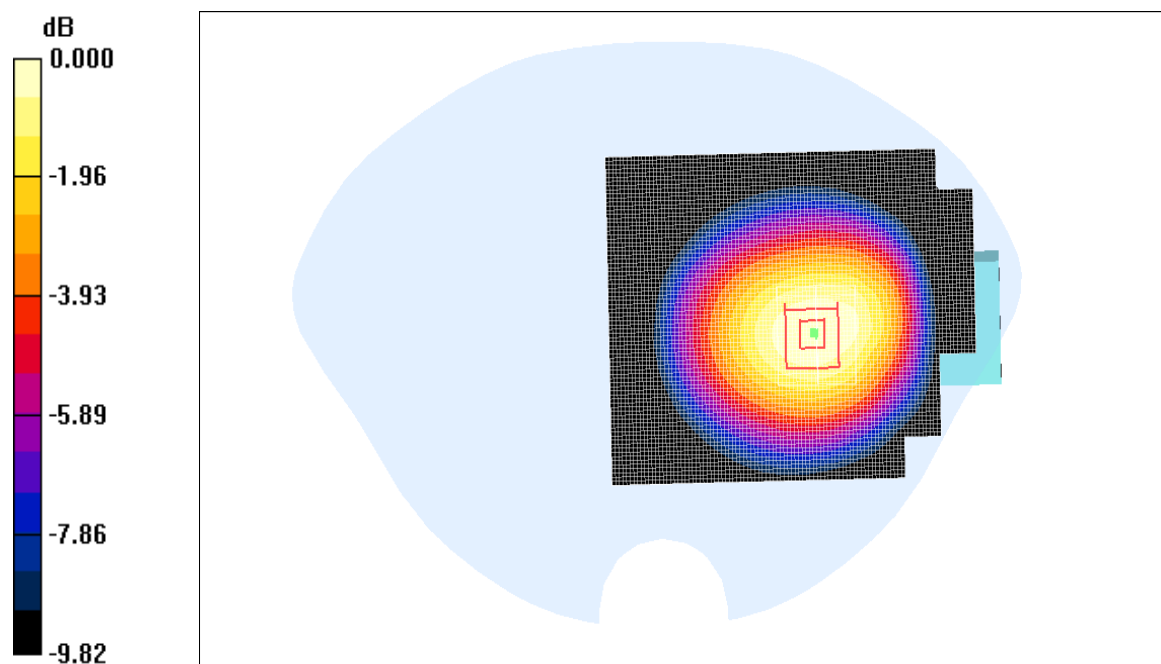

0 dB = 0.397mW/g

LG Electronics Inc.

DUT: GS107a; Type: Cellular/PCS GSM Phone; Serial:#1

Communication System: PCS 1900; Frequency: 1880 MHz; Duty Cycle: 1:8.3

Medium: Body 1880 MHz; ($\sigma = 1.51$ mho/m; $\epsilon_r = 54.2$; $\rho = 1000$ kg/m³)

Phantom section: Flat Section

Test Date: 10/17/2009; Ambient Temp: 22.0°C; Tissue Temp: 21.8°C

Probe: ET3DV6 - SN1729; ConvF(4.69, 4.69, 4.69); Calibrated: 2009-01-20

Sensor-Surface: 4mm (Mechanical Surface Detection)

Electronics: DAE4 Sn646; Calibrated: 2009-05-25

Phantom: SAM with CRP 1800MHz; Type: SAM; Serial: TP-1244

Measurement SW: DASY4, V4.7 Build 71; Postprocessing SW: SEMCAD, V1.8 Build 184

Flat Touch, Ch.661, Front, Fixed Ant., Standard Battery

Area Scan (81x121x1): Measurement grid: dx=15mm, dy=15mm

Maximum value of SAR (interpolated) = 0.313mW/g

Zoom Scan (5x5x7): Measurement grid: dx=8mm, dy=8mm, dz=5mm

Reference Value = 6.86V/m; Power Drift = -0.041 dB

Peak SAR (extrapolated) = 0.554W/kg

SAR(1 g) = 0.271mW/g; SAR(10 g) = 0.147mW/g

Maximum value of SAR (measured) = 0.289mW/g

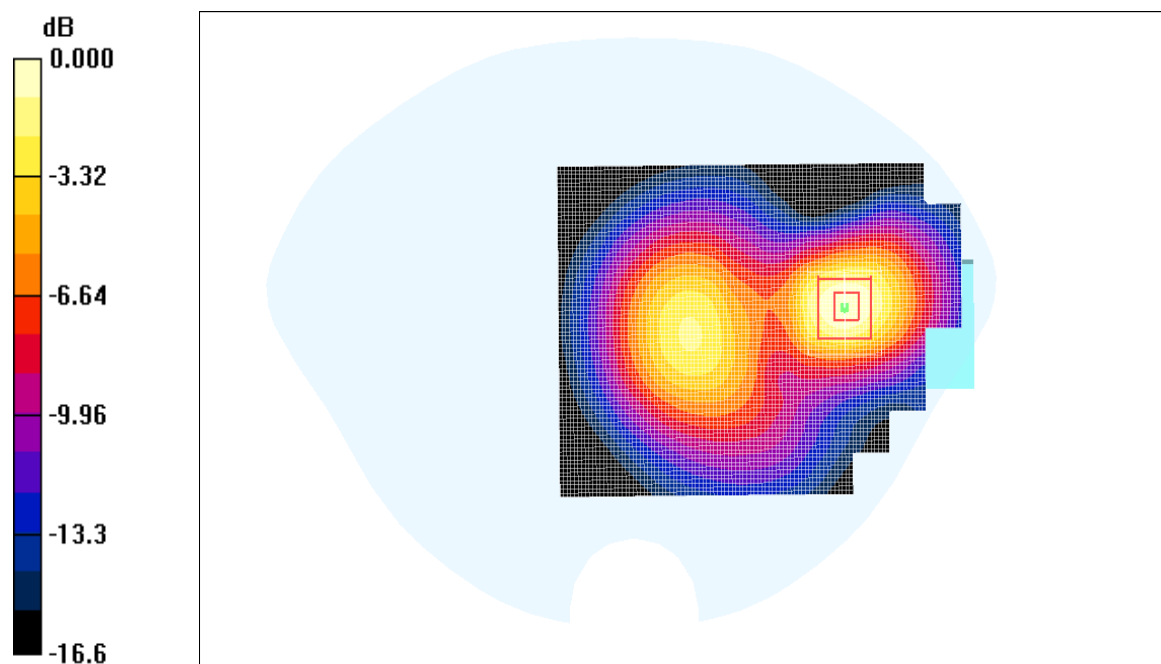

0 dB = 0.289mW/g

LG Electronics Inc.

DUT: GS107a; Type: Cellular/PCS GSM Phone; Serial:#1

Communication System: PCS 1900; Frequency: 1880 MHz; Duty Cycle: 1:8.3
Medium: Body 1880 MHz; ($\sigma = 1.51$ mho/m; $\epsilon_r = 54.2$; $\rho = 1000$ kg/m³)
Phantom section: Flat Section

Test Date: 10/17/2009; Ambient Temp: 22.0°C; Tissue Temp: 21.8°C

Probe: ET3DV6 - SN1729; ConvF(4.69, 4.69, 4.69); Calibrated: 2009-01-20
Sensor-Surface: 4mm (Mechanical Surface Detection)
Electronics: DAE4 Sn646; Calibrated: 2009-05-25
Phantom: SAM with CRP 1800MHz; Type: SAM; Serial: TP-1244
Measurement SW: DASY4, V4.7 Build 71; Postprocessing SW: SEMCAD, V1.8 Build 184

Flat Touch, Ch.661, Rear, Fixed Ant., Standard Battery

Area Scan (81x121x1): Measurement grid: dx=15mm, dy=15mm
Maximum value of SAR (interpolated) = 0.340mW/g

Zoom Scan (5x5x7): Measurement grid: dx=8mm, dy=8mm, dz=5mm
Reference Value = 8.95 V/m; Power Drift = -0.021 dB
Peak SAR (extrapolated) = 0.609 W/kg
SAR(1 g) = 0.323mW/g; SAR(10 g) = 0.201mW/g
Maximum value of SAR (measured) = 0.338mW/g

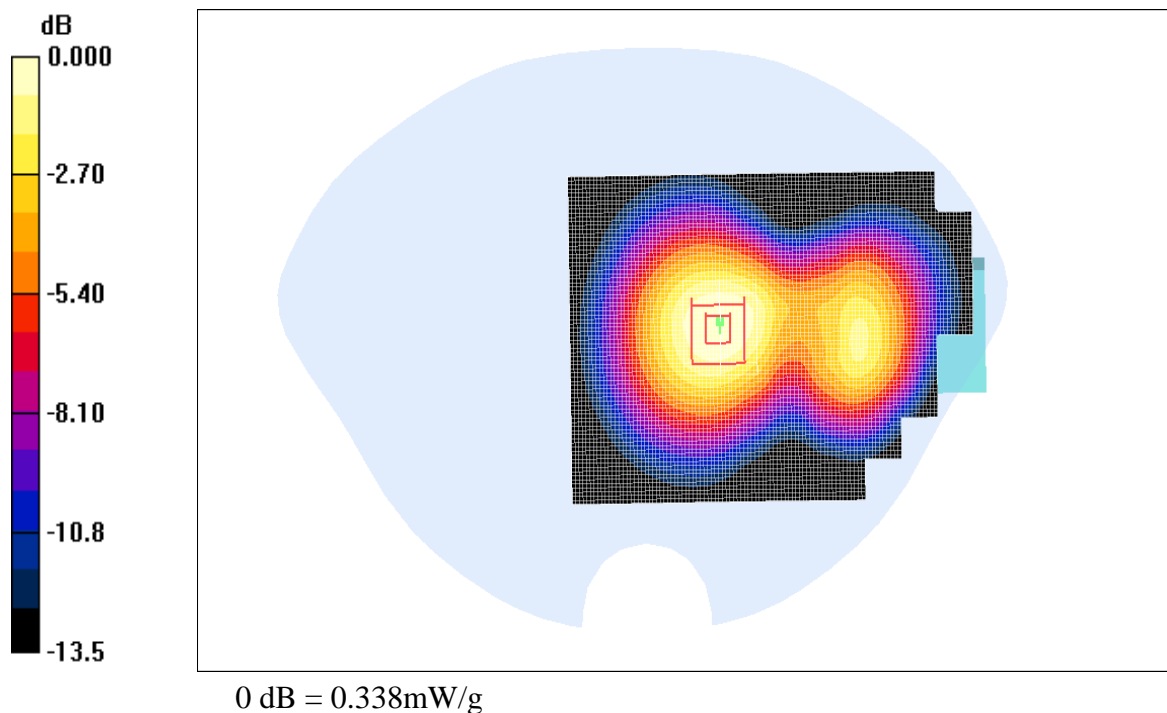

LG Electronics Inc.

DUT: GS107a; Type: Cellular/PCS GSM Phone; Serial:#1

Communication System: GSM 850; Frequency: 836.6 MHz; Duty Cycle: 1:8.3
Medium: Head 836.6 MHz; ($\sigma = 0.887\text{mho/m}$; $\epsilon_r = 40.3$; $\rho = 1000\text{ kg/m}^3$)
Phantom section: Left Section

Test Date: 10/16/2009; Ambient Temp: 22.0°C; Tissue Temp: 21.8°C

Probe: ET3DV6 - SN1729; ConvF(6.08, 6.08, 6.08); Calibrated: 2009-01-20
Sensor-Surface: 4mm (Mechanical Surface Detection)
Electronics: DAE4 Sn646; Calibrated: 2009-05-25
Phantom: SAM with CRP 835MHz; Type: SAM; Serial: TP-1066
Measurement SW: DASY4, V4.7 Build 71; Postprocessing SW: SEMCAD, V1.8 Build 184

Left Head Touch, Ch.190, Fixed Ant., Standard Battery

Area Scan (61x111x1): Measurement grid: dx=15mm, dy=15mm
Maximum value of SAR (interpolated) = 1.22mW/g

Zoom Scan (5x5x7) : Measurement grid: dx=8mm, dy=8mm, dz=5mm
Reference Value = 12.8 V/m; Power Drift = -0.383 dB
Peak SAR (extrapolated) = 1.77 W/kg
SAR(1 g) = 1.17mW/g; SAR(10 g) = 0.784mW/g
Maximum value of SAR (measured) = 1.23mW/g

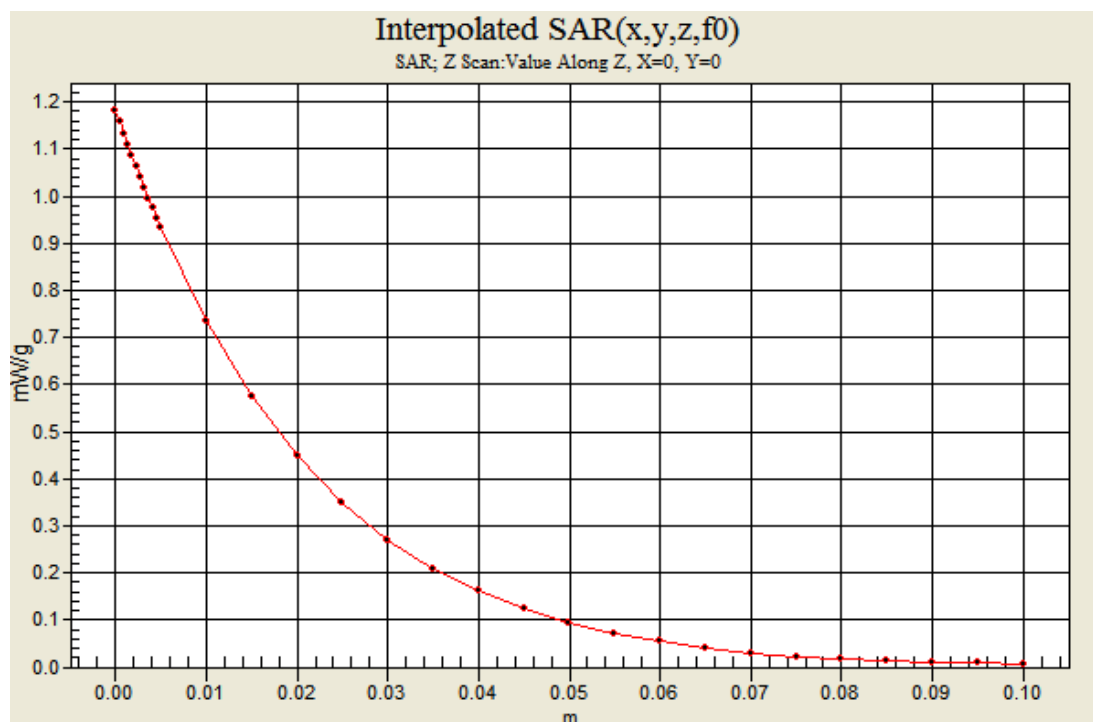

0 dB = 1.23mW/g

LG Electronics Inc.

DUT: GS107a; Type: Cellular/PCS GSM Phone; Serial:#1

Communication System: PCS 1900; Frequency: 1909.8 MHz; Duty Cycle: 1:8.3
Medium: Head 1909.8 MHz; ($\sigma = 1.44\text{mho/m}$; $\epsilon_r = 39.9$; $\rho = 1000\text{ kg/m}^3$)
Phantom section: Right Section

Test Date: 10/17/2009; Ambient Temp: 22.0°C; Tissue Temp: 21.8°C

Probe: ET3DV6 - SN1729; ConvF(4.96, 4.96, 4.96); Calibrated: 2009-01-20
Sensor-Surface: 4mm (Mechanical Surface Detection)
Electronics: DAE4 Sn646; Calibrated: 2009-05-25
Phantom: SAM with CRP 1800MHz; Type: SAM; Serial: TP-1244
Measurement SW: DASY4, V4.7 Build 71; Postprocessing SW: SEMCAD, V1.8 Build 184

Right Head Touch, Ch.810, Fixed Ant., Standard Battery

Area Scan (61x111x1): Measurement grid: dx=15mm, dy=15mm
Maximum value of SAR (interpolated) = 1.35mW/g

Zoom Scan (5x5x7): Measurement grid: dx=8mm, dy=8mm, dz=5mm
Reference Value = 11.6 V/m; Power Drift = -0.020 dB
Peak SAR (extrapolated) = 2.35 W/kg
SAR(1 g) = 1.14mW/g; SAR(10 g) = 0.618mW/g
Maximum value of SAR (measured) = 1.24mW/g

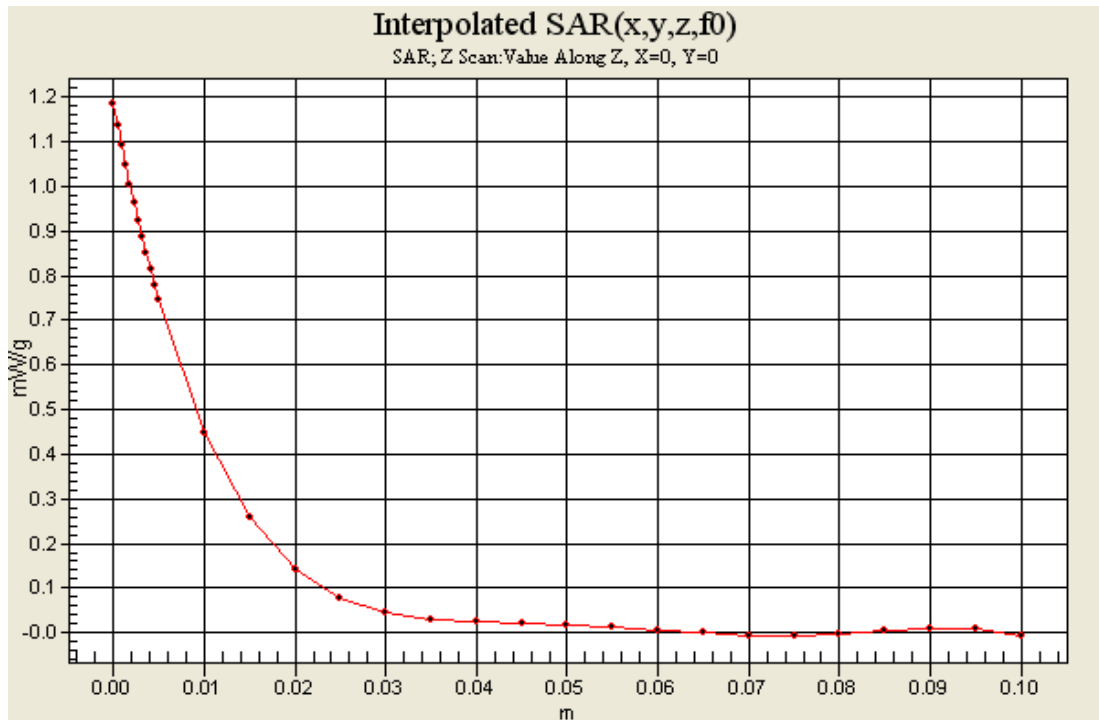

0 dB = 1.24mW/g

LG Electronics Inc.

DUT: GS107a; Type: Cellular/PCS GSM Phone; Serial:#1

Communication System: GSM 850; Frequency: 836.6 MHz; Duty Cycle: 1:8.3

Medium: Body 836.6 MHz; ($\sigma = 0.95$ mho/m; $\epsilon_r = 53.7$; $\rho = 1000$ kg/m³)

Phantom section: Flat Section

Test Date: 10/16/2009; Ambient Temp: 22.0°C; Tissue Temp: 21.8°C

Probe: ET3DV6 - SN1729; ConvF(5.84, 5.84, 5.84); Calibrated: 2009-01-20

Sensor-Surface: 4mm (Mechanical Surface Detection)

Electronics: DAE4 Sn646; Calibrated: 2009-05-25

Phantom: SAM with CRP 835MHz; Type: SAM; Serial: TP-1066

Measurement SW: DASY4, V4.7 Build 71; Postprocessing SW: SEMCAD, V1.8 Build 184

Flat Touch, Ch.190, Rear, Fixed Ant., Standard Battery

Area Scan (71x101x1): Measurement grid: dx=15mm, dy=15mm

Maximum value of SAR (interpolated) = 0.399mW/g

Zoom Scan (5x5x7): Measurement grid: dx=8mm, dy=8mm, dz=5mm

Reference Value = 7.53 V/m; Power Drift = -0.064 dB

Peak SAR (extrapolated) = 0.565 W/kg

SAR(1 g) = 0.377mW/g; SAR(10 g) = 0.264mW/g

Maximum value of SAR (measured) = 0.397mW/g

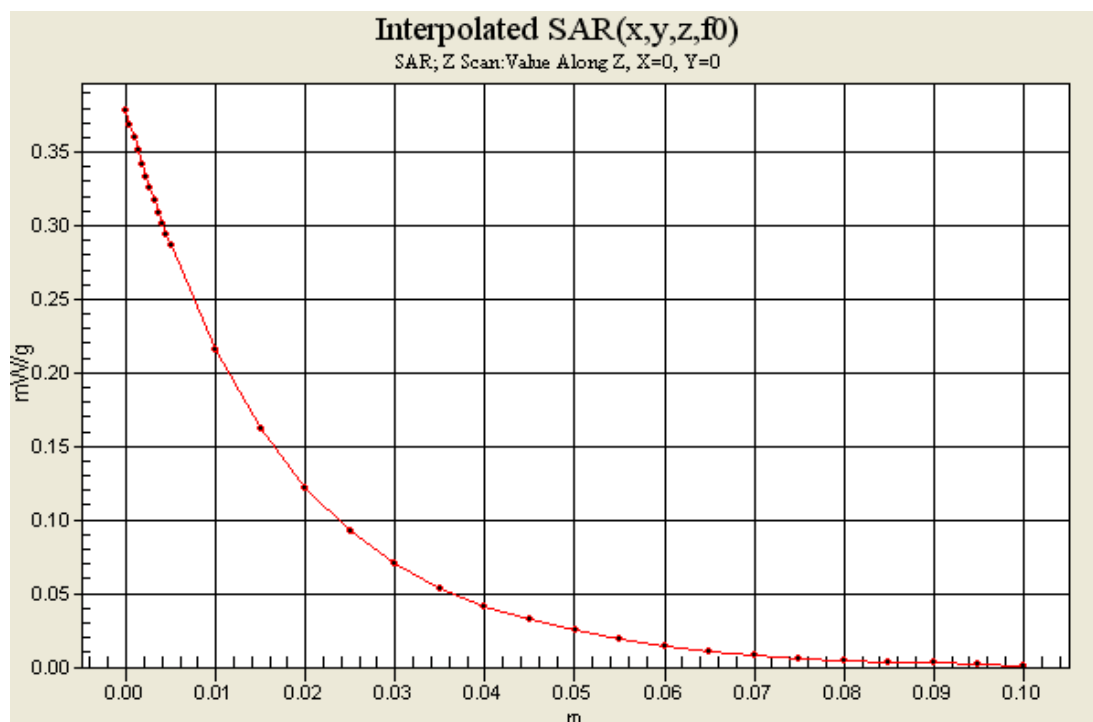

LG Electronics Inc.

DUT: GS107a; Type: Cellular/PCS GSM Phone; Serial:#1

Communication System: PCS 1900; Frequency: 1880 MHz; Duty Cycle: 1:8.3

Medium: Body 1880 MHz; ($\sigma = 1.51$ mho/m; $\epsilon_r = 54.2$; $\rho = 1000$ kg/m³)

Phantom section: Flat Section

Test Date: 10/17/2009; Ambient Temp: 22.0°C; Tissue Temp: 21.8°C

Probe: ET3DV6 - SN1729; ConvF(4.69, 4.69, 4.69); Calibrated: 2009-01-20

Sensor-Surface: 4mm (Mechanical Surface Detection)

Electronics: DAE4 Sn646; Calibrated: 2009-05-25

Phantom: SAM with CRP 1800MHz; Type: SAM; Serial: TP-1244

Measurement SW: DASY4, V4.7 Build 71; Postprocessing SW: SEMCAD, V1.8 Build 184

Flat Touch, Ch.661, Rear, Fixed Ant., Standard Battery

Area Scan (81x121x1): Measurement grid: dx=15mm, dy=15mm

Maximum value of SAR (interpolated) = 0.340mW/g

Zoom Scan (5x5x7): Measurement grid: dx=8mm, dy=8mm, dz=5mm

Reference Value = 8.95 V/m; Power Drift = -0.021 dB

Peak SAR (extrapolated) = 0.609 W/kg

SAR(1 g) = 0.323mW/g; SAR(10 g) = 0.201mW/g

Maximum value of SAR (measured) = 0.338mW/g

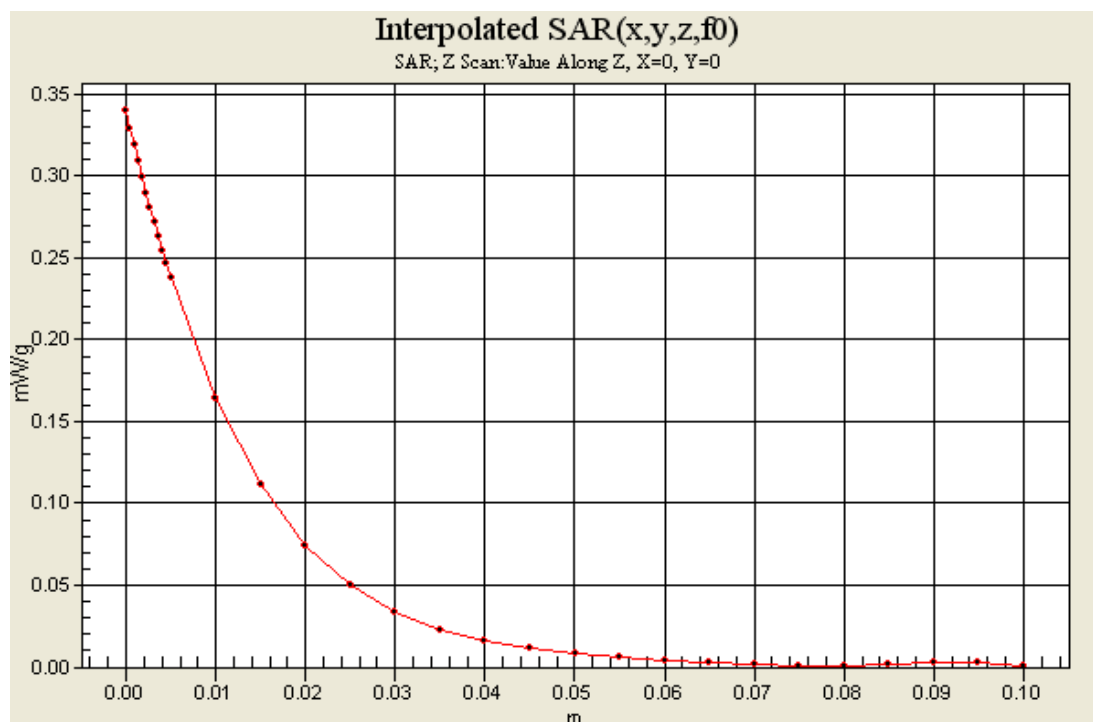

0 dB = 0.338mW/g

APPENDIX C: Calibration Certificates

**Calibration Laboratory of
Schmid & Partner
Engineering AG**
Zeughausstrasse 43, 8004 Zurich, Switzerland









S Schweizerischer Kalibrierdienst
C Service suisse d'étalonnage
S Servizio svizzero di taratura
S Swiss Calibration Service

Accredited by the Swiss Accreditation Service (SAS)
The Swiss Accreditation Service is one of the signatories to the EA
Multilateral Agreement for the recognition of calibration certificates

Accreditation No.: **SCS 108**

Client: **LG Dymstec**

Certificate No.: **ET3-1729_Jan09**

CALIBRATION CERTIFICATE																																																															
Object	ET3DV6 SN:1729																																																														
Calibration procedure(s)	QA/CAL-01/v6 and QA/CAL-23/v3 Calibration procedure for dosimetric E-field probes																																																														
Calibration date:	January 20, 2009																																																														
Condition of the calibrated item	In Tolerance																																																														
<p>This calibration certificate documents the traceability to national standards, which realize the physical units of measurements (SI). The measurements and the uncertainties with confidence probability are given on the following pages and are part of the certificate.</p> <p>All calibrations have been conducted in the closed laboratory facility: environment temperature (22 ± 3)°C and humidity < 70%.</p> <p>Calibration Equipment used (M&TE critical for calibration)</p> <table border="1"> <thead> <tr> <th>Primary Standards</th> <th>ID #</th> <th>Cal Date (Certificate No.)</th> <th>Scheduled Calibration</th> </tr> </thead> <tbody> <tr> <td>Power meter E4419B</td> <td>GB41293874</td> <td>1-Apr-08 (No. 217-00788)</td> <td>Apr-09</td> </tr> <tr> <td>Power sensor E4412A</td> <td>MY41495277</td> <td>1-Apr-08 (No. 217-00788)</td> <td>Apr-09</td> </tr> <tr> <td>Power sensor E4412A</td> <td>MY41498087</td> <td>1-Apr-08 (No. 217-00788)</td> <td>Apr-09</td> </tr> <tr> <td>Reference 3 dB Attenuator</td> <td>SN: S5054 (3c)</td> <td>1-Jul-08 (No. 217-00865)</td> <td>Jul-09</td> </tr> <tr> <td>Reference 20 dB Attenuator</td> <td>SN: S5086 (20b)</td> <td>31-Mar-08 (No. 217-00787)</td> <td>Apr-09</td> </tr> <tr> <td>Reference 30 dB Attenuator</td> <td>SN: S5129 (30b)</td> <td>1-Jul-08 (No. 217-00866)</td> <td>Jul-09</td> </tr> <tr> <td>Reference Probe ES3DV2</td> <td>SN: 3013</td> <td>2-Jan-09 (No. ES3-3013_Jan09)</td> <td>Jan-10</td> </tr> <tr> <td>DAE4</td> <td>SN: 660</td> <td>9-Sep-08 (No. DAE4-660_Sep08)</td> <td>Sep-09</td> </tr> </tbody> </table> <table border="1"> <thead> <tr> <th>Secondary Standards</th> <th>ID #</th> <th>Check Date (in house)</th> <th>Scheduled Check</th> </tr> </thead> <tbody> <tr> <td>RF generator HP 8648C</td> <td>US3642U01700</td> <td>4-Aug-99 (in house check Oct-07)</td> <td>In house check: Oct-09</td> </tr> <tr> <td>Network Analyzer HP 8753E</td> <td>US37390585</td> <td>18-Oct-01 (in house check Oct-08)</td> <td>In house check: Oct-09</td> </tr> </tbody> </table> <table border="1"> <thead> <tr> <th>Calibrated by:</th> <th>Name</th> <th>Function</th> <th>Signature</th> </tr> </thead> <tbody> <tr> <td></td> <td>Katja Pokovic</td> <td>Technical Manager</td> <td></td> </tr> <tr> <td>Approved by:</td> <td>Niels Kusjer</td> <td>Quality Manager</td> <td></td> </tr> </tbody> </table> <p>Issued: January 20, 2009</p> <p>This calibration certificate shall not be reproduced except in full without written approval of the laboratory.</p>				Primary Standards	ID #	Cal Date (Certificate No.)	Scheduled Calibration	Power meter E4419B	GB41293874	1-Apr-08 (No. 217-00788)	Apr-09	Power sensor E4412A	MY41495277	1-Apr-08 (No. 217-00788)	Apr-09	Power sensor E4412A	MY41498087	1-Apr-08 (No. 217-00788)	Apr-09	Reference 3 dB Attenuator	SN: S5054 (3c)	1-Jul-08 (No. 217-00865)	Jul-09	Reference 20 dB Attenuator	SN: S5086 (20b)	31-Mar-08 (No. 217-00787)	Apr-09	Reference 30 dB Attenuator	SN: S5129 (30b)	1-Jul-08 (No. 217-00866)	Jul-09	Reference Probe ES3DV2	SN: 3013	2-Jan-09 (No. ES3-3013_Jan09)	Jan-10	DAE4	SN: 660	9-Sep-08 (No. DAE4-660_Sep08)	Sep-09	Secondary Standards	ID #	Check Date (in house)	Scheduled Check	RF generator HP 8648C	US3642U01700	4-Aug-99 (in house check Oct-07)	In house check: Oct-09	Network Analyzer HP 8753E	US37390585	18-Oct-01 (in house check Oct-08)	In house check: Oct-09	Calibrated by:	Name	Function	Signature		Katja Pokovic	Technical Manager		Approved by:	Niels Kusjer	Quality Manager	
Primary Standards	ID #	Cal Date (Certificate No.)	Scheduled Calibration																																																												
Power meter E4419B	GB41293874	1-Apr-08 (No. 217-00788)	Apr-09																																																												
Power sensor E4412A	MY41495277	1-Apr-08 (No. 217-00788)	Apr-09																																																												
Power sensor E4412A	MY41498087	1-Apr-08 (No. 217-00788)	Apr-09																																																												
Reference 3 dB Attenuator	SN: S5054 (3c)	1-Jul-08 (No. 217-00865)	Jul-09																																																												
Reference 20 dB Attenuator	SN: S5086 (20b)	31-Mar-08 (No. 217-00787)	Apr-09																																																												
Reference 30 dB Attenuator	SN: S5129 (30b)	1-Jul-08 (No. 217-00866)	Jul-09																																																												
Reference Probe ES3DV2	SN: 3013	2-Jan-09 (No. ES3-3013_Jan09)	Jan-10																																																												
DAE4	SN: 660	9-Sep-08 (No. DAE4-660_Sep08)	Sep-09																																																												
Secondary Standards	ID #	Check Date (in house)	Scheduled Check																																																												
RF generator HP 8648C	US3642U01700	4-Aug-99 (in house check Oct-07)	In house check: Oct-09																																																												
Network Analyzer HP 8753E	US37390585	18-Oct-01 (in house check Oct-08)	In house check: Oct-09																																																												
Calibrated by:	Name	Function	Signature																																																												
	Katja Pokovic	Technical Manager																																																													
Approved by:	Niels Kusjer	Quality Manager																																																													

Certificate No: ET3-1729_Jan09

Page 1 of 9

**Calibration Laboratory of
Schmid & Partner
Engineering AG**
Zeughausstrasse 43, 8004 Zurich, Switzerland



S Schweizerischer Kalibrierdienst
C Service suisse d'étalonnage
S Servizio svizzero di taratura
S Swiss Calibration Service

Accredited by the Swiss Accreditation Service (SAS)
The Swiss Accreditation Service is one of the signatories to the EA
Multilateral Agreement for the recognition of calibration certificates

Accreditation No.: **SCS 108**

Glossary:

TSL tissue simulating liquid
 NORM_{x,y,z} sensitivity in free space
 ConvF sensitivity in TSL / NORM_{x,y,z}
 DCP diode compression point
 Polarization ϕ ϕ rotation around probe axis
 Polarization ϑ ϑ rotation around an axis that is in the plane normal to probe axis (at measurement center), i.e., $\vartheta = 0$ is normal to probe axis

Calibration is Performed According to the Following Standards:

- a) IEEE Std 1528-2003, "IEEE Recommended Practice for Determining the Peak Spatial-Averaged Specific Absorption Rate (SAR) in the Human Head from Wireless Communications Devices: Measurement Techniques", December 2003
- b) IEC 62209-1, "Procedure to measure the Specific Absorption Rate (SAR) for hand-held devices used in close proximity to the ear (frequency range of 300 MHz to 3 GHz)", February 2005

Methods Applied and Interpretation of Parameters:

- **NORM_{x,y,z}:** Assessed for E-field polarization $\vartheta = 0$ ($f \leq 900$ MHz in TEM-cell; $f > 1800$ MHz: R22 waveguide). NORM_{x,y,z} are only intermediate values, i.e., the uncertainties of NORM_{x,y,z} does not effect the E²-field uncertainty inside TSL (see below ConvF).
- **NORM(f)_{x,y,z} = NORM_{x,y,z} * frequency_response** (see Frequency Response Chart). This linearization is implemented in DASY4 software versions later than 4.2. The uncertainty of the frequency response is included in the stated uncertainty of ConvF.
- **DCP_{x,y,z}:** DCP are numerical linearization parameters assessed based on the data of power sweep (no uncertainty required). DCP does not depend on frequency nor media.
- **ConvF and Boundary Effect Parameters:** Assessed in flat phantom using E-field (or Temperature Transfer Standard for $f \leq 800$ MHz) and inside waveguide using analytical field distributions based on power measurements for $f > 800$ MHz. The same setups are used for assessment of the parameters applied for boundary compensation (alpha, depth) of which typical uncertainty values are given. These parameters are used in DASY4 software to improve probe accuracy close to the boundary. The sensitivity in TSL corresponds to NORM_{x,y,z} * ConvF whereby the uncertainty corresponds to that given for ConvF. A frequency dependent ConvF is used in DASY version 4.4 and higher which allows extending the validity from ± 50 MHz to ± 100 MHz.
- **Spherical isotropy (3D deviation from isotropy):** in a field of low gradients realized using a flat phantom exposed by a patch antenna.
- **Sensor Offset:** The sensor offset corresponds to the offset of virtual measurement center from the probe tip (on probe axis). No tolerance required.

ET3DV6 SN:1729

January 20, 2009

Probe ET3DV6

SN:1729

Manufactured:	October 1, 2002
Last calibrated:	February 21, 2007
Recalibrated:	January 20, 2009

Calibrated for DASY Systems

(Note: non-compatible with DASY2 system!)

Certificate No: ET3-1729_Jan09

Page 3 of 9

ET3DV6 SN:1729

January 20, 2009

DASY - Parameters of Probe: ET3DV6 SN:1729

Sensitivity in Free Space^A

Diode Compression^B

NormX	1.66 ± 10.1%	μV/(V/m) ²	DCP X	93 mV
NormY	1.63 ± 10.1%	μV/(V/m) ²	DCP Y	94 mV
NormZ	1.82 ± 10.1%	μV/(V/m) ²	DCP Z	92 mV

Sensitivity in Tissue Simulating Liquid (Conversion Factors)

Please see Page 8.

Boundary Effect

TSL **900 MHz** Typical SAR gradient: 5 % per mm

Sensor Center to Phantom Surface Distance		3.7 mm	4.7 mm
SAR _{be} [%]	Without Correction Algorithm	10.3	5.9
SAR _{be} [%]	With Correction Algorithm	0.8	0.4

TSL **1810 MHz** Typical SAR gradient: 10 % per mm

Sensor Center to Phantom Surface Distance		3.7 mm	4.7 mm
SAR _{be} [%]	Without Correction Algorithm	12.8	8.4
SAR _{be} [%]	With Correction Algorithm	0.9	0.3

Sensor Offset

Probe Tip to Sensor Center **2.7 mm**

The reported uncertainty of measurement is stated as the standard uncertainty of measurement multiplied by the coverage factor k=2, which for a normal distribution corresponds to a coverage probability of approximately 95%.

^A The uncertainties of NormX,Y,Z do not affect the E²-field uncertainty inside TSL (see Page 8).

^B Numerical linearization parameter: uncertainty not required.

ET3DV6 SN:1729

January 20, 2009

Frequency Response of E-Field (TEM-Cell:if110 EXX, Waveguide: R22)

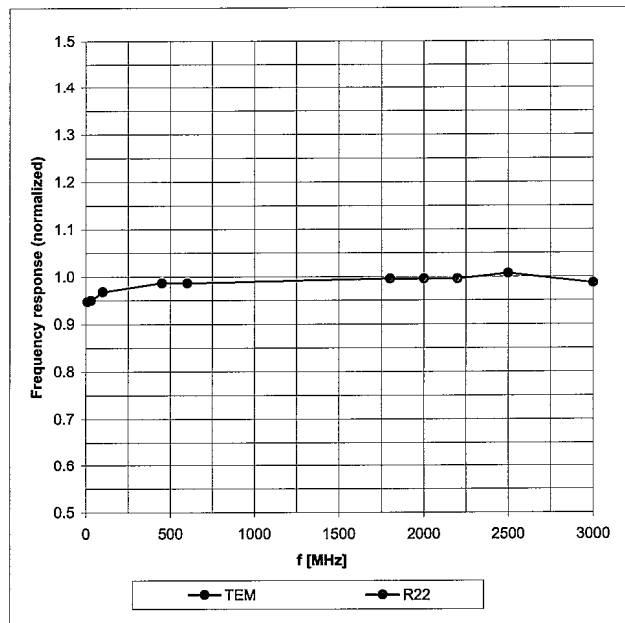

Uncertainty of Frequency Response of E-field: $\pm 6.3\%$ ($k=2$)

Certificate No: ET3-1729_Jan09

Page 5 of 9

ET3DV6 SN:1729

January 20, 2009

Receiving Pattern (ϕ), $\vartheta = 0^\circ$

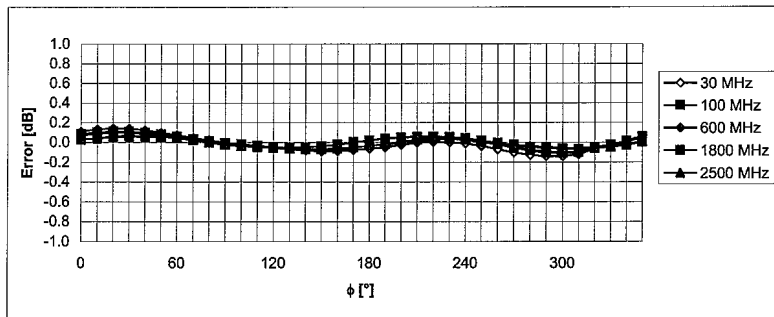
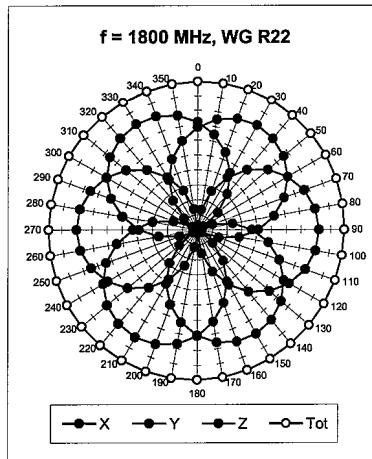
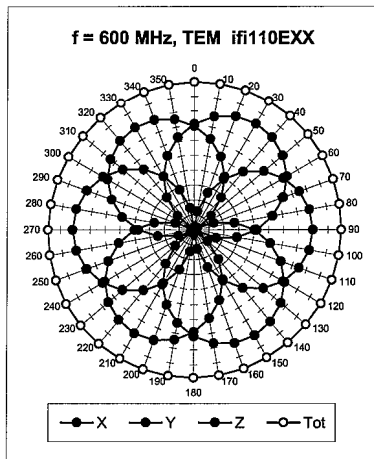

Uncertainty of Axial Isotropy Assessment: $\pm 0.5\%$ ($k=2$)

Certificate No: ET3-1729_Jan09

Page 6 of 9

ET3DV6 SN:1729

January 20, 2009

Dynamic Range f(SAR_{head})
(Waveguide R22, f = 1800 MHz)

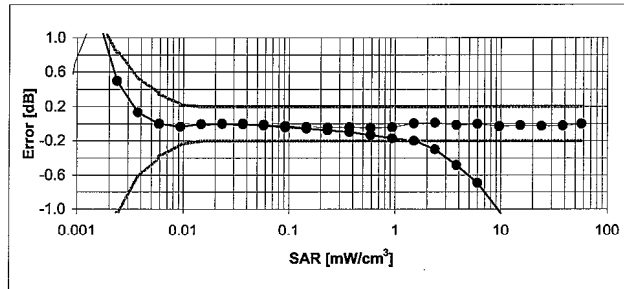
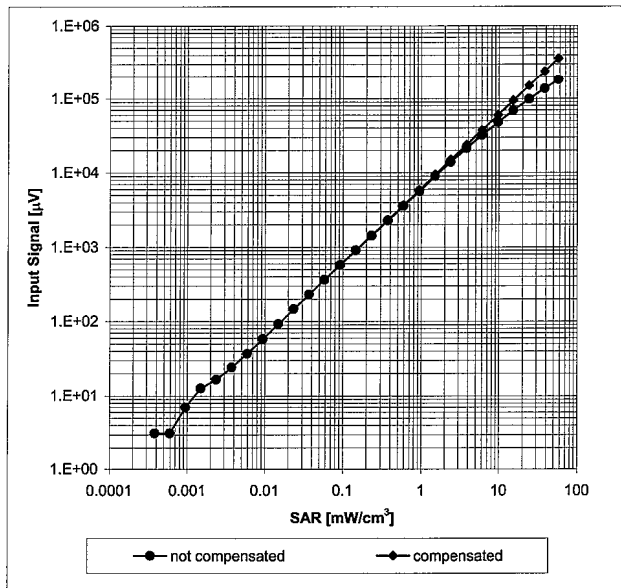

Uncertainty of Linearity Assessment: $\pm 0.6\%$ (k=2)

Certificate No: ET3-1729_Jan09

Page 7 of 9

ET3DV6 SN:1729

January 20, 2009

Conversion Factor Assessment

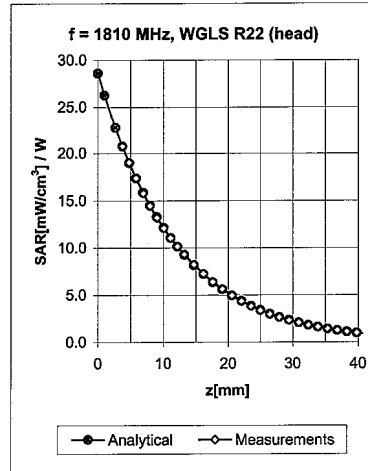
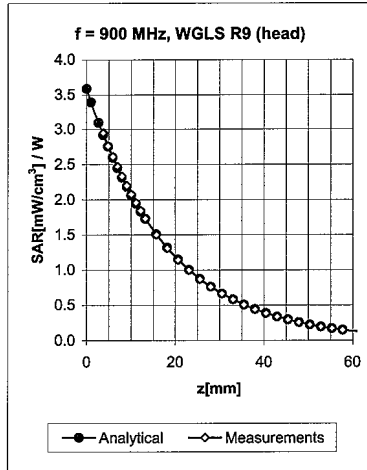

f [MHz]	Validity [MHz] ^c	TSL	Permittivity	Conductivity	Alpha	Depth	ConvF Uncertainty
900	± 50 / ± 100	Head	41.5 ± 5%	0.97 ± 5%	0.44	2.27	5.92 ± 11.0% (k=2)
1810	± 50 / ± 100	Head	40.0 ± 5%	1.40 ± 5%	0.75	2.22	5.11 ± 11.0% (k=2)
1950	± 50 / ± 100	Head	40.0 ± 5%	1.40 ± 5%	0.66	2.45	4.87 ± 11.0% (k=2)
900	± 50 / ± 100	Body	55.0 ± 5%	1.05 ± 5%	0.39	2.60	5.82 ± 11.0% (k=2)
1810	± 50 / ± 100	Body	53.3 ± 5%	1.52 ± 5%	0.87	2.11	4.67 ± 11.0% (k=2)
1950	± 50 / ± 100	Body	53.3 ± 5%	1.52 ± 5%	0.99	1.87	4.65 ± 11.0% (k=2)

^c The validity of ± 100 MHz only applies for DASY v4.4 and higher (see Page 2). The uncertainty is the RSS of the ConvF uncertainty at calibration frequency and the uncertainty for the indicated frequency band.

Certificate No: ET3-1729_Jan09

Page 8 of 9

ET3DV6 SN:1729

January 20, 2009

Deviation from Isotropy in HSL

Error (ϕ, ϑ), $f = 900$ MHz

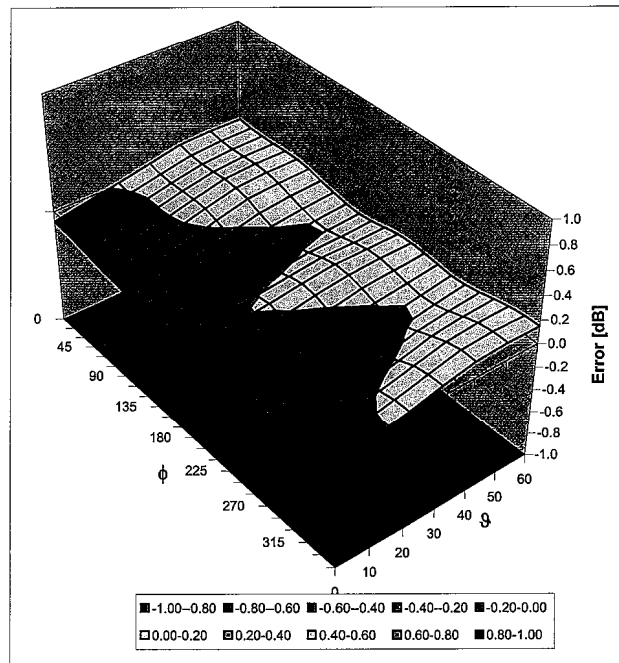

Uncertainty of Spherical Isotropy Assessment: $\pm 2.6\%$ ($k=2$)

Certificate No: ET3-1729_Jan09

Page 9 of 9

Schmid & Partner Engineering AG

s p e a g

Zeughausstrasse 43, 8004 Zurich, Switzerland
 Phone +41 44 245 9700, Fax +41 44 245 9779
 info@speag.com, http://www.speag.com

Additional Conversion Factors
 for Dosimetric E-Field Probe

Type:	ET3DV6
Serial Number:	1729
Place of Assessment:	Zurich
Date of Assessment:	April 27, 2009
Probe Calibration Date:	January 20, 2009

Schmid & Partner Engineering AG hereby certifies that conversion factor(s) of this probe have been evaluated on the date indicated above. The assessment was performed using the FDTD numerical code SEMCAD of Schmid & Partner Engineering AG. Since the evaluation is coupled with measured conversion factors, it has to be recalculated yearly, i.e., following the recalibration schedule of the probe. The uncertainty of the numerical assessment is based on the extrapolation from measured value at 900 MHz or at 1810 MHz.

Assessed by:

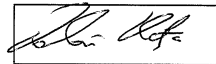

Schmid & Partner Engineering AG

s p e a g

Zeughausstrasse 43, 8004 Zurich, Switzerland
 Phone +41 44 245 9700, Fax +41 44 245 9779
 info@speag.com, http://www.speag.com

Dosimetric E-Field Probe ET3DV6 - SN:1729

Conversion factor (\pm standard deviation)

835 \pm 50 MHz	<i>ConvF</i>	6.08 \pm 7%	$\epsilon_r = 41.5 \pm 5\%$ $\sigma = 0.90 \pm 5\%$ mho/m (head tissue)
1900 \pm 50 MHz	<i>ConvF</i>	4.96 \pm 7%	$\epsilon_r = 40.0 \pm 5\%$ $\sigma = 1.40 \pm 5\%$ mho/m (head tissue)
835 \pm 50 MHz	<i>ConvF</i>	5.84 \pm 7%	$\epsilon_r = 55.2 \pm 5\%$ $\sigma = 0.97 \pm 5\%$ mho/m (body tissue)
1900 \pm 50 MHz	<i>ConvF</i>	4.69 \pm 7%	$\epsilon_r = 53.3 \pm 5\%$ $\sigma = 1.52 \pm 5\%$ mho/m (body tissue)

Important Note:

For numerically assessed probe conversion factors, parameters Alpha and Delta in the DASY software must have the following entries: Alpha = 0 and Delta = 1.

Please see also Section 4.7 of the DASY4 Manual.

**Calibration Laboratory of
Schmid & Partner
Engineering AG**
Zeughausstrasse 43, 8004 Zurich, Switzerland



S Schweizerischer Kalibrierdienst
C Service suisse d'étalonnage
S Servizio svizzero di taratura
S Swiss Calibration Service

Accredited by the Swiss Accreditation Service (SAS)
The Swiss Accreditation Service is one of the signatories to the EA
Multilateral Agreement for the recognition of calibration certificates

Accreditation No.: **SCS 108**

Client **LG (Dymstec)**

Certificate No: **D835V2-471_Jan09**

CALIBRATION CERTIFICATE

Object: **D835V2 - SN: 471**

Calibration procedure(s): **QA CAL-05.v7
Calibration procedure for dipole validation kits**

Calibration date: **January 19, 2009**



Condition of the calibrated item: **In Tolerance**

This calibration certificate documents the traceability to national standards, which realize the physical units of measurements (SI).
The measurements and the uncertainties with confidence probability are given on the following pages and are part of the certificate.

All calibrations have been conducted in the closed laboratory facility: environment temperature (22 ± 3)°C and humidity < 70%.

Calibration Equipment used (M&TE critical for calibration)

Primary Standards	ID #	Cal Date (Certificate No.)	Scheduled Calibration
Power meter EPM-442A	GB37480704	08-Oct-08 (No. 217-00898)	Oct-09
Power sensor HP 8481A	US37292783	08-Oct-08 (No. 217-00898)	Oct-09
Reference 20 dB Attenuator	SN: 5086 (20g)	01-Jul-08 (No. 217-00864)	Jul-09
Type-N mismatch combination	SN: 5047.2 / 06327	01-Jul-08 (No. 217-00867)	Jul-09
Reference Probe ES3DV2	SN: 3025	28-Apr-08 (No. ES3-3025_Apr08)	Apr-09
DAE4	SN: 601	14-Mar-08 (No. DAE4-601_Mar08)	Mar-09
Secondary Standards	ID #	Check Date (in house)	Scheduled Check
Power sensor HP 8481A	MY41092317	18-Oct-02 (in house check Oct-07)	In house check: Oct-09
RF generator R&S SMT-06	100005	4-Aug-99 (in house check Oct-07)	In house check: Oct-09
Network Analyzer HP 8753E	US37390585 S4206	18-Oct-01 (in house check Oct-08)	In house check: Oct-09

Calibrated by:	Name	Function	Signature
	Jeton Kastrati	Laboratory Technician	
Approved by:	Katja Pokovic	Technical Manager	

Issued: January 20, 2009

This calibration certificate shall not be reproduced except in full without written approval of the laboratory.

**Calibration Laboratory of
Schmid & Partner
Engineering AG**
Zeughausstrasse 43, 8004 Zurich, Switzerland





S Schweizerischer Kalibrierdienst
C Service suisse d'étalonnage
S Servizio svizzero di taratura
S Swiss Calibration Service

Accredited by the Swiss Accreditation Service (SAS)
The Swiss Accreditation Service is one of the signatories to the EA
Multilateral Agreement for the recognition of calibration certificates

Accreditation No.: **SCS 108**

Glossary:

TSL	tissue simulating liquid
ConvF	sensitivity in TSL / NORM x,y,z
N/A	not applicable or not measured

Calibration is Performed According to the Following Standards:

- a) IEEE Std 1528-2003, "IEEE Recommended Practice for Determining the Peak Spatial-Averaged Specific Absorption Rate (SAR) in the Human Head from Wireless Communications Devices: Measurement Techniques", December 2003
- b) IEC 62209-1, "Procedure to measure the Specific Absorption Rate (SAR) for hand-held devices used in close proximity to the ear (frequency range of 300 MHz to 3 GHz)", February 2005
- c) Federal Communications Commission Office of Engineering & Technology (FCC OET), "Evaluating Compliance with FCC Guidelines for Human Exposure to Radiofrequency Electromagnetic Fields; Additional Information for Evaluating Compliance of Mobile and Portable Devices with FCC Limits for Human Exposure to Radiofrequency Emissions", Supplement C (Edition 01-01) to Bulletin 65

Additional Documentation:

- d) DASY4/5 System Handbook

Methods Applied and Interpretation of Parameters:

- *Measurement Conditions:* Further details are available from the Validation Report at the end of the certificate. All figures stated in the certificate are valid at the frequency indicated.
- *Antenna Parameters with TSL:* The dipole is mounted with the spacer to position its feed point exactly below the center marking of the flat phantom section, with the arms oriented parallel to the body axis.
- *Feed Point Impedance and Return Loss:* These parameters are measured with the dipole positioned under the liquid filled phantom. The impedance stated is transformed from the measurement at the SMA connector to the feed point. The Return Loss ensures low reflected power. No uncertainty required.
- *Electrical Delay:* One-way delay between the SMA connector and the antenna feed point. No uncertainty required.
- *SAR measured:* SAR measured at the stated antenna input power.
- *SAR normalized:* SAR as measured, normalized to an input power of 1 W at the antenna connector.
- *SAR for nominal TSL parameters:* The measured TSL parameters are used to calculate the nominal SAR result.

Certificate No: D835V2-471_Jan09
Page 2 of 6

Measurement Conditions

DASY system configuration, as far as not given on page 1.

DASY Version	DASY5	V5.0
Extrapolation	Advanced Extrapolation	
Phantom	Modular Flat Phantom V4.9	
Distance Dipole Center - TSL	15 mm	with Spacer
Zoom Scan Resolution	dx, dy, dz = 5 mm	
Frequency	835 MHz ± 1 MHz	

Head TSL parameters

The following parameters and calculations were applied.

	Temperature	Permittivity	Conductivity
Nominal Head TSL parameters	22.0 °C	41.5	0.90 mho/m
Measured Head TSL parameters	(22.0 ± 0.2) °C	41.3 ± 6 %	0.91 mho/m ± 6 %
Head TSL temperature during test	(21.5 ± 0.2) °C	----	----

SAR result with Head TSL

SAR averaged over 1 cm ³ (1 g) of Head TSL	Condition	
SAR measured	250 mW input power	2.44 mW / g
SAR normalized	normalized to 1W	9.76 mW / g
SAR for nominal Head TSL parameters ¹	normalized to 1W	9.66 mW / g ± 17.0 % (k=2)

SAR averaged over 10 cm ³ (10 g) of Head TSL	condition	
SAR measured	250 mW input power	1.61 mW / g
SAR normalized	normalized to 1W	6.44 mW / g
SAR for nominal Head TSL parameters ¹	normalized to 1W	6.39 mW / g ± 16.5 % (k=2)

¹ Correction to nominal TSL parameters according to d), chapter "SAR Sensitivities"

Appendix

Antenna Parameters with Head TSL

Impedance, transformed to feed point	51.7 Ω - 1.7 j Ω
Return Loss	- 32.5 dB

General Antenna Parameters and Design

Electrical Delay (one direction)	1.386 ns
----------------------------------	----------

After long term use with 100W radiated power, only a slight warming of the dipole near the feedpoint can be measured.

The dipole is made of standard semirigid coaxial cable. The center conductor of the feeding line is directly connected to the second arm of the dipole. The antenna is therefore short-circuited for DC-signals.

No excessive force must be applied to the dipole arms, because they might bend or the soldered connections near the feedpoint may be damaged.

Additional EUT Data

Manufactured by	SPEAG
Manufactured on	November 15, 2002

DASY5 Validation Report for Head TSL

Date/Time: 19.01.2009 11:07:17

Test Laboratory: SPEAG, Zurich, Switzerland

DUT: Dipole 835 MHz; Type: D835V2; Serial: D835V2 - SN:471

Communication System: CW-835; Frequency: 835 MHz; Duty Cycle: 1:1

Medium: HSL 900 MHz

Medium parameters used: $f = 835$ MHz; $\sigma = 0.91$ mho/m; $\epsilon_r = 41.1$; $\rho = 1000$ kg/m³

Phantom section: Flat Section

Measurement Standard: DASY5 (IEEE/IEC)

DASY5 Configuration:

- Probe: ES3DV2 - SN3025; ConvF(5.97, 5.97, 5.97); Calibrated: 28.04.2008
- Sensor-Surface: 3.4mm (Mechanical Surface Detection)
- Electronics: DAE4 Sn601; Calibrated: 14.03.2008
- Phantom: Flat Phantom 4.9L; Type: QD000P49AA; Serial: 1001
- Measurement SW: DASY5, V5.0 Build 120; SEMCAD X Version 13.4 Build 45

Pin=250mW; dip=15mm; dist=3.4mm/Zoom Scan (7x7x7)/Cube 0: Measurement grid: dx=5mm, dy=5mm, dz=5mm

Reference Value = 56.2 V/m; Power Drift = 0.026 dB

Peak SAR (extrapolated) = 3.61 W/kg

SAR(1 g) = 2.44 mW/g; SAR(10 g) = 1.61 mW/g

Maximum value of SAR (measured) = 2.75 mW/g

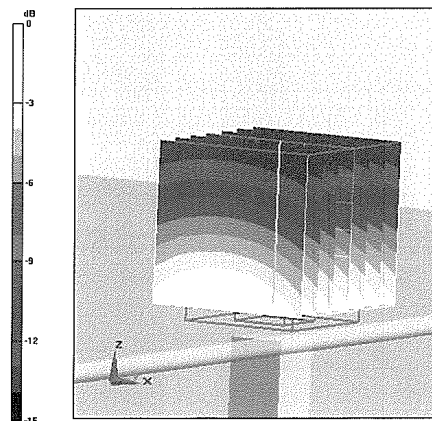

0 dB = 2.75mW/g

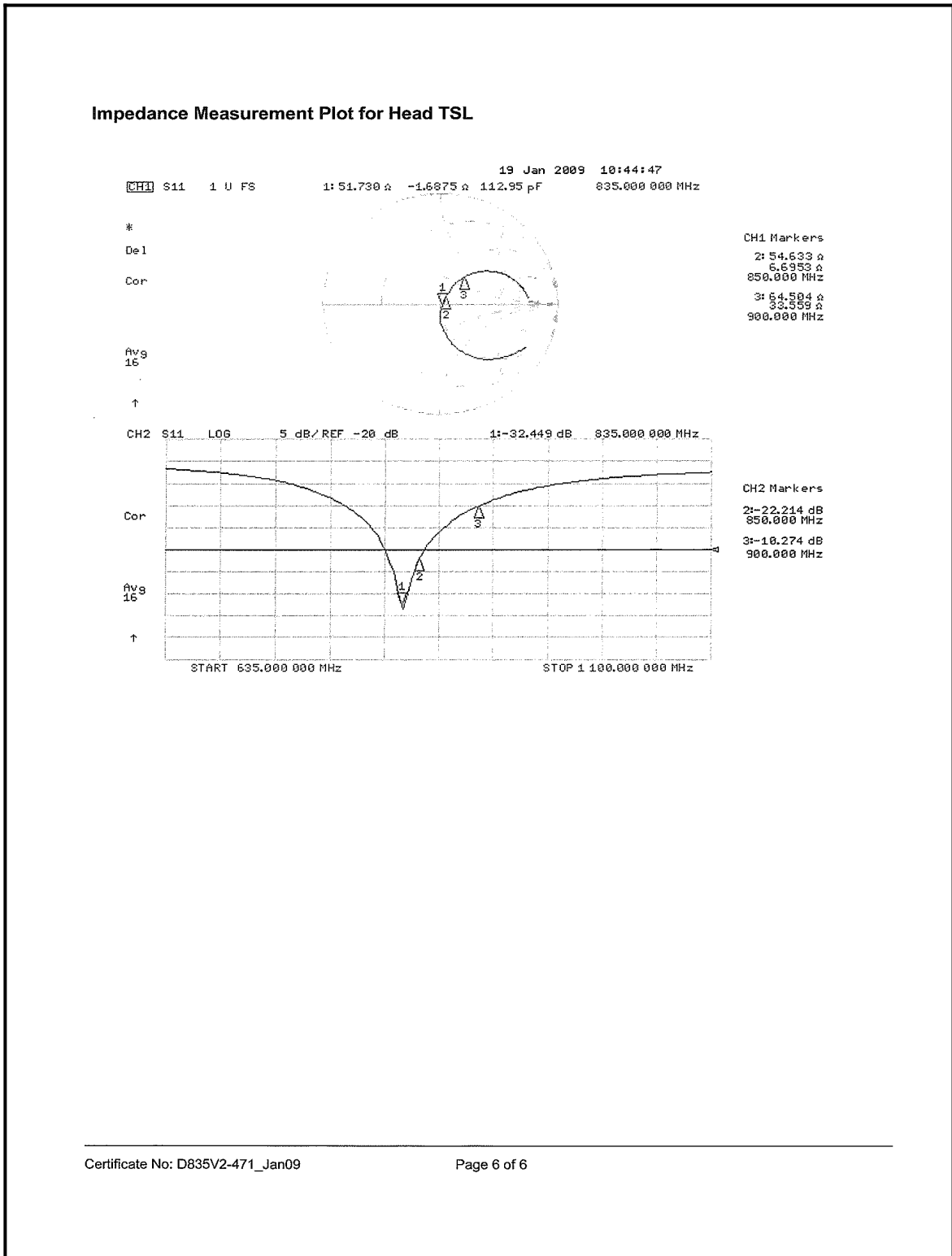

**Calibration Laboratory of
Schmid & Partner
Engineering AG**
Zeughausstrasse 43, 8004 Zurich, Switzerland





S Schweizerischer Kalibrierdienst
C Service suisse d'étalonnage
S Servizio svizzero di taratura
S Swiss Calibration Service

Accredited by the Swiss Federal Office of Metrology and Accreditation
The Swiss Accreditation Service is one of the signatories to the EA
Multilateral Agreement for the recognition of calibration certificates

Accreditation No.: **SCS 108**

Client **LG (Dymstec)**

Certificate No: **D1900V2-5d057_Apr08**

CALIBRATION CERTIFICATE

Object: **D1900V2 - SN: 5d057**

Calibration procedure(s): **QA CAL-05.v7
Calibration procedure for dipole validation kits**

Calibration date: **April 22, 2008**

Condition of the calibrated item: **In Tolerance**

This calibration certificate documents the traceability to national standards, which realize the physical units of measurements (SI).
The measurements and the uncertainties with confidence probability are given on the following pages and are part of the certificate.

All calibrations have been conducted in the closed laboratory facility: environment temperature (22 ± 3)°C and humidity < 70%.

Calibration Equipment used (M&TE critical for calibration)

Primary Standards	ID #	Cal Date (Calibrated by, Certificate No.)	Scheduled Calibration
Power meter EPM-442A	GB37480704	04-Oct-07 (No. 217-00736)	Oct-08
Power sensor HP 8481A	US37292783	04-Oct-07 (No. 217-00736)	Oct-08
Reference 20 dB Attenuator	SN: 5086 (20g)	07-Aug-07 (No. 217-00718)	Aug-08
Type-N mismatch combination	SN: 5047.2 / 06327	08-Aug-07 (No. 217-00721)	Aug-08
Reference Probe ES3DV2	SN: 3025	01-Mar-08 (No. ES3-3025_Mar08)	Mar-09
DAE4	SN: 601	14-Mar-08 (No. DAE4-601_Mar08)	Mar-09

Secondary Standards	ID #	Check Date (in house)	Scheduled Check
Power sensor HP 8481A	MY41092317	18-Oct-02 (in house check Oct-07)	In house check: Oct-08
RF generator R&S SMT-06	100005	4-Aug-99 (in house check Oct-07)	In house check: Oct-09
Network Analyzer HP 8753E	US37390585 S4206	18-Oct-01 (in house check Oct-07)	In house check: Oct-08

Calibrated by: **Marcel Fehr**

Name: **Marcel Fehr** Function: **Laboratory Technician**

Signature: 

Approved by: **Katja Pokovic**

Name: **Katja Pokovic** Function: **Technical Manager**

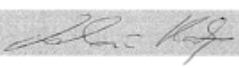
Signature: 

Issued: April 23, 2008

This calibration certificate shall not be reproduced except in full without written approval of the laboratory.

Certificate No: D1900V2-5d057_Apr08

Page 1 of 6

**Calibration Laboratory of
Schmid & Partner
Engineering AG**
Zeughausstrasse 43, 8004 Zurich, Switzerland



S Schweizerischer Kalibrierdienst
C Service suisse d'étalonnage
S Servizio svizzero di taratura
S Swiss Calibration Service

Accredited by the Swiss Accreditation Service (SAS)
The Swiss Accreditation Service is one of the signatories to the EA
Multilateral Agreement for the recognition of calibration certificates

Accreditation No.: **SCS 108**

Glossary:

TSL	tissue simulating liquid
ConvF	sensitivity in TSL / NORM x,y,z
N/A	not applicable or not measured

Calibration is Performed According to the Following Standards:

- IEEE Std 1528-2003, "IEEE Recommended Practice for Determining the Peak Spatial-Averaged Specific Absorption Rate (SAR) in the Human Head from Wireless Communications Devices: Measurement Techniques", December 2003
- CENELEC EN 50361, "Basic standard for the measurement of Specific Absorption Rate related to human exposure to electromagnetic fields from mobile phones (300 MHz - 3 GHz), July 2001
- Federal Communications Commission Office of Engineering & Technology (FCC OET), "Evaluating Compliance with FCC Guidelines for Human Exposure to Radiofrequency Electromagnetic Fields; Additional Information for Evaluating Compliance of Mobile and Portable Devices with FCC Limits for Human Exposure to Radiofrequency Emissions", Supplement C (Edition 01-01) to Bulletin 65

Additional Documentation:

- DASY4/5 System Handbook

Methods Applied and Interpretation of Parameters:

- Measurement Conditions:** Further details are available from the Validation Report at the end of the certificate. All figures stated in the certificate are valid at the frequency indicated.
- Antenna Parameters with TSL:** The dipole is mounted with the spacer to position its feed point exactly below the center marking of the flat phantom section, with the arms oriented parallel to the body axis.
- Feed Point Impedance and Return Loss:** These parameters are measured with the dipole positioned under the liquid filled phantom. The impedance stated is transformed from the measurement at the SMA connector to the feed point. The Return Loss ensures low reflected power. No uncertainty required.
- Electrical Delay:** One-way delay between the SMA connector and the antenna feed point. No uncertainty required.
- SAR measured:** SAR measured at the stated antenna input power.
- SAR normalized:** SAR as measured, normalized to an input power of 1 W at the antenna connector.
- SAR for nominal TSL parameters:** The measured TSL parameters are used to calculate the nominal SAR result.

Measurement Conditions

DASY system configuration, as far as not given on page 1.

DASY Version	DASY4	V4.7
Extrapolation	Advanced Extrapolation	
Phantom	Modular Flat Phantom V5.0	
Distance Dipole Center - TSL	10 mm	with Spacer
Zoom Scan Resolution	dx, dy, dz = 5 mm	
Frequency	1900 MHz ± 1 MHz	

Head TSL parameters

The following parameters and calculations were applied.

	Temperature	Permittivity	Conductivity
Nominal Head TSL parameters	22.0 °C	40.0	1.40 mho/m
Measured Head TSL parameters	(22.0 ± 0.2) °C	40.1 ± 6 %	1.47 mho/m ± 6 %
Head TSL temperature during test	(21.2 ± 0.2) °C	----	----

SAR result with Head TSL

SAR averaged over 1 cm³ (1 g) of Head TSL	condition	
SAR measured	250 mW input power	10.1 mW / g
SAR normalized	normalized to 1W	40.4 mW / g
SAR for nominal Head TSL parameters ¹	normalized to 1W	39.5 mW / g ± 17.0 % (k=2)

SAR averaged over 10 cm³ (10 g) of Head TSL	Condition	
SAR measured	250 mW input power	5.19 mW / g
SAR normalized	normalized to 1W	20.8 mW / g
SAR for nominal Head TSL parameters ¹	normalized to 1W	20.6 mW / g ± 16.5 % (k=2)

¹ Correction to nominal TSL parameters according to d), chapter "SAR Sensitivities"

Appendix

Antenna Parameters with Head TSL

Impedance, transformed to feed point	53.1 Ω + 4.8 $j\Omega$
Return Loss	- 25.2 dB

General Antenna Parameters and Design

Electrical Delay (one direction)	1.199 ns
----------------------------------	----------

After long term use with 100W radiated power, only a slight warming of the dipole near the feedpoint can be measured.

The dipole is made of standard semirigid coaxial cable. The center conductor of the feeding line is directly connected to the second arm of the dipole. The antenna is therefore short-circuited for DC-signals.

No excessive force must be applied to the dipole arms, because they might bend or the soldered connections near the feedpoint may be damaged.

Additional EUT Data

Manufactured by	SPEAG
Manufactured on	March 19, 2004

Certificate No: D1900V2-5d057_Apr08 Page 4 of 6

DASY4 Validation Report for Head TSL

Date/Time: 22.04.2008 14:09:52

Test Laboratory: SPEAG, Zurich, Switzerland

DUT: Dipole 1900 MHz; Type: D1900V2; Serial: D1900V2 - SN:5d057

Communication System: CW; Frequency: 1900 MHz; Duty Cycle: 1:1

Medium: HSL U10 BB;

Medium parameters used: $f = 1900 \text{ MHz}$; $\sigma = 1.47 \text{ mho/m}$; $\epsilon_r = 40.1$; $\rho = 1000 \text{ kg/m}^3$

Phantom section: Flat Section

Measurement Standard: DASY4 (High Precision Assessment)

DASY4 Configuration:

- Probe: ES3DV2 - SN3025; ConvF(4.9, 4.9, 4.9); Calibrated: 01.03.2008
- Sensor-Surface: 3.4mm (Mechanical Surface Detection)
- Electronics: DAE4 Sn601; Calibrated: 14.03.2008
- Phantom: Flat Phantom 5.0 (front); Type: QD000P50AA; ;
- Measurement SW: DASY4, V4.7 Build 55; Postprocessing SW: SEMCAD, V1.8 Build 172

Pin = 250 mW; d = 10 mm/Zoom Scan (7x7x7)/Cube 0:

Measurement grid: $dx=5\text{mm}$, $dy=5\text{mm}$, $dz=5\text{mm}$

Reference Value = 93.1 V/m; Power Drift = 0.035 dB

Peak SAR (extrapolated) = 18.8 W/kg

SAR(1 g) = 10.1 mW/g; SAR(10 g) = 5.19 mW/g

Maximum value of SAR (measured) = 12.1 mW/g

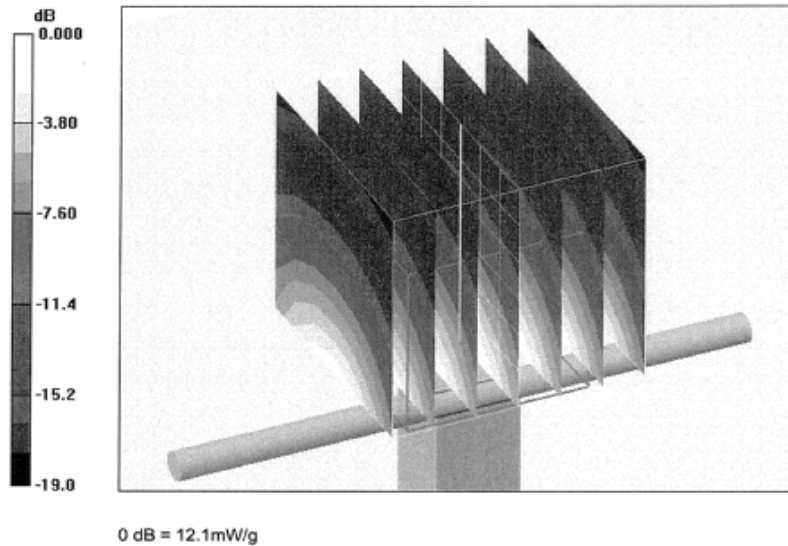

Impedance Measurement Plot for Head TSL

