



Some of the contents in this manual may differ from your phone depending on the software of the phone or your service provider.

# GD510N User Guide

Congratulations on your purchase of the advanced and compact GD510N phone by LG, designed to operate with the latest digital mobile communication technology.



#### **Disposal of your old appliance**

- 1** When this crossed-out wheeled bin symbol is attached to a product it means the product is covered by the European Directive 2002/96/EC.
- 2** All electrical and electronic products should be disposed of separately from the municipal waste stream via designated collection facilities appointed by the government or the local authorities.
- 3** The correct disposal of your old appliance will help prevent potential negative consequences for the environment and human health.
- 4** For more detailed information about disposal of your old appliance, please contact your city office, waste disposal service or the shop where you purchased the product.

This device is not intended for sale in the USA.

### **Part 15.21 statement**

" Change or Modifications that are not expressly approved by the manufacturer could void the user's authority to operate the equipment. "

### **Part 15.105 statement**

This equipment has been tested and found to comply with the limits for a class B digital device, pursuant to Part 15 of the FCC Rules.

These limits are designed to provide reasonable protection against harmful interference in a residential installation. This equipment generates uses and can radiate radio frequency energy and, if not installed and used in accordance with the instructions, may cause harmful interference to radio communications. However, there is no guarantee that interference will not occur in a particular installation. If this equipment does cause harmful interference or television reception, which can be determined by turning the equipment off and on, the user is encouraged to try to correct the interference by one or more of the following measures:

- Reorient or relocate the receiving antenna.
- Increase the separation between the equipment and receiver.
- Connect the equipment into an outlet on a circuit different from that to which the receiver is connected.
- Consult the dealer or an experienced radio/TV technician for help.

## **Part 15 Class B Compliance**

This device and its accessories comply with part15 of FCC rules & Class B digital apparatus requirements for ICES-003.

Operation is subject to the following two conditions:

- (1) This device & its accessories may not cause harmful interference.
- (2) This device & its accessories must accept any interference received,  
including interference that may cause undesired operation.

## **Body-worn Operation**

This device has been tested for typical body-worn operations with the distance of 0.79inches (2.0cm) from the user's body.

To comply with FCC RF exposure requirements, a minimum separation distance of 0.79inches(2.0cm) must be maintained from the user's body.

Additionally, Belt clips, holsters & other body-worn accessories may not contain metallic components.

# Getting to know your phone

## Side keys

- **When the screen is Home screen:** Ring tone and key tone volume.
- **During a call:** Earpiece volume.

## Charger, Cable, Handsfree connector

## Smart key

- Accepts and ends call.
- Goes to **home** screen directly.

## Power / Lock key

- Long press for **power** ON / OFF.
- Short press to turn off the screen.

## Camera/Multi-tasking key

- Long press to use the camera.
- Short press to use **multi** tasking.

 **WARNING:** Placing a heavy object on the phone or sitting on it while it is in your pocket can damage the phone's LCD and touch screen functionality.

# Open view

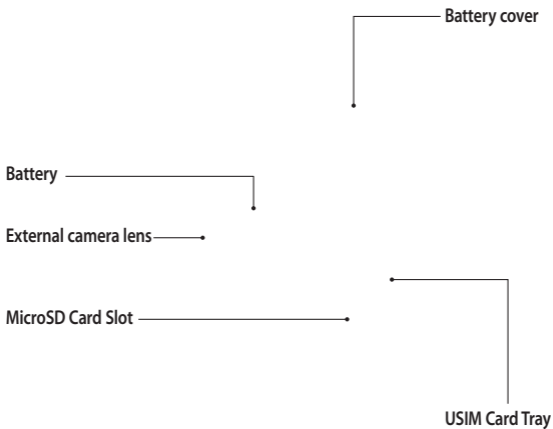

# Installing the USIM and battery

## 1 Remove the battery cover

Slide the battery cover towards the bottom of the phone and away from it.

 **WARNING:** Do not use your fingernail when removing the battery.

 **WARNING:** Do not remove the battery when the phone is switched on, as this may damage the phone.

## 2 Install the USIM card

Slide the USIM card into the USIM card holder making sure that the gold contact area on the card is facing downwards. To remove the USIM card, pull it gently in the opposite direction.

## 3 Install the battery

Insert the top of the battery into the top edge of the battery compartment first. Ensure that the battery contacts align with the terminals on the phone. Press down the bottom of the battery until it clicks into place.

# Charging your phone

Remove the charger socket cover on the side of your GD510N. Connect Travel Adapter(Charger) and the included USB cable. Connect the USB cable into the phone and plug it into a power outlet. Your GD510N must be charged until the “Battery full” message appears on the screen.

**NOTE:** The battery must be fully charged initially to improve battery lifetime. Disregard the first “Battery full” message and keep the phone on charge overnight.

# Memory card

## Installing a memory card

You can expand the memory space on your phone by using a MicroSD memory card.

**NOTE:** A memory card is an optional accessory.

- 1 Open the memory card slot cover on the right hand edge of the phone.
- 2 Slide the memory card into the slot until it clicks into place.

- 3 Replace the cover.

## Formatting the memory card

Your memory card may already be formatted. If your card isn't formatted, you will need to format it before you can begin using it.

- 1 From the Home screen select , then **Phone settings** in **SETTINGS** tab.
- 2 Touch **Memory manager** then chose **External memory**.
- 3 Touch **Format** and then confirm your choice.
- 4 Enter the password, if one is set, and your card will then be formatted and ready to use.









**NOTE:** If there is existing content on your memory card, the folder structure may be different after formatting since all files will have been deleted.

# Menu map









Touch  in the Home screen to open a **Top menu**. From here you can access further menus by scrolling through the icons:

**COMMUNICATIOIN**, **ENTERTAINMENT**, **UTILITIES** and **SETTINGS**.









## COMMUNICATIOIN

-  Contacts
-  Recent history
-  Messaging
-  E-mail
-  Dialling
-  Contact search
-  Speed Dials
-  New message









## ENTERTAINMENT

-  Camera
-  Gallery
-  My stuff
-  Music
-  Games & Apps
-  FM radio
-  Video camera
-  Muvee studio

## UTILITIES

-  Browser
-  Yahoo! Search
-  Alarm
-  Organiser
-  Memo
-  Voice recorder
-  Tools
-  Drawing panel

## SETTINGS

-  Profiles
-  Screen settings
-  Phone settings
-  Call settings
-  Bluetooth
-  Touch settings
-  Connectivity
-  Messaging setting

# Using your touch screen

## Touch screen tips

- To select an item, touch the centre of the icon.
- Do not press too hard. The touchscreen is sensitive enough to pick up on a light, firm touch.
- Use the tip of your finger to touch the option you require. Be careful not to touch any other keys.
- Whenever your GD510N is not in use it will return to the lock screen.

## Control the touch screen

The controls on the GD510N touch screen change dynamically depending on the task you are carrying out.

## Opening Applications

To open any application simply touch its icon.

## Scrolling

Drag from side to side to scroll. On some screens, such as web pages, you can also scroll up or down.

# Your home screen

You can drag and click what you need right away in all home screen types.

Active



**Widget home screen** - When you touch , the mobile widget panel appears. When you register widget by drag, widget is created in the dropped spot.

Active



**Speed dial home screen** - When you touch , the speed dial list appears.

Active



**Livesquare home screen** - On the **Livesquare** screen, making a call, sending a message and saving a number is easy using the number allocated to an avatar. To use the call, messaging or contacts function, select an avatar and choose the **Quick key** icon you want to use.

**TIP!** The User Interface is based on three types of Homescreens. To swap between the home screens just wipe quickly over display from left to right or from right to left.

# Your home screen

## The quick keys

The quick keys on your home screen provide easy, one-touch access to the functions you use the most.



Touch to bring up the touch dialling pad to make a call.



Touch to open your **Contacts**. To search for the number you want to call, enter the name of the contact at the top of the screen using the touchpad. You can also create new contacts and edit existing ones.



Touch to access the **Messaging** menu. From here you can create a new SMS or MMS, or view your message folder.

















Touch to open the full **Top menu** which is divided into four categories.

## The status bar

The status bar uses various icons to indicate things like signal strength, new messages and battery life, as well as telling you whether your Bluetooth or GPRS is active.

Below is a table which explains the meaning of the icons you're most likely to see in the status bar.

Icon	Description
	Multitasking
	Network signal strength (number of bars will vary)
	No network signal
	Remaining battery life
	Battery empty
	New text message
	New voice message
	Message inbox is full
	Message sending failed
	Multimedia message sending failed

Icon	Description
	An alarm is set
	Customised Profile in use
	Normal profile in use
	Outdoor profile in use
	Silent profile in use
	Headset in use
	Calls are diverted
	EDGE in use
	Roaming
	Flight mode is on
	Bluetooth is active
	BGM play
	BGM pause
	Memory card is enable to use

# Your home screen

## Changing your Status from the status bar

Touch the status bar to open the Status Summary. It shows the current Time, Network, SVC ID, Battery, Handset memory, External Memory, Profile, MP3 and Bluetooth status. Here you can set Profile type, play/pause MP3 and activate/deactivate Bluetooth.



## Using the Multitasking function

Press the multitasking hard key  to open the Multitasking menu. From here you can view all the applications you have running and access them with one touch.

When you have an application running in the background (e.g. a game or the FM radio),  will appear in the status bar.

# Calls



## Making a call

- 1 Touch  to open the keypad.
- 2 Key in the number using the keypad.
- 3 Touch  to initiate the call.
- 4 To end the call press the Smart key.

**TIP!** To enter + for making an international call, press and hold .



**TIP!** Press the power key to lock the touchscreen to prevent calls being made by mistake.

## Making a call from your contacts

- 1 From the home screen touch  to open the **Contacts**.
- 2 Enter the first few letters of the contact you would like to call.
- 3 From the filtered list, touch the contact you'd like to call and select the number to use if you have more than one saved.
- 4 Touch  to initiate the call

## Answering and rejecting a call

When your phone rings touch to answer the call.

Tap  to mute the ringing. This is useful if you forgot to change your profile to Silent for a meeting. Press the Smart key or touch  to reject an incoming call.

# Calls

## In-call options

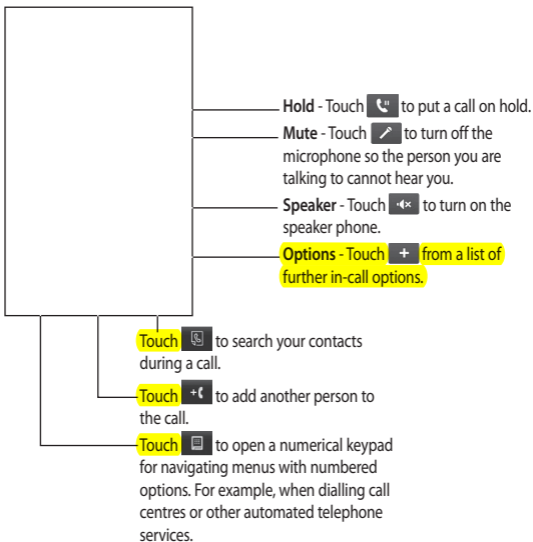



**TIP!** To scroll through a list of options or your list of contacts, touch the last item visible and slide your finger up the screen. The list will move up so more items become visible.



## Speed dialling

You can assign a frequently-called contact to a speed dial number.

- 1 Select **Contacts** in COMMUNICATION tab and tap **Speed dials**.
- 2 Your Voicemail is already set to speed dial 1. You cannot change this. Touch any other number to assign it a speed dial contact.
- 3 Your **Contacts** will open. Select the contact you'd like to assign to that number by touching their phone number once. To find a contact tap the search field box and enter the first letter of the name of the contact required.

## Making a second call

- 1 During your initial call, touch  and select the number you want to call.
- 2 Dial the number or search your contacts.
- 3 Touch  to connect the call.
- 4 Both calls will be displayed on the call screen. Your initial call will be locked and the caller put on hold.

- 5 To change between the calls, touch  and choose **Swap call** or press the number of the held call.
- 6 To end one or both calls press  and select **End** followed by **All**, **Held** or **Active**.

**TIP!** Touch any single call log entry to view the date, time and duration of the call.

**NOTE:** You will be charged for each call you make.

## Viewing your call logs

Touch **Recent history** in the COMMUNICATION tab.

**TIP!** Touch any single call log entry to view the date, time and duration of the call.

## Using call divert

- 1 Touch **Call settings** in the **SETTINGS** tab.
- 2 Touch **Call divert**.
- 3 Choose whether to divert all calls, when the line is busy, when there is no answer or when you are not reachable.

# Calls

4 Input the number you'd like to divert to.

5 Touch **Request** to activate.

**NOTE:** Charges are incurred for diverting calls. Please contact your network provider for details.

**TIP!** To turn off all call divers, choose **Deactivate all** from the **Call divert** menu.

## Using call barring

1 Touch **Call settings** in the **SETTINGS** tab.

2 Touch **Call barring**.

3 Choose any or all of the six options:

**All outgoing**

**Outgoing international**

**Outgoing international calls except**

**All incoming**

**Incoming when abroad**

**Deactivate all**

4 Enter the call barring password. Please check with your network operator for this service.

**TIP!** Select **Fixed dial**

**number** to turn on and compile a list of numbers which can be called from your phone. You'll need your PIN2 code from your operator. Only numbers included in the fixed dial list can be called from your phone.

## Changing the common call setting

1 Touch **Call settings** in the **SETTINGS** tab.

2 Touch **Common setting**. From here you can amend the settings for:

**Call reject** - Slide the switch to **On** to highlight the Reject list. You can touch the text box to choose from all calls, specific contacts or groups, or those from unregistered numbers (those not in your contacts). Touch **Save** to change the setting.

**Send my number** - Choose whether your number will be displayed when you call someone.

**Auto redial** - Slide the switch left for **On** or right for **Off**.

**Answer mode** - Choose whether to answer the phone using the send key or any key.

**Minute minder** - Slide the switch left to **On** to hear a tone every minute during a call.

**BT answer mode** - Select **Hands-free** to be able to answer a call using a Bluetooth headset, or select **Handset** to press a key on the handset to answer a call.

**Save new number** - Select **Yes** to save a new number.

# Contacts

## Searching for a contact

There are two ways to search for a contact:

- 1 Touch **Contacts** in the **COMMUNICATION** tab.
- 2 Touch **Search**.
- 3 You see a list of contacts, typing in the first letter of a contact's name will jump the menu to that alphabetical area of the list.

**TIP!** The alphabetical keypad is displayed once you tap the blank square.

## Adding a new contact

- 1 Touch **Contacts** in the **COMMUNICATION** tab. And touch **Add contact**.
- 2 Choose whether to save the contact to your **Handset** or **SIM**.
- 3 Enter your first and last name.
- 4 You can enter up to five different numbers per contact. Each entry has a preset type **Mobile**, **Home**, **Office**, **Pager**, **Fax** and **General**.
- 5 Add an email address.
- 6 Assign the contact to one or more groups. Choose from **No group**,

**Family**, **Friends**, **Colleagues**, **School** or **VIP**.

- 7 You can also add a **Ringtone**, **Birthday**, **Anniversary**, **Homepage**, **Home address**, **Company name**, **Job title**, **Company address**, **Memo** and **Livecon**.
- 8 Touch **Save** to save the contact.

## Creating a group

- 1 Touch **Contacts** in the **COMMUNICATION** tab. And touch **Group**.
- 2 Touch .
- 3 Select **Add group**.
- 4 Enter a name for your new group. You can also assign a ringtone to the group.

**NOTE:** If you delete a group, the contacts which were assigned to that group will not be lost. They will remain in your **Contacts**.

## Changing your contact settings

You can adapt your contact settings so that your **Contacts** suits your own preferences.

- 1 Touch **Contacts** in the **COMMUNICATION** tab. And touch **Settings**.
- 2 From here you can adjust the following settings:

### Contact list settings -

**Contacts location** - Choose whether to view contacts saved to both your **Handset & USIM**, **Handset** only or **USIM** only.

**Name display** - Choose to show the first name or last name of a contact first.

### Quick command key -

**Copy** - Copy your contacts from your USIM to your handset or from your handset to your USIM. Choose to do this one at a time, or all at once.

**Move** - This works in the same way as Copy, but the contact will only be saved to the location you've moved it to.

### Send all contacts via Bluetooth -

Send all of your contacts to another device using Bluetooth. You will be prompted to turn on Bluetooth if you select this option.

**Backup contacts** - See **Backing up and restoring your phone's information** on page 56.

**Restore contacts** - See **Backing up and restoring your phone's information** on page 56.

**Clear contacts** - Delete all your contacts. Touch **Yes** if you are sure you want to wipe your **Contacts**.

## Viewing information

- 1 Touch **Contacts** in the **COMMUNICATION** tab. And touch **Information**.
- 2 From here you can view your **Service dial numbers**, your **Own number**, your **Memory info**. (how much memory space you've got left) and **My business card**.

**TIP!** If you've yet to add a business card for yourself, select **My business card** and enter all your details as you would for any contact. Touch **Save** to finish.

# Messaging

## Messaging

Your GD510N combines **SMS and MMS** into one intuitive and easy to use menu.

## Sending a message

- 1 Touch **Messaging** in the **COMMUNICATION** tab. And touch **New message** to begin composing a new message.
- 2 Touch **Insert** to add an image, video, sound or template.
- 3 Touch **Recipient** at the bottom of the screen to enter the recipients. Then enter the number or touch  to select a contact. You can even add multiple contacts.
- 4 Touch **Send** when ready.

 **WARNING:** If an image, video or sound is added to an SMS it will be automatically convert to an MMS and you will be charged accordingly.

## Entering text

There are five ways to enter text:

**Keypad, Keyboard, Handwriting-Screen, Handwriting-Box, Handwriting-Double Box.**

You can choose your input method by tapping  and **Input method**. Tap the text area once to see the keyboard.

Touch  to turn on T9 mode.

Touch  to choose the writing language.

Touch  to change between numbers, symbols and text input.

Use **Shift** to change between capital or lowercase input.

## T9 mode

The T9 mode uses a built-in dictionary to recognise the words you're writing based on the sequence of keys you've touched. It predicts the word you are inputting and suggests alternatives.

## Handwriting recognition

In Handwriting mode you simply write on the screen and your GD510N will convert your handwriting into your message. Select **Handwriting-Screen** or **Handwriting-Box** according to your preferred view.

## Setting up your email

Touch **E-mail** in the COMMUNICATION tab.

If the email account is not set up, start the email set up wizard.

You can check and edit settings by selecting . You can also check the additional settings that were filled in automatically when you created the account.

## Retrieving your email

You can automatically or manually check your account for new emails. To check manually:

- 1 Touch **E-mail** in the COMMUNICATION tab.
- 2 Touch the account you want to use .

## Sending an email using your new account

- 1 Touch **New e-mail** and a new email will open.
- 2 Complete the message.
- 3 Touch **Send** and your email will be sent.

## Changing your email settings

- 1 Touch **E-mail** in the COMMUNICATION tab.
- 2 Touch  and select **E-mail settings** and then you can adapt the following settings:

**Allow reply Email** - Choose to allow the sending of 'read, confirmation' messages.

**Request reply Email** - Choose whether to request read confirmation messages.

**Retrieve interval** - Choose how often your GD510N checks for new email messages.

**Retrieve amount** - Choose the number of emails to be retrieved at any one time.

**Include message in Fwd & Reply** - Choose to include the original message in your reply.

# Messaging

**Include attachment** - Choose to include the original attachment in any reply.

**Auto Retrieval in Roaming** - Choose whether to retrieve your messages automatically when abroad (roaming).

**New email notification** - Choose whether to be alerted to new emails.

**Signature** - Create an email signature and switch this feature on.

**Priority** - Choose the priority level of your email messages.

**Mail sending size** - Set the maximum size of sending mail.

**Email counter** - Input the date you want. You can check emails you sent during that period.

## Message folders

**Inbox** - All the messages you receive are placed into your inbox.

**Drafts** - If you don't have time to finish writing a message, you can save what you've done so far here.

**Outbox** - This is a temporary storage folder while messages are being sent.

**Sent items** - All the messages you have sent are placed in this folder.

**My Folders** - Create folders to store your messages.

## Changing your text message settings

Touch **Messaging** in the **COMMUNICATION** tab. And touch **Settings**. Select **Text message**. You can make changes to:

**Text message centre** - Enter the details of your message centre.

**Delivery report** - Slide the switch left to receive confirmation that your messages have been delivered.

**Validity period** - Choose how long your messages are stored at the message centre.

**Message types** - Convert your text into **Text, Voice, Fax, X.400** or **Email**.

**Character encoding** - Choose how your characters are encoded. This impacts the size of your messages and therefore data charges.

**Send long text as** - Choose to send long messages as **Multiple SMS** or as **MMS**.

## Changing your multimedia message settings

Touch **Messaging** in the **COMMUNICATION** tab. Chose **Settings** and **Multimedia message**.

You can make changes to:

**Retrieval mode** - Choose **Home** or **Roaming network**. If you then choose **Manual** you will receive only notifications of MMS and you can then decide whether to download them in full.

**Delivery report** - Choose to allow and/or request a delivery report.

**Read reply** - Choose to allow and/or request a reply report.

**Priority** - Choose the priority level of your MMS.

**Validity period** - Choose how long your message is stored at the message centre.

**Slide duration** - Choose how long your slides appear on screen.

**Creation mode** - Choose your message mode.

**Delivery time** - Choose how long before a message is delivered.

**Multi msg centre** - Enter the details of your message centre.

## Changing your other settings

Touch **Messaging** in the **COMMUNICATION** tab. And touch **Settings**.

**Voicemail** - Touch  to add a new Voicemail service. Contact your network operator for more information on the service they provide.

**Service message** - Choose to receive or block service messages. You can also set your message security by creating trusted and untrusted lists of senders.

**Message counter** - Choose to set period for counting messages.

**Info service** - Choose your reception status, language and other settings.

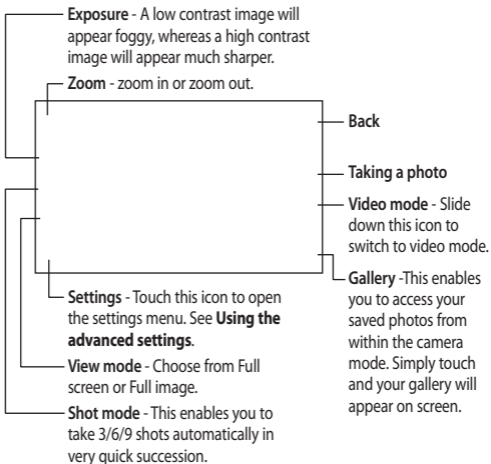

# Camera

## Getting to know the viewfinder



**TIP!** You can bring up the options by tapping the screen. They auto turn off after a few seconds.





## Taking a quick photo

- 1 Press the  key on the right side of the phone a few seconds.
- 2 The viewfinder will appear on screen.
- 3 When the camera has focused on your subject, either press the  on the side of the phone firmly or **touch** the  on the right-center of the screen to take a photo.

**TIP!** To switch to the camera mode or video mode, slide up / down the camera or video icon on the right-center of the view finder.

## After you've taken your photo

Your captured photo will appear on screen. The name of the image runs along the bottom of the screen.

-  Touch to send the photo as a message, e-mail or Bluetooth.
-  Touch to set a Home screen image.
-  Touch to edit the photo.
-  Touch to delete the photo you have just taken and confirm by touching **Yes**. The viewfinder will reappear.
-  Touch to move to your gallery.



# Camera

## Using the advanced settings

From the viewfinder touch  to open all the advanced settings options.

**Size** - Change the size of the photo to save on memory space or take a picture preset to the correct size for contact. Select a pixel value from the six numerical options (**3M: 2048x1536, 2M: 1600x1200, 1M: 1280x960, 640x480, 400x240(W), 320x240**).

**Colour Effect** - Choose a colour tone to apply to the photo you're taking. There are five colour tone options: **Off, Black & White, Negative** or **Sepia**.

**White balance** - Choose from Auto, Incandescent, Sunny, Fluorescent or Cloudy.

**Night mode** - Useful to use at dark place.

**Self-timer** - The self-timer allows you to set a delay after the capture button is pressed before the camera takes the picture. Choose from **3 seconds, 5 seconds** or **10 seconds**. Great for that group photo you want to be part of.

**Quality** - Choose between **Super fine, Fine** and **Normal**. The finer the quality the sharper a photo will be, but the file size will increase. This means you'll be able to store fewer photos in your memory.

**Memory** - Choose whether to save your photos to the Handset memory or to the External memory.

**Show captured image** - Choose simple view or edit view.

**Hide icons** - Choose the camera settings icons to be hidden manually or automatically.

**Shutter sound** - Select one of the three shutter sounds.

**Grid screen** - Choose from Off, Simple cross or Trisection

**Reset settings** - Reset all the camera settings.

# Video camera

## Getting to know the viewfinder

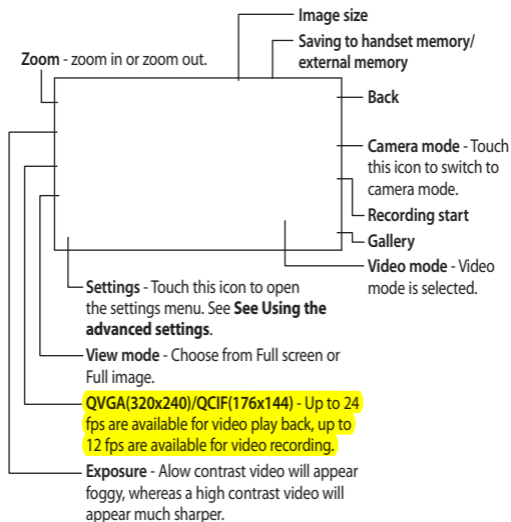







**TIP!** You can close all the shortcut options for a clearer viewfinder screen. Simply touch the centre of the viewfinder once. To recall the options touch the screen again.

# Video camera

## Shooting a quick video







- 1 Press the camera key on the right side of the phone.

**TIP!** To switch to the camera mode or video mode, slide up / down the camera or video icon on the right-center of the view finder

- 2 Holding the phone horizontally, point the lens towards the subject of the video.
- 3 Press the  once to start recording. Or press the red dot  at the center right of the screen.
- 4 **Rec** will appear at the bottom of the viewfinder with a timer at the bottom showing the length of the video.
- 5 To pause the video touch  and resume by selecting .
- 6 Touch  on screen or press the  a second time to stop recording.

## After you've shot your video

A still image representing your captured video will appear on screen. The name of the video runs along the bottom of the screen together with six icons down the right side .

-  Touch to play the video.
  -  Touch to send the video as a **Message or Email** or by **Bluetooth** or **YouTube**.
  -  Touch to edit the video.
  -  Touch to delete the video you have just captured and confirm by touching **Yes**. The viewfinder will reappear.
- Touch  to shoot another video straight away.
-  Touch to view a gallery of saved videos and images.



## Using the advanced settings

From the viewfinder touch **Settings** to open all the advanced settings options.

**Colour Effect** - Choose a colour tone to apply to the video you're taking. **Off, Black & White, Negative, Sepia.**

**White balance** - The white balance ensures that any white in your videos is realistic. In order for your camera to correctly adjust the white balance you may need to determine the light conditions. Choose from **Auto, Incandescent, Sunny, Fluorescent** or **Cloudy.**

**Quality** - Choose between **Super fine, Fine** and **Normal.** The finer the quality the sharper a video will be, but the file size will increase as a result, which means you'll be able to store fewer videos in the phone's memory.

**Set time** - Set a duration limit for your video. Choose from **2 hours** or **MMS** to limit the size so that you can send the video as an MMS.

**TIP!** If you choose MMS duration, try choosing a lower image quality to enable you to shoot a longer video.

**Memory** - Choose whether to save your videos to the **Handset memory** or to the **External memory.**



**Voice** - Choose Mute to record a video without sound.

**Hide icons** - Choose the camera settings icons to be hidden manually or automatically.

**Reset settings** - Reset all the video camera settings.





# Your photos and videos

## Viewing your photos and videos

- 1 Touch **Gallery** in ENTERTAINMENT tab. Or Touch  on your camera preview screen. You can check your pictures and videos.
- 2 Your gallery will appear on screen.
- 3 Touch the video or photo twice to open it fully.
- 4 To play the video touch . To pause playback touch .

**TIP!** Flick left or right to view other photos or videos.

## Capturing an image from a video

- 1 Select the video you would like to capture an image from.
- 2 Touch  to pause the video on the frame you'd like to convert to an image and touch the right side of the screen to open the  menu.
- 3 From the options menu select .
- 4 The image will appear on screen, with its assigned image name.
- 5 Touch the image then  to return to the gallery.

- 6 The image will be saved in your **My stuff** folder and appear in the gallery. You need to exit the gallery and then re-open it for this to appear.





 **WARNING:** Some functions will not work properly if the multimedia file has not been recorded on the phone.

## Viewing your photos as a slide show



Slideshow mode will show all the photos in your gallery one at a time as a slideshow. Videos can not be viewed as a slideshow.

- 1 Touch  in **Gallery** and select Slide show.
- 2 The slideshow will begin.



There are options within slideshows:

-  Touch to show random.
-  Touch to pause the slideshow on a particular photo.
-  Touch again to resume playback.
-  Touch to increase or decrease the speed of the slideshow.

## Setting a photo as wallpaper

- 1 Touch **Gallery** in **ENTERTAINMENT** tab.
- 2 Touch the photo you would like to set as wallpaper.
- 3 Touch the screen to open the menu.
- 4 Touch .
- 5 The screen will switch to portrait mode. You can then change the size of the picture with.
- 6 When you are happy with the picture touch **Set** .
- 7 Choose from options where you want to change.

## Editing your photos

- 1 Open the photo you'd like to edit and touch  to bring up the options.
- 2 Touch the icons to adapt your photo:
  -  Crop your photo and move your finger across the screen to select the area.
  -  Draw something on your photo freehand. Select the thickness of the line from the four options and the colour you would like to use.

 Put writing on the picture.

 Decorate your photo with stamps. Choose from the different stamps available and touch your photo wherever you'd like them to be.

 Erase whatever you draw.

 Touch to return to the gallery.

 Save the changes you have made to the photos. Select to save the changes over the **Original file**, or as a **New file**. If you select **New file** enter a file name.

 Undo the last **Effect** or edit you made to the photo.

 Touch to open further effect options.

 You can adjust the selected photo.

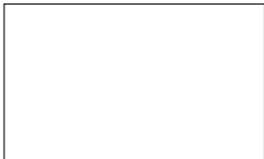

# Your photos and videos

## Adding an effect to a photo

- 1 From the editing screen, touch



- 2 Choose to apply any of the options to the photo:

**Face beautify** - Automatically detect a face in the image and brighten it up.

**Tunnel effect** - Lomo camera effect.

**Colour negative** - Colour negative effect.

**Black and white** - Black and white colour effect.

**Sepia** - Sepia effect.

**Blur** - Apply a blurred effect.

**Sharpen** - Move the marker along the bar to sharpen the focus of the photo. Select **OK** icon to apply the changes or choose  to cancel.

**Mosaic blur** - Touch to apply a blurred mosaic effect to the photo.

**Oil painting** - Oil painting effect.

**Sketch** - Apply an effect to make the picture look like a sketch.

**Emboss** - Emboss effect.

**Solarize** - Change the effect of exposure to the light.

**Vivid** - An effect of clearness and brilliance.

**Moonlight** - Change the light to look like moonlight.

**Antique** - An old image effect.

**Glow** - A light beam effect.

**Cartoon** - A cartoon effect.

**Water color** - A water color effect.

- 3 To undo an effect simply touch

**Undo** .

# Multimedia

You can store any multimedia files into your phone's memory so that you have easy access to all of your pictures, sounds, videos and games. You can also save your files to a memory card. The advantage of using a memory card is that you can free up space on your phone's memory.

## Pictures

**Images** contains a list of pictures including default images pre-loaded onto your phone, images downloaded by you and images taken on your phone's camera.

## Sending a photo

- 1 Touch **My stuff** in ENTERTAINMENT tab and select **Images**. Select the picture you want.
- 2 Touch **Send** and choose from **Multimedia message, Email, Bluetooth and Blogger**.

## Using an image

You can choose images to use as wallpapers and lock screen or even to identify a caller.

- 1 Touch **My stuff** in ENTERTAINMENT tab and select **Images**. Select the picture you want. And touch .

- 2 Touch **Use as** and choose from:

**Home screen image** - Set a wallpaper for the home screen.

**Lock screen image** - Set a wallpaper for the the lock screen.

**Contacts image** - Allocate an image to a particular person in your contacts list so that their picture shows when they call you.

**Start up image** - Set an image to appear when you switch the phone on.

**Shut down image** - Set an image to appear when you switch the phone off.

## Printing an image

- 1 Touch **My stuff** in ENTERTAINMENT tab and select **Images**. Select the picture you want. And touch .
- 2 Touch **Print** then choose between **Bluetooth and PictBridge**.

**TIP!** You can print via bluetooth or by connecting to a PictBridge compatible printer.

# Multimedia

## Moving or copying an image

You can move or copy an image between the phone memory and the memory card. You might want to do this to either free up some space in one of the memory banks or to safeguard your images from being lost.

- 1 Touch **My stuff** in ENTERTAINMENT tab and select Images and touch .
- 2 Select **Move** or **Copy**.
- 3 You can mark/unmark the images by tapping it sequentially. Mark the image that you want to move or copy and touch **Copy/Move**.

## Sounds

The **Sounds** contains a list of sounds including the downloaded sounds, default sounds and voice recordings.

From here you can manage, send or set sounds as ringtones.

## Using a sound

- 1 Touch **My stuff** in ENTERTAINMENT tab and select Sounds and touch .
- 2 Select a sound you want and it will begin to play.

- 3 Touch  and select **Use as**.
- 4 Choose from **Ringtone**, **Message tone**, **Start-up** or **Shut down**.

## Videos

The **Video** shows a list of downloaded videos and videos you have recorded on your phone.

## Watching a video

- 1 Touch **My stuff** in ENTERTAINMENT tab and select Videos.
- 2 Select a video to play.

## Sending a video clip

- 1 Select a video.
- 2 Touch **Send** and choose from **Multimedia message**, **Email**, **Bluetooth** and **YouTube**.

## Games & Apps

You can install new games and applications to your phone to keep you amused when you have time to spare.

You can also access to here using the menu **Games & Apps** in ENTERTAINMENT tab.

## Playing a game

- 1 Touch **Games & Apps** in ENTERTAINMENT tab.
- 2 Open the **Games** and choose and touch a game to launch.

## Documents

From the Documents menu, you can view all of your document files. From here you can view Excel, Powerpoint, Word, Text and PDF files.

## Transferring a file to your phone

Bluetooth is probably the easiest way to transfer a file from your computer to your phone. You can also use LG PC Suite via your sync cable.

### To transfer using Bluetooth:

- 1 Make sure your phone and computer have Bluetooth switched on and are visible to one another.
- 2 Use your computer to send the file via Bluetooth.
- 3 When the file is sent you will have to accept it on your phone by touching **Yes**.

- 4 The file should appear in **My folder** as a default, the second tab in **My stuff**. You may miss the file if the folder is full.





## Others

The **Others** contains a list of the files which are not pictures, sounds, videos, documents, games or applications.

## Muvee studio

You can create a music video.

## Creating a movie

- 1 Touch **Muvee studio** in COMMUNICATION tab.
- 2 Touch  to add an image. Checkbox images you want to include then select **Insert**.
- 3 Touch style tab to choose a Muvee style.
- 4 Touch **Default sound** to change the sound.
- 5 Touch  to see what you've created.
- 6 Touch  then **Order** to make an order.
- 7 Touch  then **Save Location** to choose where to save the movie.

# Multimedia

## Music

Your LG GD510N has a built-in music player so you can play all your favourite tracks. To access the music player, touch **Music** in COMMUNICATION tab. From here you can access a number of folders:

**Recently played** - View all of the songs you have played recently.

**All tracks** - Contains all of the songs you have on your phone.

**Artists** - Browse through your music collection by artist.

**Albums** - Browse through your music collection by album.

**Genres** - Browse through your music collection by genre.

**Playlists** - Contains all playlists you have created.

**Shuffle tracks** - Play your tracks in a random order.





## Transferring music onto your phone

The easiest way to transfer music onto your phone is via Bluetooth or your sync cable.

You can also use LG PC Suite, see page 56 for details. To transfer using Bluetooth:

- 1 Make sure both devices have Bluetooth switched on and are visible to one another.
- 2 Select the music file on the other device and choose to send it via Bluetooth.
- 3 When the file is ready to be sent you should accept it on your phone by touching **Yes**.
- 4 The file should appear in **Music > All tracks**.

## Playing a song

- 1 Touch **Music** in ENTERTAINMENT tab.
- 2 Select the song you want to play.
- 3 Touch  to pause the song.
- 4 Touch  to skip to the next song.
- 5 Touch  to skip to the previous song.
- 6 Touch  to return to the **Music** menu.

## Creating a playlist

You can create your own playlists by choosing a selection of songs from the **All tracks** folder.

- 1 Touch **Music** in ENTERTAINMENT tab.

- 2 Touch **Add new playlist**, enter the playlist name and touch **Save**.
- 3 The **All tracks** folder will show all the songs in your phone. Touch all of the songs that you would like to include in your playlist; a tick will show next to the track names.
- 4 Touch **Save**.

## FM Radio

Your LG GD510N has an FM radio feature so you can tune into your favourite stations to listen to on the move.





**NOTE:** You will need to insert your headphones in order to listen to the radio. Insert them into the headphone socket (this is the same socket that you plug your charger into).

## Searching for stations

You can tune radio stations into your phone by searching for them either manually or automatically. They will then be saved to specific channel numbers so you don't have to keep re-tuning. You must first attach the headset to the phone as this acts as the antenna.

### To auto tune:

- 1 Touch **FM radio** in ENTERTAINMENT tab, then .
- 2 Touch **Auto scan**. Then the stations will be automatically found and allocated to a channel in your phone.

**NOTE:** You can also manually tune into a station by using  and  displayed next to the radio frequency. If you press and hold  and , the stations will be automatically found.

## Resetting channels

- 1 Touch **FM radio** in ENTERTAINMENT tab, then .
- 2 Choose **Reset** to reset the current channel or choose **Reset all** to reset all of the channels. Each channel will return to the starting 87.5Mhz frequency.

# Organiser

## Adding an event to your calendar

- 1 Touch **Organiser** in UTILITIES tab.  
Select **Calendar**.
- 2 Select the date you would like to add an event to.
- 3 Touch  then **Add event**.
- 4 Touch **Category** then choose from **Appointment, Anniversary or Birthday**.  
Check the date and enter the time you would like your event to begin.
- 5 For **Appointments and Anniversaries** enter the time and date your event finishes in the lower two time and date boxes.  
**Enter the location in case of Appointments.**
- 6 Enter **Subject**.
- 7 Set **Alarm** and **Repeat**.
- 8 Select **Save** and your event will be saved in the calendar. A square cursor will mark the day that any events have been saved to and a bell will ring at the start time of your event, so that you can stay organised.

## Adding an item to your to do list

- 1 Touch **Organiser** in UTILITIES tab.
- 2 Select **To do** and touch **Add To do**.
- 3 Set the date for the to do item, add notes and select a priority level: **High, Medium or Low**.
- 4 Save your to do list item by selecting **Save**.

## Using date finder

Date finder is a handy tool to help you calculate what the date will be after a certain amount of days has passed. For example, 60 days from 10.10.07 will be 09.12.2007.

- 1 Touch **Organiser** in UTILITIES tab.
- 2 Select **Date finder**.
- 3 In the **From** tab set your required date.
- 4 In the **After** tab set the number of days.
- 5 The **Target date** will be shown below.

## Adding a memo

- 1 Touch **Memo** in UTILITIES tab.
- 2 Touch **Add memo**.
- 3 Type your memo, followed by **Save**.

- 4 Your memo will appear on screen next time you open the **Memo** application.

## Setting your alarm

- 1 Touch **Alarm** in UTILITIES tab.
- 2 Touch **Add alarm**.
- 3 Set the time you would like the alarm to sound and touch **Save**.
- 4 Choose whether you would like your **alarm** to repeat **Once, Daily, Mon - Fri, Mon - Sat, Sat - Sun, Except holiday or Choose weekday**.  
The icons indicate the weekday you select.
- 5 Select **Alarm type** to select a type for your alarm.
- 6 Chooses Sound from folder. To listen to sounds touch the sound, followed by .
- 7 Add a memo for the alarm. Touch **Save** when you have finished typing the memo.
- 8 Finally you can set the snooze interval at 5, 10, 20, 30 minutes, 1 hour or off.
- 9 Once you have set your alarm, touch **Save**.

**NOTE:** You can set up to 5 alarms.

**TIP!** Touch on/off icon on the right hand side of the alarm to set.

## Adding a memo with drawing panel

- 1 Touch **Drawing panel** in UTILITIES tab .
- 2 Touch **Add Drawing**.
- 3 Draw your memo on the touch screen LCD followed by .
- 4 Your memo will appear on screen next time you open the **Drawing Panel** application.

## Voice recorder

Use your voice recorder to record voice memos or other sounds.

Touch **Voice recorder** in UTILITIES tab. And select  to change Settings:



**Duration** – Set the recording duration. Choose from **No limit, MMS message size or 1 minute**.

**Quality** – Select the sound quality. Choose from Super Fine, Fine or Normal.

**Memory in use** – Get information of free space of memory.

# Organiser

## Recording a sound or voice

- 1 Touch  to begin recording.
- 2 Touch  to end recording.
- 3 Touch  to listen to your recording.

## Using your calculator

- 1 Touch **Tools** in UTILITIES tab.
- 2 Select **Calculator**.
- 3 Touch the numeric keys to input numbers.
- 4 For simple calculations, touch the function you require (+, -, \*, /), followed by =.
- 5 For more complex calculations, touch  and choose from **sin**, **cos**, **tan**, **log**, **ln**, **exp**, **sqrt**, **deg** or **rad** etc.

## Converting a unit

- 1 Touch **Tools** in UTILITIES tab.
- 2 Select **Unit converter**.
- 3 Choose whether you would like to convert **Currency**, **Surface**, **Weight**, **Length**, **Temperature**, **Volume** or **Velocity**.
- 4 You can then select the unit, and enter the value you would like to convert from, followed by the unit



you would like to convert to.

- 5 The corresponding value will appear on the screen.

## Using the stopwatch

- 1 Touch **Tools** in UTILITIES tab.
- 2 Select **Stopwatch**.
- 3 Touch **Start** to begin the timer.
- 4 Touch **Lap** if you want to record a lap time.
- 5 Touch **Stop** to end the timer.
- 6 Touch **Resume** to restart the stopwatch at the time you stopped it at, or touch **Reset** to begin the time again.

## Adding a city to your World clock

- 1 Touch **Tools** in UTILITIES tab.
- 2 Select **World clock**.
- 3 Touch the , followed by **Add city**.
- 3 Choose the city on the map or touch the  and type the name of the city you require.

# PC Sync

You can synchronise your PC with your phone to make sure all your important details and dates match, and also to backup your files to put your mind at ease.

## Installing LG PC Suite on your computer

- 1 From the Home screen press  and select **Connectivity** on the **SETTINGS** tab.
- 2 Select **USB connection mode** and touch **PC Suite**.
- 3 Connect handset and PC via USB cable and wait for a while. Installation guide message will be displayed.
- 4 Follow the instructions on the screen to complete the LG PC Suite Installer wizard.
- 5 Once installation is complete, the LG PC Suite icon will appear on your desktop.

## Connecting your phone and PC

- 1 From the Home screen press  and select **Connectivity** on the **SETTINGS** tab.
- 2 Select **USB connection mode**.
- 3 Touch **PC Suite**.

- 4 Connect handset and PC via USB cable and wait for a while. PC Suite executed automatically for your use.

## Backing up and restoring your phone's information

- 1 Connect your phone to your PC as outlined above.
- 2 Click on the **Backup** icon, and select **Backup** or **Restore**.
- 3 Mark the contents you would like to back up or restore. Select the location you would like to backup information to, or restore information from. Click **OK**.
- 4 Your information will be backed up or restored.

## Viewing your phone files on your PC

- 1 Connect your phone to your PC as outlined previously.
- 2 Click on the **Manage Files** icon.
- 3 All of the documents, flash contents, images, sounds and videos you have saved onto your phone will be displayed on the screen in the LG Phone folder.

# PC Sync

**TIP!** Viewing the contents of your phone on your PC helps you to arrange files, organise documents and remove contents you no longer need.

## Synchronising your contacts

- 1 Connect your phone to your PC.
- 2 Click on the **Manage Contacts** icon.
- 3 Your PC will now import and display all contacts saved to your USIM card and handset.
- 4 Click on **File** and select **Save**. You can now select where you would like to save your contacts to.

**NOTE:** To backup contacts saved to your USIM card, click on the SIM card folder on the left side of your PC screen.

Right-click your contacts and then Select all.

Right-click at the same position and select Copy to Phone memory. Now click on the Handset folder on the left of your screen and all your numbers will be displayed.

## Synchronising your messages

- 1 Connect your phone to your PC.
- 2 Click on the **Messages** icon.
- 3 All of your phone messages will be displayed in folders on your screen.
- 4 Use the tool bar at the top of your screen to edit and rearrange messages.

## Using your phone as Music Sync device

Your Phone can be used as Music Sync device to Sync Music Files only.

Music Sync can be done using Windows Media Player 10 / 11 and supports both Handset Memory and External Memory Card.

- 1 Disconnect your phone from your PC.
- 2 From the Home screen select  , then select **Connectivity** on the SETTINGS tab.
- 3 Select **USB connection mode**.
- 4 Touch **Music sync**.
- 5 Connect your phone to your PC. Your phone will read: **Connecting as Music Sync ...** followed by **Disconnect Cable to Stop Music Sync**.

# The web

## Accessing the web

- 1 Touch **Browser** in UTILITIES tab.
- 2 To access the browser homepage directly, select **Home**. Alternately select **Enter address** and type in your desired URL, followed by **Connect**.

**NOTE:** An additional cost is incurred when connecting to this service and downloading content. Check your data charges with your network provider.

## Adding and accessing your bookmarks

For easy and fast access to your favourite websites, you can add bookmarks and save web pages.

- 1 Touch **Browser** in UTILITIES tab.
- 2 Select **Bookmarks**. A list of your Bookmarks will appear on the screen.
- 3 To add a new bookmark, touch **Add Bookmark**. Enter a name for your bookmark followed by the URL.
- 4 Touch **Save**. Your Bookmark will now appear in the list of bookmarks.

- 5 To access the bookmark simply touch the bookmark and then touch **Connect**. You will be connected to your bookmark.

## Using RSS reader

RSS (Really Simple Syndication) is a family of web feed formats used to publish frequently updated content such as blog entries, news headlines or podcasts. An RSS document, which is called a feed, web feed, or channel, contains either a summary of content from an associated web site or the full text. RSS makes it possible for people to keep up with their favourite web sites in an automated manner that is easier than checking them manually. The user subscribes to a feed by entering the feed's link into the reader or by clicking an RSS icon in a browser that initiates the subscription process. The reader checks the user's subscribed feeds regularly for new content, downloading any updates that it finds.

# The web

## Saving a page

- 1 Access your required webpage as described above.
- 2 Touch  and select **Save this page**.
- 3 Enter a name for the webpage so you can easily recognise it.
- 4 Touch **Save**.

## Accessing a saved page

Touch **Browser** in UTILITIES tab. And select **Saved pages**.

## Viewing your browser history

Touch **Browser** in UTILITIES tab. And select **History**.

## Changing the web browser settings

Touch **Browser** in UTILITIES tab. And select **Settings**.

You can choose to edit **Profiles**, **Appearance settings**, **Cache**, **Cookies**, **Security**, or to reset all settings, select **Reset Settings**.

## Using your phone as a modem

Your GD510N can double as a modem for your PC, giving you email and internet access even when you can't connect using wires. You can use either the USB cable or Bluetooth.

### Using the USB cable:

- 1 Ensure you have the LG PC Suite installed on your PC.
- 2 Connect your GD510N and your PC using the USB cable and launch the LG PC Suite software.
- 3 Click **Internet Kit** on your PC. Then click **New** button and select **Modem**.
- 4 Choose **LG Mobile USB Modem** and select **OK**. It will now appear on screen.
- 5 Write the Profile that can connect to the Internet and save the values.
- 6 The profile that you create will appear on your PC screen. Select it and click **Connect**.  
Your PC will connect through your GD510N.  
**NOTE:** For more information on synchronising using the LG PC Suite see page 56.

## Using Bluetooth:

- 1 Ensure Bluetooth is switched **On** and **Visible** for both your PC and GD510N.
- 2 Pair your PC and GD510N so that a passcode is required for connection.
- 3 Use the **Connection wizard** on your LG PC Suite to create an active Bluetooth connection.
- 4 Click **Internet Kit** on your PC. Then click **New** button.
- 5 Choose **LG Mobile USB Modem** and select **OK**. It will now appear on screen.
- 6 Write the Profile that can connect to the Internet and save the values.
- 7 The profile that you create will appear on your PC screen. Select it and click **Connect**.  
Your PC will connect through your GD510N.

# Settings

## Personalising your profiles

You can quickly change your profile on the Home screen.

Using the settings menu you can personalise each profile setting.

- 1 Touch **Profiles** in **SETTINGS** tab.
- 2 Choose the profile you want to edit.
- 3 You can then change all of the sounds and alert options available in the list, including your **Voice Ring tone** and **Volume, Message alerts** settings and more.

## Changing your screen settings

Touch **Screen settings** in **SETTINGS** tab.

### Screen settings

**Wallpaper** - Choose the theme **for your home screen or lock screen.**

**Livesquare** - Touch **Livesquare guide** to check the its functions.

**Top Menu** - Choose the style of the top menu.

**Dialling** - Adjust the number size and colour.

**Font** - Adjust the font size.

**Backlight** - Choose how long the backlight remains ON.

**NOTE:** The longer the backlight is on for, the more battery power is used and you may need to charge your phone more often.

**Brightness** - Adjust the screen brightness.

**Greeting message** - Choose on or off and fill in the greeting message.

**Start-up/Shut down** - Choose the theme for your start-up/shut down screen.

- 2 Touch **Save** to save your settings.

## Changing your phone settings

Enjoy the freedom of adapting how your GD510N works to your own style.

Touch **Phone settings** in **SETTINGS** tab, then choose from the list below.

### Phone settings

**Date & time** - Adjust your date and time settings or choose to auto update the time when you travel or for daylight saving.

**Power save** - Choose to switch the factory set power saving settings **On** or **Off**.

**Languages** - Change the language of your GD510N's display.

**Motion silent** - Make GD510N go into the mute or snooze by turning it over when it is ringing.

**Auto Keylock** - Lock the keypad automatically in Home screen.

**Security** - Adjust your security settings, including PIN codes and handset lock.

**Memory manager** - See **Using memory manager** for more information.

**Reset settings** - Reset all the settings to their factory definitions.

**information** - View the technical information for your GD510N.

## Changing your connectivity settings

Your connectivity settings have already been set up by your network operator, so you can enjoy your new phone from the off. If you want to change any settings, use this menu.

Touch **Connectivity** in SETTINGS tab.

### Network settings

**Select Network** - If you set to **Automatic**, GD510N automatically searches for the network and registers the handset to the network. This is recommended for

best service and quality.

If you set to **Manual** all the currently available networks are shown and you can select one of them for registration.

**Preferred lists** - If the network is searching automatically, you can add a preferred network to be connected to.

**Internet profiles** - This menu shows the Internet profiles. you cannot delete or edit default configurations depending on country variant.

**Access points** - Your network operator has already saved this information. You can add new access points using this menu.

**Packet data conn.** - Choose when your device should be connected to network for packet data.

**USB connection mode** - Choose Data service and synchronise your GD510N using the LG PC Suite software to copy files from your phone. See PC sync for more information on synchronisation.

If you use Music sync with Windows Media Player, select Music sync in this menu. Music sync is only available for music content.

# Settings

## Using memory manager

Your GD510N has three memories available: the phone, the SIM Card and an external memory card.

You can use memory manager to determine how each memory is used and see how much space is available.

Touch **Phone settings** in **SETTINGS** tab. then **Memory Manager**.

**Handset common memory** - View the memory available on your GD510N for Pictures, Sounds, Video, Flash, MMS, Email, Java applications and others.

**Handset reserved memory** - View the memory available on your handset for SMS, Contacts, Calendar, To do list, Memo, Alarm, Call history, Bookmarks and Miscellaneous items.

**SIM memory** - View the memory available on your SIM Card.

**External memory** - View the memory available on your external memory card (you may need to purchase the memory card separately).

**Primary storage settings** - Choose the location you prefer items to be saved to.

## Sending and receiving your files using Bluetooth

### To send a file:

- 1 Open the file you want to send, typically this will be a photo, video or music file.
- 2 Choose **Send**.  
Choose **Bluetooth**.
- 3 If you have already paired the **Bluetooth** device, your GD510N will not automatically search for other **Bluetooth** devices. If not, your GD510N will search for other **Bluetooth** enabled devices within range.
- 4 Choose the device you want to send the file to and touch **Select**.
- 5 Your file will be sent.

**TIP!** Keep an eye on the progress bar to make sure your file is sent.

### To receive a file:

- 1 To receive files your Bluetooth must be both **On** and **Visible**. See Changing your **Bluetooth** settings on the right for more information.
- 2 A message will prompt you to accept the file from the sender. Touch **Yes** to receive the file.

- 3 You will see where the file has been saved and you can choose to **View** the file or **Use as wallpaper**. Files will usually be saved to the appropriate folder in your My stuff.

## Changing your bluebooth settings:

Touch **Bluetooth** in SETTINGS tab. And select  and choose **Settings**.

Make your changes to:

**My device visibility** - Choose to be **Visible** or **Hidden** or **Visible for 1 min**.

**My device name** - Enter a name for your GD510N.

**Supported services** - Choose how to use Bluetooth in association with different services.

**Remote SIM Mode** - Turn on or off.

**My address** - Show your Bluetooth address.

## Pairing with another Bluetooth device

By pairing your GD510N and another device, you can set up a passcode protected connection.

- 1 Check your Bluetooth is **On** and

**Visible**. You can change your visibility in the **Settings** menu.

- 2 Touch **Search**.
- 3 Your GD510N will search for devices. When the search is completed **Refresh** will appear on screen.
- 4 Choose the device you want to pair with and enter the passcode, then touch **OK**.
- 5 Your phone will then connect to the other device, on which you should enter the same passcode.
- 6 Your passcode protected Bluetooth connection is now ready.

## Using a Bluetooth headset

- 1 Check your Bluetooth is **On** and **Visible**.
- 2 Follow the instructions that came with your headset to place your headset in pairing mode and pair your devices.
- 3 Touch **Ask before connect** or **Always connect** and touch **Yes** to Connect now. Your GD510N will automatically switch to Headset profile.