



On your side

HCT

TEST REPORT

FCC/ISED RFID Test for EAX70191101
Certification

APPLICANT
LG Electronics Inc.

REPORT NO.
HCT-RF-2307-FI001

DATE OF ISSUE
July 17, 2023

Tested by
Kyung Jun Woo



Technical Manager
Jong Seok Lee

Accredited by KOLAS, Republic of KOREA

HCT CO., LTD.
BongJai Huh
BongJai Huh / CEO



HCT Co., Ltd.

74, Seoicheon-ro 578beon-gil, Majang-myeon, Icheon-si, Gyeonggi-do, 17383 KOREA
Tel. +82 31 634 6300 Fax. +82 31 645 6401

TEST REPORT

FCC/ISED RFID Test
for EAX70191101

REPORT NO.
HCT-RF-2307-FI001

DATE OF ISSUE
July 17, 2023

Additional model
-

Applicant **LG Electronics Inc.**
222, LG-ro, Jinwi-myeon, Pyeongtaek-si, Gyeonggi-do 17709, Republic of Korea

Eut Type	NFC Reader for EVC
Model Name	EAX70191101
FCC ID	BEJEAX70191101
IC	2703H-EAX70191101
RF Output Field Strength	29.66 dB μ V/m @30 m
Frequency of Operation	13.56 MHz
Modulation type	ASK
FCC Classification	Low Power Communication Device Transmitter (DXX)
FCC Rule Part(s)	FCC Part 15.225 Subpart C
ISED Rule Part(s)	RSS-210 Issue 10 (December 2019), RSS-Gen Issue 5_Amendment 1 (March 2019)

The result shown in this test report refer only to the sample(s) tested unless otherwise stated.
This test results were applied only to the test methods required by the standard.

REVISION HISTORY

The revision history for this test report is shown in table.

Revision No.	Date of Issue	Description
0	July 17, 2023	Initial Release

Engineering Statement:

The measurements shown in this report were made in accordance with the procedures indicated, and the emissions from this equipment were found to be within the limits applicable. I assume full responsibility for the accuracy and completeness of these measurements, and for the qualifications of all persons taking them. It is further stated that upon the basis of the measurements made, the equipment tested is capable of operation in accordance with the requirements of the FCC Rules under normal use and maintenance. measurements, and for the qualifications of all persons taking them. It is further stated that upon the basis of the measurements made, the equipment tested is capable of operation in accordance with the requirements of the FCC Rules under normal use and maintenance.

KOLAS Statement:

The above Test Report is the accredited test result by (KS Q) ISO/IEC 17025 and KOLAS(Korea Laboratory Accreditation Scheme), which signed the ILAC-MRA. (KOLAS Accreditation No. KT197)

If this report is required to confirmation of authenticity, please contact to www.hct.co.kr

CONTENTS

1. EUT DESCRIPTION	5
2. TEST METHODOLOGY	6
EUT CONFIGURATION	6
EUT EXERCISE	6
GENERAL TEST PROCEDURES	6
DESCRIPTION OF TEST MODES	7
3. INSTRUMENT CALIBRATION	7
4. FACILITIES AND ACCREDITATIONS	7
FACILITIES	7
EQUIPMENT	7
5. ANTENNA REQUIREMENTS	8
6. MEASUREMENT UNCERTAINTY	9
7. DESCRIPTION OF TESTS	10
8. TEST SUMMARY	24
9. TEST RESULT	26
9.1. Operation within the band 13.110 MHz - 14.010 MHz	26
9.2. Radiated Emission 9 kHz - 30 MHz	28
9.3. Radiated Emission 30 MHz - 1000 MHz	31
9.4. 20 dB Bandwidth	32
9.5. Frequency Stability	33
9.6. POWERLINE CONDUCTED EMISSIONS	37
10. LIST OF TEST EQUIPMENT	39
11. ANNEX A_ TEST SETUP PHOTO	41

1. EUT DESCRIPTION

Model	EAX70191101
Additional model	-
EUT Type	NFC Reader for EVC
Power Supply	3.30 V
Frequency Range	13.56 MHz
Transmit Power	29.66 dB μ V/m @30 m
Modulation Type	ASK
Date(s) of Tests	June 27, 2023 ~ July 12, 2023
PMN (Product Marketing Number)	NFC Reader for EVC
HVIN (Hardware Version Identification Number)	EAX70191101
FVIN (Firmware Version Identification Number)	R2.4
HMN (Host Marketing Name)	N/A
EUT serial numbers	Radiated: EM23060018 V1.0

2. TEST METHODOLOGY

The measurement procedure described in the American National Standard of Procedures for Compliance Testing of Unlicensed Wireless Devices (ANSI C63.10-2013) is used in the measurement of the test device.

EUT CONFIGURATION

The EUT configuration for testing is installed on RF field strength measurement to meet the Commissions requirement and operating in a manner that intends to maximize its emission characteristics in a continuous normal application.

EUT EXERCISE

The EUT was operated in the engineering mode to fix the Tx frequency that was for the purpose of the measurements. According to its specifications, the EUT must comply with the requirements of the Section 15.207, 15.209 and 15.225 under the FCC Rules Part 15 Subpart C. / RSS-210 Issue 10 (December 2019)

GENERAL TEST PROCEDURES

Conducted Emissions

The EUT is placed on the turntable, which is 0.8 m above ground plane. According to the requirements in Section 6.2 of ANSI C63.10. (Version :2013) Conducted emissions from the EUT measured in the frequency range between 0.15 MHz and 30 MHz using CISPR Quasi-peak and average detector modes.

Radiated Emissions

The EUT is placed on a turn table, which is 0.8 m above ground plane. The turntable shall rotate 360 degrees to determine the position of maximum emission level. EUT is set 3 m away from the receiving antenna, which varied from 1 m to 4 m to find out the highest emission. And also, each emission was to be maximized by changing the polarization of receiving antenna both horizontal and vertical. In order to find out the max. emission, the relative positions of this hand-held transmitter (EUT) was rotated through three orthogonal axes according to the requirements in Section 6.6.5 of ANSI C63.10. (Version: 2013).

DESCRIPTION OF TEST MODES

The EUT has been tested under operating condition. Test program used to control the EUT for staying in continuous transmitting and receiving mode is programmed.

3. INSTRUMENT CALIBRATION

The measuring equipment, which was utilized in performing the tests documented herein, has been calibrated in accordance with the manufacturer's recommendations for utilizing calibration equipment, which is traceable to recognized national standards.

Especially, all antenna for measurement is calibrated in accordance with the requirements of C63.5 (Version : 2017).

4. FACILITIES AND ACCREDITATIONS

FACILITIES

The SAC(Semi-Anechoic Chamber) and conducted measurement facility used to collect the radiated data are located at the 74, Seoicheon-ro 578beon-gil, Majang-myeon, Icheon-si, Gyeonggi-do, 17383, Rep. of KOREA. The site is constructed in conformance with the requirements of ANSI C63.4. (Version :2014) and CISPR Publication 22.

Detailed description of test facility was submitted to the Commission and accepted dated April 02, 2018 (Registration Number: KR0032).

EQUIPMENT

Radiated emissions are measured with one or more of the following types of Linearly polarized antennas: tuned dipole, bi-conical, log periodic, bi-log, and/or ridged waveguide, horn. Spectrum analyzers with pre-selectors and quasi-peak detectors are used to perform radiated measurements.

Conducted emissions are measured with Line Impedance Stabilization Networks and EMI Test Receivers. Calibrated wideband preamplifiers, coaxial cables, and coaxial attenuators are also used for making measurements.

All receiving equipment conforms to CISPR Publication 16-1, "Radio Interference Measuring Apparatus and Measurement Methods."

5. ANTENNA REQUIREMENTS

According to FCC 47 CFR § 15.203:

“An intentional radiator antenna shall be designed to ensure that no antenna other than that furnished by the responsible party can be used with the device. The use of a permanently attached antenna or of an antenna that uses a unique coupling to the intentional radiator shall be considered sufficient to comply with the provisions of this section.”

- (1) The antennas of this E.U.T are permanently attached.
- (2) The E.U.T Complies with the requirement of § 15.203

According to RSS-Gen(Issue 5) Section 6.8:

The applicant for equipment certification shall provide a list of all antenna types that may be used with the transmitter, where applicable (i.e. for transmitters with detachable antenna), indicating the maximum permissible antenna gain (in dBi) and the required impedance for each antenna. The test report shall demonstrate the compliance of the transmitter with the limit for maximum equivalent isotropically radiated power (e.i.r.p.) specified in the applicable RSS, when the transmitter is equipped with any antenna type, selected from this list.

For expediting the testing, measurements may be performed using only the antenna with highest gain of each combination of transmitter and antenna type, with the transmitter output power set at the maximum level. However, the transmitter shall comply with the applicable requirements under all operational conditions and when in combination with any type of antenna from the list provided in the test report (and in the notice to be included in the user manual, provided below).

When measurements at the antenna port are used to determine the RF output power, the effective gain of the device's antenna shall be stated, based on a measurement or on data from the antenna's manufacturer.

The test report shall state the RF power, output power setting and spurious emission measurements with each antenna type that is used with the transmitter being tested.

6. MEASUREMENT UNCERTAINTY

The measurement uncertainties shown below were calculated in accordance with the requirements of ANSI C63.10-2013.

All measurement uncertainty values are shown with a coverage factor of $k=2$ to indicate a 95 % level of confidence.

The measurement data shown herein meets or exceeds the U_{CISPR} measurement uncertainty values specified in CISPR 16-4-2 and, thus, can be compared directly to specified limits to determine compliance.

Parameter	Expanded Uncertainty (dB)
Conducted Disturbance (150 kHz ~ 30 MHz)	1.90 (Confidence level about 95 %, $k=2$)
Radiated Disturbance (9 kHz ~ 30 MHz)	4.14 (Confidence level about 95 %, $k=2$)
Radiated Disturbance (30 MHz ~ 1 GHz)	5.82 (Confidence level about 95 %, $k=2$)
Radiated Disturbance (1 GHz ~ 18 GHz)	5.74 (Confidence level about 95 %, $k=2$)
Radiated Disturbance (18 GHz ~ 40 GHz)	5.76 (Confidence level about 95 %, $k=2$)
Radiated Disturbance (Above 40 GHz)	5.52 (Confidence level about 95 %, $k=2$)

7. DESCRIPTION OF TESTS

7.1. Radiated Test

Limit (Operation within the band 13.110 MHz – 14.010 MHz)

Frequency (MHz)	Field Strength ($\mu\text{V}/\text{m}$)	Measurement Distance (m)
13.553 – 13.567	15,848	30
$13.410 \leq f \leq 13.553$ $13.567 \leq f \leq 13.710$	334	30
$13.110 \leq f \leq 13.410$ $13.710 \leq f \leq 14.010$	106	30

Note:

1. $15,848 \mu\text{V}/\text{m} = 84.0 \text{ dB}\mu\text{V}/\text{m}$
2. $334 \mu\text{V}/\text{m} = 50.47 \text{ dB}\mu\text{V}/\text{m}$
3. $106\mu\text{V}/\text{m} = 40.51\text{dB}\mu\text{V}/\text{m}$

Only FCC Limit

Frequency (MHz)	Field Strength ($\mu\text{V}/\text{m}$)	Measurement Distance (m)
0.009 – 0.490	$2400/F(\text{kHz})$	300
0.490 – 1.705	$24000/F(\text{kHz})$	30
1.705 – 30	30	30

Only ISED Limit

Frequency (MHz)	Magnetic Field Strength ($\mu\text{A}/\text{m}$)	Measurement Distance (m)
0.009 – 0.490	$6.37/F(\text{kHz})$	300
0.490 – 1.705	$63.7/F(\text{kHz})$	30
1.705 – 30	0.08	30

FCC&ISED Limit

Frequency (MHz)	Field Strength ($\mu\text{V}/\text{m}$)	Measurement Distance (m)
30-88	*100	3
88-216	*150	3
216-960	*200	3
Above 960	500	3

※:

Except as provided in 15.209(g), fundamental emissions from intentional radiators operating under this Section shall not be located in the frequency bands 54-72MHz, 76-88 MHz, 174-216 MHz or 470-806 MHz. However, operation within these frequency bands is permitted under other sections of this Part, e.g. 15.231 and 15.241.

Test Configuration

Below 30 MHz

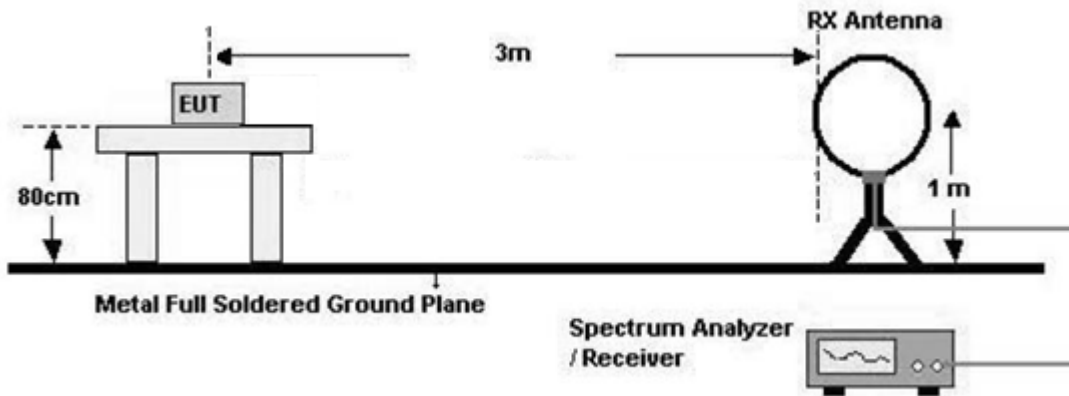

30 MHz - 1 GHz

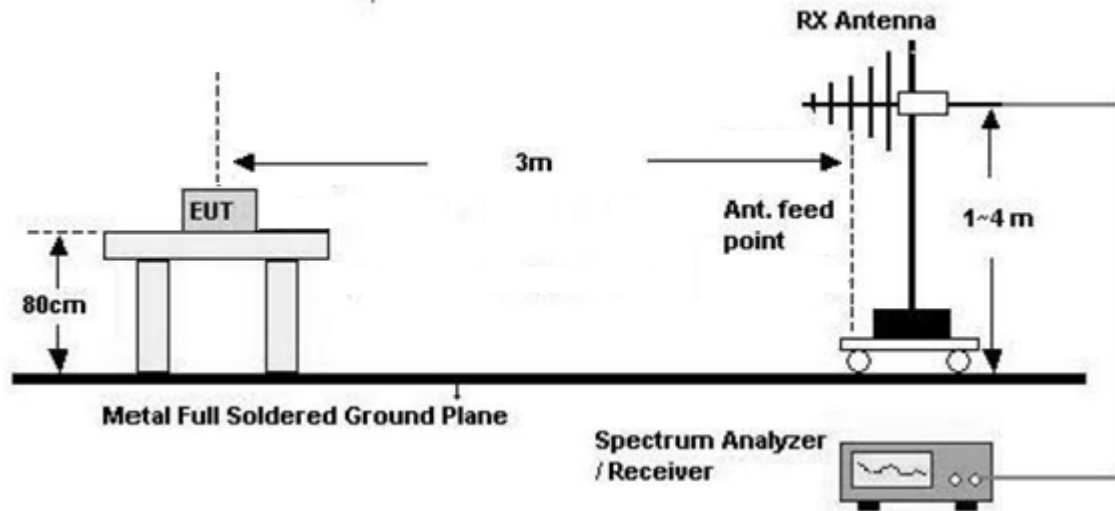

Test Procedure of in-band

1. The EUT was placed on a non-conductive table located on semi-anechoic chamber.
2. The loop antenna was placed at a location 3 m from the EUT
3. The EUT is placed on a turntable, which is 0.8m above ground plane.
4. We have done x, y, z planes in EUT and horizontal and vertical polarization and Parallel to the ground plane in detecting antenna.
5. The turntable shall be rotated for 360 degrees to determine the position of maximum emission level.
6. Distance Correction Factor = $40\log(3\text{ m}/30\text{ m}) = -40\text{ dB}$
Measurement Distance : 3 m (Below 30 MHz)

7. Spectrum Setting

- 1) Frequency Range = 9 kHz ~ 150 kHz
 - Detector = Peak
 - Trace = Maxhold
 - RBW = 300 Hz
 - VBW $\geq 3 \times$ RBW
- 2) Frequency Range = 150 kHz ~ 30 MHz
 - Detector = Peak
 - Trace = Maxhold
 - RBW = 10 kHz
 - VBW $\geq 3 \times$ RBW

8. Total = Measured Value + Antenna Factor(A.F) + Cable Loss(C.L) + Distance Factor(D.F)

Test Procedure of Radiated spurious emissions(Below30 MHz)

1. The EUT was placed on a non-conductive table located on semi-anechoic chamber.
2. The loop antenna was placed at a location 3 m from the EUT
3. The EUT is placed on a turntable, which is 0.8m above ground plane.
4. We have done x, y, z planes in EUT and horizontal and vertical polarization and Parallel to the ground plane in detecting antenna.
5. The turntable shall be rotated for 360 degrees to determine the position of maximum emission level.
6. Distance Correction Factor(0.009 MHz – 0.490 MHz) = $40\log(3\text{ m}/300\text{ m}) = -80\text{ dB}$
Measurement Distance : 3 m
7. Distance Correction Factor(0.490 MHz – 30 MHz) = $40\log(3\text{ m}/30\text{ m}) = -40\text{ dB}$
Measurement Distance : 3 m
8. Spectrum Setting
 - 1) Frequency Range = 9 kHz ~ 150 kHz
 - Detector = Peak
 - Trace = Maxhold
 - RBW = 300 Hz
 - VBW $\geq 3 \times$ RBW
 - 2) Frequency Range = 150 kHz ~ 30 MHz
 - Detector = Peak
 - Trace = Maxhold
 - RBW = 10 kHz
 - VBW $\geq 3 \times$ RBW
9. Total = Measured Value + Antenna Factor(A.F) + Cable Loss(C.L) + Distance Factor(D.F)
10. Measurement value only up to 6 maximum emissions noted, or would be lesser if no specific emissions from the EUT are recorded (ie: margin > 20 dB from the applicable limit) and considered that's already beyond the background noise floor.

KDB 414788 OFS and Chamber Correlation Justification

Base on FCC 15.31 (f) (2): measurements may be performed at a distance closer than that specified in the regulations; however, an attempt should be made to avoid making measurements in the near field. OFS and chamber correlation testing had been performed and chamber measured test result is the worst case test result.

Test Procedure of Radiated spurious emissions(Above30 MHz)

1. The EUT was placed on a non-conductive table located on semi-anechoic chamber.
2. The EUT is placed on a turntable, which is 0.8m above ground plane.
3. The Hybrid antenna was placed at a location 3 m from the EUT, which is varied from 1m to 4m to find out the highest emissions.
4. We have done x, y, z planes in EUT and horizontal and vertical polarization in detecting antenna.
5. The turntable shall be rotated for 360 degrees to determine the position of maximum emission level.
6. Spectrum Setting
 - Frequency Range = 30 MHz ~ 1 GHz
 - Detector = Peak
 - Trace = Maxhold
 - RBW = 100 kHz
 - VBW \geq 3 x RBW
- 7.Total = = Measured Value
 - We apply to the offset in the range 30 MHz - 1 GHz.
 - The offset is Antenna Factor(A.F) + Cable Loss(C.L) – Amp Gain(A.G)
8. Measurement value only up to 6 maximum emissions noted, or would be lesser if no specific emissions from the EUT are recorded (ie: margin > 20 dB from the applicable limit) and considered that's already beyond the background noise floor.
 - = Measured Value
 - We apply to the offset in the range 30 MHz - 1 GHz.
 - The offset is Antenna Factor(A.F) + Cable Loss(C.L) – Amp Gain(A.G)

7.2. 20 dB Bandwidth

Test Configuration

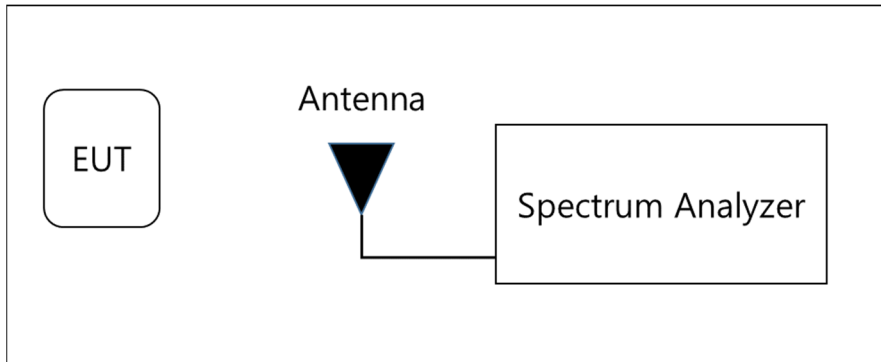

Test Procedure

The 20 dB bandwidth was measured by using a spectrum analyzer.

(Procedure 6.9.2 in ANSI 63.10-2013)

- 1) RBW = 1 %~5 % of the OBW
- 2) VBW = approximately three times RBW
- 3) Span = between two times and five times the OBW
- 4) Detector = Peak
- 5) Trace mode = Max hold
- 6) Allow the trace to stabilize

Note :

We tested Occupied Bandwidth using the automatic bandwidth measurement capability of a spectrum analyzer.

7.3. Frequency Stability

Limit

The frequency tolerance of the carrier signal shall be maintained within $\pm 0.01\%$ of the operating frequency.

Test Configuration

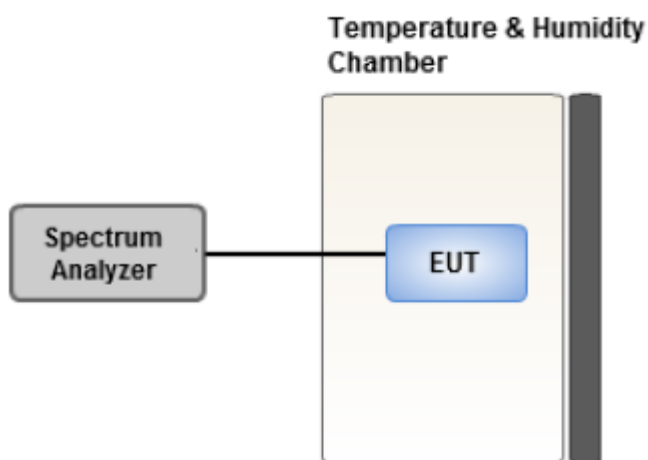

Test Procedure.

For battery operated equipment, the equipment tests shall be performed using a new battery.

- 1) Turn the EUT OFF and place it inside the environmental temperature chamber.
For devices that have oscillator heaters, energize only the heater circuit.
- 2) Set the temperature control on the chamber to the highest specified in the regulatory requirements
for the type of device and allow the oscillator heater and the chamber temperature to stabilize.
- 3) While maintaining a constant temperature inside the environmental chamber, turn the EUT ON and record the operating frequency at startup, and at 2 minutes, 5 minutes, and 10 minutes after the EUT is energized. Four measurements in total are made.
- 4) The frequency tolerance of the carrier signal shall be maintained within $\pm 0.01\%$ of the operating frequency.

Note:

- 1) Temperature:
The temperature is varied from $-20\text{ }^{\circ}\text{C}$ to $+50\text{ }^{\circ}\text{C}$ using an environmental chamber.
- 2) Primary Supply Voltage :



The primary supply voltage is varied from 85 % to 115 % of the nominal value for non hand-carried battery and AC powered equipment.

For hand-carried, battery-powered equipment, primary supply voltage is reduced to the battery operating end point which shall be specified by the manufacturer.

7.4. AC Power line Conducted Emissions

Limit

For an intentional radiator that is designed to be connected to the public utility (AC) power line, the radio frequency voltage that is conducted back onto the AC power line on any frequency or frequencies, within the band 150 kHz to 30 MHz, shall not exceed the limits in the following table, as measured using a 50 μ H/50 ohms line impedance stabilization network (LISN).

Frequency Range (MHz)	Limits (dB μ V)	
	Quasi-peak	Average
0.15 to 0.50	66 to 56 ^(a)	56 to 46 ^(a)
0.50 to 5	56	46
5 to 30	60	50

^(a)Decreases with the logarithm of the frequency.

Compliance with this provision shall be based on the measurement of the radio frequency voltage between each power line (LINE and NEUTRAL) and ground at the power terminals.

Test Configuration

See test photographs attached in Annex A for the actual connections between EUT and support equipment.

Test Procedure

1. The EUT is placed on a wooden table 80 cm above the reference ground plane.
2. The EUT is connected via LISN to a test power supply.
3. The measurement results are obtained as described below:
4. Detectors : Quasi Peak and Average Detector.
5. The EUT is the device operating below 30 MHz.
 - For unterminated the Antenna, the AC line conducted tests are performed with the antenna connected
 - For terminated the Antenna, the AC line conducted tests are performed with a dummy load connected to the EUT antenna output terminal.

Sample Calculation

Quasi-peak(Final Result) = Measured Value + Correction Factor

7.5. Receiver Spurious Emissions

Limit

Frequency (MHz)	Field Strength ($\mu\text{V/m}$)	Measurement Distance (m)
30-88	100	3
88-216	150	3
216-960	200	3
Above 960	500	3

Note:

Measurements for compliance with the limits in table may be performed at distances other than 3 metres.

Test Configuration

30 MHz - 1 GHz

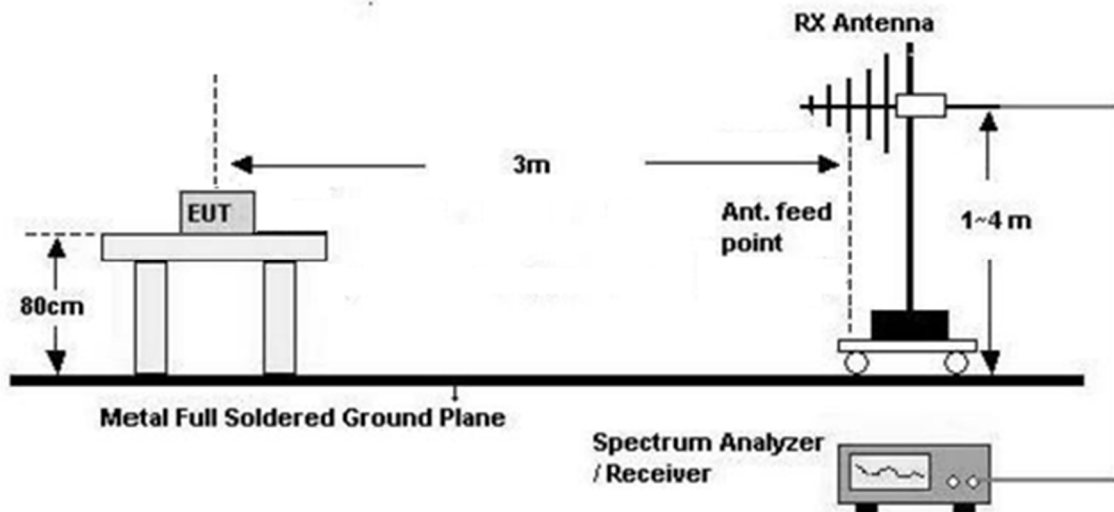

Test Procedure of Receiver Spurious Emissions (Below 1GHz)

1. The EUT was placed on a non-conductive table located on semi-anechoic chamber.
2. The EUT is placed on a turntable, which is 0.8 m above ground plane.
3. The Hybrid antenna was placed at a location 3 m from the EUT, which is varied from 1 m to 4 m to find out the highest emissions.
4. We have done x, y, z planes in EUT and horizontal and vertical polarization in detecting antenna.
5. The turntable shall be rotated for 360 degrees to determine the position of maximum emission level.
6. Spectrum Setting
 - (1) Measurement Type(Peak):
 - Measured Frequency Range : 30 MHz – 1 GHz
 - Detector = Peak
 - Trace = Maxhold
 - RBW = 100 kHz
 - VBW \geq 3 x RBW
 - (2) Measurement Type(Quasi-peak):
 - Measured Frequency Range : 30 MHz – 1 GHz
 - Detector = Quasi-Peak
 - RBW = 120 kHz
7. Total = Measured Value
 - We apply to the offset in the range 30 MHz - 1 GHz.
 - The offset is Antenna Factor(A.F) + Cable Loss(C.L) – Amp Gain(A.G)

Above 1 GHz

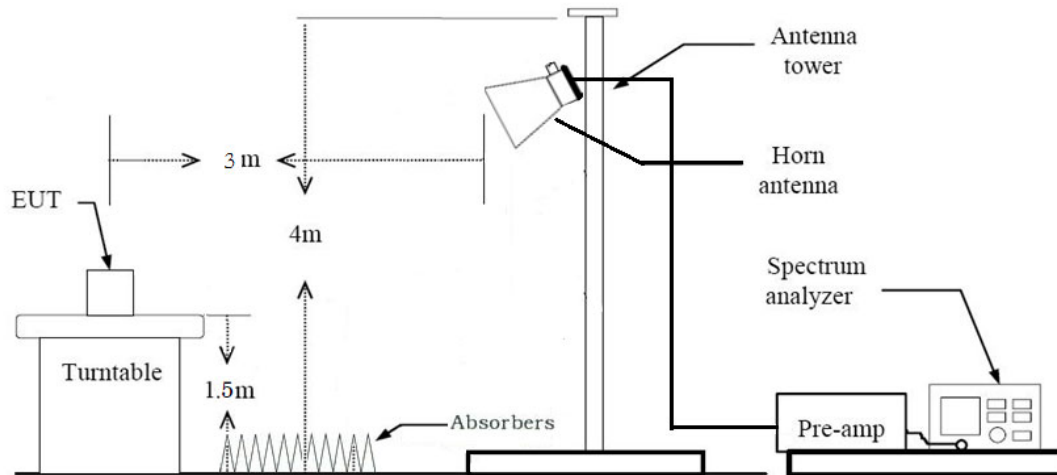

Test Procedure of Radiated spurious emissions (Above 1 GHz)

1. The EUT is placed on a turntable, which is 1.5 m above ground plane.
2. We have done x, y, z planes in EUT and horizontal and vertical polarization in detecting antenna.
3. The turntable shall be rotated for 360 degrees to determine the position of maximum emission level.
4. EUT is set 3 m away from the receiving antenna, which is varied from 1m to 4m to find out the highest emissions.
5. Maximum procedure was performed on the six highest emissions to ensure EUT compliance.
6. Each emission was to be maximized by changing the polarization of receiving antenna both horizontal and vertical.

7. Spectrum Setting

(1) Measurement Type(Peak):

- Measured Frequency Range : 1 GHz – 25 GHz
- Detector = Peak
- Trace = Maxhold
- RBW = 1 MHz
- VBW \geq 3 x RBW

(2) Measurement Type(Average):

- Duty cycle < 98%, duty cycle variations are less than $\pm 2\%$
- Measured Frequency Range : 1 GHz – 25 GHz
- Detector = RMS
- Averaging type = power (*i.e.*, RMS)
- RBW = 1 MHz

- VBW \geq 3 x RBW
- Sweep time = auto.

8. Measurement value only up to 6 maximum emissions noted, or would be lesser if no specific emissions from the EUT are recorded (ie: margin > 20 dB from the applicable limit) and considered that's already beyond the background noise floor.

9. Total = Measured Level + Antenna Factor(A.F) + Cable Loss(C.L) - Amp Gain(A.G) + Distance Factor(D.F)

7.6. Worst case configuration and mode

Radiated test

1. All modes of operation were investigated and the worst case configuration results are reported.
 - Mode : Stand alone
 - Worstcase : Stand alone
2. All EUT Axis of operation were investigated and the worst case configuration results are reported.
 - Worst case EUT Axis: Z
3. All type and bitrate were investigated and the worst case results are reported.
 - Worst case : Type A, 106 kbps
4. All position of loop antenna were investigated and the worst case configuration results are reported.
 - Position : Horizontal, Vertical, Parallel to the ground plane
 - Worstcase : Horizontal

AC Power line Conducted Emissions

1. All modes of operation were investigated and the worst case configuration results are reported.
 - Mode : Stand alone
 - Worstcase : Stand alone

20 dB Bandwidth & Frequency Stability

1. All type and bitrate were investigated and the worst case results are reported.
 - Worst case : Type A, 106 kbps

8. TEST SUMMARY

FCC Part

Regulation	Requirement	Result
Part 15.225 (a)	Radiated Electric Field Emissions (13.553 MHz to 13.567 MHz)	Pass
Part 15.225 (b)	Radiated Electric Field Emissions ($13.410 \leq f \leq 13.553$, $13.567 \leq f \leq 13.710$)	Pass
Part 15.225 (c)	Radiated Electric Field Emissions ($13.110 \leq f \leq 13.410$, $13.710 \leq f \leq 14.010$)	Pass
Part 15.209	Radiated Electric Field Emissions (9 kHz to 30 MHz)	Pass
Part 15.209	Radiated Electric Field Emissions (30 MHz to 1 GHz)	Pass
Part 15.225 (e)	Frequency Stability	Pass
Part 15.207	AC power conducted emissions (150 kHz to 30 MHz)	Pass
Part 15.215 (c)	20 dB Bandwidth	Pass

ISED Part

Test Description	ISED Part Section(s)	Test Result
Radiated Electric Field Emissions (13.553 MHz to 13.567 MHz)	RSS-210, annex B.6(a)(i)	Pass
Radiated Electric Field Emissions ($13.410 \leq f \leq 13.553$, $13.567 \leq f \leq 13.710$)	RSS-210, annex B.6(a)(ii)	Pass
Radiated Electric Field Emissions ($13.110 \leq f \leq 13.410$, $13.710 \leq f \leq 14.010$)	RSS-210, annex B.6(a)(iii)	Pass
Radiated Electric Field Emissions (9 kHz to 30 MHz)	RSS-GEN, 8.9	Pass
Radiated Electric Field Emissions (30 MHz to 1 GHz)	RSS-GEN, 8.9	Pass
Frequency Stability	RSS-210, annex B.6(a)(iv)	Pass
AC power conducted emissions (150kHz to 30MHz)	RSS-GEN, 8.8	Pass
20 dB Bandwidth	RSS-GEN, 6.7	Pass
Receiver Spurious Emissions	RSS-GEN, 7	Pass

9. TEST RESULT

9.1. Operation within the band 13.110 MHz – 14.010 MHz

Measured Frequency Range :

13.553 MHz-13.567 MHz

Frequency (MHz)	Measured Value (dB μ V/m) @3 m	A.F+C.L [dB/m]	Distance Correction (dB)	Ant. POL (H/V)	Total (dB μ V/m) @30 m	Limit (dB μ V/m) @30 m	Margin (dB)
13.5605	49.08	20.59	-40.00	H	29.66	84.00	54.34
13.5621	48.02	20.59	-40.00	H	28.61	84.00	55.39

Measured Frequency Range :

13.410 MHz-13.553 MHz and 13.567 MHz-13.710 MHz

Frequency (MHz)	Measured Value (dB μ V/m) @3 m	A.F+C.L [dB/m]	Distance Correction (dB)	Ant. POL (H/V)	Total (dB μ V/m) @30 m	Limit (dB μ V/m) @30 m	Margin (dB)
13.5530	42.63	20.59	-40.00	H	23.22	50.47	27.25
13.5671	43.68	20.59	-40.00	H	24.27	50.47	26.20

Measured Frequency Range :

13.110 MHz – 13.410 MHz and 13.710 MHz-14.010 MHz

Frequency (MHz)	Measured Value (dB μ V/m) @3 m	A.F+C.L [dB/m]	Distance Correction (dB)	Ant. POL (H/V)	Total (dB μ V/m) @30 m	Limit (dB μ V/m) @30 m	Margin (dB)
13.1571	10.31	20.59	-40.00	H	-9.10	40.51	49.61
13.9404	9.48	20.59	-40.00	H	-9.93	40.51	50.44

▣ Test Plots

13.553 MHz ~ 13.567 MHz

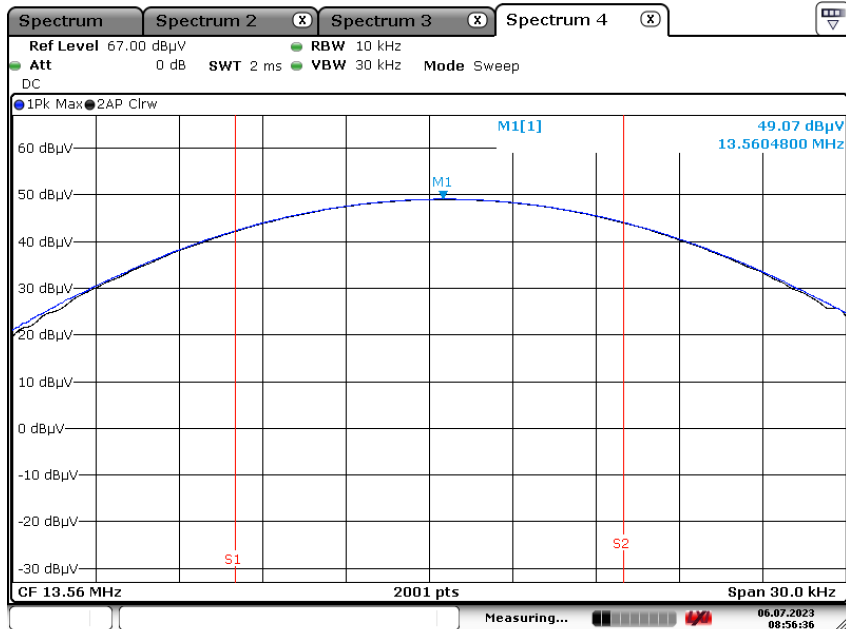

Date: 6.JUL.2023 08:56:36

13.567 MHz-13.710 MHz

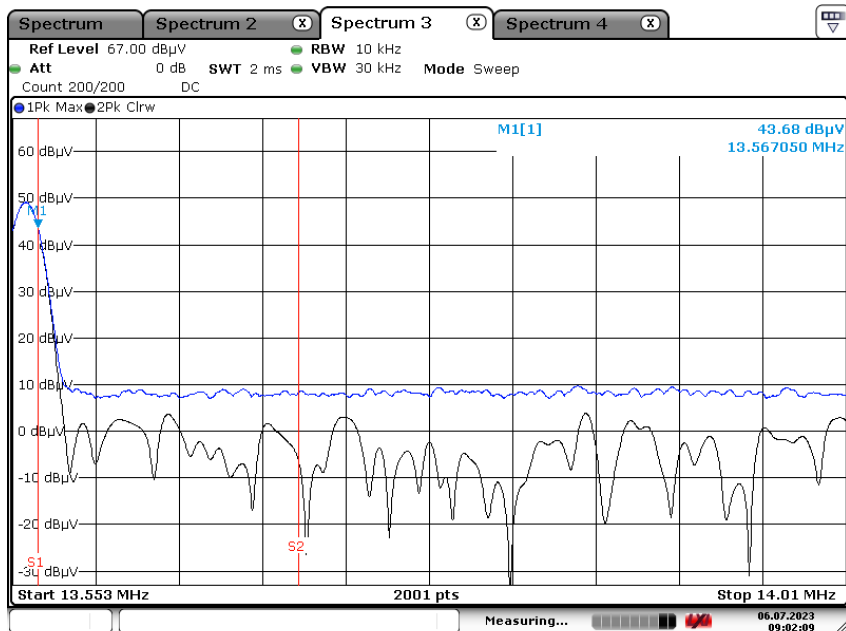

Date: 6.JUL.2023 09:02:10

Note:

In order to simplify the report, Plots of worst case are only reported

9.2. Radiated Emission 9 kHz – 30 MHz

-FCC

Measured Frequency Range :

9 kHz - 490 kHz

Frequency (kHz)	Measured Value (dB μ V/m) @3 m	A.F+C.L [dB/m]	Distance Correction (dB)	Ant. POL (H/V)	Total (dB μ V/m) @300 m	Limit (dB μ V/m) @300 m	Margin (dB)
0.0194	36.14	19.62	-80.00	H	-24.24	41.85	66.09
0.0524	32.16	20.14	-80.00	H	-27.70	33.23	60.93

Measured Frequency Range :

490 kHz - 30 MHz

Frequency (MHz)	Measured Value (dB μ V/m) @3 m	A.F+C.L [dB/m]	Distance Correction (dB)	Ant. POL (H/V)	Total (dB μ V/m) @30 m	Limit (dB μ V/m) @30 m	Margin (dB)
24.0028	11.71	20.93	-40.00	H	-7.36	29.54	36.90
21.0614	10.25	20.93	-40.00	H	-8.82	29.54	38.36
19.6254	10.14	20.59	-40.00	H	-9.27	29.54	38.81
28.1632	10.90	20.79	-40.00	H	-8.32	29.54	37.86

-ISED

Measured Frequency Range :

9 kHz - 490 kHz

Frequency (kHz)	Measured Value (dB μ V/m) @3 m	A.F+C.L [dB/m]	Distance Correction (dB)	Ant. POL (H/V)	Total (dB μ A/m) @300 m	Limit (dB μ A/m) @300 m	Margin (dB)
0.0194	36.14	19.62	-80.00	H	-75.77	0.33	76.10
0.0524	32.16	20.14	-80.00	H	-79.23	0.12	79.35

Measured Frequency Range :

490 kHz - 30 MHz

Frequency (MHz)	Measured Value (dB μ V/m) @3 m	A.F+C.L [dB/m]	Distance Correction (dB)	Ant. POL (H/V)	Total (dB μ A/m) @30 m	Limit (dB μ A/m) @30 m	Margin (dB)
24.0028	11.71	20.93	-40.00	H	-58.89	0.08	58.97
21.0614	10.25	20.93	-40.00	H	-60.35	0.08	60.43
19.6254	10.14	20.59	-40.00	H	-60.80	0.08	60.88
28.1632	10.90	20.79	-40.00	H	-59.85	0.08	59.93

Test Plot

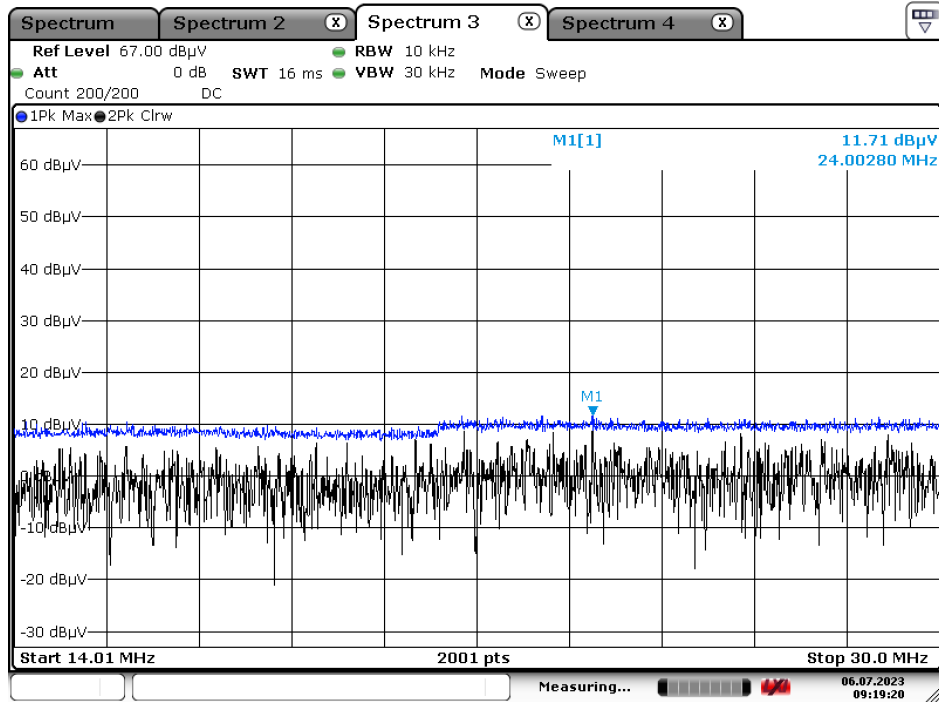

Date: 6.JUL.2023 09:19:21

Note:

In order to simplify the report, Plot of worst case is only reported

9.3. Radiated Emission 30 MHz – 1000 MHz

Measured Frequency Range :
30 MHz - 1000 MHz

Frequency (MHz)	Measured Value (dB μ V/m)@3 m	Ant. Pol (H/V)	Total (dB μ V/m)	Limit (dB μ V/m)	Margin (dB)
#162.5800	33.74	H	33.74	43.52	9.78
216.8700	33.08	H	33.08	46.02	12.94
#244.0200	37.39	V	37.39	46.02	8.63
#271.1700	34.27	H	34.27	46.02	11.75
298.3100	37.34	H	37.34	46.02	8.68
#325.4600	35.08	V	35.08	46.02	10.94

Note:

- # is the result for restricted band.
- Correction factor was included in the Spectrum Analyzer.

Test Plot

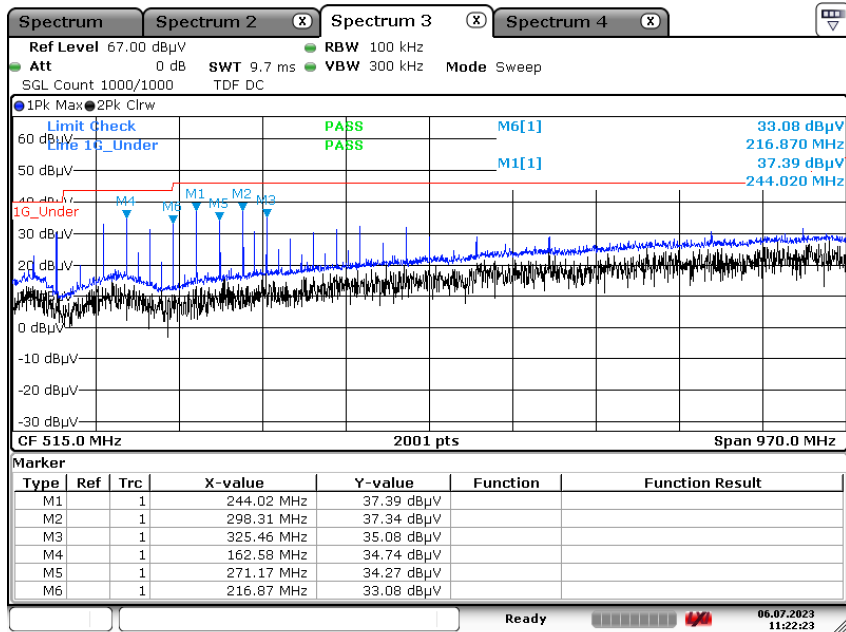

Date: 6.JUL.2023 11:22:24

Note:

In order to simplify the report, Plot of worst case is only reported

9.4. 20 dB Bandwidth

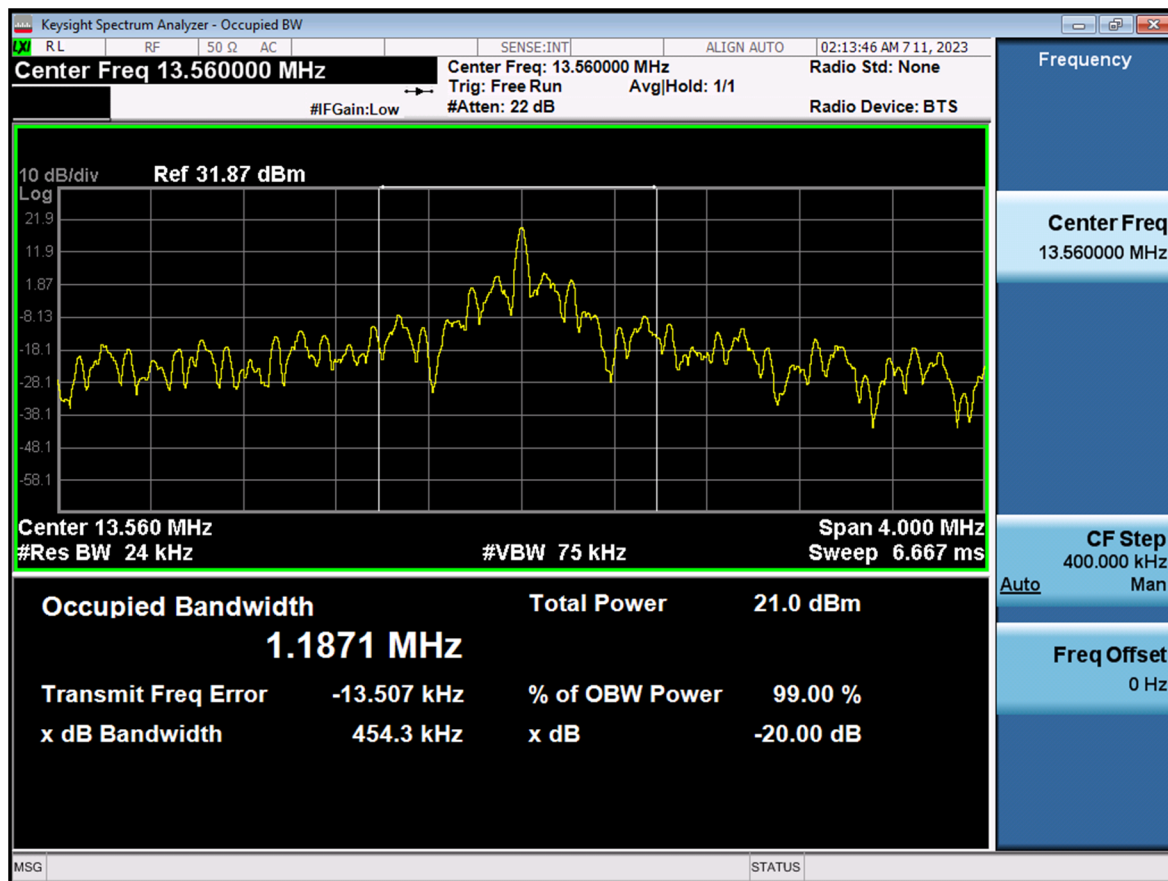



9.5. Frequency Stability

Startup

OPERATING FREQUENCY: 13.56 MHz
 REFERENCE VOLTAGE: 3.3 VDC
 DEVIATION LIMIT: ±0.01 % = ±1356 Hz

Voltage	Power	Temp.	Frequency	Frequency Dev.	Frequency
(%)	(VDC)	(°C)	(MHz)	(Hz)	Dev (%)
100 %	3.3	-20	13.560007	7	0.0000516
100 %		-10	13.560050	50	0.0003687
100 %		0	13.560073	73	0.0005383
100 %		+10	13.560034	34	0.0002507
100 %		+20(Ref.)	13.560095	95	0.0007006
100 %		+30	13.560069	69	0.0005088
100 %		+40	13.560083	83	0.0006121
100 %		+50	13.560058	58	0.0004277
LOW		3.0	+20	13.560096	96
HIGH	3.6	+20	13.560038	38	0.0002802



2 minutes

PERATING FREQUENCY: 13.56 MHz

REFERENCE VOLTAGE: 3.3 VDC

DEVIATION LIMIT: ±0.01 % = ±1356 Hz

Voltage	Power	Temp.	Frequency	Frequency Dev.	Frequency
(%)	(VDC)	(°C)	(MHz)	(Hz)	Dev (%)
100 %	3.3	-20	13.560072	72	0.0005310
100 %		-10	13.560077	77	0.0005678
100 %		0	13.560074	74	0.0005457
100 %		+10	13.560064	64	0.0004720
100 %		+20(Ref.)	13.560005	5	0.0000369
100 %		+30	13.560048	48	0.0003540
100 %		+40	13.560006	6	0.0000442
100 %		+50	13.560078	78	0.0005752
LOW		3.0	+20	13.560016	16
HIGH	3.6	+20	13.560030	30	0.0002212



5 minutes

PERATING FREQUENCY: 13.56 MHz

REFERENCE VOLTAGE: 3.3 VDC

DEVIATION LIMIT: ±0.01 % = ±1356 Hz

Voltage	Power	Temp.	Frequency	Frequency Dev.	Frequency
(%)	(VDC)	(°C)	(MHz)	(Hz)	Dev (%)
100 %	3.3	-20	13.560042	42	0.0003097
100 %		-10	13.560100	100	0.0007375
100 %		0	13.560089	89	0.0006563
100 %		+10	13.560041	41	0.0003024
100 %		+20(Ref.)	13.560036	36	0.0002655
100 %		+30	13.560020	20	0.0001475
100 %		+40	13.560021	21	0.0001549
100 %		+50	13.560041	41	0.0003024
LOW		3.0	+20	13.560026	26
HIGH	3.6	+20	13.560036	36	0.0002655



10 minutes

PERATING FREQUENCY: 13.56 MHz
 REFERENCE VOLTAGE: 3.3 VDC
 DEVIATION LIMIT: ±0.01 % = ±1356 Hz

Voltage	Power	Temp.	Frequency	Frequency Dev.	Frequency
(%)	(VDC)	(°C)	(MHz)	(Hz)	Dev (%)
100 %	3.3	-20	13.560012	12	0.0000885
100 %		-10	13.560043	43	0.0003171
100 %		0	13.560094	94	0.0006932
100 %		+10	13.560081	81	0.0005973
100 %		+20(Ref.)	13.560023	23	0.0001696
100 %		+30	13.560093	93	0.0006858
100 %		+40	13.560051	51	0.0003761
100 %		+50	13.560026	26	0.0001917
LOW		3.0	+20	13.560019	19
HIGH	3.6	+20	13.560004	4	0.0000295



9.6 POWERLINE CONDUCTED EMISSIONS

Conducted Emissions

TERM

Test

1 / 1

Test Report

Common Information

EUT : EAX70191101
 Operating Conditions : RFID_Term Mode
 Comment :

Full Spectrum

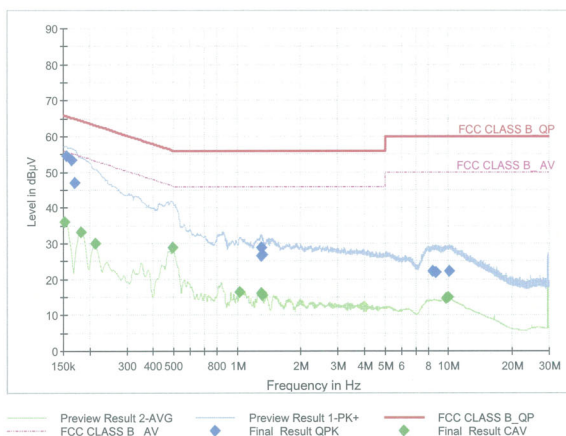

Final Result QPK

Frequency (MHz)	QuasiPeak (dBµV)	Limit (dBµV)	Margin (dB)	Meas. Time (ms)	Bandwidth (kHz)	Line	Filter	Corr. (dB)
0.1545	54.62	65.75	11.13	1000.0	9.000	N	OFF	9.6
0.1635	53.29	65.28	12.00	1000.0	9.000	N	OFF	9.6
0.1703	47.16	64.95	17.79	1000.0	9.000	N	OFF	9.6
1.2943	28.74	56.00	27.26	1000.0	9.000	N	OFF	9.7
1.3033	26.40	56.00	29.60	1000.0	9.000	N	OFF	9.7
1.3123	26.70	56.00	29.30	1000.0	9.000	N	OFF	9.7
8.4020	22.22	60.00	37.78	1000.0	9.000	N	OFF	10.0
8.6855	21.81	60.00	38.19	1000.0	9.000	N	OFF	10.0
10.1143	22.23	60.00	37.77	1000.0	9.000	N	OFF	10.1

Final Result CAV

Frequency (MHz)	CAverage (dBµV)	Limit (dBµV)	Margin (dB)	Meas. Time (ms)	Bandwidth (kHz)	Line	Filter	Corr. (dB)
0.1523	36.19	55.88	19.69	1000.0	9.000	L1	OFF	9.7
0.1815	33.13	54.42	21.29	1000.0	9.000	L1	OFF	9.7
0.2130	29.91	53.09	23.18	1000.0	9.000	L1	OFF	9.7
0.4965	28.74	46.06	17.32	1000.0	9.000	N	OFF	9.6
1.0310	16.43	46.00	29.57	1000.0	9.000	N	OFF	9.7
1.3033	16.21	46.00	29.79	1000.0	9.000	N	OFF	9.7
1.3145	15.66	46.00	30.34	1000.0	9.000	N	OFF	9.7
9.7588	14.77	50.00	35.23	1000.0	9.000	N	OFF	10.0
10.0175	15.14	50.00	34.86	1000.0	9.000	N	OFF	10.1

2023-07-11

오후 2:59:21

UNTERM

Test

1 / 1

Test Report

Common Information

EUT : EAX70191101
 Operating Conditions : RFID_UnTem Mode
 Comment :

Full Spectrum

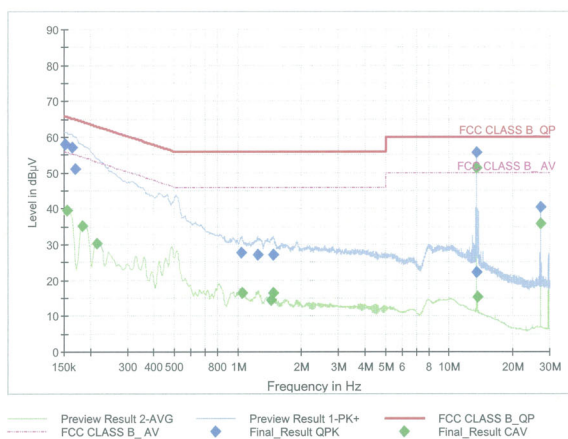

Final Result QPK

Frequency (MHz)	QuasiPeak (dBµV)	Limit (dBµV)	Margin (dB)	Meas. Time (ms)	Bandwidth (kHz)	Line	Filter	Corr. (dB)
0.1523	58.02	65.88	7.86	1000.0	9.000	N	OFF	9.6
0.1635	57.11	65.28	8.17	1000.0	9.000	N	OFF	9.6
0.1703	51.19	64.95	13.76	1000.0	9.000	N	OFF	9.6
1.0378	27.71	56.00	28.29	1000.0	9.000	N	OFF	9.7
1.2425	27.05	56.00	28.95	1000.0	9.000	N	OFF	9.7
1.4720	27.12	56.00	28.88	1000.0	9.000	N	OFF	9.7
13.4533	22.27	60.00	37.73	1000.0	9.000	L1	OFF	10.1
13.5613	55.58	60.00	4.42	1000.0	9.000	L1	OFF	10.1
27.1220	40.38	60.00	19.62	1000.0	9.000	L1	OFF	10.6

Final Result CAV

Frequency (MHz)	CAverage (dBµV)	Limit (dBµV)	Margin (dB)	Meas. Time (ms)	Bandwidth (kHz)	Line	Filter	Corr. (dB)
0.1545	39.45	55.75	16.31	1000.0	9.000	L1	OFF	9.7
0.1838	35.28	54.31	19.03	1000.0	9.000	L1	OFF	9.7
0.2153	30.40	53.00	22.60	1000.0	9.000	L1	OFF	9.7
1.0445	16.36	46.00	29.64	1000.0	9.000	N	OFF	9.7
1.4338	14.55	46.00	31.45	1000.0	9.000	N	OFF	9.7
1.4653	16.38	46.00	29.62	1000.0	9.000	N	OFF	9.7
13.5613	51.40	50.00	-1.40	1000.0	9.000	L1	OFF	10.1
13.6558	15.38	50.00	34.62	1000.0	9.000	L1	OFF	10.2
27.1220	35.76	50.00	14.24	1000.0	9.000	L1	OFF	10.6

2023-07-11

오후 2:53:27

10. LIST OF TEST EQUIPMENT

Conducted Test

Equipment	Model	Manufacturer	Serial No.	Due to Calibration	Calibration Interval
LISN	ENV216	Rohde & Schwarz	102245	08/22/2023	Annual
EMI Test Receiver	ESR	Rohde & Schwarz	101910	05/26/2024	Annual
Temperature Chamber	SU-642	ESPEC	93008124	02/22/2024	Annual
Signal Analyzer	N9030A	Keysight	MY55410508	09/06/2023	Annual
Power Meter	N1911A	Agilent	MY45100523	03/06/2024	Annual
Power Sensor	N1921A	Agilent	MY57820067	03/06/2024	Annual
Directional Coupler	87300B	Agilent	3116A03621	11/02/2023	Annual
Power Splitter	11667B	Hewlett Packard	10545	02/06/2024	Annual
DC Power Supply	E3632A	Agilent	KR75305528	01/03/2024	Annual
Attenuator(10 dB)(DC-26.5 GHz)	8493C-010	Agilent	08285	06/21/2023	Annual
Attenuator(30 dB)(DC-26.5 GHz)	8493C-030	Agilent	77640	06/14/2023	Annual
Software	EMC32	Rohde & Schwarz	N/A	N/A	N/A
FCC WLAN&BT&BLE Conducted Test Software v3.0	N/A	HCT CO., LTD.	N/A	N/A	N/A
Bluetooth Tester	CBT	Rohde & Schwarz	100808	02/16/2024	Annual

Note:

1. Equipment listed above that calibrated during the testing period was set for test after the calibration.
2. Equipment listed above that has a calibration due date during the testing period, the testing is completed before equipment expiration date.

Radiated Test

Equipment	Model	Manufacturer	Serial No.	Due to Calibration	Calibration Interval
Controller(Antenna mast)	CO3000	Innco system	CO3000-4p	N/A	N/A
Antenna Position Tower	MA4640/800-XP-EP	Innco system	N/A	N/A	N/A
Controller	EM2090	Emco	060520	N/A	N/A
Turn Table	N/A	Ets	N/A	N/A	N/A
Loop Antenna	FMZB 1513	Rohde & Schwarz	1513-333	03/17/2024	Biennial
Hybrid Antenna	VULB 9168	Schwarzbeck	9168-0895	08/16/2024	Biennial
Horn Antenna	BBHA 9120D	Schwarzbeck	9120D-1191	11/18/2023	Biennial
Horn Antenna(15 GHz ~ 40 GHz)	BBHA9170	Schwarzbeck	BBHA9170124	03/28/2025	Biennial
Amp & Filter Bank Switch Controller	FBSM-01A	TNM system	0	N/A	N/A
RF Switching System	FBSR-03A (3G HPF+LNA)	T&M SYSTEM	S3L1	12/05/2023	Annual
RF Switching System	FBSR-03A (10dB ATT+LNA)	T&M SYSTEM	S3L2	12/05/2023	Annual
RF Switching System	FBSR-03A (7G HPF+LNA)	T&M SYSTEM	S3L3	12/05/2023	Annual
RF Switching System	FBSR-03A (3dB ATT+LNA)	T&M SYSTEM	S3L4	12/05/2023	Annual
Power Amplifier	CBL18265035	CERNEK	22966	12/01/2023	Annual
Power Amplifier	CBL26405040	CERNEK	25956	03/02/2024	Annual
Power Amplifier	310N	SONOMA INSTRUMENT	186169	02/15/2024	Annual
Bluetooth Tester	TC-3000C	TESCOM	3000C000175	03/28/2024	Annual
Spectrum Analyzer	FSP (9 kHz ~ 30 GHz)	Rohde & Schwarz	836650/016	09/06/2023	Annual
Spectrum Analyzer	FSVA40 (10 Hz ~ 40 GHz)	Rohde & Schwarz	101502	03/17/2024	Annual

Note:

1. Equipment listed above that calibrated during the testing period was set for test after the calibration.
2. Equipment listed above that has a calibration due date during the testing period, the testing is completed before equipment expiration date.
3. Especially, all antenna for measurement is calibrated in accordance with the requirements of C63.5(Version : 2017).



11. ANNEX A_ TEST SETUP PHOTO

Please refer to test setup photo file no. as follows;

No.	Description
1	HCT-RF-2307-FI001-P