

MPE TEST REPORT
(Class II Permissive Change)

Applicant: LG Electronics USA.
1000 Sylvan Avenue,
Englewood Cliffs New Jersey United States 07632,
Attn: Kyung-Su Han / Director

Date of Issue: Sep. 08, 2017
Order Number: GETEC-C1-17-441
Test Report Number: GETEC-E3-17-046
Test Site: GUMI UNIVERSITY EMC CENTER
(FCC Test Firm Registration No.: 269701)

FCC ID. : BEJE18MRE07
Applicant : LG Electronics USA.

Rule Part(s) : FCC Part 1
Test Procedure : FCC Part 1, Subpart I, section 1.1310 and KDB 680106 D01 V02
EUT Type : Refrigerator
Type of Authority : Certification
Model Name : SKSCR3001P
Trade Mark : LG

This equipment has been shown to be in compliance with the applicable technical standards as indicated in the measurement report and was tested in accordance with the measurement procedures specified in 47 CFR Part 1, Subpart I, section 1.1310 and KDB 680106 D01 V02

I attest to the accuracy of data. All measurements reported herein were performed by me or were made under my supervision and are correct to the vest of my knowledge and belief. I assume full responsibility for the completeness of these measurements and vouch for the qualifications of all persons taking them.

Tested by,

Reviewed by,



Sang Hyun Park, Associate Engineer
GUMI UNIVERSITY EMC CENTER



Hyoung Seop Kim, Technical Manager
GUMI UNIVERSITY EMC CENTER



CONTENTS

1. GENERAL INFORMATION	3
2. INTRODUCTION	4
3. PRODUCT INFORMATION	5
3.1 DESCRIPTION OF EUT	5
3.2 DEFINITION OF MODELS	5
3.3 SUPPORT EQUIPMENT / CABLES USED	5
3.4 MODIFICATION ITEM(S)	5
4. DESCRIPTION OF TESTS	6
4.1 TEST CONDITION	6
5. TEST EQUIPMENT USED	6
6. TEST RESULT	7
6.1 TEST SETUP	7
6.2 MEASUREMENT PROCEDURE	7
6.3 EQUIPMENT APPROVAL CONSIDERATIONS	8
6.4 ENVIRONMENTAL EVALUATION AND EXPOSURE LIMIT	9
6.5 E AND H FIELD STRENGTH	10
6.5.1 FIELD STRENGTH MEASURE VALUE AT 10 CM FROM THE EDGES SURROUNDING THE EUT	10
7. PHOTOGRAPHS	11
7.1 TEST PHOTOGRAPHS	11



Scope: Measurement and determination of electromagnetic emissions (EME) of radio frequency devices including intentional and / or unintentional radiators for compliance with technical rules and regulations of the Federal Communications Commission.

1. General Information

Applicant: LG Electronics USA.

**Applicant Address: 1000 Sylvan Avenue,
Englewood Cliffs New Jersey United States 07632**

Manufacturer: LG Electronics Inc.

**Manufacturer Address: 170, Sungsanpaechong-ro, Seongsan-gu, Changwon-si,
Gyeongsangnam-do, 642-711, Korea**

Contact Person: Bogeun Lee / Research Engineer

Tel. Number: +82-55-260-3966

● FCC ID.	BEJE18MRE07
● EUT Type	Refrigerator
● Model Name	SKSCR3001P
● Rule Part(s)	FCC Part 1
● Type of Authority	Certification
● Test Procedure(s)	FCC Part 1, Subpart I, section 1.1310 and KDB 680106 D01 V02
● Dates of Test	Sep. 02, 2017
● Place of Test	GUMI UNIVERSITY EMC CENTER (FCC Test Firm Registration Number: 269701) 37 Yaeun-ro, Gumi-si, Gyeongsangbuk-do, 730-711, Republic of Korea.
● Test Report Number	GETEC-E3-17-046
● Dates of Issue	Sep. 08, 2017

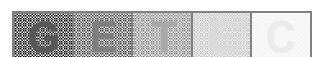



2. Introduction

The measurement procedure described in American National Standard for Methods of Measurement of Radio-Nose Emissions From Low-Voltage Electrical and Electronic Equipment in the Range of 9 kHz to 40 GHz (ANSI C63.4-2014) was used in determining radiated and conducted emissions emanating from **LG Electronics USA**.

Refrigerator (Model name: SKSCR3001P)

These measurement tests were conducted at **GUMI UNIVERSITY EMC CENTER**.

The site address is 37 Yaeun-ro, Gumi-si, Gyeongsangbuk-do, 730-711, Gyeongnam 641-713, Korea

This test site is one of the highest point of GUMI UNIVERSITY at about 200 kilometers away from Seoul city and 40 kilometers away from Daegu city. It is located in the valley surrounded by mountains in all directions where ambient radio signal conditions are quiet and a favorable area to measure the radio frequency interference on open field test site for the computing and ISM devices manufactures. The detailed description of the measurement facility was found to be in compliance with the requirements of §2.948 according to ANSI C63.4 (2014)

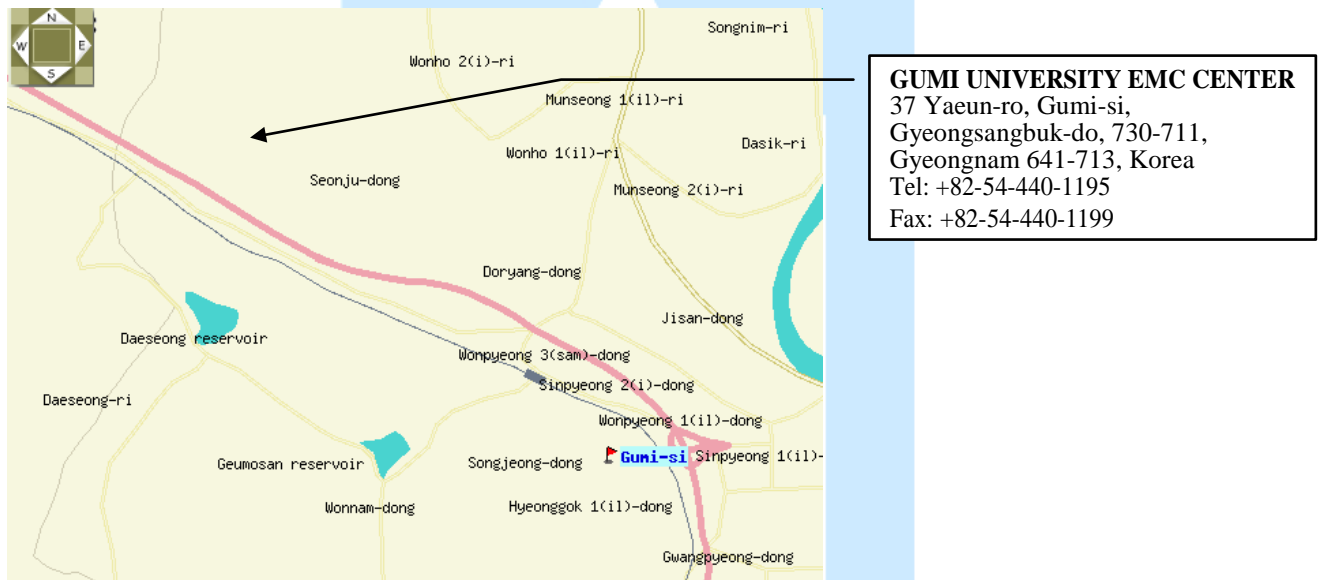
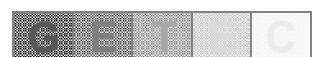

Fig 1. The map above shows the GUMI UNIVERSITY in vicinity area.





3. Product Information

3.1 Description of EUT

The Equipment under Test (EUT) is the **LG Electronics USA. Refrigerator (Model Name: SKSCR3001P)**
FCC ID.: BEJE18MRE07.

Type of Equipment	Refrigerator
Model Name	SKSCR3001P
Serial Number	Prototype
RF Frequency	330 kHz ~ 370 kHz
External connector	DC input 1 EA
Rated Voltage	Input : AC 115 V, 60 Hz (Wireless Power Transmitter input voltage: DC 12 V)
Output Electricity Power	Less than 3 W
Size(W x H x T)	29 ^{3/4} (W) x 23 ^{3/4} (D) x 83 ^{1/2} (H) inch (Wireless Power Transmitter module :50 (mm) x 35 (mm) x 1.0 (mm))

3.2 Definition of models

- None.

3.3 Support Equipment / Cables used

3.3.1 Used Support Equipment

Description	Manufacturer	Model Name	S/N & FCC ID.
None	-	-	S/N: - FCC ID.: -

See "Appendix E – Test Setup Photographs" for actual system test set-up

3.3.2 System configuration

Description	Manufacturer	Model Name	S/N & FCC ID.
None.	-	-	S/N: -. FCC ID.: -.

3.3.3 Used Cable(s)

Cable Name	Condition	Description
Power cable	Connected to the EUT and AC power	2.20 m Unshielded.

3.4 Modification Item(s)

-. None

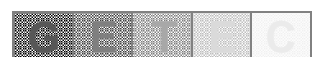



4. Description of tests

4.1 Test Condition

The EUT was installed, arranged and operated in a manner that is most representative of equipment as typically used. The measurements were carried out while varying operating modes and cable positions within typically arrangement to determine maximum emission level.

The representative and worst test mode(s) were noted in the test report.

- Test Voltage / Frequency: AC 115V, 60 Hz(Wireless Power Transfer Device supplied DC 12 V)
- Operating condition during the test(s) :

This device has been tested in the configurations of charging mode

Charging Current	Support Equipment	Comment
1 000 mA	Refrigerator Shelf RX module	

5. Test Equipment used

Model Name	Manufacturer	Description	Serial Number	Due to Calibration
■ - ELT-400	Narda Safety Test Solutions GmbH	EMF Tester	J-0005	Sep. 09, 2018
■ - HI-6105	ETS LINDGREN	Electric field Probe	203871	Dec. 13, 2017

All test equipment used is calibrated on a regular basis.

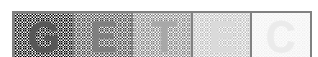



6. Test Result

6.1 Test Setup

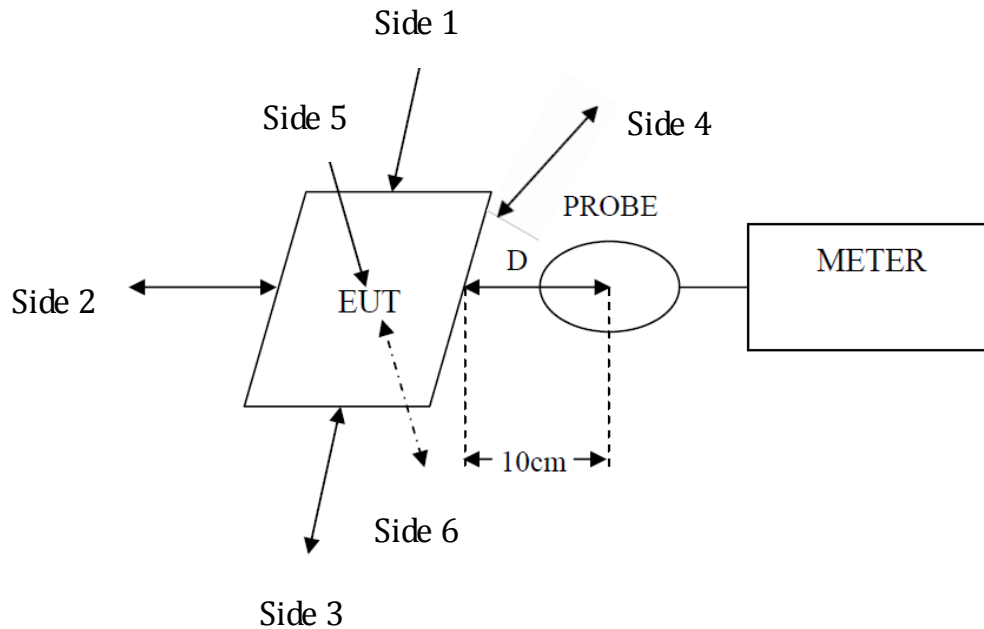

6.2 Measurement Procedure

The RF exposure test was performed on 360 degree turn table in anechoic chamber. The measurement probe was placed at test distance (10 cm) which is between the edge of the charger and the geometric center of probe. The turn table was rotated 360 degree to search of highest strength. The highest emission level was recorded and compared with limit as soon as measurement of each points (Side 1 ~ 6) were completed. The EUT were measured according to the dictates of KDB 680106 D01v02.

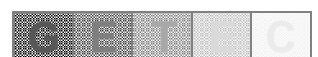



6.3 Equipment Approval Considerations.

The EUT does with item 5.2 of KDB 680106 D01v02

- a) Power transfer frequency is less than 1 MHz
- Power transfer(Main Carrier) frequency is fixed between 330 kHz ~ 370 kHz
- b) Output power from each primary coil is less than 5 watts.
- The maximum field strength of fundamental : 60.81 dB μ V/m at 3 m. The EIRP calculation is reference to KDB 789033
* $EIRP[dBm] = E[dB\mu V/m] + 20\log(d[meters]) - 104.77$, $d = 3$ m
* $60.81 \text{ dB}\mu V/m - 95.2 = -34.39 \text{ dBm EIRP}$
* The output power from primary coil is 0.000 363 mW
- c) The transfer system includes only single primary and secondary coils. This includes charging systems that may have multiple primary coils and clients that are able to detect and allow coupling only between individual pairs of coils
- The system is consists of single primary and secondary coils.

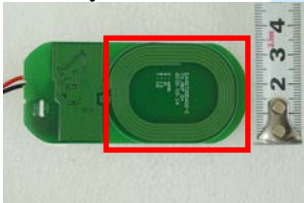

- d) Client device is inserted in or placed directly in contact with the transmitter
- Client device(Receiver) is placed by the transmitter with a less than 10 mm gap.
Refer to following photo.

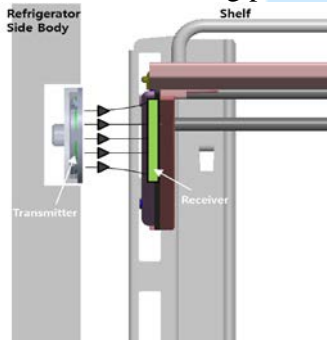

- e) The maximum coupling surface area of the transmit(charging) device is between 60 cm² and 400 cm²
- The shape of primary and secondary coils are same and the they are center-aligned.
Maximum coupling surface area of transmitter is under 20cm²
- f) Aggregate leakage fields at 10 cm surrounding the device from all simultaneous transmitting coils are demonstrated to be less than 30% of the MPE limit.
- Aggregate leakage level of the system in normal operating condition at 10cm surrounding the device is under 15% of MPE limit (<0.2A/m)
- 0.212 A/m (maximum measure value) < 0.486 Am (30% MPE limit)

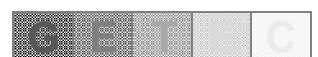



6.4 Environmental evaluation and exposure limit

*** according to FCC CFR 47 part 1, 1.1307(b), 1.1310**

§1.1310 : The criteria listed in the following table shall be used to evaluate the environment impact of human exposure to radio frequency (RF) radiation as specified in §1.1307(b), except in the case of portable devices which shall be evaluated according to the provisions of FCC part 2.1093 of this chapter

Table 1 – LIMITS FOR MAXIMUM PERMISSIBLE EXPOSURE (MPE)

Frequency Range (MHz)	Electric Field Strength(V/m)	Magnetic Field Strength(A/m)	Power Density (mW/cm ²)	Average Time (minutes)
(A) Limits for Occupational /Control Exposures				
0.3 – 3.0	614	1.63	*(100)	6
3.0 – 30	1842/f	4.89/f	*(900/f ²)	6
30 – 300	61.4	6.163	1.0	6
300 – 1 500			f/300	6
1 500 – 100 000			5	6
(B) Limits for General Population / Uncontrol Exposures				
0.3 – 1.34	614	1.63	*(100)	30
1.34 – 30	824/f	2.19	*(180/f ²)	30
30 – 300	27.5	0.073	0.2	30
300 – 1 500			f/1 500	30
1 500 – 100 000			1.0	30

F=frequency in MHz

* = Plane wave equivalent power density

Note 1 to Table 1: Occupational/controlled limits apply in situations in which persons are exposed as a consequence of their employment provided those persons are fully aware of the potential for exposure and can exercise control over their exposure. Limits for occupational/controlled exposure also apply in situations when an individual is transient through a location where occupational/controlled limits apply provided he or she is made aware of the potential for exposure.

Note 2 to Table 1: General population/uncontrolled exposures apply in situations in which the general public may be exposed, or in which persons that are exposed as a consequence of their employment may not be fully aware of the potential for exposure or can not exercise control over their exposure.

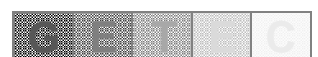



6.5 E and H field strength

Temperature : 22.4 °C
Relative Humidity : 58.9 % R.H.
Air pressure : 100.4 kPa

Test mode : Continuous Power transmitting mode

6.5.1 Field Strength measure value at 10 cm from the edges surrounding the EUT

Electric Field Strength

Test Position	Probe Measure Result(V/m)	Limit(V/m)	30 % Limit(V/m)
Side 1	7.76	614	184.2
Side 2	5.15	614	184.2
Side 3	5.82	614	184.2
Side 4	9.15	614	184.2
Side 5	6.82	614	184.2

Magnetic Field Strength

Test Position	Probe Measure Result(A/m)	Limit(A/m)	30 % Limit(A/m)
Side 1	0.099	1.63	0.489
Side 2	0.092	1.63	0.489
Side 3	0.096	1.63	0.489
Side 4	0.103	1.63	0.489
Side 5	0.101	1.63	0.489



7. Photographs

7.1 Test Photographs

Test model No.: SKSCR3001P

Test with full load

Side 1

< Electric field >



< Magnetic field >





Side 2

< Electric field >



< Magnetic field >

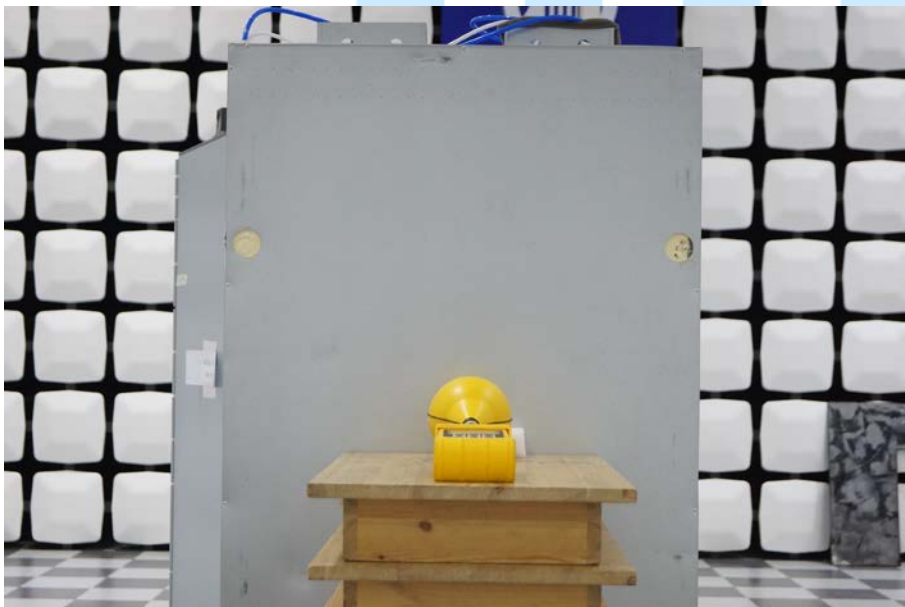



Side 3

< Electric field >

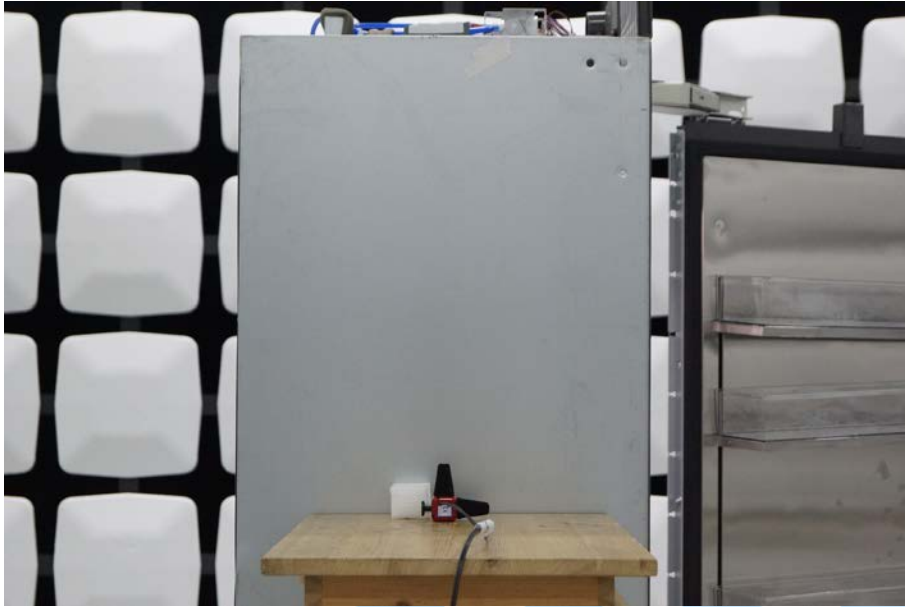

< Magnetic field >





Side 4

< Electric field >

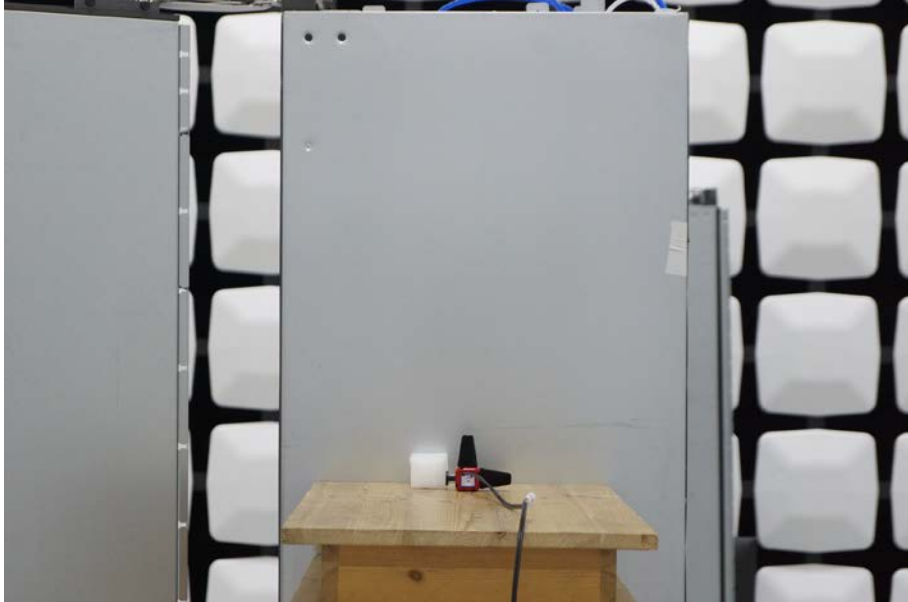

< Magnetic field >





Side 5

< Electric field >

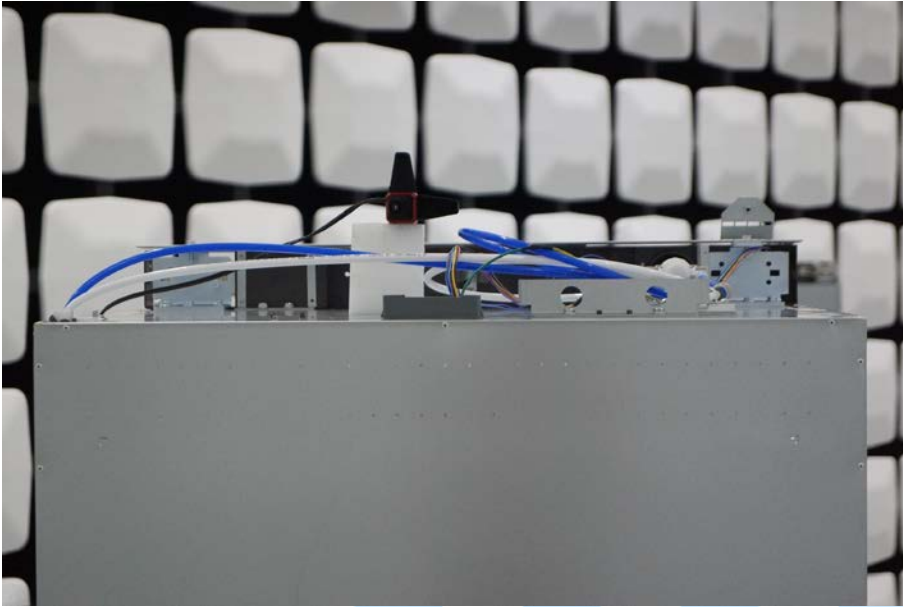

< Magnetic field >

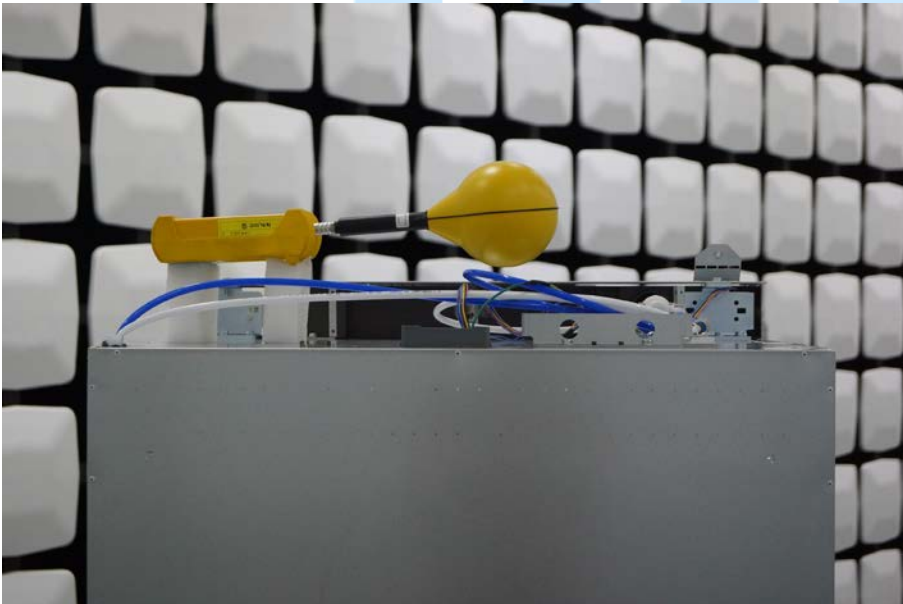

- The end -