



APPENDIX B
: INFORMATION OF CLASS II PERMISSIVE CHANGE



Information of Class II Permissive Change

This information is to show compliance with FCC regulation Sec. 2.1043 and to be treated as Class II permissive change. We declare that the basic frequencies of Clks, Xtals, processors/CPUs... used/ or Generated within device have not changed.

1. Identification of apparatus

EUT Type: Household Refrigerator
Model Name: SKSCF3001P
FCC ID.: BEJE18MFF07
Applicant: LG Electronics USA, Inc.

2. Contents of change(s): Alternated Item.

■ Original Item

< Wireless shelf module > : **P/No. : EAX67566001**

■ Alternated New Item

< Wireless shelf module > : **P/No. : EAX67566001 Or EAX67566005**

※ Pictures of the Wireless shelf module (original & Alternated new) within internal photos.

Refer to “APPENDIX E = INTERNAL PHOTOGRAPHS ; 4 Page – 5 Page”

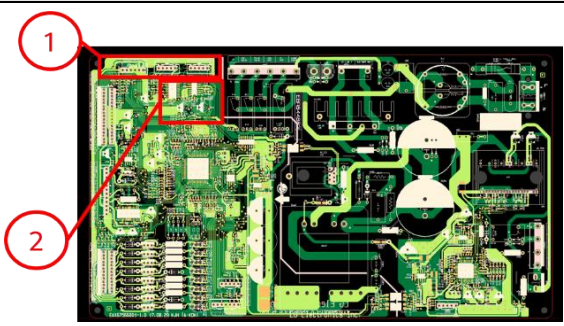
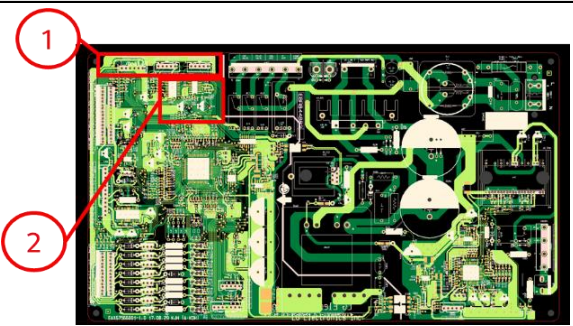

※ Changing Point(Detail)

	OLD	NEW
PCB Artwork	 <div data-bbox="367 862 742 1030" style="border: 1px solid black; padding: 5px; margin-top: 10px;"><p>① Change Connector ② Add DC Boost circuit</p></div>	 <p style="text-align: center;">Or</p> 