

Scan to see the online manual.



OWNER'S MANUAL SPEED MICROWAVE OVEN

Read this owner's manual thoroughly before operating the appliance and keep it handy for reference at all times.

ENGLISH

SKSLV3100S



MFL71846602
Rev.00_112523

www.signaturekitchensuite.com

Copyright © 2023 Signature Kitchen Suite. All Rights Reserved.

2

TABLE OF CONTENTS

3 IMPORTANT SAFETY INSTRUCTIONS

- 3 READ ALL INSTRUCTIONS BEFORE USE
- 3 WARNING
- 8 CAUTION

10 PRODUCT OVERVIEW

- 10 Product Features

12 OPERATION

- 12 Operating Control Panel
- 13 Changing Settings
- 14 Operating the Microwave
- 24 Operating the Oven

31 SMART FUNCTIONS

- 31 LG ThinQ Application
- 33 Smart Diagnosis™ Feature

34 MAINTENANCE

- 34 Cleaning

35 TROUBLESHOOTING

- 35 FAQs
- 37 Before Calling for Service

40 LIMITED WARRANTY

- 40 USA

IMPORTANT SAFETY INSTRUCTIONS

READ ALL INSTRUCTIONS BEFORE USE

Precautions to Avoid Possible Exposure to Excessive Microwave Energy

- (a) Do not attempt to operate this oven with the door open since open-door operation can result in harmful exposure to microwave energy. It is important not to defeat or tamper with the safety interlocks.
- (b) Do not place any object between the oven front face and the door or allow soil or cleaner residue to accumulate on sealing surfaces.
- (c) Do not operate the oven if it is damaged. It is particularly important that the oven door close properly and that there is no damage to the: (1) door (bent), (2) hinges and latches (broken or loosened), (3) door seals and sealing surfaces.
- (d) The oven should not be adjusted or repaired by anyone except properly qualified service personnel.

Safety Messages

Your safety and the safety of others are very important.

We have provided many important safety messages in this manual and on your appliance. Always read and follow all safety messages.



This is the safety alert symbol.

This symbol alerts you to potential hazards that can kill or injure you and others. All safety messages will follow the safety alert symbol and either the word **WARNING** or **CAUTION**.

These words mean:



WARNING

You may be killed or seriously injured if you do not follow instructions.



CAUTION

You may be injured or cause damage to the product if you do not follow instructions.

All safety messages will tell you what the potential hazard is, tell you how to reduce the chance of injury, and tell you what may happen if the instructions are not followed.

WARNING

WARNING

- To reduce the risk of explosion, fire, death, electric shock, injury or scalding to persons when using this product, follow basic precautions, including the following:

Technical Safety

- To reduce the risk of burns, electric shock, fire, injury to persons or exposure to excessive microwave energy when using the microwave oven, read all instructions before using the appliance.
- This appliance is not intended for use by persons (including children) with reduced physical, sensory or mental capabilities, or lack of experience and knowledge, unless they have been given supervision or instruction concerning use of the appliance by a person responsible for their safety. Children should be supervised to ensure that they do not play with the appliance.

4 IMPORTANT SAFETY INSTRUCTIONS

- Children must not be allowed to play with accessories or hang down from the door or any part of the oven. Doing so can cause serious injury and damage. As with any appliance, close supervision is necessary when used by children.
- Read and follow the **Precautions to Avoid Possible Exposure to Excessive Microwave Energy** found on **page 3**.
- Install or locate this appliance only in accordance with the provided installation instructions.
- Some products such as whole eggs and sealed containers – for example, closed glass jars – can explode and should not be heated in this oven.
- Use this appliance only for its intended use as described in the manual. Do not use corrosive chemicals or vapors, such as sulfide and chloride, in this appliance. This type of oven is specifically designed to heat, cook, or dry food. It is not designed for industrial or laboratory use.
- This appliance should be serviced only by qualified service personnel. Contact the nearest authorized service facility for examination, repair, or adjustment.
- Do not cover or block any openings on the appliance.
- Do not store this appliance outdoors. Do not use this product near water - for example, near a kitchen sink, in a wet basement, near a swimming pool, or similar location.
- To avoid electric shock:
 - This appliance must be grounded. Connect only to a properly grounded outlet. See **Grounding Instructions**.
 - Do not operate this appliance if it has a damaged cord or plug, if it is not working properly or if it has been damaged or dropped.
 - Do not immerse the electrical cord or plug in water. Keep cord away from heated surfaces.
 - Do not let cord hang over edge of table or counter.
- See door surface cleaning instructions in the **MAINTENANCE** chapter.
- To reduce the risk of fire in the oven cavity:
 - Do not overcook food. Carefully attend to the microwave oven when paper, plastic or other combustible materials are placed inside the oven to facilitate cooking.
 - Do not use the cavity for storage purposes. Do not leave paper products, cooking utensils or food in the cavity when not in use.
 - Remove wire twist-ties from paper or plastic bags before placing bags in oven.
- If materials inside the oven ignite:
 - Keep the oven door closed and turn the oven off.
 - Disconnect the power cord or shut off power at the fuse or circuit breaker panel.
- Liquids, such as water, coffee, or tea can be overheated beyond the boiling point without appearing to be boiling due to surface tension of the liquid. Visible bubbling or boiling when the container is removed from the microwave oven is not always present.
- **THIS COULD RESULT IN VERY HOT LIQUIDS SUDDENLY BOILING OVER WHEN THE CONTAINER IS DISTURBED OR A SPOON OR OTHER UTENSIL IS INSERTED INTO THE LIQUID.**

To reduce the risk of injury to persons:

 - Do not overheat the liquid. Stir the liquid both before and halfway through heating it.
 - Do not use straight-sided containers with narrow necks. Use extreme care when inserting a spoon or other utensil into the container.
 - After heating, allow the container to stand in the microwave oven for a short time before removing the container.
- Do not operate any heating or cooking appliance beneath this appliance.
- Do not mount unit over or near any portion of a heating or cooking appliance.
- Do not mount over a sink.
- Do not store anything directly on top of the appliance surface when the appliance is in operation.

Grounding Instructions

- This appliance must be grounded. Connect only to a properly grounded outlet. In the event of an electrical short circuit, grounding reduces the risk of electric shock by providing an escape wire for the electric current. This appliance is equipped with a cord having a grounding wire with a grounding plug.
- Improper use of the grounding can result in a risk of electric shock.
- A short power-supply cord is provided to reduce the risks resulting from becoming entangled in or tripping over a longer cord.
- Longer cord sets or extension cords are available and may be used if care is exercised in their use.
- Consult a qualified electrician or service technician if the grounding instructions are not completely understood, or if doubt exists as to whether the appliance is properly grounded.
- Do not use an extension cord. If the power supply cord is too short, have a qualified electrician or service technician install an outlet near the appliance.

Installation

- Never allow anyone to climb, sit, stand or hang on the oven door. Injury might result from contact with hot food or the oven itself.
- Do not line the oven walls, racks, bottom, or any other part of the oven with aluminum foil or any other material. Doing so will disrupt heat distribution, produce poor baking results and cause permanent damage to the oven interior (aluminum foil will melt to the interior surface of the oven).
- Do not use aluminum foil or any other material to line the oven bottom. Improper installation of oven liners may result in a risk of electric shock or fire.
- Make sure your appliance is properly installed and grounded by a qualified installer, according to the installation instructions. Any adjustment and service should be performed only by qualified installers or service technicians.
- Be certain that all packing materials are removed from the appliance before operating. Keep plastic, clothes, paper, and other flammable materials away from parts of the appliance that may become hot.
- The electrical power must be shut off while the electrical connections are being made.
- Improper connection of aluminum house wiring to copper leads can result in an electrical hazard or fire. Use only connectors designed for joining copper to aluminum and follow the manufacturer's recommended procedure closely.

Operation

- DO NOT TOUCH HEATING ELEMENTS OR INTERIOR SURFACES OF OVEN. Heating elements may be hot even though they are dark in color. Interior surfaces of an oven become hot enough to cause burns. During and after use, do not touch or let clothing or other flammable materials contact heating elements or interior surfaces of oven until they have had sufficient time to cool. Other surfaces, such as oven vent openings and surfaces near these openings, oven doors, and windows of oven doors, also get hot and may cause burns if not allowed to cool.
- Use care when opening door. The hot air and steam that escape can cause burns to hands, face and eyes. Let hot air or steam escape from the oven before removing or replacing food in the oven.
- Do not use plastic to cover food.
- Never attempt to dry a pet in the oven.
- Never use your appliance for warming or heating the room.
- Always use pot holders or oven mitts when removing food from the oven or the surface element. Cookware will be hot. Use only dry pot holders. Moist or damp pot holders on hot surfaces may result in burns from steam. Do not let the pot holder touch hot heating elements. Do not use a towel or other bulky cloth to remove food.
- Do not heat unopened food containers. Pressure in the containers may cause them to burst which may result in injury.

6 IMPORTANT SAFETY INSTRUCTIONS

- Do not allow aluminum foil to contact heating elements.
- Do not touch the oven racks while they are hot.
- Do not use the oven if a heating element develops a glowing spot during use or shows other signs of damage. A glowing spot indicates the heating element may fail and present a potential burn, fire, or shock hazard. Turn the oven off immediately and have the heating element replaced by a qualified service technician.
- Never allow children to remain unsupervised near the oven.
- DO NOT block the oven vent during operation. This can damage the electric parts of the oven. Air must be able to move freely.
- Do not put large, heavy items such as whole turkeys on the open oven door.
- Take care when the door is open to avoid injury.
- If the door or door seals are damaged, the oven must not be operated until it has been repaired by a competent person.
- Do not allow children to crawl into the oven.
- Do not put your hand under the controller or between the door and metal bottom trim (vent) during operation. The outside of the oven can become very hot to the touch.

Maintenance

- Do not store items of interest to children in cabinets above an oven or on the back guard of an oven. Children climbing on the oven to reach items could be seriously injured.
- Let hot cookware cool in a safe place, out of reach of small children.
- If the door glass, surface, or oven heating unit of the appliance are damaged, discontinue use of the appliance and call for service.
- Always disconnect power from the appliance before servicing.
- Never pour cold water over a hot oven for cleaning purposes.
- Oversized food or oversized metal utensils should not be inserted in a microwave/toaster oven as they may create a fire or risk of electric shock.
- Do not clean with metal scouring pads. Pieces can burn off the pad and touch electrical parts causing a risk of electric shock.
- Do not store any materials, other than manufacturer's recommended accessories, in this oven when not in use.
- Do not cover racks or any other part of the oven with metal foil. This will cause overheating of the oven.
- If your oven is dropped or damaged, have it thoroughly checked by a qualified service technician before using it.

Risk of Fire and Flammable Materials

- Do not store or use flammable material in or near the oven. Flammable materials include paper, plastic, pot holders, linens, wall coverings, curtains, and gasoline or other flammable vapors and liquids such as grease or cooking oil. These materials can be ignited when the oven is in use.
- Use extreme caution when moving or disposing of hot grease.
- Wear proper apparel. Do not wear loose-fitting or hanging garments, which may ignite if they contact hot surfaces, and cause severe burns.
- Do not use the oven for drying clothes. Only use the oven for its intended purpose.
- If cabinet storage is provided directly above the oven, use it to store items that are not frequently used and can be safely stored in an area subjected to heat. Temperatures may be unsafe for volatile items such as flammable liquids, cleaners or aerosol sprays.

- Do not use water on grease fires. Should an oven fire occur, leave the oven door closed and turn the oven off. If the fire continues, throw baking soda on the fire or use a fire extinguisher. Do not put water or flour on the fire. Flour may be explosive and water can spread a grease fire and cause personal injury.

Microwave Oven

- The oven must be installed following the provided installation instructions.
- Secure the cord in the cabinet above the oven.
- Preserve the oven floor:
 - Do not heat the oven floor excessively.
 - Do not cook anything directly on the oven floor or turntable. Use a microwavable dish.
- Do not heat any type of baby bottle or baby food. Uneven heating may occur and possibly cause personal injury.
- Do not deep-fat fry in the oven.
- Do not attempt home canning in the microwave oven.
- Do not use cylindrical-shaped containers.
- In all containers, for best results, stir the liquid several times before heating. Always stir liquid several times between reheatings.
- Place food directly on the trays when cooking unless prompted by the oven to do otherwise.

Radio/TV/Wireless Equipment Interference

- Operating the microwave oven near equipment—such as a radio, TV, wireless LAN, Bluetooth devices, medical equipment, or wireless equipment which uses the same frequency, may cause interference. This interference is not an indication of a defect in the product or its operation. The product is safe to use.
- Do not use medical equipment near the microwave oven, as the interference could affect the medical equipment's operation.
- When there is interference, it may be reduced or eliminated by taking the following measures:
 - Clean the door and the sealing surfaces of the oven.
 - Reorient the receiving antenna of the radio, TV, Bluetooth, or other equipment.
 - Relocate the microwave oven in relation to the radio, TV, Bluetooth, or other equipment.
 - Move the microwave oven away from the receiver.
 - Plug the microwave oven into a different outlet so that the microwave oven and receiver are on different branch circuits.

Federal Communications Commission Radio Frequency Interference Statement (U.S.A. Only)

- This equipment generates and uses ISM frequency energy and if not installed and used properly, that is in strict accordance with the manufacturer's instructions, may cause interference to radio and television reception. It has been type tested and found to comply with limits for ISM Equipment pursuant to part 18 of FCC Rules, which are designed to provide reasonable protection against such interference in a residential installation. However, there is no guarantee that interference will not occur in a particular installation. If this equipment does cause interference to radio or television reception, which can be determined by turning the equipment off and on, the user is encouraged to try to correct the interference by one or more of the following:
 - Reorient the receiving antenna of the radio or television.
 - Relocate the microwave oven with respect to the receiver.
 - Move the microwave oven away from the receiver.

8 IMPORTANT SAFETY INSTRUCTIONS

- Plug the microwave oven into a different outlet so that the microwave oven and the receiver are on different branch circuits.
- The manufacturer is not responsible for any radio or TV interference caused by unauthorized modification to this microwave oven. It is the responsibility of the user to correct such interference.

CAUTION

CAUTION

- To reduce the risk of minor injury to persons, malfunction, or damage to the product or property when using this product, follow basic precautions, including the following:
-

Operation

- Always heat fat slowly, and watch as it heats.
- If frying combinations of oils and fats, stir them together before heating.
- Use a deep fat thermometer, if possible, to prevent overheating fat beyond the smoking point.
- Use the least possible amount of fat for effective shallow or deep-fat frying. Filling the pan with too much fat can cause spillovers when food is added.
- Accessible parts may become hot when the broil functions are in use.
- Do not place food or cookware on the bottom of the oven cavity. Doing so will cause permanent damage to the oven bottom finish.
- When using cooking or roasting bags in the oven, follow the manufacturer's directions.
- To protect against food-borne illnesses, cook meat and poultry thoroughly. The USDA has indicated the following as safe minimum internal temperatures for consumption:
 - Ground beef: 160 °F (71 °C)
 - Poultry: 165 °F (74 °C)
 - Beef, veal, pork, or lamb: 145 °F (68 °C)
 - Fish/seafood: 145 °F (68 °C)
- Do not use this oven for commercial purposes. It is made for household use only.
- The door or the outer surface may get hot when the appliance is operating.
- Do not use this oven for purposes other than cooking.
- Use caution if opening the door when the oven is operating. Hot surfaces can cause serious burns.

Maintenance

- Do not repair or replace any part of the appliance unless specifically recommended in the manual. All other servicing should be performed by a qualified technician.
- Do not use harsh etching, abrasive cleaners or sharp metal scrapers to clean the oven door glass since they can scratch the surface. Scratches may cause the glass to shatter.
- Make sure oven lights are cool before cleaning.
- Do not clean the door gasket. The door gasket is essential for a good seal. Care should be taken not to rub, damage, or move the gasket.
- Do not rinse trays and racks by placing them in water just after cooking. This may cause breakage or damage.
- The oven should be cleaned regularly and any food deposits should be removed. Failure to maintain the oven in a clean condition could lead to deterioration of the surface that could shorten the life of the appliance and possibly result in a hazardous situation.

IMPORTANT SAFETY INSTRUCTIONS 9

- Do not touch heating elements or interior surfaces of microwave oven.
 - During and after use or cleaning the interior, do not touch other flammable materials contact heating elements or interior surfaces of microwave oven until they have had sufficient time to cool. Other surfaces, such as windows of microwave oven door, oven lamp , also get hot and may cause burns if not allowed to cool.
- When cleaning, turn off the oven light and then clean.

ENGLISH

SAVE THESE INSTRUCTIONS

10 PRODUCT OVERVIEW

PRODUCT OVERVIEW

Product Features

The appearance and specifications listed in this manual may vary due to constant product improvements.

Exterior / Interior

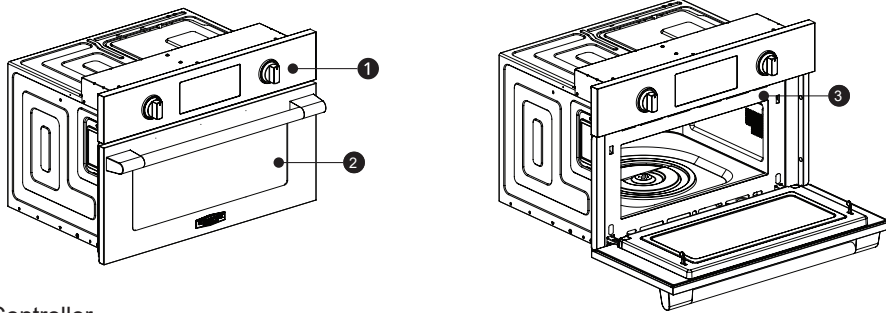

- 1 Oven Controller
- 2 Oven Door
- 3 Model & Serial Number Plate, Cooking Guide

Accessories

The turntable rotates in both directions to help food cook more evenly. Do not operate the microwave oven without the glass tray in place. The shaft, rotating ring and either the metal or glass tray must always be in place when using the oven.

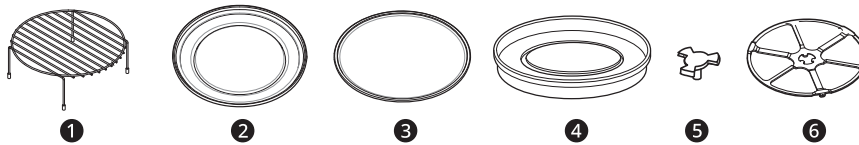



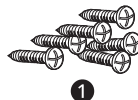

- 1 Rack (For the Convection Bake, Broil and Speed Conv. and Speed Broil functions)
- 2 Metal Tray (For the Convection Bake, Speed Conv. and Speed Broil functions)
- 3 Glass Tray (For the Microwave and Defrost function)
- 4 Air Fry Pan (For the Air Fry function)
- 5 Shaft
- 6 Rotating Ring

Accessories for Installation



- 1 Wood Screws - Silver (4X14) (6ea, 4 needed for installation and 2 extras)

How to Use Accessories

				
Microwave Sensor Cook, Popcorn, Potato, Vegetable, Defrost, Soften, Melt, Simmer	○	△	-	-
Conv. Bake Dehydrate, Warm, Proof	-	○	△	-
Broil	-	△	○	-
Speed Cook Speed Conv, Speed Broil	-	○	-	-
Air Fry	-	-	-	○

○: Recommended method

△: Alternative method

-: Do not use

NOTE

- Contact LG Customer Service at 1-800-243-0000 if any accessories are missing.
- For your safety and for extended product life, only use authorized components.
- The manufacturer is not responsible for product malfunction or accidents caused by the use of separately purchased, unauthorized components or parts.
- The images in this guide may be different from the actual components and accessories, which are subject to change by the manufacturer without prior notice for product improvement purposes.
- Do not operate the oven when it is empty except when preheating. Never operate the microwave while the oven is empty.

Specifications

MZBZ1715* Model

- **Power Supply:** 120 V AC, 60 Hz
- **Rated Current**
 - Microwave: 14.0 A (Max 16.0 A)
 - Conv. Bake: 13.5 A
 - Broil: 11.0 A
 - Air Fry: 14.0 A
- **Rated Power Input**
 - Microwave: 1650 W (Max 1900 W)
 - Conv. Bake: 1600 W
 - Broil: 1300 W
 - Air Fry: 1650 W
- **Rated Output**
 - Microwave: 975 W

- **Exterior Dimensions (W x H x D):**
29 3/4" x 20 1/8" x 23 3/16"
755.0 x 510.4 x 588.7 (mm)
- **Interior Dimensions (W x H x D):**
20 3/4" x 8 3/8" x 17 5/16"
526.6 x 212.3 x 439.6 (mm)
- **Oven Capacity:** 1.7 cu.ft

OPERATION

Operating Control Panel

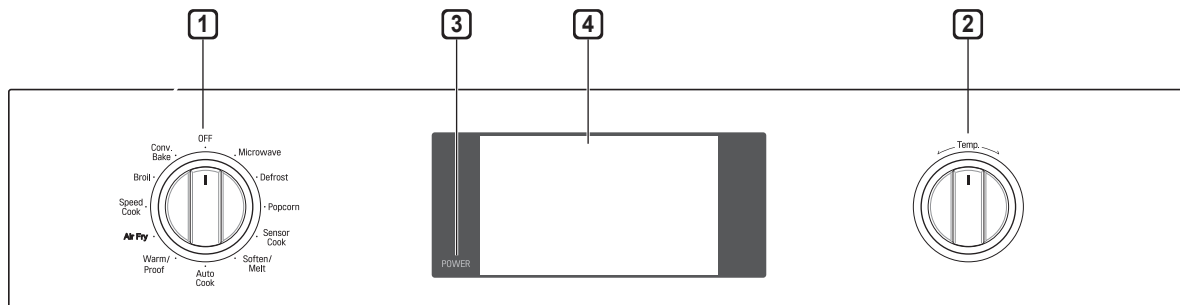

- 1** Oven Mode Knob
- 2** Temp Knob
- 3** LCD Display On/Off
- 4** LCD Touchscreen for Oven

Display Icons

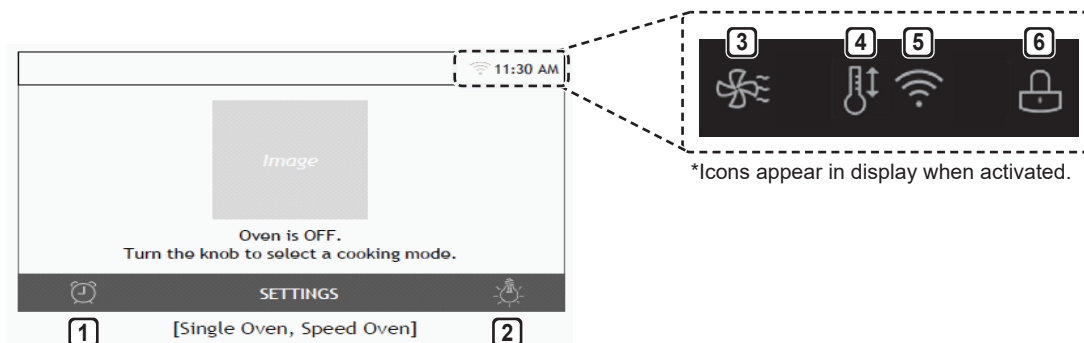

*Icons appear in display when activated.

- 1** **Lamp Icon**
Touch to turn light on/off
- 2** **Timer Icon**
Touch to set a timer
- 3** **Oven Cooling Icon**
Appears during or after oven operation to indicate cooling fan is running in oven
- 4** **Auto Conversion Icon**
Appears when Convection Auto Conversion is turned on
- 5** **Wi-Fi Icon**
 - Appears when range is connected to Wi-Fi
 - Appears when range is disconnected from Wi-Fi or is not registered
- 6** **Lock Icon**
Appears when Lockout is on

Energy Saving Tips

- For optimal performance and energy savings, follow the guides for proper use of accessories.
- Avoid opening the oven door more than necessary during use. This helps the oven maintain temperature, prevents unnecessary heat loss, and saves on energy use.

Changing Settings

Clock

The clock must be set to the correct time of day in order for the automatic oven timing functions to work properly.

- 1 Press **Clock**.
- 2 Press the numbers to enter the time. For example, to set the clock for 10:30, press the numbers: **1**, **0**, **3** and **0**.
- 3 Press **START**.

NOTE

- To check the time of day when the display is showing other information, press **Clock**.

Settings

Press the **Settings** button repeatedly to toggle through and change oven settings.

The **Settings** button allows you to:

- set the clock mode (12 or 24 hours)
- adjust the beeper volume
- set the clock on/off
- adjust the scroll speed

Setting the Clock Mode

The control is set to use a 12-hour clock. To reset the clock to 24-hour mode, follow the steps below.

- 1 Press **Settings**.
- 2 Press **1** to set the clock mode.
- 3 Press **1** to select a 12-hour clock, or **2** to select a 24-hour clock.

Adjusting the Beeper Volume

- 1 Press **Settings**.
- 2 Press **2** to adjust the beeper volume.

- 3 Press **1** for Loud, **2** for Low, and **3** for Mute.

Setting the Clock On/Off

- 1 Press **Settings**.
- 2 Press **3** to set the clock on/off.
- 3 Press **1** for Clock On, and **2** for Clock Off.

Adjusting the Scroll Speed

- 1 Press **Settings**.
- 2 Press **4** to adjust the scroll speed.
- 3 Press **1** for Slow, **2** for Normal, and **3** for Fast.

Timer On/Off

The Timer On/Off serves as an extra timer in the kitchen that beeps when the set time has run out. It does not start or stop cooking.

The Timer On/Off feature can be used during any of the other oven control functions.

The Timer can be set for any time from 1 second to 99 minutes and 59 seconds.

Setting the Timer

- 1 Press **Timer On/Off** once.
- 2 Press number keys to set the cook time.
- 3 Press **Timer On/Off** to start the Timer. The remaining time countdown appears in the display.
- 4 When the set time runs out, **END** shows in the display. The indicator tones sound every 15 seconds until **Timer On/Off** is pressed.

NOTE

- If the remaining time is not in the display, recall the remaining time by pressing **Timer On/Off**.

14 OPERATION

Canceling the Timer

- 1 Press **Timer On/Off** once.
The display returns to the time of day.

Control Lock

The Control Lock prevents most oven controls from operating. It does not disable the clock or the interior oven light.

- 1 Press and hold **CLEAR/OFF** for three seconds.
- 2 **LOCKED** appears in the display.
- 3 To deactivate the Control Lock, Press and hold **CLEAR/OFF** for three seconds.

Wi-Fi

Connect the appliance to a home Wi-Fi network to use the smart functions. See the **SMART FUNCTIONS** for more details.

Setting Up Wi-Fi

- 1 Press and hold **Wi-Fi** for 3 seconds. The Wi-Fi icon  appears at the top of the display.
- 2 Follow the instructions in the **LG ThinQ** application.

NOTE

- The Wi-Fi icon on the display shows the status of the appliance's network connection. If the Wi-Fi icon is not shown, use the smart phone app to select the Wi-Fi network or connect the product again.

Operating the Microwave

Before Using

WARNING

- To avoid risk of personal injury or property damage, do not use stoneware, metal cookware, or metal rimmed cookware in the oven.

- Do not use your microwave oven to cook eggs in the shell. Pressure can build up inside the shell, causing it to burst.
- Never operate the oven when it is empty. Food or water should always be in the oven during operation to absorb the microwave energy.
- Do not use the oven to dry newspapers or clothes. They may catch fire.

NOTE

- If you wait longer than 5 minutes after closing the oven door to press **START**, the display shows **INSERT FOOD**. Open and close the door to operate the oven.
- Press the center of each key firmly since the areas between the keys will not activate the oven. A tone will sound each time a key is pressed correctly. Don't press several keys at once.
- Do not strike the control panel with silverware, cookware, etc. It may be damaged or broken.
- Always be careful when taking cookware out of the oven. Some dishes absorb heat from the cooked food and may be hot. See the **Cookware Guide** section for more information.
- To avoid breakage, do not rinse containers or the glass turntable in water while they are hot.
- Always allow the turntable to cool before removing it from the oven.
- The turntable must always be in place when you operate the oven.

Microwave Cookware Guide

Microwave-Safe Cookware

Use microwavable cookware.

WARNING

- Do not permit children to use plastic cookware without complete supervision.
- **Ovenproof Glass**
 - Ovenproof glassware that is treated for high intensity heat so it is heat-resistant is microwave-safe.
 - Use utility dishes, loaf dishes, pie plates, cake plates, liquid measuring cups, casseroles and bowls without metal rims.

- Do not use delicate glassware, such as tumblers or wine glasses, as these might shatter when heated.
- **China**
 - Use bowls, cups, serving plates, pottery, stoneware, ceramics, and platters without metal rims or handles. Many containers made of these materials are microwave-safe, but test them before use.
- **Plastic**
 - **Plastic Storage Containers:** Use plastic dishes, cups, semi-rigid freezer containers and plastic bags only for short cooking times. Do not use them when cooking food for long periods or at high power levels, as the hot food will eventually warp or melt the plastic.
 - **Plastic wrap (as a cover):** Lay the plastic wrap loosely over the dish and press it to the sides. Vent plastic wrap by turning back one edge slightly to allow excess steam to escape. The dish should be deep enough so that the plastic wrap will not touch the food. As the food heats it may melt the plastic wrap wherever the wrap touches the food.
 - **Plastic Cooking Bags:** Provided they are specially made for cooking, cooking bags are microwave safe. Remember to make a slit in the bag so that steam can escape. Never use ordinary plastic bags for cooking in the microwave oven, as they will melt and rupture.
 - **Plastic Microwave Cookware:** A variety of shapes and sizes of microwave cookware are available. You may be able to use items you already have on hand rather than investing in new kitchen equipment.
- **Paper**
 - Use paper towels, waxed paper, paper napkins, and paper plates with no metal rims or design. Look for the manufacturer's label for use in the microwave oven.
 - Paper plates and containers are convenient and safe to use in the microwave oven, provided that the cooking time is short and foods to be cooked are low in fat and moisture. Paper towels are also very useful for wrapping foods and for lining baking trays in which greasy foods such as bacon are cooked.
 - Avoid colored paper products as the color may run. Do not use recycled paper products in the microwave oven. They may contain impurities which could cause arcing or fires when used in the microwave.

• **Tableware**

- Do not put plates with painted decoration in the oven, as the paint may contain metal and cause arcing.

Microwave-Unsafe Cookware

• **Metal Containers/Metal Decoration**

- Never use metal or metal-rimmed cookware in the microwave oven.
- Microwaves cannot penetrate metal. They will bounce off any metal object in the oven and cause arcing, an alarming phenomenon that resembles lightning.
- Metal shields the food from microwave energy and produces uneven cooking. Also avoid metal skewers, thermometers, foil trays, metal-rimmed or metal-banded dinnerware, casserole dishes, etc. The metal rim interferes with normal cooking and may damage the oven.

• **Aluminum Foil**

- Avoid large sheets of aluminum foil because they hinder cooking and may cause harmful arcing.
- Use small pieces of foil to shield poultry legs and wings.
- Keep ALL aluminum foil at least 1" (2.54 cm) from the side walls and door of the oven.

• **Wood**

- Wood bowls and boards will dry out and may split or crack when you use them in the microwave oven.
- Baskets react in the same way.

• **Tightly Covered Cookware**

- Be sure to leave openings for steam to escape from covered containers.
- Pierce plastic pouches of vegetables or other food items before cooking.
- Tightly closed pouches could explode.

• **Brown Paper**

- Avoid using brown paper bags.
- They absorb too much heat and could burn.

• **Flawed or Chipped Cookware:**

- Any container that is cracked, flawed, or chipped may break in the oven.

• **Metal Twist Ties**

- Remove metal twist ties from plastic or paper bags.
- They become hot and could cause a fire.

16 OPERATION

Cooking Tips

Carefully monitor the food in the microwave oven while it is cooking. Directions given in recipes to elevate, stir, etc., are the minimum steps recommended. If food is overcooked (dry), undercooked, or unevenly cooked, make adjustments before or during cooking to correct the problem.

• Overcooked or Dry Food

- **Sprinkling:** Sprinkle low-moisture foods such as roasts and vegetables with water before cooking, or cover them to retain moisture.
- **Density:** Light, porous food such as cakes and breads cook more quickly than heavy, dense foods such as roasts and casseroles.
- **Shielding:** Cover the corners of square dishes with small strips of aluminum foil to prevent overcooking. Don't use too much foil, and secure the foil to the dish. Foil can cause arcing if it gets too close to the oven walls during cooking.
- **Bones and Fat:** Bones conduct heat, and fat cooks more quickly than meat. Take care with bony or fatty cuts of meat.

• Undercooked Food

- **Covering:** Cover food with a microwave-safe lid, parchment paper (not waxed paper), or plastic wrap to trap heat and steam and cook food more quickly.
- **Standing Time:** Let food stand for several minutes after it is removed from the oven to allow it to finish cooking and help flavors blend and develop.
- **Quantity:** The more food you place in the oven, the longer the required cooking time.
- **Temperature:** Ice-cold ingredients take much longer to cook than room temperature ingredients.

• Unevenly Cooked Food

- **Stirring:** Stir food from the outside toward the center during cooking, as food at the outside of the dish heats more quickly.
- **Arranging:** Turn food over several times during cooking. The upper portions of thick foods cook more quickly than the lower portions. Thick or dense foods can be elevated so that microwaves can be absorbed by the underside and center of the foods.
- **Shaping:** Place the thickest portions of foods like meat, poultry or fish toward the outside of the cookware to help them cook more evenly. If possible, shape foods into thin rounds or rings.

• Foods with Skin, Shell or Membrane

- **Skin or Membrane:** Pierce the outsides of foods like potatoes, sausages, or egg whites or yolks before cooking.
- **Shell:** Pierce or remove the shells from eggs, clams, oysters, or other shelled foods before cooking.

• Testing if Cooked

- Microwaves cook food quickly, so test food for doneness frequently. Some foods are left in the microwave until completely cooked, but most foods, including meats and poultry, should be removed from the oven while still slightly undercooked and allowed to finish cooking during standing time. The internal temperature of foods will rise between 5 °F (3 °C) and 15 °F (8 °C) during standing time.

• Defrosting Tips

- Remove fish, shellfish, meat, and poultry from their original wrapping paper or plastic package. Otherwise, the wrap close to the food will hold steam and heat, which can cause the outer surface of the food to be cooked.
- Remove any metal twist ties.
- Always slit or pierce plastic pouches or packaging.
- Open containers such as cartons before they are placed in the oven.
- If food is foil wrapped, remove the foil and place the food in a suitable container.
- The length of defrosting time varies depending on the shape of the food and on how solidly the food is frozen.
- As food begins to defrost, separate the food into pieces so that they can defrost more easily.
- Turn over food during defrosting or standing time. Separate into pieces and remove food as required.
- Let food stand after defrosting. Food should still be somewhat icy in the center when removed from the oven.
- When using Defrost, the weight to be entered is the net weight in pounds and tenths of pounds (the weight of the food minus the container).
- Slit the skins of frozen food such as sausage.
- Bend plastic pouches of food to ensure even defrosting.
- Place food in a shallow container or in a microwave roasting dish to catch the drippings.

- Always underestimate defrosting time. Food should still be somewhat icy in the center when removed from the oven. If defrosted food is still frozen solid in the center, return it to the upper oven for more defrosting.
- Depending on the shape of the food, some areas may defrost more quickly than others.
- The shape of the package affects how quickly food will defrost. Shallow packages will defrost more quickly than a deep block.
- For best results, shape ground meat into the form of a doughnut before freezing. When defrosting, scrape off thawed meat when the beep sounds and continue defrosting.
- Use small pieces of aluminum foil to shield parts of food such as chicken wings, leg tips, fish tails, or areas that start to get warm. Make sure the foil does not touch the sides, top, or bottom of the oven. The foil can damage the oven lining.

Microwave Power Levels

This microwave oven is equipped with 10 power levels to give you maximum flexibility and control over cooking.

Power Level	Use
10 (100%)	<ul style="list-style-type: none"> • Boiling water • Browning ground beef • Making candy • Cooking whole poultry, poultry pieces, fish & vegetables • Cooking tender cuts of meat
9 (90%)	<ul style="list-style-type: none"> • Reheating rice, pasta & vegetables
8 (80%)	<ul style="list-style-type: none"> • Reheating prepared foods quickly • Reheating sandwiches
7 (70%)	<ul style="list-style-type: none"> • Cooking egg, milk and cheese dishes • Cooking cakes and breads • Melting chocolate
6 (60%)	<ul style="list-style-type: none"> • Cooking veal • Cooking whole fish • Cooking puddings and custard
5 (50%)	<ul style="list-style-type: none"> • Cooking ham, whole poultry and lamb • Cooking rib roast and sirloin tip

Power Level	Use
4 (40%)	<ul style="list-style-type: none"> • Thawing meat, poultry and seafood
3 (30%)	<ul style="list-style-type: none"> • Cooking less tender cuts of meat
2 (20%)	<ul style="list-style-type: none"> • Taking chill out of fruit • Softening butter
1 (10%)	<ul style="list-style-type: none"> • Keeping casseroles and main dishes warm • Softening butter and cream cheese
0 (0%)	<ul style="list-style-type: none"> • Standing time

Microwave Mode

Express Cook

Press a number key from 1 through 6 to immediately start the Microwave function at High power for the selected number of minutes.

- 1 Press a number key from **1** through **6** to start cooking. For example, press **2** to cook for 2 minutes.
 - When the cook time is over a melody sounds and **COOK END** displays.

Cooking at High Power Level

If the power level is not set, the Microwave function defaults to High power.

- 1 Press **Microwave**.
- 2 Press number keys to set the cook time.
- 3 Press **START** to start cooking.
 - When the cook time is over a melody sounds and **COOK END** displays.

Cooking at Lower Power Levels

High power cooking does not always give the best results with foods that need slower cooking, such as roasts, baked goods, or custards. The oven has 9 power settings in addition to HIGH.

- 1 Press **Microwave**.

18 OPERATION

- 2 Press number keys to set the cook time.
- 3 Press Power Level followed by a number key to set the power level.
- 4 Press **START** to start cooking.
 - When the cook time is over a melody sounds and **COOK END** displays.

Sensor Cook Mode

About Features

This function reheats favorite foods without requiring you to select cooking times and power levels. The oven automatically determines the required cooking time for each food item. When the internal sensor detects a certain amount of humidity coming from the food, it tells the oven how much longer to heat.

The display shows the remaining heating time. For best results when sensor cooking, follow these recommendations.

- Food should be at normal storage temperature.
- The glass tray and the outside of the container should be dry.
- Do not open the door or press **CLEAR/OFF** during the sensing time. When the sensing time is over, the oven beeps and the remaining cooking time will appear in the display window. At this time you can open the door to stir, turn, or rearrange the food.

Appropriate containers and coverings help assure good sensor cooking results.

- Always use microwavable containers and cover them loosely with lids or vented plastic wrap.
- Never use tight-sealing plastic covers. They can prevent steam from escaping and cause food to overcook.
- Match the amount of food to the size of the container. Fill containers at least half full for best results.
- Be sure the outside of the cooking container and the inside of the upper oven are dry before placing food in the oven. Beads of moisture turning into steam can mislead the sensor.

Setting the Sensor Cook Function

Example: To cook rice

- 1 Press **Sensor Cook**.
- 2 Press **7** to select rice from the menu. The Sensor Cook function starts.
 - When the cook time is over a melody sounds and **COOK END** displays.

Sensor Cook Menu

Refer to the information below to set the desired menu item and see the recommended amounts.

- **1 Beverage** (1 - 2 cups[†])
 - Cookware: Mug or microwave-safe cup on the glass tray
 - Food temperature: Room
 - Instructions: Use microwave safe mug or cup without covering. After heating, stir to complete reheating.
- **2 Casserole** (10 - 20 oz)
 - Cookware: Microwave-safe bowl on the glass tray
 - Food temperature: Refrigerated
 - Instructions: Use microwave safe bowl. Cover food with vented plastic wrap and place in oven. After heating, let stand for 3 minutes.
- **3 Chicken** (16 - 20 oz)
 - Cookware: Microwave-safe bowl on the glass tray
 - Food temperature: Refrigerated
 - Instructions: Use microwave safe bowl. Cover food with vented plastic wrap and place in oven. After heating, let stand for 3 minutes.
- **4 Pasta** (½ - 2 cups[†])
 - Cookware: Microwave-safe bowl on the glass tray
 - Food temperature: Refrigerated (precooked)
 - Instructions: Use microwave safe bowl. Cover food with vented plastic wrap and place in oven. After heating, let stand for 3 minutes.
- **5 Pizza** (1 - 3 slices)
 - Cookware: Microwave-safe bowl on the glass tray
 - Food temperature: Refrigerated
 - Instructions: This is a reheat function for leftover pizza. Use microwave safe plate without covering.

- **6 Plate of food** (1 serving)
 - Cookware: Microwave-safe bowl on the glass tray
 - Food temperature: Refrigerated
 - Instructions: Use microwave safe bowl. Cover food with lid or vented plastic wrap and place in oven. After heating, let stand for 3 minutes.
- **7 Rice** (½ - 2 cups[†])
 - Cookware: Microwave-safe bowl on the glass tray
 - Food temperature: Refrigerated (precooked)
 - Instructions: Use microwave safe bowl. Cover food with vented plastic wrap and place in oven. After heating, let stand for 3 minutes.
- **8 Soup** (1 - 4 cups[†])
 - Cookware: Microwave-safe bowl on the glass tray
 - Food temperature: Room
 - Instructions: Use microwave safe bowl. Cover food with vented plastic wrap and place in oven. After heating, let stand for 3 minutes.

walls as it rotates. Fold the ends of the bag up and toward the center of the bag.



- Prepare only one bag at a time.
- Do not use popcorn popping devices in microwave oven with this feature.
- Do not leave the oven unattended while cooking popcorn.
- Do not use the **Popcorn** key pad in combination with any other feature key pads.
- Do not attempt to reheat or cook any unpopped kernels.
- Do not reuse the bag. Overcooking can result in an oven fire.

⚠ WARNING

- Be careful when handling the container. Microwave heating of beverages can result in delayed eruptive boiling. Therefore, care must be taken when handling the container.

† 8 oz (240 ml)/cup

Popcorn Mode

This function is for cooking prepackaged popcorn.

Setting the Popcorn Function

- 1** Press **Popcorn**. The Popcorn function starts.
- 2** Press **CLEAR/OFF** to cancel Popcorn at any time.

⚠ CAUTION

- Never use a brown paper bag for popping corn or attempt to pop leftover kernels.

NOTE

- When popping prepackaged popcorn, place the bag carefully in the oven so it does not touch the

Potato Mode

Setting the Potato Function

- 1** Press **Potato**. The Potato function starts.
 - 2** Press **CLEAR/OFF** to cancel Potato at any time.
- **Potato** (1 - 4 ea)
 - Cookware: Paper towel on the glass tray
 - Food temperature: Room
 - Instructions: Pierce skin with a fork and place on paper towel on the glass tray. Do not cover. After cooking, let stand for 5 minutes.

Vegetable Mode

Setting the Vegetable Function

- 1** Press **Vegetable**. Press a number to enter a category from the menu below. The Vegetable function starts.
- 2** Press **CLEAR/OFF** to cancel Vegetable at any time.

20 OPERATION

Vegetable Menu

- **1 Canned vegetable** (1 - 4 cups)
 - Cookware: Microwave-safe bowl on the glass tray
 - Food temperature: Room
 - Instructions: Cover with vented plastic wrap. Stir thoroughly after cooking.
- **2 Fresh vegetable** (1 - 4 cups)
 - Cookware: Microwave-safe bowl on the glass tray
 - Food temperature: Refrigerated
 - Soft vegetables only : Cauliflower, Broccoli, Spinach etc.
 - Instructions: Add water (1 - 2 cups: 2 tbsp water, 3 - 4 cups: 4 tbsp water). Cover with vented plastic wrap. After cooking, let stand for 3 minutes.
- **3 Frozen vegetable** (1 - 4 cups)
 - Cookware: Microwave-safe bowl on the glass tray
 - Food temperature: Frozen
 - Instructions: Add water (1 - 2 cups: 2 tbsp water, 3 - 4 cups: 4 tbsp water). Cover with vented plastic wrap. After cooking, let stand for 3 minutes.

Defrost Mode

The oven has 4 preset defrost modes. The Defrost Menu shows the suggested defrost mode for various foods. This defrost function conveniently chimes during the mode to remind you to check, turn over, separate, or rearrange the food.

- **1:** Meat
- **2:** Poultry
- **3:** Fish
- **4:** Bread

Setting the Defrost Function

Example: To defrost 1.2 pounds of meat

- 1** Press **Defrost**.
- 2** Press **1** to select Meat.
- 3** Set the weight: Press **1, 2.** (for 1.2 lbs)

- 4** Press **START** to start defrosting.
- 5** When the oven beeps, turn food over and press **START**.
- 6** When defrosting is complete, press **CLEAR/OFF**.

NOTE

- The countdown appears in the display after **START** is pressed. The oven chimes once during the defrost cycle.
- At the chime, open the oven door and turn the food over. Remove any food that has thawed. Return the still frozen items to the oven and press **START** to complete the defrost cycle.

Weight Conversion Table

Most food weights are given in pounds and ounces. If using pounds, food weights must be converted to pounds and tenths of pounds (decimals).

Use the following table if necessary to convert food weights to decimals.

Ounces	Decimal Weight
1.6	0.1
3.2	0.2
4.8	0.3
6.4	0.4
8.0	0.5 (One-half pound)
9.6	0.6
11.2	0.7
12.8	0.8
14.4	0.9
16.0	1.0 (One pound)

Defrost Menu

Refer to the information below to set the desired code and weight.

Meat (0.1 - 6.0 lbs)

- Beef: Ground beef, round steak, stew cubes, tenderloin steak, pot roast, rib roast, rump roast, chuck roast, hamburger patties

- Lamb: Chops, rolled roast
- Pork: Chops, hot dogs, spareribs, country-style ribs, rolled roast, sausage
- Veal: Cutlets (1 lb., ½ inch thick)
- Turn food over when the oven beeps.
- Standing time: 5-15 minutes

Poultry (0.1 - 6.0 lbs)

- Poultry: Whole, cut-up, breast (boneless)
- Cornish Hens: Whole
- Turkey: Breast
- Rinse chicken with tap water and let stand for 60 minutes after defrosting for better results.
- Turn food over when the oven beeps.
- Standing time: 60 minutes

Fish (0.1 - 4.0 lbs)

- Fish: Fillets, whole steaks
- Shellfish: Crab meat, lobster tails, shrimp, scallops
- Turn food over when the oven beeps.
- Standing time: 5-10 minutes

Bread (0.1 - 2.0 lbs)

- Sliced bread, buns, baguettes, etc.
- Separate slices and place between paper towels or on flat plate. Turn food over when the oven beeps.
- Standing time: 1-2 minutes

Soften Mode

The oven uses low power to soften foods such as butter, cream cheese, frosting, and ice cream. See the following menu for details.

Setting the Soften Function

Example: 8 oz of cream cheese

- 1 Press **Soften**.
- 2 Select from the menu: Press **2** to select cream cheese and press **START**.
- 3 Set the weight: Press **2** to select 8 oz.

4 Press **START**.

- When the cook time is over a melody sounds and **COOK END** displays.

Soften Menu

- **1 Butter** (½, 1, 2 sticks)
 - Cookware: Microwave-safe dish on the glass tray
 - Food temperature: Refrigerated
 - Instructions: Unwrap and place food in oven. Butter will be at room temperature and ready for use in a recipe.
- **2 Cream cheese** (3, 8 oz)
 - Cookware: Microwave-safe dish on the glass tray
 - Food temperature: Refrigerated
 - Instructions: Unwrap and place food in oven. Cream cheese will be at room temperature and ready for use in a recipe.
- **3 Frosting** (16 oz)
 - Cookware: Microwave-safe bowl on the glass tray
 - Food temperature: Refrigerated
 - Instructions: Unwrap and place food in oven. Frosting will be at room temperature and ready for use in a recipe.
- **4 Ice cream** (1 pint, 1 quart)
 - Cookware: Glass tray
 - Food temperature: Frozen
 - Instructions: Remove lid and cover. Place food in oven. Ice cream will be soft enough to make scooping easier.

Melt Mode

The oven uses low power to melt foods such as butter, caramel, cheese, chocolate, and marshmallows. See the following menu for details.

Setting the Melt Function

Example: 8 oz of Chocolate

- 1 Press **Melt**.
- 2 Select from the menu: Press **4** to select chocolate and press **START**.

22 OPERATION

3 Set the weight: Press **2** to select 8 oz.

4 Press **START**.

- When the cook time is over a melody sounds and **COOK END** displays.

Melt Menu

- **1 Butter** (½, 1, 2 sticks)
 - Cookware: Microwave-safe bowl on the glass tray
 - Food temperature: Refrigerated
 - Instructions: Unwrap and place food in oven. After heating, stir to complete melting.
- **2 Caramel** (4, 8, 12 oz)
 - Cookware: Microwave-safe bowl on the glass tray
 - Food temperature: Room
 - Instructions: Unwrap and place food in oven. After heating, stir to complete melting.
- **3 Cheese** (4, 8, 12 oz)
 - Cookware: Microwave-safe bowl on the glass tray
 - Food temperature: Refrigerated
 - Instructions: Use processed cheese food only. Unwrap and cut into cubes. Place food in oven. After heating, stir to complete melting.
- **4 Chocolate** (4, 8, 12 oz)
 - Cookware: Microwave-safe bowl on the glass tray
 - Food temperature: Room
 - Instructions: Chocolate chips or squares of baking chocolate may be used. Unwrap and place food in oven. After heating, stir to complete melting.
- **5 Marshmallow** (5, 10 oz)
 - Cookware: Microwave-safe bowl on the glass tray
 - Food temperature: Room
 - Instructions: Unwrap and place food in oven. After heating, stir to complete melting.

More Modes

The product firmware may be updated to include additional functions through More Modes.

The currently available options include the Simmer function. The Simmer function provides precise cooking performance for foods that require low heat for a long cooking time.

⚠ CAUTION

- Wear oven mitts and use care when removing the cookware from the oven. Cookware will be hot, and the hot water can spill and cause scalding or burns.

Setting the Simmer Function

Example: 9 oz of Macaroni

- 1** Press **More Modes** and **1**.
- 2** Press **5** and **START** to select Macaroni.
- 3** Press **3** to select 9 oz.
- 4** Press **START**.
 - When the oven beeps, carefully remove the bowl from the oven and add the rice or pasta. Loosely cover with a lid or plastic wrap and carefully place the bowl back in the oven. Press **START**.
 - When the cook time is over a melody sounds and **COOK END** displays.
- 5** Press **CLEAR/OFF** to cancel at any time or when cooking is complete.

Simmer Menu

- **1 Rice** (1, 2, 3 servings)
 - Cookware: Microwave-safe bowl† on the glass tray
 - Food temperature: Room
 - 1 serving (water: ¾ cup/200 g, rice: 3 oz/85 g)
 - 2 servings (water: 1-¼ cups/300 g, rice: 6 oz/170 g)
 - 3 servings ((water: 1-¾ cups/425 g, rice: 9 oz/250 g)
 - Instructions: Add the desired amount of water to a microwave-safe bowl and place in the oven. Press **More Modes** and **1** to select Simmer. Press **1** to select Rice. Then press numbers to enter the weight. Press **START** to start cooking. When the oven beeps, carefully remove the bowl from the oven and add the rice. Loosely cover with a lid or plastic wrap and carefully place the bowl back in the oven.

Press **START**. After cooking, carefully remove the bowl from oven. Stir rice, cover and allow to rest for 5-10 minutes if needed. After standing time, drain water if needed.

NOTE

- The amount of water and time may vary depending on the type of rice used. The preset times are designed for standard long grain rice.

• 2 Farfalle (1, 2, 3, 4 servings)

- Cookware: Microwave-safe bowl† on the glass tray
- Food temperature: Room
- 1 serving (water 4-1/4 cups/1 L, farfalle 3 oz/85 g)
2 servings (water 4-1/4 cups/1 L, farfalle 6 oz/170 g)
3 servings (water 6-1/3 cups/1.5 L, farfalle 9 oz/255 g)
4 servings (water 6-1/3 cups/1.5 L, farfalle 12 oz/340 g)
- Instructions: Add the desired amount of water to a microwave-safe bowl and place in the oven. Press **More Modes** and **1** to select Simmer. Press **2** to select Farfalle. Then press numbers to enter the weight. Press **START** to start cooking. When the oven beeps, carefully remove the bowl from the oven and add the pasta. Loosely cover with a lid or plastic wrap and carefully place the bowl back in the oven. Press **START**.

• 3 Fusilli (1, 2, 3, 4 servings)

- Cookware: Microwave-safe bowl† on the glass tray
- Food temperature: Room
- 1 serving (water 4-1/4 cups/1 L, fusilli 3 oz/85 g)
2 servings (water 4-1/4 cups/1 L, fusilli 6 oz/170 g)
3 servings (water 6-1/3 cups/1.5 L, fusilli 9 oz/255 g)
4 servings (water 6-1/3 cups/1.5 L, fusilli 12 oz/340 g)
- Instructions: Follow instructions for cooking Farfalle, but after selecting Simmer press **3** and **START** to select Fusilli.

• 4 Lasagna (1, 2, 3 servings)

- Cookware: Microwave-safe bowl† on the glass tray
- Food temperature: Room

- 1 serving (water 4-1/4 cups/1 L, lasagna 3 oz/85 g)
2 servings (water 4-1/4 cups/1 L, lasagna 6 oz/170 g)
3 servings (water 6-1/3 cups/1.5 L, lasagna 9 oz/255 g)
- Instructions: Follow instructions for cooking Farfalle, but after selecting Simmer press **4** and **START** to select Lasagna. Stir twice in the middle of cooking.

• 5 Macaroni (1, 2, 3, 4 servings)

- Cookware: Microwave-safe bowl† on the glass tray
- Food temperature: Room
- 1 serving (water 4-1/4 cups/1 L, macaroni 3 oz/85 g)
2 servings (water 4-1/4 cups/1 L, macaroni 6 oz/170 g)
3 servings (water 6-1/3 cups/1.5 L, macaroni 9 oz/255 g)
4 servings (water 6-1/3 cups/1.5 L, macaroni 12 oz/340 g)
- Instructions: Follow instructions for cooking Farfalle, but after selecting Simmer press **5** and **START** to select Macaroni.

• 6 Penne (1, 2, 3, 4 servings)

- Cookware: Microwave-safe bowl† on the glass tray
- Food temperature: Room
- 1 serving (water 4-1/4 cups/1 L, penne 3 oz/85 g)
2 servings (water 4-1/4 cups/1 L, penne 6 oz/170 g)
3 servings (water 6-1/3 cups/1.5 L, penne 9 oz/255 g)
4 servings (water 6-1/3 cups/1.5 L, penne 12 oz/340 g)
- Instructions: Follow instructions for cooking Farfalle, but after selecting Simmer press **6** and **START** to select Penne. Stir twice in the middle of cooking.

• 7 Spaghetti (1, 2, 3 servings)

- Cookware: Microwave-safe bowl† on the glass tray
- Food temperature: Room
- 1 serving (water 4-1/4 cups/1 L, spaghetti 3 oz/85 g)
2 servings (water 4-1/4 cups/1 L, spaghetti 6 oz/170 g)
3 servings (water 6-1/3 cups/1.5 L, spaghetti 9 oz/255 g)

24 OPERATION

- Instructions: Follow instructions for cooking Farfalle, but after selecting Simmer press **7** and **START** to select Spaghetti.

† Use a large bowl that holds at least 1 gallon (4 L) and is at least 6 in. (15 cm) high.

NOTE

- Be careful when removing the bowl from the oven or opening the lid as it will be very hot.

Operating the Oven

Conv. Bake Mode

During Convection Bake, a heating element is used to raise the temperature of the air inside the oven. The convection cooking temperatures range from 100 °F (38 °C) to 450 °F (232 °C). It is best to preheat the oven when convection cooking.

NOTE

- Reduce oven temperature by 25 °F from the temperature recommended on packaged foods. The baking time may vary according to the food condition or individual preference.

Setting the Convection Bake Function

With Preheating

- 1 Press **Conv. Bake**. 350 °F appears in the display.
- 2 Press numbers to set the oven temperature. Press **START**.
- 3 Press **START** again. The oven starts to preheat and the display shows **PREHEAT** and the oven temperature. (Do not enter the time.)
- 4 When the melody sounds, place the food in the oven.
- 5 Press numbers to set the cook time.
- 6 Press **START**.

- 7 When cooking is complete, Press **CLEAR/OFF**.

Without Preheating

- 1 Press **Conv. Bake**. 350 °F appears in the display.
- 2 Press numbers to set the oven temperature. Press **START**.
- 3 Press numbers to set the cook time.
- 4 Press **START**.
- 5 When cooking is complete, Press **CLEAR/OFF**.

NOTE

- When the oven reaches the set preheat temperature, a melody will sound. The oven automatically holds that temperature for 60 minutes.
- The oven temperature drops very quickly when the door is opened; however, this should not prevent food from being fully cooked during the normal cooking time.

Broil Mode

This feature allows you to brown and crisp food quickly. There is no need for preheating.

Setting the Broil Function

- 1 Press **Broil**.
- 2 Press numbers to set the cook time.
- 3 Press **START**. The oven begins to heat.
- 4 Press **CLEAR/OFF** to cancel at any time or when cooking is complete.

CAUTION

- Always use oven gloves when removing the food and accessories after cooking as the oven and accessories will be very hot.

NOTE

- For best results, use the metal tray and rack when broiling in the oven.

**Air Fry Mode**

The Air Fry function is specially designed for oil free frying. This function allows you to manually select the temperature and cook time. To automatically air fry common foods, select the Auto Cook Air Fry mode under More Modes. Air Fry temperatures range from 300 °F to 425 °F.

Setting the Air Fry Function**Example: Air Frying for 9 minutes 30 seconds at 425 °F**

- 1 Press **Air Fry**. 400 °F appears in the display.
- 2 Press numbers to set the oven temperature. Press **START**.
- 3 Press numbers to set the cook time.
- 4 Press **START**. The oven begins to heat.
- 5 Press **CLEAR/OFF** to cancel at any time or when cooking is complete.

Air Fry Menu

- Arrange food evenly in a single layer.
- For best results, turn food over 1 - 2 times during cooking.
- Cookware: Air Fry Pan on the rack on the metal tray
- **Fresh shrimp** (6 - 12 oz)
 - Set temp / Time (minutes): 425 °F / 17 - 23

- **Frozen chicken nuggets** (5 - 10 oz)
 - Set temp / Time (minutes): 425 °F / 14 - 18
- **Frozen chicken tenders** (6 - 14 oz)
 - Set temp / Time (minutes): 425 °F / 20 - 25
- **Frozen chicken wings** (5 - 18 oz)
 - Set temp / Time (minutes): 425 °F / 21 - 26
- **Frozen churros** (4 - 8 oz)
 - Set temp / Time (minutes): 375 °F / 10 - 13
- **Frozen french fries** (5 - 10 oz)
 - Set temp / Time (minutes): 425 °F / 17 - 23
- **Homemade french fries** (6 - 12 oz)
 - Set temp / Time (minutes): 425 °F / 17 - 23
- **Homemade potato wedges** (8 - 16 oz)
 - Set temp / Time (minutes): 425 °F / 20 - 27
- **Mixed vegetable** (6 - 12 oz)
 - Set temp / Time (minutes): 400 °F / 17 - 23

Dehydrate Mode

Use this function to dry fruit, vegetables, and beef to create healthy and nutritious snacks without using chemicals and preservatives. Place parchment paper on the metal tray and spread the food in a single layer. Dehydrate temperatures range from 100 °F to 200 °F.

Setting the Dehydrate Function**Example: Dehydrating for 5 hours at 140 °F**

- 1 Press **Dehydrate**. 160 °F appears in the display.
- 2 Set the oven temperature: Press **1, 4, 0** and **START**.
- 3 Set the cook time: Press **5, 0** and **0.HR** appears in the time display.
- 4 Press **START**. The oven begins to dehydrate.
- 5 Press **CLEAR/OFF** to cancel at any time or when cooking is complete.

Dehydrate Menu

- **Bananas**
 - Preparation: Cut into 1/4" (5 - 6 mm) slices.

26 OPERATION

- Set temp / Time: 160 °F / 5 - 8 hrs
- Use: Snacks, baby food, granola, cookies and banana bread
- **Figs**
 - Preparation: Remove stems and halve.
 - Set temp / Time: 160 °F / 8 - 9 hrs
 - Use: Fillings, cakes, puddings, bread and cookies
- **Kiwi**
 - Preparation: Peel and cut into 3/8" (8 - 12 mm) slices.
 - Set temp / Time: 160 °F / 5 - 8 hrs
 - Use: Snacks
- **Mangos**
 - Preparation: Remove skin and cut into 3/8" (6 - 10 mm) slices.
 - Set temp / Time: 160 °F / 6 - 9 hrs
 - Use: Snacks, cereals, baked goods
- **Pineapple**
 - Preparation: Peel, core and cut into 3/8" (8 - 12 mm) slices.
 - Set temp / Time: 160 °F / 6 - 9 hrs
 - Use: Snacks, baked goods, baked granola
- **Tomatoes**
 - Preparation: Wash and slice into 1/4" (6 mm) thick circles.
 - Set temp / Time: 160 °F / 6 - 9 hrs
 - Use: Soups, stews, paste or sauce
- **Mushroom**
 - Preparation: Clean with soft brush or cloth. Don't wash.
 - Set temp / Time: 140 °F / 4 - 8 hrs
 - Use: Rehydrate for soups, meat dishes, omelettes or frying
- **Beef jerky**
 - Preparation: Cut meat into 1/4" (5 - 6 mm) thick slices and marinate for 6 - 8 hours in the refrigerator.
 - Set temp / Time: 175 °F / 6 - 9 hrs
 - Use: Snacks

Auto Cook Mode

Use Auto Cook to heat common prepared foods without selecting cooking times and power levels.

Auto Cook has preset programs for 22 common foods.

Setting the Auto Cook Function

Example: To cook 4 slices of bacon

- 1** Press **Auto Cook**.
- 2** Select the food item: Press **1** for Bacon.
- 3** Press **START** to enter choice.
- 4** Set the weight or amount: Press **1** to select 3 - 4 slices of bacon.
- 5** Press **START** to begin cooking.

Auto Cook Menu

- **1 Bacon (regular sliced)** (3 - 4, 5 - 6 slices)
 - Cookware: Paper towel on a microwave-safe dish on the glass tray
 - Food temperature: Refrigerated
- **2 Baked potato** (1, 2, 3 - 4 potatoes)
 - Cookware: Metal tray
 - Food temperature: Room
- **3 Brownie** (8" X 8" pan, 9" X 13" pan)
 - Cookware: Microwave-safe cookware on the glass tray
 - Food temperature: Room
 - Instructions: Place the microwave-safe cookware on a sheet of waxed paper on the glass tray in the oven.
- **4 Cod fillets** (1 lb)
 - Cookware: Metal tray
 - Food temperature: Refrigerated
 - Instructions: Brush with oil, and season with salt and pepper. Turn food over when the oven beeps.
- **5 Fresh vegetable** (4 - 6, 7 - 9, 10 - 12, 13 - 15, 16 - 20 oz)
 - Cookware: Microwave-safe bowl on the glass tray
 - Food temperature: Refrigerated
 - Instructions: Add water (4 - 12 oz: 2 tbsp water, 13 - 20 oz: 4 tbsp water). Cover with vented plastic wrap. After cooking, stir and let stand for 3 minutes.

- **6 Frozen bagels** (1, 2 - 3 bagels)
 - Cookware: Metal tray
 - Food temperature: Frozen
- **7 Frozen garlic bread (sliced)** (1 - 2, 3 - 4, 5 - 6 pieces)
 - Cookware: Metal tray
 - Food temperature: Frozen
 - Instructions: Turn food over when the oven beeps.
- **8 Frozen pizza (regular crust)** (Individual 6", Regular 12")
 - Cookware: Metal tray
 - Food temperature: Frozen
- **9 Frozen soft pretzels** (1, 2, 3 - 4 pretzels)
 - Cookware: Metal tray
 - Food temperature: Frozen
- **10 Frozen vegetable** (4 - 6, 7 - 9, 10 - 12, 13 - 15, 16 - 20 oz)
 - Cookware: Microwave-safe bowl on the glass tray
 - Food temperature: Frozen
 - Instructions: Add water (4 - 12 oz: 2 tbsp water, 13 - 20 oz : 4 tbsp water). Cover with vented plastic wrap. After cooking, stir and let stand for 3 minutes.
- **11 Lamb chops (1/2" thick, 6 - 7 oz each)** (1, 2, 3 - 4 chops)
 - Cookware: Metal tray
 - Food temperature: Refrigerated
 - Instructions: Brush with oil, and season with salt and pepper. Turn food over when the oven beeps.
- **12 Meat loaf** (9" X 5")
 - Cookware: Microwave-safe cookware (glass or silicone) on the glass tray
 - Food temperature: Refrigerated
- **13 Nachos** (1 - 3, 4 - 6 servings (8 ea / 1 serving))
 - Cookware: Metal tray
 - Food temperature: Room
- **14 Oatmeal** (1, 2 servings)
 - Cookware: Large microwave-safe bowl on the glass tray
 - Food temperature: Room
 - Instructions: Combine ingredients in a bowl. Cover with vented plastic wrap. After cooking, let stand for 3 minutes.
- **15 Pork chops (1/2" thick, 6 - 7 oz each)** (1, 2, 3 - 4 chops)
 - Cookware: Metal tray
 - Food temperature: Refrigerated
 - Instructions: Brush with oil, and season with salt and pepper. Turn food over when the oven beeps.
- **16 Quinoa** (1, 2 servings)
 - Cookware: Large microwave-safe bowl on the glass tray
 - Food temperature: Room
 - Instructions: Combine ingredients in a bowl. Cover with vented plastic wrap. After cooking, let stand for 3 minutes.
- **17 Ribeye steak (1" thick, 14 - 16 oz each)** (1, 2 steaks)
 - Cookware: Metal tray
 - Food temperature: Refrigerated
 - Instructions: Brush with oil, and season with salt and pepper. Turn food over when the oven beeps.
- **18 Rice** (1/2, 1 cup)
 - Cookware: Deep and large microwave-safe bowl on the glass tray
 - Food temperature: Room
 - Instructions: Add rice and water to a bowl on the glass tray. Cover with vented plastic wrap. After cooking, let stand for 5-10 minutes.
- **19 Salmon steak** (1, 2, 3 - 4 steaks)
 - Cookware: Metal tray
 - Food temperature: Refrigerated
 - Ingredients: Ribeye steak (1" thick, 14 - 15 oz)
 - Instructions: Brush with oil, and season with salt and pepper. Turn food over when the oven beeps.
- **20 Sirloin steak (1" thick, 18 - 21 oz each)** (1, 2 steaks)
 - Cookware: Metal tray
 - Food temperature: Refrigerated
 - Instructions: Brush with oil, and season with salt and pepper. Turn food over when the oven beeps.
- **21 Tenderloin** (3/4, 1 1/2 lb)
 - Cookware: Metal tray
 - Food temperature: Refrigerated
 - Instructions: Brush with oil, and season with salt and pepper. Turn food over when the oven beeps.

28 OPERATION

- **22 Vegetable-canned** (4 - 6, 7 - 9, 10 - 12, 13 - 15, 16 - 20 oz)
 - Cookware: Microwave-safe bowl on the glass tray
 - Food temperature: Room
 - Instructions: Cover with vented plastic wrap. After cooking, stir and let stand for 3 minutes.

NOTE

- Do not use recycled paper products in the oven. They sometimes contain impurities that cause arcing and sparking.
- Never use paper products when using a convection mode.

Speed Cook Mode

The Speed Convection and Speed Broil modes use power from the heating elements and microwaves simultaneously to cook food quickly.

CAUTION

- When using the Speed Cook function, remember that the oven, door and dishes will be very hot.

NOTE

- You can only select microwave power levels 1 through 4 with Speed Cook. Each power level uses the heating elements and microwave energy for a set percentage.

Speed Conv.

Setting the Speed Convection Function

Use this mode to roast meat, chicken or vegetables, or to cook frozen pizza, cake, pies, or bread.

Example: Cooking for 15 minutes at 40 % power and 375 °F

- 1** Press **Speed Conv.**
- 2** Set the power level: Press **4**.
- 3** 350 °F appears in the display. Set the oven temperature: Press **3, 7, 5** and **START**.

- 4** Set the cook time: Press **1, 5, 0** and **0**.

- 5** Press **START**. The oven begins to heat.

- 6** When cooking has finished or to cancel, press **CLEAR/OFF**.

Speed Broil

Setting the Speed Broil Function

Use this function for steaks, chicken fillets, fish or seafood.

Example: Cooking for 10 minutes at 20 % power

- 1** Press **Speed Broil**.
- 2** Set the power level: Press **2**.
- 3** Set the cook time: Press **1, 0, 0** and **0**.
- 4** Press **START**. The oven begins to heat.
- 5** When cooking has finished or to cancel, press **CLEAR/OFF**.

Warm Mode

This function maintains an oven temperature of less than 195 °F. This function should not be used to reheat cold food. This function keeps cooked food warm for serving up to 3 hours after cooking has finished. After 3 hours this function shuts the oven OFF automatically.

Setting the Warm Function

- 1** Press **Warm**.
- 2** Select the temperature level: Press **1** for High, **2** for Medium, or **3** for Low.
 - High: 195 °F (91 °C)
 - Medium: 165 °F (74 °C)
 - Low: 140 °F (60 °C)

- 3** Select the type: Press **1** for moist, **2** for crisp.
- 4** Press **START** to start warming. The time is automatically set for 3 hours.
- 5** Press **CLEAR/OFF** at any time to cancel.

NOTE

- This function is intended to keep food warm. Do not use it to cool food down.
- It is normal for the fan to operate during this function.

Proof Mode

This function maintains a warm oven for rising yeast-leavened products before baking.

Setting the Proof Function**Example: Proofing for 2 hours**

- 1** Press **Proof**.
- 2** Set the proof time: Press **2**, **0** and **0**.
- 3** Press **START** to start proofing.
- 4** Press **CLEAR/OFF** at any time to cancel.

NOTE

- To avoid lowering the oven temperature and lengthening proofing time, do not open the oven door unnecessarily.
- Check bread products early to avoid over-proofing.
- Do not use the Proofing mode for warming food or keeping food hot. The proofing oven temperature is not hot enough to hold foods at safe temperatures. Use the Warm function to keep food warm.
- Proofing will not operate if the oven is too hot. Allow the oven to cool before proofing.

More Modes

The product firmware may be updated to include additional functions through More Modes.

The currently available options include the Auto Cook Air Fry function, which contains presets for air frying many common foods.

Setting the Auto Cook Air Fry Function**Example: 3 - 4 servings of frozen mozzarella sticks**

- 1** Press **More Modes** and **1**.
- 2** Press **6** to select frozen mozzarella sticks. Press **START**.
- 3** Press **2** to select 3-4 servings.
- 4** Press **START**.
- 5** When the oven beeps, turn food over.
- 6** Press **CLEAR/OFF** to cancel at any time or when cooking is complete.

Auto Cook Air Fry Menu

- **1 Chicken legs** (1 - 2, 3 - 4 servings (3.5 oz/100g per serving))
 - Cookware: Air Fry pan on the rack on the metal tray
 - Food temperature: Refrigerated
 - Instructions: Turn food over when the oven beeps.
- **2 Frozen chicken nuggets** (1 - 2, 3 - 4 servings (3.5 oz/100g per serving))
 - Cookware: Air Fry pan on the rack on the metal tray
 - Food temperature: Frozen
 - Instructions: Turn food over when the oven beeps.
- **3 Frozen chicken wings** (1 - 2, 3 - 4 servings (3.5 oz/100g per serving))
 - Cookware: Air Fry pan on the rack on the metal tray
 - Food temperature: Frozen

30 OPERATION

- Instructions: Turn food over when the oven beeps.
- **4 Frozen french fries** (1 - 2, 3 - 4 servings, (3.5 oz/100g per serving))
 - Cookware: Air Fry pan on the rack on the metal tray
 - Food temperature: Frozen
 - Instructions: Turn food over when the oven beeps.
- **5 Frozen hash brown patties** (1 - 2, 3 - 4 servings (3.5 oz/100g per serving))
 - Cookware: Air Fry pan on the rack on the metal tray
 - Food temperature: Frozen
 - Instructions: Turn food over when the oven beeps.
- **6 Frozen mozzarella sticks** (1 - 2, 3 - 4 servings (3.5 oz/100g per serving))
 - Cookware: Air Fry pan on the rack on the metal tray
 - Food temperature: Frozen
 - Instructions: Turn food over when the oven beeps.
- **7 Frozen potato wedges** (1 - 2, 3 - 4 servings (3.5 oz/100g per serving))
 - Cookware: Air Fry pan on the rack on the metal tray
 - Food temperature: Frozen
 - Instructions: Turn food over when the oven beeps.
- **8 Hamburger** (2, 3 - 4, 5 - 6 patties (1/2" thick))
 - Cookware: Air Fry pan on the rack on the metal tray
 - Food temperature: Refrigerated
 - Instructions: Turn food over when the oven beeps.
- **9 Sausage** (1 - 6, 7 - 14 links)
 - Cookware: Air Fry pan on the rack on the metal tray
 - Food temperature: Refrigerated
 - Instructions: Turn food over when the oven beeps.

SMART FUNCTIONS

LG ThinQ Application

This feature is only available on models with Wi-Fi.

The **LG ThinQ** application allows you to communicate with the appliance using a smartphone.

LG ThinQ Application Features

- **Settings**
 - Allows you to set various options on the oven and in the application.
- **Smart Diagnosis™**
 - This function provides useful information for diagnosing and solving issues with the appliance based on the pattern of use.
- **Scan to Cook**
 - Scan the barcode on a ready-made meal using the LG ThinQ application and send the recommended or customized cooking instructions straight to your oven.
- **Monitoring**
 - This function helps you check the current status, remaining time, cook settings and end time in one place.
- **Product Notifications**
 - Turn on the Push Alerts to receive appliance status notifications. The notifications are triggered even if the **LG ThinQ** application is not open.
- **Timer**
 - You can set the timer from the application.
- **Firmware Update**
 - Keep the appliance updated.

NOTE

- If you change your wireless router, Internet service provider, or password, delete the connected appliance from the **LG ThinQ** application and connect it again.
- This information is current at the time of publication. The application is subject to change for product improvement purposes without notice to users.

Installing LG ThinQ Application and Connecting an LG Appliance

Models with QR Code

Scan the QR code attached to the product using the camera or a QR code reader application on your smartphone.

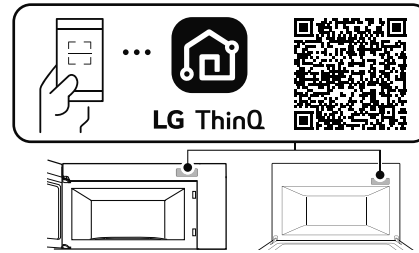

Models without QR Code

- 1** Search for and install the **LG ThinQ** application from the Google Play Store or Apple App Store on a smartphone.
- 2** Run the **LG ThinQ** application and sign in with your existing account or create an LG account to sign in.
- 3** Touch the add (+) button on the **LG ThinQ** application to connect your LG appliance. Follow the instructions in the application to complete the process.

NOTE

- To verify the Wi-Fi connection, check that the Wi-Fi icon on the control panel is lit.
- The appliance supports 2.4 GHz Wi-Fi networks only. To check your network frequency, contact your Internet service provider or refer to your wireless router manual.
- **LG ThinQ** is not responsible for any network connection problems or any faults, malfunctions, or errors caused by network connection.
- The surrounding wireless environment can make the wireless network service run slowly.
- If the distance between the appliance and the wireless router is too far, the signal becomes weak. It may take a long time to connect or fail to install the application.

32 SMART FUNCTIONS

NOTE

- If the appliance is having trouble connecting to the Wi-Fi network, it may be too far from the router. Purchase a Wi-Fi repeater (range extender) to improve the Wi-Fi signal strength.
- The network connection may not work properly depending on the Internet service provider.
- The Wi-Fi may not connect or the connection may be interrupted because of the home network environment.
- If the appliance cannot be connected due to problems with the wireless signal transmission, unplug the appliance and wait about a minute before trying again.
- If the firewall on your wireless router is enabled, disable the firewall or add an exception to it.
- The wireless network name (SSID) should be a combination of English letters and numbers. (Do not use special characters.)
- Smartphone user interface (UI) may vary depending on the mobile operating system (OS) and the manufacturer.
- If the security protocol of the router is set to **WEP**, network setup may fail. Change the security protocol (**WPA2** is recommended), and connect the product again.

Wireless LAN Module Specifications

Frequency Range	2412 - 2462 MHz
Output Power (Max)	< 30 dBm

FCC Notice

The following notice covers the transmitter module contained in this product.

This equipment has been tested and found to comply with the limits for a Class B digital device, pursuant to Part 15 of the FCC Rules. These limits are designed to provide reasonable protection against harmful interference in a residential installation. This equipment generates, uses, and can radiate radio frequency energy and, if not installed and used in accordance with the instructions, may cause harmful interference to radio communications. However, there is no guarantee that interference will not occur in a particular installation. If this equipment does cause harmful interference to radio or television reception, which can be determined by turning the

equipment off and on, the user is encouraged to try to correct the interference by one or more of the following measures:

- Reorient or relocate the receiving antenna.
- Increase the separation between the equipment and the receiver.
- Connect the equipment into an outlet on a circuit different from that to which the receiver is connected.
- Consult the dealer or an experienced radio/TV technician for help.

This device complies with part 15 of the FCC Rules. Operation is subject to the following two conditions:

- (1) This device may not cause harmful interference and
- (2) This device must accept any interference received, including interference that may cause undesired operation.

Any changes or modifications in construction of this device which are not expressly approved by the party responsible for compliance could void the user's authority to operate the equipment.

FCC RF Radiation Exposure Statement

This equipment complies with FCC radiation exposure limits set forth for an uncontrolled environment. This transmitter must not be co-located or operating in conjunction with any other antenna or transmitter.

This equipment should be installed and operated with a minimum distance of 20 cm (7.8 inches) between the antenna and your body. Users must follow the specific operating instructions for satisfying RF exposure compliance.



Open Source Software Notice Information

To obtain the source code that is contained in this product, under GPL, LGPL, MPL, and other open source licenses that have the obligation to disclose source code, and to access all referred license terms, copyright notices and other relevant documents, please visit <https://opensource.lge.com>.

LG Electronics will also provide open source code to you on CD-ROM for a charge covering the cost of performing such distribution (such as the cost of media, shipping, and handling) upon email request to opensource@lge.com.

This offer is valid to anyone in receipt of this information for a period of three years after our last shipment of this product.

Smart Diagnosis™ Feature

This feature is only available on models with the  or  logo.

Use this feature to help you diagnose and solve problems with your appliance.

NOTE

- For reasons not attributable to LGE's negligence, the service may not operate due to external factors such as, but not limited to, Wi-Fi unavailability, Wi-Fi disconnection, local app store policy, or app unavailability.
- The feature may be subject to change without prior notice and may have a different form depending on where you are located.

- 3 Keep the phone in place until the tone transmission has finished. The display will count down the time. Once the countdown is over and the tones have stopped, the diagnosis will be displayed in the application.

NOTE

- For best results, do not move the phone while the tones are being transmitted.

Using LG ThinQ to Diagnose Issues

If you experience a problem with your Wi-Fi equipped appliance, it can transmit troubleshooting data to a smartphone using the **LG ThinQ** application.

- Launch the **LG ThinQ** application and select the **Smart Diagnosis** feature in the menu. Follow the instructions provided in the **LG ThinQ** application.

Using Audible Diagnosis to Diagnose Issues

Follow the instructions below to use the audible diagnosis method.

- Launch the **LG ThinQ** application and select the **Smart Diagnosis** feature in the menu. Follow the instructions for audible diagnosis provided in the **LG ThinQ** application.

- 1 Press the **START** button for three seconds.
 - If the display has been locked, you must deactivate the lock and then reactivate it.
- 2 Hold the mouthpiece of your phone in front of the **Smart Diagnosis** logo located on the control panel.

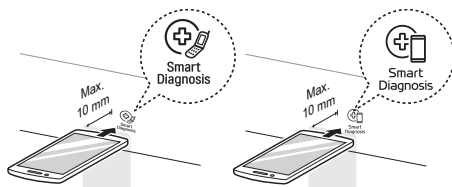

34 MAINTENANCE

MAINTENANCE

Cleaning

Interior

Wash often with warm, sudsy water and a sponge or soft cloth. Use only mild, nonabrasive soaps or a mild detergent. Keep the areas clean where the door and oven frame touch when closed.

Wipe well with a clean cloth. Over time, stains can occur on the surfaces as the result of food particles spattering during cooking. This is normal.

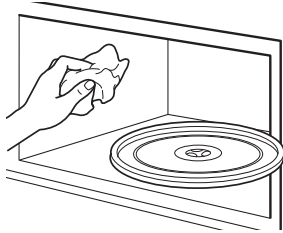

For stubborn soil, boil a cup of water in the oven for 2 to 3 minutes. Steam will soften the soil. To get rid of odors inside the oven, boil a cup of water with some lemon juice or vinegar in it.

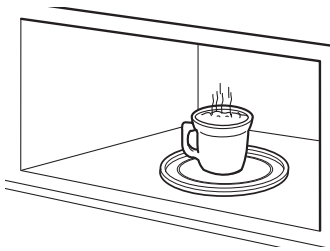

Exterior

Use a soft cloth sprayed with glass cleaner.

Apply the glass cleaner to the soft cloth. Do not spray directly on the oven.

NOTE

- Abrasive cleansers, steel wool pads, gritty wash cloths, some paper towels, etc., can damage the control panel and the interior and exterior oven surfaces.

For heavily soiled areas use a mild cleanser and scouring sponge.

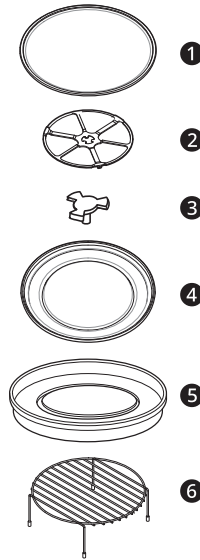

- ① Glass Tray
- ② Rotating Ring
- ③ Shaft
- ④ Metal Tray
- ⑤ Air Fry Pan
- ⑥ Rack

NOTE

- The glass tray is dishwasher safe.

Glass Tray and Rotating Ring

To clean all accessories except for the shaft, wash in mild, sudsy water.

TROUBLESHOOTING

FAQs

Frequently Asked Questions

Q: Will the oven be damaged if it operates while empty?

A: Yes. Never operate the oven while it is empty or without the glass tray.

Q: Does microwave energy pass through the viewing screen in the door?

A: No. The metal screen bounces the energy back to the oven cavity. The holes (or ports) allow only light to pass through. They do not let microwave energy pass through.

Q: Why do I see a light reflection around the outer case?

A: This light is from the oven light which is located between the oven cavity and the outer wall of the oven.

Q: What are the various sounds I hear when the oven is operating?

A: The clicking sound is caused by a mechanical switch turning the microwave oven's magnetron ON and OFF.
The heavy hum and clunk is from the change in power the magnetron draws as it is turned ON and OFF by a mechanical switch. The change in blower speed is from the change in line voltage caused by the magnetron being turned ON and OFF.

Q: Can my oven be damaged if food is cooked for too long?

A: Like any other cooking appliance, it is possible to overcook food to the point that the food creates smoke and even possibly fire, and damages the inside of the oven. It is always best to be near the oven while you are cooking.

Q: Why is a standing time recommended after microwave cooking time is over?

A: Standing time allows foods to continue cooking evenly for a few minutes after the actual microwave oven cooking cycle. The amount of standing time depends upon the density of the foods.

Q: Why is additional time required for cooking food stored in the refrigerator?

A: As in conventional cooking, the initial temperature of food affects total cooking time. You need more time to cook food taken out of a refrigerator than for food at room temperature.

Q: Sometimes the door of my oven appears wavy. Is this normal?

A: This appearance is normal and does not affect the operation of your oven.

Q: Why does the glass tray not move?

A: The correct side of the tray should be facing up and the tray should sit firmly on the center hub. The support is not operating correctly. Reinstall the glass tray and restart the oven. Cooking without the glass tray can give you poor results.

Q: Why does the dish become hot when I microwave food in it? I thought that this should not happen.

A: As the food becomes hot it will conduct the heat to the dish. Use hot pads to remove food after cooking.

Q: What does standing time mean?

A: Standing time means that food should be taken out of the oven and covered for additional time after cooking. This process allows the cooking to finish, saves energy, and frees the oven for other purposes.

36 TROUBLESHOOTING

Q: Can I pop popcorn in my oven? How do I get the best results?

A: Yes. Pop packaged microwave popcorn following manufacturer's guidelines or use the preprogrammed Popcorn button. Do not use regular paper bags. Use the listening test by stopping the oven as soon as the popping slows to a pop every one or two seconds. Do not try to repop unpopped kernels. You can also use special microwave poppers. When using a popper, be sure to follow manufacturer's directions. Do not pop popcorn in glass utensils.

Q: Why does steam come out of the air exhaust vent?

A: Steam is normally produced during cooking. The oven has been designed to vent steam out of the vent.

Q: During convection cooking the fan stops when I open the door. Is that normal?

A: Yes, this is normal. When the door is opened, the convection fan will stop until the door is closed.

Q: Why aren't the function buttons working?

A: Make sure that the oven is not in Control Lock mode. The lock  will show in the display if Control Lock is activated. To deactivate Control Lock, press and hold **CLEAR/OFF** for three seconds.

Before Calling for Service

Review this section before calling for service; doing so will save you both time and money.

Cooking

Problem	Possible Cause & Solution
Oven will not work	Plug on appliance is not completely inserted in the electrical outlet. <ul style="list-style-type: none"> Make sure electrical plug is plugged into a live, properly grounded outlet.
	A fuse in your home may be blown or the circuit breaker tripped. <ul style="list-style-type: none"> Replace the fuse or reset the circuit breaker.
	Oven controls improperly set. <ul style="list-style-type: none"> See the OPERATION chapter.
	Oven too hot. <ul style="list-style-type: none"> Allow the oven to cool to below locking temperature.
Arcing or Sparking	Cookware is not microwave safe. <ul style="list-style-type: none"> When in doubt, test cookware before use.
	Do not operate oven while empty. <ul style="list-style-type: none"> Place the food in the oven.
Unevenly Cooked Foods, Overcooked Foods, Undercooked Foods, Improper Defrosting	Carefully monitor the food in the microwave oven while it is cooking. <ul style="list-style-type: none"> See the Cooking Tips in the Operating the Microwave section.
If the display shows a time counting down but the oven is not cooking.	The oven door is not closed. <ul style="list-style-type: none"> Check that the oven door is firmly closed.
Steam is exhausted through the oven vent.	Cooking foods with high moisture produces steam. <ul style="list-style-type: none"> This is normal.
Appliance does not operate.	Cord is not plugged in correctly. <ul style="list-style-type: none"> Make sure cord is plugged correctly into outlet. Check circuit breakers.
	Service wiring is not complete. <ul style="list-style-type: none"> Contact your electrician for assistance.
	Power outage. <ul style="list-style-type: none"> Check house lights to be sure. Call your local electric company for service.
Oven smokes excessively during broiling.	Oven control not set properly. <ul style="list-style-type: none"> See the Operating the Oven section.
	Meat not properly prepared. <ul style="list-style-type: none"> Remove excess fat from meat. Cut remaining fatty edges to prevent curling.
	Grease has built up on oven surfaces. Old grease or food spatters cause excessive smoking. <ul style="list-style-type: none"> Regular cleaning is necessary when broiling frequently.
Food does not bake properly	Oven controls improperly set. <ul style="list-style-type: none"> See the Operating the Oven section.

38 TROUBLESHOOTING

Problem	Possible Cause & Solution
Food does not bake properly	<p>Incorrect cookware or cookware of improper size being used.</p> <ul style="list-style-type: none"> See the Operating the Oven section.
Food does not broil properly	<p>Oven controls improperly set.</p> <ul style="list-style-type: none"> See the Operating the Oven section.
	<p>In some areas the power voltage may be low.</p> <ul style="list-style-type: none"> Preheat the broil element for 5-7 minutes.
Moisture collects on oven window or steam comes from oven vent	<p>This happens when cooking foods high in moisture.</p> <ul style="list-style-type: none"> This is normal.

Parts & Features

Problem	Possible Cause & Solution
Oven control beeps and displays any F code error.	<p>Electronic control has detected a fault condition.</p> <ul style="list-style-type: none"> Turn off the oven function you are using to clear the display and stop beeping. Reprogram oven. If fault recurs, record fault number and call for service. <p>Press CLEAR/OFF to clear the display and stop beeping. If the fault recurs, record fault number and call for service.</p> <p>[Case 1]</p> <ul style="list-style-type: none"> Code: F1 Cause: High Temperature Sensor Open <p>[Case 2]</p> <ul style="list-style-type: none"> Code: F2 Cause: High Temperature Sensor Short <p>[Case 3]</p> <ul style="list-style-type: none"> Code: F4 Cause: Humidity Sensor Error <p>[Case 4]</p> <ul style="list-style-type: none"> Code: F22 Cause: Low Temperature Sensor Open <p>[Case 5]</p> <ul style="list-style-type: none"> Code: F23 Cause: Low Temperature Sensor Short
Oven light does not work.	<p>The bulb is defective.</p> <ul style="list-style-type: none"> Press Light to check if the bulb is working.

Noises

Problem	Possible Cause & Solution
"Crackling" or "popping" sound	<p>This is the sound of the metal heating and cooling during the cooking.</p> <ul style="list-style-type: none"> This is normal.
Fan noise	<p>A convection fan may automatically turn on and off.</p> <ul style="list-style-type: none"> This is normal.

Wi-Fi

Problem	Possible Cause & Solution
Trouble connecting appliance and smartphone to Wi-Fi network	The password for the Wi-Fi network was entered incorrectly. <ul style="list-style-type: none"> Delete your home Wi-Fi network and begin the connection process again.
	Mobile data for your smartphone is turned on. <ul style="list-style-type: none"> Turn off the Mobile data on your smartphone before connecting the appliance.
	The wireless network name (SSID) is set incorrectly. <ul style="list-style-type: none"> The wireless network name (SSID) should be a combination of English letters and numbers. (Do not use special characters.)
	The router frequency is not 2.4 GHz. <ul style="list-style-type: none"> Only a 2.4 GHz router frequency is supported. Set the wireless router to 2.4 GHz and connect the appliance to the wireless router. To check the router frequency, check with your Internet service provider or the router manufacturer.
	The appliance and the router are too far apart. <ul style="list-style-type: none"> If the appliance is too far from the router, the signal may be weak and the connection may not be configured correctly. Move the router closer to the appliance or purchase and install a Wi-Fi repeater.
	During Wi-Fi setup, the app is requesting a password to connect to the product (on certain phones). <ul style="list-style-type: none"> Locate the network name which starts with "LG" under Settings > Networks. Note the last part of the network name. <ul style="list-style-type: none"> If the network name looks like LGE_Appliance_XX-XX-XX, enter lge12345. If the network name looks like LGE_Appliance_XXXX, enter XXXX twice as your password. For example, if the network name appears as LGE_Appliance_8b92, then you would enter 8b928b92 as your password. In this instance, the password is case sensitive and the last 4 characters are unique to your appliance.

40 LIMITED WARRANTY

LIMITED WARRANTY**USA****TERMS AND CONDITIONS**

ARBITRATION NOTICE: THIS LIMITED WARRANTY CONTAINS AN ARBITRATION PROVISION THAT REQUIRES YOU AND LG ELECTRONICS ("LG") TO RESOLVE DISPUTES BY BINDING ARBITRATION INSTEAD OF IN COURT, UNLESS YOU CHOOSE TO OPT OUT. IN ARBITRATION, CLASS ACTIONS AND JURY TRIALS ARE NOT PERMITTED. PLEASE SEE THE SECTION TITLED "PROCEDURE FOR RESOLVING DISPUTES" BELOW.

Should your LG Electric **Microwave Oven** ("Product") fail due to a defect in materials or workmanship under normal and proper use, during the warranty period set forth below, LG will, at its option, repair or replace the Product. This limited warranty is valid only to the original retail purchaser of the Product ("You") and applies only when purchased lawfully and used within the United States including U.S. Territories.

WARRANTY PERIOD	
Microwave Oven	Inverter Magnetron Only
Parts (internal/functional parts only) and Labor: One (1) year from the date of original retail purchase	Parts Only: Ten (10) years from the date of original retail purchase You are responsible for any applicable labor cost.

- Replacement Products and parts are warranted for the remaining portion of the original warranty period or ninety (90) days, whichever is greater.
- Replacement Products and parts may be new, reconditioned, refurbished, or otherwise factory remanufactured.
- Replaced Product or part(s) will be the property of LG.
- Proof of original retail purchase specifying the Product model and date of purchase is required to obtain warranty service under this limited warranty.

EXCEPT TO THE EXTENT PROHIBITED BY APPLICABLE LAW, ANY IMPLIED WARRANTY OF MERCHANTABILITY OR FITNESS FOR A PARTICULAR PURPOSE ON THE PRODUCT IS LIMITED IN DURATION TO THE DURATION OF THE ABOVE LIMITED WARRANTY. UNDER NO CIRCUMSTANCES SHALL LG OR ITS U.S. DISTRIBUTORS/DEALERS BE LIABLE FOR ANY INDIRECT, INCIDENTAL, CONSEQUENTIAL, SPECIAL, OR PUNITIVE DAMAGES, INCLUDING, WITHOUT LIMITATION, LOST GOODWILL, LOST REVENUES OR PROFITS, WORK STOPPAGE, IMPAIRMENT OF OTHER GOODS, COST OF REMOVAL AND REINSTALLATION OF THE PRODUCT, LOSS OF USE, OR ANY OTHER DAMAGES WHETHER BASED IN CONTRACT, TORT, OR OTHERWISE. LG'S TOTAL LIABILITY, IF ANY, SHALL NOT EXCEED THE PURCHASE PRICE PAID BY YOU FOR THE PRODUCT.

SOME STATES DO NOT ALLOW THE EXCLUSION OR LIMITATION OF INCIDENTAL OR CONSEQUENTIAL DAMAGES OR LIMITATIONS ON HOW LONG AN IMPLIED WARRANTY LASTS, SO THE ABOVE EXCLUSIONS OR LIMITATIONS MAY NOT APPLY TO YOU. THIS LIMITED WARRANTY GIVES YOU SPECIFIC LEGAL RIGHTS AND YOU MAY ALSO HAVE OTHER RIGHTS THAT VARY FROM STATE TO STATE.

THIS LIMITED WARRANTY DOES NOT COVER

- Service trips to deliver, pick up, or install, educate how to operate, correct wiring, or correct unauthorized repairs.
- Damage or failure of the Product to perform during power failures and interrupted or inadequate electrical service.
- Damage or failure of the Product caused by leaky or broken water pipes, frozen water pipes, restricted drain lines, inadequate or interrupted water supply or inadequate supply of air.
- Damage or failure of the Product resulting from operating the Product in a corrosive atmosphere or contrary to the Product owner's manual.

- Damage or failure of the Product caused by accidents, pests and vermin, lightning, wind, fire, floods, acts of nature, or any other causes beyond the control of LG.
- Damage or failure of the Product caused by unauthorized modification or alteration, or if the Product is used for other than the intended purpose, or any water leakage where the Product was not properly installed.
- Damage or failure of the Product caused by incorrect electrical current, voltage, or plumbing codes.
- Damage or failure of the Product caused by transportation, storage, and/or handling, including scratches, dents, chips, and/or other damage to the finish of the Product, unless such damage is reported within one (1) week of delivery.
- Damage or failure of the Product resulting from misuse, abuse, improper installation, repair, or maintenance. Improper repair includes the use of parts not authorized by LG. Improper installation or maintenance includes installation or maintenance contrary to the Product owner's manual.
- Damage or failure of the Product caused by the use of parts, components, accessories, consumable cleaning products, or any other products or services that were not authorized by LG.
- Damage or missing items to any display or open box Product.
- Refurbished Product or any Product sold "As Is", "Where Is", "With all Faults", or similar disclaimer.
- Products with original serial numbers that have been removed, altered, or cannot be readily determined.
- Increases in utility costs and additional utility expenses.
- Any noises associated with normal operation.
- Products used for other than normal and proper household use (e.g., commercial or industrial use) or contrary to the Product owner's manual.
- Costs associated with removal and reinstallation of the Product for repairs, or the removal and reinstallation of the Product if it is installed in an inaccessible location or not installed in accordance with the Product Owner's manual.
- Accessories, removable components, or consumable parts (e.g. Shelves, door bins, drawers, water/air filters, racks, light bulbs, batteries, etc., as applicable), except for internal/functional parts covered under this limited warranty.

The cost of repair or replacement under these excluded circumstances shall be borne by You.

TO OBTAIN WARRANTY SERVICE AND ADDITIONAL INFORMATION

Call 1-800-243-0000 and select the appropriate option from the menu.

Or visit our website at <http://www.lg.com>

Or by mail: LG Electronics Customer Service P.O. Box 240007 Huntsville, AL 35813 ATTN: CIC

PROCEDURE FOR RESOLVING DISPUTES

ALL DISPUTES BETWEEN YOU AND LG ARISING OUT OF OR RELATING IN ANY WAY TO THIS LIMITED WARRANTY OR THE PRODUCT SHALL BE RESOLVED EXCLUSIVELY THROUGH BINDING ARBITRATION, AND NOT IN A COURT OF GENERAL JURISDICTION. BINDING ARBITRATION MEANS THAT YOU AND LG ARE EACH WAIVING THE RIGHT TO A JURY TRIAL AND TO BRING OR PARTICIPATE IN A CLASS ACTION.

Definitions. For the purposes of this section, references to "LG" mean LG Electronics U.S.A., Inc., its parents, subsidiaries and affiliates, and each of their officers, directors, employees, agents, beneficiaries, predecessors in interest, successors, assigns and suppliers; references to "dispute" or "claim" shall include any dispute, claim or controversy of any kind whatsoever (whether based in contract, tort, statute, regulation, ordinance, fraud, misrepresentation or any other legal or equitable theory) arising out of or relating in any way to the sale, condition or performance of the product or this Limited Warranty.

Notice of Dispute. In the event you intend to commence an arbitration proceeding, you must first notify LG in writing at least 30 days in advance of initiating the arbitration by sending a letter to LG at LG Electronics, USA, Inc. Attn: Legal Department- Arbitration 111 Sylvan Avenue, Englewood Cliffs, NJ 07632 USA. You and LG agree to engage in good faith discussions in an attempt to amicably resolve your claim. The notice must provide your name, address, and telephone number; identify the product that is the

42 LIMITED WARRANTY

subject of the claim; and describe the nature of the claim and the relief being sought. If you and LG are unable to resolve the dispute within 30 days, either party may proceed to file a claim for arbitration.

Agreement to Binding Arbitration and Class Action Waiver. Upon failure to resolve the dispute during the 30 day period after sending written notice to LG, you and LG agree to resolve any claims between us only by binding arbitration on an individual basis, unless you opt out as provided below. Any dispute between you and LG shall not be combined or consolidated with a dispute involving any other person's or entity's product or claim. More specifically, without limitation of the foregoing, any dispute between you and LG shall not under any circumstances proceed as part of a class or representative action. Instead of arbitration, either party may bring an individual action in small claims court, but that small claims court action may not be brought on a class or representative basis.

Arbitration Rules and Procedures. To begin arbitration of a claim, either you or LG must make a written demand for arbitration. The arbitration will be administered by the American Arbitration Association ("AAA") and will be conducted before a single arbitrator under the AAA's Consumer Arbitration Rules that are in effect at the time the arbitration is initiated (referred to as the "AAA Rules") and under the procedures set forth in this section. The AAA Rules are available online at www.adr.org/consumer. Send a copy of your written demand for arbitration, as well as a copy of this provision, to the AAA in the manner described in the AAA Rules. You must also send a copy of your written demand to LG at LG Electronics, USA, Inc. Attn: Legal Department- Arbitration 111 Sylvan Avenue, Englewood Cliffs, NJ 07632 USA. If there is a conflict between the AAA Rules and the rules set forth in this section, the rules set forth in this section will govern. This arbitration provision is governed by the Federal Arbitration Act. Judgment may be entered on the arbitrator's award in any court of competent jurisdiction. All issues are for the arbitrator to decide, except that issues relating to the scope and enforceability of the arbitration provision and to the arbitrability of the dispute are for the court to decide. The arbitrator is bound by the terms of this provision.

Governing Law. The law of the state of your residence shall govern this Limited Warranty and any disputes between us except to the extent that such law is preempted by or inconsistent with applicable federal law.

Fees/Costs. You do not need to pay any fee to begin an arbitration. Upon receipt of your written demand for arbitration, LG will promptly pay all arbitration filing fees to the AAA unless you seek more than \$25,000 in damages, in which case the payment of these fees will be governed by the AAA Rules. Except as otherwise provided for herein, LG will pay all AAA filing, administration and arbitrator fees for any arbitration initiated in accordance with the AAA Rules and this arbitration provision. If you prevail in the arbitration, LG will pay your attorneys' fees and expenses as long as they are reasonable, by considering factors including, but not limited to, the purchase amount and claim amount. Notwithstanding the foregoing, if applicable law allows for an award of reasonable attorneys' fees and expenses, an arbitrator can award them to the same extent that a court would. If the arbitrator finds either the substance of your claim or the relief sought in the demand is frivolous or brought for an improper purpose (as measured by the standards set forth in Federal Rule of Civil Procedure 11(b)), then the payment of all arbitration fees will be governed by the AAA Rules. In such a situation, you agree to reimburse LG for all monies previously disbursed by it that are otherwise your obligation to pay under the AAA Rules. Except as otherwise provided for, LG waives any rights it may have to seek attorneys' fees and expenses from you if LG prevails in the arbitration.

Hearings and Location. If your claim is for \$25,000 or less, you may choose to have the arbitration conducted solely on the basis of (1) documents submitted to the arbitrator, (2) through a telephonic hearing, or (3) by an in-person hearing as established by the AAA Rules. If your claim exceeds \$25,000, the right to a hearing will be determined by the AAA Rules. Any in-person arbitration hearings will be held at a location within the federal judicial district in which you reside unless we both agree to another location or we agree to a telephonic arbitration.

Opt Out. You may opt out of this dispute resolution procedure. If you opt out, neither you nor LG can require the other to participate in an arbitration proceeding. To opt out, you must send notice to LG no later than 30 calendar days from the date of the first consumer purchaser's purchase of the product by either: (i) sending an e-mail to optout@lge.com, with the subject line: "Arbitration Opt Out" or (ii) calling 1-800-980-2973. You must include in the opt out e-mail or provide by telephone: (a) your name and address; (b) the date on which the product was purchased; (c) the product model name or model number; and (d) the serial number (the serial number can be found (i) on the product; or (ii) online by accessing <https://www.lg.com/us/support/repair-service/schedule-repair-continued> and clicking on "Find My Model & Serial Number").

You may only opt out of the dispute resolution procedure in the manner described above (that is, by e-mail or telephone); no other form of notice will be effective to opt out of this dispute resolution procedure. Opting out of this dispute resolution procedure will not affect the coverage of the Limited Warranty in any way, and you will continue to enjoy the full benefits of the Limited Warranty. If you keep this product and do not opt out, then you accept all terms and conditions of the arbitration provision described above.

ENGLISH



LG Customer Information Center

For inquiries or comments,
visit www.lg.com or call:

1-800-243-0000 U.S.A.
1-888-542-2623 CANADA

Register your product Online!

www.lg.com