



## 14. CALIBRATION CERTIFICATES

The following pages include the probe calibration used to evaluate HAC for the DUT.

<b>FCC ID:</b> BEJCU400	 <b>PCTEST</b> wired & wireless	<b>HAC (RF EMISSIONS) TEST REPORT</b>	 <b>LG</b>	<b>Reviewed by:</b> Quality Manager
<b>HAC Filename:</b> 0610110886	<b>Test Dates:</b> October 16 - 19, 2006	<b>EUT Type:</b> Dual-Band GSM/WCDMA Phone with Bluetooth		Page 39 of 74



Accredited by the Swiss Federal Office of Metrology and Accreditation  
The Swiss Accreditation Service is one of the signatories to the EA  
Multilateral Agreement for the recognition of calibration certificates

Accreditation No.: **SCS 108**

Client **PC Test**

Certificate No: **ER3-2335\_Jul06**

## CALIBRATION CERTIFICATE

Object **ER3DV6 - SN:2335**

Calibration procedure(s) **QA CAL-02.v4  
Calibration procedure for E-field probes optimized for close near field  
evaluations in air**

Calibration date: **July 10, 2006**

Condition of the calibrated item **In Tolerance**

This calibration certificate documents the traceability to national standards, which realize the physical units of measurements (SI).  
The measurements and the uncertainties with confidence probability are given on the following pages and are part of the certificate.

All calibrations have been conducted in the closed laboratory facility: environment temperature (22 ± 3)°C and humidity < 70%.

Calibration Equipment used (M&TE critical for calibration)

Primary Standards	ID #	Cal Date (Calibrated by, Certificate No.)	Scheduled Calibration
Power meter E4419B	GB41293874	5-Apr-06 (METAS, No. 251-00557)	Apr-07
Power sensor E4412A	MY41495277	5-Apr-06 (METAS, No. 251-00557)	Apr-07
Power sensor E4412A	MY41498087	5-Apr-06 (METAS, No. 251-00557)	Apr-07
Reference 3 dB Attenuator	SN: S5054 (3c)	11-Aug-05 (METAS, No. 251-00499)	Aug-06
Reference 20 dB Attenuator	SN: S5086 (20b)	4-Apr-06 (METAS, No. 251-00558)	Apr-07
Reference 30 dB Attenuator	SN: S5129 (30b)	11-Aug-05 (METAS, No. 251-00500)	Aug-06
Reference Probe ER3DV6	SN: 2328	3-Oct-05 (SPEAG, No. ER3-2328_Oct05)	Oct-06
DAE4	SN: 654	2-Feb-06 (SPEAG, No. DAE4-654_Feb06)	Feb-07
Secondary Standards	ID #	Check Date (in house)	Scheduled Check
RF generator HP 8648C	US3642U01700	4-Aug-99 (SPEAG, in house check Nov-05)	In house check: Nov-07
Network Analyzer HP 8753E	US37390585	18-Oct-01 (SPEAG, in house check Nov-05)	In house check: Nov 06

	Name	Function	Signature
Calibrated by:	Katja Pokovic	Technical Manager	
Approved by:	Niels Kuster	Quality Manager	

Issued: July 10, 2006

This calibration certificate shall not be reproduced except in full without written approval of the laboratory.

Certificate No: ER3-2335\_Jul06

Page 1 of 9

FCC ID: BEJCU400	PCTEST	HAC (RF EMISSIONS) TEST REPORT	LG	Reviewed by: Quality Manager
HAC Filename: 0610110886	Test Dates: October 16 - 19, 2006	EUT Type: Dual-Band GSM/WCDMA Phone with Bluetooth		Page 40 of 74

**Calibration Laboratory of  
Schmid & Partner  
Engineering AG**  
Zeughausstrasse 43, 8004 Zurich, Switzerland



**S** Schweizerischer Kalibrierdienst  
**C** Service suisse d'étalonnage  
**S** Servizio svizzero di taratura  
**S** Swiss Calibration Service

Accredited by the Swiss Federal Office of Metrology and Accreditation  
The Swiss Accreditation Service is one of the signatories to the EA  
Multilateral Agreement for the recognition of calibration certificates

Accreditation No.: **SCS 108**

**Glossary:**

**NORM<sub>x,y,z</sub>** sensitivity in free space  
**DCP** diode compression point  
**Polarization  $\phi$**   $\phi$  rotation around probe axis  
**Polarization  $\vartheta$**   $\vartheta$  rotation around an axis that is in the plane normal to probe axis (at measurement center), i.e.,  $\vartheta = 0$  is normal to probe axis  
**Connector Angle** information used in DASY system to align probe sensor X to the robot coordinate system

**Calibration is Performed According to the Following Standards:**

- a) IEEE Std 1309-1996, " IEEE Standard for calibration of electromagnetic field sensors and probes, excluding antennas, from 9 kHz to 40 GHz", 1996.

**Methods Applied and Interpretation of Parameters:**

- **NORM<sub>x,y,z</sub>**: Assessed for E-field polarization  $\vartheta = 0$  for XY sensors and  $\vartheta = 90$  for Z sensor ( $f \leq 900$  MHz in TEM-cell;  $f > 1800$  MHz: R22 waveguide).
- **NORM(f)<sub>x,y,z</sub>** = **NORM<sub>x,y,z</sub>** \* *frequency\_response* (see Frequency Response Chart).
- **DCP<sub>x,y,z</sub>**: DCP are numerical linearization parameters assessed based on the data of power sweep (no uncertainty required). DCP does not depend on frequency.
- **Spherical isotropy (3D deviation from isotropy)**: in a locally homogeneous field realized using an open waveguide setup.
- **Sensor Offset**: The sensor offset corresponds to the offset of virtual measurement center from the probe tip (on probe axis). No tolerance required.
- **Connector Angle**: The angle is assessed using the information gained by determining the **NORM<sub>x</sub>** (no uncertainty required).

<b>FCC ID:</b> BEJCU400	<b>PCTEST</b> microtest	<b>HAC (RF EMISSIONS) TEST REPORT</b>	<b>LG</b>	<b>Reviewed by:</b> Quality Manager
<b>HAC Filename:</b> 0610110886	<b>Test Dates:</b> October 16 - 19, 2006	<b>EUT Type:</b> Dual-Band GSM/WCDMA Phone with Bluetooth	Page 41 of 74	



# Probe ER3DV6

## SN:2335

Manufactured: May 31, 2006  
Calibrated: July 10, 2006

Calibrated for DASY Systems

(Note: non-compatible with DASY2 system!)

FCC ID: BEJCU400	 <b>HAC (RF EMISSIONS) TEST REPORT</b> 		<b>Reviewed by:</b> Quality Manager
HAC Filename: 0610110886	Test Dates: October 16 - 19, 2006	EUT Type: Dual-Band GSM/WCDMA Phone with Bluetooth	Page 42 of 74

**DASY - Parameters of Probe: ER3DV6 SN:2335**

Sensitivity in Free Space [ $\mu\text{V}/(\text{V}/\text{m})^2$ ]		Diode Compression <sup>A</sup>	
NormX	1.62 ± 10.1 % (k=2)	DCP X	93 mV
NormY	1.67 ± 10.1 % (k=2)	DCP Y	93 mV
NormZ	1.90 ± 10.1 % (k=2)	DCP Z	95 mV

## Frequency Correction

X	0.0
Y	0.0
Z	0.0



## Sensor Offset (Probe Tip to Sensor Center)

X	2.5 mm
Y	2.5 mm
Z	2.5 mm

## Connector Angle 69 °

The reported uncertainty of measurement is stated as the standard uncertainty of measurement multiplied by the coverage factor k=2, which for a normal distribution corresponds to a coverage probability of approximately 95%.

<sup>A</sup> numerical linearization parameter: uncertainty not required

FCC ID: BEJCU400	 <b>PCTEST</b> Engineering Laboratory, Inc.	HAC (RF EMISSIONS) TEST REPORT	 LG	Reviewed by: Quality Manager
HAC Filename: 0610110886	Test Dates: October 16 - 19, 2006	EUT Type: Dual-Band GSM/WCDMA Phone with Bluetooth	Page 43 of 74	

### Frequency Response of E-Field (TEM-Cell:ifi110 EXX, Waveguide R22)

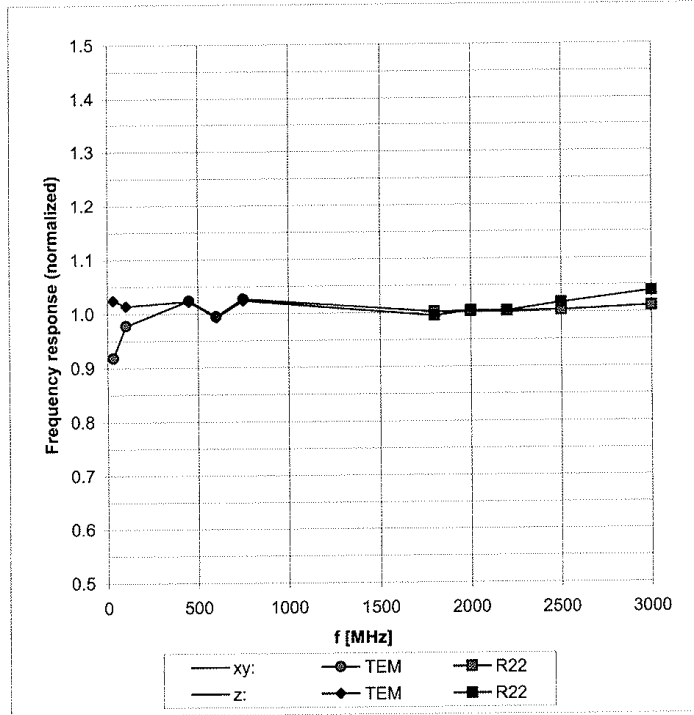

Uncertainty of Frequency Response of E-field:  $\pm 6.3\%$  (k=2)

FCC ID: BEJCU400	PCTEST	HAC (RF EMISSIONS) TEST REPORT	LG	Reviewed by: Quality Manager
HAC Filename: 0610110886	Test Dates: October 16 - 19, 2006	EUT Type: Dual-Band GSM/WCDMA Phone with Bluetooth		Page 44 of 74

Receiving Pattern ( $\phi$ ),  $\vartheta = 0^\circ$

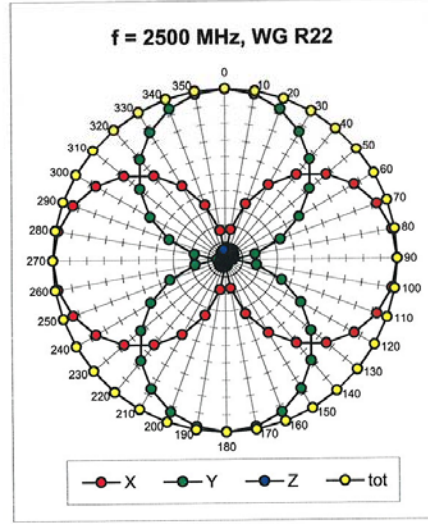
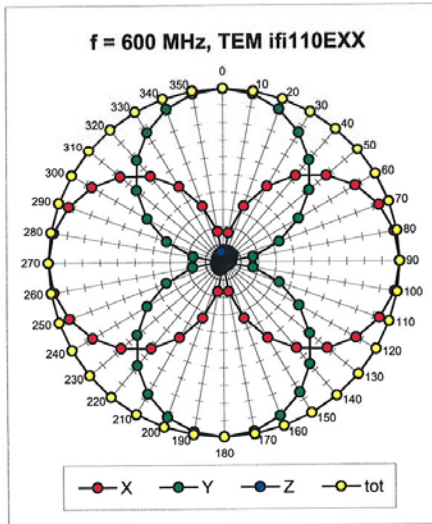

Receiving Pattern ( $\phi$ ),  $\vartheta = 90^\circ$

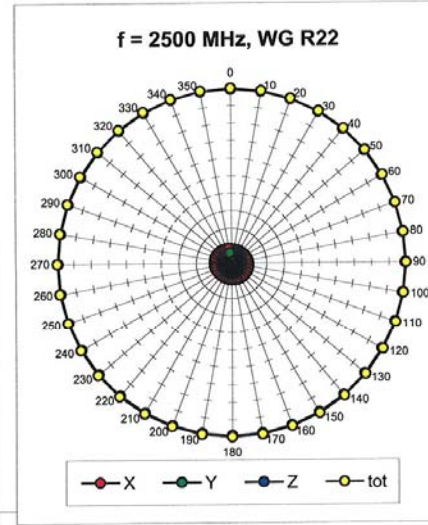
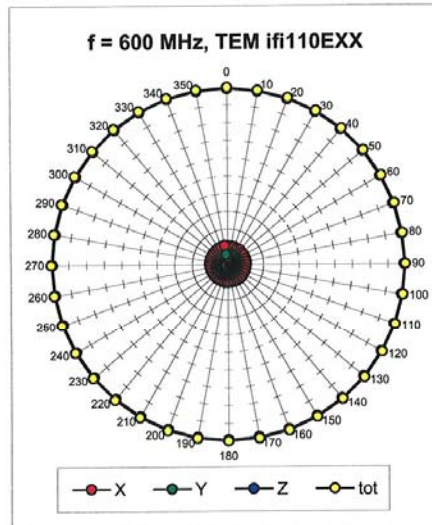

FCC ID: BEJCU400	PCTEST Engineering Laboratory, Inc.	HAC (RF EMISSIONS) TEST REPORT	LG	Reviewed by: Quality Manager
HAC Filename: 0610110886	Test Dates: October 16 - 19, 2006	EUT Type: Dual-Band GSM/WCDMA Phone with Bluetooth		Page 45 of 74

### Receiving Pattern ( $\phi$ ), $\vartheta = 0^\circ$

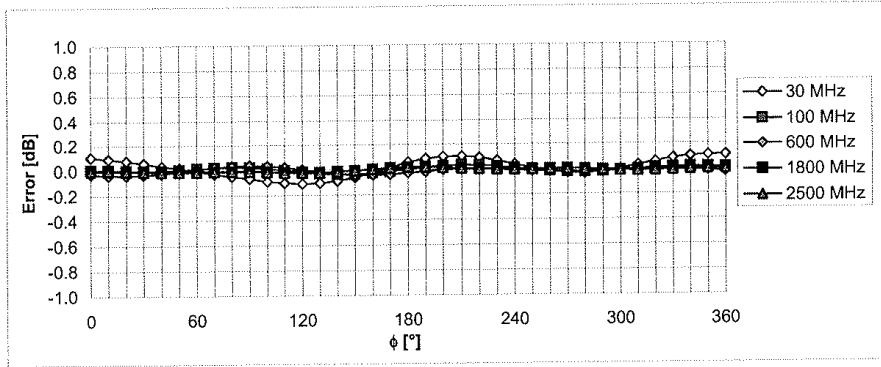

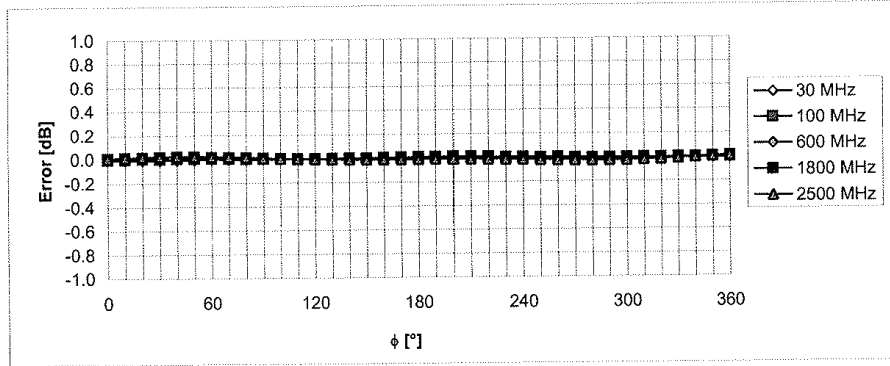

Uncertainty of Axial Isotropy Assessment:  $\pm 0.5\%$  (k=2)

### Receiving Pattern ( $\phi$ ), $\vartheta = 90^\circ$





Uncertainty of Axial Isotropy Assessment:  $\pm 0.5\%$  (k=2)

FCC ID: BEJCU400	 PCTEST wiredless	HAC (RF EMISSIONS) TEST REPORT	 LG	Reviewed by: Quality Manager
HAC Filename: 0610110886	Test Dates: October 16 - 19, 2006	EUT Type: Dual-Band GSM/WCDMA Phone with Bluetooth		Page 46 of 74

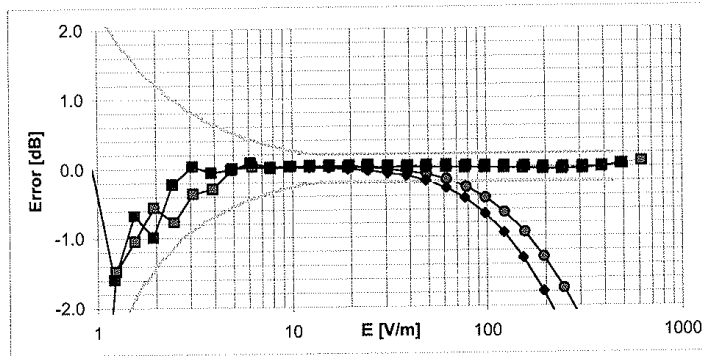
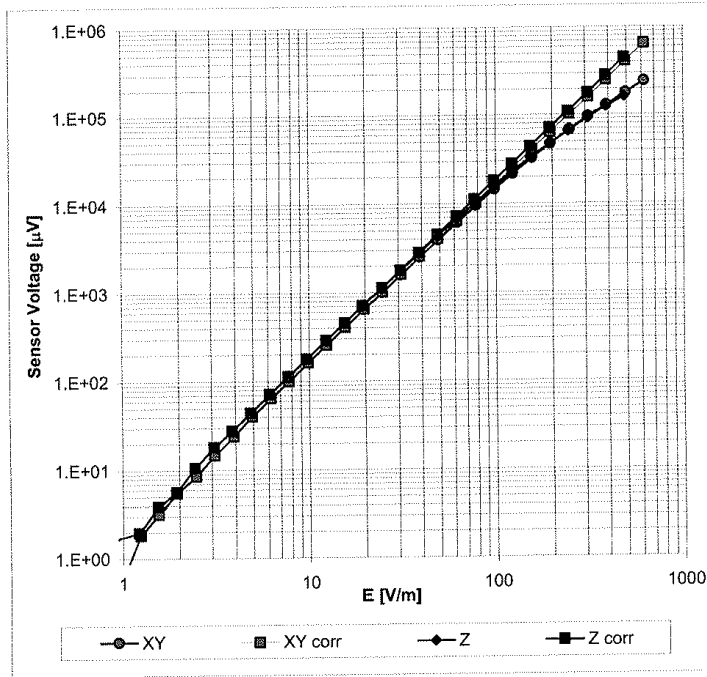
### Dynamic Range f(E-field) (Waveguide R22, f = 1800 MHz)





Uncertainty of Linearity Assessment:  $\pm 0.6\%$  (k=2)

FCC ID: BEJCU400	 PCTEST	HAC (RF EMISSIONS) TEST REPORT	 LG	Reviewed by: Quality Manager
HAC Filename: 0610110886	Test Dates: October 16 - 19, 2006	EUT Type: Dual-Band GSM/WCDMA Phone with Bluetooth		Page 47 of 74

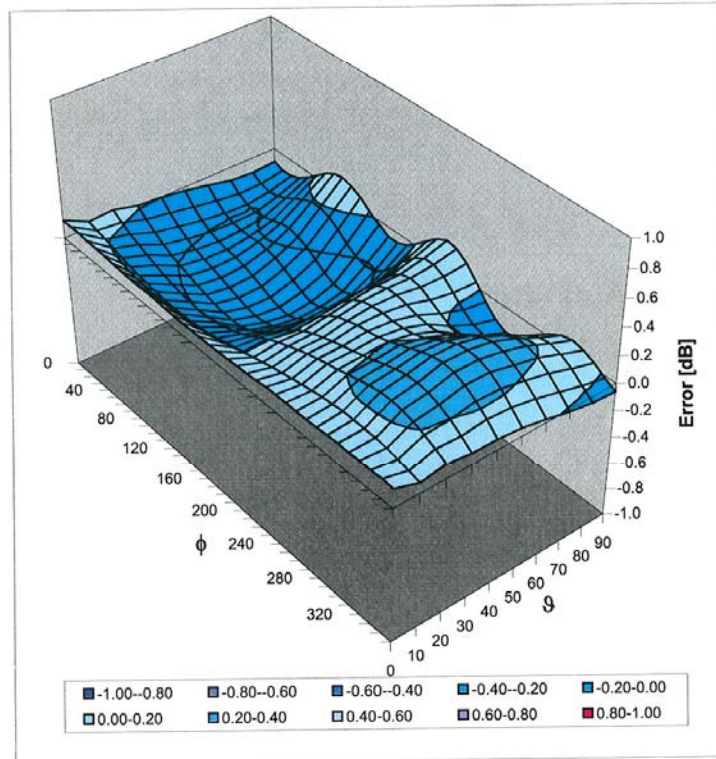
### Deviation from Isotropy in Air Error ( $\phi, \theta$ ), $f = 900$ MHz



Uncertainty of Spherical Isotropy Assessment:  $\pm 2.6\%$  ( $k=2$ )

<b>FCC ID:</b> BEJCU400		<b>HAC (RF EMISSIONS) TEST REPORT</b>	 <b>Reviewed by:</b> Quality Manager
<b>HAC Filename:</b> 0610110886	<b>Test Dates:</b> October 16 - 19, 2006	<b>EUT Type:</b> Dual-Band GSM/WCDMA Phone with Bluetooth	Page 48 of 74



Accredited by the Swiss Federal Office of Metrology and Accreditation  
The Swiss Accreditation Service is one of the signatories to the EA  
Multilateral Agreement for the recognition of calibration certificates

Accreditation No.: **SCS 108**

Client **PC Test**

Certificate No: **H3-6207\_Jul06**

## CALIBRATION CERTIFICATE

Object: **H3DV6 - SN:6207**

Calibration procedure(s): **QA CAL-03.v4  
Calibration procedure for H-field probes optimized for close near field  
evaluations in air**

Calibration date: **July 10, 2006**

Condition of the calibrated item: **In Tolerance**

This calibration certificate documents the traceability to national standards, which realize the physical units of measurements (SI).  
The measurements and the uncertainties with confidence probability are given on the following pages and are part of the certificate.

All calibrations have been conducted in the closed laboratory facility: environment temperature (22 ± 3)°C and humidity < 70%.

Calibration Equipment used (M&TE critical for calibration)

Primary Standards	ID #	Cal Date (Calibrated by, Certificate No.)	Scheduled Calibration
Power meter E4419B	GB41293874	5-Apr-06 (METAS, No. 251-00557)	Apr-07
Power sensor E4412A	MY41495277	5-Apr-06 (METAS, No. 251-00557)	Apr-07
Power sensor E4412A	MY41498087	5-Apr-06 (METAS, No. 251-00557)	Apr-07
Reference 3 dB Attenuator	SN: S5054 (3c)	11-Aug-05 (METAS, No. 251-00499)	Aug-06
Reference 20 dB Attenuator	SN: S5086 (20b)	4-Apr-06 (METAS, No. 251-00558)	Apr-07
Reference 30 dB Attenuator	SN: S5129 (30b)	11-Aug-05 (METAS, No. 251-00500)	Aug-06
Reference Probe H3DV6	SN: 6182	3-Oct-05 (SPEAG, No. H3-6182_Oct05)	Oct-06
DAE4	SN: 654	21-Jun-06 (SPEAG, No. DAE4-654_Jun06)	Jun-07

Secondary Standards	ID #	Check Date (in house)	Scheduled Check
RF generator HP 8648C	US3642U01700	4-Aug-99 (SPEAG, in house check Nov-05)	In house check: Nov-07
Network Analyzer HP 8753E	US37390585	18-Oct-01 (SPEAG, in house check Nov-05)	In house check: Nov 06

	Name	Function	Signature
Calibrated by:	Katja Pokovic	Technical Manager	
Approved by:	Niels Kuster	Quality Manager	

Issued: July 10, 2006

This calibration certificate shall not be reproduced except in full without written approval of the laboratory.

FCC ID: BEJCU400	PCTEST	HAC (RF EMISSIONS) TEST REPORT	LG	Reviewed by: Quality Manager
HAC Filename: 0610110886	Test Dates: October 16 - 19, 2006	EUT Type: Dual-Band GSM/WCDMA Phone with Bluetooth		Page 49 of 74

**Calibration Laboratory of  
Schmid & Partner  
Engineering AG**  
Zeughausstrasse 43, 8004 Zurich, Switzerland



**S** Schweizerischer Kalibrierdienst  
**C** Service suisse d'étalonnage  
**S** Servizio svizzero di taratura  
**S** Swiss Calibration Service

Accredited by the Swiss Federal Office of Metrology and Accreditation  
The Swiss Accreditation Service is one of the signatories to the EA  
Multilateral Agreement for the recognition of calibration certificates

Accreditation No.: **SCS 108**

**Glossary:**

**NORM<sub>x,y,z</sub>** sensitivity in free space  
**DCP** diode compression point  
**Polarization  $\phi$**   $\phi$  rotation around probe axis  
**Polarization  $\vartheta$**   $\vartheta$  rotation around an axis that is in the plane normal to probe axis (at measurement center), i.e.,  $\vartheta = 0$  is normal to probe axis  
**Connector Angle** information used in DASY system to align probe sensor X to the robot coordinate system

**Calibration is Performed According to the Following Standards:**

- a) IEEE Std 1309-1996, " IEEE Standard for calibration of electromagnetic field sensors and probes, excluding antennas, from 9 kHz to 40 GHz", 1996.

**Methods Applied and Interpretation of Parameters:**

- **X,Y,Z\_a0a1a2**: Assessed for E-field polarization  $\vartheta = 90$  for XY sensors and  $\vartheta = 0$  for Z sensor ( $f \leq 900$  MHz in TEM-cell;  $f > 1800$  MHz: R22 waveguide).
- **X,Y,Z(f)\_a0a1a2**= **X,Y,Z\_a0a1a2**\* *frequency\_response* (see Frequency Response Chart).
- **DCP<sub>x,y,z</sub>**: DCP are numerical linearization parameters assessed based on the data of power sweep (no uncertainty required). DCP does not depend on frequency.
- **Spherical isotropy (3D deviation from isotropy)**: in a locally homogeneous field realized using an open waveguide setup.
- **Sensor Offset**: The sensor offset corresponds to the offset of virtual measurement center from the probe tip (on probe axis). No tolerance required.
- **Connector Angle**: The angle is assessed using the information gained by determining the **X\_a0a1a2** (no uncertainty required).

<b>FCC ID:</b> BEJCU400	<b>PCTEST</b> microtest	<b>HAC (RF EMISSIONS) TEST REPORT</b>	<b>LG</b>	<b>Reviewed by:</b> Quality Manager
<b>HAC Filename:</b> 0610110886	<b>Test Dates:</b> October 16 - 19, 2006	<b>EUT Type:</b> Dual-Band GSM/WCDMA Phone with Bluetooth	Page 50 of 74	



# Probe H3DV6

## SN:6207

Manufactured: June 12, 2006  
Calibrated: July 10, 2006

Calibrated for DASY Systems

(Note: non-compatible with DASY2 system!)

FCC ID: BEJCU400	 <b>PCTEST</b> microtest	<b>HAC (RF EMISSIONS) TEST REPORT</b>	 <b>LG</b> <b>Reviewed by:</b> Quality Manager
<b>HAC Filename:</b> 0610110886	<b>Test Dates:</b> October 16 - 19, 2006	<b>EUT Type:</b> Dual-Band GSM/WCDMA Phone with Bluetooth	Page 51 of 74

**DASY - Parameters of Probe: H3DV6 SN:6207**

Sensitivity in Free Space [A/m /  $\sqrt{(\mu V)}$ ]

	a0	a1	a2
X	2.444E-03	-1.213E-4	9.909E-5 ± 5.1 % (k=2)
Y	2.476E-03	4.181E-6	1.653E-4 ± 5.1 % (k=2)
Z	2.973E-03	-1.666E-4	9.651E-5 ± 5.1 % (k=2)

Diode Compression<sup>1</sup>

DCP X	85 mV
DCP Y	85 mV
DCP Z	85 mV



Sensor Offset (Probe Tip to Sensor Center)

X	3.0 mm
Y	3.0 mm
Z	3.0 mm

Connector Angle -7 °

The reported uncertainty of measurement is stated as the standard uncertainty of measurement multiplied by the coverage factor k=2, which for a normal distribution corresponds to a coverage probability of approximately 95%.

<sup>1</sup> numerical linearization parameter: uncertainty not required

FCC ID: BEJCU400	 PCTEST	HAC (RF EMISSIONS) TEST REPORT	 LG	Reviewed by: Quality Manager
HAC Filename: 0610110886	Test Dates: October 16 - 19, 2006	EUT Type: Dual-Band GSM/WCDMA Phone with Bluetooth	Page 52 of 74	

### Frequency Response of H-Field (TEM-Cell:ifi110, Waveguide R22)

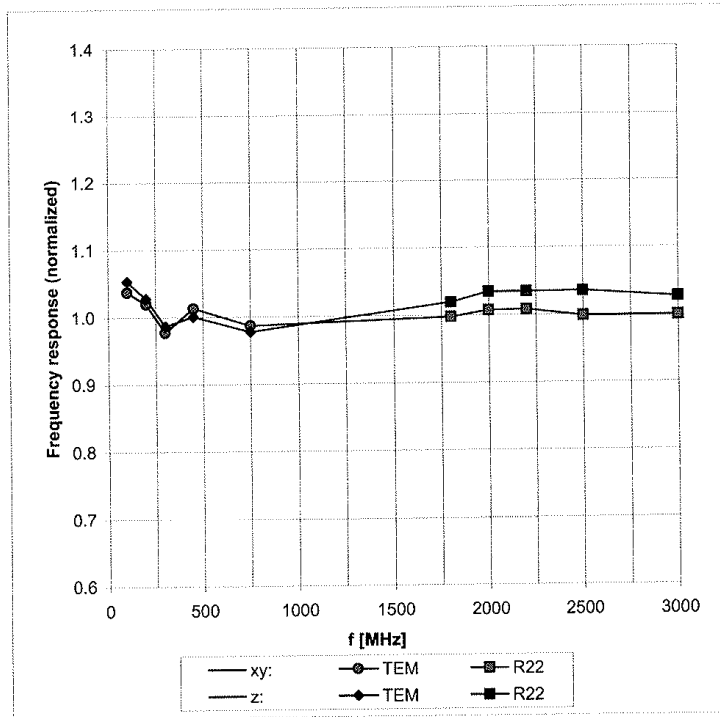

Uncertainty of Frequency Response of E-field: ± 6.3% (k=2)

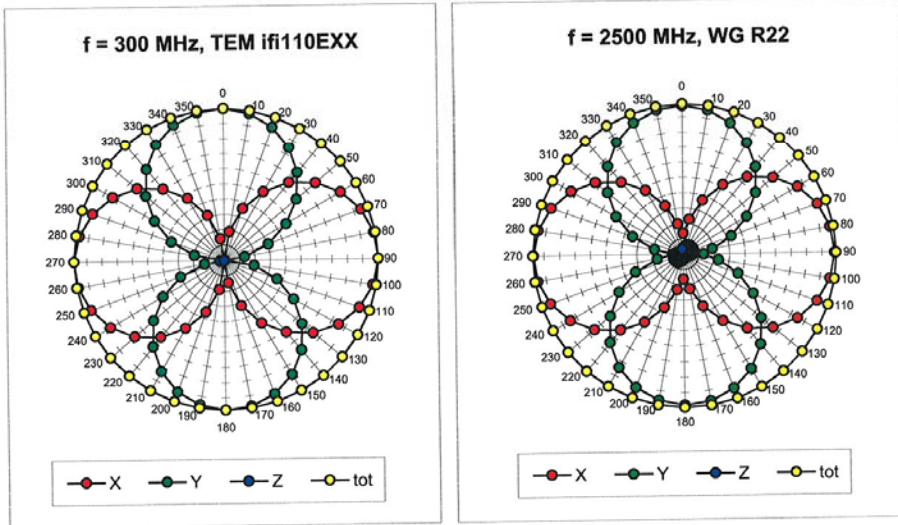

FCC ID: BEJCU400	PCTEST	HAC (RF EMISSIONS) TEST REPORT	LG	Reviewed by: Quality Manager
HAC Filename: 0610110886	Test Dates: October 16 - 19, 2006	EUT Type: Dual-Band GSM/WCDMA Phone with Bluetooth		Page 53 of 74

**Receiving Pattern ( $\phi$ ),  $\vartheta = 90^\circ$**

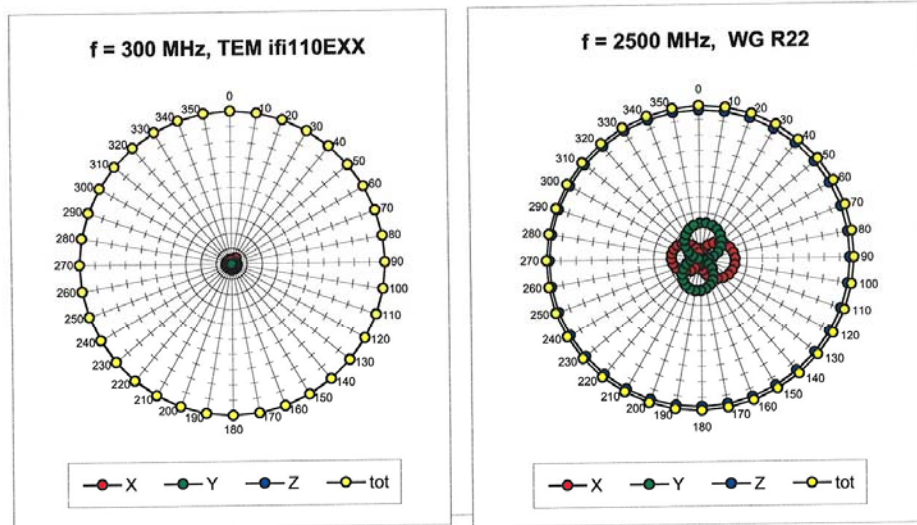

**Receiving Pattern ( $\phi$ ),  $\vartheta = 0^\circ$**



<p>FCC ID: BEJCU400</p>		<p>HAC (RF EMISSIONS) TEST REPORT</p>	 <p>Reviewed by: Quality Manager</p>
<p>HAC Filename: 0610110886</p>	<p>Test Dates: October 16 - 19, 2006</p>	<p>EUT Type: Dual-Band GSM/WCDMA Phone with Bluetooth</p>	<p>Page 54 of 74</p>

### Receiving Pattern ( $\phi$ ), $\vartheta = 90^\circ$

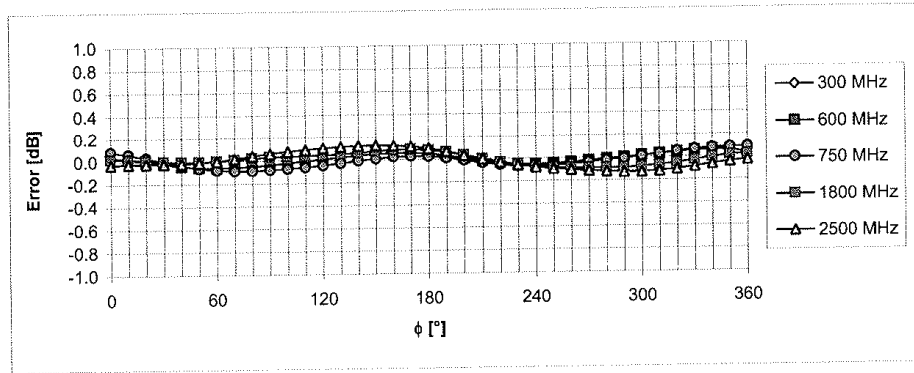

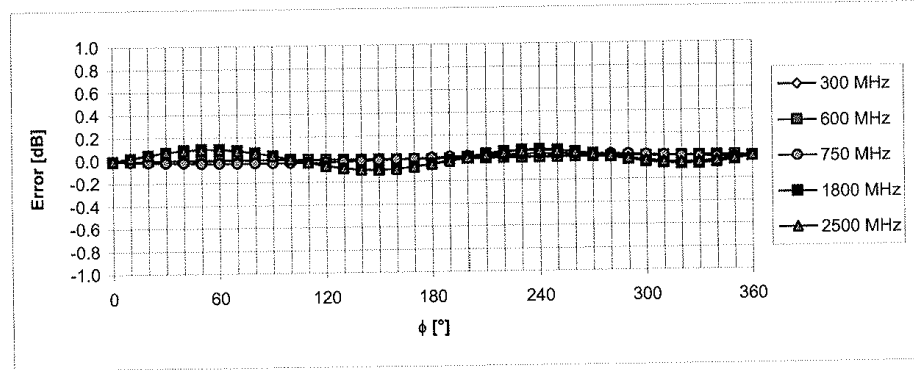

Uncertainty of Axial Isotropy Assessment:  $\pm 0.5\%$  (k=2)

### Receiving Pattern ( $\phi$ ), $\vartheta = 0^\circ$





Uncertainty of Axial Isotropy Assessment:  $\pm 0.5\%$  (k=2)

FCC ID: BEJCU400	 PCTEST	HAC (RF EMISSIONS) TEST REPORT	 LG	Reviewed by: Quality Manager
HAC Filename: 0610110886	Test Dates: October 16 - 19, 2006	EUT Type: Dual-Band GSM/WCDMA Phone with Bluetooth		Page 55 of 74

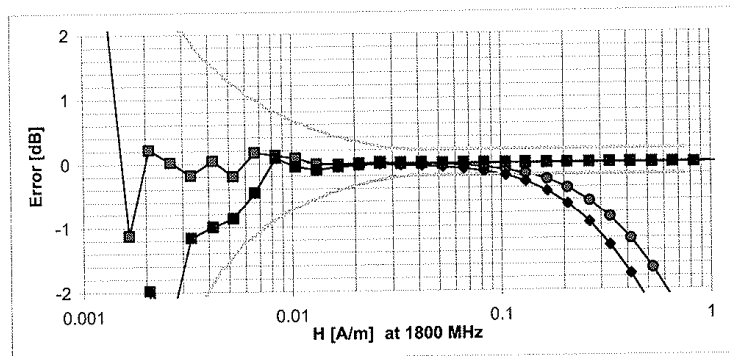
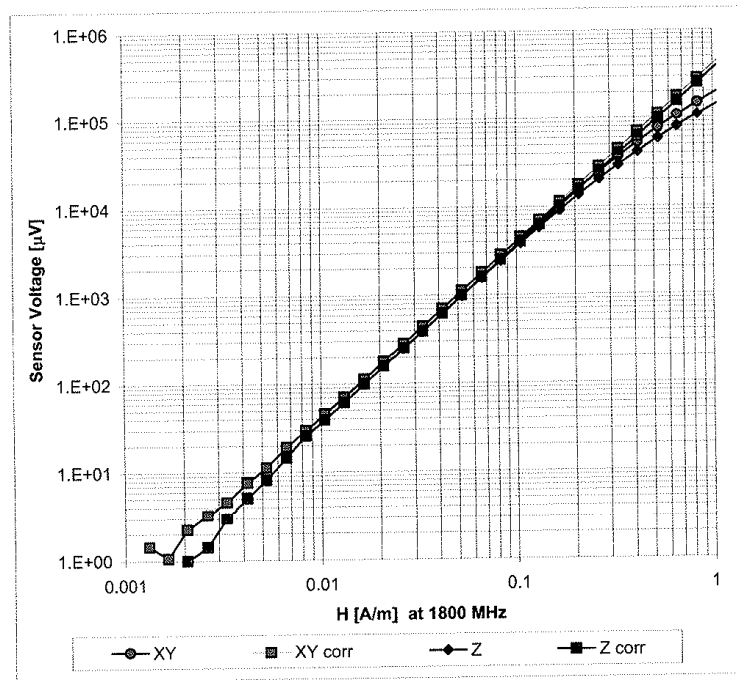
### Dynamic Range f(H-field) (Waveguide R22, f = 1800 MHz)



Uncertainty of Linearity Assessment:  $\pm 0.6\%$  (k=2)

FCC ID: BEJCU400	 PCTEST	HAC (RF EMISSIONS) TEST REPORT	 LG	Reviewed by: Quality Manager
HAC Filename: 0610110886	Test Dates: October 16 - 19, 2006	EUT Type: Dual-Band GSM/WCDMA Phone with Bluetooth		Page 56 of 74



Accredited by the Swiss Federal Office of Metrology and Accreditation  
**The Swiss Accreditation Service is one of the signatories to the EA  
Multilateral Agreement for the recognition of calibration certificates**

**Accreditation No.: SCS 108**

Client **PC Test**

Certificate No: **CD835V3-1082\_Jul06**

**CALIBRATION CERTIFICATE**

Object **CD835V3 - SN: 1082**

Calibration procedure(s) **QA CAL-20.v4  
Calibration procedure for dipoles in air**

Calibration date: **July 17, 2006**

Condition of the calibrated item **In Tolerance**

This calibration certificate documents the traceability to national standards, which realize the physical units of measurements (SI).  
All calibrations have been conducted in the closed laboratory facility: environment temperature (22 ± 3)°C and humidity < 70%.

Calibration Equipment used (M&TE critical for calibration)

Primary Standards	ID #	Cal Date (Calibrated by, Certificate No.)	Scheduled Calibration
Power meter EPM-442A	GB37480704	04-Oct-05 (METAS, No. 251-00516)	Oct-06
Power sensor HP 8481A	US37292783	04-Oct-05 (METAS, No. 251-00516)	Oct-06
Reference 20 dB Attenuator	SN: 5086 (20g)	11-Aug-05 (METAS, No 251-00498)	Aug-06
Reference 10 dB Attenuator	SN: 5047.2 (10r)	11-Aug-05 (METAS, No 251-00498)	Aug-06
DAE4	SN: 660	1-Mar-06 (SPEAG, No. DAE4-660_Mar06)	Calibration, Mar-07
Probe ER3DV6	SN: 2336	20-Dec-05 (SPEAG, No. ER3-2336_Dec05)	Calibration, Dec-06
Probe H3DV6	SN: 6065	20-Dec-05 (SPEAG, No. H3-6065-Dec05)	Calibration, Dec-06
Secondary Standards	ID #	Check Date (in house)	Scheduled Check
Power meter EPM-4419B	GB43310788	12-Aug-03 (SPEAG, in house check Oct-05)	In house check: Oct-06
Power sensor HP 8481A	MY41093312	10-Aug-03 (SPEAG, in house check Oct-05)	In house check: Oct-07
Power sensor HP 8481A	MY41093315	10-Aug-03 (SPEAG, in house check Oct-05)	In house check: Oct-06
Network Analyzer HP 8753E	US37390585	18-Oct-01 (SPEAG, in house check Nov-05)	In house check: Nov-06
RF generator R&S SMT06	SN: 100005	26-Jul-04 (SPEAG, in house check Nov-05)	In house check: Nov-07

Calibrated by: **Name: Mike Meili, Function: Laboratory Technician, Signature: M. Meili**

Approved by: **Fin Bomholt, Technical Director, Signature: F. Bomholt**

Issued: July 18, 2006

This calibration certificate shall not be reproduced except in full without written approval of the laboratory.

<b>FCC ID:</b> BEJCU400	<b>PCTEST</b>	<b>HAC (RF EMISSIONS) TEST REPORT</b>	<b>LG</b>	<b>Reviewed by:</b> Quality Manager
<b>HAC Filename:</b> 0610110886	<b>Test Dates:</b> October 16 - 19, 2006	<b>EUT Type:</b> Dual-Band GSM/WCDMA Phone with Bluetooth	Page 57 of 74	



Accredited by the Swiss Federal Office of Metrology and Accreditation  
**The Swiss Accreditation Service is one of the signatories to the EA  
Multilateral Agreement for the recognition of calibration certificates**

**Accreditation No.: SCS 108**

**References**

- [1] ANSI-PC63.19-2001 (Draft 3.x, 2005)  
American National Standard for Methods of Measurement of Compatibility between Wireless Communications Devices and Hearing Aids.

**Methods Applied and Interpretation of Parameters:**

- *Coordinate System:* y-axis is in the direction of the dipole arms. z-axis is from the basis of the antenna (mounted on the table) towards its feed point between the two dipole arms. x-axis is normal to the other axes. In coincidence with standard [1], the measurement planes (probe sensor center) are selected to be at a distance of 10 mm above the top edge of the dipole arms.
- *Measurement Conditions:* Further details are available from the hardcopies at the end of the certificate. All figures stated in the certificate are valid at the frequency indicated. The forward power to the dipole connector is set with a calibrated power meter connected and monitored with an auxiliary power meter connected to a directional coupler. While the dipole under test is connected, the forward power is adjusted to the same level.
- *Antenna Positioning:* The dipole is mounted on a HAC Test Arch phantom using the matching dipole positioner with the arms horizontal and the feeding cable coming from the floor. The measurements are performed in a shielded room with absorbers around the setup to reduce the reflections. It is verified before the mounting of the dipole under the Test Arch phantom, that its arms are perfectly in a line. It is installed on the HAC dipole positioner with its arms parallel below the dielectric reference wire and able to move elastically in vertical direction without changing its relative position to the top center of the Test Arch phantom. The vertical distance to the probe is adjusted after dipole mounting with a DASY4 Surface Check job. Before the measurement, the distance between phantom surface and probe tip is verified. The proper measurement distance is selected by choosing the matching section of the HAC Test Arch phantom with the proper device reference point (upper surface of the dipole) and the matching grid reference point (tip of the probe) considering the probe sensor offset. The vertical distance to the probe is essential for the accuracy.
- *Feed Point Impedance and Return Loss:* These parameters are measured using a HP 8753E Vector Network Analyzer. The impedance is specified at the SMA connector of the dipole. The influence of reflections was eliminated by applying the averaging function while moving the dipole in the air, at least 70cm away from any obstacles.
- *E-field distribution:* E field is measured in the x-y-plane with an isotropic ER3D-field probe with 100 mW forward power to the antenna feed point. In accordance with [1], the scan area is 20mm wide, its length exceeds the dipole arm length (180 or 90mm). The sensor center is 10 mm (in z) above the top of the dipole arms. Two 3D maxima are available near the end of the dipole arms. Assuming the dipole arms are perfectly in one line, the average of these two maxima (in subgrid 2 and subgrid 8) is determined to compensate for any non-parallelity to the measurement plane as well as the sensor displacement. The E-field value stated as calibration value represents the maximum of the interpolated 3D-E-field, 10mm above the dipole surface.
- *H-field distribution:* H-field is measured with an isotropic H-field probe with 100mW forward power to the antenna feed point, in the x-y-plane. The scan area and sensor distance is equivalent to the E-field scan. The maximum of the field is available at the center (subgrid 5) above the feed point. The H-field value stated as calibration value represents the maximum of the interpolated H-field, 10mm above the dipole surface at the feed point.

<b>FCC ID:</b> BEJCU400	<b>PCTEST</b>	<b>HAC (RF EMISSIONS) TEST REPORT</b>	<b>LG</b>	<b>Reviewed by:</b> Quality Manager
<b>HAC Filename:</b> 0610110886	<b>Test Dates:</b> October 16 - 19, 2006	<b>EUT Type:</b> Dual-Band GSM/WCDMA Phone with Bluetooth		Page 58 of 74

## 1 Measurement Conditions

DASY system configuration, as far as not given on page 1.

<b>DASY Version</b>	DASY4	V4.7 B44
<b>DASY PP Version</b>	SEMCAD	V1.8 B171
<b>Phantom</b>	HAC Test Arch	SD HAC P01 BA, #1002
<b>Distance Dipole Top - Probe Center</b>	10 mm	
<b>Scan resolution</b>	dx, dy = 5 mm	area = 20 x 180 mm
<b>Frequency</b>	<b>835 MHz ± 1 MHz</b>	
<b>Forward power at dipole connector</b>	20.0 dBm = 100mW	
<b>Input power drift</b>	< 0.05 dB	

## 2 Maximum Field values

<b>H-field 10 mm above dipole surface</b>	condition	<b>interpolated maximum</b>
Maximum measured	100 mW forward power	<b>0.454 A/m</b>

Uncertainty for H-field measurement: 8.2% (k=2)

<b>E-field 10 mm above dipole surface</b>	condition	<b>Interpolated maximum</b>
Maximum measured above high end	100 mW forward power	172.3 V/m
Maximum measured above low end	100 mW forward power	162.3 V/m
Averaged maximum above arm	100 mW forward power	<b>167.3 V/m</b>

Uncertainty for E-field measurement: 12.8% (k=2)

## 3 Appendix

### 3.1 Antenna Parameters

<b>Frequency</b>	<b>Return Loss</b>	<b>Impedance</b>
800 MHz	16.7 dB	( 43.5 – j12.2 ) Ohm
<b>835 MHz</b>	<b>27.6 dB</b>	<b>( 51.3 + j4.0 ) Ohm</b>
900 MHz	16.1 dB	( 57.4 – j15.4 ) Ohm
950 MHz	21.1 dB	( 44.3 + j6.0 ) Ohm
960 MHz	18.0 dB	( 49.0 + j12.6 ) Ohm



### 3.2 Antenna Design and Handling

The calibration dipole has a symmetric geometry with a built-in two stub matching network, which leads to the enhanced bandwidth.

The dipole is built of standard semirigid coaxial cable. The internal matching line is open ended. The antenna is therefore open for DC signals.

Do not apply force to dipole arms, as they are liable to bend. The soldered connections near the feedpoint may be damaged. After excessive mechanical stress or overheating, check the impedance characteristics to ensure that the internal matching network is not affected.

After long term use with 40W radiated power, only a slight warming of the dipole near the feedpoint can be measured.

<b>FCC ID:</b> BEJCU400	 <b>PCTEST</b> Engineering Laboratory, Inc.	<b>HAC (RF EMISSIONS) TEST REPORT</b>	 <b>LG</b>	<b>Reviewed by:</b> Quality Manager
<b>HAC Filename:</b> 0610110886	<b>Test Dates:</b> October 16 - 19, 2006	<b>EUT Type:</b> Dual-Band GSM/WCDMA Phone with Bluetooth	Page 59 of 74	

### 3.3 Measurement Sheets

#### 3.3.1 Return Loss and Smith Chart

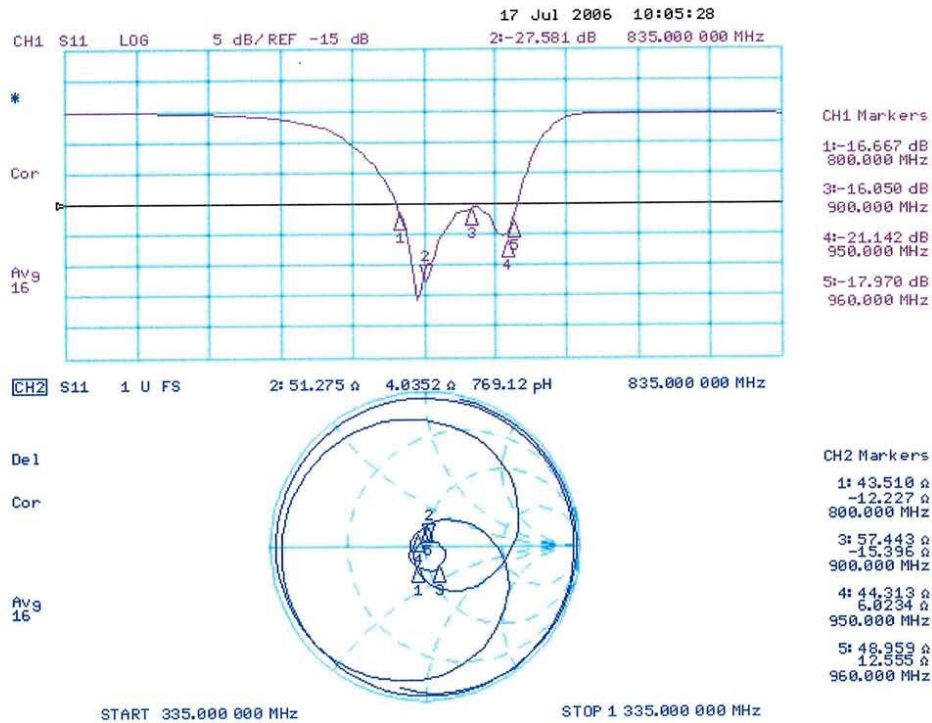

FCC ID: BEJCU400	PCTEST microtest	HAC (RF EMISSIONS) TEST REPORT	LG	Reviewed by: Quality Manager
HAC Filename: 0610110886	Test Dates: October 16 - 19, 2006	EUT Type: Dual-Band GSM/WCDMA Phone with Bluetooth		Page 60 of 74

**3.3.2 DASY4 H-field result**

Date/Time: 7/17/2006 2:56:42 PM

Test Laboratory: SPEAG, Zurich, Switzerland  
 File Name: [H\\_CD835\\_1082\\_060717.da4](#)

**DUT: HAC-Dipole 835 MHz; Type: D835V3; Serial: 1082**  
**Program Name: HAC H Dipole**

Communication System: CW; Frequency: 835 MHz; Duty Cycle: 1:1  
 Medium: Air Medium parameters used:  $\sigma = 0$  mho/m,  $\epsilon_r = 1$ ;  $\rho = 1$  kg/m<sup>3</sup>  
 Phantom section: H Dipole Section

DASY4 Configuration:  
 - Probe: H3DV6 - SN6065; ; Calibrated: 12/20/2005  
 - Sensor-Surface: (Fix Surface)  
 - Electronics: DAE4 Sn660; Calibrated: 3/1/2006  
 - Phantom: HAC Test Arch 4.6; Type: SD HAC P01 BA; Serial: 1002  
 - Measurement SW: DASY4, V4.7 Build 44; Postprocessing SW: SEMCAD, V1.8 Build 171

**H Scan - Sensor Center 10mm above CD835 Dipole/Hearing Aid Compatibility Test (41x361x1): Measurement grid:**  
 dx=5mm, dy=5mm  
 Maximum value of peak Total field = 0.454 A/m  
 Probe Modulation Factor = 1.00  
 Reference Value = 0.482 A/m; Power Drift = -0.014 dB  
**Hearing Aid Near-Field Category: M2 (AWF 0 dB)**

Peak H-field in A/m

Grid 1	Grid 2	Grid 3
0.372	0.402	0.386
Grid 4	Grid 5	Grid 6
0.425	0.454	0.438
Grid 7	Grid 8	Grid 9
0.379	0.404	0.388

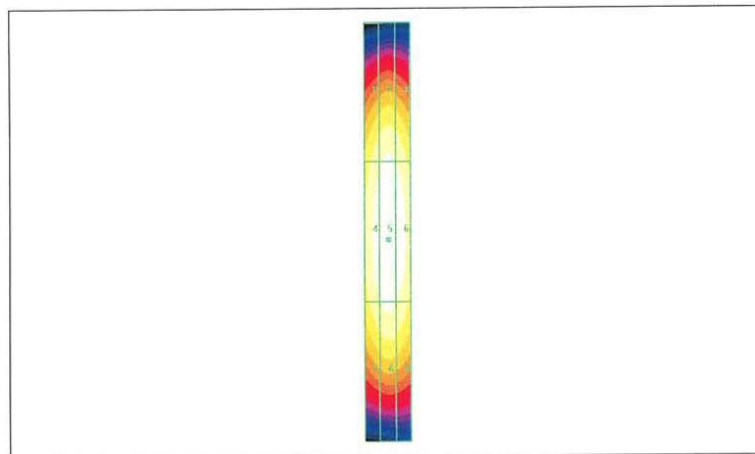
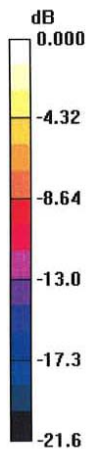

0 dB = 0.454A/m

FCC ID: BEJCU400	PCTEST	HAC (RF EMISSIONS) TEST REPORT	LG	Reviewed by: Quality Manager
HAC Filename: 0610110886	Test Dates: October 16 - 19, 2006	EUT Type: Dual-Band GSM/WCDMA Phone with Bluetooth		Page 61 of 74

**3.3.3 DASY4 E-Field result**

Date/Time: 7/17/2006 11:50:47 AM

Test Laboratory: SPEAG, Zurich, Switzerland  
 File Name: [E\\_CD835\\_1082\\_060717.da4](#)

**DUT: HAC-Dipole 835 MHz; Type: D835V3; Serial: 1082**  
**Program Name: HAC E Dipole**

Communication System: CW; Frequency: 835 MHz; Duty Cycle: 1:1  
 Medium: Air Medium parameters used:  $\sigma = 0$  mho/m,  $\epsilon_r = 1$ ;  $\rho = 1000$  kg/m<sup>3</sup>  
 Phantom section: E Dipole Section

DASY4 Configuration:  
 - Probe: ER3DV6 - SN2336; ConvF(1, 1, 1); Calibrated: 12/20/2005  
 - Sensor-Surface: (Fix Surface)  
 - Electronics: DAE4 Sn660; Calibrated: 3/1/2006  
 - Phantom: HAC Test Arch 4.6; Type: SD HAC P01 BA; Serial: 1002  
 - Measurement SW: DASY4, V4.7 Build 44; Postprocessing SW: SEMCAD, V1.8 Build 171

**E Scan - Sensor Center 10mm above CD835 Dipole/Hearing Aid Compatibility Test (41x361x1):** Measurement grid:  
 dx=5mm, dy=5mm  
 Maximum value of peak Total field = 172.3 V/m  
 Probe Modulation Factor = 1.00  
 Reference Value = 122.7 V/m; Power Drift = -0.030 dB  
**Hearing Aid Near-Field Category: M2 (AWF 0 dB)**

Peak E-field in V/m

Grid 1	Grid 2	Grid 3
166.8	172.3	165.8
Grid 4	Grid 5	Grid 6
84.7	88.9	87.9
Grid 7	Grid 8	Grid 9
154.6	162.3	160.4

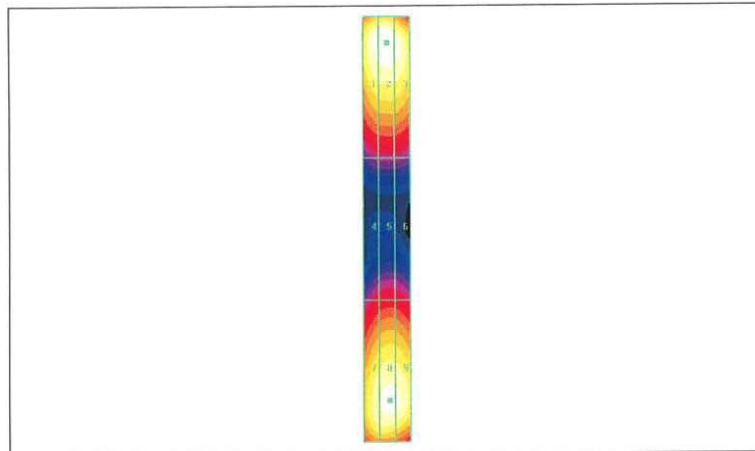
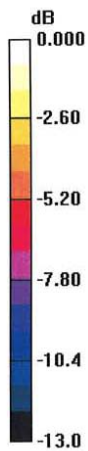

0 dB = 172.3V/m

FCC ID: BEJCU400	PCTEST	HAC (RF EMISSIONS) TEST REPORT	LG	Reviewed by: Quality Manager
HAC Filename: 0610110886	Test Dates: October 16 - 19, 2006	EUT Type: Dual-Band GSM/WCDMA Phone with Bluetooth	Page 62 of 74	



Accredited by the Swiss Federal Office of Metrology and Accreditation  
The Swiss Accreditation Service is one of the signatories to the EA  
Multilateral Agreement for the recognition of calibration certificates

Accreditation No.: **SCS 108**

Client **PC Test**

Certificate No: **CD1880V3-1064\_Jul06**

## CALIBRATION CERTIFICATE

Object **CD1880V3 - SN: 1064**

Calibration procedure(s) **QA CAL-20.v4  
Calibration procedure for dipoles in air**

Calibration date: **July 18, 2006**

Condition of the calibrated item **In Tolerance**

This calibration certificate documents the traceability to national standards, which realize the physical units of measurements (SI).  
All calibrations have been conducted in the closed laboratory facility: environment temperature ( $22 \pm 3$ )°C and humidity < 70%.

Calibration Equipment used (M&TE critical for calibration)

Primary Standards	ID #	Cal Date (Calibrated by, Certificate No.)	Scheduled Calibration
Power meter EPM-442A	GB37480704	04-Oct-05 (METAS, No. 251-00516)	Oct-06
Power sensor HP 8481A	US37292783	04-Oct-05 (METAS, No. 251-00516)	Oct-06
Reference 20 dB Attenuator	SN: 5086 (20g)	11-Aug-05 (METAS, No 251-00498)	Aug-06
Reference 10 dB Attenuator	SN: 5047.2 (10r)	11-Aug-05 (METAS, No 251-00498)	Aug-06
DAE4	SN: 660	1-Mar-06 (SPEAG, No. DAE4-660_Mar06)	Calibration, Mar-07
Probe ER3DV6	SN: 2336	20-Dec-05 (SPEAG, No. ER3-2336_Dec05)	Calibration, Dec-06
Probe H3DV6	SN: 6065	20-Dec-05 (SPEAG, No. H3-6065-Dec05)	Calibration, Dec-06

Secondary Standards	ID #	Check Date (in house)	Scheduled Check
Power meter EPM-4419B	GB43310788	12-Aug-03 (SPEAG, in house check Oct-05)	In house check: Oct-06
Power sensor HP 8481A	MY41093312	10-Aug-03 (SPEAG, in house check Oct-05)	In house check: Oct-07
Power sensor HP 8481A	MY41093315	10-Aug-03 (SPEAG, in house check Oct-05)	In house check: Oct-06
Network Analyzer HP 8753E	US37390585	18-Oct-01 (SPEAG, in house check Nov-05)	In house check: Nov-06
RF generator R&S SMT06	SN: 100005	26-Jul-04 (SPEAG, in house check Nov-05)	In house check: Nov-07

Calibrated by:	Name Mike Meili	Function Laboratory Technician	Signature 
Approved by:	Name Fin Bomholt	Technical Director	

Issued: July 20, 2006

This calibration certificate shall not be reproduced except in full without written approval of the laboratory.

Certificate No: CD1880V3-1064\_Jul06

Page 1 of 6

FCC ID: BEJCU400	<b>PCTEST</b> microtest	<b>HAC (RF EMISSIONS) TEST REPORT</b>	<b>LG</b>	Reviewed by: Quality Manager
HAC Filename: 0610110886	Test Dates: October 16 - 19, 2006	EUT Type: Dual-Band GSM/WCDMA Phone with Bluetooth	Page 63 of 74	



Accredited by the Swiss Federal Office of Metrology and Accreditation  
The Swiss Accreditation Service is one of the signatories to the EA  
Multilateral Agreement for the recognition of calibration certificates

Accreditation No.: **SCS 108**

**References**

- [1] ANSI-PC63.19-2001 (Draft 3.x, 2005)  
American National Standard for Methods of Measurement of Compatibility between Wireless  
Communications Devices and Hearing Aids.

**Methods Applied and Interpretation of Parameters:**

- *Coordinate System:* y-axis is in the direction of the dipole arms. z-axis is from the basis of the antenna (mounted on the table) towards its feed point between the two dipole arms. x-axis is normal to the other axes. In coincidence with standard [1], the measurement planes (probe sensor center) are selected to be at a distance of 10 mm above the top edge of the dipole arms.
- *Measurement Conditions:* Further details are available from the hardcopies at the end of the certificate. All figures stated in the certificate are valid at the frequency indicated. The forward power to the dipole connector is set with a calibrated power meter connected and monitored with an auxiliary power meter connected to a directional coupler. While the dipole under test is connected, the forward power is adjusted to the same level.
- *Antenna Positioning:* The dipole is mounted on a HAC Test Arch phantom using the matching dipole positioner with the arms horizontal and the feeding cable coming from the floor. The measurements are performed in a shielded room with absorbers around the setup to reduce the reflections. It is verified before the mounting of the dipole under the Test Arch phantom, that its arms are perfectly in a line. It is installed on the HAC dipole positioner with its arms parallel below the dielectric reference wire and able to move elastically in vertical direction without changing its relative position to the top center of the Test Arch phantom. The vertical distance to the probe is adjusted after dipole mounting with a DASY4 Surface Check job. Before the measurement, the distance between phantom surface and probe tip is verified. The proper measurement distance is selected by choosing the matching section of the HAC Test Arch phantom with the proper device reference point (upper surface of the dipole) and the matching grid reference point (tip of the probe) considering the probe sensor offset. The vertical distance to the probe is essential for the accuracy.
- *Feed Point Impedance and Return Loss:* These parameters are measured using a HP 8753E Vector Network Analyzer. The impedance is specified at the SMA connector of the dipole. The influence of reflections was eliminated by applying the averaging function while moving the dipole in the air, at least 70cm away from any obstacles.
- *E-field distribution:* E field is measured in the x-y-plane with an isotropic ER3D-field probe with 100 mW forward power to the antenna feed point. In accordance with [1], the scan area is 20mm wide, its length exceeds the dipole arm length (180 or 90mm). The sensor center is 10 mm (in z) above the top of the dipole arms. Two 3D maxima are available near the end of the dipole arms. Assuming the dipole arms are perfectly in one line, the average of these two maxima (in subgrid 2 and subgrid 8) is determined to compensate for any non-parallelity to the measurement plane as well as the sensor displacement. The E-field value stated as calibration value represents the maximum of the interpolated 3D-E-field, 10mm above the dipole surface.
- *H-field distribution:* H-field is measured with an isotropic H-field probe with 100mW forward power to the antenna feed point, in the x-y-plane. The scan area and sensor distance is equivalent to the E-field scan. The maximum of the field is available at the center (subgrid 5) above the feed point. The H-field value stated as calibration value represents the maximum of the interpolated H-field, 10mm above the dipole surface at the feed point.

<b>FCC ID:</b> BEJCU400	<b>PCTEST</b>	<b>HAC (RF EMISSIONS) TEST REPORT</b>	<b>LG</b>	<b>Reviewed by:</b> Quality Manager
<b>HAC Filename:</b> 0610110886	<b>Test Dates:</b> October 16 - 19, 2006	<b>EUT Type:</b> Dual-Band GSM/WCDMA Phone with Bluetooth	Page 64 of 74	

## 1 Measurement Conditions

DASY system configuration, as far as not given on page 1.

<b>DASY Version</b>	DASY4	V4.7B44
<b>DASY PP Version</b>	SEMCAD	V1.8 B171
<b>Phantom</b>	HAC Test Arch	SD HAC P01 BA, #1002
<b>Distance Dipole Top - Probe Center</b>	10 mm	
<b>Scan resolution</b>	dx, dy = 5 mm	area = 20 x 90 mm
<b>Frequency</b>	<b>1880 MHz ± 1 MHz</b>	
<b>Forward power at dipole connector</b>	20.0 dBm = 100mW	
<b>Input power drift</b>	< 0.05 dB	

## 2 Maximum Field values

H-field 10 mm above dipole surface	condition	Interpolated maximum
Maximum measured	100 mW forward power	<b>0.451 A/m</b>

Uncertainty for H-field measurement: 8.2% (k=2)

E-field 10 mm above dipole surface	condition	Interpolated maximum
Maximum measured above high end	100 mW forward power	137.9 V/m
Maximum measured above low end	100 mW forward power	131.3 V/m
Averaged maximum above arm	100 mW forward power	<b>134.6 V/m</b>

Uncertainty for E-field measurement: 12.8% (k=2)

## 3 Appendix

### 3.1 Antenna Parameters

Frequency	Return Loss	Impedance
1710 MHz	20.4 dB	( 49.1 + j9.5 ) Ohm
<b>1880 MHz</b>	<b>22.1 dB</b>	<b>( 50.7 + j7.9 ) Ohm</b>
1900 MHz	22.5 dB	( 52.6 + j7.2 ) Ohm
1950 MHz	30.6 dB	( 53.0 – j0.3 ) Ohm
2000 MHz	20.8 dB	( 41.8 + j1.7 ) Ohm



### 3.2 Antenna Design and Handling

The calibration dipole has a symmetric geometry with a built-in two stub matching network, which leads to the enhanced bandwidth.

The dipole is built of standard semirigid coaxial cable. The internal matching line is open ended. The antenna is therefore open for DC signals.

Do not apply force to dipole arms, as they are liable to bend. The soldered connections near the feedpoint may be damaged. After excessive mechanical stress or overheating, check the impedance characteristics to ensure that the internal matching network is not affected.

After long term use with 40W radiated power, only a slight warming of the dipole near the feedpoint can be measured.

<b>FCC ID:</b> BEJCU400	 <b>PCTEST</b> Engineering Laboratory	<b>HAC (RF EMISSIONS) TEST REPORT</b>	 <b>LG</b>	<b>Reviewed by:</b> Quality Manager
<b>HAC Filename:</b> 0610110886	<b>Test Dates:</b> October 16 - 19, 2006	<b>EUT Type:</b> Dual-Band GSM/WCDMA Phone with Bluetooth	Page 65 of 74	

### 3.3 Measurement Sheets

#### 3.3.1 Return Loss and Smith Chart

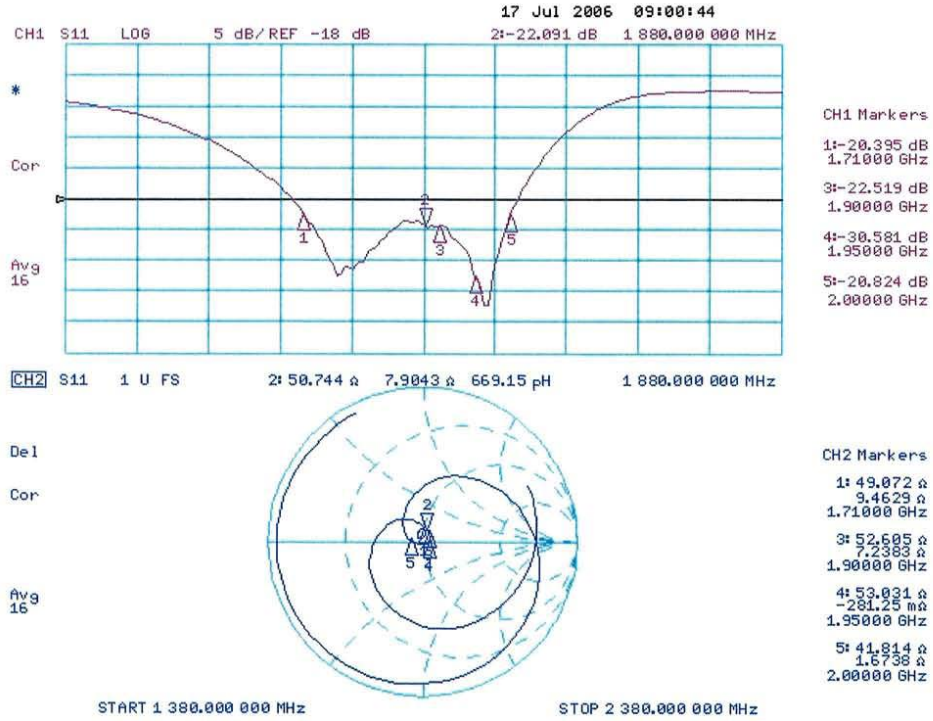

FCC ID: BEJCU400	PCTEST microtest	HAC (RF EMISSIONS) TEST REPORT	LG	Reviewed by: Quality Manager
HAC Filename: 0610110886	Test Dates: October 16 - 19, 2006	EUT Type: Dual-Band GSM/WCDMA Phone with Bluetooth		Page 66 of 74

**3.3.2 DASY4 H-field result**

Date/Time: 7/18/2006 10:16:29 AM

Test Laboratory: SPEAG, Zurich, Switzerland

**DUT: HAC Dipole 1880 MHz; Type: CD1880V3; Serial: 1064**

Communication System: CW; Frequency: 1880 MHz; Duty Cycle: 1:1

Medium: Air

Medium parameters used:  $\sigma = 0$  mho/m,  $\epsilon_r = 1$ ;  $\rho = 1$  kg/m<sup>3</sup>

Phantom section: H Dipole Section

DASY4 Configuration:

- Probe: H3DV6 - SN6065; Calibrated: 12/20/2005
- Sensor-Surface: (Fix Surface)
- Electronics: DAE4 Sn660; Calibrated: 3/1/2006
- Phantom: HAC Test Arch 4.6; Type: SD HAC P01 BA; Serial: 1002
- Measurement SW: DASY4, V4.7 Build 44; Postprocessing SW: SEMCAD, V1.8 Build 171

**H Scan - Sensor Center 10mm above CD1880V3 Dipole/Hearing Aid Compatibility Test (41x181x1):**

Measurement grid: dx=5mm, dy=5mm

Maximum value of peak Total field = 0.451 A/m

Probe Modulation Factor = 1.00

Reference Value = 0.476 A/m; Power Drift = -0.002 dB



**Hearing Aid Near-Field Category: M2 (AWF 0 dB)**

Peak H-field in A/m

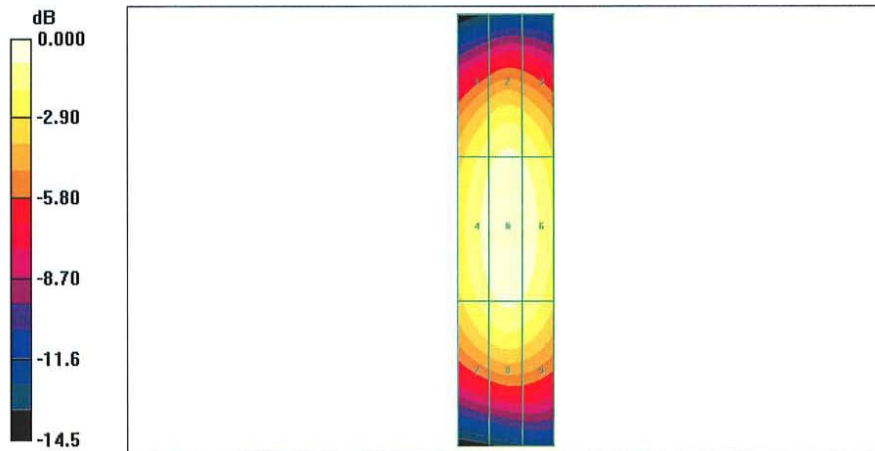
Grid 1	Grid 2	Grid 3
0.389	0.417	0.402
Grid 4	Grid 5	Grid 6
0.425	0.451	0.437
Grid 7	Grid 8	Grid 9
0.387	0.412	0.398



0 dB = 0.451A/m

FCC ID: BEJCU400	 <b>PCTEST</b> microtest	<b>HAC (RF EMISSIONS) TEST REPORT</b>	 <b>LG</b>	<b>Reviewed by:</b> Quality Manager
<b>HAC Filename:</b> 0610110886	<b>Test Dates:</b> October 16 - 19, 2006	<b>EUT Type:</b> Dual-Band GSM/WCDMA Phone with Bluetooth	Page 67 of 74	

**3.3.3 DASY4 E-Field result**

Date/Time: 7/18/2006 11:51:17 AM

Test Laboratory: SPEAG, Zurich, Switzerland

**DUT: HAC Dipole 1880 MHz; Type: CD1880V3; Serial: 1064**

Communication System: CW; Frequency: 1880 MHz; Duty Cycle: 1:1

Medium: Air

Medium parameters used:  $\sigma = 0$  mho/m,  $\epsilon_r = 1$ ;  $\rho = 1000$  kg/m<sup>3</sup>

Phantom section: E Dipole Section

DASY4 Configuration:

- Probe: ER3DV6 - SN2336; ConvF(1, 1, 1); Calibrated: 12/20/2005
- Sensor-Surface: (Fix Surface)
- Electronics: DAE4 Sn660; Calibrated: 3/1/2006
- Phantom: HAC Test Arch 4.6; Type: SD HAC P01 BA; Serial: 1002
- Measurement SW: DASY4, V4.7 Build 44; Postprocessing SW: SEMCAD, V1.8 Build 171

**E Scan - Sensor Center 10mm above CD1880V3 Dipole/Hearing Aid Compatibility Test (41x181x1):**

Measurement grid: dx=5mm, dy=5mm

Maximum value of peak Total field = 137.9 V/m

Probe Modulation Factor = 1.00

Reference Value = 132.3 V/m; Power Drift = 0.013 dB

**Hearing Aid Near-Field Category: M2 (AWF 0 dB)**

Peak E-field in V/m

Grid 1	Grid 2	Grid 3
134.7	137.9	131.1
Grid 4	Grid 5	Grid 6
86.8	90.4	88.7
Grid 7	Grid 8	Grid 9
128.1	131.3	127.7

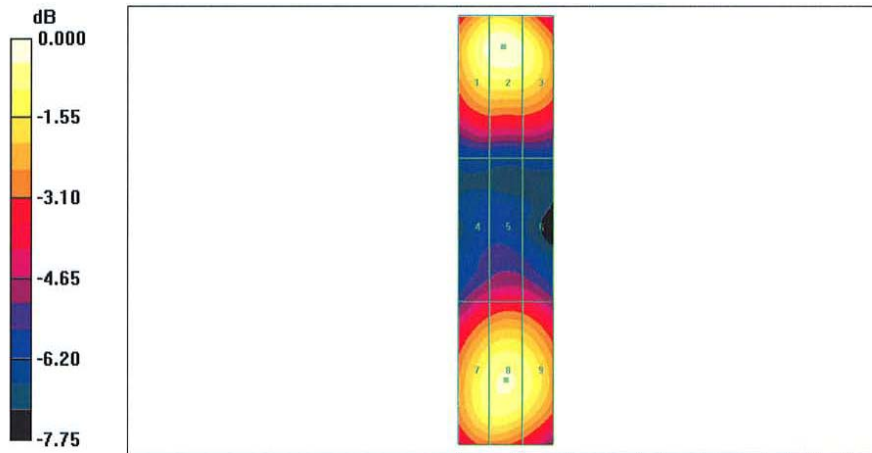



0 dB = 137.9V/m

FCC ID: BEJCU400	PCTEST microtest	HAC (RF EMISSIONS) TEST REPORT	LG	Reviewed by: Quality Manager
HAC Filename: 0610110886	Test Dates: October 16 - 19, 2006	EUT Type: Dual-Band GSM/WCDMA Phone with Bluetooth	Page 68 of 74	

## 15. CONCLUSION



The measurements indicate that the wireless communications device complies with the HAC limits specified in accordance with the ANSI C63.19 Standard and FCC WT Docket No. 01-309 RM-8658. Precise laboratory measures were taken to assure repeatability of the tests. The tested device complies with the requirements in respect to all parameters specific to the test. The test results and statements relate only to the item(s) tested.

Please note that the M-rating for this equipment only represents the field interference possible against a hypothetical and typical hearing aid. The measurement system and techniques presented in this evaluation are proposed in the ANSI standard as a means of best approximating wireless device compatibility with a hearing-aid. The literature is under continual re-construction.



<b>FCC ID:</b> BEJCU400	 <b>PCTEST</b> wired wireless	<b>HAC (RF EMISSIONS) TEST REPORT</b>	 <b>LG</b>	<b>Reviewed by:</b> Quality Manager
<b>HAC Filename:</b> 0610110886	<b>Test Dates:</b> October 16 - 19, 2006	<b>EUT Type:</b> Dual-Band GSM/WCDMA Phone with Bluetooth	Page 69 of 74	

## 16. REFERENCES

1. ANSI C63.19-2006 v3.12, American National Standard for Methods of Measurement of Compatibility between Wireless communication devices and Hearing Aids.", New York, NY, IEEE, January 2006
2. FCC Public Notice DA 06-1215, *Wireless Telecommunications Bureau and Office of Engineering and Technology Clarify Use of Revised Wireless Phone Hearing Aid Compatibility Standard*, June 6, 2006
3. Berger, H. S., "Compatibility Between Hearing Aids and Wireless Devices," Electronic Industries Forum, Boston, MA, May, 1997
4. Berger, H. S., "Hearing Aid and Cellular Phone Compatibility: Working Toward Solutions," *Wireless Telephones and Hearing Aids: New Challenges for Audiology*, Gallaudet University, Washington, D.C., May, 1997 (To be reprinted in the American Journal of Audiology).
5. Berger, H. S., "Hearing Aid Compatibility with Wireless Communications Devices," IEEE International Symposium on Electromagnetic Compatibility, Austin, TX, August, 1997.
6. Bronaugh, E. L., "Simplifying EMI Immunity (Susceptibility) Tests in TEM Cells," in the 1990 IEEE International Symposium on Electromagnetic Compatibility Symposium Record, Washington, D.C., August 1990, pp. 488-491
7. Byrne, D. and Dillon, H., The National Acoustics Laboratory (NAL) New Procedure for Selecting the Gain and Frequency Response of a Hearing Aid, *Ear and Hearing* 7:257-265, 1986.
8. Crawford, M. L., "Measurement of Electromagnetic Radiation from Electronic Equipment using TEM Transmission Cells," U.S. Department of Commerce, National Bureau of Standards, NBSIR 73-306, Feb. 1973.
9. Crawford, M. L., and Workman, J. L., "Using a TEM Cell for EMC Measurements of Electronic Equipment," U.S. Department of Commerce, National Bureau of Standards. Technical Note 1013, July 1981.
10. EHIMA GSM Project, Development phase, Project Report (1<sup>st</sup> part) Revision A. Technical-Audiological Laboratory and Telecom Denmark, October 1993.
11. EHIMA GSM Project, Development phase, Part II Project Report. Technical-Audiological Laboratory and Telecom Denmark, June 1994.
12. EHIMA GSM Project Final Report, Hearing Aids and GSM Mobile Telephones: Interference Problems, Methods of Measurement and Levels of Immunity. Technical-Audiological Laboratory and Telecom Denmark, 1995.
13. HAMPIS Report, Comparison of Mobile phone electromagnetic near field with an upscaled electromagnetic far field, using hearing aid as reference, 21 October 1999.
14. Hearing Aids/GSM, Report from OTWIDAM, Technical-Audiological Laboratory and Telecom Denmark, April 1993.

FCC ID: BEJCU400	 <b>PCTEST</b> Engineering Laboratory, Inc.	<b>HAC (RF EMISSIONS) TEST REPORT</b>	 <b>LG</b>	<b>Reviewed by:</b> Quality Manager
<b>HAC Filename:</b> 0610110886	<b>Test Dates:</b> October 16 - 19, 2006	<b>EUT Type:</b> Dual-Band GSM/WCDMA Phone with Bluetooth	Page 70 of 74	

15. IEEE 100, The Authoritative Dictionary of IEEE Standards Terms, Seventh Edition.
16. Joyner, K. H., et. al., Interference to Hearing Aids by the New Digital Mobile Telephone System, Global System for Mobile (GSM) Communication Standard, National Acoustic Laboratory, Australian Hearing Series, Sydney 1993.
17. Joyner, K. H., et. al., Interference to Hearing Aids by the Digital Mobile Telephone System, Global System for Mobile Communications (GSM), NAL Report #131, National Acoustic Laboratory, Australian Hearing Series, Sydney, 1995.
18. Kecker, W. T., Crawford, M. L., and Wilson, W. A., "Construction of a Transverse Electromagnetic Cell", U.S. Department of Commerce, National Bureau of Standards, Technical Note 1011, Nov. 1978.
19. Konigstein, D., and Hansen, D., "A New Family of TEM Cells with enlarged bandwidth and Optimized working Volume," in the Proceedings of the 7<sup>th</sup> International Symposium on EMC, Zurich, Switzerland, March 1987; 50:9, pp. 127-132.
20. Kuk, F., and Hjordstgaard, N. K., "Factors affecting interference from digital cellular telephones," Hearing Journal, 1997; 50:9, pp 32-34.
21. Ma, M. A., and Kanda, M., "Electromagnetic Compatibility and Interference Metrology," U.S. Department of Commerce, National Bureau of Standards, Technical Note 1099, July 1986, pp. 17-43.
22. Ma, M. A., Sreenivashiah, I. , and Chang, D. C., "A Method of Determining the Emission and Susceptibility Levels of Electrically Small Objects Using a TEM Cell," U.S. Department of Commerce, National Bureau of Standards, Technical Note 1040, July 1981.
23. McCandless, G. A., and Lyregaard, P. E., Prescription of Gain/Output (POGO) for Hearing Aids, Hearing Instruments 1:16-21, 1983
24. Skopec, M., "Hearing Aid Electromagnetic Interference from Digital Wireless Telephones, "IEEE Transactions on Rehabilitation Engineering, vol. 6, no. 2, pp. 235-239, June 1998.
25. Technical Report, GSM 05.90, GSM EMC Considerations, European Telecommunications Standards Institute, January 1993.
26. Victorian, T. A., "Digital Cellular Telephone Interference and Hearing Aid Compatibility—an Update," Hearing Journal 1998; 51:10, pp. 53-60
27. Wong, G. S. K., and Embleton, T. F. W., eds., AIP Handbook of Condenser Microphones: Theory, Calibration and Measurements, AIP Press.

FCC ID: BEJCU400	 <b>PCTEST</b> Engineering Laboratory, Inc.	<b>HAC (RF EMISSIONS) TEST REPORT</b>	 <b>LG</b>	<b>Reviewed by:</b> Quality Manager
<b>HAC Filename:</b> 0610110886	<b>Test Dates:</b> October 16 - 19, 2006	<b>EUT Type:</b> Dual-Band GSM/WCDMA Phone with Bluetooth	Page 71 of 74	