



# PCTEST ENGINEERING LABORATORY, INC.

6660-B Dobbin Road, Columbia, MD 21045 USA  
Tel. 410.290.6652 / Fax 410.290.6554  
<http://www.pctestlab.com>



## HEARING AID COMPATIBILITY CERTIFICATE

**Applicant Name:**  
LG Electronics USA  
1000 Sylvan Avenue  
Englewood Cliffs, NJ 07632  
United States

**Date of Testing:**  
April 19 - 26, 2008  
**Test Site/Location:**  
PCTEST Lab, Columbia, MD, USA  
**Test Report Serial No.:**  
0804140485.BEJ

**FCC ID:** BEJAX155

**APPLICANT:** LG ELECTRONICS USA

**Application Type:** Certification  
**FCC Rule Part(s):** § 20.19(b), §6.3(v), §7.3(v)  
**HAC Standard:** ANSI C63.19-2006 v3.12;  
**FCC Classification:** Licensed Transmitter Held to Ear (PCE)  
**EUT Type:** Cellular/PCS CDMA Phone  
**Model(s):** AX155  
**Tx Frequency:** 824.70 - 848.31 MHz (Cellular CDMA)  
1851.25 - 1908.75 MHz (PCS CDMA)

**Test Device Serial No.:** Pre-Production Sample [S/N: 80D576CE]

**C63.19-2006 HAC Category:** M3 (RF EMISSIONS CATEGORY)



This wireless portable device has been shown to be hearing-aid compatible under the above rated category, specified in ANSI/IEEE Std. C63.19-2006 and had been tested in accordance with the specified measurement procedures. Hearing-Aid Compatibility is based on the assumption that all production units will be designed electrically identical to the device tested in this report.

I attest to the accuracy of data. All measurements reported herein were performed by me or were made under my supervision and are correct to the best of my knowledge and belief. I assume full responsibility for the completeness of these measurements and vouch for the qualifications of all persons taking them.

*PCTEST certifies that no party to this application has been denied the FCC benefits pursuant to Section 5301 of the Anti-Drug Abuse Act of 1988, 21 U.S.C. 862.*

  
Randy Ortanez  
President





FCC ID: BEJAX155	 PCTEST ENGINEERING LABORATORY, INC.	HAC (RF EMISSIONS) TEST REPORT	 LG	Reviewed by: Quality Manager
HAC Filename: 0804140485.BEJ	Test Dates: April 19 - 26, 2008	EUT Type: Cellular/PCS CDMA Phone	Page 1 of 70	

# TABLE OF CONTENTS

---

1.	INTRODUCTION .....	3
2.	TEST SITE LOCATION.....	4
3.	EUT DESCRIPTION .....	5
4.	ANSI/IEEE C63.19 PERFORMANCE CATEGORIES.....	6
5.	SYSTEM SPECIFICATIONS.....	7
6.	TEST PROCEDURE.....	13
7.	SYSTEM CHECK .....	15
8.	MODULATION FACTOR .....	18
9.	FCC 3G MEASUREMENTS.....	20
10.	OVERALL MEASUREMENT SUMMARY .....	21
11.	EQUIPMENT LIST .....	24
12.	MEASUREMENT UNCERTAINTY .....	25
13.	TEST DATA.....	26
14.	CALIBRATION CERTIFICATES.....	35
15.	CONCLUSION.....	65
16.	REFERENCES .....	66
17.	TEST PHOTOGRAPHS .....	68

<b>FCC ID:</b> BEJAX155	 <b>PCTEST</b> <small>ENGINEERING LABORATORY, INC.</small>	<b>HAC (RF EMISSIONS) TEST REPORT</b>	 <b>LG</b>	<b>Reviewed by:</b> Quality Manager
<b>HAC Filename:</b> 0804140485.BEJ	<b>Test Dates:</b> April 19 - 26, 2008	<b>EUT Type:</b> Cellular/PCS CDMA Phone	Page 2 of 70	

# 1. INTRODUCTION

On July 10, 2003, the Federal Communications Commission (FCC) adopted new rules requiring wireless manufacturers and service providers to provide digital wireless phones that are compatible with hearing aids. The FCC has modified the exemption for wireless phones under the Hearing Aid Compatibility Act of 1998 (HAC Act) in WT Docket 01-309 RM-8658<sup>1</sup> to extend the benefits of wireless telecommunications to individuals with hearing disabilities. These benefits encompass business, social and emergency communications, which increase the value of the wireless network for everyone. An estimated more than 10% of the population in the United States show signs of hearing impairment and of that fraction, almost 80% use hearing aids. Approximately 500 million people worldwide suffer from hearing loss.

## Compatibility Tests Involved:

The standard calls for wireless communications devices to be measured for:

- RF Electric-field emissions
- RF Magnetic-field emissions
- T-coil mode, magnetic-signal strength in the audio band
- T-coil mode, magnetic-signal frequency response through the audio band
- T-coil mode, magnetic-signal and noise articulation index

The hearing aid must be measured for:



- RF immunity in microphone mode
- RF immunity in T-coil mode

In the following tests and results, this report includes the evaluation for a wireless communications device.



Figure 1-1 Hearing Aid *in-vitu*

<sup>1</sup> FCC Rule & Order, WT Docket 01-309 RM-8658

FCC ID: BEJAX155	 PCTEST ENGINEERING LABORATORY, INC.	HAC (RF EMISSIONS) TEST REPORT	 LG	Reviewed by: Quality Manager
HAC Filename: 0804140485.BEJ	Test Dates: April 19 - 26, 2008	EUT Type: Cellular/PCS CDMA Phone		Page 3 of 70

## 2. TEST SITE LOCATION

### 2.1 INTRODUCTION

The map at the right shows the location of the PCTEST LABORATORY in Columbia, Maryland. It is in proximity to the FCC Laboratory, the Baltimore-Washington International (BWI) airport, the city of Baltimore and Washington, DC (See Figure 2).

These measurement tests were conducted at the PCTEST Engineering Laboratory, Inc. facility in New Concept Business Park, Guilford Industrial Park, Columbia, Maryland. The site address is 6660-B Dobbin Road, Columbia, MD 21045. The test site is one of the highest points in the Columbia area with an elevation of 390 feet above mean sea level. The site coordinates are 39° 11'15" N latitude and 76° 49' 38" W longitude. The facility is 1.5 miles North of the FCC laboratory, and the ambient signal and ambient signal strength are approximately equal to those of the FCC laboratory. There are no FM or TV transmitters within 15 miles of the site. The detailed description of the measurement facility was found to be in compliance with the requirements of § 2.948 according to ANSI C63.4 on January 27, 2006 and Industry Canada.



**Figure 2-1**

Map of the Greater Baltimore and Metropolitan Washington D.C. area

### 2.2 Test Facility / Accreditations:

Measurements were performed at an independent accredited PCTEST Engineering Lab located in Columbia, MD 21045, U.S.A.



- PCTEST Lab is accredited to ISO 17025-2005 by the American Association for Laboratory Accreditation (A2LA) in Specific Absorption Rate (SAR) testing, Hearing-Aid Compatibility (HAC), CTIA Test Plans, and wireless testing for FCC and Industry Canada Rules.
- PCTEST Lab is accredited to ISO 17025 by U.S. National Institute of Standards and Technology (NIST) under the National Voluntary Laboratory Accreditation Program (NVLAP Lab code: 100431-0) in EMC, FCC and Telecommunications.
- PCTEST facility is an FCC registered (PCTEST Reg. No. 90864) test facility with the site description report on file and has met all the requirements specified in Section 2.948 of the FCC Rules and Industry Canada (IC-2451).
- PCTEST Lab is a recognized U.S. Conformity Assessment Body (CAB) in EMC and R&TTE (n.b. 0982) under the U.S.-EU Mutual Recognition Agreement (MRA).
- PCTEST TCB is a Telecommunication Certification Body (TCB) accredited to ISO/IEC Guide 65 by the American National Standards Institute (ANSI) in all scopes of FCC Rules and all Industry Canada Standards (RSS).
- PCTEST facility is an IC registered (IC-2451) test laboratory with the site description on file at Industry Canada.
- PCTEST is a CTIA Authorized Test Laboratory (CATL) for AMPS and CDMA, and EvDO mobile phones.
- PCTEST is a CTIA Authorized Test Laboratory (CATL) for Over-the-Air (OTA) Antenna Performance testing for AMPS, CDMA, GSM, GPRS, EGPRS, UMTS (W-CDMA), CDMA 1xEVDO Data, CDMA 1xRTT Data.

FCC ID: BEJAX155	PCTEST ENGINEERING LABORATORY, INC.	HAC (RF EMISSIONS) TEST REPORT	LG	Reviewed by: Quality Manager
HAC Filename: 0804140485.BEJ	Test Dates: April 19 - 26, 2008	EUT Type: Cellular/PCS CDMA Phone	Page 4 of 70	

### 3. EUT DESCRIPTION



**FCC ID:** BEJAX155  
**Manufacturer:** LG Electronics USA  
 1000 Sylvan Avenue  
 Englewood Cliffs, NJ 07632  
 United States  
**Trade Name:** LGE  
**Model(s):** AX155  
**Serial Number:** 80D576CE  
**Tx Frequencies:** 824.70 - 848.31 MHz (Cellular CDMA)  
 1851.25 - 1908.75 MHz (PCS CDMA)

**Antenna Configurations:** Internal Antenna  
**Maximum Conducted Power (EMC/SAR):** 24.5 dBm (CDMA), 25.1 dBm (PCS)  
**Maximum Conducted Power (HAC):** 24.6 dBm (CDMA), 25.2 dBm (PCS)  
**HAC Test Configurations:** CDMA, 1013, 384, 777, BT Off  
 PCS, 25, 600, 1175, BT Off

**FCC Classification:** Licensed Transmitter Held to Ear (PCE)  
**EUT Type:** Cellular/PCS CDMA Phone

<b>FCC ID:</b> BEJAX155	<b>PCTEST</b> ENGINEERING LABORATORY, INC.	<b>HAC (RF EMISSIONS) TEST REPORT</b>	<b>LG</b>	<b>Reviewed by:</b> Quality Manager
<b>HAC Filename:</b> 0804140485.BEJ	<b>Test Dates:</b> April 19 - 26, 2008	<b>EUT Type:</b> Cellular/PCS CDMA Phone	Page 5 of 70	

## 4. ANSI/IEEE C63.19 PERFORMANCE CATEGORIES



### I. RF EMISSIONS

The ANSI Standard presents performance requirements for acceptable interoperability of hearing aids with wireless communications devices. When these parameters are met, a hearing aid operates acceptably in close proximity to a wireless communications device.

Category	Telephone RF Parameters	
Near field Category	E-field emissions CW dB(V/m)	H-field emissions CW dB(A/m)
<b>f &lt; 960 MHz</b>		
<b>M1</b>	56 to 61 + 0.5 x AWF	5.6 to 10.6 +0.5 x AWF
<b>M2</b>	51 to 56 + 0.5 x AWF	0.6 to 5.6 +0.5 x AWF
<b>M3</b>	46 to 51 + 0.5 x AWF	-4.4 to 0.6 +0.5 x AWF
<b>M4</b>	< 46 + 0.5 x AWF	< -4.4 + 0.5 x AWF
<b>f &gt; 960 MHz</b>		
<b>M1</b>	46 to 51 + 0.5 x AWF	-4.4 to 0.6 +0.5 x AWF
<b>M2</b>	41 to 46 + 0.5 x AWF	-9.4 to -4.4 +0.5 x AWF
<b>M3</b>	36 to 41 + 0.5 x AWF	-14.4 to -9.4 +0.5 x AWF
<b>M4</b>	< 36 + 0.5 x AWF	< -14.4 + 0.5 x AWF
<b>Table 4-1</b> <b>Hearing aid and WD near-field categories as defined in ANSI C63.19-2006 v3.12 [2]</b>		

### II. ARTICULATION WEIGHTING FACTOR (AWF)

Standard	Technology	Articulation Weighing Factor (AWF)
T1/T1P1/3GPP	UMTS (WCDMA)	0
IS-95	CDMA	0
iDEN™	TDMA (22 and 11 Hz)	0
J-STD-007	GSM (217 Hz)	-5
<b>Table 4-2</b> <b>Articulation Weighing Factors</b>		

FCC ID: BEJAX155	 PCTEST ENGINEERING LABORATORY, INC.	HAC (RF EMISSIONS) TEST REPORT	 LG	Reviewed by: Quality Manager
HAC Filename: 0804140485.BEJ	Test Dates: April 19 - 26, 2008	EUT Type: Cellular/PCS CDMA Phone	Page 6 of 70	

## 5. SYSTEM SPECIFICATIONS

### ER3DV6 E-Field Probe Description

Construction:	One dipole parallel, two dipoles normal to probe axis Built-in shielding against static charges
Calibration:	In air from 100 MHz to 3.0 GHz (absolute accuracy $\pm 6.0\%$ , $k=2$ )
Frequency:	100 MHz to $> 6$ GHz; Linearity: $\pm 0.2$ dB (100 MHz to 3 GHz)
Directivity	$\pm 0.2$ dB in air (rotation around probe axis) $\pm 0.4$ dB in air (rotation normal to probe axis)
Dynamic Range	2 V/m to $> 1000$ V/m (M3 or better device readings fall well below diode compression point)
Linearity:	$\pm 0.2$ dB
Dimensions	Overall length: 330 mm (Tip: 16 mm) Tip diameter: 8 mm (Body: 12 mm) Distance from probe tip to dipole centers: 2.5 mm



**Figure 5-1**  
E-field Free-space Probe

### H3DV6 H-Field Probe Description

Construction:	Three concentric loop sensors with 3.8 mm loop diameters Resistively loaded detector diodes for linear response Built-in shielding against static charges
Frequency:	200 MHz to 3 GHz (absolute accuracy $\pm 6.0\%$ , $k=2$ ); Output linearized
Directivity:	$\pm 0.25$ dB (spherical isotropy error)
Dynamic Range:	10 mA/m to 2 A/m at 1 GHz (M3 or better device readings fall well below diode compression point)
Dimensions:	Overall length: 330 mm (Tip: 40 mm) Tip diameter: 6 mm (Body: 12 mm) Distance from probe tip to dipole centers: 3 mm
E-Field Interference:	$< 10\%$ at 3 GHz (for plane wave)





**Figure 5-2**  
H-Field Free-space Probe

### Probe Tip Description

HAC field measurements take place in the close near field with high gradients. Increasing the measuring distance from the source will generally decrease the measured field values (in case of the validation dipole approx. 10% per mm).

Magnetic field sensors are measuring the integral of the H-field across their sensor area surrounded by the loop. They are calibrated in a precise, homogeneous field. When measuring a gradient field, the result will be very close to the field in the center of the loop which is equivalent to the value of a homogeneous field equivalent to the center value. But it will be different from the field at the border of the loop.

FCC ID: BEJAX155	 <b>PCTEST</b> ENGINEERING LABORATORY, INC.	HAC (RF EMISSIONS) TEST REPORT	 <b>LG</b>	Reviewed by: Quality Manager
HAC Filename: 0804140485.BEJ	Test Dates: April 19 - 26, 2008	EUT Type: Cellular/PCS CDMA Phone	Page 7 of 70	

Consequently, two sensors with different loop diameters - both calibrated ideally - would give different results when measuring from the edge of the probe sensor elements. The behavior for electrically small E-field sensors is equivalent.

The magnetic field loops of the H3D probes are concentric, with the center 3mm from the tip for H3DV6. Their radius is 1.9mm.

The electric field probes have a more irregular internal geometry because it is physically not possible to have the 3 orthogonal sensors situated with the same center. The effect of the different sensor centers is accounted for in the HAC uncertainty budget ("sensor displacement"). Their geometric center is at 2.5mm from the tip, and the element ends are 1.1mm closer to the tip.

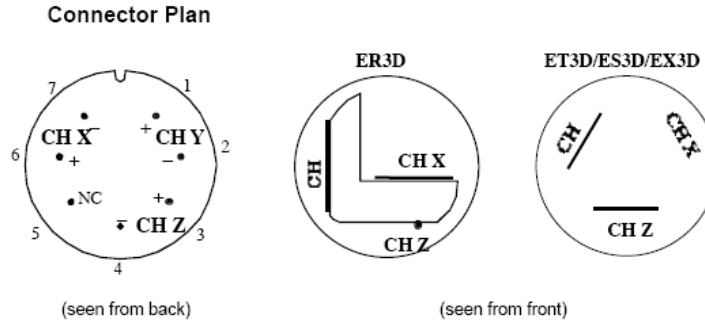

The antistatic shielding inside the probe is connected to the probe connector case.

**Instrumentation Chain**

**Equation 1**

**Conversion of Connector Voltage  $u_i$  to E-Field  $E_i$**

$$E_i = \sqrt{\frac{u_i + (u_i^2 \cdot CF) / (DCP)}{Norm_i \cdot ConvF}}$$

whereby

- $E_i$ : electric field in V/m
- $u_i$ : voltage of channel i at the connector in  $\mu V$
- $Norm_i$ : sensitivity of channel i in  $\mu V / (V/m)^2$
- $ConvF$ : enhancement factor in liquid (ConvF=1 for Air)
- $DCP$ : diode compression point in  $\mu V$
- $CF$ : signal crest factor (peak power/average power)

**Conditions of Calibration**

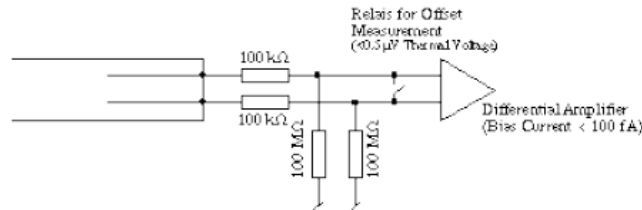

- Please note:
- a lower input impedance of the amplifier will result in different sensitivity factors  $Norm_i$  and  $DCP$
  - larger bias currents will cause higher offset

FCC ID: BEJAX155	PCTEST ENGINEERING LABORATORY, INC.	HAC (RF EMISSIONS) TEST REPORT	LG	Reviewed by: Quality Manager
HAC Filename: 0804140485.BEJ	Test Dates: April 19 - 26, 2008	EUT Type: Cellular/PCS CDMA Phone		Page 8 of 70

## Probe Response to Frequency

The E-field sensors have inherently a very flat frequency response. They are calibrated with a number of frequencies resulting in a common calibration factor, with the frequency behavior documented in the calibration certificate (See also below).

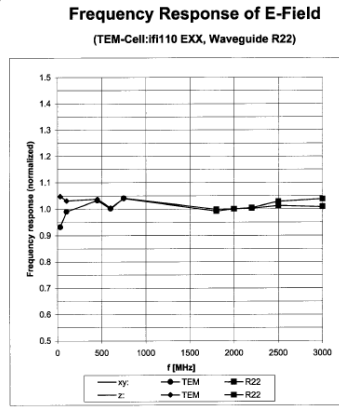

Uncertainty of Frequency Response of E-field:  $\pm 6.3\%$  ( $k=2$ )

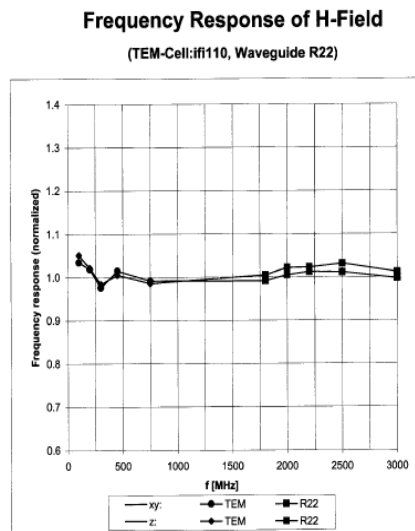

**Figure 5-3 E-Field Probe Frequency Response**

H-field sensors have a frequency dependent sensitivity which is evaluated for a series of frequencies also visible in the probe calibration certificate. The calibration factors result from a fitting algorithm. The proper conversion is calculated by the DASY4 software depending on the frequency setting in the procedure. See below for H-field frequency response:



Uncertainty of Frequency Response of E-field:  $\pm 6.3\%$  ( $k=2$ )

**Figure 5-4 H-Field Probe Frequency Response**

FCC ID: BEJAX155	 <b>PCTEST</b> ENGINEERING LABORATORY, INC.	HAC (RF EMISSIONS) TEST REPORT	 LG	Reviewed by: Quality Manager
HAC Filename: 0804140485.BEJ	Test Dates: April 19 - 26, 2008	EUT Type: Cellular/PCS CDMA Phone		Page 9 of 70

## Conversion to Peak

Peak is defined as Peak Envelope Power. All raw measurements from the HAC measurement system are RMS values. The DASY4 system incorporates the crest factor of the signal in the computation of the RMS values (See Equation 1). Although the software also has capability to estimate the peak field by applying a square root of crest factor value to the readings, the probe modulation factor was applied manually instead per C63.19 in the measurement tables in this report. The equation to convert the raw measurements in the data tables are:

$$\text{Peak Field} = 20 \cdot \log (\text{Raw} \cdot \text{PMF})$$

Where:

Peak Field = Peak field (in dBV/m or dBA/m)

Raw = Raw field measurement from the measurement system (in V/m or A/m).

PMF = Probe Modulation Factor (in linear units).

## SPEAG Robotic System



E-field and H-field measurements are performed using the DASY4 automated dosimetric assessment system. The DASY4 is made by Schmid & Partner Engineering AG (SPEAG) in Zurich, Switzerland and consists of high precision robotics system (Staubli), robot controller, Pentium 4 computer, near-field probe, probe alignment sensor, and the HAC phantom. The robot is a six-axis industrial robot performing precise movements to position the probe to the location (points) of maximum electromagnetic field (EMF).



**Figure 5-5**  
SPEAG Robotic System

## System Hardware

A cell controller system contains the power supply, robot controller, teach pendant (Joystick), and a remote control used to drive the robot motors. The PC consists of the Gateway Pentium 4 2.53 GHz computer with Windows XP system and RF Measurement Software DASY4 v4.5 (with HAC Extension), A/D interface card, monitor, mouse, and keyboard. The Staubli Robot is connected to the cell controller to allow software manipulation of the robot. A data acquisition electronic (DAE) circuit that performs the signal amplification, signal multiplexing, AD-conversion, offset measurements, mechanical surface detection, collision detection, etc. is connected to the Electro-optical coupler (EOC). The EOC performs the conversion from the optical into digital electric signal of the DAE and transfers data to the PC plug-in card.

FCC ID: BEJAX155	 PCTEST ENGINEERING LABORATORY, INC.	HAC (RF EMISSIONS) TEST REPORT	 LG	Reviewed by: Quality Manager
HAC Filename: 0804140485.BEJ	Test Dates: April 19 - 26, 2008	EUT Type: Cellular/PCS CDMA Phone		Page 10 of 70

## System Electronics

The DAE consists of a highly sensitive electrometer-grade preamplifier with auto-zeroing, a channel and gain-switching multiplexer, a fast 16 bit AD-converter and a command decoder and control logic unit. Transmission to the PC-card is accomplished through an optical downlink for data and status information and an optical uplink for commands and clock lines. The mechanical probe mounting device includes two different sensor systems for frontal and sidewise probe contacts. They are also used for mechanical surface detection and probe collision detection. The robot uses its own controller with a built in VME-bus computer.

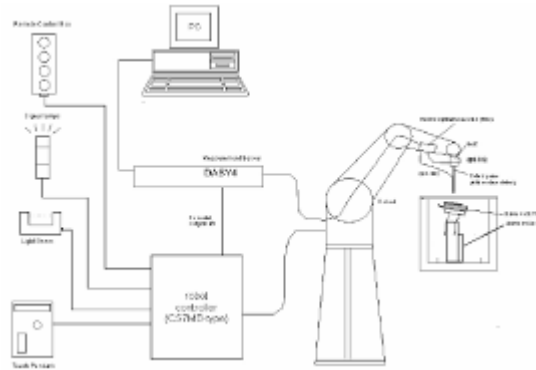



**Figure 5-6**  
SPEAG Robotic System Diagram

## DASY4 Instrumentation Chain

The first step of the evaluation is a linearization of the filtered input signal to account for the compression characteristics of the detector diode. The compensation depends on the input signal, the diode type and the DC-transmission factor from the diode to the evaluation electronics. If the exciting field is pulsed, the crest factor of the signal must be known to correctly compensate for peak power. The formula for each channel can be given as:

$$V_i = U_i + U_i^2 \cdot \frac{cf}{dcp_i}$$

with  $V_i$  = compensated signal of channel  $i$  (i = x, y, z)  
 $U_i$  = input signal of channel  $i$  (i = x, y, z)  
 $cf$  = crest factor of exciting field (DASY parameter)  
 $dcp_i$  = diode compression point (DASY parameter)

FCC ID: BEJAX155	 PCTEST ENGINEERING LABORATORY, INC.	HAC (RF EMISSIONS) TEST REPORT	 LG	Reviewed by: Quality Manager
HAC Filename: 0804140485.BEJ	Test Dates: April 19 - 26, 2008	EUT Type: Cellular/PCS CDMA Phone		Page 11 of 70

From the compensated input signals the primary field data for each channel can be evaluated:

$$\text{E - fieldprobes : } E_i = \sqrt{\frac{V_i}{\text{Norm}_i \cdot \text{ConvF}}}$$

$$\text{H - fieldprobes : } H_i = \sqrt{V_i} \cdot \frac{a_{i0} + a_{i1}f + a_{i2}f^2}{f}$$

- with  $V_i$  = compensated signal of channel i (i = x, y, z)  
 $\text{Norm}_i$  = sensor sensitivity of channel i (i = x, y, z)  
 $\mu\text{V}/(\text{V/m})^2$  for E-field Probes  
 $\text{ConvF}$  = sensitivity enhancement in solution  
 $a_{ij}$  = sensor sensitivity factors for H-field probes  
 $f$  = carrier frequency [GHz]  
 $E_i$  = electric field strength of channel i in V/m  
 $H_i$  = magnetic field strength of channel i in A/m

The RSS value of the field components gives the total field strength (Hermitian magnitude):



$$E_{tot} = \sqrt{E_x^2 + E_y^2 + E_z^2}$$

The primary field data are used to calculate the derived field units.

The measurement/integration time per point, as specified by the system manufacturer is >500 ms.

The signal response time is evaluated as the time required by the system to reach 90% of the expected final value after an on/off switch of the power source with an integration time of 500 ms and a probe response time of <5 ms. In the current implementation, DASY4 waits longer than 100 ms after having reached the grid point before starting a measurement, i.e., the response time uncertainty is negligible.



If the device under test does not emit a CW signal, the integration time applied to measure the electric field at a specific point may introduce additional uncertainties due to the discretization. The tolerances for the different systems had the worst-case of 2.6%.

FCC ID: BEJAX155	 <b>PCTEST</b> ENGINEERING LABORATORY, INC.	HAC (RF EMISSIONS) TEST REPORT	 <b>LG</b>	Reviewed by: Quality Manager
HAC Filename: 0804140485.BEJ	Test Dates: April 19 - 26, 2008	EUT Type: Cellular/PCS CDMA Phone	Page 12 of 70	

## 6. TEST PROCEDURE

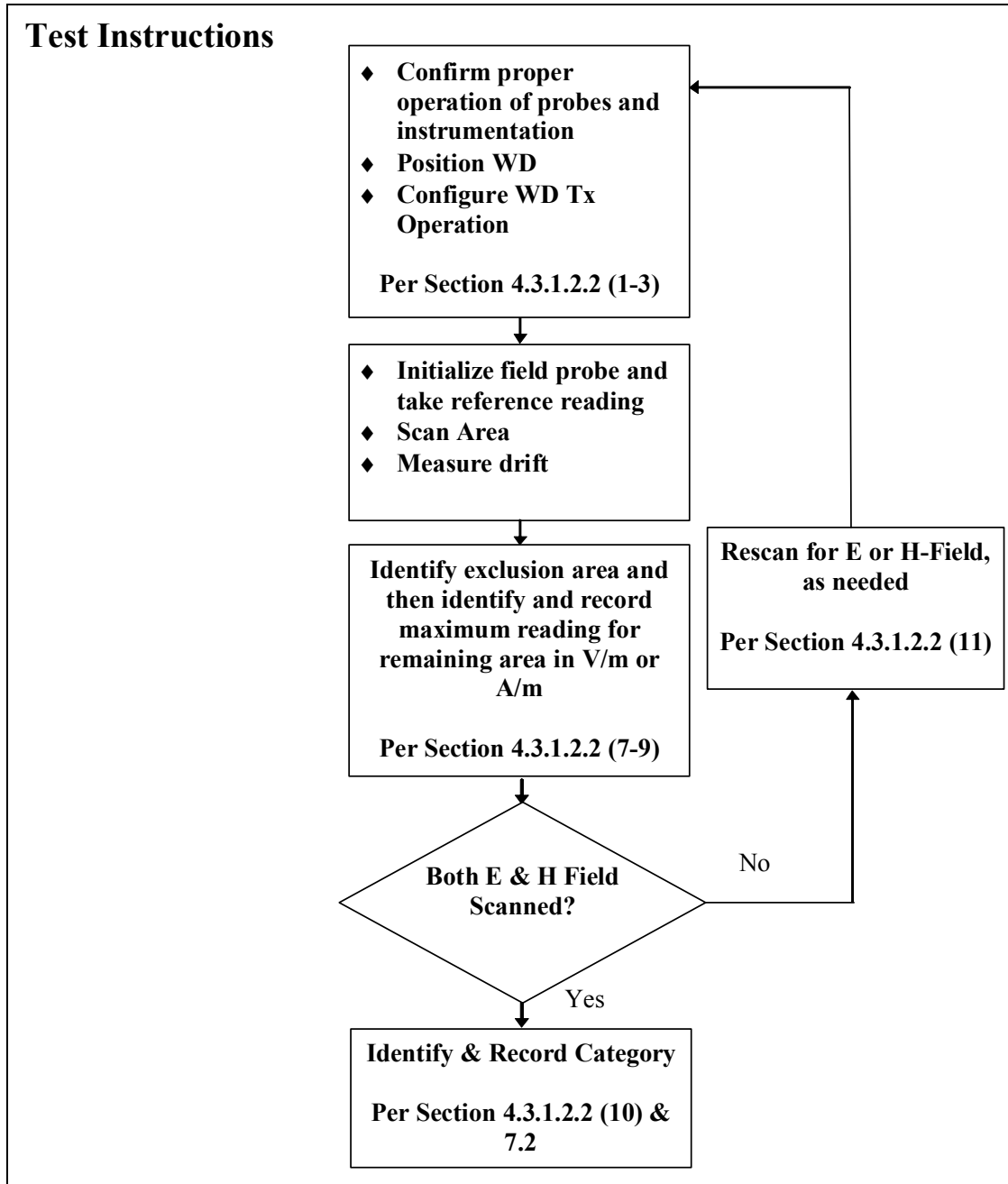
### I. RF EMISSIONS



FCC ID: BEJAX155	 PCTEST ENGINEERING LABORATORY, INC.	HAC (RF EMISSIONS) TEST REPORT	 LG	Reviewed by: Quality Manager
HAC Filename: 0804140485.BEJ	Test Dates: April 19 - 26, 2008	EUT Type: Cellular/PCS CDMA Phone	Page 13 of 70	

## Test Setup

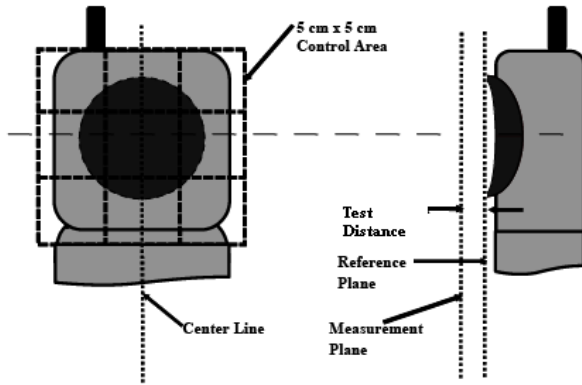

**Figure 6-1**

E/H-Field Emissions Test Setup Diagram (See Test Photographs for actual WD scan grid overlay)

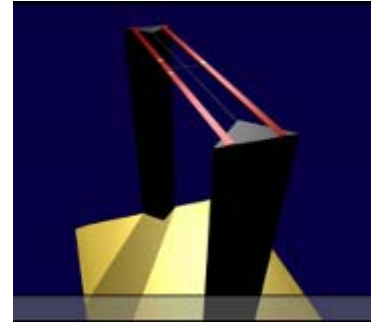



**Figure 6-2**  
HAC Phantom

## RF Emissions Test Procedure:

The following illustrate a typical RF emissions test scan over a wireless communications device:

1. Proper operation of the field probe, probe measurement system, other instrumentation, and the positioning system was confirmed.
2. WD is positioned in its intended test position, acoustic output point of the device perpendicular to the field probe.
3. The WD operation for maximum rated RF output power was configured and confirmed with the base station simulator, at the test channel and other normal operating parameters as intended for the test. The battery was ensured to be fully charged before each test.
4. The center sub-grid was centered over the center of the acoustic output (also audio band magnetic output, if applicable). The WD audio output was positioned tangent (as physically possible) to the measurement plane.
5. A surface calibration was performed before each setup change to ensure repeatable spacing and proper maintenance of the measurement plane using the HAC Phantom.
6. The measurement system measured the field strength at the reference location.
7. Measurements at 2mm increments in the 5 x 5 cm region were performed at a distance 1 cm from the probe elements to the WD. A 360° rotation about the azimuth axis at the maximum interpolated position was measured. For the worst-case condition, the peak reading from this rotation was used in re-evaluating the HAC category.
8. The system performed a drift evaluation by measuring the field at the reference location.
9. Steps 1-8 were done for both the E and H-Field measurements.

FCC ID: BEJAX155	 <b>PCTEST</b> ENGINEERING LABORATORY, INC.	<b>HAC (RF EMISSIONS) TEST REPORT</b>	 <b>LG</b>	Reviewed by: Quality Manager
HAC Filename: 0804140485.BEJ	Test Dates: April 19 - 26, 2008	EUT Type: Cellular/PCS CDMA Phone		Page 14 of 70

## 7. SYSTEM CHECK

### I. System Check Parameters

The input signal was an un-modulated continuous wave. The following points were taken into consideration in performing this check:

- Average Input Power  $P = 100\text{mW RMS}$  ( $20\text{dBm RMS}$ ) after adjustment for return loss
- The test fixture must meet the 2 wavelength separation criterion
- The proper measurement of the 1 cm probe to dipole separation, which is measured from top surface of the dipole to the calibration reference point of the sensor, defined by the probe manufacturer is shown in the following diagram:

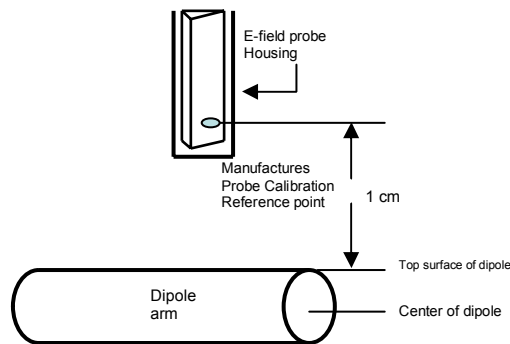

**Figure 7-1**  
Separation Distance from Dipole to Field Probe

RF power was recorded using both an average reading meter and a peak reading meter. Readings of the probe are provided by the measurement system.

To assure proper operation of the near-field measurement probe the input power to the dipole shall be commensurate with the full rated output power of the wireless device (e.g. - for a cellular phone wireless device the average peak antenna input power will be on the order of  $100\text{mW}$  (i.e. -  $20\text{dBm}$ ) RMS after adjustment for any mismatch.



### II. Validation Procedure

A dipole antenna meeting the requirements given in C63.19 was placed in the position normally occupied by the WD.

The length of the dipole was scanned with both E-field and H-field probes and the maximum values for each were recorded.

#### Measurement of CW

Using the near-field measurement system, scan the antenna over the radiating dipole and record the greatest field reading observed. Due to the nature of E-fields about free-space dipoles, the two E-field peaks measured over the dipole are averaged to compensate for non-parallelity of the setup (

FCC ID: BEJAX155	 PCTEST ENGINEERING LABORATORY, INC.	HAC (RF EMISSIONS) TEST REPORT	 LG	Reviewed by: Quality Manager
HAC Filename: 0804140485.BEJ	Test Dates: April 19 - 26, 2008	EUT Type: Cellular/PCS CDMA Phone		Page 15 of 70

see manufacturer method on dipole calibration certificates, page 2). Field strength measurements shall be made only when the probe is stationary.

RF power was recorded using both an average and a peak power reading meter.

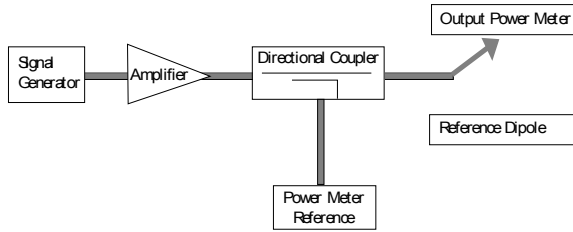

**Figure 7-2**

Setup for Desired Output Power to Dipole

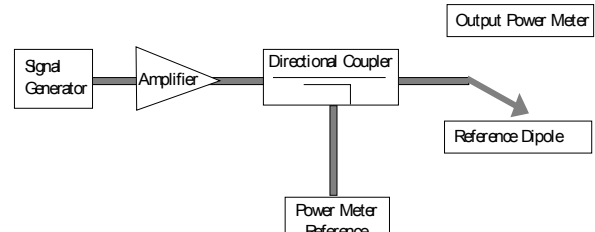
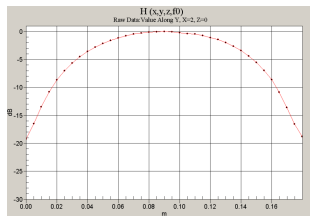

**Figure 7-3**

Setup to Dipole

Using this setup configuration, the signal generator was adjusted for the desired output power (100mW) at a specified frequency. The reference power from the coupled port of the directional coupler is recorded. Next, the output cable is connected to the reference dipole, as shown in Figure 7-3.

The input signal level was adjusted until the reference power from the coupled port of the directional coupler was the same as previously recorded, to compensate for the impedance mismatch between the output cable and the reference dipole. To assure proper operation of the near-field measurement probe the input power to the reference dipole was verified to the full rated output power of the wireless device. The dipole was secured in a holder in a manner to meet the 20 dB reflection. The near-field measurement probe was positioned over the dipole. The antenna was scanned over the appropriate sized area to cover the dipole from end to end. SPEAG uses 2D interpolation algorithms between the measured points. Please see below two dimensional plots showing that the interpolated values interpolate smoothly between 5mm steps for a free-space RF dipole:



**Figure 7-4**

2-D Raw Data from scan along dipole axis



**Figure 7-5**

2-D Interpolated points from scan along dipole axis

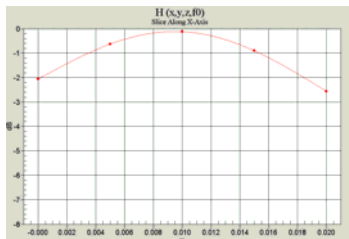

**Figure 7-6**

2-D Raw Data from scan along transverse axis

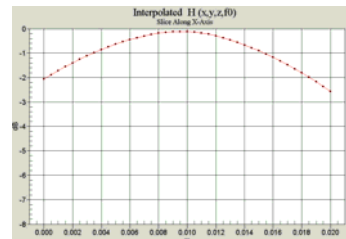

**Figure 7-7**

2-D Interpolated points from scan along transverse axis

FCC ID: BEJAX155	PCTEST ENGINEERING LABORATORY, INC.	HAC (RF EMISSIONS) TEST REPORT	LG	Reviewed by: Quality Manager
HAC Filename: 0804140485.BEJ	Test Dates: April 19 - 26, 2008	EUT Type: Cellular/PCS CDMA Phone		Page 16 of 70

### III. System Check Results

#### Validation Results

Frequency (MHz)	Input Power (dBm)	E-field Result (V/m)	Target Field (V/m)	% Deviation
835	20.0	179.9	167.3	7.5%
1880	20.0	138.6	134.6	2.9%
Frequency (MHz)	Input Power (dBm)	H-field Result (A/m)	Target Field (A/m)	% Deviation
835	20.0	0.472	0.454	3.9%
1880	20.0	0.446	0.451	-1.2%

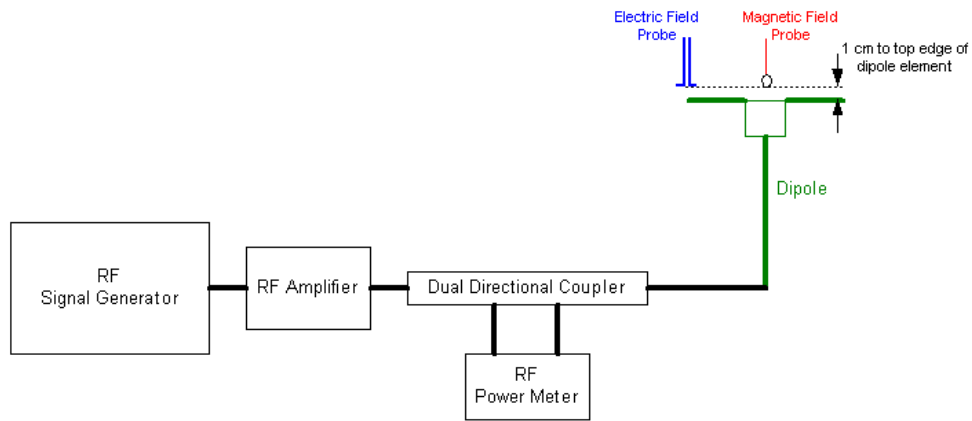

**Figure 7-8**  
System Check Setup

FCC ID: BEJAX155	PCTEST ENGINEERING LABORATORY, INC.	HAC (RF EMISSIONS) TEST REPORT	LG	Reviewed by: Quality Manager
HAC Filename: 0804140485.BEJ	Test Dates: April 19 - 26, 2008	EUT Type: Cellular/PCS CDMA Phone		Page 17 of 70

## 8. MODULATION FACTOR

A calibration was made of the modulation response of the probe and its instrumentation chain. This calibration was performed with the field probe, attached to its instrumentation. The response of the probe system to a CW field at the frequency of interest is compared to its response to a modulated signal with equal peak amplitude to that of a CW signal. The field level of the test signals are ensured to be more than 10 dB above the ambient level and the noise floor of the instrumentation being used. The ratio of the CW reading to that taken with a modulated reading was applied to the DUT measurements.

All voice modes for this device have been investigated in this section of the report. According to the FCC 3G Measurement Procedures, May 2006 for RF Emissions, variations in peak field and power readings.

**This was done using the following procedure:**

1. The probe was illuminated with a CW signal at the intended measurement frequency and wireless device power.
2. The probe was positioned at the field maxima over the dipole antenna (determined after an area scan over the dipole) illuminated with the CW signal.
3. The reading of the probe measurement system of the CW signal at the maximum point was recorded.
4. Using a Spectrum Analyzer, the modulated signal adjusted with the same peak level of the CW signal was determined.
5. The probe measurement system reading was recorded with the modulated signal. The appropriate system crest factors for the modulation type were configured in the software to the system measurements.
6. The ratio of the CW reading to modulated signal reading is the probe modulation factor (PMF) for the modulation and field probe combination. This was repeated for 80% AM.
7. Steps 1-6 were repeated at all frequency bands and for both E and H field probes.

The modulation factors obtained were applied to readings taken of the actual wireless device, in order to obtain an accurate peak field reading using the formula:

$$\text{Peak} = 20 \cdot \log (\text{Raw} \cdot \text{PMF})$$

This method correlates well with the modulation using the DUT in the alternative substitution method. See below for correlation of signal:

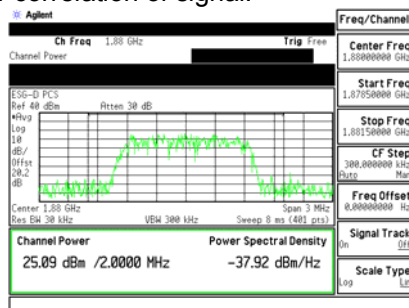

**Figure 8-1**  
Signal Generator Modulated Signal

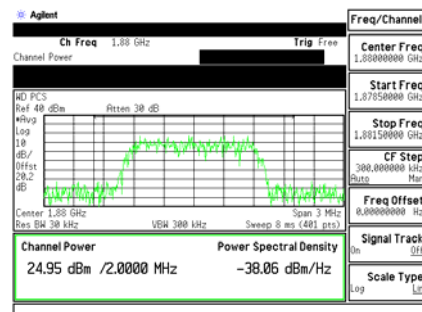

**Figure 8-2**  
Wireless Device Modulated Signal

FCC ID: BEJAX155	PCTEST ENGINEERING LABORATORY, INC.	HAC (RF EMISSIONS) TEST REPORT	LG	Reviewed by: Quality Manager
HAC Filename: 0804140485.BEJ	Test Dates: April 19 - 26, 2008	EUT Type: Cellular/PCS CDMA Phone		Page 18 of 70

**Modulation Factors:**

f (MHz)	Protocol	E-Field (V/m)	H-Field (A/m)	E-Field Modulation Factor	H-Field Modulation Factor
835	AM	193.30	0.5751	1.425	1.307
835	CDMA*	295.40	0.9029	0.933	0.833
835	CW	275.50	0.7517		
1880	AM	155.40	0.6561	1.445	1.501
1880	CDMA*	226.80	1.2010	0.990	0.820
1880	CW	224.50	0.9846		

  

f (MHz)	Protocol	E-Field (V/m)	E-Field Modulation Factor
1880	CDMA / SO3	75.10	2.910
1880	CW	218.55	

**Figure 8-3**  
Modulation Factors

FCC 3G Note: "CDMA\*" represents worst-case mode, while "CDMA/SO3" represents RC1/SO3 mode.

**CW and Modulated Signal Zero-Span plots:**

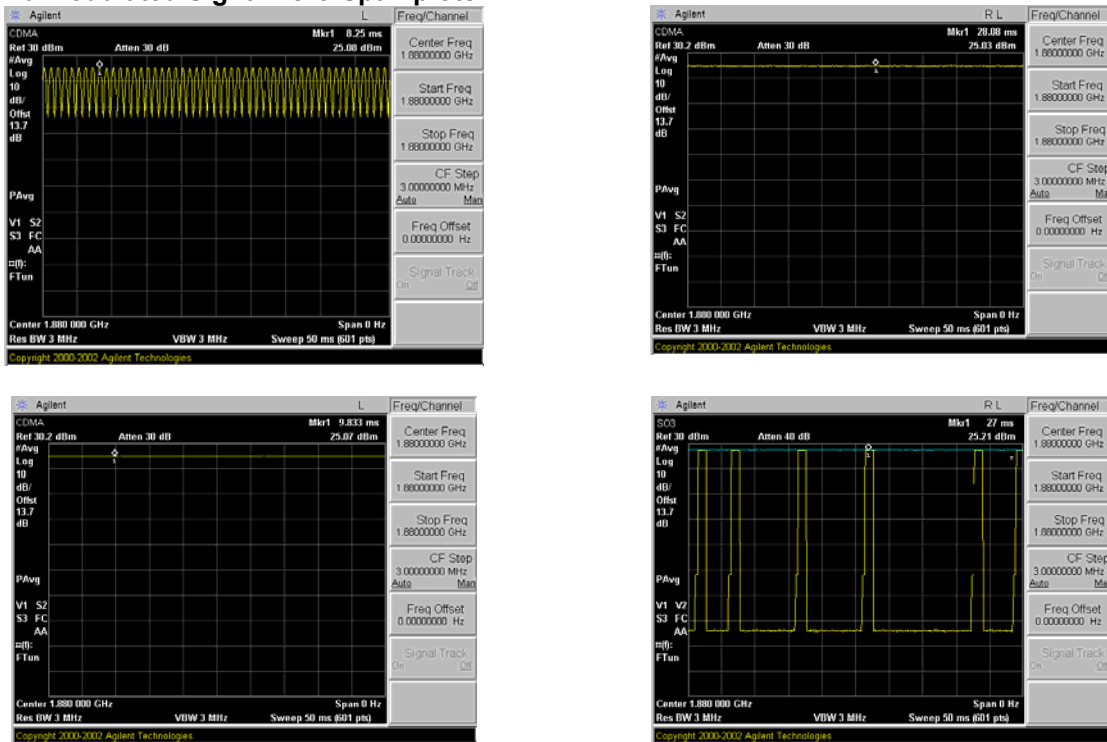

**Figure 8-4** Zero-Span Plots

FCC ID: BEJAX155	PCTEST ENGINEERING LABORATORY, INC.	HAC (RF EMISSIONS) TEST REPORT	LG	Reviewed by: Quality Manager
HAC Filename: 0804140485.BEJ	Test Dates: April 19 - 26, 2008	EUT Type: Cellular/PCS CDMA Phone		Page 19 of 70

## 9. FCC 3G MEASUREMENTS

Sample pre-testing of the various modes were performed at the worst case probe location as part of subset testing justification. See below for measured conducted power for applicable device modes:

### I. Handset Capabilities\*:

\*See Device Capabilities attachment for applicable device modes and powers.

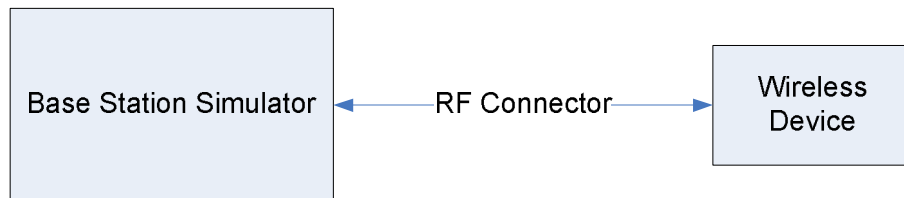

**Figure 9-1**  
Power Measurement Setup

### II. Worst-Case Probe Location Measurements

Below are RC/SO mode investigation results of the device at the worst-case (maximum) field point location. The worst-case RC/SO was used for HAC testing.

**Table 9-1**  
Handset 3G mode variation on RF Emissions

Mode	Channel	Backlight	RC/SO	Scan Center	Battery	Time Avg. Field (V/m)	Peak Field (dBV/m)	FCC Limit (dBV/m)	FCC MARGIN (dB)	RESULT	Excl Blocks per 4.4
PCS	25	off	SO3/RC1	Acoustic	Standard	23.74	36.8	41.0	-4.21	M3	none
PCS	25	off	SO3/RC3	Acoustic	Standard	40.18	32.0	41.0	-9.01	M4	none
PCS	25	off	SO3/RC4	Acoustic	Standard	40.20	32.0	41.0	-9.00	M4	none
PCS	25	off	SO55/RC3	Acoustic	Standard	39.92	31.9	41.0	-9.06	M4	none
PCS	25	off	SO55/RC1	Acoustic	Standard	38.35	31.6	41.0	-9.41	M4	none
PCS	25	off	SO2/RC1	Acoustic	Standard	38.11	31.5	41.0	-9.47	M4	none
PCS	25	off	SO2/RC3	Acoustic	Standard	38.32	31.6	41.0	-9.42	M4	none
PCS	25	off	SO9/RC2	Acoustic	Standard	38.45	31.6	41.0	-9.39	M4	none
PCS	25	off	SO9/RC5	Acoustic	Standard	38.74	31.7	41.0	-9.33	M4	none

FCC ID: BEJAX155	PCTEST ENGINEERING LABORATORY, INC.	HAC (RF EMISSIONS) TEST REPORT	LG	Reviewed by: Quality Manager
HAC Filename: 0804140485.BEJ	Test Dates: April 19 - 26, 2008	EUT Type: Cellular/PCS CDMA Phone	Page 20 of 70	

## 10. OVERALL MEASUREMENT SUMMARY

<b>FCC ID:</b>	BEJAX155
<b>Model:</b>	AX155
<b>S/N:</b>	80D576CE

### I. E-FIELD EMISSIONS:



**Table 10-1  
HAC Data Summary for E-field**

Mode	Channel	Backlight	RC/SO	Scan Center	Battery	Time Avg. Field (V/m)	Peak Field (dBV/m)	FCC Limit (dBV/m)	FCC MARGIN (dB)	RESULT	Excl Blocks per 4.4
<b>E-field Emissions</b>											
CDMA	1013	off	SO3/RC4	Acoustic	Standard	77.04	37.1	51.0	-13.87	M4	none
CDMA	384	off	SO3/RC4	Acoustic	Standard	76.61	37.1	51.0	-13.92	M4	none
CDMA	777	off	SO3/RC4	Acoustic	Standard	66.80	35.9	51.0	-15.11	M4	none
PCS	25	off	SO3/RC4	Acoustic	Standard	36.94	31.3	41.0	-9.74	M4	none
PCS	600	off	SO3/RC4	Acoustic	Standard	35.26	30.9	41.0	-10.14	M4	none
PCS	1175	off	SO3/RC4	Acoustic	Standard	35.54	30.9	41.0	-10.07	M4	none



**Figure 10-1**  
Sample E-field Scan Overlay  
(See Test Setup Photographs for actual WD overlay)

Note: Worst-case measurement evaluated for worst-case 1/8 rate gating condition in RC1/SO3; Mute=Yes

<b>FCC ID:</b> BEJAX155	 <b>PCTEST</b> ENGINEERING LABORATORY, INC.	<b>HAC (RF EMISSIONS) TEST REPORT</b>	 <b>LG</b>	<b>Reviewed by:</b> Quality Manager
<b>HAC Filename:</b> 0804140485.BEJ	<b>Test Dates:</b> April 19 - 26, 2008	<b>EUT Type:</b> Cellular/PCS CDMA Phone		Page 21 of 70

<b>FCC ID:</b>	BEJAX155
<b>Model:</b>	AX155
<b>S/N:</b>	80D576CE



## II. H-FIELD EMISSIONS:

**Table 10-2  
HAC Data Summary for H-field**

Mode	Channel	Backlight	RC/SO	Scan Center	Battery	Time Avg. Field (A/m)	Peak Field (dBA/m)	FCC Limit (dBA/m)	FCC MARGIN (dB)	RESULT	Excl Blocks per 4.4
<b>H-field Emissions</b>											
CDMA	1013	off	SO3/RC4	Acoustic	Standard	0.1214	-19.9	0.6	-20.51	M4	none
CDMA	384	off	SO3/RC4	Acoustic	Standard	0.1218	-19.9	0.6	-20.48	M4	none
CDMA	777	off	SO3/RC4	Acoustic	Standard	0.1068	-21.0	0.6	-21.62	M4	none
PCS	25	off	SO3/RC4	Acoustic	Standard	0.0858	-23.1	-9.4	-13.65	M4	none
PCS	600	off	SO3/RC4	Acoustic	Standard	0.0566	-26.7	-9.4	-17.26	M4	none
PCS	1175	off	SO3/RC4	Acoustic	Standard	0.0609	-26.0	-9.4	-16.63	M4	none



**Figure 10-2**  
Sample H-field Scan Overlay  
(See Test Setup Photographs for actual WD overlay)

<b>FCC ID:</b> BEJAX155	 <b>PCTEST</b> ENGINEERING LABORATORY, INC.	<b>HAC (RF EMISSIONS) TEST REPORT</b>	 <b>LG</b>	<b>Reviewed by:</b> Quality Manager
<b>HAC Filename:</b> 0804140485.BEJ	<b>Test Dates:</b> April 19 - 26, 2008	<b>EUT Type:</b> Cellular/PCS CDMA Phone		Page 22 of 70

FCC ID:	BEJAX155
Model:	AX155
S/N:	80D576CE

### III. Worst-case Configuration Evaluation

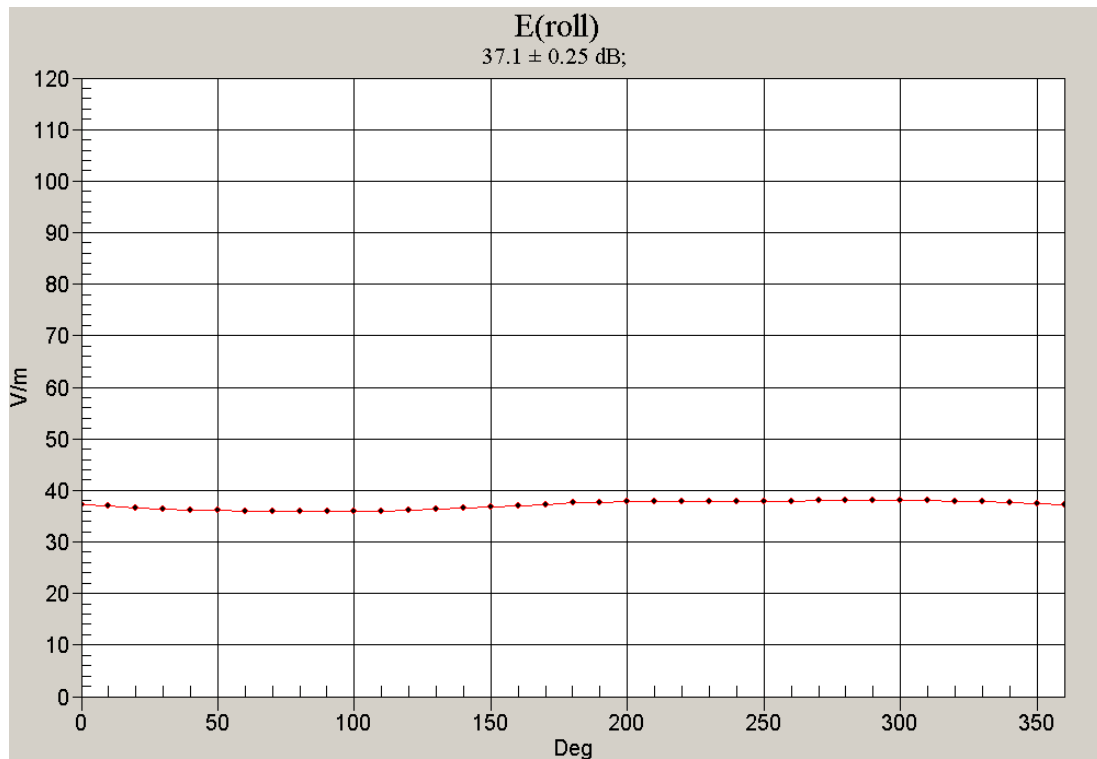

**Table 10-3**  
**Peak Reading 360° Probe Rotation at Azimuth axis**

Mode	Channel	Backlight	RC/SO	Scan Center	Battery	Time Avg. Field (V/m)	Peak Field (dBV/m)	FCC Limit (dBV/m)	FCC MARGIN (dB)	RESULT
<b>Probe Rotation at Worst-case</b>										
PCS	25	off	SO3/RC4	Acoustic	Standard	38.06	31.5	41.0	-9.48	M4



**Figure 10-3**  
**Worst-Case Probe Rotation about Azimuth axis**

\* Note: Location of probe rotation is shown in Figure 10-1 or Figure 10-2



FCC ID: BEJAX155	 PCTEST ENGINEERING LABORATORY, INC.	HAC (RF EMISSIONS) TEST REPORT	 LG	Reviewed by: Quality Manager
HAC Filename: 0804140485.BEJ	Test Dates: April 19 - 26, 2008	EUT Type: Cellular/PCS CDMA Phone	Page 23 of 70	

## 11. EQUIPMENT LIST

Manufacturer	Model	Description	Calibration Date	Cal Interval	Calibration Due	Serial No.
Agilent	8648D	(9kHz-4GHz) Signal Generator	10/11/07	Biennial	10/10/09	3613A00315
Agilent	E4407B	ESA Spectrum Analyzer	3/13/08	Annual	3/13/09	US39210313
Agilent	E4432B	ESG-D Series Signal Generator	8/8/06	Biennial	8/8/08	US40053896
Agilent	E5515C	Wireless Communications Test Set	6/8/07	Biennial	6/8/09	GB46110872
Agilent	E5515C	Wireless Communications Test Set	6/8/07	Biennial	6/8/09	GB46310798
Agilent	E5515C	Wireless Communications Test Set	8/31/07	Biennial	8/31/09	GB41450275
Agilent	N4010A	Wireless Connectivity Test Set	6/11/07	Annual	6/11/08	GB46170464
Bruel & Kjaer	4128	Head and Torso Simulator	5/16/06	Biennial	5/15/08	1947220
Bruel & Kjaer	4231	Acoustical Calibrator	6/1/06	Biennial	5/31/08	2343018
Rohde & Schwarz	CMU200	Base Station Simulator	5/24/07	Annual	5/23/08	836371/0079
Rohde & Schwarz	CMU200	Base Station Simulator	9/7/07	Annual	9/6/08	833855/0010
Rohde & Schwarz	CMU200	Base Station Simulator	12/6/07	Annual	12/5/08	107826
Rohde & Schwarz	CMU200	Base Station Simulator	12/13/07	Annual	12/13/08	109892
Rohde & Schwarz	NRVD	Dual Channel Power Meter	12/12/06	Biennial	12/11/08	101695
Rohde & Schwarz	NRVS	Single Channel Power Meter	7/3/07	Biennial	7/2/09	835360/0079
Rohde & Schwarz	NRV-Z32	Peak Power Sensor (100uW-2W)	12/21/06	Biennial	12/20/08	100155
Rohde & Schwarz	NRV-Z33	Peak Power Sensor (1mW-20W)	11/28/06	Biennial	11/27/08	100004
Rohde & Schwarz	NRV-Z53	Power Sensor	7/3/07	Biennial	7/2/09	846076/0007
SPEAG	CD1880V3	Freespace 1880 MHz Dipole	1/16/07	Biennial	1/15/09	1002
SPEAG	CD1880V3	Freespace 1880 MHz Dipole	3/11/08	Biennial	3/11/10	1064
SPEAG	CD2450V3	Freespace 2450 MHz Dipole	7/18/06	Biennial	7/17/08	1062
SPEAG	CD835V3	Freespace 835 MHz Dipole	7/17/06	Biennial	7/16/08	1082
SPEAG	CD835V3	Freespace 835 MHz Dipole	1/16/07	Biennial	1/15/09	1003
SPEAG	DAE3	Dasy Data Acquisition Electronics	11/13/07	Annual	11/12/08	455
SPEAG	DAE4	Dasy Data Acquisition Electronics	5/25/07	Annual	5/24/08	704
SPEAG	DAE4	Dasy Data Acquisition Electronics	8/29/07	Annual	8/28/08	665
SPEAG	DAE4	Dasy Data Acquisition Electronics	1/30/08	Annual	1/29/09	649
SPEAG	ER3DV6	Freespace E-field Probe	7/19/07	Annual	7/18/08	2353
SPEAG	ER3DV6	Freespace E-field Probe	11/20/07	Annual	11/19/08	2335
SPEAG	ER3DV6	Freespace E-field Probe	1/28/08	Annual	1/27/09	2332
SPEAG	H3DV6	Freespace H-field Probe	7/19/07	Annual	7/18/08	6207
SPEAG	H3DV6	Freespace H-field Probe	11/20/07	Annual	11/19/08	6170
SPEAG	H3DV6	Freespace H-field Probe	1/28/08	Annual	1/27/09	6180

**Table 11-1**  
Equipment List

\*Calibration traceable to the National Institute of Standards and Technology (NIST).

FCC ID: BEJAX155	 <b>PCTEST</b> ENGINEERING LABORATORY, INC.	<b>HAC (RF EMISSIONS) TEST REPORT</b>	 <b>LG</b>	Reviewed by: Quality Manager
HAC Filename: 0804140485.BEJ	Test Dates: April 19 - 26, 2008	EUT Type: Cellular/PCS CDMA Phone	Page 24 of 70	

## 12. MEASUREMENT UNCERTAINTY



Wireless Communications Device Near-Field Measurement						
Uncertainty Estimation						
Uncertainty Component	Data (dB)	Data Type	Prob. Dist.	Divisor	Unc. (dB)	Notes/Comments
<b>Measurement System</b>						
RF System Reflections	0.50	Tolerance	N	1.00	0.50	Ref. < -20 dB
Field Probe Calibration	0.21	Tolerance	N	1.00	0.21	
Field Probe Isotropy	0.01	Tolerance	N	1.00	0.01	
Field Probe Frequency Response	0.135	Tolerance	N	1.00	0.14	
Field Probe Linearity	0.013	Tolerance	N	1.00	0.01	
Probe Modulation Factor	0.468	Accuracy	R	1.73	0.28	
Boundary Effects	0.105	Accuracy	R	1.73	0.06	*
Probe Positioning Accuracy	0.20	Accuracy	R	1.73	0.12	*
Probe Positioner	0.050	Accuracy	R	1.73	0.03	*
Extrapolation/Interpolation	0.045	Tolerance	R	1.73	0.03	*
System Detection Limit	0.05	Tolerance	R	1.73	0.03	*
Readout Electronics	0.015	Tolerance	N	1.00	0.02	*
Integration Time	0.11	Tolerance	R	1.73	0.06	*
Response Time	0.033	Tolerance	R	1.73	0.02	*
Phantom Thickness	0.10	Tolerance	R	1.73	0.06	*
System Repeatability (Field x 2=power)	0.17	Tolerance	N	1.00	0.17	
<b>Test Sample Related</b>						
Device Positioning Vertical	0.2	Tolerance	R	1.73	0.12	*
Device Positioning Lateral	0.045	Tolerance	R	1.73	0.03	*
Device Holder and Phantom	0.1	Tolerance	R	1.73	0.06	*
Power Drift	0.21	Tolerance	R	1.73	0.12	
<b>Combined Standard Uncertainty (k=1)</b>					<b>0.67</b>	<b>16.6%</b>
<b>Expanded Uncertainty [95% confidence] (k=2)</b>					<b>1.34</b>	<b>32.6%</b>
<b>Expanded Uncertainty [95% confidence] on Field</b>					<b>0.67</b>	<b>16.3%</b>

**Table 12-1**  
Uncertainty Estimation Table

Notes:



1. Test equipments are calibrated according to techniques outlined in NIS81, NIS3003 and NIST Tech Note 1297. All equipments have traceability according to NIST. Measurement Uncertainties are defined in further detail in NIS 81 and NIST Tech Note 1297 and UKAS M3003.
2. \* Uncertainty specifications from Schmidt & Partner Engineering AG (not site specific)

Measurement uncertainty reflects the quality and accuracy of a measured result as compared to the true value. Such statements are generally required when stating results of measurements so that it is clear to the intended audience that the results may differ when reproduced by different facilities. Measurement results vary due to the measurement uncertainty of the instrumentation, measurement technique, and test engineer. Most uncertainties are calculated using the tolerances of the instrumentation used in the measurement, the measurement setup variability, and the technique used in performing the test. While not generally included, the variability of the equipment under test also figures into the overall measurement uncertainty. Another component of the overall uncertainty is based on the variability of repeated measurements (so-called Type A uncertainty). This may mean that the Hearing Aid immunity tests may have to be repeated by taking down the test setup and resetting it up so that there are a statistically significant number of repeat measurements to identify the measurement uncertainty. By combining the repeat measurement results with that of the instrumentation chain using the technique contained in NIS 81 and NIS 3003, the overall measurement uncertainty was estimated.

FCC ID: BEJAX155		HAC (RF EMISSIONS) TEST REPORT		Reviewed by: Quality Manager
HAC Filename: 0804140485.BEJ	Test Dates: April 19 - 26, 2008	EUT Type: Cellular/PCS CDMA Phone	Page 25 of 70	

## 13. TEST DATA

See following Attached Pages for Test Data.

<b>FCC ID:</b> BEJAX155	 <b>PCTEST</b> ENGINEERING LABORATORY, INC.	<b>HAC (RF EMISSIONS) TEST REPORT</b>		<b>Reviewed by:</b> Quality Manager
<b>HAC Filename:</b> 0804140485.BEJ	<b>Test Dates:</b> April 19 - 26, 2008	<b>EUT Type:</b> Cellular/PCS CDMA Phone		Page 26 of 70

Date: 4/19/2008

**PCTEST**  
ENGINEERING LABORATORY, INC.  
**PCTEST Hearing-Aid Compatibility Facility**

**DUT: CD835V3 - SN1082**

Type: CD835V3  
Serial: 1082

**Communication System: CW; Frequency: 835 MHz;**

Measurement Standard: DAS4 (High Precision Assessment)

DAS4 Configuration:



- Probe: ER3DV6 - SN2335; Calibrated: 11/20/2007
- Sensor-Surface: 0mm (Fix Surface)
- Electronics: DAE4 Sn665; Calibrated: 8/29/2007
- Phantom: HAC; Type: SD HAC P01 BA;
- Measurement SW: DAS4, V4.7 Build 53;

**835MHz, 100mW/20dBm/Hearing Aid Compatibility Test (41x361 x1):**

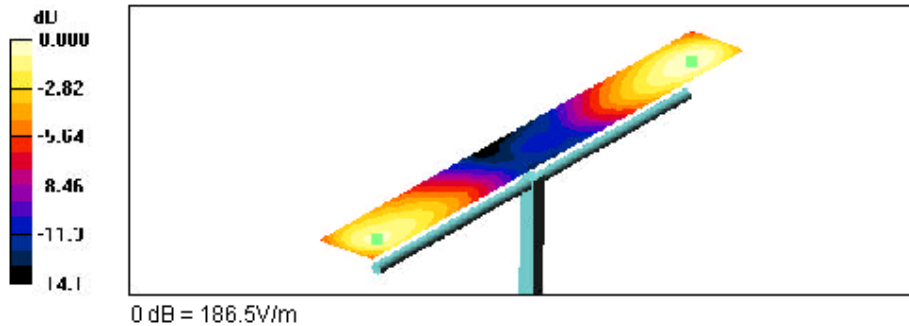
Measurement grid: dx=5mm, dy=5mm  
Probe Modulation Factor = 1.00  
Reference Value = 116.1 V/m; Power Drift = -0.063 dB  
Average value of Total (interpolated) = 179.9 V/m



© 2008 PCTEST

FCC ID: BEJAX155	 PCTEST ENGINEERING LABORATORY, INC.	HAC (RF EMISSIONS) TEST REPORT	 LG	Reviewed by: Quality Manager
HAC Filename: 0804140485.BEJ	Test Dates: April 19 - 26, 2008	EUT Type: Cellular/PCS CDMA Phone	Page 27 of 70	

Date: 4/19/2008

**PCTEST**  
ENGINEERING LABORATORY, INC.  
**PCTEST Hearing-Aid Compatibility Facility**

**DUT: CD1880V3 - SN1064**

Type: CD1880V3  
Serial: 1064

**Communication System: CW; Frequency: 1880 MHz;**

Measurement Standard: DAS4 (High Precision Assessment)

DAS4 Configuration:

- Probe: ER3DV6 - SN2335; Calibrated: 11/20/2007
- Sensor-Surface: 0mm (Fix Surface)
- Electronics: DAE4 Sn665; Calibrated: 8/29/2007
- Phantom: HAC; Type: SD HAC P01 BA;
- Measurement SW: DAS4, V4.7 Build 53;

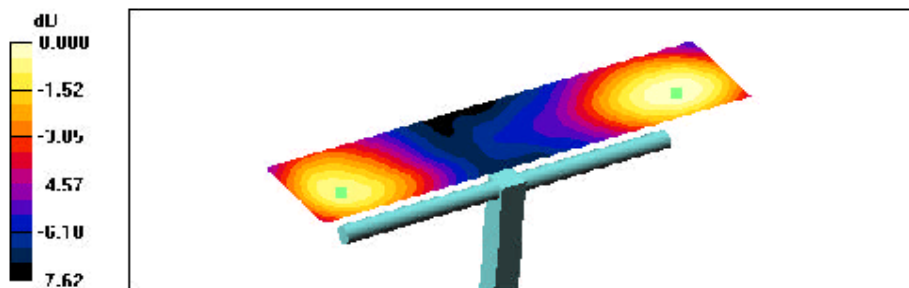

**1880MHz, 100mW/20dBm/Hearing Aid Compatibility Test (41x181x1):**

Measurement grid: dx=5mm, dy=5mm  
Probe Modulation Factor = 1.00  
Reference Value = 163.5 V/m; Power Drift = -0.020 dB  
Average value of Total (interpolated) = 138.6 V/m



0 dB = 142.3V/m

© 2008 PCTEST

FCC ID: BEJAX155	 PCTEST ENGINEERING LABORATORY, INC.	HAC (RF EMISSIONS) TEST REPORT	 LG	Reviewed by: Quality Manager
HAC Filename: 0804140485.BEJ	Test Dates: April 19 - 26, 2008	EUT Type: Cellular/PCS CDMA Phone	Page 28 of 70	

Date: 4/19/2008

**PCTEST**  
ENGINEERING LABORATORY, INC.  
**PCTEST Hearing-Aid Compatibility Facility**

**DUT: CD835V3 - SN1082**

Type: CD835V3  
Serial: 1082

**Communication System: CW; Frequency: 835 MHz;**

Measurement Standard: DASY4 (High Precision Assessment)

DASY4 Configuration :



- Probe: HSDV6 - SN6170; Calibrated: 11/20/2007
- Sensor-Surface: 0mm (Fix Surface)
- Electronics: DAE4 Sn665; Calibrated: 8/29/2007
- Phantom: HAC; Type: SD HAC P01 BA;
- Measurement SW: DASY4, V4.7 Build 53;

**835MHz, 100mW/20dBm/Hearing Aid Compatibility Test (41x361 x1):**

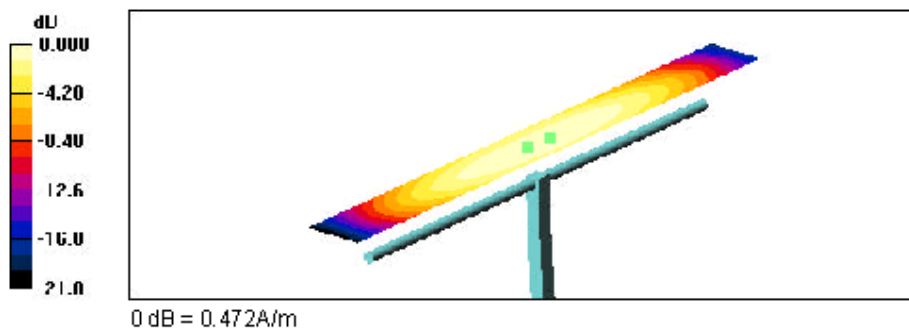
Measurement grid: dx=5mm, dy=5mm  
Probe Modulation Factor = 1.00  
Reference Value = 0.472 A/m; Power Drift = 0.004 dB  
Maximum value of Total (interpolated) = 0.472 A/m



© 2008 PCTEST

FCC ID: BEJAX155	 PCTEST ENGINEERING LABORATORY, INC.	HAC (RF EMISSIONS) TEST REPORT	 LG	Reviewed by: Quality Manager
HAC Filename: 0804140485.BEJ	Test Dates: April 19 - 26, 2008	EUT Type: Cellular/PCS CDMA Phone	Page 29 of 70	

Date: 4/19/2008



**DUT: CD1880V3 - SN1064**

Type: CD1880V3  
Serial: 1064

**Communication System: CW; Frequency: 1880 MHz;**

Measurement Standard: DASY4 (High Precision Assessment)

DASY4 Configuration :

- Probe: HSDV6 - SN6170; Calibrated: 11/20/2007
- Sensor-Surface: 0mm (Fix Surface)
- Electronics: DAE4 Sn665; Calibrated: 8/29/2007
- Phantom: HAC; Type: SD HAC P01 BA;
- Measurement SW: DASY4, V4.7 Build 53;

**1880MHz, 100mW/20dBm/Hearing Aid Compatibility Test (41x181x1):**

Measurement grid: dx=5mm, dy=5mm  
Probe Modulation Factor = 1.00

Reference Value = 0.477 A/m; Power Drift = -0.011 dB  
Maximum value of Total (interpolated) = 0.446 A/m

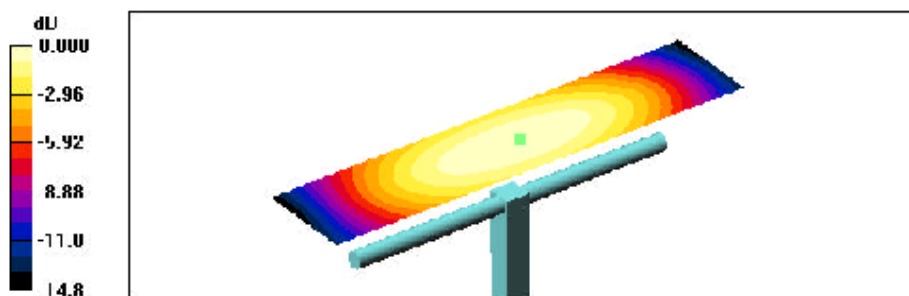

0 dB = 0.446A/m

© 2008 PCTEST

FCC ID: BEJAX155	PCTEST ENGINEERING LABORATORY, INC.	HAC (RF EMISSIONS) TEST REPORT	LG	Reviewed by: Quality Manager
HAC Filename: 0804140485.BEJ	Test Dates: April 19 - 26, 2008	EUT Type: Cellular/PCS CDMA Phone	Page 30 of 70	

  
**PCTEST Hearing-Aid Compatibility Facility**

**DUT: AX155**  
 Type: Cellular/PCS CDMA Phone w/ Bluetooth  
 Serial: 80D576CE  
*Backlight off*  
*Duty Cycle: 1:1*

**Communication System: Cellular CDMA; Frequency: 824.7 MHz;**

Measurement Standard: DAS14 (High Precision Assessment)

DASY4 Configuration:

- Probe: ER3DV6 - SN2335; Calibrated: 11/20/2007
- Sensor Surface: (Fix Surface)
- Electronics: DAE4 Sn665; Calibrated: 8/29/2007
- Phantom: HAC; Type: SD HAC P01 BA;
- Measurement SW: DAS14, V4.7 Build 53;

**Low.ch CDMA/Hearing Aid Compatibility Test (251x251x1):**



Measurement grid dx=2mm, dy=2mm  
 Maximum value of peak Total field = 71.9 V/m  
 Probe Modulation Factor = 0.933  
 Reference Value = 72.3 V/m; Power Drift = 0.149 dB  
**Hearing Aid Near-Field Category: M4 (AWF 0 dB)**

Peak E-field in V/m

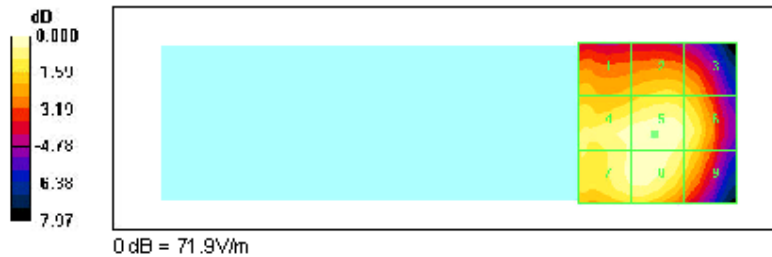
Grid 1	Grid 2	Grid 3
<b>58.8</b>	<b>61.7</b>	<b>60.0</b>
Grid 4	Grid 5	Grid 6
<b>69.6</b>	<b>71.9</b>	<b>68.0</b>
Grid 7	Grid 8	Grid 9
<b>69.2</b>	<b>70.4</b>	<b>64.6</b>



© 2008 PCTEST

FCC ID: BEJAX155		HAC (RF EMISSIONS) TEST REPORT		Reviewed by: Quality Manager
HAC Filename: 0804140485.BEJ	Test Dates: April 19 - 26, 2008	EUT Type: Cellular/PCS CDMA Phone	Page 31 of 70	

  
**PCTEST Hearing-Aid Compatibility Facility**

**DUT: AX155**  
 Type: Cellular/PCS CDMA Phone w/ Bluetooth  
 Serial: 80D576CE  
*Backlight off*  
*Duty Cycle: 1:1*

**Communication System: PCS CDMA; Frequency: 1851.25 MHz;**

Measurement Standard: DAS4 (High Precision Assessment)

DASY4 Configuration:

- Probe: ER3DV6 - SN2335; Calibrated: 11/20/2007
- Sensor Surface: (Fix Surface)
- Electronics: DAE4 Sn685; Calibrated: 8/29/2007
- Phantom: HAC; Type: SD HAC P01 BA;
- Measurement SW: DAS4, V4.7 Build 53;

**Low-ch/Hearing Aid Compatibility Test (251x251x1):**



Measurement grid dx=2mm, dy=2mm  
 Maximum value of peak Total field = 36.6 V/m  
 Probe Modulation Factor = 0.990  
 Reference Value = 31.5 V/m; Power Drift = 0.084 dB  
**Hearing Aid Near-Field Category: M4 (AWF 0 dB)**

Peak E-field in V/m

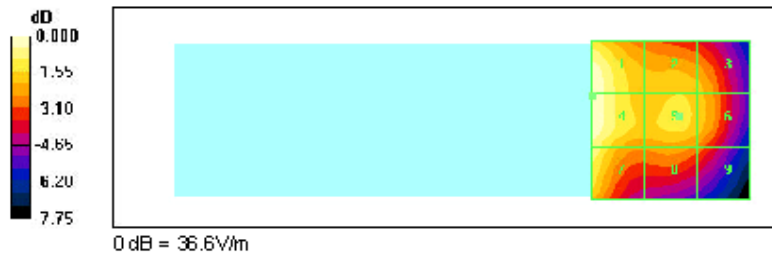
Grid 1	Grid 2	Grid 3
<b>36.6</b>	<b>30.6</b>	<b>29.9</b>
Grid 4	Grid 5	Grid 6
<b>36.6</b>	<b>31.4</b>	<b>30.5</b>
Grid 7	Grid 8	Grid 9
<b>33.9</b>	<b>28.3</b>	<b>26.8</b>



© 2008 PCTEST

FCC ID: BEJAX155		HAC (RF EMISSIONS) TEST REPORT		Reviewed by: Quality Manager
HAC Filename: 0804140485.BEJ	Test Dates: April 19 - 26, 2008	EUT Type: Cellular/PCS CDMA Phone	Page 32 of 70	

  
**PCTEST Hearing-Aid Compatibility Facility**

**DUT: AX155**

Type: Cellular/PCS CDMA Phone w/ Bluetooth  
 Serial: 80D576CE  
*Backlight off*  
*Duty Cycle: 1:1*

**Communication System: Cellular CDMA; Frequency: 836.52 MHz;**

Measurement Standard: DAS4 (High Precision Assessment)

DASY4 Configuration:

- Probe: H3DV6 - SN6170; Calibrated: 11/20/2007
- Sensor Surface: (Fix Surface)
- Electronics: DAE4 Sn665; Calibrated: 8/29/2007
- Phantom: HAC; Type: SD HAC P01 BA;
- Measurement SW: DAS4, V4.7 Build 53;

**Mid.ch cdma/Hearing Aid Compatibility Test (251x251x1):**



Measurement grid dx=2mm, dy=2mm  
 Maximum value of peak Total field = 0.101 A/m  
 Probe Modulation Factor = 0.833  
 Reference Value = 0.060 A/m; Power Drift = -0.114 dB  
**Hearing Aid Near-Field Category: M4 (AWF 0 dB)**

Peak H-field in A/m

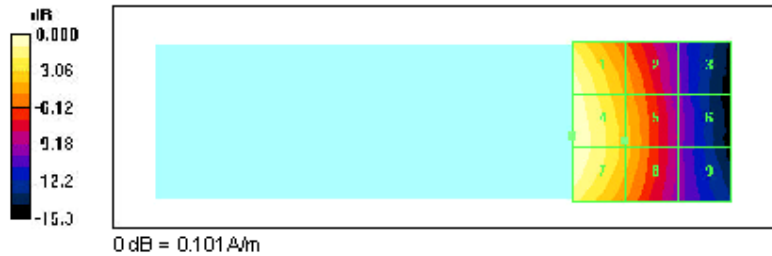
Grid 1	Grid 2	Grid 3
<b>0.097</b>	<b>0.062</b>	<b>0.033</b>
Grid 4	Grid 5	Grid 6
<b>0.101</b>	<b>0.066</b>	<b>0.034</b>
Grid 7	Grid 8	Grid 9
<b>0.101</b>	<b>0.066</b>	<b>0.034</b>



© 2008 PCTEST

FCC ID: BEJAX155		HAC (RF EMISSIONS) TEST REPORT		Reviewed by: Quality Manager
HAC Filename: 0804140485.BEJ	Test Dates: April 19 - 26, 2008	EUT Type: Cellular/PCS CDMA Phone	Page 33 of 70	

  
**PCTEST Hearing-Aid Compatibility Facility**

**DUT: AX155**

Type: Cellular/PCS CDMA Phone w/ Bluetooth  
 Serial: 80D576CE  
*Backlight off*  
*Duty Cycle: 1:1*

**Communication System: PCS CDMA; Frequency: 1880 MHz;**

Measurement Standard: DAS14 (High Precision Assessment)

DASY4 Configuration:

- Probe: H3DV6 - SN6170; Calibrated: 11/20/2007
- Sensor Surface: (Fix Surface)
- Electronics: DAE4 Sn665; Calibrated: 8/29/2007
- Phantom: HAC; Type: SD HAC P01 BA;
- Measurement SW: DASY4, V4.7 Build 53;

**Mid.ch/Hearing Aid Compatibility Test (251x251x1):**



Measurement grid: dx=2mm, dy=2mm  
 Maximum value of peak Total field = 0.046 A/m  
 Probe Modulation Factor = 0.820  
 Reference Value = 0.041 A/m; Power Drift = -0.122 dB  
**Hearing Aid Near-Field Category: M4 (AWF 0 dB)**

Peak H-field in A/m

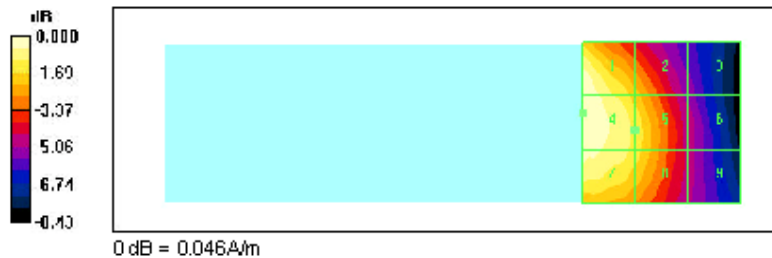
Grid 1	Grid 2	Grid 3
<b>0.046</b>	<b>0.037</b>	<b>0.025</b>
Grid 4	<b>Grid 5</b>	Grid 6
<b>0.046</b>	<b>0.040</b>	<b>0.027</b>
Grid 7	Grid 8	Grid 9
<b>0.045</b>	<b>0.039</b>	<b>0.027</b>





© 2008 PCTEST

FCC ID: BEJAX155		HAC (RF EMISSIONS) TEST REPORT		Reviewed by: Quality Manager
HAC Filename: 0804140485.BEJ	Test Dates: April 19 - 26, 2008	EUT Type: Cellular/PCS CDMA Phone	Page 34 of 70	

## 14. CALIBRATION CERTIFICATES

The following pages include the probe calibration used to evaluate HAC for the DUT.

<b>FCC ID:</b> BEJAX155	 <b>PCTEST</b> ENGINEERING LABORATORY, INC.	<b>HAC (RF EMISSIONS) TEST REPORT</b>	 <b>LG</b>	<b>Reviewed by:</b> Quality Manager
<b>HAC Filename:</b> 0804140485.BEJ	<b>Test Dates:</b> April 19 - 26, 2008	<b>EUT Type:</b> Cellular/PCS CDMA Phone	Page 35 of 70	

Calibration Laboratory of  
Schmid & Partner  
Engineering AG  
Zeughausstrasse 43, 8004 Zurich, Switzerland



S Schweizerischer Kalibrierdienst  
C Service suisse d'étalonnage  
S Servizio svizzero di taratura  
S Swiss Calibration Service

Accredited by the Swiss Accreditation Service (SAS)  
The Swiss Accreditation Service is one of the signatories to the EA  
Multilateral Agreement for the recognition of calibration certificates

Accreditation No.: SCS 108

Client **PC Test**

Certificate No: ER3-2335\_Nov07

### CALIBRATION CERTIFICATE

Object: **ER3DV6 - SN:2335**

Calibration procedure(s): **QA CAL-02.v5  
Calibration procedure for E-field probes optimized for close near field  
evaluations in air**

Calibration date: **November 20, 2007**

Condition of the calibrated item: **In Tolerance**

This calibration certificate documents the traceability to national standards, which realize the physical units of measurements (SI).  
The measurements and the uncertainties with confidence probability are given on the following pages and are part of the certificate.

All calibrations have been conducted in the closed laboratory facility: environment temperature (22 ± 3)°C and humidity < 70%.

Calibration Equipment used (M&PE critical for calibration)

Primary Standards	ID #	Cal Date (Calibrated by, Certificate No.)	Scheduled Calibration
Power meter E4410B	0941280874	29-Mar-07 (METAS, No. 217-00670)	Mar-08
Power sensor E4412A	MY41405277	29-Mar-07 (METAS, No. 217-00670)	Mar-08
Power sensor E4412A	MY41409067	29-Mar-07 (METAS, No. 217-00670)	Mar-08
Reference 3 dB Attenuator	SN: S8054 (3a)	9-Aug-07 (METAS, No. 217-00719)	Aug-08
Reference 20 dB Attenuator	SN: S8086 (20b)	29-Mar-07 (METAS, No. 217-00671)	Mar-08
Reference 30 dB Attenuator	SN: S8126 (30b)	9-Aug-07 (METAS, No. 217-00720)	Aug-08
Reference Probe LR3DV6	SN: 2326	2-Oct-07 (SPEAG, No. ERS-2326_Oct07)	Oct-08
DAE4	SN: 654	26-Apr-07 (SPEAG, No. DAE4-654_Apr07)	Apr-08

Secondary Standards	ID #	Check Date (In House)	Scheduled Check
RF generator HP 6640C	US2642J01700	4-Aug-09 (PPFA), In house check Oct-07	In house check: Oct-09
Network Analyzer HP 8753C	US37300695	18-Oct-01 (SPEAG, In house check Oct-07)	In house check: Oct-06

Calibrated by:	Name	Function	Signature
	Katja Pokovic	Technical Manager	
Approved by:	Nils Kusler	Quality Manager	

Issued: November 20, 2007

This calibration certificate shall not be reproduced except in full without written approval of the laboratory.

Certificate No: ER3-2335\_Nov07

Page 1 of 9

FCC ID: BEJAX155	PCTEST ENGINEERING LABORATORY, INC.	HAC (RF EMISSIONS) TEST REPORT	LG	Reviewed by: Quality Manager
HAC Filename: 0804140485.BEJ	Test Dates: April 19 - 26, 2008	EUT Type: Cellular/PCS CDMA Phone		Page 36 of 70

**Calibration Laboratory of  
Schmid & Partner  
Engineering AG**  
Zeughausstrasse 43, 8004 Zurich, Switzerland



S Schweizerischer Kalibrierdienst  
S Service suisse d'étalonnage  
S Servizio svizzero di taratura  
S Swiss Calibration Service

Accredited by the Swiss Accreditation Service (SAS):  
The Swiss Accreditation Service is one of the signatories to the EA  
Multilateral Agreement for the recognition of calibration certificates

Accreditation No.: **SCS 108**

**Glossary:**

**NORM<sub>x,y,z</sub>** sensitivity in free space  
**DCP** diode compression point  
**Polarization  $\alpha$**   $\alpha$  rotation around probe axis  
**Polarization  $\vartheta$**   $\vartheta$  rotation around an axis that is in the plane normal to probe axis (at measurement center), i.e.,  $\vartheta = 0$  is normal to probe axis  
**Connector Angle** information used in DASY system to align probe sensor X to the robot coordinate system

**Calibration is Performed According to the Following Standards:**

- a) IEEE Std 1309-2005, "IEEE Standard for calibration of electromagnetic field sensors and probes, excluding antennas, from 9 kHz to 40 GHz", December 2005.

**Methods Applied and Interpretation of Parameters:**

- **NORM<sub>x,y,z</sub>**: Assessed for E-field polarization  $\vartheta = 0$  for XY sensors and  $\vartheta = 90$  for Z sensor ( $f \leq 900$  MHz in TEM-cell;  $f > 1800$  MHz: R22 waveguide).
- **NORM(f)<sub>x,y,z</sub>** = **NORM<sub>x,y,z</sub>** \* *frequency\_response* (see Frequency Response Chart).
- **DCP<sub>x,y,z</sub>**: DCP are numerical linearization parameters assessed based on the data of power sweep (no uncertainty required). DCP does not depend on frequency.
- **Spherical isotropy (3D deviation from isotropy)**: in a locally homogeneous field realized using an open waveguide setup.
- **Sensor Offset**: The sensor offset corresponds to the offset of virtual measurement center from the probe tip (on probe axis). No tolerance required.
- **Connector Angle**: The angle is assessed using the information gained by determining the **NORM<sub>x</sub>** (no uncertainty required).

FCC ID: BEJAX155	PCTEST ENGINEERING LABORATORY, INC.	HAC (RF EMISSIONS) TEST REPORT	LG	Reviewed by: Quality Manager
HAC Filename: 0804140485.BEJ	Test Dates: April 19 - 26, 2008	EUT Type: Cellular/PCS CDMA Phone	Page 37 of 70	



# Probe ER3DV6

## SN:2335

Manufactured: May 31, 2006  
 Last calibrated: July 10, 2006  
 Recalibrated: November 20, 2007

Calibrated for DASY Systems

(Note: non-compatible with DASY2 system!)

FCC ID: BEJAX155		HAC (RF EMISSIONS) TEST REPORT		Reviewed by: Quality Manager
HAC Filename: 0804140485.BEJ	Test Dates: April 19 - 26, 2008	EUT Type: Cellular/PCS CDMA Phone	Page 38 of 70	

**DASY - Parameters of Probe: ER3DV6 SN:2335**

Sensitivity in Free Space [ $\mu\text{V}/(\text{V}/\text{m})^2$ ]		Diode Compression <sup>A</sup>	
NormX	1.64 ± 10.1 % (k=2)	DCP X	93 mV
NormY	1.67 ± 10.1 % (k=2)	DCP Y	93 mV
NormZ	1.92 ± 10.1 % (k=2)	DCP Z	96 mV

## Frequency Correction

X	0.0
Y	0.0
Z	0.0



## Sensor Offset (Probe Tip to Sensor Center)

X	2.5 mm
Y	2.5 mm
Z	2.5 mm

## Connector Angle -285 °

The reported uncertainty of measurement is stated as the standard uncertainty of measurement multiplied by the coverage factor k=2, which for a normal distribution corresponds to a coverage probability of approximately 95%.

<sup>A</sup> numerical linearization parameter, in case it is not required

FCC ID: BEJAX155	 <b>PCTEST</b> ENGINEERING LABORATORY, INC.	HAC (RF EMISSIONS) TEST REPORT	 LG	Reviewed by: Quality Manager
HAC Filename: 0804140485.BEJ	Test Dates: April 19 - 26, 2008	EUT Type: Cellular/PCS CDMA Phone	Page 39 of 70	

### Frequency Response of E-Field (TEM-Cell:ff110 EXX, Waveguide R22)

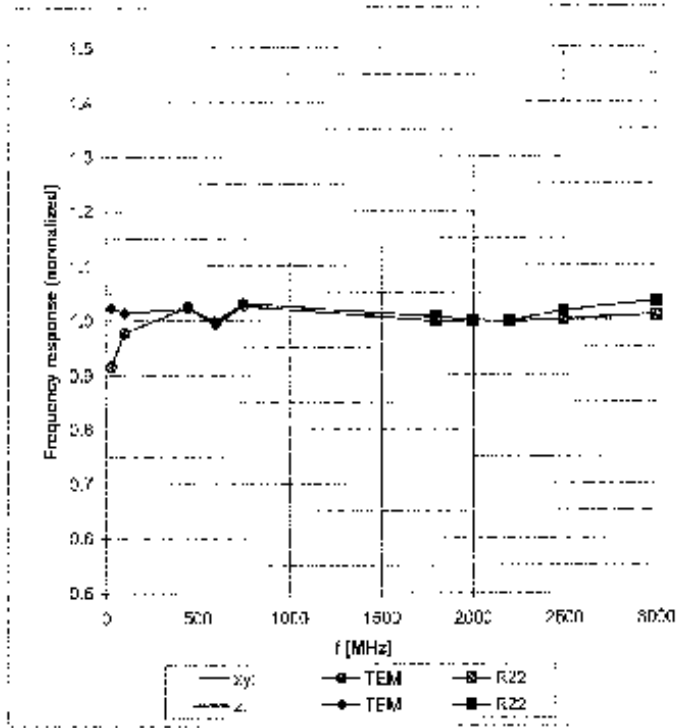

Uncertainty of Frequency Response of E-field:  $\pm 6.3\%$  (k=2)

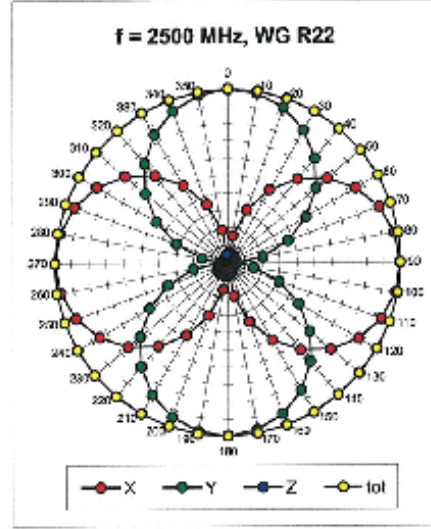
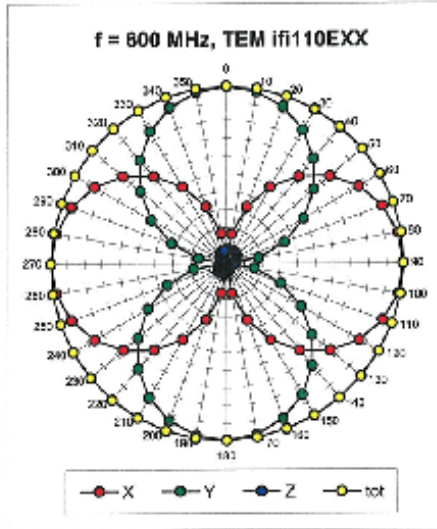

FCC ID: BEJAX155	PCTEST ENGINEERING LABORATORY, INC.	HAC (RF EMISSIONS) TEST REPORT	LG	Reviewed by: Quality Manager
HAC Filename: 0804140485.BEJ	Test Dates: April 19 - 26, 2008	EUT Type: Cellular/PCS CDMA Phone		Page 40 of 70

Receiving Pattern ( $\phi$ ),  $\theta = 0^\circ$

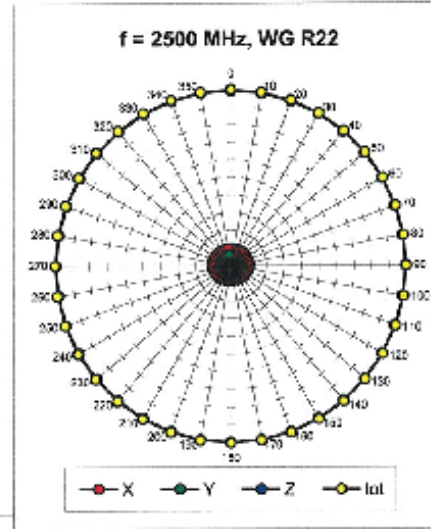
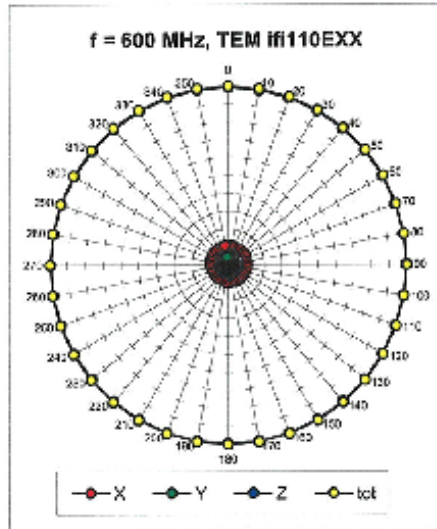

Receiving Pattern ( $\phi$ ),  $\theta = 90^\circ$



<p>FCC ID: BEJAX155</p>		<p>HAC (RF EMISSIONS) TEST REPORT</p>	 <p>Reviewed by: Quality Manager</p>
<p>HAC Filename: 0804140485.BEJ</p>	<p>Test Dates: April 19 - 26, 2008</p>	<p>EUT Type: Cellular/PCS CDMA Phone</p>	<p>Page 41 of 70</p>

### Receiving Pattern ( $\phi$ ), $\theta = 0^\circ$

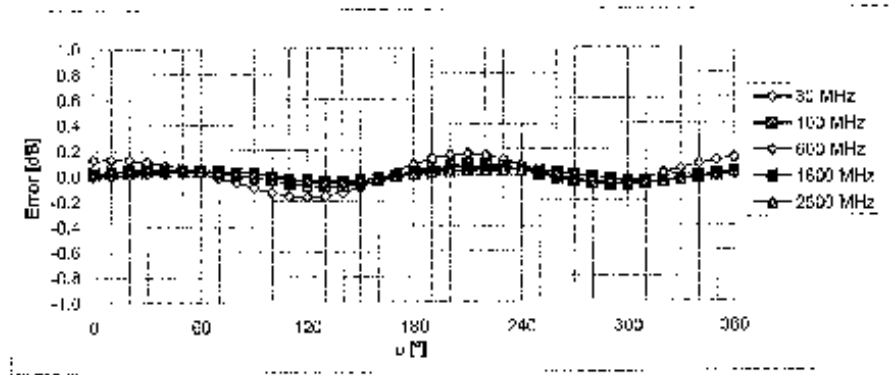

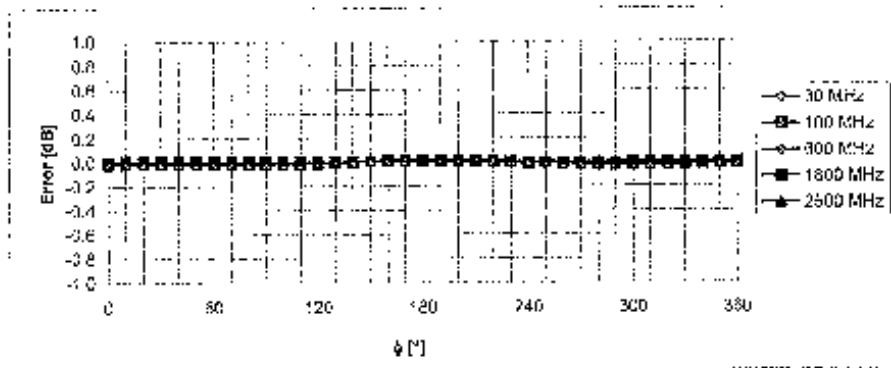

Uncertainty of Axial Isotropy Assessment:  $\pm 0.5\%$  ( $k=2$ )

### Receiving Pattern ( $\phi$ ), $\theta = 90^\circ$





Uncertainty of Axial Isotropy Assessment:  $\pm 0.5\%$  ( $k=2$ )

FCC ID: BEJAX155	 PCTEST ENGINEERING LABORATORY, INC.	HAC (RF EMISSIONS) TEST REPORT	 LG	Reviewed by: Quality Manager
HAC Filename: 0804140485.BEJ	Test Dates: April 19 - 26, 2008	EUT Type: Cellular/PCS CDMA Phone		Page 42 of 70

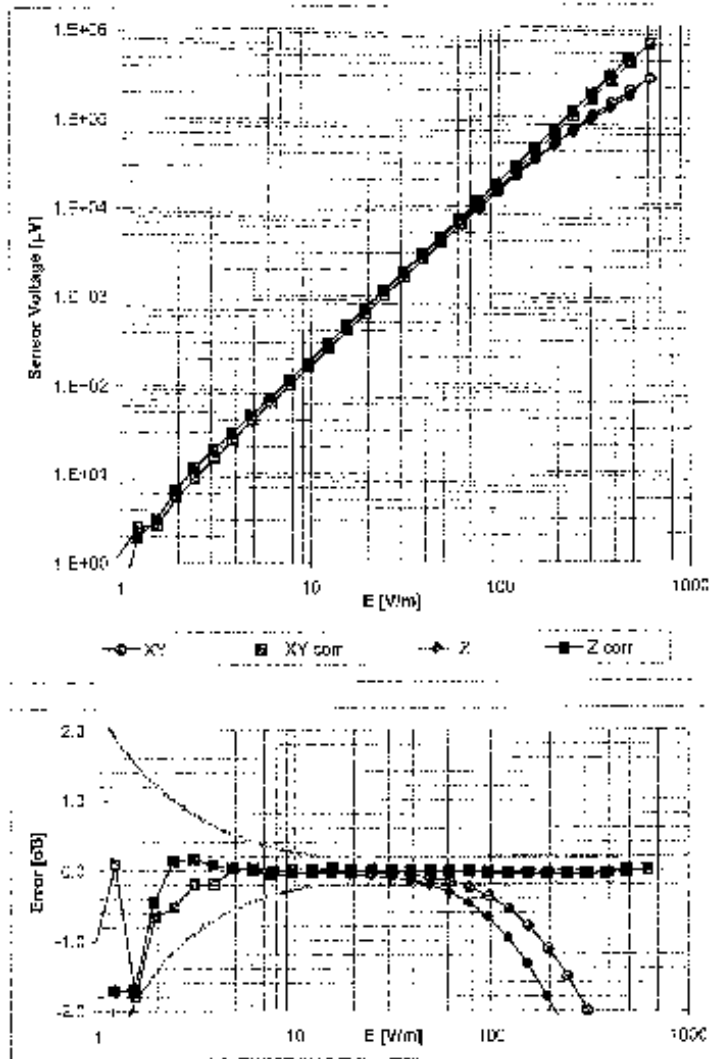
### Dynamic Range f(E-field) (Waveguide R22, f = 1800 MHz)



Uncertainty of Linearity Assessment:  $\pm 0.6\%$  (k=2)

FCC ID: BEJAX155	 PCTEST ENGINEERING LABORATORY, INC.	HAC (RF EMISSIONS) TEST REPORT	 LG	Reviewed by: Quality Manager
HAC Filename: 0804140485.BEJ	Test Dates: April 19 - 26, 2008	EUT Type: Cellular/PCS CDMA Phone		Page 43 of 70

### Deviation from Isotropy in Air Error ( $\phi, \theta$ ), $f = 900$ MHz

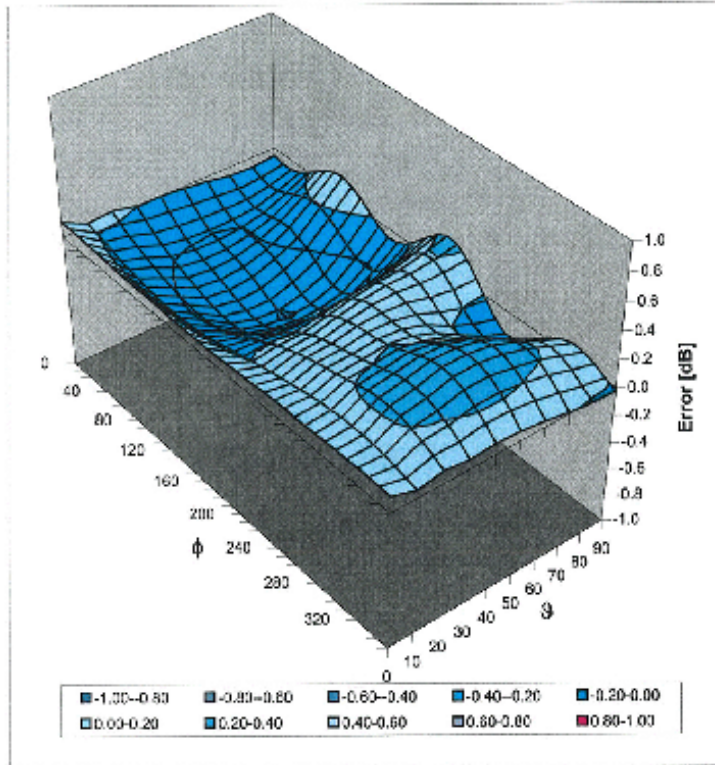

Uncertainty of Spherical Isotropy Assessment:  $\pm 2.6\%$  (k=2)

FCC ID: BEJAX155	PCTEST ENGINEERING LABORATORY, INC.	HAC (RF EMISSIONS) TEST REPORT	LG	Reviewed by: Quality Manager
HAC Filename: 0804140485.BEJ	Test Dates: April 19 - 26, 2008	EUT Type: Cellular/PCS CDMA Phone		Page 44 of 70



Accredited by the Swiss Accreditation Service (SAS)  
The Swiss Accreditation Service is one of the signatories to the EA  
Multilateral Agreement for the recognition of calibration certificates

Accreditation No.: **SCS 108**

Client **PC Test**

Certificate No: **H3-6170\_Nov07**

CALIBRATION CERTIFICATE			
Object	H3DV6 - SN:6170		
Calibration procedure(s)	QA CAL-03.v5 Calibration procedure for H-field probes optimized for close near field evaluations in air		
Calibration date:	November 20, 2007		
Condition of the calibrated item	In Tolerance		
This calibration certificate documents the traceability to national standards, which realize the physical units of measurements (SI). The measurements and the uncertainties with confidence probability are given on the following pages and are part of the certificate.			
All calibrations have been conducted in the closed laboratory facility: environment temperature (22 ± 3)°C and humidity < 70%.			
Calibration Equipment used (M&TE critical for calibration)			
Primary Standards	ID #	Cal Date (Calibrated by, Certificate No.)	Scheduled Calibration
Power meter E4419B	G341293874	29-Mar-07 (METAS, No. 217-00670)	Mar-08
Power sensor E4412A	MY41495277	29-Mar-07 (METAS, No. 217-00670)	Mar-08
Power sensor E4412A	MY41498087	29-Mar-07 (METAS, No. 217-00670)	Mar-08
Reference 3 dB Attenuator	SN: S5054 (3c)	8-Aug-07 (METAS, No. 217-00719)	Aug-08
Reference 20 dB Attenuator	SN: S5086 (20b)	29-Mar-07 (METAS, No. 217-00671)	Mar-08
Reference 30 dB Attenuator	SN: S5129 (30b)	8-Aug-07 (METAS, No. 217-00720)	Aug-08
Reference Probe H3DV6	SN: 6182	2-Oct-07 (SPEAG, No. H3-6182_Oct07)	Oct-08
DAE4	SN: 654	20-Apr-07 (SPEAG, No. DAE4-654_Apr07)	Apr-08
Secondary Standards	ID #	Check Date (in house)	Scheduled Check
RF generator HP 8645C	US3642U01700	4-Aug-09 (SPEAG, in house check Oct-07)	In house check: Oct-09
Network Analyzer HP 8753E	US37390585	16-Oct-01 (SPEAG, in house check Oct-07)	In house check: Oct-08
Calibrated by:	Name Katja Pokovic	Function Technical Manager	Signature 
Approved by:	Name Niola Kustor	Function Quality Manager	Signature 
			Issued: November 20, 2007
This calibration certificate shall not be reproduced except in full without written approval of the laboratory.			

Certificate No: H3-6170\_Nov07

Page 1 of 8

FCC ID: BEJAX155	PCTEST ENGINEERING LABORATORY, INC.	HAC (RF EMISSIONS) TEST REPORT	LG	Reviewed by: Quality Manager
HAC Filename: 0804140485.BEJ	Test Dates: April 19 - 26, 2008	EUT Type: Cellular/PCS CDMA Phone		Page 45 of 70

**Calibration Laboratory of  
Schmid & Partner  
Engineering AG**  
Zeughausstrasse 43, 8004 Zurich, Switzerland



**S** Schweizerischer Kalibrierdienst  
**S** Service suisse d'étalonnage  
**C** Servizio svizzero di taratura  
**S** Swiss Calibration Service

Accredited by the Swiss Accreditation Service (SAS)  
The Swiss Accreditation Service is one of the signatories to the EA  
Multilateral Agreement for the recognition of calibration certificates

Accreditation No.: **SCS 108**

**Glossary:**

**NORM<sub>x,y,z</sub>** sensitivity in free space  
**DCP** diode compression point  
**Polarization  $\varphi$**   $\varphi$  rotation around probe axis  
**Polarization  $\vartheta$**   $\vartheta$  rotation around an axis that is in the plane normal to probe axis (at measurement center), i.e.,  $\vartheta = 0$  is normal to probe axis  
**Connector Angle** information used in DASY system to align probe sensor X to the robot coordinate system

**Calibration is Performed According to the Following Standards:**

- a) IEEE Std 1309-2005, "IEEE Standard for calibration of electromagnetic field sensors and probes, excluding antennas, from 9 kHz to 40 GHz", December 2005.

**Methods Applied and Interpretation of Parameters:**

- **X,Y,Z<sub>a0a1a2</sub>**: Assessed for E-field polarization  $\vartheta = 90$  for XY sensors and  $\vartheta = 0$  for Z sensor ( $f \leq 900$  MHz in TEM-cell;  $f > 1800$  MHz: R22 waveguide).
- **X,Y,Z(f)<sub>a0a1a2</sub>** = **X,Y,Z<sub>a0a1a2</sub>** \* frequency\_response (see Frequency Response Chart).
- **DCP<sub>x,y,z</sub>**: DCP are numerical linearization parameters assessed based on the data of power sweep (no uncertainty required). DCP does not depend on frequency.
- **Spherical isotropy (3D deviation from isotropy)**: in a locally homogeneous field realized using an open waveguide setup.
- **Sensor Offset**: The sensor offset corresponds to the offset of virtual measurement center from the probe tip (on probe axis). No tolerance required.
- **Connector Angle**: The angle is assessed using the information gained by determining the **X<sub>a0a1a2</sub>** (no uncertainty required).

FCC ID: BEJAX155	<b>PCTEST</b> ENGINEERING LABORATORY, INC.	<b>HAC (RF EMISSIONS) TEST REPORT</b>	<b>LG</b>	<b>Reviewed by:</b> Quality Manager
<b>HAC Filename:</b> 0804140485.BEJ	<b>Test Dates:</b> April 19 - 26, 2008	<b>EUT Type:</b> Cellular/PCS CDMA Phone	Page 46 of 70	



# Probe H3DV6

## SN:6170

Manufactured: May 19, 2005  
Last calibrated: October 13, 2006  
Recalibrated: November 20, 2007

Calibrated for DASY Systems

(Note: non-compatible with DASY2 system!)

FCC ID: BEJAX155	 <b>PCTEST</b> ENGINEERING LABORATORY, INC.	HAC (RF EMISSIONS) TEST REPORT	 <b>LG</b> Reviewed by: Quality Manager
HAC Filename: 0804140485.BEJ	Test Dates: April 19 - 26, 2008	EUT Type: Cellular/PCS CDMA Phone	Page 47 of 70

**DASY - Parameters of Probe: H3DV6 SN:6170**

Sensitivity in Free Space [A/m /  $\sqrt{\mu V}$ ]

	a0	a1	a2
X	2.494E-03	1.205E-4	1.608E-6 ± 5.1 % (k=2)
Y	2.631E-03	5.696E-6	-2.557E-5 ± 5.1 % (k=2)
Z	2.954E-03	-6.796E-5	2.893E-5 ± 5.1 % (k=2)

Diode Compression<sup>1</sup>

DGP X	85 mV
DGP Y	85 mV
DGP Z	86 mV



Sensor Offset (Probe Tip to Sensor Center)

X	3.0 mm
Y	3.0 mm
Z	3.0 mm

Connector Angle -358 °

The reported uncertainty of measurement is stated as the standard uncertainty of measurement multiplied by the coverage factor k=2, which for a normal distribution corresponds to a coverage probability of approximately 95%.

<sup>1</sup> numerical linearization parameter uncertainty not required

FCC ID: BEJAX155	 <b>PCTEST</b> ENGINEERING LABORATORY, INC.	HAC (RF EMISSIONS) TEST REPORT	 <b>LG</b>	Reviewed by: Quality Manager
HAC Filename: 0804140485.BEJ	Test Dates: April 19 - 26, 2008	EUT Type: Cellular/PCS CDMA Phone	Page 48 of 70	

### Frequency Response of H-Field (TEM-Cell:ifi110, Waveguide R22)

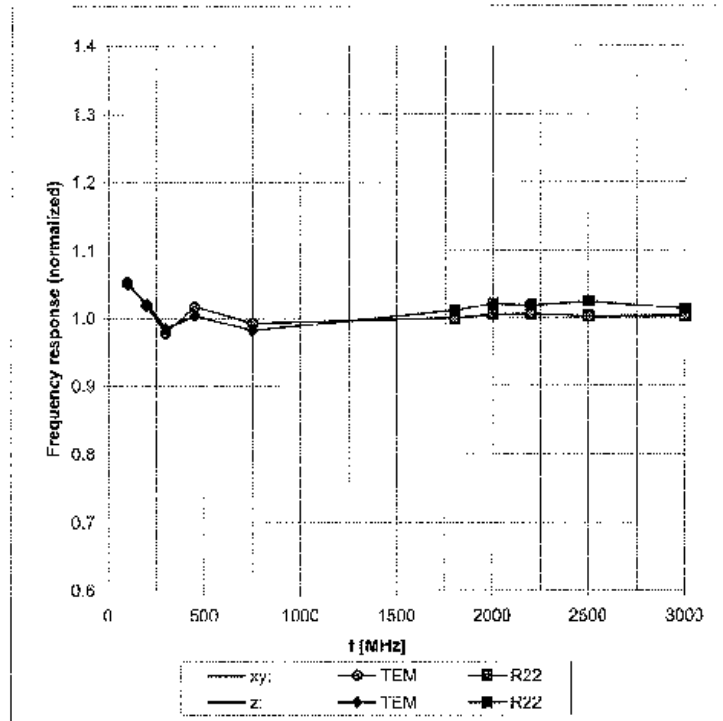

Uncertainty of Frequency Response of E-field:  $\pm 6.3\%$  ( $k=2$ )

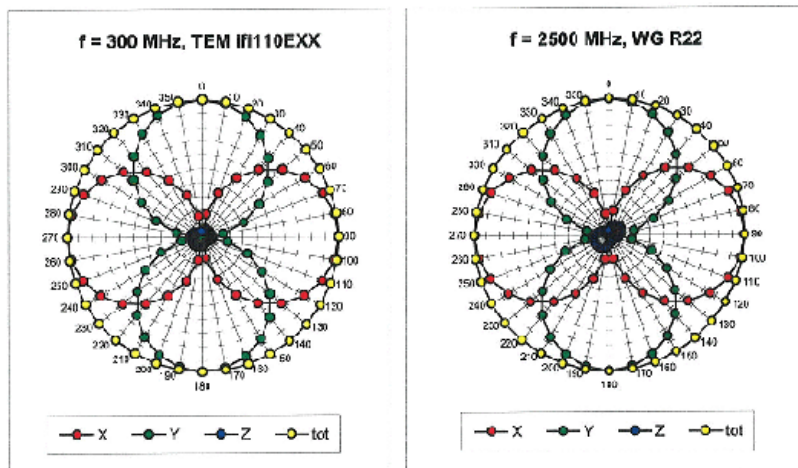

FCC ID: BEJAX155	PCTEST ENGINEERING LABORATORY, INC.	HAC (RF EMISSIONS) TEST REPORT	LG	Reviewed by: Quality Manager
HAC Filename: 0804140485.BEJ	Test Dates: April 19 - 26, 2008	EUT Type: Cellular/PCS CDMA Phone	Page 49 of 70	

Receiving Pattern ( $\phi$ ),  $\theta = 90^\circ$

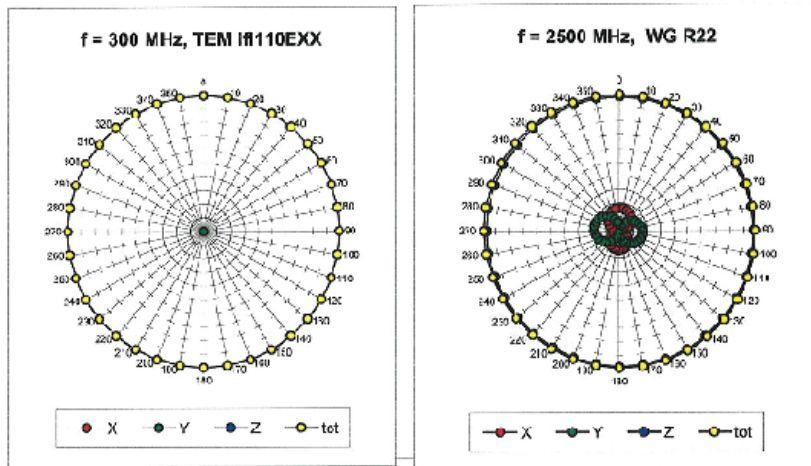

Receiving Pattern ( $\phi$ ),  $\theta = 0^\circ$



<p>FCC ID: BEJAX155</p>		<p>HAC (RF EMISSIONS) TEST REPORT</p>	 <p>Reviewed by: Quality Manager</p>
<p>HAC Filename: 0804140485.BEJ</p>	<p>Test Dates: April 19 - 26, 2008</p>	<p>EUT Type: Cellular/PCS CDMA Phone</p>	<p>Page 50 of 70</p>

### Receiving Pattern ( $\phi$ ), $\vartheta = 90^\circ$

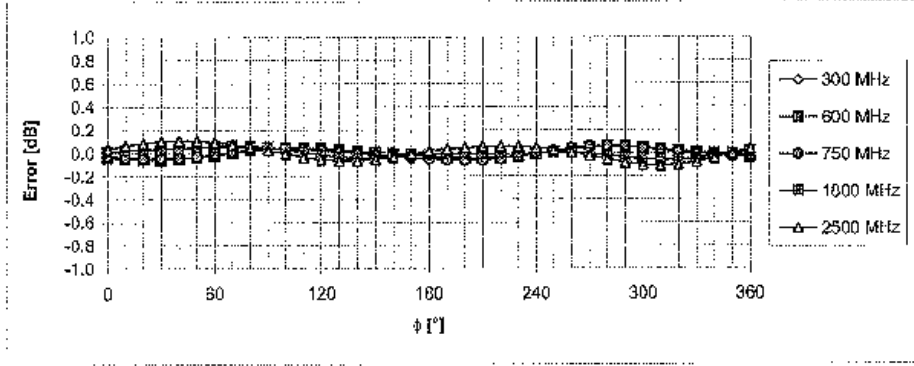

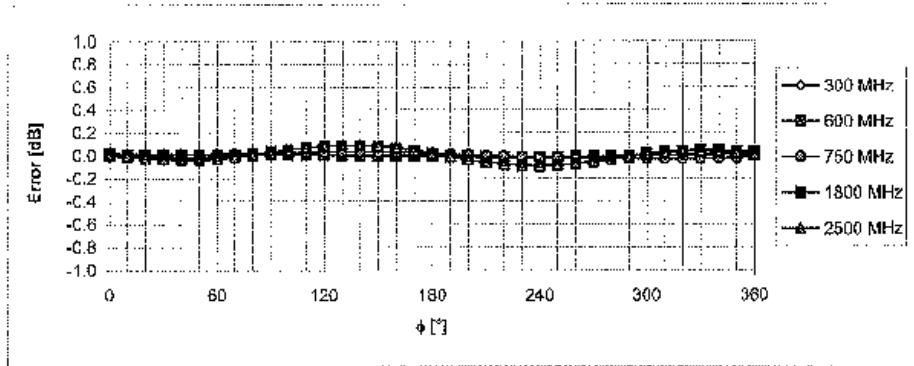

Uncertainty of Axial Isotropy Assessment:  $\pm 0.5\%$  (k=2)

### Receiving Pattern ( $\phi$ ), $\vartheta = 0^\circ$





Uncertainty of Axial Isotropy Assessment:  $\pm 0.5\%$  (k=2)

FCC ID: BEJAX155		HAC (RF EMISSIONS) TEST REPORT		Reviewed by: Quality Manager
HAC Filename: 0804140485.BEJ	Test Dates: April 19 - 26, 2008	EUT Type: Cellular/PCS CDMA Phone		Page 51 of 70

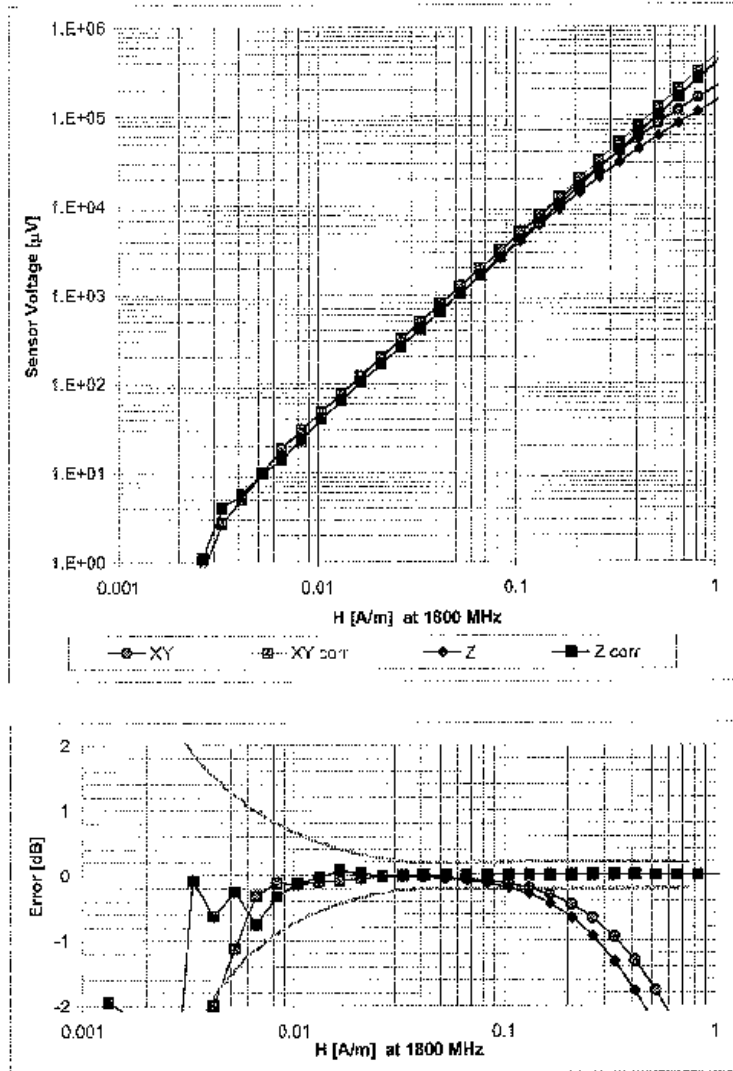
### Dynamic Range f(H-field) (Waveguide R22, f = 1800 MHz)



Uncertainty of Linearity Assessment:  $\pm 0.6\%$  (k=2)

FCC ID: BEJAX155	 PCTEST ENGINEERING LABORATORY, INC.	HAC (RF EMISSIONS) TEST REPORT	 LG	Reviewed by: Quality Manager
HAC Filename: 0804140485.BEJ	Test Dates: April 19 - 26, 2008	EUT Type: Cellular/PCS CDMA Phone		Page 52 of 70



Accredited by the Swiss Federal Office of Metrology and Accreditation  
The Swiss Accreditation Service is one of the signatories to the EA  
Multilateral Agreement for the recognition of calibration certificates

Accreditation No.: **SCS 108**

Client **PC Test**

Certificate No: **CD835V3-1082\_Jul06**

## CALIBRATION CERTIFICATE

Object **CD835V3 - SN: 1082**

Calibration procedure(s) **QA CAL-20.v4  
Calibration procedure for dipoles in air**

Calibration date: **July 17, 2006**

Condition of the calibrated item **In Tolerance**

This calibration certificate documents the traceability to national standards, which realize the physical units of measurements (SI).  
All calibrations have been conducted in the closed laboratory facility: environment temperature (22 ± 3)°C and humidity < 70%.

Calibration Equipment used (M&I: critical for calibration)

Primary Standards	ID #	Cal Date (Calibrated by, Certificate No.)	Scheduled Calibration
Power meter EPM-442A	GB37480704	04-Oct-05 (METAS, No. 251-00516)	Oct-06
Power sensor HP 8481A	US37292783	04-Oct-05 (METAS, No. 251-00516)	Oct-06
Reference 20 dB Attenuator	SN: 5086 (20g)	11-Aug-05 (METAS, No 251-00488)	Aug-05
Reference 10 dB Attenuator	SN: 5047 2 (10r)	11-Aug-05 (METAS, No 251-00488)	Aug-05
DAE4	SN: 660	1-Mar-06 (SPEAG, No. DAE4-660_Mar06)	Calibration, Mar-07
Probe ER3DV6	SN: 2336	20-Dec-05 (SPEAG, No. ER3-2336_Dec05)	Calibration, Dec-06
Probe H3DV6	SN: 6065	20-Dec-05 (SPEAG, No. H3-6065-Dec05)	Calibration, Dec-06
Secondary Standards	ID #	Check Date (in house)	Scheduled Check
Power meter EPM-4413B	GB43310786	12-Aug-03 (SPEAG, in house check Oct-05)	In house check: Oct-06
Power sensor HP 8481A	MY41093312	10-Aug-03 (SPEAG, in house check Oct-05)	In house check: Oct-07
Power sensor HP 8481A	MY41093315	10-Aug-03 (SPEAG, in house check Oct-05)	In house check: Oct-06
Network Analyzer HP 6753E	US37390585	18-Oct-01 (SPEAG, in house check Nov-05)	In house check: Nov-06
RF generator R&S SMT06	SN: 100005	28-Jul-04 (SPEAG, in house check Nov-05)	In house check: Nov-07

Calibrated by:	Name <b>Mike Meil</b>	Function Laboratory Technician	Signature <i>M. Meil</i>
Approved by:	Name <b>Fin Bernholt</b>	Function Technical Director	Signature <i>F. Bernholt</i>

Issued: July 16, 2006

This calibration certificate shall not be reproduced except in full without written approval of the laboratory.

Certificate No: CD835V3-1082\_Jul06

Page 1 of 6

FCC ID: BEJAX155	PCTEST ENGINEERING LABORATORY, INC.	HAC (RF EMISSIONS) TEST REPORT	LG	Reviewed by: Quality Manager
HAC Filename: 0804140485.BEJ	Test Dates: April 19 - 26, 2008	EUT Type: Cellular/PCS CDMA Phone		Page 53 of 70



Accredited by the Swiss Federal Office of Metrology and Accreditation  
The Swiss Accreditation Service is one of the signatories to the EA  
Multilateral Agreement for the recognition of calibration certificates

Accreditation No.: SCS 108

#### References

- [1] ANSI-PCB3.19-2001 (Draft 3.x, 2006)  
American National Standard for Methods of Measurement of Compatibility between Wireless Communications Devices and Hearing Aids.

#### Methods Applied and Interpretation of Parameters:

- **Coordinate System:** y-axis is in the direction of the dipole arms. z-axis is from the basis of the antenna (mounted on the table) towards its feed point between the two dipole arms. x-axis is normal to the other axes. In coincidence with standard [1], the measurement planes (probe sensor center) are selected to be at a distance of 10 mm above the top edge of the dipole arms.
- **Measurement Conditions:** Further details are available from the hardcopies at the end of the certificate. All figures stated in the certificate are valid at the frequency indicated. The forward power to the dipole connector is set with a calibrated power meter connected and monitored with an auxiliary power meter connected to a directional coupler. While the dipole under test is connected, the forward power is adjusted to the same level.
- **Antenna Positioning:** The dipole is mounted on a HAC Test Arch phantom using the matching dipole positioner with the arms horizontal and the feeding cable coming from the floor. The measurements are performed in a shielded room with absorbers around the setup to reduce the reflections. It is verified before the mounting of the dipole under the Test Arch phantom, that its arms are perfectly in a line. It is installed on the HAC dipole positioner with its arms parallel below the dielectric reference wire and able to move electrically in vertical direction without changing its relative position to the top center of the Test Arch phantom. The vertical distance to the probe is adjusted after dipole mounting with a DASY4 Surface Check job. Before the measurement, the distance between phantom surface and probe tip is verified. The proper measurement distance is selected by choosing the matching section of the HAC Test Arch phantom with the proper device reference point (upper surface of the dipole) and the matching grid reference point (tip of the probe) considering the probe sensor offset. The vertical distance to the probe is essential for the accuracy.
- **Feed Point Impedance and Return Loss:** These parameters are measured using a HP 8753E Vector Network Analyzer. The impedance is specified at the SMA connector of the dipole. The influence of reflections was eliminated by applying the averaging function while moving the dipole in the air, at least 70cm away from any obstacles.
- **E-field distribution:** E-field is measured in the x-y-plane with an isotropic ER3D-field probe with 100 mW forward power to the antenna feed point. In accordance with [1], the scan area is 20mm wide, its length exceeds the dipole arm length (180 or 80mm). The sensor center is 10 mm (in z) above the top of the dipole arms. Two 3D maxima are available near the end of the dipole arms. Assuming the dipole arms are perfectly in one line, the average of these two maxima (at subgrid 2 and subgrid 8) is determined to compensate for any non-parallelity to the measurement plane as well as the sensor displacement. The E-field value stated as calibration value represents the maximum of the interpolated 3D-E-field, 10mm above the dipole surface.
- **H-field distribution:** H-field is measured with an isotropic H-field probe with 100mW forward power to the antenna feed point, in the x-y-plane. The scan area and sensor distance is equivalent to the E-field scan. The maximum of the field is available at the center (subgrid 5) above the feed point. The H-field value stated as calibration value represents the maximum of the interpolated H-field, 10mm above the dipole surface at the feed point.

FCC ID: BEJAX155	PCTEST ENGINEERING LABORATORY, INC.	HAC (RF EMISSIONS) TEST REPORT	LG	Reviewed by: Quality Manager
HAC Filename: 0804140485.BEJ	Test Dates: April 19 - 26, 2008	EUT Type: Cellular/PCS CDMA Phone		Page 54 of 70

## 1 Measurement Conditions

DASY system configuration, as far as not given on page 1.

DASY Version	DASY4	V4.7 B44
DASY PP Version	SEMCAD	V1.8 B171
Phantom	HAC Test Arch	SD HAC P01 BA, #1002
Distance Dipole Top - Probe Center	10 mm	
Scan resolution	dx, dy = 5 mm	area = 20 x 180 mm
Frequency	835 MHz $\pm$ 1 MHz	
Forward power at dipole connector	20.0 dBm = 100mW	
Input power drift	< 0.05 dB	

## 2 Maximum Field values

H-field 10 mm above dipole surface	condition	Interpolated maximum
Maximum measured	100 mW forward power	0.454 A/m

Uncertainty for H-field measurement: 8.2% (k=2)

E-field 10 mm above dipole surface	condition	Interpolated maximum
Maximum measured above high end	100 mW forward power	172.9 V/m
Maximum measured above low end	100 mW forward power	162.3 V/m
Averaged maximum above arm	100 mW forward power	167.3 V/m

Uncertainty for E-field measurement: 12.9% (k=2)

## 3 Appendix

### 3.1 Antenna Parameters

Frequency	Return Loss	Impedance
800 MHz	18.7 dB	( 43.5 - j12.2 ) Ohm
835 MHz	27.6 dB	( 51.3 + j4.0 ) Ohm
900 MHz	16.1 dB	( 57.4 - j15.4 ) Ohm
950 MHz	21.1 dB	( 44.3 + j6.0 ) Ohm
980 MHz	18.0 dB	( 48.0 - j12.6 ) Ohm



### 3.2 Antenna Design and Handling

The calibration dipole has a symmetric geometry with a built-in two stub matching network, which leads to the enhanced bandwidth.

The dipole is built of standard semirigid coaxial cable. The internal matching line is open ended. The antenna is therefore open for DC signals.

Do not apply force to dipole arms, as they are liable to bend. The soldered connections near the feedpoint may be damaged. After excessive mechanical stress or overheating, check the impedance characteristics to ensure that the internal matching network is not affected.



After long term use with 40W radiated power, only a slight warming of the dipole near the feedpoint can be measured.

FCC ID: BEJAX155	 PCTEST ENGINEERING LABORATORY, INC.	HAC (RF EMISSIONS) TEST REPORT	 LG	Reviewed by: Quality Manager
HAC Filename: 0804140485.BEJ	Test Dates: April 19 - 26, 2008	EUT Type: Cellular/PCS CDMA Phone		Page 55 of 70

### 3.3 Measurement Sheets

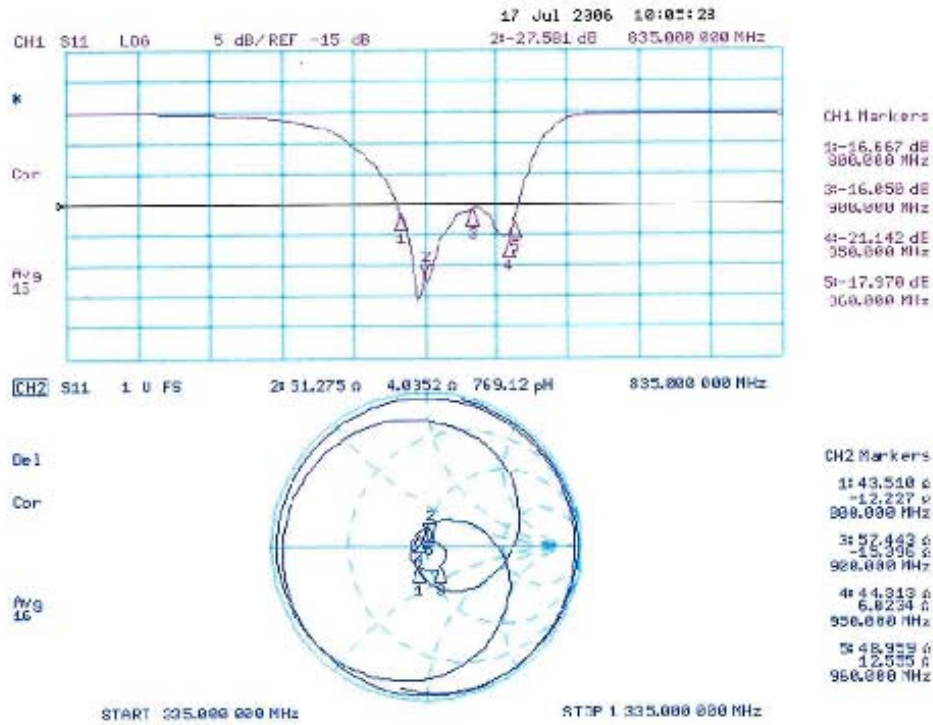
#### 3.3.1 Return Loss and Smith Chart



FCC ID: BEJAX155	 PCTEST ENGINEERING LABORATORY, INC.	HAC (RF EMISSIONS) TEST REPORT	 LG	Reviewed by: Quality Manager
HAC Filename: 0804140485.BEJ	Test Dates: April 19 - 26, 2008	EUT Type: Cellular/PCS CDMA Phone		Page 56 of 70

**3.3.2 DASY4 H-field result**

Date/Time: 7/17/2006 2:56:42 PM

Test Laboratory: SPEAG, Zurich, Switzerland  
 File Name: [H\\_CD835\\_1082\\_060717.dad](#)

**DUT: HAC-Dipole 835 MHz; Typc: D835V3; Serial: 1082**  
**Program Name: HAC H Dipole**

Communication System: CW; Frequency: 835 MHz; Duty Cycle: 1:1  
 Medium: Air Medium parameters used:  $\sigma = 0$  mho/m,  $\epsilon_r = 1$ ;  $\rho = 1$  kg/m<sup>3</sup>  
 Phantom section: H Dipole Section

DASY4 Configuration:  
 - Probe: H3DV6 - SN6065; ; Calibrated: 12/20/2005  
 - Sensor-Surface: (Fix Surface)  
 - Electronics: DAE4 Sn660; Calibrated: 3/1/2006  
 - Phantom: HAC Test Arch 4.6; Type: SD HAC P01 BA; Serial: 1002  
 - Measurement SW: DASY4, V4.7 Build 44; Postprocessing SW: SEMCAD, V1.8 Build 171

**H Scan - Sensor Center 10mm above CD835 Dipole/Hearing Aid Compatibility Test (41x361x1): Measurement grid:**  
 dx=5mm, dy=5mm  
 Maximum value of peak Total field = 0.454 A/m  
 Probe Modulation Factor = 1.00  
 Reference Value = 0.487 A/m; Power Drift = -0.014 dB  
**Hearing Aid Near-Field Category: M2 (AWF 0 dB)**

Peak H field in A/m

Grid 1	Grid 2	Grid 3
0.372	0.402	0.386
Grid 4	Grid 5	Grid 6
0.425	0.454	0.438
Grid 7	Grid 8	Grid 9
0.379	0.404	0.388

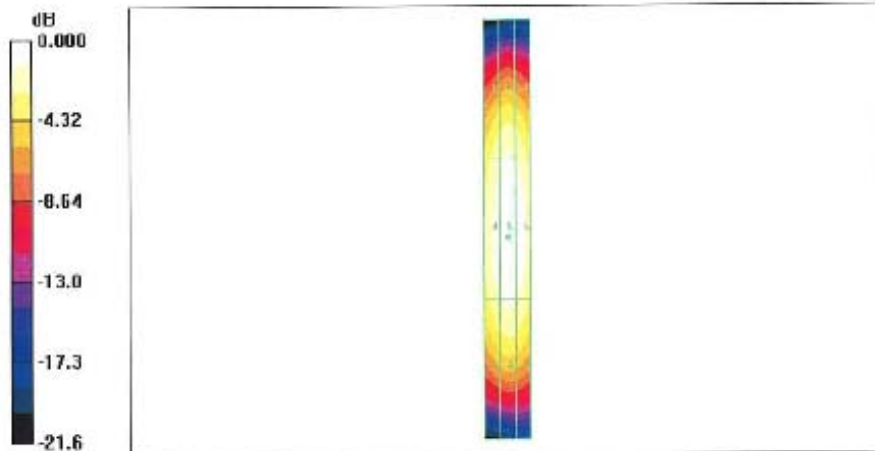

0 dB = 0.454 A/m

FCC ID: BEJAX155	PCTEST ENGINEERING LABORATORY, INC.	HAC (RF EMISSIONS) TEST REPORT	LG	Reviewed by: Quality Manager
HAC Filename: 0804140485.BEJ	Test Dates: April 19 - 26, 2008	EUT Type: Cellular/PCS CDMA Phone	Page 57 of 70	

**3.3.3 DASY4 E-Field result**

Date/Time: 7/17/2006 11:50:47 AM

Test Laboratory: SPEAG, Zurich, Switzerland  
 File Name: [E\\_CD835\\_1082\\_060717.da4](#)

**DUT: HAC-Dipole 835 MHz; Type: D835V3; Serial: 1082**  
**Program Name: HAC E Dipole**

Communication System: CW; Frequency: 835 MHz; Duty Cycle: 1:1  
 Medium: Air Medium parameters used:  $\sigma = 0$  mho/m,  $\epsilon_r = 1$ ;  $\rho = 1000$  kg/m<sup>3</sup>  
 Phantom section: E Dipole Section

DASY4 Configuration:  
 - Probe: ER3DV6 - SN2336; ConvF(1, 1, 1); Calibrated: 12/20/2005  
 - Sensor-Surface: Fix Surface  
 - Electronics: DAE4 Sn660; Calibrated: 3/1/2006  
 - Phantom: HAC Test Arch 4.6; Type: SD HAC P01 BA; Serial: 1002  
 - Measurement SW: DASY4, V4.7 Build 44; Postprocessing SW: SEMCAD, V1.8 Build 171

**R Scan - Sensor Center 10mm above CD835 Dipole/Hearing Aid Compatibility Test (41x361x1): Measurement grid:**  
 dx=5mm, dy=5mm  
 Maximum value of peak Total field = 172.3 V/m  
 Probe Modulation Factor = 1.00  
 Reference Value = 122.7 V/m; Power Drift = -0.030 dB  
**Hearing Aid Near-Field Category: M2 (AWF 0 dB)**

Peak E-field in V/m

Grid 1	Grid 2	Grid 3
166.8	172.3	165.8
Grid 4	Grid 5	Grid 6
84.7	88.9	87.9
Grid 7	Grid 8	Grid 9
154.6	162.3	160.4

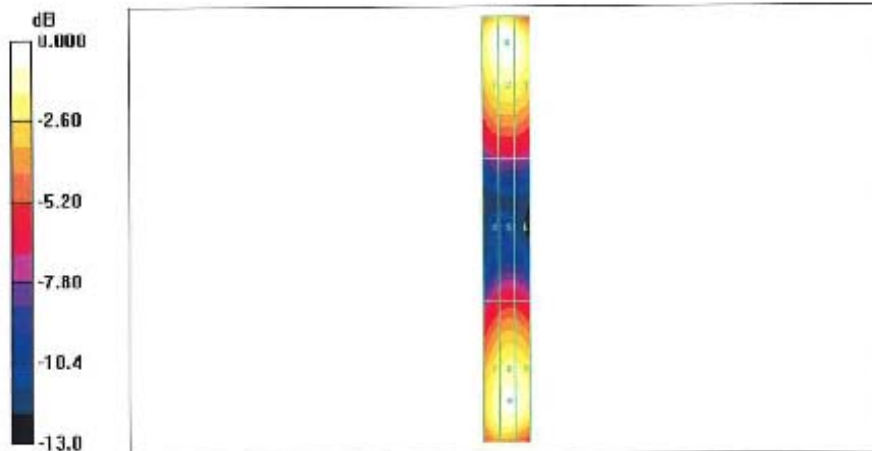

0 dB = 172.3 V/m

FCC ID: BEJAX155	PCTEST ENGINEERING LABORATORY, INC.	HAC (RF EMISSIONS) TEST REPORT	LG	Reviewed by: Quality Manager
HAC Filename: 0804140485.BEJ	Test Dates: April 19 - 26, 2008	EUT Type: Cellular/PCS CDMA Phone		Page 58 of 70



Accredited by the Swiss Federal Office of Metrology and Accreditation  
The Swiss Accreditation Service is one of the signatories to the EA  
Multilateral Agreement for the recognition of calibration certificates

Accreditation No.: SCS 108

Client PC Test

Certificate No: CD1880V3-1064\_Jul06

CALIBRATION CERTIFICATE			
Object	CD1880V3 - SN: 1064		
Calibration procedure(s)	QA CAL-20.v4 Calibration procedure for dipoles in air		
Calibration date:	July 18, 2006		
Condition of the calibrated item	In Tolerance		
This calibration certificate documents the traceability to national standards, which realize the physical units of measurements (SI). All calibrations have been conducted in the closed laboratory facility; environment temperature (22 ± 3)°C and humidity < 70%.			
Calibration Equipment used (M&TE critical for calibration)			
Primary Standards	ID #	Cal Date (Calibrated by, Certificate No.)	Scheduled Calibration
Power meter EPM-442A	GB37460704	04-Oct-05 (METAS, No. 251-00516)	Oct-06
Power sensor HP 8481A	UG37292783	04-Oct-05 (METAS, No. 251-00516)	Oct-06
Reference 20 dB Attenuator	SN: 5086 (20g)	11-Aug-05 (METAS, No 251-00496)	Aug-06
Reference 10 dB Attenuator	SN: 5047.2 (10g)	11-Aug-05 (METAS, No 251-00496)	Aug-06
DAE4	SN: 600	1-Mar-06 (SPEAG, No. DAC1-630_Mar06)	Calibration, Mar-07
Probe ER3DV6	SN: 2336	23-Dec-05 (SPEAG, No. CR3-2336_Dec05)	Calibration, Dec-06
Probe H3DV6	SN: 6065	23-Dec-05 (SPEAG, No. H3-6065-Dec05)	Calibration, Dec-06
Secondary Standards	ID #	Check Date (in house)	Scheduled Check
Power meter EPM-4419B	GB43310788	12-Aug-03 (SPEAG, in house check Oct-05)	In house check: Oct-06
Power sensor HP 8481A	M*41093312	10-Aug-03 (SPEAG, in house check Oct-05)	In house check: Oct-07
Power sensor HP 8481A	M*41093315	10-Aug-03 (SPEAG, in house check Oct-05)	In house check: Oct-06
Network Analyzer HP 6753E	US37390585	13-Oct-01 (SPEAG, in house check Nov-05)	In house check: Nov-06
RF generator R&S SMT08	SN: 100036	23-Jul-04 (SPEAG, in house check Nov-05)	In house check: Nov-07
Calibrated by:	Name Mike Meili	Function Laboratory Technician	Signature <i>M. Meili</i>
Approved by:	Name Fir Bernholt	Function Technical Director	Signature <i>F. Bernholt</i>
			Issued: July 20, 2006
This calibration certificate shall not be reproduced except in full without written approval of the laboratory.			

Certificate No: CD1880V3-1064\_Jul06

Page 1 of 6

FCC ID: BEJAX155	PCTEST ENGINEERING LABORATORY, INC.	HAC (RF EMISSIONS) TEST REPORT	LG	Reviewed by: Quality Manager
HAC Filename: 0804140485.BEJ	Test Dates: April 19 - 26, 2008	EUT Type: Cellular/PCS CDMA Phone		Page 59 of 70



Accredited by the Swiss Federal Office of Metrology and Accreditation  
The Swiss Accreditation Service is one of the signatories to the EA  
Multilateral Agreement for the recognition of calibration certificates

Accreditation No.: **SCS 108**

**References**

- [1] ANSI-PC83.19-2001 (Draft 3.x, 2005)  
American National Standard for Methods of Measurement of Compatibility between Wireless  
Communications Devices and Hearing Aids.

**Methods Applied and Interpretation of Parameters:**

- **Coordinate System:** y-axis is in the direction of the dipole arms, z-axis is from the base of the antenna (mounted on the table) towards its feed point between the two dipole arms. x-axis is normal to the other axes. In accordance with standard [1], the measurement planes (probe sensor center) are selected to be at a distance of 10 mm above the top edge of the dipole arms.
- **Measurement Conditions:** Further details are available from the hardcopies at the end of the certificate. All figures stated in the certificate are valid at the frequency indicated. The forward power to the dipole connector is set with a calibrated power meter connected and monitored with an auxiliary power meter connected to a directional coupler. While the dipole under test is connected, the forward power is adjusted to the same level.
- **Antenna Positioning:** The dipole is mounted on a HAC Test Arch phantom using the matching dipole positioner with the arms horizontal and the feeding cable coming from the front. The measurements are performed in a shielded room with absorbers around the setup to reduce the reflections. It is verified before the mounting of the dipole under the Test Arch phantom, that its arms are perfectly in a line. It is installed on the HAC dipole positioner with its arms parallel below the dielectric reference wire and able to move elastically in vertical direction without changing its relative position to the top center of the Test Arch phantom. The vertical distance to the probe is adjusted after dipole mounting with a DASY4 Surface Check job. Before the measurement, the distance between phantom surface and probe tip is verified. The proper measurement distance is selected by choosing the matching section of the HAC Test Arch phantom with the proper device reference point (upper surface of the dipole) and the matching grid reference point (top of the probe) considering the probe sensor offset. The vertical distance to the probe is essential for the accuracy.
- **Feed Point Impedance and Return Loss:** These parameters are measured using a HP 8753E Vector Network Analyzer. The impedance is specified at the SMA connector of the dipole. The influence of reflections was eliminated by applying the averaging function while moving the dipole in the air, at least 70cm away from any obstacles.
- **E-field distribution:** E-field is measured in the x-y-plane with an isotropic ER3D-field probe with 100 mW forward power to the antenna feed point. In accordance with [1], the scan area is 20mm wide, its length exceeds the dipole arm length (130 or 90 mm). The sensor center is 10 mm (d.z) above the top of the dipole arms. Two 3D maxima are available near the end of the dipole arms. Assuming the dipole arms are perfectly in one line, the average of those two maxima (in subgrid 7 and subgrid 8) is determined to compensate for any non-parallelity in the measurement plane as well as the sensor displacement. The E-field value stated as calibration value represents the maximum of the interpolated 3D-E-field, 10mm above the dipole surface.
- **H-field distribution:** H-field is measured with an isotropic H-field probe with 100mW forward power to the antenna feed point, in the x-y-plane. The scan area and sensor distance is equivalent to the E-field scan. The maximum of the field is available at the center (subgrid 5) above the feed point. The H-field value stated as calibration value represents the maximum of the interpolated H-field, 10mm above the dipole surface at the feed point.

FCC ID: BEJAX155	PCTEST ENGINEERING LABORATORY, INC.	HAC (RF EMISSIONS) TEST REPORT	LG	Reviewed by: Quality Manager
HAC Filename: 0804140485.BEJ	Test Dates: April 19 - 26, 2008	EUT Type: Cellular/PCS CDMA Phone		Page 60 of 70

### 1 Measurement Conditions

DASY system configuration, as far as not given on page 1.

DASY Version	DASY2	V2.7B44
DASY PP Version	SEMCAD	V1.8 B171
Phantom	HAC Test Arch	SD HAC P01 BA, #1002
Distance Dipole Top - Probe Center	10 mm	
Scan resolution	dx, dy = 5 mm	area = 20 x 50 mm
Frequency	1880 MHz ± 1 MHz	
Forward power at dipole connector	20.0 dBm = 100mW	
Input power drift	< 0.05 dB	

### 2 Maximum Field values

H-field 10 mm above dipole surface	condition	interpolated maximum
Maximum measured	100 mW forward power	0.451 A/m

Uncertainty for H-field measurement: 8.2% (k=2)

E-field 10 mm above dipole surface	condition	interpolated maximum
Maximum measured above high end	100 mW forward power	137.9 V/m
Maximum measured above low end	100 mW forward power	131.3 V/m
Averaged maximum above arr	100 mW forward power	134.6 V/m

Uncertainty for E-field measurement: 12.8% (k=2)

### 3 Appendix

#### 3.1 Antenna Parameters

Frequency	Return Loss	Impedance
1710 MHz	20.4 dB	( 49.1 + j8.5 ) Ohm
<b>1880 MHz</b>	<b>22.1 dB</b>	<b>( 50.7 + j7.9 ) Ohm</b>
1900 MHz	22.5 dB	( 52.8 + j7.2 ) Ohm
1850 MHz	30.6 dB	( 53.0 - j0.3 ) Ohm
2000 MHz	23.8 dB	( 41.8 + j1.7 ) Ohm



#### 3.2 Antenna Design and Handling

The calibration dipole has a symmetric geometry with a built-in two stub matching network, which leads to the enhanced bandwidth.

The dipole is built of standard semi-rigid coaxial cable. The internal matching line is open ended. The antenna is therefore open for DC signals.

Do not apply force to dipole arms, as they are liable to bend. The soldered connections near the feedpoint may be damaged. After excessive mechanical stress or overheating, check the impedance characteristics to ensure that the internal matching network is not affected.

After long term use with 40W radiated power, only a slight warming of the dipole near the feedpoint can be measured.

FCC ID: BEJAX155	 PCTEST ENGINEERING LABORATORY, INC.	HAC (RF EMISSIONS) TEST REPORT	 LG	Reviewed by: Quality Manager
HAC Filename: 0804140485.BEJ	Test Dates: April 19 - 26, 2008	EUT Type: Cellular/PCS CDMA Phone	Page 61 of 70	

### 3.3 Measurement Sheets

#### 3.3.1 Return Loss and Smith Chart

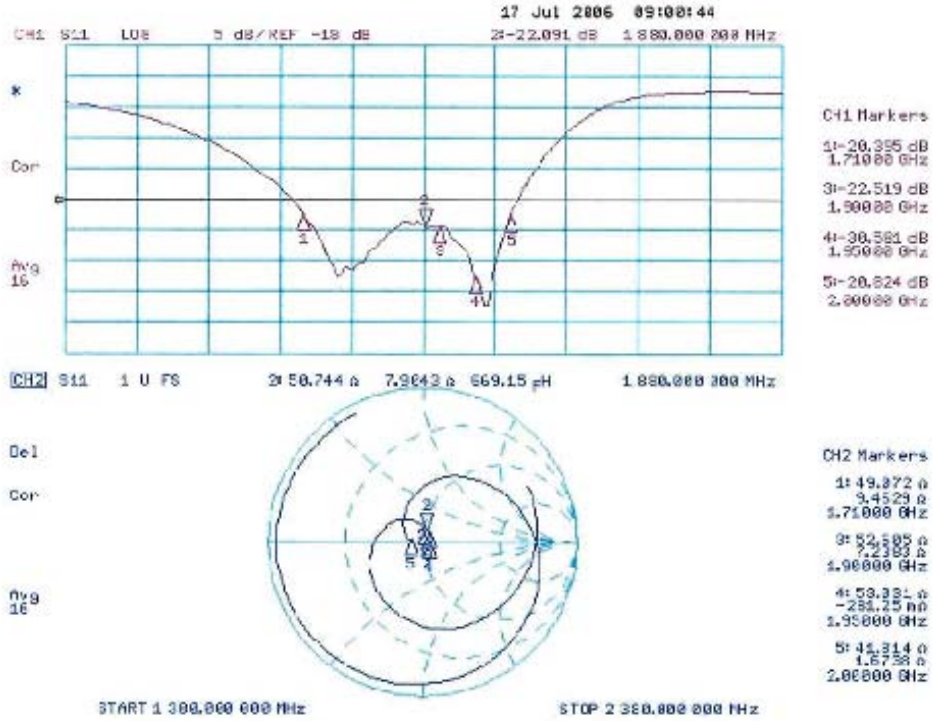

FCC ID: BEJAX155	PCTEST ENGINEERING LABORATORY, INC.	HAC (RF EMISSIONS) TEST REPORT	LG	Reviewed by: Quality Manager
HAC Filename: 0804140485.BEJ	Test Dates: April 19 - 26, 2008	EUT Type: Cellular/PCS CDMA Phone		Page 62 of 70

**3.3.2 DASY4 H-field result**

Date/Time: 7/18/2006 10:16:29 AM

Test Laboratory: SPEAG, Zurich, Switzerland

**DUT: HAC Dipole 1880 MHz; Type: CD1880V3; Serial: 1064**

Communication System: CW; Frequency: 1880 MHz; Duty Cycle: 1:1

Medium: Air

Medium parameters used:  $\sigma = 0$  mho/m,  $\epsilon_r = 1$ ;  $\rho = 1$  kg/m<sup>3</sup>

Phantom section: II Dipole Section

DASY4 Configuration:

- Probe: H3DV6 - SN6065; Calibrated: 12/20/2005
- Sensor-Surface: (Fix Surface)
- Electronics: DAE4 Sn660; Calibrated: 3/1/2006
- Phantom: HAC Test Arch 4.6; Type: SD HAC P01 BA; Serial: 1002
- Measurement SW: DASY4, V4.7 Build 44; Postprocessing SW: SEMCAD, V1.8 Build 171

**H Scan - Sensor Center 10mm above CD1880V3 Dipole/Hearing Aid Compatibility Test (41x181x1):**

Measurement grid: dx=5mm, cy=5mm

Maximum value of peak Total field = 0.451 A/m

Probe Modulation Factor = 1.00

Reference Value = 0.476 A/m; Power Drift: -0.002 dB

Hearing Aid Near-Field Category: **M2 (AWF 0 dB)**

Peak H-field in A/m

Grid 1	Grid 2	Grid 3
0.389	0.417	0.402
Grid 4	Grid 5	Grid 6
0.425	0.451	0.437
Grid 7	Grid 8	Grid 9
0.387	0.412	0.398

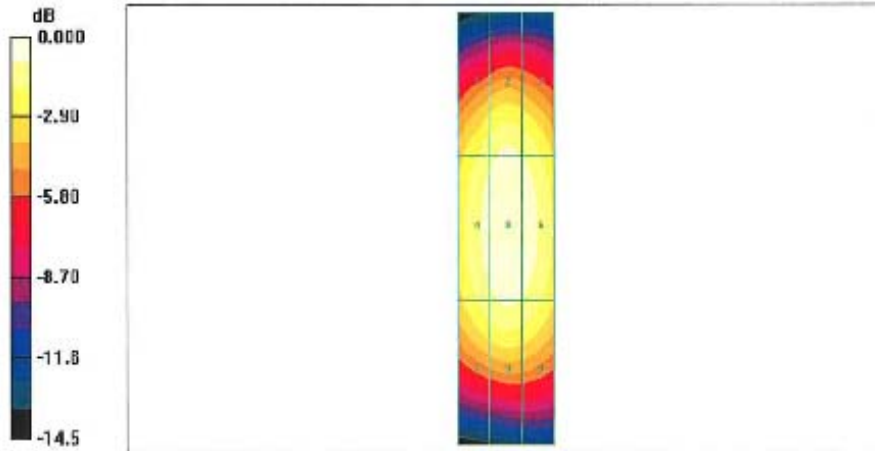

0 dB = 0.451 A/m

FCC ID: BEJAX155	PCTEST ENGINEERING LABORATORY, INC.	HAC (RF EMISSIONS) TEST REPORT	LG	Reviewed by: Quality Manager
HAC Filename: 0804140485.BEJ	Test Dates: April 19 - 26, 2008	EUT Type: Cellular/PCS CDMA Phone	Page 63 of 70	

**3.3.3 DASY4 E-Field result**

Date/Time: 7/18/2006 11:51:17 AM

Test Laboratory: SPFAG, Zurich, Switzerland

**DUT: HAC Dipole 1880 MHz; Type: CD1880V3; Serial: 1064**

Communication System: CW; Frequency: 1880 MHz; Duty Cycle: 1:

Medium: Air

Medium parameters used:  $\epsilon = 0$  mho/m,  $\epsilon_r = 1$ ;  $\rho = 1000$  kg/m<sup>3</sup>

Phantom section: E Dipole Section

DASY4 Configuration:

- Probe: BR3DV6 - SN2336; ConvF(1, 1, 1); Calibrated: 12/20/2005
- Sensor-Surface (Fix Surface)
- Electronics: DAE4 Sn660; Calibrated: 3/1/2006
- Phantom: HAC Test Arch 4.6; Type: SD HAC P01 BA; Serial: 1002
- Measurement SW: DASY4, V4.7 Build 44; Postprocessing SW: SEMCAD, V1.8 Build 171

**E Scan - Sensor Center 10mm above CD1880V3 Dipole/Hearing Aid Compatibility Test (41x181x1):**

Measurement grid dx=5mm, dy=5mm

Maximum value of peak Total field = 137.9 V/m

Probe Modulation Factor = 1.00

Reference Value = 132.3 V/m; Power Drift = 0.013 dB

Hearing Aid Near-Field Category: **M2 (AWF 0 dB)**

Peak E-field in V/m

Grid 1	Grid 2	Grid 3
134.7	137.9	131.1
Grid 4	Grid 5	Grid 6
86.8	90.4	88.7
Grid 7	Grid 8	Grid 9
128.1	131.2	127.7

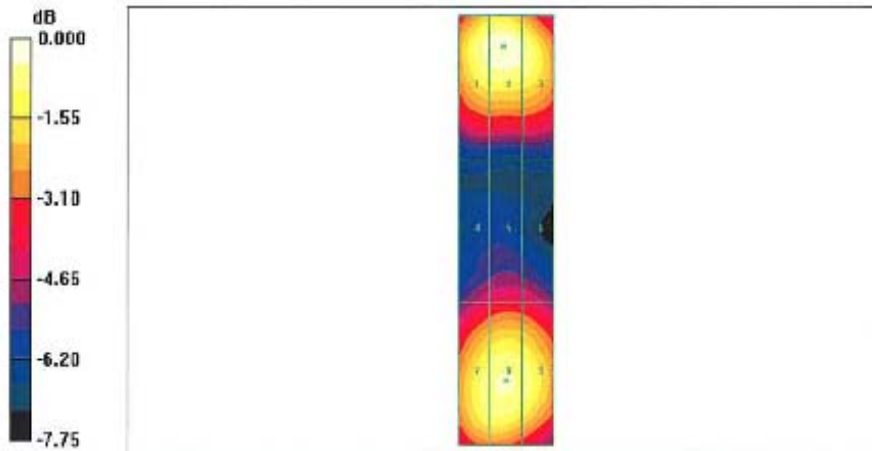



0 dB = 137.9 V/m

FCC ID: BEJAX155	PCTEST ENGINEERING LABORATORY, INC.	HAC (RF EMISSIONS) TEST REPORT	LG	Reviewed by: Quality Manager
HAC Filename: 0804140485.BEJ	Test Dates: April 19 - 26, 2008	EUT Type: Cellular/PCS CDMA Phone	Page 64 of 70	

## 15. CONCLUSION



The measurements indicate that the wireless communications device complies with the HAC limits specified in accordance with the ANSI C63.19 Standard and FCC WT Docket No. 01-309 RM-8658. Precise laboratory measures were taken to assure repeatability of the tests. The tested device complies with the requirements in respect to all parameters specific to the test. The test results and statements relate only to the item(s) tested.

Please note that the M-rating for this equipment only represents the field interference possible against a hypothetical and typical hearing aid. The measurement system and techniques presented in this evaluation are proposed in the ANSI standard as a means of best approximating wireless device compatibility with a hearing-aid. The literature is under continual re-construction.



<b>FCC ID:</b> BEJAX155	 <b>PCTEST</b> ENGINEERING LABORATORY, INC.	<b>HAC (RF EMISSIONS) TEST REPORT</b>	 <b>LG</b>	<b>Reviewed by:</b> Quality Manager
<b>HAC Filename:</b> 0804140485.BEJ	<b>Test Dates:</b> April 19 - 26, 2008	<b>EUT Type:</b> Cellular/PCS CDMA Phone	Page 65 of 70	

## 16. REFERENCES

1. ANSI C63.19-2006 v3.12, American National Standard for Methods of Measurement of Compatibility between Wireless communication devices and Hearing Aids.", New York, NY, IEEE, January 2006
2. FCC Public Notice DA 06-1215, *Wireless Telecommunications Bureau and Office of Engineering and Technology Clarify Use of Revised Wireless Phone Hearing Aid Compatibility Standard*, June 6, 2006
3. Review Guidance for Reviewing Applications for Certification of 3G Devices, May/June 2006
4. Berger, H. S., "Compatibility Between Hearing Aids and Wireless Devices," Electronic Industries Forum, Boston, MA, May, 1997
5. Berger, H. S., "Hearing Aid and Cellular Phone Compatibility: Working Toward Solutions," *Wireless Telephones and Hearing Aids: New Challenges for Audiology*, Gallaudet University, Washington, D.C., May, 1997 (To be reprinted in the American Journal of Audiology).
6. Berger, H. S., "Hearing Aid Compatibility with Wireless Communications Devices," IEEE International Symposium on Electromagnetic Compatibility, Austin, TX, August, 1997.
7. Bronaugh, E. L., "Simplifying EMI Immunity (Susceptibility) Tests in TEM Cells," in the 1990 IEEE International Symposium on Electromagnetic Compatibility Symposium Record, Washington, D.C., August 1990, pp. 488-491
8. Byrne, D. and Dillon, H., The National Acoustics Laboratory (NAL) New Procedure for Selecting the Gain and Frequency Response of a Hearing Aid, *Ear and Hearing* 7:257-265, 1986.
9. Crawford, M. L., "Measurement of Electromagnetic Radiation from Electronic Equipment using TEM Transmission Cells," U.S. Department of Commerce, National Bureau of Standards, NBSIR 73-306, Feb. 1973.
10. Crawford, M. L., and Workman, J. L., "Using a TEM Cell for EMC Measurements of Electronic Equipment," U.S. Department of Commerce, National Bureau of Standards. Technical Note 1013, July 1981.
11. EHIMA GSM Project, Development phase, Project Report (1<sup>st</sup> part) Revision A. Technical-Audiological Laboratory and Telecom Denmark, October 1993.
12. EHIMA GSM Project, Development phase, Part II Project Report. Technical-Audiological Laboratory and Telecom Denmark, June 1994.
13. EHIMA GSM Project Final Report, Hearing Aids and GSM Mobile Telephones: Interference Problems, Methods of Measurement and Levels of Immunity. Technical-Audiological Laboratory and Telecom Denmark, 1995.
14. HAMPIS Report, Comparison of Mobile phone electromagnetic near field with an upscaled electromagnetic far field, using hearing aid as reference, 21 October 1999.

FCC ID: BEJAX155	 <b>PCTEST</b> ENGINEERING LABORATORY, INC.	HAC (RF EMISSIONS) TEST REPORT	 <b>LG</b>	Reviewed by: Quality Manager
HAC Filename: 0804140485.BEJ	Test Dates: April 19 - 26, 2008	EUT Type: Cellular/PCS CDMA Phone	Page 66 of 70	

15. Hearing Aids/GSM, Report from OTWIDAM, Technical-Audiological Laboratory and Telecom Denmark, April 1993.
16. IEEE 100, The Authoritative Dictionary of IEEE Standards Terms, Seventh Edition.
17. Joyner, K. H., et. al., Interference to Hearing Aids by the New Digital Mobile Telephone System, Global System for Mobile (GSM) Communication Standard, National Acoustic Laboratory, Australian Hearing Series, Sydney 1993.
18. Joyner, K. H., et. al., Interference to Hearing Aids by the Digital Mobile Telephone System, Global System for Mobile Communications (GSM), NAL Report #131, National Acoustic Laboratory, Australian Hearing Series, Sydney, 1995.
19. Kecker, W. T., Crawford, M. L., and Wilson, W. A., "Construction of a Transverse Electromagnetic Cell", U.S. Department of Commerce, National Bureau of Standards, Technical Note 1011, Nov. 1978.
20. Konigstein, D., and Hansen, D., "A New Family of TEM Cells with enlarged bandwidth and Optimized working Volume," in the Proceedings of the 7<sup>th</sup> International Symposium on EMC, Zurich, Switzerland, March 1987; 50:9, pp. 127-132.
21. Kuk, F., and Hjordstgaard, N. K., "Factors affecting interference from digital cellular telephones," Hearing Journal, 1997; 50:9, pp 32-34.
22. Ma, M. A., and Kanda, M., "Electromagnetic Compatibility and Interference Metrology," U.S. Department of Commerce, National Bureau of Standards, Technical Note 1099, July 1986, pp. 17-43.
23. Ma, M. A., Sreenivashiah, I. , and Chang, D. C., "A Method of Determining the Emission and Susceptibility Levels of Electrically Small Objects Using a TEM Cell," U.S. Department of Commerce, National Bureau of Standards, Technial Note 1040, July 1981.
24. McCandless, G. A., and Lyregaard, P. E., Prescription of Gain/Output (POGO) for Hearing Aids, Hearing Instruments 1:16-21, 1983
25. Skopec, M., "Hearing Aid Electromagnetic Interference from Digital Wireless Telephones, "IEEE Transactions on Rehabilitation Engineering, vol. 6, no. 2, pp. 235-239, June 1998.
26. Technical Report, GSM 05.90, GSM EMC Considerations, European Telecommunications Standards Institute, January 1993.
27. Victorian, T. A., "Digital Cellular Telephone Interference and Hearing Aid Compatibility—an Update," Hearing Journal 1998; 51:10, pp. 53-60
28. Wong, G. S. K., and Embleton, T. F. W., eds., AIP Handbook of Condenser Microphones: Theory, Calibration and Measurements, AIP Press.

FCC ID: BEJAX155	 <b>PCTEST</b> ENGINEERING LABORATORY, INC.	<b>HAC (RF EMISSIONS) TEST REPORT</b>	 <b>LG</b>	<b>Reviewed by:</b> Quality Manager
<b>HAC Filename:</b> 0804140485.BEJ	<b>Test Dates:</b> April 19 - 26, 2008	<b>EUT Type:</b> Cellular/PCS CDMA Phone	Page 67 of 70	