

TEST REPORT

of

FCC Part 15 Subpart C §15.247
IC RSS-247 Issue 2 and RSS-Gen Issue 5

FCC ID: BEJ-PL2
IC Certification: 2703H-PL2

1. Equipment Under Test : Bluetooth Speaker
2. Model Name : PL2
3. Variant Model Name(s) : Refer to the page 3
4. Applicant : FCC: LG Electronics USA
: IC: LG Electronics Inc.
5. Manufacturer : LG Electronics Inc.
6. Date of Receipt : 2020.02.06
7. Date of Test(s) : 2020.02.11 ~ 2020.03.30
8. Date of Issue : 2020.04.06

In the configuration tested, the EUT complied with the standards specified above. This test report does not assure KOLAS accreditation.

- 1) The results of this test report are effective only to the items tested.
- 2) The SGS Korea is not responsible for the sampling, the results of this test report apply to the sample as received.

Tested by:



Jinhyoung Cho

Technical
Manager:



Hyunchae You

SGS Korea Co., Ltd. Gunpo Laboratory

INDEX

<u>Table of contents</u>	Page
1. General Information -----	3
2. Transmitter Radiated Spurious Emissions and Conducted Spurious Emission -----	8
3. 6 dB Bandwidth & 99 % Bandwidth -----	23
4. Maximum Peak Conducted Output Power -----	28
5. Power Spectral Density -----	31
6. AC Power Line Conducted Emission -----	34
7. Antenna Requirement -----	39

1. General Information

1.1. Testing Laboratory

SGS Korea Co., Ltd. (Gunpo Laboratory)

- 10-2, LS-ro 182beon-gil, Gunpo-si, Gyeonggi-do, Korea, 15807
- 4, LS-ro 182beon-gil, Gunpo-si, Gyeonggi-do, Korea, 15807
- Designation number: KR0150

All SGS services are rendered in accordance with the applicable SGS conditions of service available on request and accessible at <http://www.sgs.com/en/Terms-and-Conditions.aspx>.

Phone No. : +82 31 688 0901

Fax No. : +82 31 688 0921

1.2. Details of Applicant

FCC Applicant : LG Electronics USA

FCC Address : 1000 Sylvan Avenue, Englewood Cliffs, New Jersey, United States, 07632

IC Applicant : LG Electronics Inc.

IC Address : 222, LG-ro, Jinwi-myeon, Pyeongtaek-si, Gyeonggi-do, 451-713, Korea (Republic Of)

Contact Person : Han, Kyung-su

Phone No. : +2 201 472 2623

1.3. Details of Manufacturer

Company : LG Electronics Inc.

Address : 170, Seongsanpaechong-ro, Seongsan-gu, Changwon-si, Gyeongsangnam-do
 51533, Korea

1.4. Description of EUT

Kind of Product	Bluetooth Speaker
Model Name	PL2
Variant Model Name	PL2W
Power Supply	DC 3.7 V
Frequency Range	2 402 MHz ~ 2 480 MHz (Bluetooth Low Energy)
Modulation Technique	GFSK
Number of Channels	40 channels (Bluetooth Low Energy)
Antenna Type	PCB pattern antenna
Antenna Gain	3.40 dB i

1.5. Test Equipment List

Equipment	Manufacturer	Model	S/N	Cal. Date	Cal. Interval	Cal. Due
Signal Generator	R&S	SMR40	100272	Jun. 07, 2019	Annual	Jun. 07, 2020
Signal Generator	R&S	SMBV100A	259067	Jun. 10, 2019	Annual	Jun. 10, 2020
Spectrum Analyzer	R&S	FSV30	103101	Jun. 05, 2019	Annual	Jun. 05, 2020
Spectrum Analyzer	Agilent	N9030A	US51350132	Nov. 15, 2019	Annual	Nov. 15, 2020
Attenuator	AEROFLEX / INMET	40AH2W-10	40G-3	Jun. 20, 2019	Annual	Jun. 20, 2020
High Pass Filter	Wainwright Instrument GmbH	WHK3.0/18G-10SS	344	May 21, 2019	Annual	May 21, 2020
High Pass Filter	Wainwright Instrument GmbH	WHNX7.5/26.5G-6SS	15	Jun. 07, 2020	Annual	Jun. 07, 2020
Low Pass Filter	Mini-Circuits	NLP-1200+	V9500401023-2	Jun. 05, 2019	Annual	Jun. 05, 2020
Power Sensor	R&S	NRP-Z81	100418	Feb. 17, 2020	Annual	Feb. 17, 2021
DC Power Supply	R&S	HMP2020	020089489	May 21, 2019	Annual	May 21, 2020
Preamplifier	H.P.	8447F	2944A03909	Aug. 07, 2019	Annual	Aug. 07, 2020
Signal Conditioning Unit	R&S	SCU-18	10117	Jun. 12, 2019	Annual	Jun. 12, 2020
Preamplifier	MITEQ Inc.	JS44-18004000-35-8P	1546891	May 13, 2019	Annual	May 13, 2020
Loop Antenna	Schwarzbeck Mess-Elektronik	FMZB 1519	1519-039	Aug. 22 2019	Biennial	Aug. 22, 2021
Bilog Antenna	Schwarzbeck Mess-Elektronik	VULB 9163	396	Mar. 21, 2019	Biennial	Mar. 21, 2021
Horn Antenna	R&S	HF906	100326	Feb. 14, 2020	Annual	Feb. 14, 2021
Horn Antenna	Schwarzbeck Mess-Elektronik	BBHA 9170	BBHA9170431	Sep. 10, 2018	Biennial	Sep. 10, 2020
Turn Table	Innco systems GmbH	DS 1200 S	N/A	N.C.R.	N/A	N.C.R.
Controller	Innco systems GmbH	CONTROLLER CO3000-4P	CO3000/963/383 30516/L	N.C.R.	N/A	N.C.R.
Antenna Mast	Innco systems GmbH	MA4640-XP-ET	MA4640/536/383 30516/L	N.C.R.	N/A	N.C.R.
Anechoic Chamber	SY Corporation	L x W x H (9.6 m x 6.4 m x 6.6 m)	N/A	N.C.R.	N/A	N.C.R.
Test Receiver	R&S	ESU26	100109	Feb. 18, 2020	Annual	Feb. 18, 2021
Test Receiver	R&S	ESCI 7	100911	Feb. 19, 2020	Annual	Feb. 19, 2021
Two-Line V-Network	R&S	ENV216	100190	May 14, 2019	Annual	May 14, 2020
Shield Room	SY Corporation	L x W x H (6.5 m x 3.5 m x 3.5 m)	N/A	N.C.R.	N/A	N.C.R.
Coaxial Cable	SUCOFLEX	104 (3 m)	MY3258414	Jan. 28, 2020	Semi-annual	Jul. 28, 2020
Coaxial Cable	SUCOFLEX	104 (10 m)	MY3145814	Jan. 28, 2020	Semi-annual	Jul. 28, 2020
Coaxial Cable	Rosenberger	LA1-C006-1500	131014 01/20	Feb. 13, 2020	Semi-annual	Aug. 13, 2020

1.6. Summary of Test Results

The EUT has been tested according to the following specifications:

APPLIED STANDARD: FCC Part15 Subpart C, IC RSS-247 Issue 2 and RSS-Gen Issue 5			
Section in FCC	Section in IC	Test Item(s)	Result
15.205(a) 15.209 15.247(d)	RSS-247 Issue 2 5.5 RSS-Gen Issue 5 8.9	Transmitter Radiated Spurious Emissions and Conducted Spurious Emission	Complied
15.247(a)(2)	RSS-247 Issue 2 5.2(a) RSS-Gen Issue 5 6.7	6 dB Bandwidth & 99 % Bandwidth	Complied
15.247(b)(3)	RSS-247 Issue 2 5.4(d)	Maximum Peak Conducted Output Power	Complied
15.247(e)	RSS-247 Issue 2 5.2(b)	Power Spectral Density	Complied
15.207	RSS-Gen Issue 5 8.8	AC Power Line Conducted Emission	Complied

1.7. Conclusion of Worst-Case (Bluetooth 4.2)

Modulation	Mode	Frequency (MHz)	Packet Length (byte)	Peak Power (dBm)
GFSK	PHY 1M	2 402	<u>37</u>	<u>4.633</u>
			250	4.631

1.8. Test Procedure(s)

The measurement procedures described in the American National Standard of Procedure for Compliance Testing of unlicensed Wireless Devices (ANSI C63.10-2013) and the guidance provided in KDB 558074 D01 15.247 Meas Guidance v05r02 were used in the measurement of the DUT.

1.9. Sample Calculation

Where relevant, the following sample calculation is provided:

1.9.1. Conducted Test

Offset value (dB) = Attenuator (dB) + Cable loss (dB)

1.9.2. Radiation Test

Field strength level (dB μ V/m) = Measured level (dB μ V) + Antenna factor (dB) + Cable loss (dB) - Amplifier gain (dB)

1.10. Measurement Uncertainty

Where relevant, the following measurement uncertainty levels have been estimated for tests performed on the apparatus:

Parameter	Uncertainty
RF Output Power	± 0.44 dB
Occupied Bandwidth	± 9.66 kHz
Power Spectral Density	± 0.60 dB
Conducted Spurious Emission	± 0.76 dB
AC Conducted Emission	± 3.45 dB
Radiated Emission, 9 kHz to 30 MHz	± 3.59 dB
Radiated Emission, below 1 GHz	± 5.88 dB
Radiated Emission, above 1 GHz	± 5.94 dB

Uncertainty figures are valid to a confidence level of 95 %.

1.11. Test Report Revision

Revision	Report Number	Date of Issue	Description
0	F690501-RF-RTL000508	2020.04.06	Initial

1.12. Description of Variant Model

Model Name	Description
PL2	- Basic model
PL2W	- Same to basic model, but variant model is different color.

1.13. Duty Cycle of EUT

Regarding to KDB 558074 D01 15.247 Meas Guidance v05r02, 6, the maximum duty cycle was investigated and set the spectrum analyzer as below;

Set RBW ≥ OBW if possible; otherwise, set RBW to the largest available value. Set detector = peak or average. The zero-span measurement method shall not be used unless both RBW and VBW are > 50/T and the number of sweep points across duration T exceeds 100.

Duty Cycle (%)	Correction Factor (dB)
64	1.94

Remark;

1. Duty Cycle (%) = (Tx on time / Tx on + off time) x 100
2. Correction Factor (dB) = 10 log (1 / Duty Cycle)

- Test plot

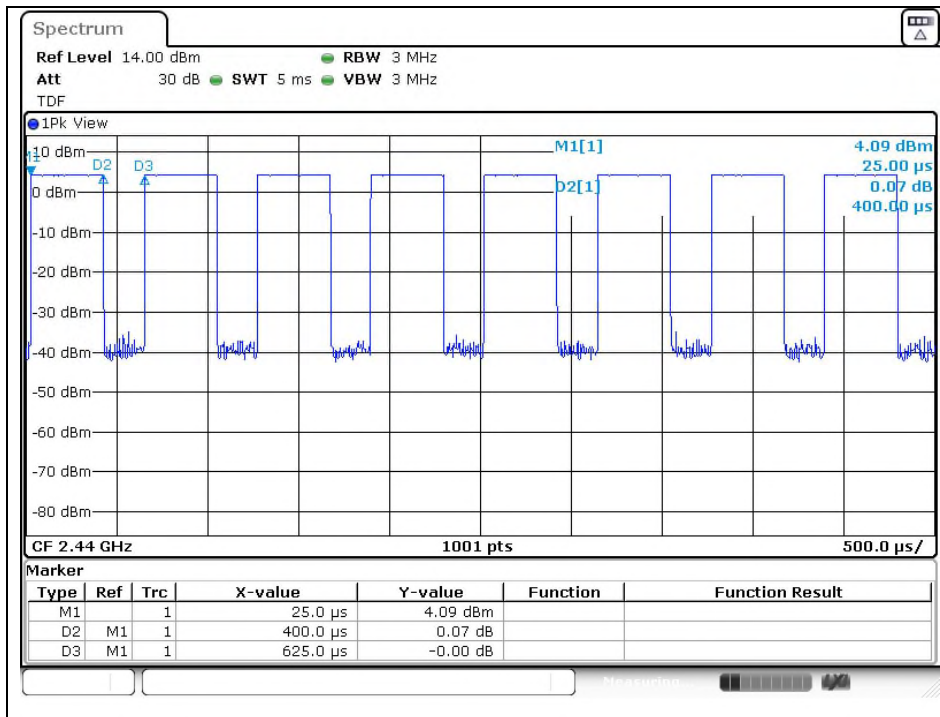

2. Transmitter Radiated Spurious Emissions and Conducted Spurious Emission

2.1. Test Setup

2.1.1. Transmitter Radiated Spurious Emissions

The diagram below shows the test setup that is utilized to make the measurements for emission from 9 kHz to 30 MHz.

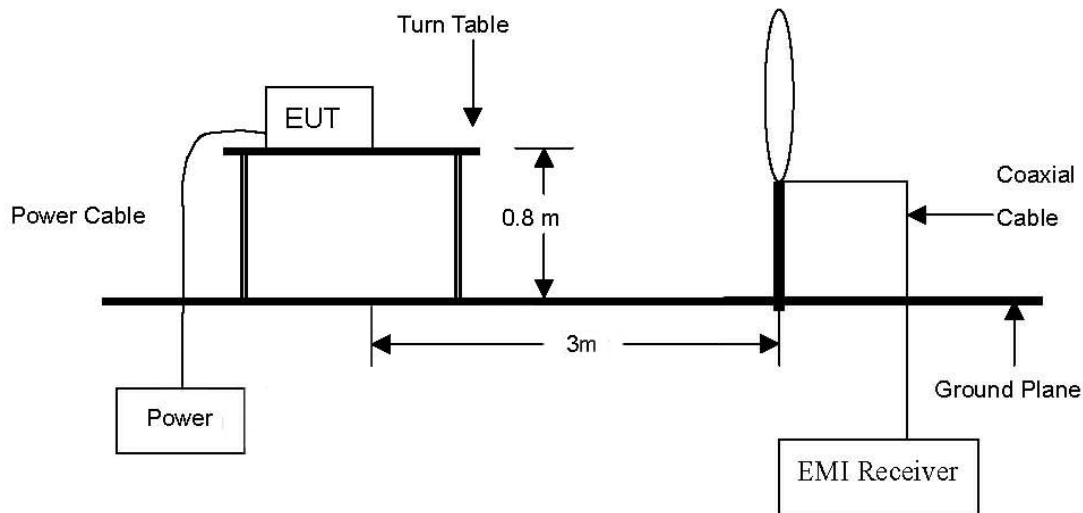

The diagram below shows the test setup that is utilized to make the measurements for emission from 30 MHz to 1 GHz.

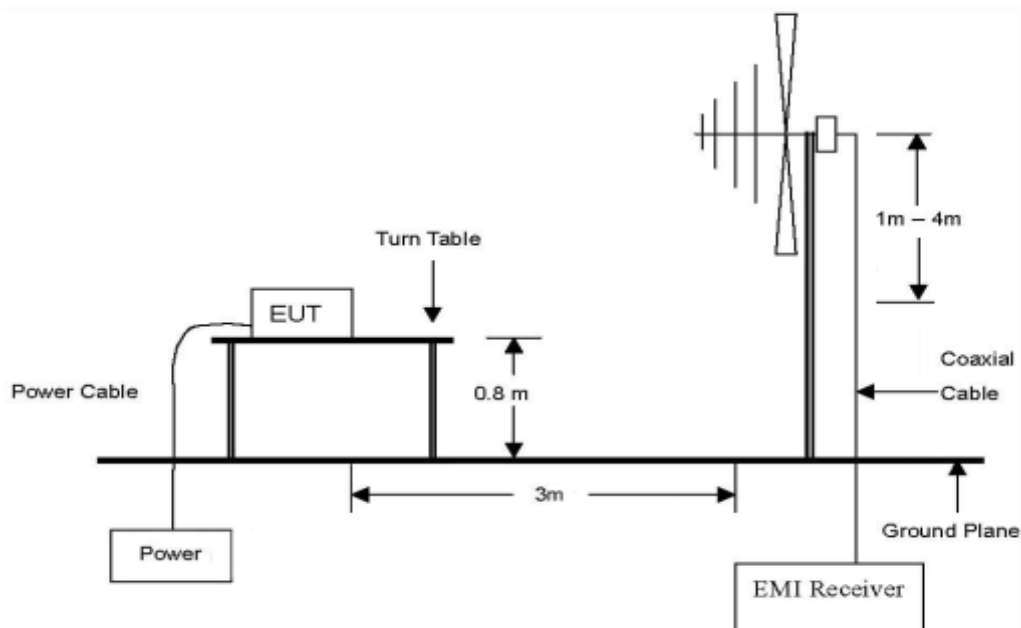

The diagram below shows the test setup that is utilized to make the measurements for emission. The spurious emissions were investigated from 1 GHz to the 10th harmonic of the highest fundamental frequency or 40 GHz, whichever is lower.

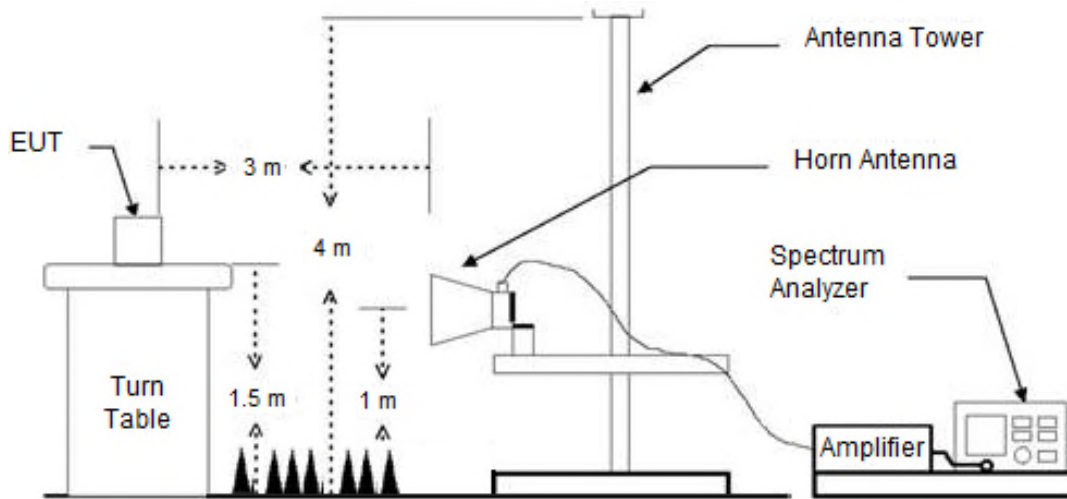

2.1.2. Conducted Spurious Emission



2.2. Limit

2.2.1. FCC

According to §15.247(d), in any 100 kHz bandwidth outside the frequency band in which the spread spectrum or digitally modulated intentional radiator is operating, the radio frequency power that is produced by the intentional radiator shall be at least 20 dB below that in the 100 kHz bandwidth within the band that contains the highest level of the desired power, based on either an RF conducted or a radiated measurement, provided the transmitter demonstrates compliance with the peak conducted power limits. If the transmitter complies with the conducted power limits based on the use of RMS averaging over a time interval, as permitted under paragraph (b)(3) of this section, the attenuation required under this paragraph shall be 30 dB instead of 20 dB. Attenuation below the general limits specified in §15.209(a) is not required. In addition, radiated emission which fall in the restricted bands, as defined in §15.205(a), must also comply with the radiated emission limits specified in §15.209(a) (see §15.205(c)).

According to §15.209(a), except as provided elsewhere in this subpart, the emissions from an intentional radiator shall not exceed the field strength levels specified in the following table:

Frequency (MHz)	Field Strength ($\mu\text{V}/\text{m}$)	Measurement Distance (Meters)
0.009-0.490	2 400/F(kHz)	300
0.490-1.705	24 000/F(kHz)	30
1.705-30.0	30	30
30-88	100**	3
88-216	150**	3
216-960	200**	3
Above 960	500	3

** Except as provided in paragraph (g), fundamental emissions from intentional radiators operating under this section shall not be located in the frequency bands 54-72 MHz, 76-88 MHz, 174-216 MHz or 470-806 MHz. However, operation within these frequency bands is permitted under other sections of this part, e.g., §§15.231 and 15.241.

2.2.2. IC

According to RSS-247 Issue 2, 5.5, in any 100 kHz bandwidth outside the frequency band in which the spread spectrum or digitally modulated device is operating, the RF power that is produced shall be at least 20 dB below that in the 100 kHz bandwidth within the band that contains the highest level of the desired power, based on either an RF conducted or a radiated measurement, provided that the transmitter demonstrates compliance with the peak conducted power limits. If the transmitter complies with the conducted power limits based on the use of root-mean-square averaging over a time interval, as permitted under section 5.4(d), the attenuation required shall be 30 dB instead of 20 dB. Attenuation below the general field strength limits specified in RSS-Gen is not required.

According to RSS-Gen Issue 5, 8.9, except where otherwise indicated in the applicable RSS, radiated emissions shall comply with the field strength limits shown in table 5 and table 6. Additionally, the level of any transmitter unwanted emission shall not exceed the level of the transmitter's fundamental emission.

Table 5 – General Field Strength Limits at frequencies above 30 MHz

Frequency (MHz)	Field Strength ($\mu\text{V}/\text{m}$ at 3 m)
30-88	100
88-216	150
216-960	200
Above 960	500

Table 6 – General Field Strength Limits at frequencies below 30 MHz

Frequency	Magnetic Field Strength (H-Field) ($\mu\text{A}/\text{m}$)	Measurement Distance (meters)
9-490 kHz ¹	6.37/F (F in kHz)	300
490-1 705 kHz	63.7/F (F in kHz)	30
1.705-30 MHz	0.08	30

Note¹: The emission limits for the ranges 9-90 kHz and 110-490 kHz are based on measurements employing a linear average detector.

2.3. Test Procedures

Radiated emissions from the EUT were measured according to the dictates in section 11.11 & 11.12 of ANSI C63.10-2013.

2.3.1. Test Procedures for emission below 30 MHz

1. The EUT was placed on the top of a rotating table 0.8 meters above the ground at a 3 meter anechoic chamber test site. The table was rotated 360 degrees to determine the position of the highest radiation.
2. Then antenna is a loop antenna is fixed at one meter above the ground to determine the maximum value of the field strength. Both parallel and perpendicular of the antenna are set to make the measurement.
3. For each suspected emission, the EUT was arranged to its worst case and then the table was turned from 0 degrees to 360 degrees to find the maximum reading.
4. The test-receiver system was set to average or quasi peak detect function and Specified Bandwidth with Maximum Hold Mode.

2.3.2. Test Procedures for emission from above 30 MHz

1. The EUT was placed on the top of a rotating table 0.8 meters above the ground at a 3 meter anechoic chamber test site below 1 GHz and 1.5 meters above the ground at a 3 meter anechoic chamber test site above 1 GHz. The table was rotated 360 degrees to determine the position of the highest radiation.
2. During performing radiated emission below 1 GHz, the EUT was set 3 meters away from the interference receiving antenna, which was mounted on the top of a variable-height antenna tower. During performing radiated emission above 1 GHz, the EUT was set 3 meter away from the interference-receiving antenna.
3. The antenna is a bi-log antenna, a horn antenna and its height is varied from one meter to four meters above the ground to determine the maximum value of the field strength. Both horizontal and vertical polarizations of the antenna are set to make the measurement.
4. For each suspected emission, the EUT was arranged to its worst case and then the antenna was tuned to heights from 1 meter to 4 meters and the table was turned from 0 degrees to 360 degrees to find the maximum reading.
5. The test-receiver system was set to Peak Detect Function and Specified Bandwidth with Maximum Hold Mode.

1. Unwanted Emissions into Non-Restricted Frequency Bands

- The Reference Level Measurement refer to section 11.11.2

Set analyzer center frequency to DTS channel center frequency, SPAN ≥ 1.5 times the DTS bandwidth, the RBW = 100 kHz and VBW $\geq 3 \times$ RBW, Detector = Peak, Sweep time = Auto couple, Trace = Max hold.

- Unwanted Emissions Level Measurement refer to section 11.11.3

Set the center frequency and span to encompass frequency range to be measured, the RBW = 100 kHz and VBW $\geq 3 \times$ RBW, Detector = Peak, Sweep time = Auto couple, Trace = Max hold.

2. Unwanted Emissions into Restricted Frequency Bands

- Peak Power measurement procedure refer to section 11.12.2.4

Set RBW = as specified in Table 9, VBW $\geq 3 \times$ RBW, Detector = Peak, Sweep time = auto, Trace = Max hold.

Table 9 – RBW as a function of frequency

Frequency	RBW
9 kHz to 150 kHz	200 Hz to 300 Hz
0.15 MHz to 30 MHz	9 kHz to 10 kHz
30 MHz to 1 000 MHz	100 kHz to 120 kHz
> 1 000 MHz	1 MHz

If the peak – detected amplitude can be shown to comply with the average limit, then it is not necessary to perform a separate average measurement.

- Average Power measurements procedure refer to section 11.12.2.5.2

The EUT shall be configured to operate at the maximum achievable duty cycle.

Measure the duty cycle D of the transmitter output signal as described in section 11.6.

Set RBW = 1 MHz, VBW $\geq 3 \times$ RBW, Detector = RMS, if span / (# of points in sweep) \leq (RBW/2).

Satisfying this condition may require increasing the number of points in the sweep or reducing the span. If this condition cannot be satisfied then the detector mode shall be set to peak.

Averaging type = power (i.e., RMS).

As an alternative the detector and averaging type may be set for linear voltage averaging.

Some instruments require linear display mode in order to use linear voltage averaging. Log or dB averaging shall not be used. Sweep time = auto, Perform a trace average of at least 100 traces.

A correction factor shall be added to the measurement results prior to comparing to the emission limit in order to compute the emission level that would have been measured had the test been performed at 100 percent duty cycle. The correction factor is computed as follows:

- 1) If power averaging (rms) mode was used in step f), then the applicable correction factor is $[10 \log (1 / D)]$, where D is the duty cycle.

3. Definition of DUT Axis.

Definition of the test orthogonal plan for EUT was described in the test setup photo.

The test orthogonal plan of EUT is **X – axis** during radiation test.

2.3.3. Test Procedures for Conducted Spurious Emissions

Per the guidance of ANSI C63.10-2013, section 11.11.1 & 11.11.2 & 11.11.3, the reference level for out of band emissions is established from the plots of this section since the band edge emissions are measured with a RBW of 100 kHz. This reference level is then used as the limit in subsequent plots for out of band spurious emissions shown in section 2.4.3. The limit for out of band spurious emission at the band edge is 20 dB below the fundamental emission level measured in a 100 kHz bandwidth.

1. Conducted Emissions at Band Edge

- The Measurement refer to section 11.11.2

Set the center frequency and span to encompass frequency range to be measured, the RBW = 100 kHz and VBW $\geq 3 \times$ RBW, Detector = Peak, Sweep time = Auto couple, Trace mode = Max hold, The trace was allowed to stabilize.

2. Conducted Spurious Emissions

- The Measurement refer to section 11.11.3

Start frequency was set to 9 kHz and stop frequency was set to 25 GHz (separated into two plots per channel), RBW = 1 MHz, VBW $\geq 3 \times$ RBW, Detector = Peak, Sweep time = Auto couple, Trace = Max hold, The trace was allowed to stabilize.

3. TDF function

- For plots showing conducted spurious emissions from 9 kHz to 25 GHz, all path loss of wide frequency range was investigated and compensated to spectrum analyzer as TDF function. So, the reading values shown in plots were final result.

2.4. Test Results

Ambient temperature : (23 ± 1) °C
 Relative humidity : 47 % R.H.

2.4.1. Radiated Spurious Emission below 1 000 MHz

The frequency spectrum from 9 kHz to 1 000 MHz was investigated. All reading values are peak values.

Radiated Emissions			Ant	Correction Factors		Total	Limit	
Frequency (MHz)	Reading (dBμV)	Detect Mode	Pol.	AF (dB/m)	AMP + CL (dB)	Actual (dBμV/m)	Limit (dBμV/m)	Margin (dB)
127.40	43.40	Peak	H	14.70	-25.29	32.81	43.50	10.69
130.80	43.80	Peak	V	14.42	-25.27	32.95	43.50	10.55
289.19	47.00	Peak	V	18.98	-24.91	41.07	46.00	4.93
296.31	48.20	Peak	H	19.20	-24.91	42.49	46.00	3.51
336.00	43.80	Peak	V	21.36	-24.79	40.37	46.00	5.63
432.03	38.20	Peak	V	22.14	-24.57	35.77	46.00	10.23
Above 500.00	Not detected	-	-	-	-	-	-	-

Remark;

- Spurious emissions for all channels were investigated and almost the same below 1 GHz.
- Reported spurious emissions are in **Low channel** as worst case among other channels.
- Radiated spurious emission measurement as below.
(Actual = Reading + AF + AMP + CL)
- According to §15.31(o), emission levels are not report much lower than the limits by over 20 dB.

- Test plot

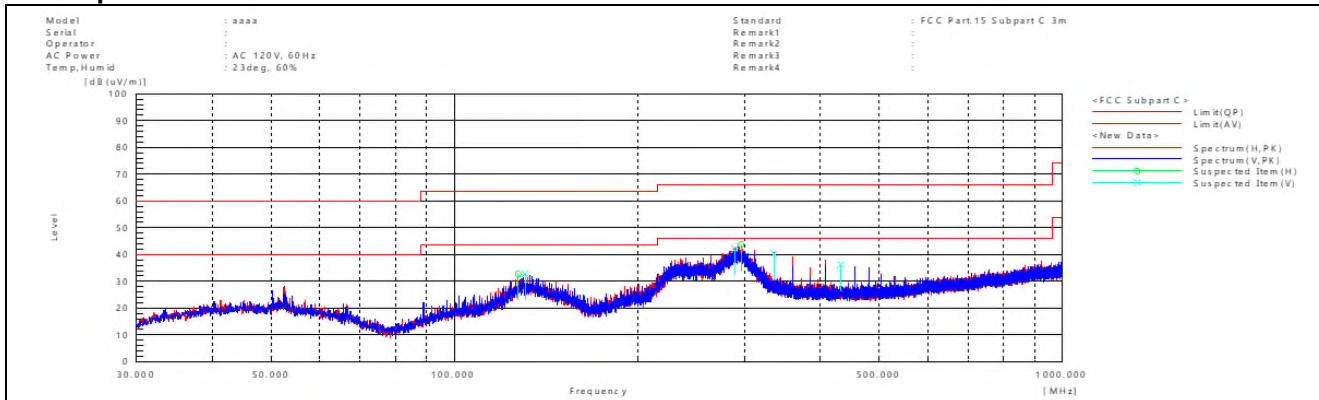

2.4.2. Radiated Spurious Emission above 1 000 MHz

The frequency spectrum above 1 000 MHz was investigated. All reading values are peak and average values.

Low Channel (2 402 MHz)

Radiated Emissions			Ant.	Correction Factors			Total	Limit	
Frequency (MHz)	Reading (dB μ V)	Detect Mode	Pol.	AF (dB/m)	CL (dB)	DF (dB)	Actual (dB μ V/m)	Limit (dB μ V/m)	Margin (dB)
*2 310.00	14.07	Peak	V	27.96	8.21	-	50.24	74.00	23.76
*2 310.00	3.41	Average	V	27.96	8.21	1.94	41.52	54.00	12.48
*2 373.48	16.05	Peak	V	28.03	8.33	-	52.41	74.00	21.59
*2 338.06	4.41	Average	V	27.85	8.24	1.94	42.44	54.00	11.56
*2 390.00	14.77	Peak	V	28.20	8.35	-	51.32	74.00	22.68
*2 390.00	4.19	Average	V	28.20	8.35	1.94	42.68	54.00	11.32

Radiated Emissions			Ant.	Correction Factors			Total	Limit	
Frequency (MHz)	Reading (dB μ V)	Detect Mode	Pol.	AF (dB/m)	AMP+CL (dB)	DF (dB)	Actual (dB μ V/m)	Limit (dB μ V/m)	Margin (dB)
Above 1 000.00	Not detected	-	-	-	-	-	-	-	-

Middle Channel (2 440 MHz)

Radiated Emissions			Ant.	Correction Factors			Total	Limit	
Frequency (MHz)	Reading (dB μ V)	Detect Mode	Pol.	AF (dB/m)	AMP+CL (dB)	DF (dB)	Actual (dB μ V/m)	Limit (dB μ V/m)	Margin (dB)
Above 1 000.00	Not detected	-	-	-	-	-	-	-	-

High Channel (2 480 MHz)

Radiated Emissions			Ant.	Correction Factors			Total	Limit	
Frequency (MHz)	Reading (dB μ V)	Detect Mode	Pol.	AF (dB/m)	CL (dB)	DF (dB)	Actual (dB μ V/m)	Limit (dB μ V/m)	Margin (dB)
*2 483.50	31.94	Peak	V	28.37	8.44	-	68.75	74.00	5.25
*2 483.50	12.16	Average	V	28.37	8.44	1.94	50.91	54.00	3.09
*2 483.54	31.98	Peak	V	28.37	8.44	-	68.79	74.00	5.21
*2 483.61	12.07	Average	V	28.37	8.44	1.94	50.82	54.00	3.18
*2 500.00	14.53	Peak	V	28.30	8.49	-	51.32	74.00	22.68
*2 500.00	4.20	Average	V	28.30	8.49	1.94	42.93	54.00	11.07

Radiated Emissions			Ant.	Correction Factors			Total	Limit	
Frequency (MHz)	Reading (dB μ V)	Detect Mode	Pol.	AF (dB/m)	AMP+CL (dB)	DF (dB)	Actual (dB μ V/m)	Limit (dB μ V/m)	Margin (dB)
Above 1 000.00	Not detected	-	-	-	-	-	-	-	-

Remark;

1. “*” means the restricted band.
2. Measuring frequencies from 1 GHz to the 10th harmonic of highest fundamental frequency.
3. Radiated emissions measured in frequency above 1 000 MHz were made with an instrument using peak/average detector mode.
4. Actual = Reading + AF + CL + (DF) or Reading + AF + AMP + CL + (DF).
5. According to § 15.31(o), emission levels are not reported much lower than the limits by over 20 dB.
6. The maximized peak measured value complies with the average limit, to perform an average measurement is unnecessary.

- Test plots

Low channel Band edge (Peak)

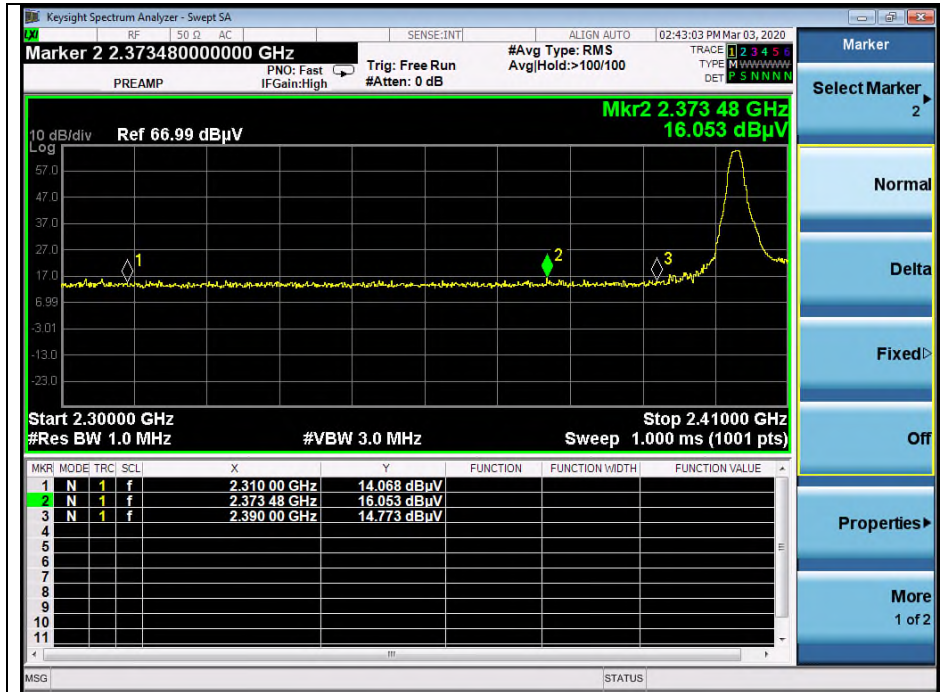

Low channel Band edge (Average)

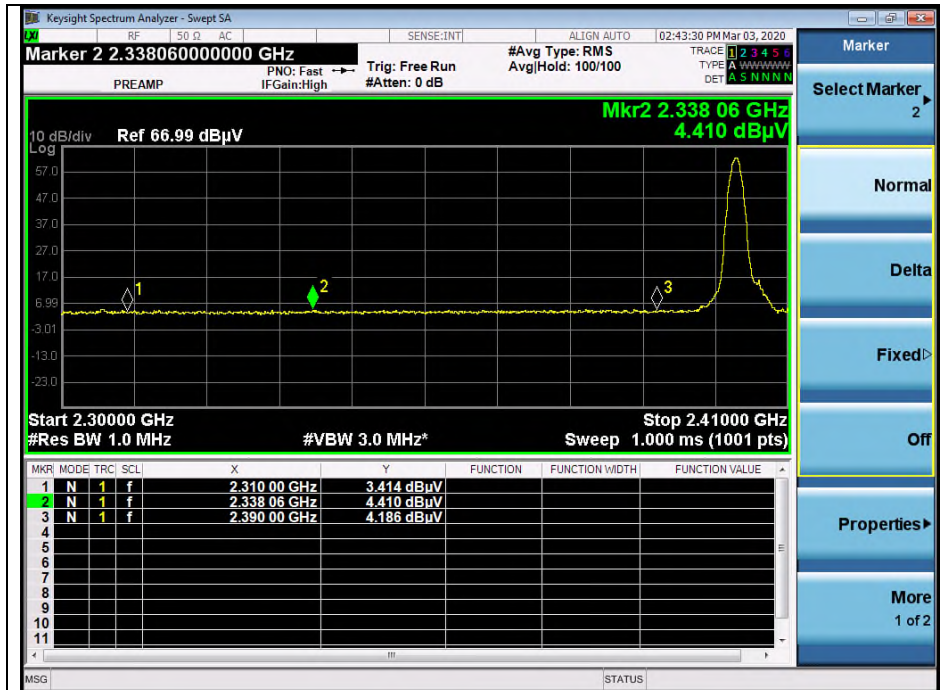

High channel Band edge (Peak)

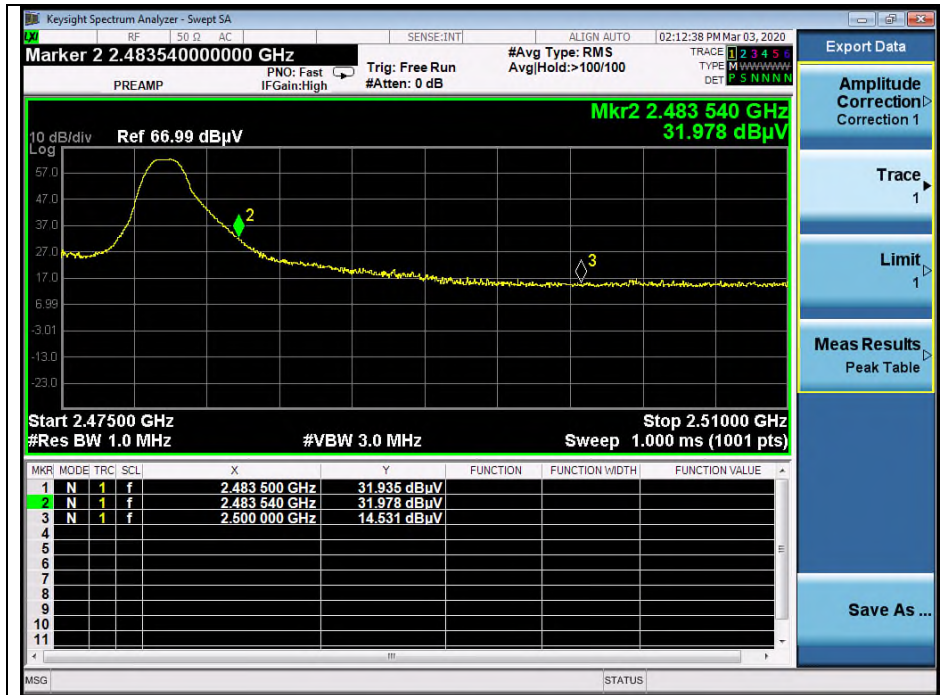

High channel Band edge (Average)

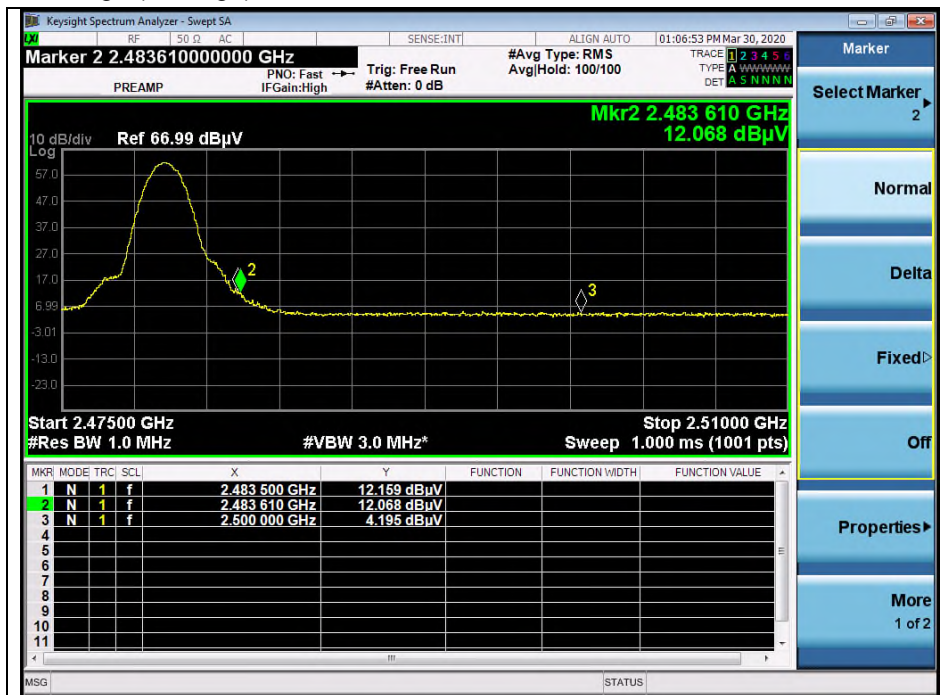

2.4.3. Plot of Conducted Spurious Emissions

Low Channel

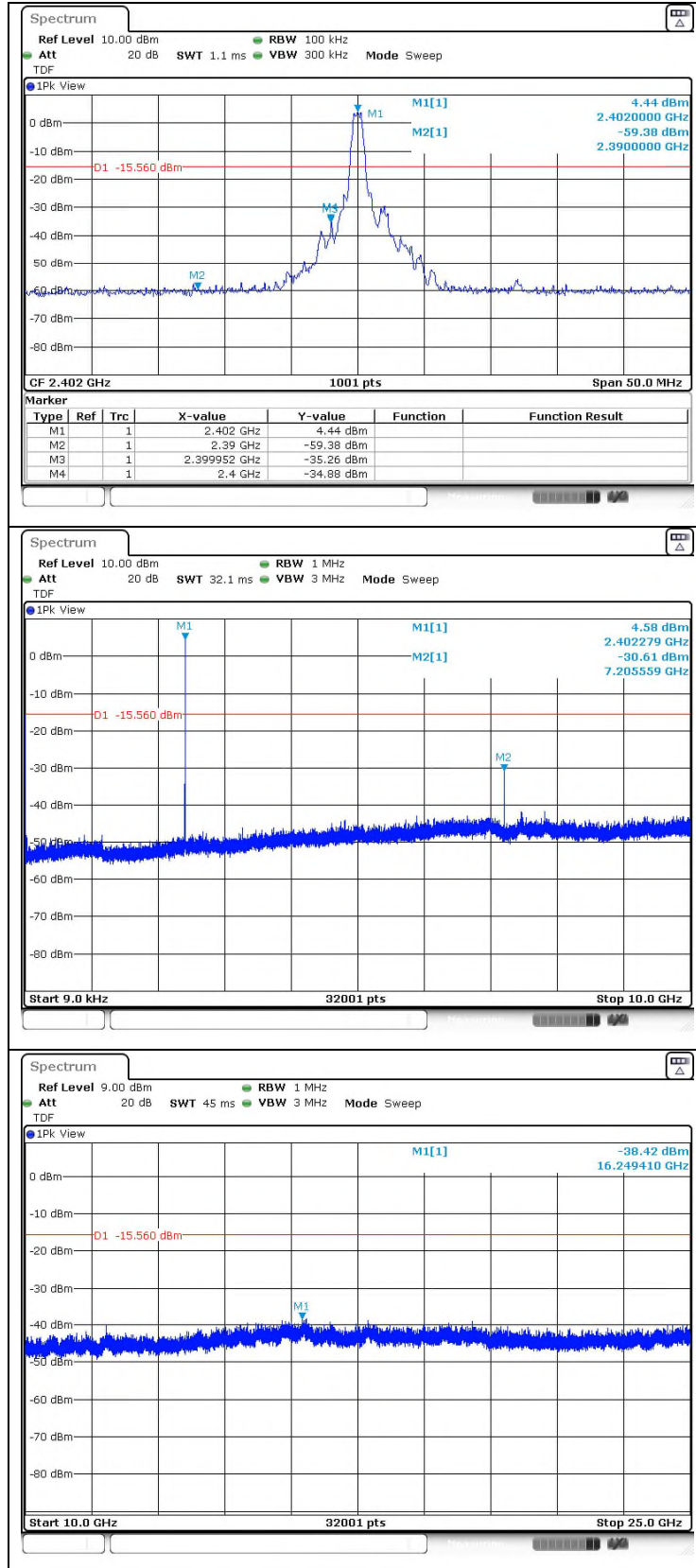

Middle Channel

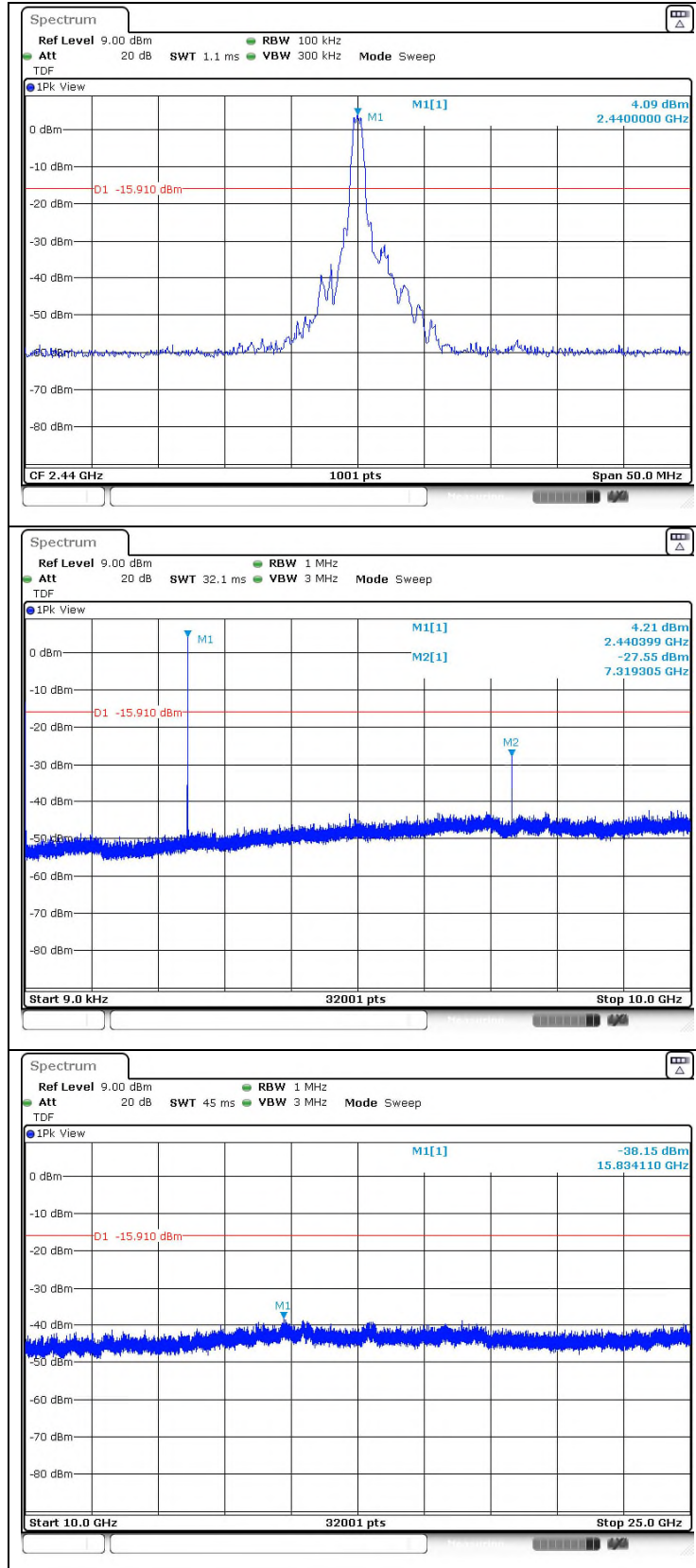

High Channel

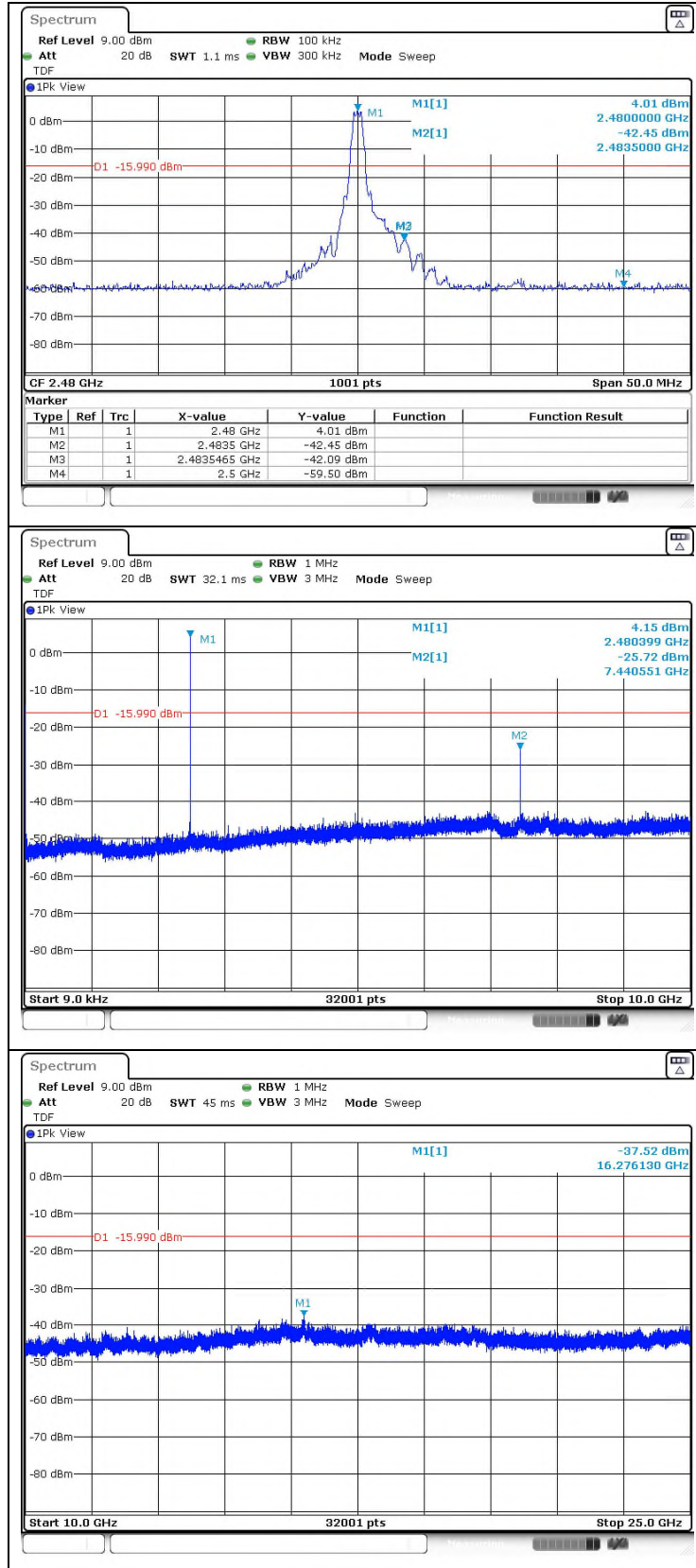

3. 6 dB Bandwidth & 99 % Bandwidth

3.1. Test Setup



3.2. Limit

3.2.1. FCC

According to §15.247(a)(2), systems using digital modulation techniques may operate in the 902-928 MHz, 2 400-2 483.5 MHz, and 5 725-5 850 MHz bands. The minimum 6 dB bandwidth shall be at least 500 kHz.

3.2.2. IC

According to RSS-247 Issue 2, 5.2(a), the minimum 6 dB bandwidth shall be 500 kHz.

3.3. Test Procedure

3.3.1. 6 dB Bandwidth

The test follows section 11.8 DTS bandwidth of ANSI C63.10-2013.

Tests performed using section 11.8.1 Option 1.

- Option 1:

1. Set RBW to = 100 kHz.
2. Set the VBW \geq 3 x RBW.
3. Detector = peak.
4. Trace mode = max hold.
5. Sweep = auto couple.
6. Allow the trace to stabilize.
7. Measure the maximum width of the emission that is constrained by the frequencies associated with the two outermost amplitude points (upper and lower frequencies) that are attenuated by 6 dB relative to the maximum level measured in the fundamental emission.

3.3.2. 99 % Bandwidth

The following conditions shall be observed for measuring the occupied bandwidth and x dB bandwidth:

- The transmitter shall be operated at its maximum carrier power measured under normal test conditions.
- The span of the spectrum analyzer shall be set large enough to capture all products of the modulation process, including the emission skirts, around the carrier frequency, but small enough to avoid having other emissions (e.g. on adjacent channels) within the span.
- The detector of the spectrum analyzer shall be set to "Sample". However, a peak, or peak hold, may be used in place of the sampling detector since this usually produces a wider bandwidth than the actual bandwidth (worst-case measurement). Use of a peak hold (or "Max Hold") may be necessary to determine the occupied / x dB bandwidth if the device is not transmitting continuously.
- The resolution bandwidth (RBW) shall be in the range of 1 % to 5 % of the actual occupied / x dB bandwidth and the video bandwidth (VBW) shall not be smaller than three times the RBW value. Video averaging is not permitted.

Note: It may be necessary to repeat the measurement a few times until the RBW and VBW are in compliance with the above requirement.

For the 99 % emission bandwidth, the trace data points are recovered and directly summed in linear power level terms. The recovered amplitude data points, beginning at the lowest frequency, are placed in a running sum until 0.5 % of the total is reached, and that frequency recorded. The process is repeated for the highest frequency data points (starting at the highest frequency, at the right side of the span, and going down in frequency). This frequency is then recorded. The difference between the two recorded frequencies is the occupied bandwidth (or the 99 % emission bandwidth).

3.4. Test Results

Ambient temperature : (23 ± 1) °C
 Relative humidity : 47 % R.H.

Mode	Channel	Frequency (MHz)	6 dB Bandwidth (MHz)	99 % Bandwidth (MHz)	Minimum Bandwidth (kHz)
GFSK	Low	2 402	0.729	1.059	500
	Middle	2 440	0.729	1.039	
	High	2 480	0.729	1.049	

- Test plots

6 dB Bandwidth

Low Channel

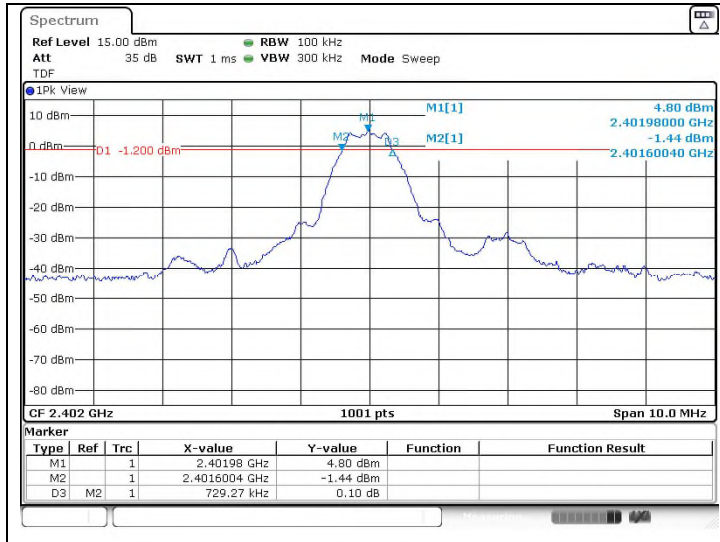

Middle Channel

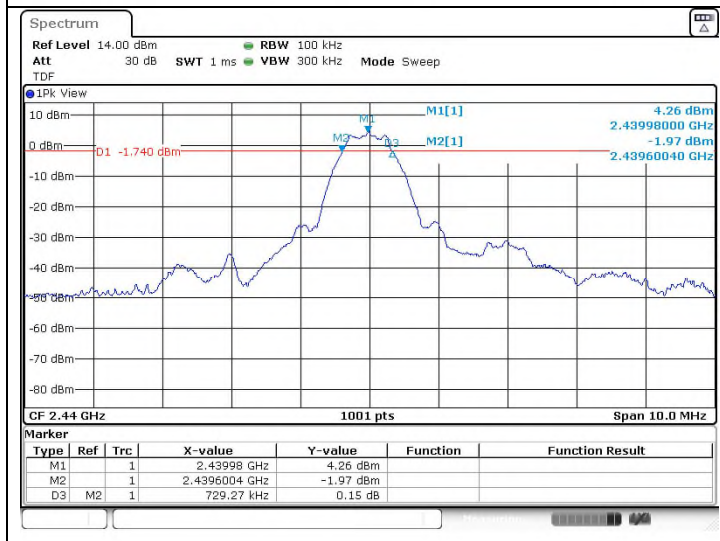

High Channel

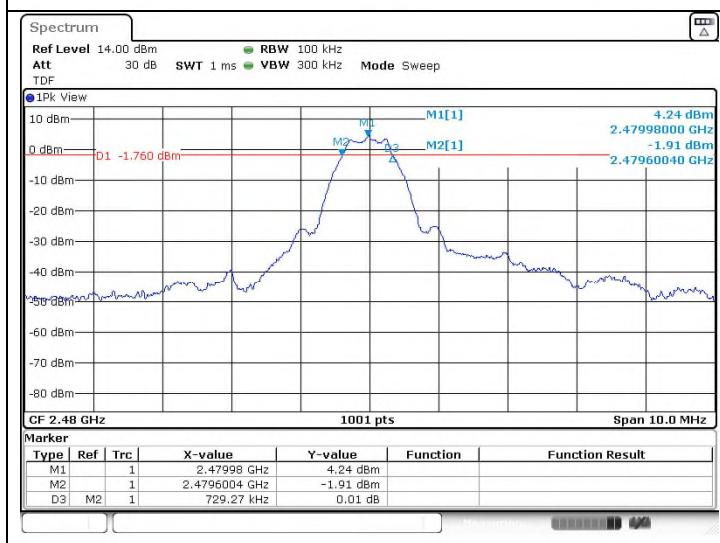

99 % Bandwidth

Low Channel

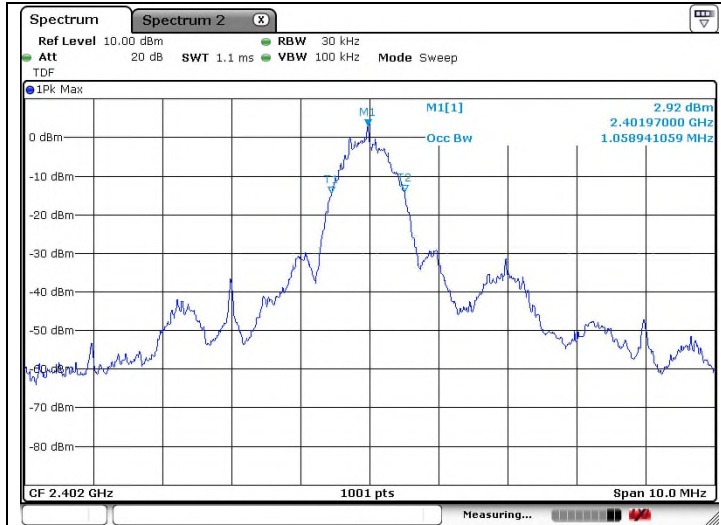

Middle Channel

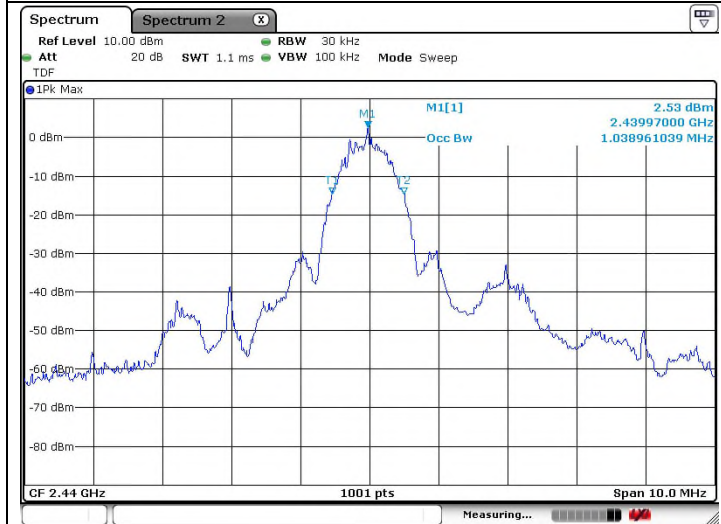

High Channel



4. Maximum Peak Conducted Output Power

4.1. Test Setup

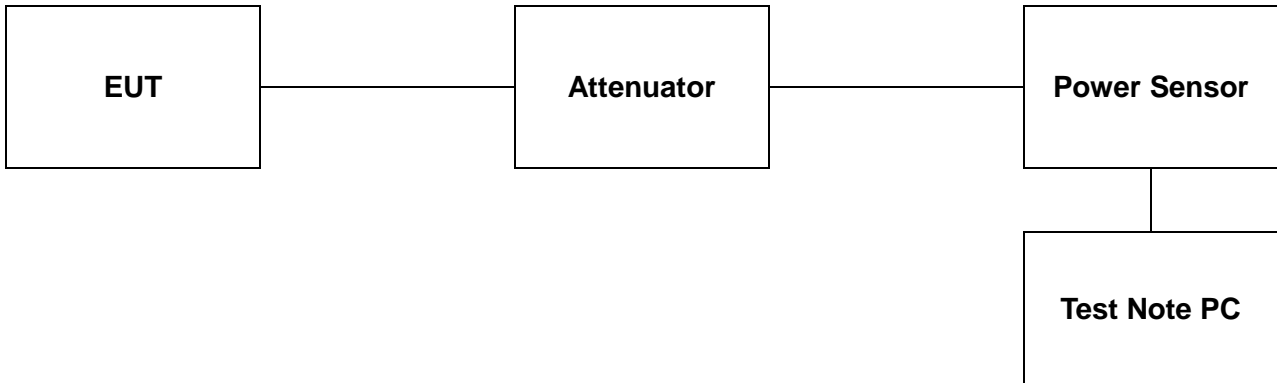

4.2. Limit

4.2.1. FCC

According to §15.247(b)(3), for systems using digital modulation in the 902-928 MHz, 2 400-2 483.5 MHz, and 5 725-5 850 MHz bands: 1 Watt. As an alternative to a peak power measurement, compliance with the one Watt limit can be based on a measurement of the maximum conducted output power. Maximum Conducted Output Power is defined as the total transmit power delivered to all antennas and antenna elements averaged across all symbols in the signaling alphabet when the transmitter is operating at its maximum power control level. Power must be summed across all antennas and antenna elements. The average must not include any time intervals during which the transmitter is off or is transmitting at a reduced power level. If multiple modes of operation are possible (e.g., alternative modulation methods), the maximum conducted output power is the highest total transmit power occurring in any mode.

According to §15.247(b)(4), the conducted output power limit specified in paragraph (b) of this section is based on the use of antennas with directional gains that do not exceed 6 dBi. Except as shown in paragraph (c) of this section, if transmitting antennas of directional gain greater than 6 dBi are used, the conducted output power from the intentional radiator shall be reduced below the stated values in paragraph (b)(1), (b)(2), and (b)(3) of this section, as appropriate, by the amount in dB that the directional gain of the antenna exceeds 6 dBi.

4.2.2. IC

According to RSS-247 Issue 2, 5.4(d), for DTSs employing digital modulation techniques operating in the bands 902-928 MHz and 2 400-2 483.5 MHz, the maximum peak conducted output power shall not exceed 1 W. The e.i.r.p. shall not exceed 4 W, except as provided in section 5.4(e),

As an alternative to a peak measurement, compliance can be based on a measurement of the maximum conducted output power. The maximum conducted output power is the total transmit power delivered to all antennas and antenna elements, averaged across all symbols in the signalling alphabet when the transmitter is operating at its maximum power control level. Power must be summed across all antennas and antenna elements. The average must not include any time intervals during which the transmitter is off or transmitting at a reduced power level. If multiple modes of operation are implemented, the maximum conducted output power is the highest total transmit power occurring in any mode.

4.3. Test Procedure

The test follows section 11.9.1.3 of ANSI C63.10-2013.

PKPM1 Peak-reading power meter method

- The maximum peak conducted output power may be measured using a broadband peak RF power meter. The power meter shall have a video bandwidth that is greater than or equal to the DTS bandwidth and shall utilize a fast-responding diode detector.

The test follows section 11.9.2.3.2 of ANSI C63.10-2013.

Method AVGPM-G (Measurement using a gated RF average-reading power meter)

- Alternatively, measurements may be performed using a wideband gated RF power meter provided that the gate parameters are adjusted such that the power is measured only when the EUT is transmitting at its maximum power control level. Since this measurement is made only during the ON time of the transmitter, no duty cycle correction is required.

Test program: (S/W name: R&S Power Viewer, Version: 3.2.0)

1. Initially overall offset for attenuator and cable loss is measured per frequency.
2. Measured offset is inserted in test program in advance of measurement for output power.
3. Power for each frequency (channel) of device is investigated as final result.
4. Final result reported on this section from R&S power viewer program includes with several factors and test program shows only final result.

4.4. Test Results

Ambient temperature : (23 ± 1) °C
 Relative humidity : 47 % R.H.

Mode	Channel	Frequency (MHz)	Average Power Result (dB m)	Peak Power Result (dB m)	Limit (dB m)
GFSK	Low	2 402	4.07	4.63	30
	Middle	2 440	3.73	4.26	
	High	2 480	3.51	4.04	

Remark;

Attenuator and cable offset was compensated in test program (R&S Power Viewer) before measuring.

5. Power Spectral Density

5.1. Test Setup

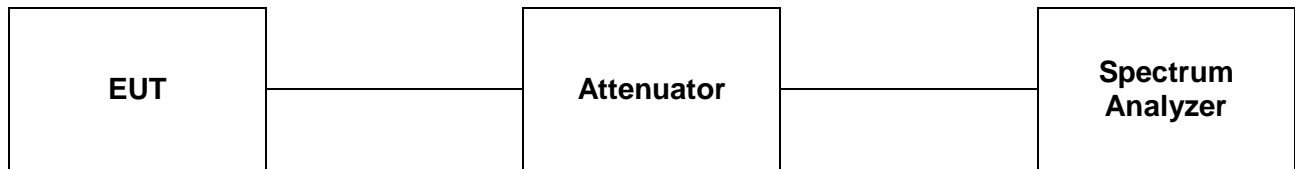

5.2. Limit

5.2.1 FCC

According to §15.247(e), for digitally modulated systems, the power spectral density conducted from the intentional radiator to the antenna shall not be greater than 8 dBm in any 3 kHz band during any time interval of continuous transmission. This power spectral density shall be determined in accordance with the provisions of paragraph (b) of this section. The same method of determining the conducted output power shall be used to determine the power spectral density.

5.2.2 IC

According to RSS-247 Issue 2, 5.2(b), the transmitter power spectral density conducted from the transmitter to the antenna shall not be greater than 8 dBm in any 3 kHz band during any time interval of continuous transmission. This power spectral density shall be determined in accordance with the provisions of section 5.4(d), (i.e. the power spectral density shall be determined using the same method as is used to determine the conducted output power).

5.3. Test Procedure

The measurements are recorded using the PKPSD measurement procedure in section 11.10.2 of ANSI C63.10-2013.

- This procedure shall be used if maximum peak conducted output power was used to demonstrate compliance, and is optional if the maximum conducted (average) output power was used to demonstrate compliance.

1. Set analyzer center frequency to DTS channel center frequency.
2. Set the span to 1.5 times the DTS bandwidth.
3. Set the RBW to $3 \text{ kHz} \leq \text{RBW} \leq 100 \text{ kHz}$.
4. Set the VBW $\geq 3 \times \text{RBW}$.
5. Detector = peak.
6. Sweep time = auto couple.
7. Trace mode = max hold.
8. Allow trace to fully stabilize.
9. Use the peak marker function to determine the maximum amplitude level within the RBW.
10. If measured value exceeds requirement, then reduce RBW (but no less than 3 kHz) and repeat.

5.4. Test Results

Ambient temperature : (23 ± 1) °C
 Relative humidity : 47 % R.H.

Mode	Channel	Frequency (MHz)	Measured PSD (dB m/3 kHz)	Limit (dB m/3 kHz)
GFSK	Low	2 402	-8.31	8
	Middle	2 440	-8.51	
	High	2 480	-8.66	

- Test plots

Low Channel

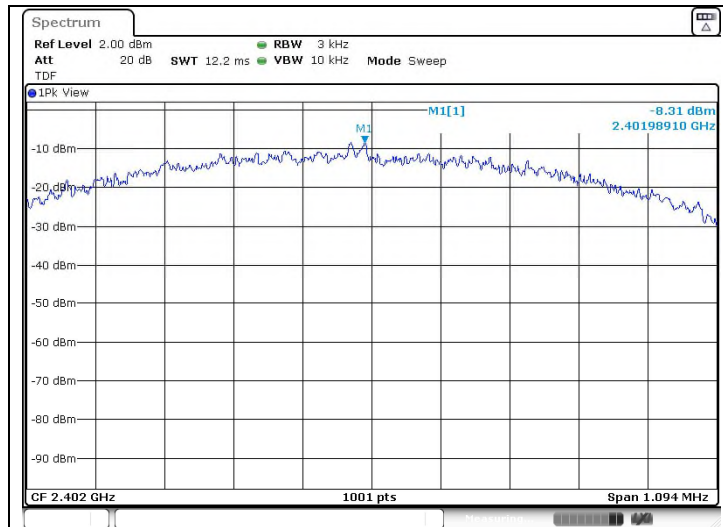

Middle Channel

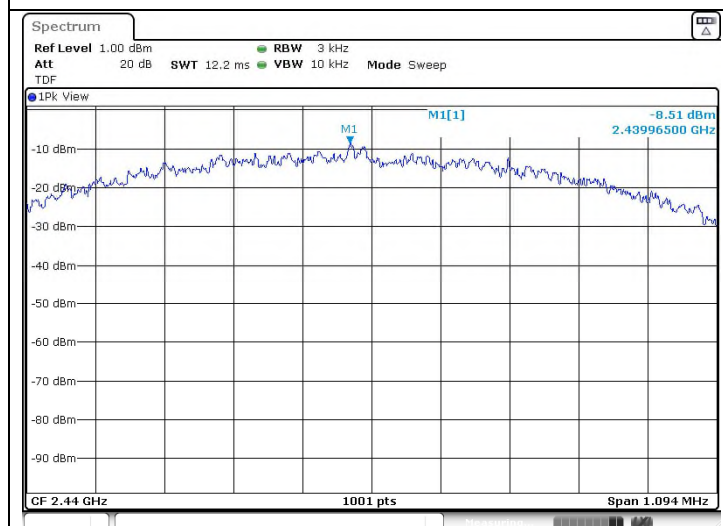

High Channel

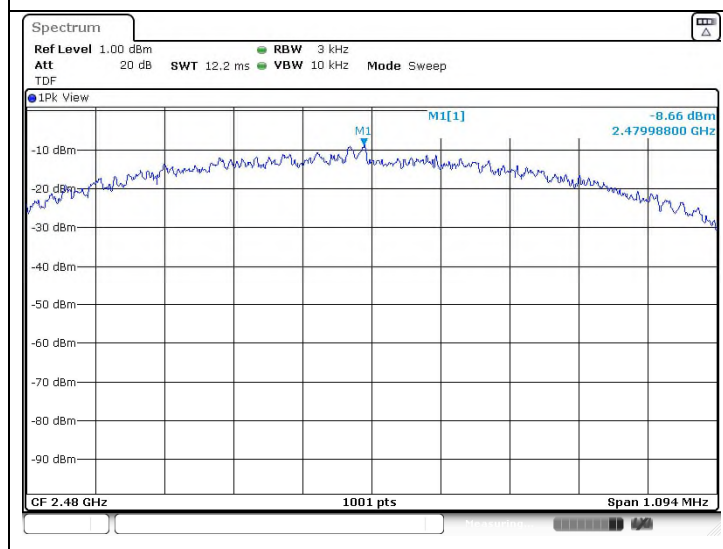

6. AC Power Line Conducted Emission

6.1. Test Setup

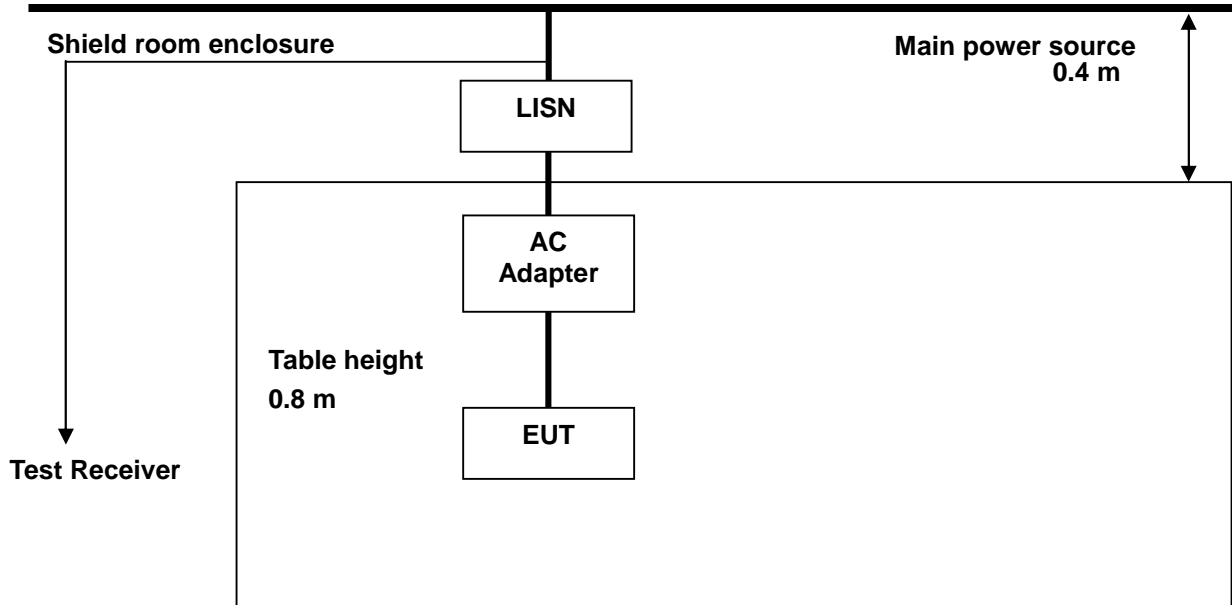

6.2. Limit

6.2.1. FCC

According to §15.207(a), for an intentional radiator that is designed to be connected to the public utility (AC) power line, the radio frequency voltage that is conducted back onto the AC power line on any frequency or frequencies, within the band 150 kHz to 30 MHz, shall not exceed the limits in the following table, as measured using a 50 μH / 50 ohms line impedance stabilization network (LISN).

Compliance with the provision of this paragraph shall be based on the measurement of the radio frequency voltage between each power line and ground at the power terminal. The lower limit applies at the boundary between the frequency ranges.

Frequency of emission (MHz)	Conducted limit (dBμV)	
	Quasi-peak	Average
0.15-0.5	66 to 56*	56 to 46*
0.5-5	56	46
5-30	60	50

* Decreases with the logarithm of the frequency.

6.2.2. IC

RSS-Gen Issue 5, 8.8, Unless stated otherwise in the applicable RSS, for radio apparatus that are designed to be connected to the public utility AC power network, the radio frequency voltage that is conducted back onto the AC power line on any frequency or frequencies within the range 150 kHz to 30 MHz shall not exceed the limits in table 4, as measured using a 50 μH / 50 Ω line impedance stabilization network. This requirement applies for the radio frequency voltage measured between each power line and the ground terminal of each AC power-line mains cable of the EUT.

For an EUT that connects to the AC power lines indirectly, through another device, the requirement for compliance with the limits in table 4 shall apply at the terminals of the AC power-line mains cable of a representative support device, while it provides power to the EUT. The lower limit applies at the boundary between the frequency ranges. The device used to power the EUT shall be representative of typical applications.

Table 4 - AC power-line conducted emissions limits

Frequency (MHz)	Conducted limit (dBμV)	
	Quasi-peak	Average
0.15-0.5	66 to 56 ¹	56 to 46 ¹
0.5-5	56	46
5-30	60	50

Note 1: The level decreases linearly with the logarithm of the frequency.

For an EUT with a permanent or detachable antenna operating between 150 kHz and 30 MHz, the AC power-line conducted emissions must be measured using the following configurations:

- (a) Perform the AC power-line conducted emissions test with the antenna connected to determine compliance with the limits of table 4 outside the transmitter's fundamental emission band.
- (b) Retest with a dummy load instead of the antenna to determine compliance with the limits of table 4 within the transmitter's fundamental emission band. For a detachable antenna, remove the antenna and connect a suitable dummy load to the antenna connector. For a permanent antenna, remove the antenna and terminate the RF output with a dummy load or network that simulates the antenna in the fundamental frequency band.

6.3. Test Procedures

AC conducted emissions from the EUT were measured according to the dictates of ANSI C63.10-2013

1. The test procedure is performed in a 6.5 m × 3.5 m × 3.5 m (L × W × H) shielded room. The EUT along with its peripherals were placed on a 1.0 m (W) × 1.5 m (L) and 0.8 m in height wooden table and the EUT was adjusted to maintain a 0.4 meter space from a vertical reference plane.
2. The EUT was connected to power mains through a line impedance stabilization network (LISN) which provides 50 ohm coupling impedance for measuring instrument and the chassis ground was bounded to the horizontal ground plane of shielded room.
3. All peripherals were connected to the second LISN and the chassis ground also bounded to the horizontal ground plane of shielded room.
4. The excess power cable between the EUT and the LISN was bundled. The power cables of peripherals were unbundled. All connecting cables of EUT and peripherals were moved to find the maximum emission.

6.4. Test Results

The following table shows the highest levels of conducted emissions on both phase of Hot and Neutral line.

Ambient temperature : (23 ± 1) °C
 Relative humidity : 47 % R.H.

 Frequency range : 0.15 MHz - 30 MHz
 Measured Bandwidth : 9 kHz

FREQ. (MHz)	LEVEL (dB μ V)		LINE	LIMIT (dB μ V)		MARGIN (dB)	
	Q-Peak	Average		Q-Peak	Average	Q-Peak	Average
0.17	42.20	23.30	N	64.96	54.96	22.76	31.66
0.23	38.10	20.00	N	62.45	52.45	24.35	32.45
0.49	29.90	18.50	N	56.17	46.17	26.27	27.67
5.07	37.10	23.20	N	60.00	50.00	22.90	26.80
12.44	39.40	22.30	N	60.00	50.00	20.60	27.70
16.21	38.80	27.50	N	60.00	50.00	21.20	22.50
0.17	44.20	27.20	H	64.96	54.96	20.76	27.76
0.20	41.80	25.60	H	63.61	53.61	21.81	28.01
0.37	35.30	25.10	H	58.50	48.50	23.20	23.40
0.45	31.20	19.80	H	56.88	46.88	25.68	27.08
12.82	38.20	25.80	H	60.00	50.00	21.80	24.20
16.11	36.30	27.50	H	60.00	50.00	23.70	22.50

Remark;

1. Line (H): Hot, Line (N): Neutral.
2. All channels of operation were investigated and the worst-case emissions were reported using **Low channel.**
3. The limit for Class B device(s) from 150 kHz to 30 MHz are specified in Section of the Title 47 CFR.
4. Traces shown in plot were made by using a peak detector and average detector.
5. Deviations to the Specifications: None.

- Test plots

Test mode: (Neutral)

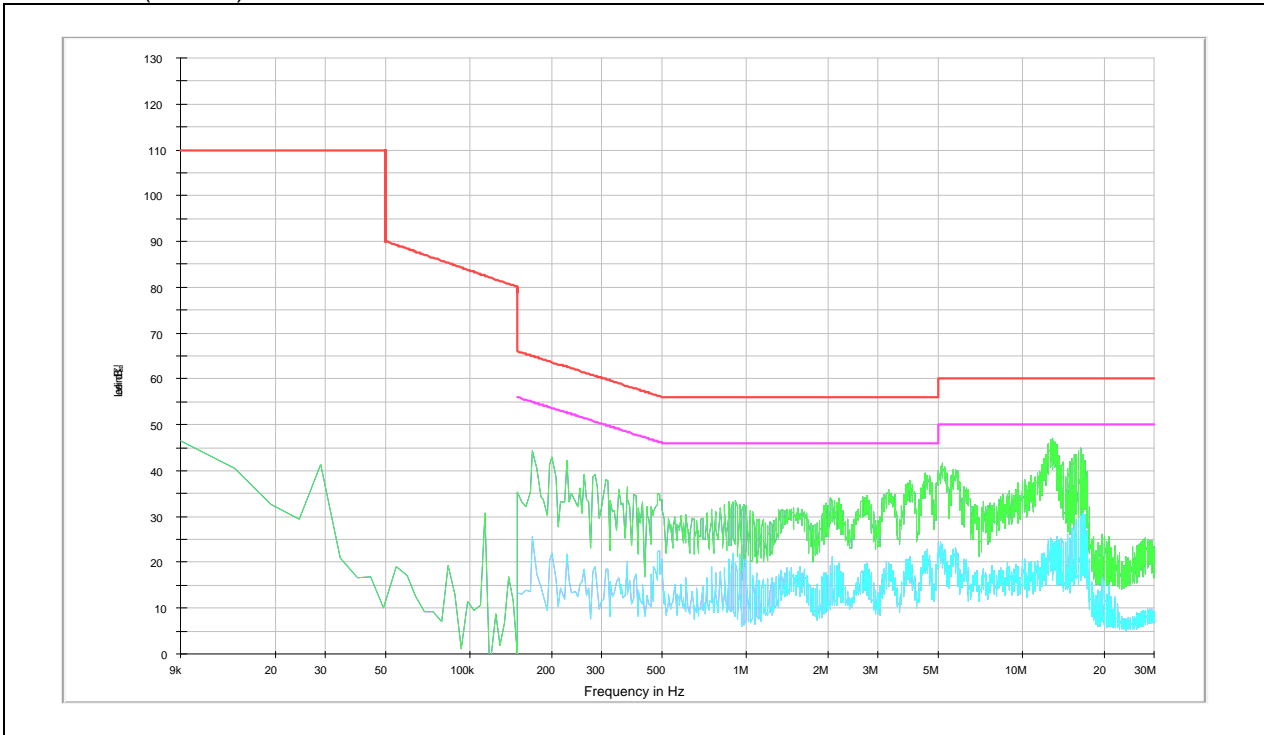

Test mode: (Hot)

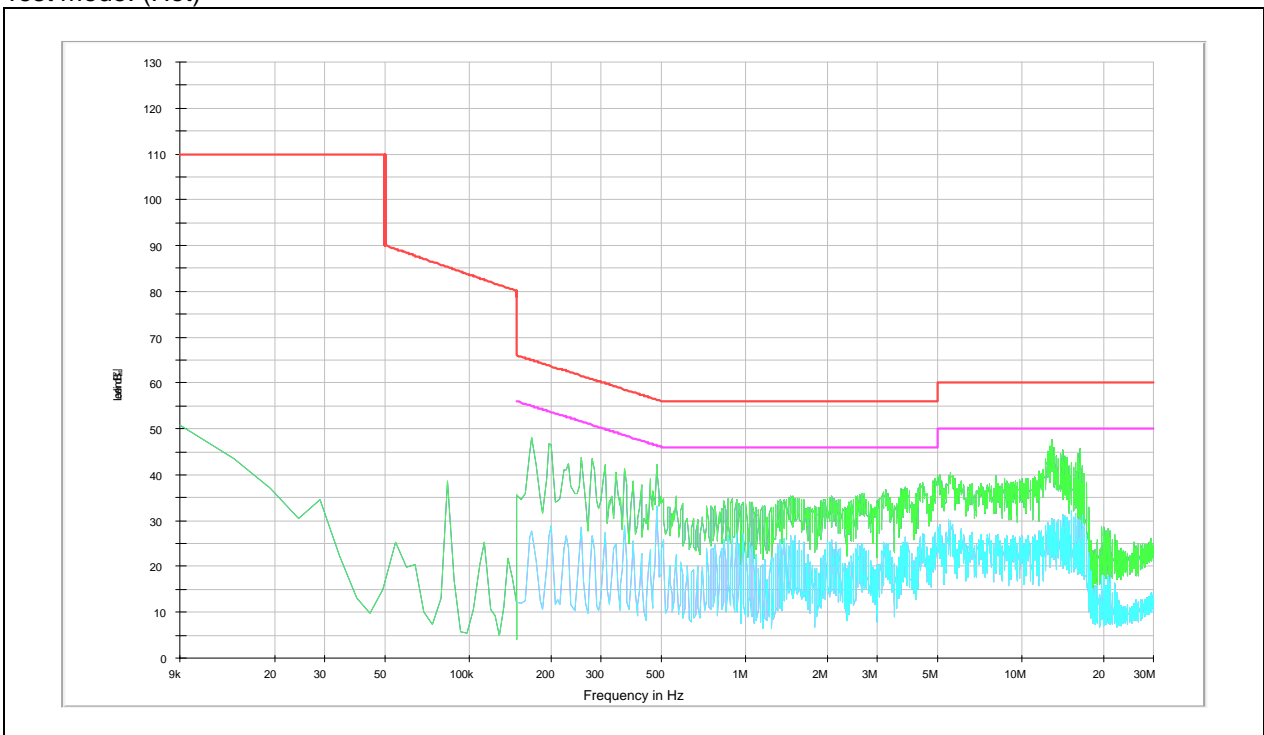

7. Antenna Requirement

7.1. Standard Applicable

For intentional device, according to FCC 47 CFR Section §15.203, an intentional radiator shall be designed to ensure that no antenna other than that furnished by the responsible party shall be used with the device. And according to FCC 47 CFR Section §15.247(b) if transmitting antennas of directional gain greater than 6 dB i are used, the power shall be reduced by the amount in dB that the gain of the antenna exceeds 6 dB i.

7.2. Antenna Connected Construction

Antenna used in this product is PCB pattern antenna with gain of 3.40 dB i.